



# Liberty 2025 Wildfire Mitigation Plan Update



# TABLE OF CONTENTS

- Introduction ..... 5**
- 1. Updates to Risk Models ..... 6**
  - 1.1 Significant Updates ..... 6
  - 1.2 Non-Significant Updates ..... 11
- 2. Changes to Approved Targets, Objectives and Expenditures ..... 12**
  - 2.1 Objectives ..... 12
  - 2.2 Targets and Expenditures ..... 14
- 3. Quarterly Inspection Targets for 2025 ..... 28**
- 4. New or Discontinued Programs ..... 29**
  - 4.1 New Programs ..... 29
  - 4.2 Discontinued Programs ..... 29
- 5. Progress on Areas for Continued Improvement ..... 30**
  - 5.1 LU-23-01: Cross-Utility Collaboration on Risk Model Development ..... 30
  - 5.2 LU-23-02: PSPS and Wildfire Risk Trade-Off Transparency ..... 30
  - 5.3 LU-23-03: Collaboration Between Vendor and Utility Risk Teams ..... 31
  - 5.4 LU-23-04: Vendor Fire Risk Model Implementation Milestones and Dates ..... 32
  - 5.5 LU-23-05: Cross-Utility Collaboration on Best Practices for Inclusion of Climate Change Forecasts in Consequence Modeling, Inclusion of Community Vulnerability in Consequence Modeling, and Utility Vegetation Management for Wildfire Safety ..... 33
  - 5.6 LU-23-06: Effectiveness of SRP and Traditional Hardening ..... 34
  - 5.7 LU-23-07: Further Design Considerations ..... 36
  - 5.8 LU-23-08: Halting Detailed Distribution Inspections ..... 37
  - 5.9 LU-23-09: Covered Conductor Inspections and Maintenance ..... 39
  - 5.10 LU-23-10: Distribution detailed inspection frequency ..... 40
  - 5.11 LU-23-11: QA/QC sample size and pass rates ..... 41
  - 5.12 LU-23-12: Additional Inspection Practices ..... 42
  - 5.13 LU-23-13: Lightning arrester replacement ..... 42
  - 5.14 LU-23-14: Expulsion fuse replacement targets ..... 43

5.15	LU-23-15: Reliability Impacts of SRP .....	43
5.16	LU-23-16: Evaluation of High Impedance Fault Detection .....	44
5.17	LU-23-17: Progress toward eliminating vegetation management work order backlog.	45
5.18	LU-23-18: Weather Station Optimization .....	46
5.19	LU-23-19: Weather Station Maintenance, and Calibration.....	46
5.20	LU-23-20: Early detection of Ignitions with HD Cameras .....	47
<b>6.</b>	<b>Appendix A: Spacer Cable Inspection Checklist .....</b>	<b>50</b>
<b>7.</b>	<b>Appendix B: Fire Mitigation Protection System Study for Liberty Utilities .....</b>	<b>51</b>
<b>8.</b>	<b>Appendix C: Eagle Rock Analytics Analysis on Weather Stations .....</b>	<b>52</b>
<b>9.</b>	<b>Appendix D: Scope of Work for Weather Station Maintenance and Calibration .....</b>	<b>53</b>
<b>10.</b>	<b>Appendix E: Weather Station Calibrations Completed in 2024 .....</b>	<b>54</b>

## LIST OF FIGURES

Figure 5-1: Liberty High Level Risk-Based Decision-Making Framework Process .....	32
Figure 5-2: Timeline of Liberty’s Risk Modeling Plan.....	33
Figure 5-3: Liberty SAIFI and SAIDI Summary (2021-2024).....	36
Figure 5-4: Liberty Asset Inspection Work Orders by Year, 2021-2025 .....	39
Figure 5-5: Liberty Findings from Detailed Asset Inspections.....	41
Figure 5-6: Map of Installed and Proposed ALERT Wildfire Cameras in Liberty’s Service Territory .....	49

## LIST OF TABLES

Table 1-1: Liberty Top-Risk Circuits (from 2025 WMP Update submission) .....	8
Table 1-2: Liberty Top-Risk Circuits (from 2023 WMP submission).....	9
Table 1-3: Summary of Significant Updates to Liberty’s Wildfire Risk Models .....	9
Table 2-1: Changes in Objective Completion Dates.....	12
Table 2-2: Qualifying WMP Initiative Changes in Targets and Expenditures .....	14
Table 3-1: Asset Inspection and Vegetation Management Targets for 2025.....	28
Table 5-1: Summary of Liberty’s Evaluation of SRP, Traditional Overhead Hardening, and Covered Conductor WMP Initiatives .....	36
Table 5-2: Liberty Findings from Detailed Asset Inspections.....	41

## Introduction

In 2023, Liberty submitted its 2023-2025 Wildfire Mitigation Plan (“WMP”) to the Office of Energy Infrastructure Safety (“OEIS” or “Energy Safety”). In 2024, each electrical corporation must provide an update to its approved 2023-2025 Wildfire Mitigation Plan as outlined in the 2025 Wildfire Mitigation Plan Update Guidelines.<sup>1</sup>

This 2025 WMP Update provides updates and information on initiatives, objectives, and targets listed in Liberty’s 2023-2025 WMP. Section 2 contains updates on the risk models used to aid the scoping of grid hardening initiatives and guide risk-based de-energization. Section 3 discusses changes in objectives, targets, or expenditures that meet the OEIS threshold. Section 4 provides updates for 2025 quarterly inspection targets. Section 5 describes new Liberty WMP-related programs. Section 6 provides progress on Areas for Continued Improvement (“ACIs”).

Liberty continues to improve its wildfire mitigation planning and implementation to progress its WMP initiatives across all WMP categories. Since Liberty’s 2023-2025 WMP submission, Liberty has made significant strides to enhance its risk modeling capabilities. These improvements will help inform Liberty’s mitigation strategies and initiative selections and increase the ability to target specific mitigations to areas with the highest wildfire and PSPS risk. Liberty continues to advance its grid hardening efforts, including continued covered conductor installation, traditional overhead hardening, and pole replacements. Liberty continues to evaluate the integration of new technologies and is expediting the implementation of its Sensitive Relay Profile (“SRP”) program in this WMP cycle. Liberty continues to prioritize its emergency preparedness and community outreach WMP initiatives to support its communities and protect customers from the risks of wildfire and PSPS impacts.

---

<sup>1</sup> 2025 Wildfire Mitigation Plan Update Guidelines: <https://energysafety.ca.gov/what-we-do/electrical-infrastructure-safety/wildfire-mitigation-and-safety/wildfire-mitigation-plans/2025-wildfire-mitigation-plans/>

# 1. Updates to Risk Models

## 1.1 Significant Updates

Energy Safety considers the following qualitative updates to risk models as significant updates:

- Introduction of a new model.
- Discontinuation of an existing model.
- Any change in existing model application or use-case. For example, newly applying an existing vegetation risk model to PSPS decision-making.
- Introduction of new data types. For example, incorporating additional risk drivers into newer versions of a model.
- Changes to data sources. For example, using a new source of data to measure vegetation moisture content.
- Changes to third-party vendors for risk modeling or inputs to risk modeling.<sup>2</sup>

Since its 2023 WMP submission, Liberty has made significant improvements to its risk modeling capabilities as part of the development of a new Risk-Based Decision Making (“RBDM”) platform. In 2023, Liberty began foundational work for this platform, enlisting Direxyon Technologies and Technosylva Inc. to provide expertise and risk assessment tools. A modeling framework was then established in collaboration with Direxyon, utilizing its investment planning tools and expertise. Liberty contracted with Technosylva for use of its Wildfire Analyst (“WFA”) product suite, which has provided the fire risk modeling outputs necessary to build Liberty’s RBDM platform.

Over the last year, Liberty has prioritized the development of a Composite Risk (“CR”) score that quantifies risk at the system, circuit, segment, and asset level of granularity. Composite Risk is comprised of modules for Wildfire Risk (“WR”) and Asset Failure Risk (“AFR”). Within these modules, Liberty has introduced functional models for Probability of Fire (“WL”), Consequence of Fire (“WC”), Probability of Asset Failure (“APF”), and Consequence of Asset Failure (“ACF”). Refer to Section 6.2.1 of Liberty’s 2025 WMP Update, and specifically Figure 6-3, for a visualization of the components within Composite Risk. During development of Liberty’s improved RBDM platform, Liberty also worked with Direxyon to determine the appropriate data inputs needed to build these models. Considerations for topography, vegetation-based fuels, climatology, demographics, historic fire weather days, live and dead fuel moisture samples, and impact to the population are quantified using data provided by Liberty and

---

<sup>2</sup> 2025 Wildfire Mitigation Plan Update Guidelines, Section 1.1.2

Technosylva. Refer to Section 6, Table 6-1 for a summary list of the risk models Liberty has introduced, including data inputs.

The Composite Risk score that has been developed, and its sub-models, are central to Liberty's RBDM platform, which will act as a long-term planning risk model to aid in the decisions and strategies for future wildfire mitigation work, with a focus on reducing Liberty's overall risk profile. The development of this model should not be confused with the operational and short-term analysis described in Section 8. Liberty plans to put this updated version of its wildfire risk model into production for use in limited facets of its business starting in Quarter 3 of 2024. Liberty will continue to focus on implementing and utilizing the wildfire risk modeling outputs for grid hardening initiatives (*i.e.*, covered conductor, pole replacements, and fuse replacements), vegetation management initiatives, and related operations. Once put into production, the existing risk calculations that Liberty presented in its 2023 WMP submission, which were modeled for Liberty by REAX Engineering and Arup, will be discontinued.

While Liberty has introduced working modules to its RBDM platform for Wildfire Risk and Asset Failure Risk, PSPS Risk is a factor that has not yet been calculated using the Direxion Risk Assessment Tool Suite. Liberty plans to develop a PSPS risk model, including PSPS likelihood and consequence, after Wildfire Risk and Asset Failure Risk modules have been put into production in 2024. For a visualization of how planned PSPS Risk modeling work will fit into Liberty's RBDM platform, refer to Section 6, Figure 6-3.

In 2024, Liberty will add Technosylva's FireRisk application to its weather forecasting and fire potential modeling capabilities. FireRisk provides daily asset-based risk forecasting to support operational needs, including situational awareness needs, such as monitoring conditions for a potential PSPS. The addition of FireRisk to Liberty's situational awareness tools will provide near-to-live weather forecasting and help to identify locations and periods of concern in its service territory, given the PSPS thresholds that Liberty has set to identify when PSPS may be implemented.

### **1.1.1 Top Risk-Contributing Circuits, Segments, or Spans**

Table 1-1 provides an updated list of available risk scores for Liberty's top risk-contributing circuits. Table 1-2 provides the initial list of risk scores for Liberty's top risk-contributing circuits from its 2023 WMP submission. Liberty's top risk circuits have been updated to reflect its quantitative risk modeling efforts that have taken place since the base 2023 WMP submission. In the previous scores that were calculated by Arup and Reax, high level asset data and risk models developed by Reax were used to quantify Utility Risk, WR, and PSPS Risk. As a part of the updated risk scores, Liberty is utilizing risk models developed in conjunction with Liberty



subject matter experts and Direxyon’s technical teams to develop Composite Risk, WR, and AFR. PSPS Risk is scheduled for development in late 2024. The difference in the circuit rankings is expected due to the difference in underlying models and the data sources that are feeding the newly developed models. For example, Liberty is now utilizing the California Electric Utility standard Technosylva WFA model to develop its AFR Score and WR Score. Additionally, in conjunction with Direxyon, Liberty has developed an AFR Score taking into account failures, specific equipment, and subject matter expert knowledge to target risk that is attributed to ignitions. Therefore, it is expected that the newly developed model outputs of Liberty’s AFR Score would provide a more accurate representation of its risk across the various circuits of its service territory.

*Table 1-1: Liberty Top-Risk Circuits (from 2025 WMP Update submission)*

Risk Ranking	Circuit	Composite Risk Score	Fire Risk Score	Asset Failure Risk Score
1	STL3101	27.9439408	17.4916161	28.1626272
2	TPZ1261	24.33849979	23.3308025	17.64815582
3	MEY3200	23.89626556	12.24412266	31.75587828
4	CAL204	23.87746171	31.46516196	11.68490153
5	MEY3300	23.33960489	16.46418173	28.62590154
6	CEM41	23.1484375	15.90151952	19.2890625
7	MEY3400	23.13973442	10.82709268	29.59332652
8	T640	23.07749077	16.5128694	15.89114391
9	MEY3100	22.86836935	12.20107026	28.95343811
10	MEY3500	22.62896871	19.33121787	26.45724218
11	STL3501	22.54609929	12.02970858	27.28014184
12	POR32	22.38978307	9.522927366	27.42491253
13	POR31	22.2193865	10.98820784	25.97447853
14	SRB51	21.22222222	30.22581151	10.74213836
15	TRK7203	20.64498141	9.780865584	22.04460967
16	WSH201	20.1671159	9.699994921	24.09703504
17	KBH4202	19.28797127	11.43895671	18.02692998
18	CEM42	19.17560976	11.06651664	18.75609756
19	MULLER1296	18.68535524	14.04229006	16.15659739
20	SLK257	17.96491228	17.99090088	10.1754386

Table 1-2: Liberty Top-Risk Circuits (from 2023 WMP submission)

Risk Ranking	Circuit	Utility Risk	Wildfire Risk	PSPS Risk
1	TPZ1261	2.34E-03	2.28E-03	6.51E-05
2	MULLER1296	3.74E-04	3.29E-04	4.57E-05
3	MEY3400	3.30E-04	1.15E-04	2.15E-04
4	TAH7300	2.71E-04	6.74E-05	2.04E-04
5	GLS7400	2.00E-04	1.76E-04	2.42E-05
6	MEY3300	1.86E-04	8.17E-05	1.04E-04
7	STL3101	1.55E-04	1.28E-05	1.42E-04
8	POR31	1.45E-04	1.45E-04	0.00E+00
9	SQV8200	8.56E-05	8.39E-05	1.63E-06
10	SQV7201	8.12E-05	5.95E-05	2.16E-05
11	608	7.87E-05	7.87E-05	1.30E-09
12	MEY3200	7.35E-05	1.69E-05	5.66E-05
13	MEY3100	7.25E-05	1.63E-05	5.62E-05
14	STL3501	6.36E-05	3.02E-06	6.06E-05
15	TAH7100	6.26E-05	1.45E-05	4.81E-05
16	MEY3500	5.45E-05	2.66E-05	2.79E-05
17	CAL204	5.33E-05	5.33E-05	0.00E+00
18	POR32	5.10E-05	5.10E-05	0.00E+00
19	TRK7204	4.09E-05	4.09E-05	0.00E+00
20	SRB51	3.42E-05	3.42E-05	0.00E+00

### 1.1.2 Qualitative Updates

Table 1-3 provides a summary of significant updates to Liberty's wildfire risk models.

Table 1-3: Summary of Significant Updates to Liberty's Wildfire Risk Models

Significant Qualitative Updates (Energy Safety Categories)	Liberty 2023-2025 WMP Section	Summary of Update
Introduction of a new model	Sections 6.1.1, 6.1.2, 6.2.1, 6.2.2.1, 6.2.2.2, 6.2.2.3, 6.2.3, 6.3.1, 6.3.2, 6.5, 9.2	<ul style="list-style-type: none"> <li>Liberty is collaborating with Technosylva and Direxyon to develop a suite of risk assessment tools.</li> <li>Technosylva is an industry recognized provider of wildfire risk solutions and is the supplier of a software package known as Technosylva's WFA. Liberty is utilizing the FireSight application within the WFA to supplement its long-term mitigation planning and the FireRisk application to supplement tactical, short-term planning for operations, situational awareness, and PSPS decision-making.</li> </ul>

Significant Qualitative Updates (Energy Safety Categories)	Liberty 2023-2025 WMP Section	Summary of Update
		<ul style="list-style-type: none"> <li>In addition, and in collaboration with Direxyon, Liberty is developing an asset level risk analysis utilizing data inputs from these products, as well as Liberty's internal asset data and subject matter expert knowledge, to quantify risk at the circuit, segment, and individual asset level.</li> <li>As Liberty's improved RBDM platform is developed, enhancements to wildfire, AFR, and PSPS risk models will be continually evaluated through collaboration and review from internal and external sources.</li> </ul>
Discontinuation of an existing model	Sections 6.1.2, 6.2.1, 6.2.2.1, 6.2.2.2, 6.2.2.3, 6.2.3, 6.3.1, 6.3.2, 6.5	<ul style="list-style-type: none"> <li>Liberty has implemented several updates to the Enterprise System Roadmap with respect to the IBM proposal and the next steps in its risk analysis. Following the last WMP submission, Liberty ended its discussions with IBM for a Vegetation and Asset Management System with IBM's technology. Instead, Liberty is focusing on enhancing and implementing Business Intelligence solutions by using its existing systems and enriching data collection processes and optimizing data storage solutions internally. Additionally, Liberty has further engaged with Technosylva and Direxyon to formulate an RBDM platform to facilitate WMP guidelines and requirements and to elevate Liberty's informed decision-making abilities. Previously Liberty was also working with CloudFire to develop its Utility Risk, Wildfire Risk, and PSPS Risk. By keeping CloudFire as a consultant, Liberty is moving away from their model in exchange for the Direxyon Risk Assessment Tool.</li> </ul>
Any change in existing model application or use-case	Sections 6.4, 7.1.4.1, 7.1.4.2, 7.1.4.3	<ul style="list-style-type: none"> <li>Using Direxyon, Liberty has established quantified risk scores as baselines to begin comparing mitigations with the current data that is available. Once the year-over-year data comparisons are available, Liberty will be able to develop a quantifiable risk reduction plan. With the Direxyon tool, Liberty will be able to assess each circuit at the segment level to target riskier areas of its system effectively. By utilizing risk output metrics like Risk Spend Efficiency, AFR, and Composite Risk, Liberty will be able to identify asset types where specific risk reduction mitigation can be performed to reduce overall risk. Preliminary metrics</li> </ul>

Significant Qualitative Updates (Energy Safety Categories)	Liberty 2023-2025 WMP Section	Summary of Update
		are available in section 6.4 where these results are Liberty's preliminary baseline outputs from Direxyon.
Introduction of new data types	N/A	N/A
Changes to data sources	Table 6-1, Figure 6-2	<ul style="list-style-type: none"> <li>As Liberty has further engaged with Technosylva and Direxyon, updates to its data sources have been outlined in Section 6 and detailed in Table 6-1 and Figure 6-2. These updates encompass data previously sourced from CloudFire and are now sourced from Technosylva to feed the Direxyon Risk Assessment Tool ("DRAT"). Additional Liberty Asset data has been input into DRAT to produce a detailed AFR score considering specific equipment risk at the asset level of detail.</li> </ul>
Changes to third-party vendors for risk modeling or inputs to risk modeling	Section 6.1.1	<ul style="list-style-type: none"> <li>Previously, CloudFire and Arup were contracted to develop Liberty's Risk Scores with inputs in regard to fire metrics, vegetation, and weather being derived from their modeling services. Moving forward, Liberty is utilizing Technosylva's library of fire metrics, vegetation, and weather as inputs to their Wildfire Analyst ("WFA") model. Additionally, Liberty is contracting with Direxyon to implement a model which outputs comprehensive Asset, Wildfire, and PSPS quantitative risk scores with inputs from Technosylva's WFA tool and Liberty's asset data.</li> </ul>

## 1.2 Non-Significant Updates

Energy Safety defines non-significant updates as any change or combination of changes to the risk model that does not meet the significant update criteria.<sup>3</sup> Based on OEIS criteria, Liberty has categorized all updates to its risk models as significant and address all the updates in Section 2.1.

---

<sup>3</sup> 2025 Wildfire Mitigation Plan Update Guidelines, Section 1.2

## 2. Changes to Approved Targets, Objectives and Expenditures

### 2.1 Objectives

Energy Safety defines changes in objectives as any change to forecasted initiative objective completion dates in the approved 2023-2025 WMP that shift an objective’s completion to a different compliance period.<sup>4</sup> This section outlines changes in objective completion dates that meet the OEIS threshold and provides justification for each change. Table 2-1 provides a summary of all changes.

*Table 2-1: Changes in Objective Completion Dates*

<b>Initiative Category</b>	<b>2023 3-Year or 10-Year Objective</b>	<b>Applicable Initiatives(s), Tracking ID(s)</b>	<b>2023-2025 WMP Objective Completion Date</b>	<b>Updated 2025 WMP Objective Completion Date</b>
Grid Design, Operations, and Maintenance	Pilot the resonant grounding or “Swedish neutral” system on one substation within three years, test its risk spend efficiency and effectiveness.	WMP-GDOM-GH-06	12/31/2025	TBD
Emergency Preparedness	Ongoing maintenance of emergency response plans	WMP-EP-02	June 2024 (3-year) None (10-year)	Annual - June 2024 and June 2025 (3-year) Ongoing (10-year)
Emergency Preparedness	Continued engagement with local stakeholders to prepare for and respond to fire-related events	WMP-EP-03	June 2024 (3-year) None (10-year)	Annual - June 2024 and June 2025 (3-year) Ongoing (10-year)
Emergency Preparedness	Enhanced documentation and use of lessons learned to update plans	WMP-EP-04	June 2024 (3-year) None (10-year)	Annual - June 2024 and June 2025 (3-year) Ongoing (10-year)

---

<sup>4</sup> 2025 Wildfire Mitigation Plan Update Guidelines, Section 2.2

### **2.1.1 Resonant grounding or “Swedish neutral” system**

**Objective:** Pilot the resonant grounding or “Swedish neutral” system on one substation within three years, and test its risk spend efficiency and effectiveness.

**Change to objective:** The objective completion date for piloting the Swedish neutral technology was delayed to assess future cost and resource needs. Liberty is designing its substation rebuilds with provisions to potentially install Swedish neutral systems where possible if Liberty chooses to pursue this technology at a later date.

### **2.1.2 Emergency response plans**

**Objective:** Ongoing maintenance of emergency response plans.

**Change to objective:** Liberty updated the three-year completion date for this objective to annual (including both June 2024 and June 2025) and included it as an ongoing objective in its 10-year plan. Liberty intends for this to be an annual ongoing objective.

### **2.1.3 Engagement with emergency response stakeholders**

**Objective:** Continued engagement with local stakeholders to prepare for and responds to fire-related events.

**Change to objective:** Liberty updated the three-year completion date for this objective to annual (including both June 2024 and June 2025) and included it as an ongoing objective in its 10-year plan. Liberty intends for this to be an annual ongoing objective.

### **2.1.4 Enhanced documentation and use of lessons learned to update emergency preparedness plans**

**Objective:** Enhanced documentation and use of lessons learned to update plans.

**Change to objective:** Liberty updated the three-year completion date for this objective to annual (including both June 2024 and June 2025) and included it as an ongoing objective in its 10-year plan. Liberty intends for this to be an annual ongoing objective.

## 2.2 Targets and Expenditures

Energy Safety defines qualified target changes as a change in 10% or more for large volume work (equal to or greater than 100 units) or a change of 20% or more for small volume work (less than 100 units). Energy Safety defines qualified changes in expenditures as an increase or decrease of more than \$10 million or an increase or decrease that constitutes a greater than 20% change.<sup>5</sup> This section outlines changes in targets and expenditures that meet the OEIS threshold. Table 2-2 provides initiatives with qualifying changes to targets and expenditures.

*Table 2-2: Qualifying WMP Initiative Changes in Targets and Expenditures*

<b>WMP Initiative</b>	<b>2025 Original Target</b>	<b>2025 Updated Target</b>	<b>2025 Original Expenditures (\$ thousands)</b>	<b>2025 Updated Expenditures (\$ thousands)</b>
WMP-GDOM-GH-02: Undergrounding of electric lines and/or equipment	1.3 miles	0.4 miles	\$7,000	\$9,100
WMP-GDOM-GH-05: Traditional overhead hardening	2.0 miles	0 miles	\$2,500	\$0
WMP-GDOM-GH-12a: Tree attachment removal	60 tree attachments	60 tree attachments	\$740	\$1,102
WMP-GDOM-GH-12b: Expulsion fuse replacement	TBD	500 expulsion fuses	TBD	\$2,000
WMP-GDOM-GH-12e: Open wire/grey wire	-	-	\$2,055	\$3,000
WMP-GDOM-GH-12f: Substation equipment replacement	TBD	1 substation	TBD	\$608
WMP-GDOM-AI-01: Detailed inspections of distribution electric lines and equipment	260.9 miles	260.9 miles	\$75	\$500

---

<sup>5</sup> 2025 Wildfire Mitigation Plan Update Guidelines, Section 2.1 and 2.3

<b>WMP Initiative</b>	<b>2025 Original Target</b>	<b>2025 Updated Target</b>	<b>2025 Original Expenditures (\$ thousands)</b>	<b>2025 Updated Expenditures (\$ thousands)</b>
WMP-GDOM-AI-02: Intrusive pole inspections	2,411 poles	2,411 poles	-	\$175
WMP-GDOM-AI-03: Patrol inspections of distribution electric lines and equipment	540.9 miles	540.9 miles	\$15	\$150
WMP-GDOM-AI-04: Other discretionary inspections of distribution electric lines and equipment	TBD	1.0 miles	\$1,000	\$150
WMP-GDOM-AI-05: Quality assurance / quality control of inspections	3% of detailed inspections	12% of detailed inspections	\$10	\$30
WMP-GDOM-AI-06: Substation inspections	42 substations	42 substations	\$10	\$45
WMP-GDOM-GO-01: Equipment settings to reduce wildfire risk	-	7 circuits with SRP	\$150	\$500
WMP-VM-INSP-02: VM Inspection Program - Patrol	-	-	\$265	\$330
WMP-VM-VFM-03: Substation Defensible Space	-	12 substations	\$21	\$84
WMP-VM-VFM-04: Fire-Resilient-Right-of-Ways	-	-	\$271	\$577
WMP-VM-VFM-05: Clearance	-	700 miles	\$941	\$1,406
WMP-VM-VFM-06: Fall-in Mitigation	220 miles	220 miles	\$8,222	\$4,810
WMP-VM-ESG-01: VM Enterprise Management System	-	-	\$431	\$844



WMP Initiative	2025 Original Target	2025 Updated Target	2025 Original Expenditures (\$ thousands)	2025 Updated Expenditures (\$ thousands)
WMP-SA-02: Grid monitoring systems	10 fault indicators	7 fault indicators	\$150	\$300
WMP-EP-01: Wildfire and PSPS Emergency Preparedness Plan	-	-	-	\$35

## 2.2.1 WMP-GDOM-GH-02: Undergrounding of electric lines and/or equipment

### 2.2.1.1 Targets

The 2025 target for undergrounding decreased from 1.3 miles to 0.4 miles.

### 2.2.1.2 Projected Expenditures

The 2025 projected expenditures for undergrounding increased from \$7,000,000 to \$9,100,000.

### 2.2.1.3 Change Justification

The 2025 target for undergrounding decreased due to a change in strategic direction based on undergrounding project delays and permitting issues. In 2023, Liberty was unable to find a civil contractor that would meet the budget for the Tahoe Vista Rule 20 project planned for 2023. Liberty adjusted its undergrounding plans to focus on the Tahoe Vista Rule 20 project during the current WMP cycle. Liberty is currently working with Placer County, CalTrans, and Civil Contractors to replan the project scope to fit the budget for a 2025 build. Liberty is also working through permitting and traffic control issues with CalTrans.

The 2025 projected expenditures for undergrounding increased due to cost uncertainties with the Tahoe Vista Rule 20 project. The cost projection has increased due to several unforeseen uncertainties that contractors highlighted during the last bid process. For example, working on major roads, often operated by CalTrans, introduces significant challenges, including the uncertainty of what might be discovered underground, such as granite. This complicates digging and makes directional boring unfeasible. Coordinating with other utilities, managing tourism traffic, dealing with changing weather conditions, and navigating the complexities of CalTrans permitting and traffic control further add to the unpredictability. Additionally, there are environmental concerns, such as the potential for spills or the discovery of artifacts during

environmental monitoring, which must be carefully addressed. These factors contribute to the higher-than-expected costs and the overall variability in the project budget. Liberty will issue a request for proposals for this project in Quarter 4 of 2024, which will determine updated projected expenditures for the project.

## **2.2.2 WMP-GDOM-GH-05: Traditional overhead hardening**

### **2.2.2.1 Targets**

The 2025 target for traditional overhead hardening decreased from 2.0 miles to 0.0 miles.

### **2.2.2.2 Projected Expenditures**

The 2025 projected expenditures for traditional overhead hardening decreased from \$2,500,000 to \$0.

### **2.2.2.3 Change Justification**

The 2025 target and projected expenditures for traditional overhead hardening decreased because Liberty significantly exceeded its 2023 target for this initiative and will shift resources to other grid hardening projects in 2025. Specifically, Liberty completed 9.2 miles of traditional overhead hardening compared to 4.0 miles targeted in 2023.

## **2.2.3 WMP-GDOM-GH-12a: Tree attachment removal**

### **2.2.3.1 Targets**

The 2025 target for tree attachment removals did not change. The target remains at 60 tree attachment removals.

### **2.2.3.2 Projected Expenditures**

The 2025 projected expenditures for tree attachment removals increased from \$740,000 to \$1,101,673.

### **2.2.3.3 Change Justification**

The 2025 projected expenditures for tree attachment removals increased due to adjustments made to align 2025 expenditures with historical spend data. Specifically, Liberty's projected expenditures are based on completing 60 tree attachment removals at an average estimated cost of approximately \$18,000 per tree attachment removal. Liberty's cost projection increased primarily due to fluctuations in labor, material, and associated overhead costs. Labor, which constitutes approximately 65-70% of the total cost, has seen an increase due to a combination

of inflation (3-3.5%) and pressures from the labor market. Overhead costs, making up about 20%, have similarly risen. Additionally, material costs, which account for about 10-15% of the total, have increased due to supply chain challenges and material shortages, which have impacted the yearly project averages. The variability of each project, depending on factors such as the use of internal versus external crews, the location of the pole, environmental or permit requirements, and the specific materials needed, further influences the budget adjustments.

Historically, tree attachment removals have been driven by customer-initiated requests and therefore, projected volume and expenditures for this initiative can vary. As Liberty increases its ability to identify and track tree attachments in its service territory, the variations in customer-driven demand for this initiative will be offset by non-customer-initiated tree attachment removals.

## **2.2.4 WMP-GDOM-GH-12b: Expulsion fuse replacement**

### **2.2.4.1 Targets**

The 2025 target for expulsion fuse replacement was established at 500 expulsion fuse replacements.

### **2.2.4.2 Projected Expenditures**

The 2025 projected expenditures for expulsion fuse replacement was established at \$2,000,000.

### **2.2.4.3 Change Justification**

At the time of its 2023 WMP submission, Liberty did not have a 2025 target or 2025 projected expenditures established for its expulsion fuse replacement WMP initiative. Refer to Liberty's response to Area of Improvement LU-23-14: Expulsion fuse replacement targets.

## **2.2.5 WMP-GDOM-GH-12e: Open wire/grey wire**

### **2.2.5.1 Targets**

The 2025 target for open wire/grey wire did not change. The target remains at 5.2 miles.

### **2.2.5.2 Projected Expenditures**

The 2025 projected expenditures for open wire/grey wire increased from \$2,055,000 to \$3,000,000.

### **2.2.5.3 Change Justification**

The 2025 projected expenditures for open wire/grey wire increased due to adjustments made to align 2025 expenditures with historical spend data. Specifically, Liberty's projected expenditures are based on completing 5.2 miles of open wire/grey wire at an average estimated cost of approximately \$600,000 per mile. Liberty's cost projection increased primarily due to fluctuations in labor, material, and associated overhead costs. Labor, which constitutes approximately 65-70% of the total cost, has seen an increase due to a combination of inflation (3-3.5%) and pressures from the labor market. Overhead costs, making up about 20%, have similarly risen. Additionally, material costs, which account for about 10-15% of the total, have increased due to supply chain challenges and material shortages, which have impacted the yearly project averages. The variability of each project, depending on factors such as the use of internal versus external crews, the location of the pole, environmental or permit requirements, and the specific materials needed, further influences the budget adjustments.

The work associated with open wire/grey wire is typically performed during the winter months or between larger projects that are delayed due to permitting. Therefore, projected work volume and expenditures for this initiative can vary.

## **2.2.6 WMP-GDOM-GH-12f: Substation equipment replacement**

### **2.2.6.1 Targets**

The 2025 target for substation equipment replacement was established at one substation. The main focus of this program is for emergency equipment replacements based on substation inspections. Liberty's target of one substation is based on Liberty's assessment of historical trends of substation inspections that result in substation equipment replacements. However, Liberty's completion or exceedance of this target is based on the results of its substation inspections and that can vary year to year. Additionally, this program also includes other planned upgrades or enhancements to substations, such as upgrading Liberty's substation relays to help with tripping in fault conditions.

### **2.2.6.2 Projected Expenditures**

The 2025 projected expenditures for substation equipment replacement was established at \$6,087,584.

### **2.2.6.3 Change Justification**

At the time of its 2023 WMP submission, Liberty did not have a 2025 target or 2025 projected expenditures established for its Substation Equipment Replacement WMP initiative.

## **2.2.7 WMP-GDOM-AI-01: Detailed inspections of distribution electric lines and equipment**

### **2.2.7.1 Targets**

The 2025 target for detailed inspections of distribution electric lines and equipment did not change. The target remains at 260.9 miles.

### **2.2.7.2 Projected Expenditures**

The 2025 projected expenditures for detailed inspections of distribution electric lines and equipment increased from \$75,000 to \$500,000.

### **2.2.7.3 Change Justification**

The 2025 projected expenditures for detailed inspections of distribution electric lines and equipment increased due to improved accuracy of Liberty's cost projection based on year-to-date actual spend for this initiative as well as an adjustment for increased labor costs. Historically, Liberty's projected expenditures for asset inspection WMP initiatives were developed using an allocation methodology of overall asset inspection costs. For its 2025 WMP Update, Liberty has improved its cost projection methodology for asset inspection WMP initiatives by tracking and reviewing related costs at a more granular level. Specifically, Liberty's projected expenditures for detailed asset inspections are based on an estimated total of 5,600 hours at an estimated cost of \$90 per hour, which accounts for an increase in labor costs.

## **2.2.8 WMP-GDOM-AI-02: Intrusive pole inspections**

### **2.2.8.1 Targets**

The 2025 target for intrusive pole inspections did not change. The target remains at 2,411 poles.

### **2.2.8.2 Projected Expenditures**

The 2025 projected expenditures for intrusive pole inspections was established at \$175,000.

### **2.2.8.3 Change Justification**

At the time of its 2023 WMP submission, Liberty did not provide 2025 projected expenditures for its intrusive pole inspections WMP initiative.

## **2.2.9 WMP-GDOM-AI-03: Patrol inspections of distribution electric lines and equipment**

### **2.2.9.1 Targets**

The 2025 target for patrol inspections of distribution electric lines and equipment did not change. The target remains at 540.9 miles.

### **2.2.9.2 Projected Expenditures**

The 2025 projected expenditures for patrol inspections of distribution electric lines and equipment increased from \$15,000 to \$75,000.

### **2.2.9.3 Change Justification**

The 2025 projected expenditures for patrol inspections of distribution electric lines and equipment increased due to improved accuracy of Liberty's cost projection based on year-to-date actual spend for this initiative as well as an adjustment for increased labor costs.

## **2.2.10 WMP-GDOM-AI-04: Other discretionary inspections of distribution electric lines and equipment**

### **2.2.10.1 Targets**

The 2025 target for other discretionary inspections of distribution electric lines and equipment was established at 1.0 miles. Liberty plans to target an additional 1.0 mile of drone inspections in 2025, with the purpose of supporting outage restoration for inaccessible areas due to weather or terrain. Historically, Liberty's projected expenditures for asset inspection WMP initiatives were developed using an allocation methodology of overall asset inspection costs. For its 2025 WMP Update, Liberty has improved its cost projection methodology for asset inspection WMP initiatives by tracking and reviewing related costs at a more granular level.

### **2.2.10.2 Projected Expenditures**

The 2025 projected expenditures for other discretionary inspections of distribution electric lines and equipment decreased from \$1,000,000 to \$150,000.

### **2.2.10.3 Change Justification**

At the time of its 2023 WMP submission, Liberty did not have a 2025 target established for its other discretionary inspections of distribution electric lines and equipment WMP initiative. Liberty's 2025 target is a continuation of its 2024 pilot for this initiative, which utilized an

internal drone and pilot to target 1.0 miles of drone inspections for outage management. The 2025 projected expenditures for other discretionary inspections of distribution electric lines and equipment decreased due to adjustments made to align 2025 expenditures with historical spend data. Specifically, Liberty's initial cost forecast for this initiative included a portion of the ongoing repairs from its 2020 full system survey, which Liberty has since removed as projected costs from this initiative.

## **2.2.11 WMP-GDOM-AI-05: Quality assurance / quality control of inspections**

### **2.2.11.1 Targets**

The 2025 target for quality assurance/quality control (QA/QC) of asset inspections did not change. The target remains at 12% QA/QC of detailed asset inspections.

### **2.2.11.2 Projected Expenditures**

The 2025 projected expenditures for QA/QC of asset inspections increased from \$10,000 to \$30,000.

### **2.2.11.3 Change Justification**

The 2025 projected expenditures for QA/QC of asset inspections increased due to adjustments made based on the implementation of Liberty's formal QA/QC program for asset inspections in 2023. Specifically, Liberty's projected expenditures for its asset inspection QA/QC program are based on an estimated total of 300 hours at an estimated cost of \$100 per hour, which accounts for an increase in labor costs.

## **2.2.12 WMP-GDOM-AI-06: Substation inspections**

### **2.2.12.1 Targets**

The 2025 target for substation inspections did not change. The target remains at 42 substations.

### **2.2.12.2 Projected Expenditures**

The 2025 projected expenditures for substation inspections increased from \$10,000 to \$45,000.

### **2.2.12.3 Change Justification**

The 2025 projected expenditures for substation inspections increased due to adjustments made to align 2025 expenditures with historical spend data. Specifically, Liberty's projected expenditures are based on an estimated total of 252 hours to complete the 42 substation inspections at an estimated cost of \$150 per hour, which accounts for an increase in labor costs. Liberty included a 20% contingency in its projected expenditures to account for uncertainties.

## **2.2.13 WMP-GDOM-GO-01: Equipment settings to reduce wildfire risk**

### **2.2.13.1 Targets**

The 2025 target for equipment settings to reduce wildfire risk was established at seven circuits with Sensitive Relay Profile ("SRP") settings implemented.

### **2.2.13.2 Projected Expenditures**

The 2025 projected expenditures for equipment settings to reduce wildfire risk increased from \$150,000 to \$500,000.

### **2.2.13.3 Change Justification**

At the time of its 2023 WMP submission, Liberty did not have a 2025 target established for the equipment settings to reduce wildfire risk WMP initiative. Liberty's 2025 target aligns with its target for WMP-SA-02: Grid monitoring systems. The 2025 projected expenditures for equipment settings to reduce wildfire risk increased due to additional experience developing Liberty's SRP program.

## **2.2.14 WMP-VM-INSP-02: VM Inspection Program – Patrol**

### **2.2.14.1 Targets**

The 2025 target for VM patrol inspections did not change. Liberty does not establish targets for its VM patrol inspections WMP initiative.

### **2.2.14.2 Projected Expenditures**

The 2025 projected expenditures for VM patrol inspections increased from \$265,225 to \$330,173.



### **2.2.14.3 Change Justification**

The 2025 projected expenditures for VM patrol inspections increased due to adjustments made to align 2025 expenditures with historical spend data and updated rates for contracted arborists to perform these inspections. Specifically, Liberty's projected expenditures are based on completing an estimated 160 miles of VM patrol inspections at an estimated cost of \$2,064 per mile.

## **2.2.15 WMP-VM-VFM-03: Substation Defensible Space**

### **2.2.15.1 Targets**

The 2025 target for substation defensible space was established at 12 substations. Liberty intends to perform two site visits per substation for vegetation treatments.

### **2.2.15.2 Projected Expenditures**

The 2025 projected expenditures for substation defensible space increased from \$21,218 to \$84,365.

### **2.2.15.3 Change Justification**

At the time of its 2023 WMP submission, Liberty did not have a 2025 target established for its substation defensible space WMP initiative. The 2025 projected expenditures for substation defensible space increased to account for multiple entries and treatments if they are deemed necessary throughout the growing season as well as additional work that may be identified by substation inspections described in WMP-GDOM-AI-06: Substation Inspections. . Specifically, Liberty's projected expenditures are based on completing defensible space work for 12 substations at an estimated cost of \$7,030 per substation.

## **2.2.16 WMP-VM-VFM-04: Fire-Resilient-Right-of-Ways**

### **2.2.16.1 Targets**

The 2025 target for fire-resilient-right-of-way did not change. Liberty does not establish targets for its VM Fire-Resilient-Right-of-Way WMP initiative.

### **2.2.16.2 Projected Expenditures**

The 2025 projected expenditures for fire-resilient-right-of-way increased from \$270,530 to \$577,360.

### **2.2.16.3 Change Justification**

The 2025 projected expenditures for fire-resilient-rights-of-way increased due to adjustments made to align 2025 expenditures with historical spend data. Previously, some of these expenses may have been recorded in other vegetation management initiatives. The updated projection more accurately reflects all anticipated costs specific to the Liberty Utilities Resilience Corridors Project authorized by the USDA Forest Service. Specifically, Liberty's projected expenditures are based on completing approximately six miles of fire-resilient-right-of-way work at an estimated cost of \$96,227 per mile.

### **2.2.17 WMP-VM-VFM-05: Clearance**

#### **2.2.17.1 Targets**

The 2025 target for clearance was established at 700 miles.

#### **2.2.17.2 Projected Expenditures**

The 2025 projected expenditures for clearance increased from \$940,912 to \$1,405,502.

#### **2.2.17.3 Change Justification**

The 2025 projected expenditures for clearance increased due to adjustments made to align 2025 expenditures with historical spend data. Previously, some of these expenses had been recorded in WMP-VM-VFM-07: Identification and Remediation of At-Risk Species. The updated projection more accurately reflects all projected expenses associated with work completed to maintain vegetation to conductor clearances. Specifically, Liberty's projected expenditures are based on completing approximately 700 miles of vegetation clearance work at an estimated cost of approximately \$2,000 per mile.

### **2.2.18 WMP-VM-VFM-06: Fall-in Mitigation**

#### **2.2.18.1 Targets**

The 2025 target for fall-in mitigation did not change. The target remains at 220 miles.

#### **2.2.18.2 Projected Expenditures**

The 2025 projected expenditures for fall-in-mitigation decreased from \$8,221,975 to \$4,810,059.

### **2.2.18.3 Change Justification**

The 2025 projected expenditures for fall-in-mitigation decreased due to adjustments made to align 2025 expenditures with historical spend data. Previously, some of these expenses included costs associated with maintaining clearances described in WMP-VM-VFM-05: Clearance. Those costs are now being more accurately recorded in that initiative. Additionally, while Liberty has maintained a similar number of annual inspection miles, the number of work orders resulting from those inspections has recently decreased resulting in a decrease in expenditures for this initiative. Specifically, Liberty's projected expenditures are based on completing an estimated 220 miles of fall-in mitigation work at an estimated cost of \$22,000 per mile.

## **2.2.19 WMP-VM-ESG-01: VM Enterprise Management System**

### **2.2.19.1 Targets**

The 2025 target for VM enterprise management system did not change. Liberty does not establish targets for its VM Enterprise Management System WMP initiative.

### **2.2.19.2 Projected Expenditures**

The 2025 projected expenditures for VM enterprise management system increased from \$430,731 to \$843,648.

### **2.2.19.3 Change Justification**

The 2025 projected expenditures for VM enterprise management system increased due to adjustments made to align 2025 expenditures with historical spend data. Specifically, Liberty's projected expenditures include costs associated with project permitting, community outreach, communications, and various VM program development activities. Liberty's average expenditures for this initiative are \$70,304 per month.

## **2.2.20 WMP-SA-02: Grid monitoring systems**

### **2.2.20.1 Targets**

The 2025 target for grid monitoring systems decreased from 10 fault indicators to 7 fault indicators.

### **2.2.20.2 Projected Expenditures**

The 2025 projected expenditures for grid monitoring systems increased from \$150,000 to \$300,000.

### **2.2.20.3 Change Justification**

The 2025 target for grid monitoring systems decreased due to adjustments made based on additional experience developing Liberty's SRP program. Liberty's 2025 target aligns with its target for WMP-GDOM-GO-01: Equipment settings to reduce wildfire risk. The 2025 projected expenditures for grid monitoring systems increased due to additional experience developing Liberty's SRP program.

## **2.2.21 WMP-EP-01: Wildfire and PSPS Emergency Preparedness Plan**

### **2.2.21.1 Targets**

The 2025 target for wildfire and PSPS emergency preparedness plan did not change. Liberty does not establish targets for its Wildfire and PSPS Emergency Preparedness Plan WMP initiative.

### **2.2.21.2 Projected Expenditures**

The 2025 projected expenditures for wildfire and PSPS emergency preparedness plan was established at \$35,000.

### **2.2.21.3 Change Justification**

At the time of its 2023 WMP submission, Liberty did not have 2025 projected expenditures established for its Wildfire and PSPS Emergency Preparedness Plan WMP initiative. The 2025 projected expenditures for wildfire and PSPS emergency preparedness planning were established based on relevant historical spend data.

### 3. Quarterly Inspection Targets for 2025

Table 3-1 lists quarterly targets for 2025 asset and vegetation inspections. If 2025 end-of-year targets were adjusted from what was reported in the 2023-2025 WMP, a change justification has been provided in Section 3.2.

*Table 3-1: Asset Inspection and Vegetation Management Targets for 2025*

WMP Initiative	Target End of Q2 2025	Target End of Q3 2025	End of Year Target 2025
WMP-GDOM-AI-01: Detailed inspections of distribution electric lines and equipment	65 miles	195 miles	260.4 miles
WMP-GDOM-AI-02: Intrusive pole inspections	0 poles	500 poles	2,652 poles
WMP-GDOM-AI-03: Patrol inspections of distribution electric lines and equipment	270 miles	540.9 miles	540.9 miles
WMP-GDOM-AI-04: Other discretionary inspections of distribution electric lines and equipment	0.5 miles	0.75 miles	1.0 miles
WMP-GDOM-AI-05: Quality assurance / quality control of inspections	0% of detailed inspections	0% of detailed inspections	12% of detailed inspections
WMP-GDOM-AI-06: Substation inspections	10 substations	22 substations	42 substations
WMP-VM-INSP-01: Vegetation Management Inspection Program – Detailed	110 miles	165 miles	220 miles
WMP-VM-INSP-03: Vegetation Management Inspection Program - LiDAR	0 miles	700 miles	700 miles
WMP-VM-QAQC-01: VM QA/QC	120 miles	229 miles	229 miles

## **4. New or Discontinued Programs**

Liberty includes information on one new WMP-related program in Section 4.1.

### **4.1 New Programs**

In July 2023, Liberty initiated a new component of its Vegetation Management QA/QC program. This includes a QA inspection of vegetation in vicinity of its power lines for adherence to regulatory minimum clearance requirements and conformance to Liberty standards. The QA assessment is composed of a random statistical sample of distribution and transmission line segments from its entire system. The QA assessment sets a baseline for future audits and ability to measure compliance and conformance over time. At 95% confidence, 99% estimate of compliance and a 3% error rate, a sample size of 41 miles was audited. Liberty intends to continue to implement QA assessments on its system on a similar timeframe and before fire season. Liberty found that it was 98.87% compliant by span and 99.48% compliant by number of trees assessed within the sample spans.

### **4.2 Discontinued Programs**

Liberty does not plan to discontinue any WMP programs in 2025.

## 5. Progress on Areas for Continued Improvement

This section provides required progress on the Areas of Continued Improvement identified by Energy Safety.<sup>6</sup>

### 5.1 LU-23-01: Cross-Utility Collaboration on Risk Model Development

**Description:** Liberty and the other IOUs have participated in past Energy Safety-sponsored risk model working group meetings. The risk model working group meetings facilitate collaboration among the IOUs on complex technical issues related to risk modeling. The risk model working group meetings are ongoing.

**Required Progress:** Liberty and the other IOUs must continue to participate in all Energy Safety-organized risk model working group meetings.

**Liberty Response:** Liberty looks forward to continued participation in Energy Safety-sponsored risk modeling working group (“RMWG”) meetings. These meetings have allowed Liberty to learn from and benchmark against the other IOUs when discussing risk modeling best practices and identifying potential areas of improvement related to the technical aspects of wildfire and PSPS risk modeling for planning and operational purposes. The RMWG provides valuable perspectives from various stakeholders, including utilities, state agencies, and intervening parties.

### 5.2 LU-23-02: PSPS and Wildfire Risk Trade-Off Transparency

**Description:** Liberty does not provide adequate transparency regarding PSPS and wildfire risk trade-offs, or how it uses risk ranking and risk buy-down to determine risk mitigation selection.

**Required Progress:** In its 2025 Update, Liberty must describe:

- How it prioritizes PSPS risk in its risk-based decisions, including trade-offs between wildfire risk and PSPS risk.
- How the rank order of its planned mitigation initiatives compares to the rank order of mitigation initiatives ranked by risk buy-down estimate, along with an explanation for any instances where the order differs.

**Liberty Response:** Liberty does not currently calculate trade-offs between wildfire risk and PSPS risk. Liberty prioritizes mitigation initiatives based on wildfire risk and asset failure risk. Liberty

---

<sup>6</sup> Decision on 2023-2025 Wildfire Mitigation Plan; Liberty, Section 11

has implemented zero PSPS events and considers the risk of PSPS to be low compared to that of wildfire risk. Liberty's PSPS Risk Model, currently in development, will allow for additional analysis of wildfire and PSPS risk trade-offs. Liberty provides updated descriptions of wildfire and PSPS risk in Sections 6 and 7 of its updated 2023-2025 WMP.

### **5.3 LU-23-03: Collaboration Between Vendor and Utility Risk Teams**

**Description:** Liberty has not shown how its internal team and risk model vendor will share risk modeling and mitigation related duties.

**Required Progress:** In its 2025 Update, Liberty must:

- Demonstrate how Liberty differentiates between activities completed by the internal staff and vendor staff throughout risk modeling narratives. This includes processes, procedures, methodologies, flow charts, schematics, and any explanations that describe collaboration with a risk modeling vendor.
- Demonstrate how Liberty identifies activities that require vendor discretion and state whether final approval from the Liberty risk team is required. This includes any decisions that need to be made, such as mitigation selection.
- Indicate the source of the data where a description of data is required, specifically indicating whether the data are internally generated or vendor generated. If Liberty cannot indicate the source of the data, it must explain why.

**Liberty Response:** Liberty collaborates with vendors to develop its overall risk models and relies on vendors to provide a platform for running simulations and analyzing different scenarios. Liberty is responsible for producing simulations, analysis, and resulting mitigation decision-making.

Liberty employees meet with vendors regularly to discuss progress on risk model development. Aside from the technical aspects of the model, such as underlying infrastructure, code, and maintenance, all decisions require approval from Liberty. Liberty subject matter experts review preliminary results from model outputs to approve the methodology and to provide input on how to improve the model.

Liberty describes the data sources used for the wildfire risk model in Section 6.5 and its risk modeling approach in Section 7.1 of its updated 2023-2025 WMP. Refer to Figure 5-1 for a high level summary of how Liberty's SMEs and Liberty's risk model vendors will share risk modeling and mitigation related duties.



Figure 5-1: Liberty High Level Risk-Based Decision-Making Framework Process

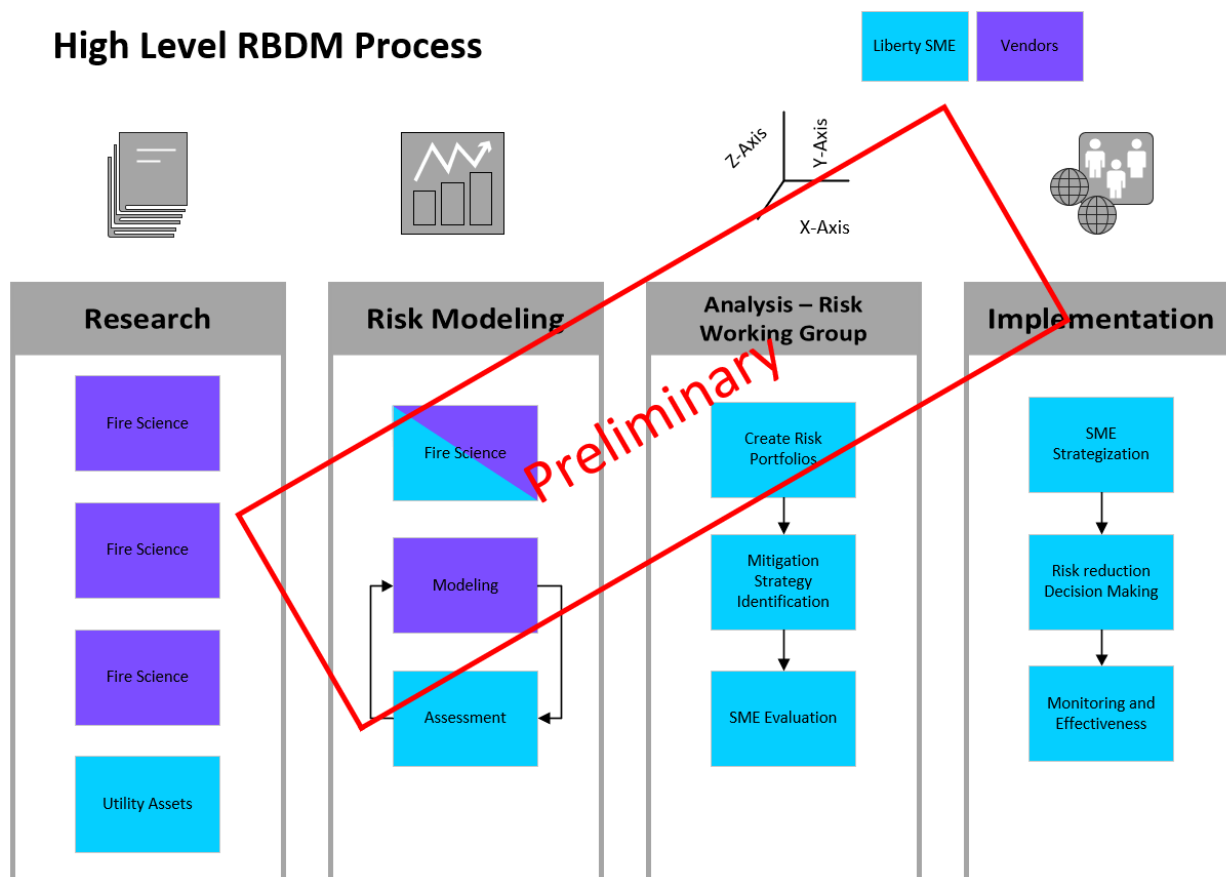

## 5.4 LU-23-04: Vendor Fire Risk Model Implementation Milestones and Dates

**Description:** Liberty’s operational and planning models may experience many changes once the vendor model implementation is complete. Energy Safety needs more information regarding improvements Liberty expects in its operational and planning models along with expected milestones and dates to ensure Liberty is being transparent about the state of its model maturity.

**Required Progress:** In its 2025 Update, Liberty must describe how it will use the new vendor risk modeling software to improve operational and/or planning risk analysis and provide a plan with milestones and dates for achieving those improvements.

**Liberty Response:** Liberty provides additional information regarding improvements to Liberty’s wildfire risk models, along with expected milestones and dates throughout Section 6 of its updated 2023-2025 WMP. Refer to Table 2-3 of Liberty’s 2025 WMP Update for a summary of

significant updates to Liberty’s Wildfire Risk Models, including specific section references for the updates and associated milestones. Refer to Section 6.5 of Liberty’s 2023-2025 WMP for a plan with milestones and dates for Liberty’s risk modeling plan. Also refer to Figure 5-2 below.

*Figure 5-2: Timeline of Liberty’s Risk Modeling Plan*

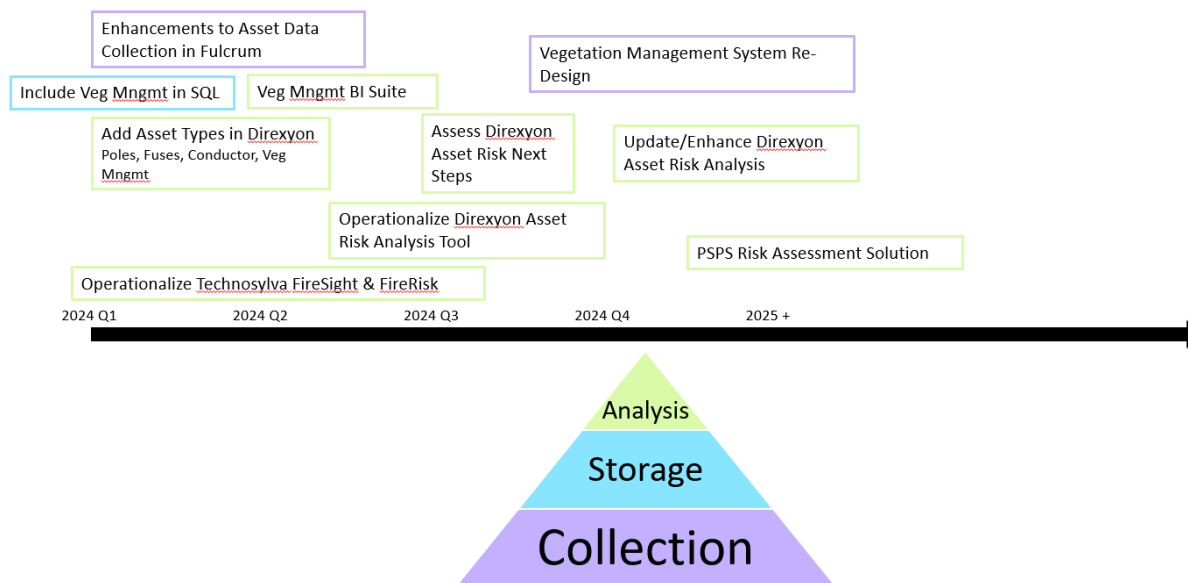

## 5.5 LU-23-05: Cross-Utility Collaboration on Best Practices for Inclusion of Climate Change Forecasts in Consequence Modeling, Inclusion of Community Vulnerability in Consequence Modeling, and Utility Vegetation Management for Wildfire Safety

**Description:** Liberty and the other IOUs have participated in past Energy Safety-sponsored scoping meetings on these topics but have not reported other collaboration efforts.

**Required Progress:** Liberty and the other IOUs must participate in all Energy Safety-organized activities related to best practices for:

- Inclusion of climate change forecasts in consequence modeling.
- Inclusion of community vulnerability in consequence modeling.
- Utility vegetation management for wildfire safety.

Liberty must collaborate with the other IOUs on developing the above-mentioned best practices. In their 2025 Updates, the IOUs (not including independent transmission operators) must provide a status update on any collaboration with each other that has taken place,

including a list of any resulting changes made to their WMPs since the 2023-2025 WMP submission.

**Liberty Response:** Liberty has participated in all Energy Safety-organized Risk Modeling Working Group meetings and looks forward to continued participation in Energy Safety-sponsored meetings on topics related to inclusion of climate change forecasts in consequence modeling, inclusion of community vulnerability in consequence modeling, and utility vegetation management for wildfire safety. In addition to Energy Safety-sponsored activities, Liberty participates in cross utility collaboration activities for best practice sharing, including:

- California Utility Forecasters Meeting – meteorology, weather forecasting and modeling;
- Western Utilities Weather Forecast Discussion – meteorology and weather forecasting;
- California Vegetation Managers Meeting – VM;
- Utility Arborist Association – VM;
- Trees and Utilities Conference – VM;
- International Lineman’s Rodeo – asset inspections and maintenance;
- Liberty, Truckee Donner Public Utilities District, and NV Energy Meeting – wildfire mitigation & PSPS collaboration.

As of its 2025 WMP Update submission, Liberty has no changes to report as a result of collaboration with other IOUs on these topics in 2024.

## 5.6 LU-23-06: Effectiveness of SRP and Traditional Hardening

**Description:** Liberty states that it is not pursuing more installation of covered conductor due to implementation of SRP and the use of traditional hardening, but does not adequately demonstrate the effectiveness or comparability of SRP versus covered conductor.

**Required Progress:** In its 2025 Update, Liberty must:

- Provide its calculations for ignition reduction effectiveness for covered conductor compared to SRP, traditional hardening, and SRP in combination with traditional hardening. This must demonstrate considerations of various ignition risk drivers, deployment time and resources, performance comparison in forested versus non-forested areas, and risk model output of riskiest areas.
- Adjust its covered conductor targets accordingly based on the analysis provided.

**Liberty Response:** Liberty is pursuing more installation of covered conductor as part of its Wildfire Mitigation Plan. SRP is being implemented as an expedited mitigation strategy to provide additional risk reduction with covered conductor and is not being implemented as an alternative to covered conductor. Liberty has experienced delays in permitting covered

conductor projects, and SRP is being used to provide expedited risk reduction while covered conductor projects continue to be planned and permitted. Traditional hardening is also selected for circuits in high fire risk areas. Due to its limited history of utility-caused ignitions, reliability data is used as a proxy for ignition reduction effectiveness. Circuits where traditional hardening and covered conductor has been installed show significant improvement in reliability metrics. Refer to Figure 5-3 for a summary table of Liberty SAIFI and SAIDI metrics on select circuits from 2021-2024. SRP has not been implemented on the system or included in the risk model to allow for calculations on its effectiveness. In selecting SRP for its ignition reduction effectiveness, Liberty relied on data from other utilities that have been using it as a mitigation strategy. Specifically, San Diego Gas and Electric has been using SRP for over a decade with no ignitions downstream of SRP-enabled devices while maintaining system reliability.<sup>7</sup>

When comparing SRP to traditional overhead hardening and covered conductor, Liberty considers cost, time, and resource requirements for implementing as well as ignition reduction effectiveness. Refer to Table 5-1 for a summary of Liberty's evaluation of these three WMP initiatives. Liberty's evaluation determined that they are all effective and will all be used as part of Liberty's overall risk mitigation strategy.

---

<sup>7</sup> <https://www.cpuc.ca.gov/-/media/cpuc-website/divisions/safety-and-enforcement-division/fast-trip/sdge--fast-trip-unplanned-outages-and-distribution-reliability-workshop-presentation.pdf>

Figure 5-3: Liberty SAIFI and SAIDI Summary (2021-2024)

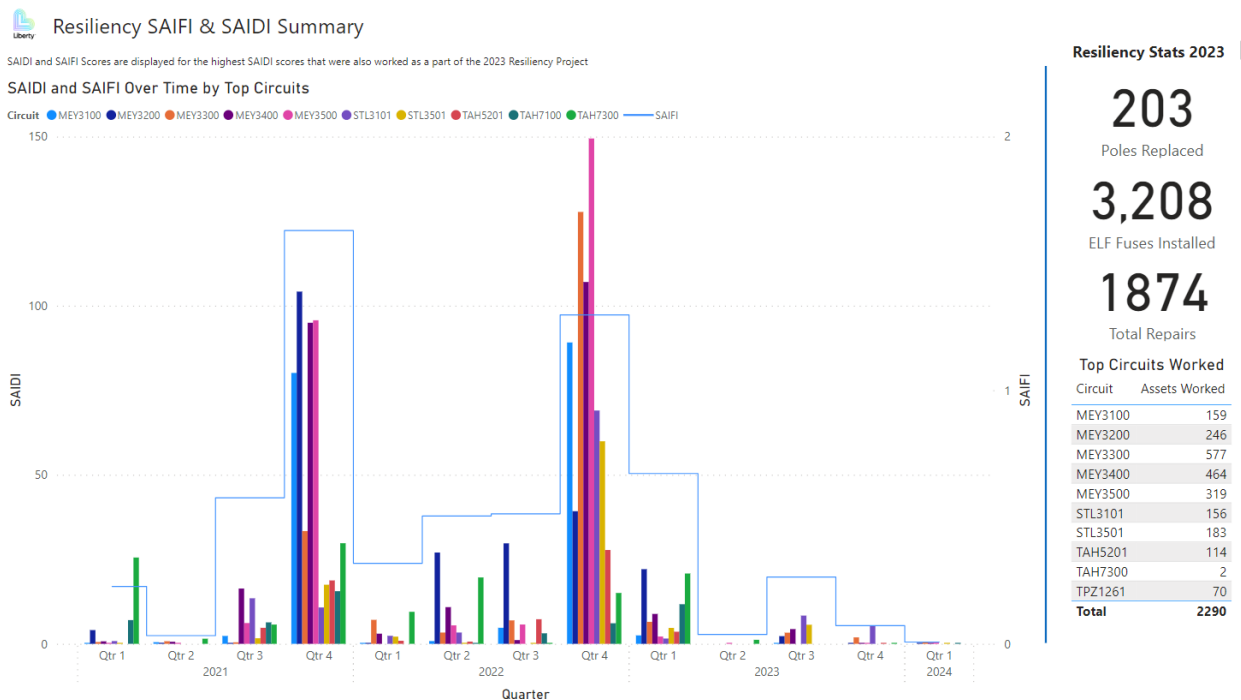

Table 5-1: Summary of Liberty’s Evaluation of SRP, Traditional Overhead Hardening, and Covered Conductor WMP Initiatives

Initiative	Cost Per Mile	Time to Implement	Resource Needs	Effectiveness
Sensitive Relay Profile	Low	Low	Low	High
Traditional Overhead Hardening	Moderate	Moderate	Moderate	High
Covered Conductor	High	High	Moderate	High

### 5.7 LU-23-07: Further Design Considerations

**Description:** Liberty’s maturity for the grid design and resiliency capability does not project comparable growth when compared to its peers.

**Required Progress:** In its 2025 Update, Liberty must provide a plan demonstrating how it will progress in maturity for the grid design and resiliency capability by 2026. This must include advancements in considering grid localization features as well as non-electrical corporation equipment as part of its grid design, design evaluation, and grid impact evaluation. If Liberty

does not find that it is necessary to advance in these areas, Liberty must justify why these considerations are not necessary as part of its wildfire risk evaluations.

**Liberty Response:** Liberty considers both grid localization features as well as non-electrical corporation equipment as part of its grid design, design evaluation, and grid impact evaluations. If Liberty's responses to the WMP Maturity Survey indicated a lack of maturity in these areas, it is likely due to a misunderstanding of the question as presented in the WMP Maturity Survey. Upon further review of Liberty's responses to the 2023 WMP Maturity Survey, Liberty's SMEs would have revised its responses to demonstrate higher maturity. Liberty will continue to look for ways to advance both issues.

Liberty considers grid localization features in the establishment of its PSPS zones, SRP implementation, and outage management system. For instance, Liberty's SRP program will allow Liberty's operations teams to increase relay sensitivity on select lines using weather forecasting and situational awareness to decrease fire risk. Liberty also plans to install fault detectors as part of its SRP implementation to decrease restoration times.

Liberty considers non-electrical corporation equipment, including communications equipment, in pole loading calculations to current standards. Through the Joint Pole Association process, Liberty will reach out to other pole attachment holders to review whether Liberty's calculations for pole loading meets their needs or whether a request to increase pole size is necessary.

## 5.8 LU-23-08: Halting Detailed Distribution Inspections

**Description:** Liberty elected to halt its Detailed Distribution inspections in 2023 to focus on reducing its work order backlog. Liberty did not explain how it will continue to manage its backlog after resuming detailed distribution inspections.

**Required Progress:** Required Progress: In its 2025 Update, Liberty must:

- Update Energy Safety on the effectiveness of its decision to halt detailed inspections to address its work order backlog. Liberty must provide an analysis comparing the number of work orders closed in 2021, 2022, and 2023 to the number of work orders created in 2021, 2022, and 2023.
- Explain how it will continue to reduce its backlog after resuming detailed inspections on January 1, 2024. This discussion must include a forecast of the number of tags Liberty expects to open in 2024 and 2025 that accounts for a potential increase in findings resulting from incorporating LiDAR, infrared, and drone technologies into its inspection portfolio. Liberty must provide the number of tags it expects to close in 2024 and 2025.

If the utility expects to close ten percent or more tags in either 2024 or 2025 than the average annual tags closed from 2020-2022, it must provide its reasoning.

**Liberty Response:** Liberty did not elect to halt detailed distribution inspections in 2023. Liberty initially targeted 156.4 miles of detailed inspections for 2023 (See Liberty\_2022\_Q4\_Tables1-15\_R1, Table 12). After an analysis of open work orders, Liberty considered halting detailed inspections and subsequently revised its 2023 target to 40.3 miles of detailed inspections (See Liberty\_2023\_Q4\_Tables1-15\_RO, Table 12) to reduce the backlog of open work orders. Liberty later determined that it should not halt or reduce detailed inspections and completed 181.4 miles for this initiative in 2023, exceeding the initial target of 156.4 miles, which was reported in Q4 2022.

When comparing work orders created to the number of work orders closed in 2021, 2022, and 2023, Liberty closed an average of 1,376 work orders per year. Using a three-year average of number of work orders closed and average number of work orders created per mile of line inspected, Liberty calculates that it would close approximately 444 work orders more than will be created in 2024 and 2025. To eliminate the current backlog of 604 past due work orders, Liberty will need to increase the number of closed work orders to 1,456 (6% increase over three-year average) for the next two years. Refer to Figure 5-4.

Figure 5-4: Liberty Asset Inspection Work Orders by Year, 2021-2025



Liberty's target of 264.2 miles of detailed inspections in 2024 is not a substantial increase over previous years. Based on the analysis conducted, an increase in findings from inspections over previous years is not expected to constrain Liberty's ability to eliminate its backlog of open work orders.

Due to its decision not to halt or reduce detailed inspections in 2023 and the ability to consistently close more work orders than is projected to be created in 2024 and 2025, Liberty's current approach to performing inspections and repairs will allow for the elimination of the work order backlog by the end of 2025.

## 5.9 LU-23-09: Covered Conductor Inspections and Maintenance

**Description:** Liberty does not incorporate checks in its inspection programs that address failures specific to covered conductor. Liberty must tailor its inspection practices to address failure modes specifically related to covered conductor.

**Required Progress:** In its 2025 Update, Liberty must explain how failure modes unique to covered conductor will be accounted for in its inspections, including water intrusion, splice covers, and surface damage. If Liberty determines any or all the preceding changes are unnecessary, then it must provide how its current inspection and maintenance processes address covered conductor failure modes.



**Liberty Response:** Liberty's current inspection and maintenance activities address covered conductor failure modes. Upon installation, a post-construction inspection is conducted to assess the covered conductor for adherence to construction standards, and manufacturer specifications. Refer to Appendix A the Spacer Cable Inspection Checklist.

Liberty follows General Order (GO) 95 overhead electric line construction standards and GO 165 minimum timing requirements for inspections. Detailed inspections include common or known failure modes for all construction types including covered conductor. To account for specific issues related to covered conductor, Liberty is adding water intrusion, splice covers, surface damage/bulging, and bracket placement to its detailed inspection checklist.

## 5.10 LU-23-10: Distribution detailed inspection frequency

**Description:** Liberty performs the minimum frequency of detailed inspections required by GOs 95 and 165. Liberty must strive to adopt a risk-based approach by increasing the frequency of detailed inspections on assets that have the highest risk according to its risk model.

**Required Progress:** In its 2025 Update, Liberty must either:

- Outline a plan to update its detailed inspections in higher risk areas, including:
  - An analysis for determining the updated frequency for performing detailed inspections.
  - Prioritization of higher risk areas based on risk analysis and risk model output, including HFTD Tier 3 lands.
  - Updates to inspection checklists to account for equipment or configurations that may pose greater wildfire risk.
  - A plan to obtain any needed workforce for performing more frequent inspections; OR
- Demonstrate that its existing inspection program adequately addresses risk. This must include analysis of the following:
  - Number of Level 1 or critical issues found during detailed inspections.

**Liberty Response:** Liberty's existing program adequately addresses risk and would not significantly reduce risk by increasing inspection frequency. An analysis of 2,290 detailed inspection records in Liberty's database show that 0.04% of inspections in HFTD Tier 3 resulted in a Level 1 issue found. When examining non-critical issues, 53.28% inspections were passed, and 37.86% Level 3 issues were found. This equates to 91.14% of inspections being no or low risk findings in HFTD Tier 3 lands. The remaining 8.82% of inspections resulted in a Level 2 finding, which Liberty follows the corrective action timeline established in General Order 95, Rule 18 of six months to address the risk. Refer to Table 5-2 and Figure 5-5.

*Table 5-2: Liberty Findings from Detailed Asset Inspections*

Findings from Detailed Inspections					
HFTD	Level 1	Level 2	Level 3	Passed	Grand Total
3	1	202	867	1220	2290
	0.04%	8.82%	37.86%	53.28%	100.00%

*Figure 5-5: Liberty Findings from Detailed Asset Inspections*

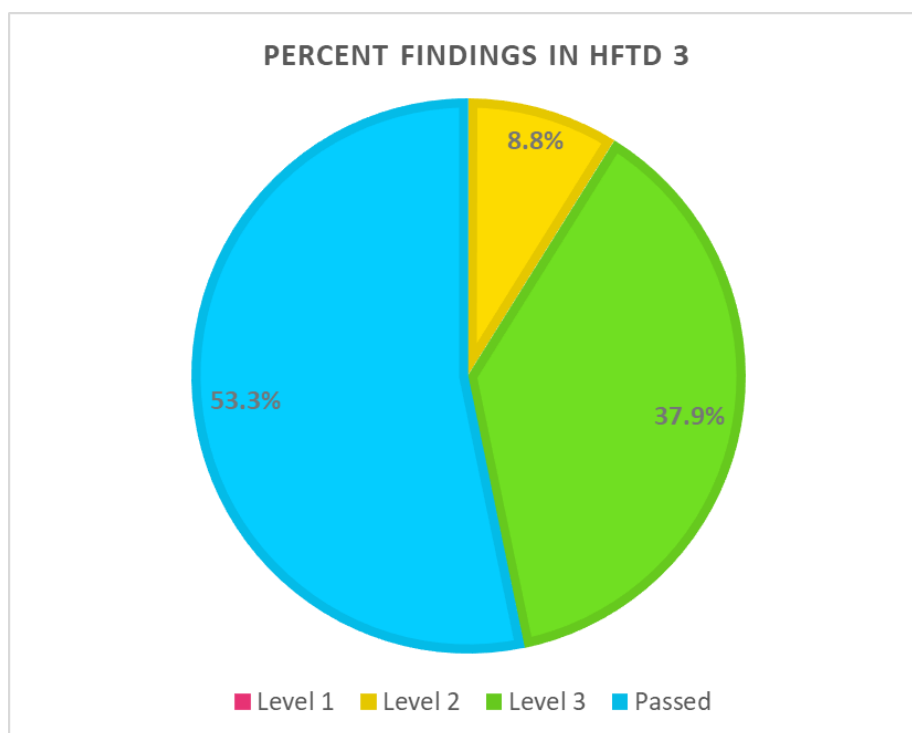

### 5.11 LU-23-11: QA/QC sample size and pass rates

**Description:** Liberty has created asset inspection QA/QC targets for 2023, but not for 2024 or 2025. Instead, Liberty explained it did not provide the 2024 and 2025 targets given the infancy of its program, and its intention to set these targets based on prior year experience. In its 2025 Update, Liberty must provide QA/QC pass rate targets for 2025.

**Required Progress:** Liberty must establish asset inspection QA/QC targets for 2025. The 2025 targets must demonstrate Liberty's progress toward industry standards in asset inspection QA/QC pass rates, and account for an appropriate increase in 2024. Liberty must strive to reach industry standard QA/QC pass rates by the end of 2025, such as SCE's target of 95 percent, SDG&E's target of 100 percent, and PG&E's target of 95 percent for distribution detailed inspections.

**Liberty Response:** Liberty has established an asset inspection QA/QC target of 90% for 2024 and 2025.

## 5.12 LU-23-12: Additional Inspection Practices

**Description:** Liberty states that it plans to incorporate three technologies, LiDAR, infrared, and drone inspections, during the 2023-2025 WMP cycle. Liberty must provide more information on these programs.

**Required Progress:** In its 2025 Update, Liberty must:

- Define the pilot program scope for each technology.
- Provide a project milestone timeline for each technology.

**Liberty Response:**

- Infrared inspections: In 2023, Liberty piloted and completed 0.1 miles of fixed wing drone infrared inspections on its transmission assets. The inspections were performed on 120kV and 60kV riser poles to identify hot spots on the potheads, cable and other associated hardware at the riser locations. No discrepancies were noted during these inspections. Liberty's assessment of this technology is still ongoing.
- Drone inspections: Liberty plans to pilot one mile of drone inspections in 2024, utilizing an internal drone and pilot. Liberty will target these drone inspections for outage management.
- LiDAR inspections: Liberty will be performing a one-time LiDAR inspection of Liberty's system, with a focus on gaining increased visibility and data for mapping tree attachments and secondary wires. The LiDAR inspection is scheduled for late-July – early-August 2024.

## 5.13 LU-23-13: Lightning arrester replacement

**Description:** Liberty states that it is evaluating CAL FIRE-exempt arresters for the replacement of installed non-exempt arresters. Liberty has not provided a timeline for the evaluation and pilot process or a plan for identifying and tracking installed, non-exempt arresters.

**Required Progress:** In its 2025 Update, Liberty must provide:

- A timeline for the evaluation and pilot phase of exempt lightning arrester installation.
- A plan to identify and track currently installed non-exempt arresters.

**Liberty Response:** Liberty's evaluation timeline is as follows:

- Q3 2024 evaluation and selection of exempt lightning arrester to be piloted,

- Q4 2024 – Q1 2025 engineering standards committee review and engineering/construction standards development,
- Q1-Q2 2025 selected lightning arrester procurement,
- Q3-Q4 2025 lightning arresstor installation/pilot implementation.

Regarding the currently installed non-exempt arresters, Liberty’s asset tracking application will be utilized to identify and track arresters in the field. When an exempt arrester is selected, Liberty will use the asset tracking application for project tracking.

### **5.14 LU-23-14: Expulsion fuse replacement targets**

**Description:** Liberty has not provided expulsion fuse replacement targets for 2024 or 2025. Instead, Liberty explained it did not provide targets due to project delays resulting from a high rate of field failures associated with replacement fuses and its intended transition to a new type of expulsion fuse.

**Required Progress:** In its 2025 Update, Liberty must provide an expulsion fuse replacement target for 2025 that encompasses fuses to be replaced in both 2024 and 2025.

**Liberty Response:** Liberty is targeting 500 expulsion fuse replacements in 2024 and 500 expulsion fuse replacements in 2025. Liberty has updated Table 8-3 and Section 8.12.12 of its 2023-2025 WMP to reflect these targets.

### **5.15 LU-23-15: Reliability Impacts of SRP**

**Description:** Liberty has not demonstrated an understanding of the reliability impacts of using SRP.

**Required Progress:** In its 2025 Update, Liberty must:

- Provide the following information for 2023 outages that occurred while SRP settings were enabled in a spreadsheet format:
  - Circuit impacted by outage.
  - Circuit segment impacted by outage.
  - Cause of outage (in line with QDR Table 6 drivers).
  - Number of customers impacted.
  - Number of customers impacted belonging to vulnerable populations (such as customers with access and functional needs and Medical Baseline customers).
  - Duration of outage.
  - Response time to outage.
  - Customer minutes of interruption.

- Provide Liberty’s calculations on the effectiveness of the SRP implementation. This must demonstrate calculations of avoided ignitions based on outages that occurred.
- Discussion of any expected changes in SRP implementation based on the above, including percentages of coverage across Liberty’s territory and SRP enablement thresholds used by Liberty.

**Liberty Response:** Liberty did not implement its SRP program in 2023 and did not enable fast-trip settings throughout 2023. Thus, there were zero outages that occurred in 2023 while SRP settings were enabled. Additionally, Liberty does not have calculations on the effectiveness of SRP implementation, including calculations of avoided ignitions based on outages that occurred. Liberty monitors the implementation of similar settings at other IOUs in California, including review of other IOU WMPs and associated filings, participating in WMP workshops and public meetings, and through Joint IOU groups discussing the implementation of wildfire mitigation technologies. Liberty plans to implement its SRP program on 15 circuits in 2024 and seven circuits in 2025, which will result in 67.45% of Liberty’s primary distribution conductor being covered by SRP by the end of 2025. Liberty will enable SRP settings on its system when a Red Flag Warning is issued by the National Weather Service or when the Severe Fire Danger Index (“SFDI”) reaches a rating of “Severe”. Based on an analysis of historical weather data for the system, Liberty estimates approximately 10-12 days per year when SRP will be enabled.

## 5.16 LU-23-16: Evaluation of High Impedance Fault Detection

**Description:** Liberty does not provide adequate justification as to why it is not moving forward with HIFD technology.

**Required Progress:** In its 2025 Update, Liberty must provide:

- A list of the types of faults covered and not covered by HIFD showing 70 percent effectiveness as discussed in its WMP.
- Evaluation of the effectiveness of HIFD in preventing ignitions, both independently and when used in combination with SRP.
- Analysis demonstrating the percentage of unnecessary faults caused by HIFD. This should include qualitative as well as quantitative analysis in the form of results from implementation along the Liberty’s Meyers 3400 circuit, including a spreadsheet of the faults and associated causes experienced during enablement.
- Discussion of Liberty’s coordination with other utilities on implementation of HIFD, including observed effectiveness.
- Adjustment of its HIFD implementation targets accordingly given the above analysis.

**Liberty Response:** The University of Nevada Reno (“UNR”) completed a Fire Mitigation Protection System Study for Liberty. Liberty provides this study in Appendix B. This report recommends that Liberty should no longer pursue HIFD and should pursue a fast trip or SRP scheme to reduce fire risk. The relevant findings of the UNR study include the following:

- The SEL relay detected 67.6% of the HIF test cases (998 HIFs were detected out of 1,476 HIF cases).
- The average detection time of HIF detection methods is around 50 seconds. Therefore, even though the relay can reduce human safety risks, the high detection time makes it less effective for mitigating wildfire hazards.
- The SEL relay detection performance is independent from arc resistance uncertainty. The relay shows approximately the same detection rate for different values of uncertainty. Also, the relay HIF detection time is independent from uncertainty levels.
- The dependability rate and detection time of the HIF methods of the relay are independent of the fault positions along the feeder.
- The dependability rate for SEL 451 is better for high sensitivity setting of 1 as opposed to 0 for low sensitivity. However, increasing sensitivity may compromise the security rate of the method by detecting no-fault scenarios as fault scenarios. Because utilities cannot tolerate trips for no-fault scenarios, a residual overcurrent element, 67G, can be used to improve the security. The element 67G is asserted if 3I0 is higher than a specified pickup. Therefore, the high sensitivity can be used only if the 67G pickup is met.
- In general, the relay phase determination accuracy is almost 63% and 55% for arcing sensitivity level equals to 1 and 0, respectively.
- In Section 5, fast tripping scheme and settings for several utilities are discussed as a practical technique to reduce the fault clearing time in distribution networks. Fast tripping lowers the released energy and in turn mitigates the fire risk in distribution networks. Based on the extensive RTDS simulations and results shown in this report, UNR strongly recommends that a fast-tripping scheme be implemented in high fire risk areas to reduce the fault clearing time; thereby significantly mitigating the fire risk.

### **5.17 LU-23-17: Progress toward eliminating vegetation management work order backlog**

In its Final Decision on Liberty’s 2023-2025 WMP, Energy Safety removed LU-23-17 and left the identification numbering for the remaining areas for continued improvement unchanged.

## 5.18 LU-23-18: Weather Station Optimization

**Description:** In 2023, Liberty plans to use a weather station optimization tool to identify spatial gaps in its weather station network and determine if additional weather stations are needed. Liberty must report on its progress as it completes the assessment.

**Required Progress:** In its 2025 Update, Liberty must:

- Describe how the weather optimization tool was used to assess the density of weather stations in its service territory.
- Provide any locations identified for additional weather stations installations.
- Include the number of weather stations planned for future installations of weather stations, based on its assessment.

**Liberty Response:** Liberty engaged Eagle Rock Analytics to perform a weather station optimization analysis for its system to evaluate how well the network captures the diversity of climate conditions within Liberty's territory. Liberty has provided updated location data of its existing weather station network, and Eagle Rock Analytics is using the data to re-run the analysis. Liberty is awaiting results of the new analysis. There are no additional weather stations currently planned for installation. The results of the analysis will show if additional weather stations are needed.

The weather optimization analysis from Eagle Rock Analytics evaluates a 1km x 1km grid across Liberty's service territory. The analysis asks how similar the bioclimate conditions of each grid location is to the locations where weather stations are installed. If the resulting value is high, the area of that grid is already well captured by existing weather stations. If the resulting value is low, then the conditions in that grid differ significantly from locations where existing weather stations exist and a weather station being installed within that grid would provide more accurate weather forecast for that grid area. Eagle Rock Analytics is currently re-running this analysis using the 39 existing weather stations that Liberty utilizes, and the results will inform if it is necessary to install new weather stations in any parts of Liberty's service territory for more accurate weather forecasting. Refer to Appendix C for the initial analysis performed by Eagle Rock Analytics.

## 5.19 LU-23-19: Weather Station Maintenance, and Calibration

**Description:** Liberty reports having 35 weather stations in its network but no maintenance or calibrations on those weather stations in three years. Frequent calibration and maintenance of weather stations is crucial for ensuring accurate, reliable, and high-quality data. As Liberty performs its annual weather station and maintenance and calibration, Energy Safety will need

Liberty to report on the following to verify the integrity of the data collected from its weather station network.

**Required Progress:** Liberty must:

- Maintain and keep a log of all the annual maintenance and calibration for each weather station, including the station name, location, conducted maintenance, in compliance with Liberty's weather station installation document, as well as document the annual replacement of any sensors. The log must also include the length of time from initiation of a repair ticket to completion and the corrective maintenance performed to bring the station back into functioning condition.
- In its 2025 Update, provide documentation indicating the number of weather stations that received their annual calibration and the number of weather stations that were unable to undergo annual maintenance and/or calibration due to factors such as remote location, weather conditions, customer refusals, environmental concerns, and safety issues. This documentation must include:
  - The station name and location.
  - The reason for the inability to conduct maintenance and/or calibration.
  - The length of time since the last maintenance and calibration.
  - The number of attempted but incomplete maintenance or calibration events for these stations in each calendar year.

**Liberty Response:** Liberty commenced its weather station maintenance and calibration program in January 2024. Before this, none of the weather stations in the network received annual maintenance or calibration. Refer to Appendix D for the scope of work for the annual maintenance and calibration program. Refer to Appendix E for a list of weather station calibrations completed in 2024.

## 5.20 LU-23-20: Early detection of Ignitions with HD Cameras

**Description:** Since its 2021 WMP update, Liberty has continually reported that it would partner/adopt HD wildfire cameras each year for early detection of wildfires. However, Liberty still does not have any equipment installed that can detect or monitor ignitions on the grid.

**Required Progress:** In its 2025 Update, Liberty must:

- Provide a plan for the adoption of the targeted eight HD cameras, including what factors caused the delay and how Liberty is working to resolve the delay. Liberty must also provide an outline on the development and implementation of policy and procedures for HD cameras in its service territory.



- Include the number and locations of all the HD cameras that have been adopted.
- Provide an explanation, including any challenges, or roadblocks if the adoption, operationalization, or development of policies and procedures for HD cameras do not get implemented by the time of the submission of Liberty's 2025 Update.

**Liberty Response:** Liberty is working with University of Nevada Reno ("UNR") on an agreement to fund for the maintenance of existing cameras, through the ALERT Wildfire program, within the view shed of Liberty's service territory. There was a delay in executing this agreement, due to UNR exploring the privatization of the ALERT Wildfire program. UNR ultimately decided not to proceed with the privatization. Liberty is awaiting an updated proposal from UNR that will inform the future development of policy and procedures for the cameras. The outline below includes initial policies and procedures that Liberty is developing for the program:

- Cameras are installed and maintained through a partnership with the UNR Seismological Laboratory ("NSL").
- NSL manages the full process of camera installation including securing land-use agreements or permits, procuring equipment and performing installation and maintenance.
- New camera installation takes 1-2 days of labor, plus a 1 –2 week waiting period if concrete work is required.
- NSL aims to install cameras early in the fire season, but exact timing is weather and snow-access dependent. Typically work is limited to summer months.
- Camera maintenance after installation is the responsibility of NSL and includes maintaining power systems, telemetry and operational equipment for command-and-control and public display of camera feeds on websites.
- NSL displays cameras on ALERTWildfire website to ensure continuity of fire camera network.
- NSL aims to address camera outages within 24 hours during fire season.
  - When this is not possible, NSL will communicate the issue to Liberty and determine a plan of action and timeline for repair.
- NSL checks all cameras for maintenance needs on an annual basis and aims to perform all maintenance needs prior to the start of fire season.
  - Timing of maintenance checks and repairs is weather and access road dependent.
- Outside of Fire Season, NSL aims to repair cameras within 3-5 business days, weather and road conditions dependent.

- NSL will communicate with Liberty when there are off season issues with cameras and develop plans for repairs on a case-by-case basis.
- Some cameras managed by NSL are installed using Wireless Internet Service Provider Infrastructure (“WISP”).
  - NSL is responsible for purchasing equipment and coordinating installation with the WISP.
  - When cameras installed on WISP infrastructure need repair, NSL will coordinate repair work and land access with WISP partner.

UNR performed a view shed analysis to propose locations of existing cameras for Liberty to adopt or potentially install new cameras where current coverage is lacking for the service territory. There are twelve existing cameras within the view shed that do not currently have sponsorship. An additional five cameras were proposed to provide coverage in areas where it is lacking. Refer to Figure 5-6.

*Figure 5-6: Map of Installed and Proposed ALERT Wildfire Cameras in Liberty’s Service Territory*

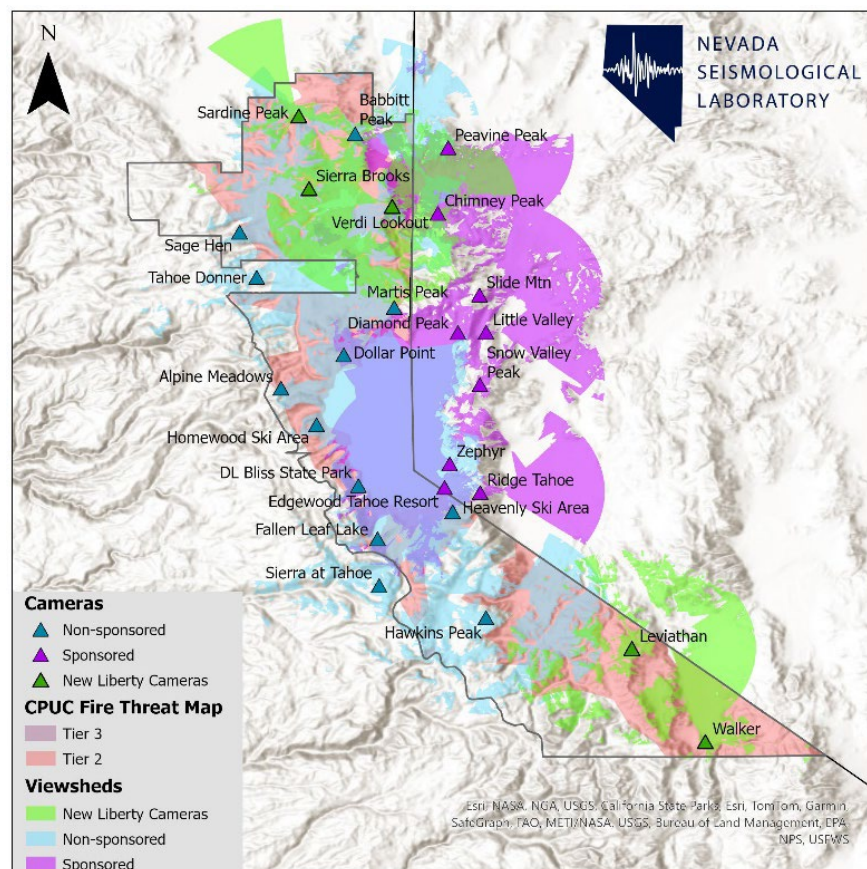

## **6. Appendix A: Spacer Cable Inspection Checklist**

## Hendrix Spacer Cable Systems FINAL INSPECTION CHECKLIST

		Y/N
Safety/Standards	Meets your companies safety requirements	
	Meets your companies construction standards	
Material	Used all Hendrix approved components	
	Only polymer insulators used (no porcelain)	
	Only covered Tie Wires used	
Lightning Arresters	At all open points: taps, dead ends, switches, transitions	
	Ground leads connected to driven ground rods	
Grounding	Connect the messenger to a driven ground rod at every pole in lightning prone areas - never more than 500 feet	
	Messenger ground connected to the secondary neutral	
	Angle and Dead End brackets grounded	
Taps and Splices	Taps offset by 24 inches from adjacent taps or ground points	
	Line Duc properly secured on messenger above all taps	
	Splices covered with Hendrix KM splice or equivalent	
	Anti Sway brackets (BAS-14/24) used at poles with taps	
	Rubber covered transformer tap wire used	
	Bushing covers used on transformers	
Guying	Guys installed at every angle pole over 6 degrees	
	Guy attached to pole at same height as the messenger	
	Anchors driven to the proper depth	
	On multiple circuits, each messenger must be guyed	
	Guy wire grounded or strain insulators used	
Hardware/Messenger	All installation equipment removed	
	Messenger secured in permanent clamp at each pole	
	HPI insulators at corners and conductor in side position at angle poles	
	Adequate slack between phase conductors (5-8 inches at 60 degrees - see table in installation guide)	

## **7. Appendix B: Fire Mitigation Protection System Study for Liberty Utilities**



## **Fire Mitigation Protection System Study for Liberty Utilities**

Final report submitted to:

Liberty Utilities, Tahoe Vista, California

by:

Mehdi Etezadi-Amoli, Ph.D., P.E.

Professor

in collaboration with

Mehrdad Majidi, Ph.D., P.E.

and

Oveis Asgari Gashteroodkhani, Ph.D.

September 28, 2022



## Contents

1. Executive Summary.....	4
2. Introduction .....	6
2.1. Utilities approaches for wildfire risks mitigation.....	6
2.1.1. Grid Hardening and Operating Adaptations to Reduce Risk .....	6
2.1.2. Risk Bowtie.....	7
2.1.3. Driver and Consequence Mitigation Programs .....	8
2.1.4. Typical distribution fault protection.....	12
2.1.5. Sensitive Relay Profile settings.....	12
2.1.6. Sensitive Ground Fault protection .....	13
2.1.7. Falling conductor detection and tripping .....	13
2.2. HIF detection in uni-grounded systems .....	14
2.2.1. Three-phase Uni-grounded System.....	14
2.2.2. High-impedance Fault Detection .....	15
2.2.3. Protection Challenges in Tahoe Area with High-impedance Ground.....	17
2.2.4. Protection Challenges during Load Switching.....	18
2.3. Literature review of HIF detection methods available in academic paper.....	19
3. Feeder and HIF modeling.....	21
3.1. Feeder modeling.....	21
3.2. HIF modeling for different surfaces.....	21
4. SEL 451 relay performance .....	25
4.1. Effects of HIF resistance uncertainty.....	25
4.2. Effects of HIF position along the lines .....	29
4.2.1. Effects of HIF position for sensitivity level = 1.....	29
4.2.2. Effects of HIF position for sensitivity level = 0.....	32
4.3. SEL relay performance analysis for HIF phase detection.....	35
4.4. Effects of arc sensitivity level.....	36
4.5. SEL relay security analysis .....	36
5. Fast Tripping.....	37



## Liberty Utilities – Fire Mitigation Protection System Study

5.1.	San Diego Gas & Electric (SDG&E) .....	42
5.2.	Southern California Edison (SCE) .....	43
5.3.	PacifiCorp .....	45
5.4.	Avista.....	46
5.5.	British Columbia Hydro (BC Hydro).....	50
6.	Conclusions and Future Works .....	51
7.	References .....	52





### 1. Executive Summary

This report assesses methods to reduce wildfires caused by power systems due to high impedance faults (HIFs). HIFs have been challenging researchers and utilities for years since their current magnitudes are below traditional overcurrent relay pickups. Most HIFs include igniting arc between a conductor and a ground surface that may cause fire and human safety issues.

In this report, protection and control practices that utilities are using to deal with wildfire risks are discussed. Details of the fire mitigation approaches for San Diego Gas & Electric (SDG&E) are presented in Section 2.1.

Also, an extensive literature review of HIF detection methods available in academic papers is provided. A Liberty Utility feeder, May3400, is modeled using RSCAD software in a real-time digital simulator (RTDS). An arc model that uses actual HIFs to apply nonlinear distortions in the arc currents is used in the simulations. HIFs for different ground surfaces such as dry cement, dry asphalt concrete, wet cement, dry soil, wet soil, dry reinforced concrete and wet reinforced concrete are modeled. The hardware-in-the-loop setup at the UNR power system lab has been used to test HIF detection modules embedded in the SEL451-6 relay. The current and voltage signals from the simulated feeder in the RSCAD software were sent to the SEL451 relay through ethernet-based communication. Several RSCAD scripts have been written for generating about 1500 HIF scenarios in the RTDS platform without user interaction. These scenarios include HIFs in different lines, different positions in each line, different contact surfaces, different level of uncertainties in nonlinear resistances of HIF model, and different sensitivity levels of HIF detection algorithms.

Different cases have been tested to assess the performance of the two HIF algorithms of the SEL451 relay in the hardware-in-the-loop platform. One method uses the Sum of Difference Current (SDI) which constitutes the non-harmonic components of the phase and residual currents. The other method called ISM uses the odd-harmonic components of the phase and residual currents. The detailed statistics of the test results are given in Section 4. This section assesses the effects of HIF resistance uncertainty, HIF positions along the line, different HIF phases and relay sensitivity levels. In summary, the following results were achieved through extensive hardware-in-the-loop tests of the SEL relay.

- The SEL relay detected 67.6% of the HIF test cases (998 HIFs were detected out of 1476 HIF cases).



## Liberty Utilities – Fire Mitigation Protection System Study

- The average detection time of HIF detection methods is around 50 seconds. Therefore, even though the relay can reduce human safety risks, the high detection time makes it less effective for mitigating wildfire hazards.
- The SEL relay detection performance is independent from arc resistance uncertainty. The relay shows approximately the same detection rate for different values of uncertainty. Also, the relay HIF detection time is independent from uncertainty levels.
- The dependability rate and detection time of the HIF methods of the relay are independent of the fault positions along the feeder.
- The dependability rate for SEL 451 is better for high sensitivity setting of 1 as opposed to 0 for low sensitivity. However, increasing sensitivity may compromise the security rate of the method by detecting no-fault scenarios as fault scenarios. Since utilities cannot tolerate trips for no-fault scenarios, a residual overcurrent element, 67G, can be used to improve the security. The element 67G is asserted if 3I0 is higher than a specified pickup. Therefore, the high sensitivity can be used only if the 67G pickup is met.
- In general, the relay phase determination accuracy is almost 63% and 55% for arcing sensitivity level equals to 1 and 0, respectively.

In Section 5, fast tripping scheme and settings for several utilities are discussed as a practical technique to reduce the fault clearing time in distribution networks. Fast tripping lowers the released energy and in turn mitigates the fire risk in distribution networks. **Based on the extensive RTDS simulations and results shown in this report, we strongly recommend that a fast-tripping scheme be implemented in high fire risk areas to reduce the fault clearing time; thereby significantly mitigating the fire risk.**



## 2. Introduction

In this section, protection practices that the utilities are using for wildfire risks mitigation are explained. Also, HIF detection in uni-grounded systems and the associated challenges are discussed. In addition, a literature review of HIF detection methods available in academic papers are given.

### 2.1. Utilities approaches for wildfire risks mitigation

Utilities around the world are facing unprecedented levels of fire risk from routine electrical faults and failures in transmission, distribution system lines, and equipment. The risk is elevated by changing weather patterns that produce extreme drought conditions and violent storms. These utilities are confronting aging power apparatus and difficult-to-detect failure or arcing-fault scenarios. Major fires in recent years have increased public awareness of the risk.

California utilities are facing this risk, dealing with its causes, and engaging in major efforts over years to reduce fire risk. The program of risk reduction is largely based on innovative solutions—experimenting with and then implementing a variety of new technologies and strategies. There is not a single strategy for fire risk reduction. Utilities pursue a variety of apparatus upgrading programs, operational and event responses, and development of new protection and control equipment and methods.

There are several strategies for reducing fire risk, including grid-hardening replacements, weather monitoring, adaptive operating procedures, adaptive distribution fault detection and tripping designs, and faster and more sensitive new transmission line protection schemes. In addition, distribution system falling conductor protection based on phasor measurement units (PMUs) or synchro-phasor data streams gathered from across distribution circuits is another utility practice to reduce the wildfire risk. Detecting a conductor break and deenergizing the circuit while the conductor is still falling completely avoids an arcing ground fault that can ignite dry vegetation.

#### 2.1.1. Grid Hardening and Operating Adaptations to Reduce Risk

Utilities have developed a broad fire safety enhancement program combining fundamental common-sense upgrading efforts to reduce root causes of risk with developments of new technologies to detect impending or immediate risk events at specific locations on the grid. Companies have invested billions over more than a decade on their risk assessment and



## Liberty Utilities – Fire Mitigation Protection System Study

mitigation phase of wildfire risk control and mitigation plan. The highlights of these implementation plan are summarized below.

Planning begins with an assessment of the cross-functional business and operational activities that impact wildfire risk reduction. These include:

- Climate change adaptation, including bolstering system resilience and reducing greenhouse gas emissions.
- Asset management program including inspection and fleet assessment to identify and repair apparatus or facilities for fire risk reduction.
- Emergency preparedness and response, including proactive response to potential risk situations and post-event analysis of response effectiveness.
- Safety management systems, including communication systems and comprehensive training of company teams on safety issues and procedures.
- Workforce training, qualification, and planning for all risk mitigation and response activities.
- Records management for continuing internal and regulatory tracking.

### 2.1.2. Risk Bowtie

The first step in developing a comprehensive risk reduction program is to identify the drivers or triggers for wildfires. A high-level list appears on the left in Figure 1 for San Diego Gas and Electric (SDG&E) utility.

The common result from all these 10 driver categories is that any of them can ignite a wildfire. This is illustrated by the central red disk in the risk bowtie configuration in Figure 1.



Figure 1 SDG&E Risk Bow Tie



## Liberty Utilities – Fire Mitigation Protection System Study

Should a fire occur, the consequences shown on the right in Figure 1 are independent of the triggering event.

With many choices of where and how to invest in new facilities, systems, and procedures, SDG&E has developed an ongoing prioritization process. Considering the bowtie diagram of Figure 1, it is clear there are opportunities to reduce the risk of fire ignition from causes (left side) and also to reduce the impact of each consequence (right side). Accordingly, SDG&E process managers and team members determine “Likelihood of Risk Event” scores for each specific sub-cause in categories on the left, and “Consequence of Risk Event” scores for impacts on the right, leading to the calculation of the Total Wildfire Risk Score assessment. Tracking over time shows how specific programs may reduce risk and tracks actual improvement over time as programs are carried out.

The Total Wildfire Risk Score includes both the reduction of wildfire risks from mitigation of triggers and from the risk reduction inherent when SDG&E operations invoke a public safety power shutdown (PSPS) of selected facilities based on risk information processing systems we describe below.

### 2.1.3. Driver and Consequence Mitigation Programs

Based on the risk-benefit analysis described above, SDG&E has been carrying out major programs to reduce the likelihood of triggers (listed by categories below).

#### A) Situational Awareness and Forecasting Programs

- Operational wildfire risk modeling  
SDG&E has developed an advanced operational model for wildfire risk based on weather and fuel moisture data, mountaintop camera network integration, weather station data, wind deviations based on measurements across the service territory, and fire simulation analytics for all reported triggering events. This system gives operators the ability to invoke many of the risk-reduction strategies in areas where they are needed while minimizing customer service impact where the risk is lower.
- Advanced weather station integration  
SDG&E has one of the most advanced weather station networks in the industry monitoring temperature, winds, and fuel moisture. In 2020, the program added 30 new stations and upgraded 50 others in a fleet of over 200 stations, with more modernization taking place during 2021. New installations are validating new sensors that more accurately assess fuel moisture conditions to correlate impact on wildfire spread.
- Wireless circuit fault indicators



## Liberty Utilities – Fire Mitigation Protection System Study

Along with sensitive and expansive fault protection system responses described in the sections below, wireless fault indicators effectively indicate the circuit section where a fault has occurred to focus the search for the exact fault location. This greatly speeds response to faults and location of the site where there is a risk of ignition.

- **Creation of Fire Science and Climate Adaptation Department**  
This organization was established in 2018 to strategize SDG&E’s fire preparedness activities and programs. Among these are an ignition management program for root cause analysis and mitigation, a Fire Science and Innovation Lab that brings together experts and community stakeholders to create new solutions and build regional fire resiliency, and university and institutional partnerships.
- **High-Performance Computing Infrastructure**  
In partnership with the San Diego Supercomputer Center, SDG&E has developed and continues the advancement of big-data tools that process high-resolution weather data into forecasts that generate real-time guidance for operators. This data is also shared with the U.S. Forest Service and the National Weather Service where the former publishes the guidance on its public website.

### B) Grid Design and System-Hardening Programs

- **Distribution SCADA capacitor replacement**  
New supervisory control and data acquisition (SCADA) capacitors with lower failure risk are replacing older fixed capacitors. SCADA control introduces situational awareness of issues in the capacitor bank as well as balance issues on the circuit that can limit sensitivity to high resistance faults or lead to undesired tripping of customers.
- **Covered conductor (tree wire) deployment**  
SDG&E’s analysis of the risk reduction benefit of new insulated conductors in consideration of root causes of faults, along with favorable pilot installation experience, is leading to ongoing replacement of old bare conductors with contact-insulation conductors in the highest fire risk zones. Insulated conductors raise the threshold of winds and fire risk for which a PSPS must be carried out. Deployment of thousands of miles of covered conductors is a program being executed over years based on risk prioritization.
- **Expulsion fuse replacement**  
SDG&E is installing fuses with reduced discharge and fire risk, approved by the California Department of Forestry and Fire Protection (CAL FIRE). About half of the old expulsion fuses were replaced in 2020, with work continuing in 2021.
- **PSPS sectionalizing and switching enhancement**



## Liberty Utilities – Fire Mitigation Protection System Study

SDG&E uses public safety power shutoffs as a last resort when the probability of ignition is higher than normal and the risk of wildfire spread is extreme. Since PSPSs have such a negative impact on the community, a sectionalizing enhancement program has strategically installed new isolating switches—over 300 so far and growing—to limit PSPS impact to the smallest practical area.

- **Microgrid deployment**  
Microgrids can mitigate PSPS impact where other mitigations are difficult to implement. SDG&E is aggressively establishing microgrid areas, some initially configured with emergency generation connections for customer support during extreme fire risk conditions.
- **Advanced protection program**  
Advanced protection systems including falling conductor protection (FCP), sensitive ground fault (SGF) protection, sensitive relay profile (SRP) settings, accurate fault location, remote event data gathering and reporting, SCADA communications to field devices, and increased sensitivity and speed of transmission line protection are used to mitigate the fire risk in the network.
- **Hotline clamp replacement**  
Thousands of conductor hotline clamps are being replaced with compression connectors to reduce the risk of energized conductor separation and falling.
- **Resiliency grants, assistance programs, and standby power programs**  
These programs support the deployment of renewable and emergency generation for vulnerable customers facing the risk of PSPSs.
- **Strategic circuit undergrounding**  
Burying the circuit nearly eliminates wildfire risk, but it is the most expensive mitigation approach. Land and environmental constraints further limit application of this approach. SDG&E is undergrounding circuits where wildfire risk is extreme or where PSPS need can be significantly reduced by undergrounding a limited section of a larger circuit.
- **Overhead distribution and transmission circuit fire hardening**  
Coordinated and risk-prioritized long-term construction programs have been replacing wood poles with steel, installing new high-strength conductors, and increasing conductor spacing where needed.
- **Cellular long-term evolution (LTE) communications network**  
This application expands coverage of reliable system-wide communications, including support for new protection technologies for distribution circuits as elaborated below.
- **Surge arrester replacement**
- **SDG&E is deploying new CAL FIRE -approved arresters employing technology that adds arrester overload detection and isolation.**



## Liberty Utilities – Fire Mitigation Protection System Study

### *C) Asset management technologies and inspection programs; vegetation management*

- **Inspection programs**  
These programs include annual circuit patrol inspections, five-year detailed transmission and distribution system inspections, 10-year intrusive inspections of wood poles, prioritized or more frequent inspections in high fire risk areas, and responsibility for individual circuits by designated personnel who monitor and report issues.
- **Analysis of maintenance findings**  
This includes categorization and ranking of detailed maintenance issue findings, with root cause determination for planning or prioritizing mitigation programs.
- **Enhanced vegetation management**  
Includes vegetation inspections, tree trimming, tree risk ranking, analysis and management of fire fuel potential, and removal of fuel near poles in high-risk areas.
- **Laser imaging, detection, and ranging (LiDAR) inspections**  
Three-dimensional aerial surveys of complete electric transmission or distribution circuit rights-of-way to determine circuit clearances and to validate engineering designs.
- **Drone inspections**  
SDG&E is developing drone camera image automated processing technology since the number of images is beyond practical human analysis. So far, drone camera image analysis is demonstrating a higher rate of circuit issue detections than human inspection.

### *D) Grid operations and procedures*

SDG&E classifies operating conditions as normal, elevated risk, and extreme risk. The latter two result in system work being restricted or extra mitigation steps for work that cannot be delayed. Programs include:

- **Firefighting aviation**  
SDG&E helicopters and coordination with other agency resources to ensure availability and coverage.
- **Fire protection teams**  
With specialized utility infrastructure expertise.
- **PSPS management**  
Determination, initiation, and restoration management processes and criteria.
- **Enterprise asset management platform**  
It serves as a data repository for all historized and predictive fire, weather, and resource allocation data.
- **Emergency operations center**  
Event management coordinated with other agencies and government activities.





### 2.1.4. Typical distribution fault protection

Distribution circuits in the SDG&E system are radially fed from a single source at the substation. For fault protection, overcurrent relays are used both at the substation breaker and field reclosers downstream. These relays sense the fault current above a setpoint for either phase or ground current and are time-coordinated to minimize the impact by only tripping the recloser closest to the fault. In recent years, the company has installed hundreds of new reclosers in high-risk circuits to section them into smaller segments and reduce patrol times when one reports an operation. The major drawback of time-overcurrent coordination with added reclosers is the additional delay time intervals added to upstream protection devices to coordinate with multiple devices in series. This increases the time that some faults persist before the recloser or protective relay trips.

To improve sensitivity and reduce fault duration in comparison to traditional time-overcurrent protection, SDG&E employs two unique protection setting profiles on its overhead reclosers. These setting profiles or configurations, invoked via SCADA commands to circuit reclosers, significantly limit fault energy and trip duration time during high-risk periods when wildfire ignition and spread are most likely to occur.

### 2.1.5. Sensitive Relay Profile settings

SDG&E first developed its SRP strategy in 2010. A special group or profile of relay or recloser protection sensitivity and tripping time settings can be engaged by distribution operations at times of high fire risk. The setpoints are selected as sensitively as possible without tripping for normal load conditions and will clear a fault in less than 4 power cycles or 70 ms. With conventional time-overcurrent protection settings, it may take seconds to clear a fault. When elevated or extreme fire weather conditions are forecasted, SDG&E distribution operations enable SRP across the system.

To achieve optimum speed and sensitivity, historical five-year loading profiles on individual devices and circuits are gathered via SCADA data communications from each recloser. SDG&E has developed an automated data processing tool that analyzes the loading history of every device in high fire risk districts to flag SRP setpoints that need reverification. As a result, decision logic used by operators for SRP engagement is updated.

When elevated or extreme fire risk weather conditions are forecasted by SDG&E's meteorologists, operators remotely switch a pre-defined list of reclosers to SRP the prior night. These SRP settings do not coordinate with other protective devices such as fuses or other reclosers further down the circuit—fault will trigger uncoordinated tripping of multiple devices and will de-energize larger sections of the feeder, impacting more loads and requiring more extensive patrols to locate the problem and ensure that the circuit is clear for re-energization.



## Liberty Utilities – Fire Mitigation Protection System Study

SDG&E performed a benefit analysis from a sample set of SRP trips to determine the reduction of wildfire ignition risk. In total, from 40 trips that occurred when SRP was enabled, there have been no fire ignitions to date. In comparison, when reclosers had normal protection settings in effect, 2% of the trips caused fire ignitions found by field patrols. This shows how the benefits of using the SRP during high wildfire risk conditions and its larger extent of outages outweigh the loss of protection coordination.

### 2.1.6. Sensitive Ground Fault protection

Another layer of risk reduction is SGF protection. In many cases, distribution ground faults that could cause a fire, such as energized conductors on the ground (wires down), have a high ground path impedance and yield very little fault current. They cannot be detected by relays or reclosers using standard ground overcurrent protection settings. The standard settings are typically high enough to avoid tripping for normal phase load imbalances, which look to the relays and reclosers like low-current ground faults of the same magnitude as the imbalance. SGF replaces standard ground current magnitude trip settings with values that are customized for each device, set just above the normal unbalance seen by that device.

Just as with SRP, setting SGF protection requires constant review and adjustment of individual protection settings in comparison to field load data history to avoid trips for load imbalance. SDG&E uses specially developed analytic tools to study the actual range of load-induced circuit current imbalance for each relay or recloser reporting load profiles, using system-wide continuous operating measurements collected by the control-center-based supervisory control and data acquisition (SCADA) system - the same loading data and tool systems used to determine annual baselines for SRP settings before each fire season. With this device-customized load imbalance profile, each device can be set just above its worst normal imbalance level with minimized risk of false tripping for normal loading. On well-balanced circuits, the setting can be far lower and more sensitive than standardized settings.

SDG&E applies SGF settings year-round as opposed to engaging them as part of an operating profile. This lowers the risk of wildfires and reduces public safety risks from energized downed conductors. As with conventional time-overcurrent protection, SGF is time-coordinated by setting a half-second delay interval between tripping times of reclosers along a circuit. This time delay minimizes the reliability impact by isolating a smaller section of the circuit when a fault occurs, and thus enables the full-time use of SGF.

### 2.1.7. Falling conductor detection and tripping

The purpose of FCP is to detect an energized conductor that has broken and to de-energize it before it strikes the ground, thereby eliminating the risk of fire ignition or public exposure to live



## Liberty Utilities – Fire Mitigation Protection System Study

conductors. SDG&E and other utilities experience such conductor breaks even with vigorous circuit-hardening programs. An SDG&E project team invented and patented the concept and scheme of FCP while developing new synchro-phasor-based distribution circuit monitoring and protection system technology.

Figure 2 shows the time sequence for a broken overhead distribution conductor falling from a height of 30 feet (9 m). Accelerating from the moment of the break, one or both ends reach the ground 1.37 s later. The FCP scheme can detect the break from circuit voltage signatures and issue trip commands so that the broken circuit section is de-energized 200 to 500 ms after the break—when the conductors have fallen only a few feet.

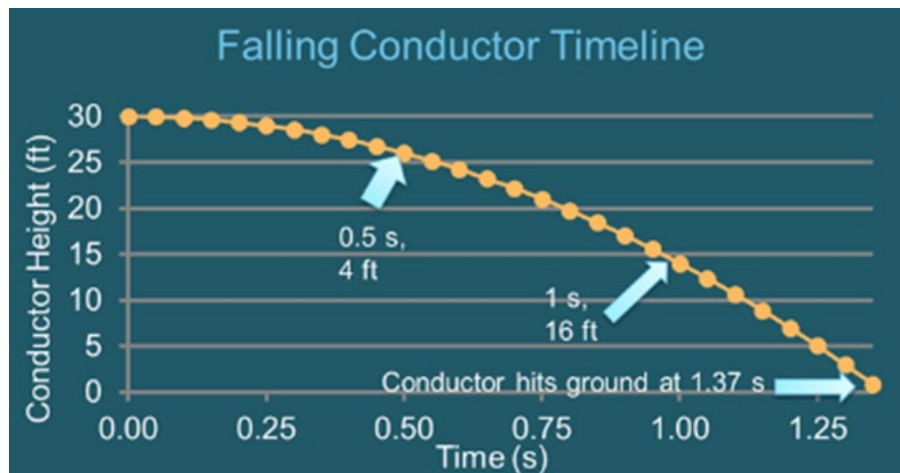

Figure 2 Falling Conductor Operational Timing

## 2.2. HIF detection in uni-grounded systems

### 2.2.1. Three-phase Uni-grounded System

A three-wire three-phase distribution network which is solely grounded at substation through the transformer neutral point is called a three-phase uni-grounded system. This system is usually more economical than an equivalent four-wire three-phase system because it uses less conductor material to transmit a given amount of electrical power. In the uni-grounded distribution networks, only the line-to-line voltage is available and the loads can be only connected phase-to-phase. However, in the four-wire system, the line-to-ground voltage can be provided for the loads using the neutral wire.

The use of uni-grounded configuration in high-resistance grounded industrial power systems have a great advantage. They can operate indefinitely with a ground fault on one phase, eliminating the need for an immediate shutdown. Once the fault is located, the particular circuit can be isolated and the fault cleared at a convenient time, resulting in a controlled, minimized outage. This advantage has tremendous value in many industries, where the instantaneous tripping of



## Liberty Utilities – Fire Mitigation Protection System Study

faulted circuits to critical processes would result in losses of production, materials, and equipment[1][2][3].

A major problem in operating these systems is detecting and locating a ground fault when it occurs. The search may be difficult and time consuming. For one particular manufacturing site studied, approximately half of the faults were quickly located; the other faults required on average four man-hours, and a few faults took 16 or more hours. Small-magnitude fault currents flow in the faulted network due to the leakage (or grounding) capacitance and through the high impedance ground. Typical fault currents are less than 10 A which may not be detected by conventional protective devices and consequently cause serious human safety issues and significant fire hazards.

### 2.2.2. High-impedance Fault Detection

In power distribution systems with voltages ranging from 4 kV to 34.5 kV, high-impedance faults (HIFs) have challenged utilities and researchers for years. HIFs are those faults on distribution feeders with fault currents below traditional overcurrent relay pickups. Fallen power conductors on poorly conductive surfaces, tree branches brushing against power lines, and dirty insulators are all potential causes of HIFs.

HIFs have such small fault currents that they generally do not affect power distribution system operation. However, HIFs caused by downed power conductors are major public safety concerns and a reason for wildfires in the system. Without timely correction, these faults can be hazardous to human lives and property. There have been several documented cases of costly litigation as a result of damages from undetected downed power conductors.

Figure 3 illustrates an arcing high-impedance fault that Texas A&M Power System Automation Laboratory (PSAL) researchers staged at their Down Conductor Test Facility. This fault consisted of a section of 2/0 ACSR in contact with undisturbed grassy ground. They staged this fault on an operating 12.47/7.2-kV multiground wye system with approximately 2000 A of single-line-to-ground fault current available at the point of the fault. This type of fault typically produces spectacular visible and audible arcing, but without drawing enough current to operate conventional protection. For instance, a 30T fuse protected the fault in Fig. 3. After staging several hundred such faults under a variety of conditions, PSAL researchers have observed that the fuse operates less than half the time.



Figure 3 A downed conductor arcs to ground at Texas A&M University's Downed Conductor Test Facility



HIFs on multi-grounded distribution systems are difficult to detect at the substation level. Single-phase loads and the multipath returns of unbalanced currents are several factors contributing to the difficulty in detecting these faults [4]. A grounded system can be quite unbalanced when a major single-phase lateral is out of service. Beyond ensuring coordination with downstream devices and fuses and avoiding pickup on cold loads and transformer inrushes, one must avoid false tripping by setting conventional ground overcurrent protection above the maximum foreseeable unbalance. Thus, overcurrent protections that use the fundamental component or root-mean square (rms) of currents are ineffective in detecting HIFs.

Some HIFs, such as those resulting from downed power conductors on asphalt or dry sand, generate virtually no-fault current. No substation-based devices can detect these HIFs or down-conductor situations. An early IEEE Power Engineering Society (PES) publication [5] documented specifics on why fallen power lines cannot always be detected. HIFs are random and dynamic. A downed power conductor can lie idle on a surface for some time and then conduct once insulation breaks down. An arcing conductor may not lie still on a ground surface, but may move around as a result of electromagnetic force. Fault current magnitudes and contents change as ground surface moisture escapes from fault generated heat, and/or as ground silicon materials burn into glasses. Soils during different seasons of a year and from different geological regions also produce different fault current contents.

Despite these challenges, researchers remain optimistic that they will find a cost-effective substation-based detection algorithm for HIFs. Perplexed by undetected breakdowns of crosslinked polyethylene (XLP)-covered conductors in the early 1970s, Pennsylvania Power and Light Company (PP&L) initiated several staged HIF tests by dropping XLP conductors on different ground surfaces [6]. EPRI and CEA directed research in the late 1970s and early 1980s that resulted in several research reports [7][8][9][10]. Since then, researchers have studied and applied many existing and emerging techniques to HIF detection. These include statistical hypothesis tests [11], inductive reasoning and expert systems [12], neural networks [13][14], third harmonic angle of fault currents [15], wavelet decomposition [16][17], decision trees [18], fuzzy logic [19], and others. The IEEE PES and Power System Relaying Committee (PSRC) have followed the developments closely and have offered a tutorial course [20] and published committee reports [21][22][23].

As indicated by a lengthy history of on-going research and the number of technologies researchers have studied and applied, one can obtain a sense of the difficulty and complexity involved in designing an HIF detection algorithm that is both dependable and 100 percent secure against false alarms.

While it is relatively easy to design an algorithm that detects certain HIFs, it is challenging to make the same algorithm secure. The objective of HIF protection is to mitigate the wildfire risks and remove hazards to the public. When an HIF detection device indicates a fault, utilities must make tripping decisions based on several circumstances to ensure a trip will not cause more hazardous situations. Utilities cannot tolerate false alarms from HIF detection devices. It can be more dangerous and costly, for example, to trip out a busy traffic intersection, hospital, or an airport load.



## Liberty Utilities – Fire Mitigation Protection System Study

### 2.2.3. Protection Challenges in Tahoe Area with High-impedance Ground

Liberty Utilities provides electricity to a part of the Lake Tahoe customers via 14.4 kV three-phase uni-grounded systems. The system loads are connected phase-to-phase and typically fed by YYD three-winding transformers as shown in Fig. 4. The mountain area is mostly covered by rocks with a low-conductivity. The sensitive earth fault (SEF) scheme is the only protection element to detect and clear the high-impedance faults in this area. This scheme is basically a definite-time overcurrent element with a low (~40A) pickup current. When the 3I<sub>0</sub> in Fig. 5 (b) exceeds the pickup current for 3-4 seconds time delay, the relay issues a trip to the breakers. Since there are several uncertainties in the amount of the load imbalance, the pickup currents are just set very low to be sensitive. In the normal configuration when the distribution feeders are radially supplied from the substation transformers, there is not any closed zero-sequence circuit as shown in Fig. 5 (a). In this case, equation (1) must be satisfied. Even if the magnitude of the three phase currents can be different due to the load imbalance, the phase current angles start shifting to satisfy (1). This phenomenon is called “neutral shift” in the uni-grounded systems. In this system, the load imbalance does not affect the line-to-line voltage but the line-to-ground voltage.

$$I_a + I_b + I_c = 3I_0 = 0 \quad (1)$$

When a ground fault occurs along the feeder, the zero-sequence circuit is closed and depending on the fault impedance, a magnitude of the zero-sequence current flows in the network as shown in Fig. 5(b). The current magnitude can be close to zero depending on the pre-fault voltage and fault impedance and the SEF may not detect the fault. Therefore, it is necessary to have an HIF scheme to address these blind zones of SEF.

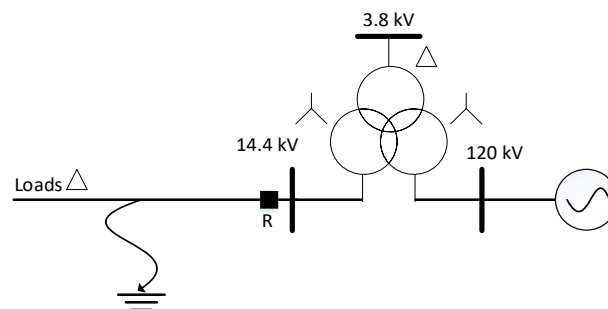

Figure 4 Typical configuration of the distribution networks in Tahoe area



## Liberty Utilities – Fire Mitigation Protection System Study

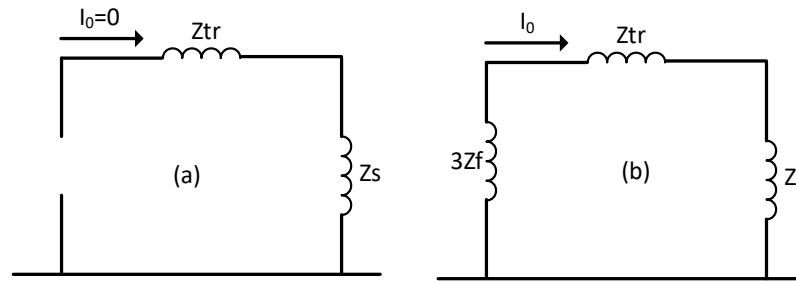

Figure 5 Zero-sequence network for Fig. 1 (a) under normal configuration, (b) under a ground fault condition

### 2.2.4. Protection Challenges during Load Switching

During the load switching in Tahoe area, two substations are paralleled, and the uni-grounded system is converted to multi-grounded system as shown in Fig. 6. The SEF element must be defeated during the load switching due to two reasons.

First, if a manual single-phase switch is used to parallel the substations, the lineman cannot close all three phases at the same time and depending on the load level, the ground current due to the unbalanced load can be more than the SEF pickup current for a couple of seconds and cause the SEF to trip the feeder.

Second, the ground current due to the unbalanced loads is not anymore zero due to multi-grounded system and equation (2) is satisfied.

$$I_a + I_b + I_c = 3I_0 \neq 0 \quad (2)$$

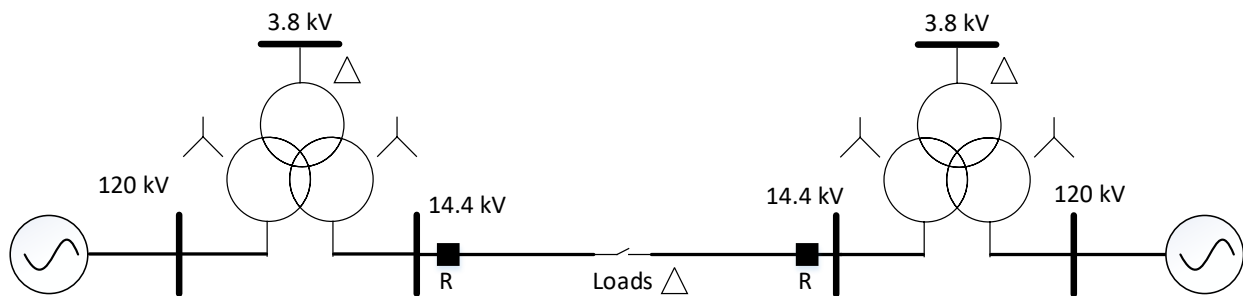

Figure 6 Typical configuration of the distribution networks in Tahoe area during the switching

If an HIF occurs during the load switching, there is not any protection element to detect and clear the fault and the linemen working on the line are exposed to higher safety issues.



### 2.3. Literature review of HIF detection methods available in academic paper

The deadliest wildfires in the world were started by power system malfunctions [24]. In California, recent severe wildfires such as the Camp Fire, and the Wine Country Fire were due to electrical equipment issues. The malfunctions of electrical network owned by the power company initiated the Camp fire, and the electrical equipment of a private owner caused the Wine Country fire [25][26]. The electric utility was determined to be responsible for at least 17 of 21 fatal wildfires of Northern California in 2017 [27] and faces at least \$30 billion in liability claims that forced it to declare bankruptcy. Investigators also believe that nearby trees which came in contact with a power line initiated the Camp Fire [28].

Statistics show that wildfires caused by power lines are highly destructive and larger than the fires caused by other means. In California, 4 of 20 largest wildfires by acreage and 5 of 20 wildfires by structure damages were due to power lines. Also, cost of these fires was estimated to be around 99% of the total cost for all fires [29]. In 2015, about 10% of all wildfires in California was initiated by electrical systems, which burned more than half of the total burned area by all fires [29]. In Australia, power lines are the cause of at least 90% of deadly wildfires. Even if a fire is not caused by power systems, it significantly extends and makes huge structural damages when it reaches a power grid.

By detecting and removing faults in power grids, the impacts of about 30% of total wildfires can be minimized or eliminated [30]. To reduce the wildfires caused by electric grids, the fault should be detected in a timely manner. If the power system protection devices cannot detect the faults with capability of igniting fires, the fire risks are not decreased. In addition, the response of protective devices must be as fast as possible to prevent the fire ignition. High current faults can initiate wildfires, as well, but they can be detected by traditional relaying schemes. However, in distribution grids ranging from 4 to 34.5 kV, high impedance faults (HIFs) are challenging to detect due to very low current amplitudes which are comparable to load currents. Also, since most of HIFs include arcing phenomenon, they can initiate large wildfires in distribution systems.

HIFs have harmonic and non-harmonic components that shape a different current waveform than other fault types. HIF occurs when a conductor touches the ground surface or tree branches slam power lines. Different ground surfaces affect HIF behavior and magnitude. For example, for asphalt or dry sand there is almost no-fault current. On the other hand, for some surfaces, there are higher current magnitudes. In most cases, the current is below the pickup of conventional protective relays. Most HIFs include arcing that produces dynamic and random characteristics in the waveform. A downed conductor may lie still on the ground first and then start to conduct when its insulation breaks down. There might be some changes in HIF contents and magnitudes as the surface moisture evaporates due to generated heat in fault process. Also, the ground surface material during different seasons can result in different fault current waveforms.

Several studies have been made to detect HIFs in the literature that will be mentioned here.

Authors in [31] propose a decision tree-based HIF detection method which measures the current with 1.92 kHz sampling rate and uses the magnitude of the 2nd, 3rd and 5th harmonics and the phase of the 3rd harmonic for feature selection. In [32], a nearest neighbor rule which is a data-mining based algorithm is introduced for HIF detection. The method obtains the converted RMS





current and voltage caused by arcs using Discrete Wavelet Transform (DWT) and feeds these values to the data-mining tool. A mathematical morphology-based method is proposed in [33] for identifying HIFs. This method uses nonlinear morphological characteristics to extract appropriate features for arcing fault detection in distribution networks. The HIF detection method in [34] is based on voltage–current characteristic profiles (VCCPs). The change in VCCPs is shown to be a great indicator of HIFs. Authors in [35][36] use a deep belief network (DBN) for detecting HIF in microgrids. Several statistical metrics based on S-transform and Time-Time-transform are used to train DBN. Reference [37] applies variational mode decomposition (VMD) and Teager-Kaiser energy operators (TKEOs) to detect HIFs. The VMD is used to obtain the intrinsic mode functions (IMFs) of zero-sequence currents. Using IMFs and TKEOs, time entropy values are obtained to distinguish HIFs from capacitor and load switching. Authors in [38] use multi-layer perceptron neural networks (MLPNN) for HIF identification. For training MLPNN, multi-resolution morphological gradient is employed to extract the time-based features from the post-fault current signals. In [39][40], signal processing tools such as S- and Time-Time-transforms are used for HIF detection in distribution systems and microgrids, respectively. Another method using adaptive neural fuzzy inference system (ANFIS) and wavelet multi-resolution signal decomposition is proposed in [41] for HIF identification. In [42], power line communication (PLC) is utilized for HIF detection and location in distribution systems. The PLC is installed at the starting point of the respective line. Bayes classifier and DWT are used for detecting HIFs in [43]. A low-order harmonic-based method is proposed in [44] for HIF detection where short-time Fourier transform (STFT) is utilized to obtain the magnitude of fundamental, 2nd, 5th harmonics and the phase of the 3rd harmonic. Authors in [45] use one-cycle sum of superimposed components of residual voltage for identifying HIF. Two novel artificial neural network-based methods for detecting arcing HIFs in multi-grounded distribution systems are proposed in [46]. In [47], smart meters are used to measure even harmonics available in voltage signals for detecting HIFs in distribution networks.

Despite all the researches that have been conducted so far, only a few commercial products are available for HIF detection. One product is based on the research carried out at a university [48] where an expert system is used to analyze harmonic and non-harmonic components of the currents for detecting and classifying HIFs. Two other companies [49][50] have produced similar products. Another company [51] has also commercialized new series of protective relays and reclosers which include HIF detection modules which are the main focus of this study. In this report, a uni-grounded distribution feeder in Northern California area is modelled in RSCAD/RTDS. In this area, the sensitive earth fault (SEF) scheme which is the only protection element to detect and clear ground faults cannot handle HIFs with low currents.



### 3. Feeder and HIF modeling

This section describes the May3400 feeder and HIF modeling in RSCAD software.

#### 3.1. Feeder modeling

A real uni-grounded system for Liberty Utilities in Northern California, May3400, is considered for this HIF study. The network is modeled using RSCAD software in a real-time digital simulator (RTDS) platform. Fig 7. shows a single line diagram of May3400 feeder. The substation relay is shown by  $R_s$  and  $R_1$ ,  $R_2$  and  $R_3$  are reclosers along the feeder.

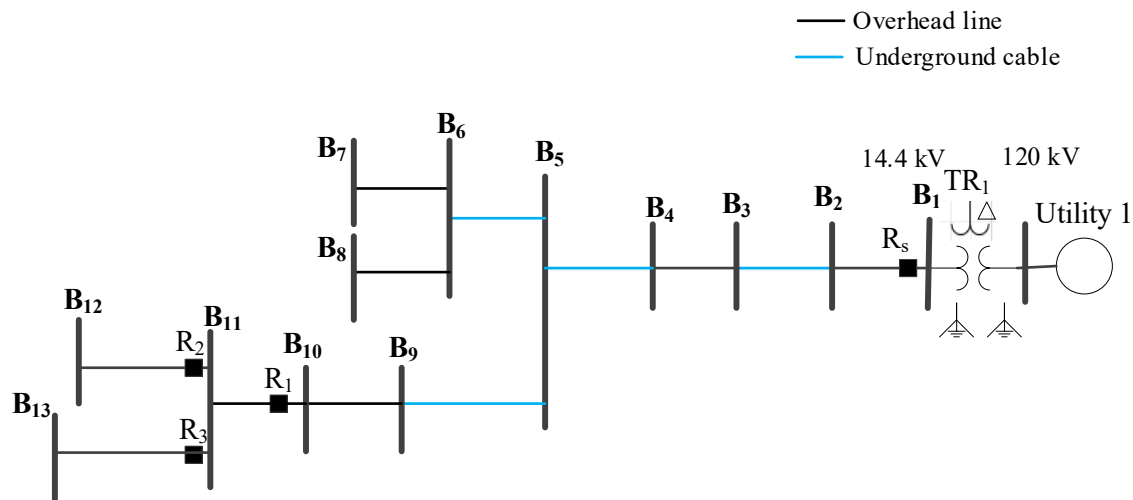

Figure 7 Single line diagram of the Liberty Utility feeder (MAY3400)

#### 3.2. HIF modeling for different surfaces

Accurate modeling of arc with a variety of nonlinear distortions under different fault conditions is an important factor for HIFs research. In this report, an experiment-based HIF model is utilized to represent actual arc waveforms measured under staged faults [52]. This HIF model simulates the nonlinear distortions of currents with improved controllability and higher accuracy. As shown in Fig. 8, the HIF model is typically established by the series connection of a controllable resistor  $R_{arc}$  to describe the arc nonlinearity and a large constant resistor  $RT$  to represent the poor conductivity of the grounding materials. The parameters including duration (DUR), extent (EXT) and offset (OFS) are used to implement the variation in the distortions of the HIF currents. Based on [52], variation of DUR, EXT and OFS of distortions are the three



major characteristics in the HIF current waveforms. Some labels are added in Fig. 9 to more clearly illustrate these three characteristics.

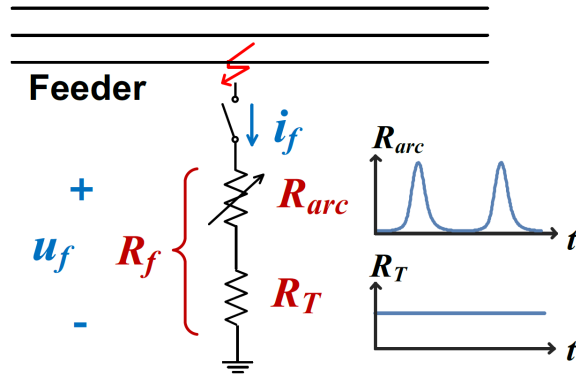

Figure 8 Structure of the HIF model

- 1) Duration (DUR) can be described as the length of zero-off interval (ZOI), which is a part of the whole distorted interval (DI).
- 2) Extent (EXT) can be described as the slope of the connecting line between the start and the end points of ZOI.
- 3) Offset (OFS) can be described as the gap between the mid-point of DI and the zero-crossing point.

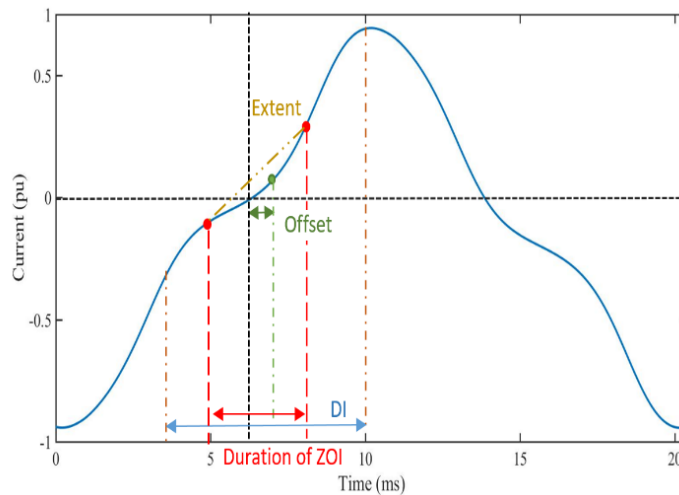

Figure 9 A sample HIF current waveform.

Table 1 presents detailed parameters of the proposed HIF model for different types of ground surfaces. Using the model presented in [52], the HIFs current for the surface types including dry cement, dry asphalt concrete, wet cement, dry soil, wet soil, dry reinforced concrete and wet reinforced concrete and their corresponding values are simulated and illustrated in Fig. 10.



## Liberty Utilities – Fire Mitigation Protection System Study

Table 1. Reference parameters of the HIF model

Field HIF Number	Ground surface type	Neutral	RMS value of the Neutral current (A)	OFS * (kV)	EXT * (kΩ)	DUR * (msec)	RT * (kΩ)
1	Dry Cement	Low-resistor-earthed	0.3	-5.335	134.7	10.39	25.17
2	Dry asphalt concrete	Low-resistor-earthed	2	-2.211	13.61	10.03	3.887
3	Wet cement	Low-resistor-earthed	8	2.387	1.547	10.32	0.9886
4	Dry soil	Low-resistor-earthed	11	5.129	3.578	7.811	0.4079
5	Wet soil	Low-resistor-earthed	14	1.088	2.172	9.973	0.4821
6	Dry reinforced concrete	Low-resistor-earthed	28	2.767	0.9323	10.13	0.2367
7	Wet reinforced concrete	Low-resistor-earthed	34	-2.863	1.939	11.32	0.2213

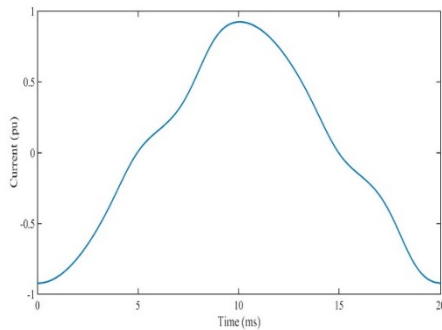

a) Dry cement

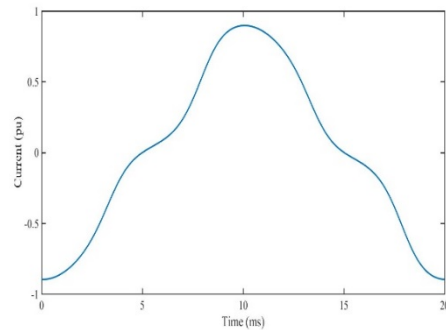

b) Dry asphalt concrete



## Liberty Utilities – Fire Mitigation Protection System Study

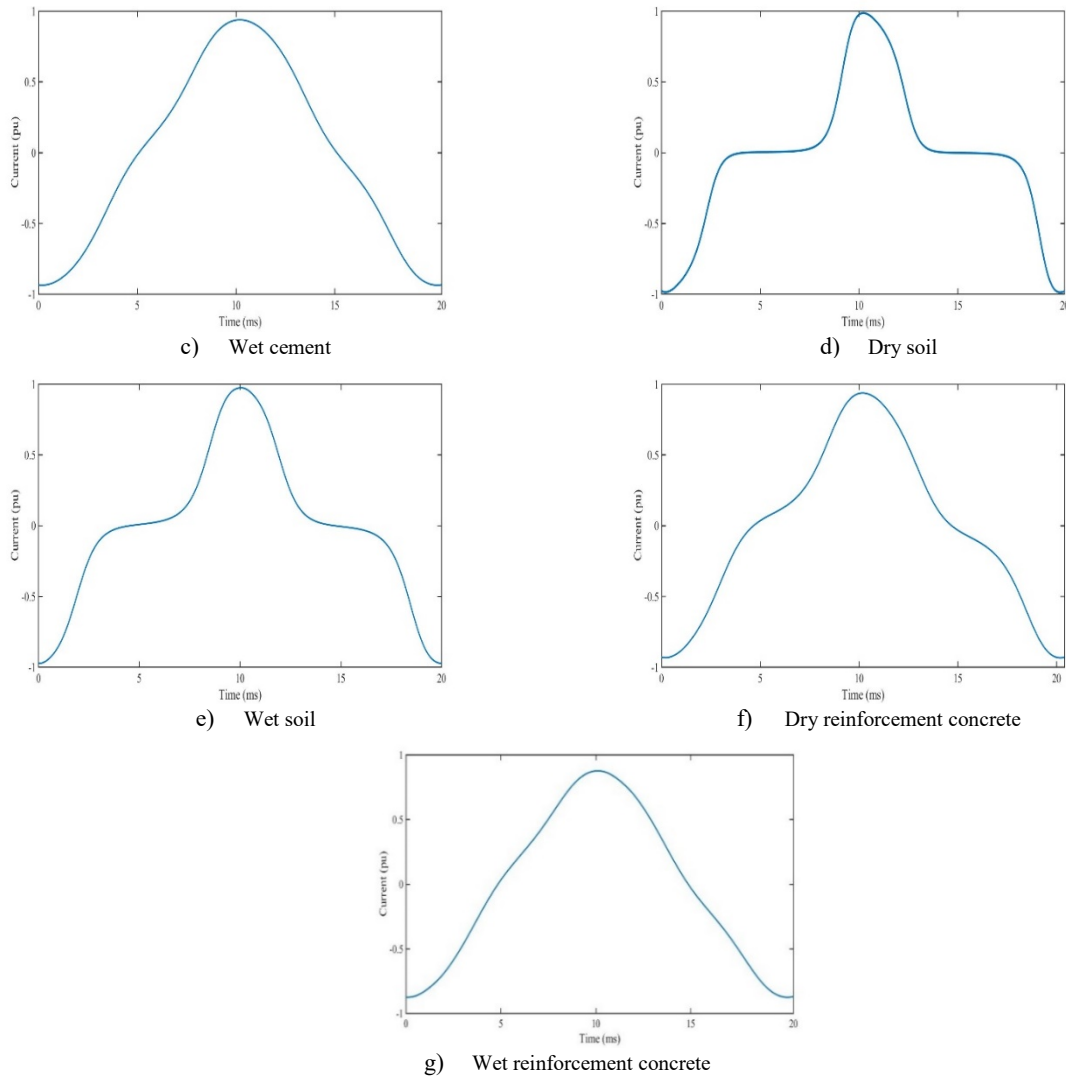

Figure 10 Current waveform of the HIFs presented in Table 1.

The actual waveform of HIFs includes time-varying distortions and amplitudes. Therefore, to apply the variation of current amplitudes, the grounding resistance  $R_T$  is added as a variable which is randomly updated every half cycle. The applied random values are some percentages of total arc model resistance and represent the uncertainty in the HIFs model. The uncertainty values are set to 10%, 5% and 2.5% for all different HIF surfaces. The wet cement surface with 10% uncertainty level is simulated to illustrate the randomness in the HIF arc current. As shown in Fig. 11, variation of  $R_T$  in the range of 75% to 95% causes random variation of the HIF current in the range of 10% every half cycle. This method is applied to all other surface types to implement the randomness into the HIF current.

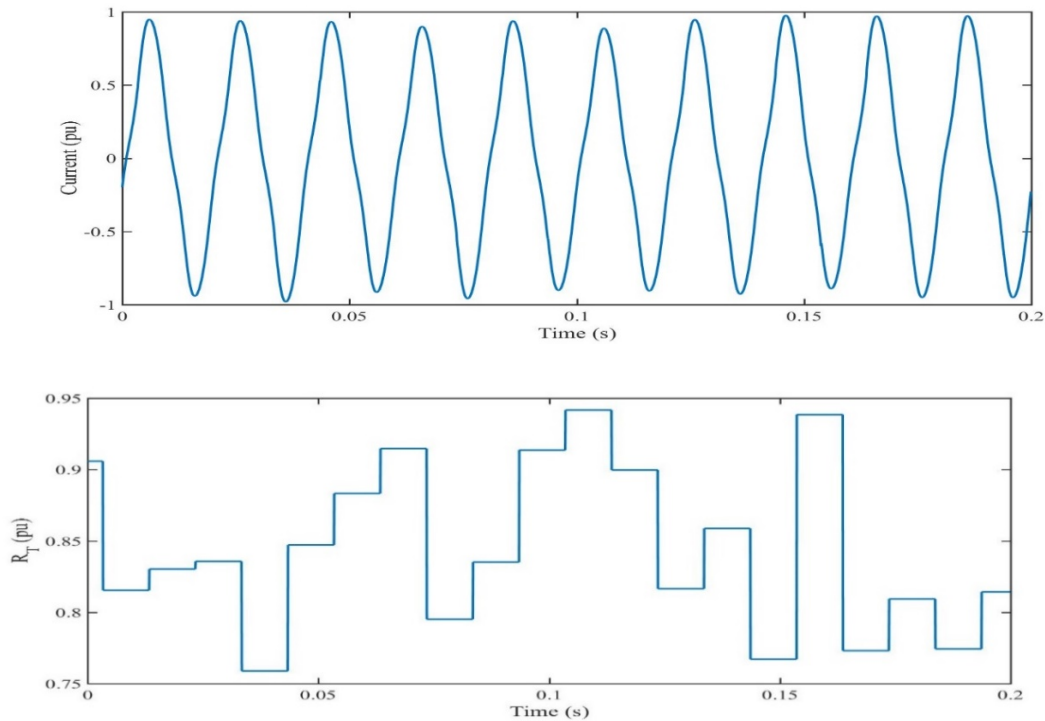

Figure 11 Current waveform of the HIF with 10% uncertainty in  $R_T$

#### 4. SEL 451 relay performance

In this section, SEL 451-6 relay is evaluated for about 1500 HIF test cases.

##### 4.1. Effects of HIF resistance uncertainty

The SEL relay performance for detection of HIF with different ground surface materials and different uncertainty levels are investigated for sensitivity levels of 1 and 0. To perform this analysis, 7 different HIF ground surfaces are simulated for 7 different lines in phase A with 3 different uncertainty levels and 2 arcing sensitivity values. Subsequently, a total number of 294 tests are performed. Each test is simulated for 80 seconds including 10 seconds for normal condition and 70 seconds for HIF condition. Table 1 presents the detailed descriptions for this study.

Table 1. Detailed descriptions of HIF resistance uncertainty scenarios for SEL relay performance

Parameter	No.	Description
Surface types	7	Dry Cement, Dry asphalt concrete, Wet cement, Dry soil, Wet soil, Dry reinforced concrete, Wet reinforced concrete



## Liberty Utilities – Fire Mitigation Protection System Study

Lines	7	Lines: L <sub>1-2</sub> , L <sub>3-4</sub> , L <sub>6-8</sub> , L <sub>9-10</sub> , L <sub>10-11</sub> , L <sub>11-12</sub> , L <sub>11-13</sub>
Uncertainties	3	Uncertainties in nonlinear HIF resistances: A) 0.75 - 0.95 10% B) 0.85 – 0.95 5% C) 0.9 – 0.95 2.5%
Sensitivity	2	HIF detection sensitivity levels: 1, 0
Total	294	

Here, we investigate the effects of uncertainty levels of the HIF resistance on the SEL relay performance. Table 2 and

Table 3 present the results obtained for 7 different surface types and 7 different lines under 3 different uncertainty levels when the SEL detection sensitivity level is set to 0 and 1, respectively.

Table 2. The effects of HIF uncertainties for nonlinear resistances under different surface types with arcing sensitivity = 0

Surface Type	Uncertainties (%)	Total cases	Number of Arc detected	Ave. arc detection time (sec) [min-max]	Dependability (%)
Dry Cement	10%	7	5	46 [43-49]	71.4
	5%	7	1	69 [69-69]	14.3
	2.5%	7	1	54 [54-54]	14.3
Dry asphalt concrete	10%	7	5	64 [54-76]	71.4
	5%	7	4	50 [43-53]	57.1
	2.5%	7	3	46 [42-53]	42.9
Wet cement	10%	7	6	47 [42-54]	85.7
	5%	7	1	77 [77-77]	14.3
	2.5%	7	7	42 [26-48]	100
Dry soil	10%	7	0	-	0
	5%	7	7	54 [46-56]	100
	2.5%	7	7	38 [24-71]	100
Wet soil	10%	7	0	-	0
	5%	7	7	49 [47-54]	100
	2.5%	7	7	50[41-68]	100
Dry reinforced concrete	10%	7	0	-	0
	5%	7	7	50 [49-54]	100
	2.5%	7	7	45[38-59]	100
Wet reinforced concrete	10%	7	0	-	0
	5%	7	7	46 [36-50]	100
	2.5%	7	7	46 [36-48]	100
Total	10%	49	16	52[43-76]	32.6
	5%	49	34	56[36-77]	69.4
	2.5%	49	39	46 [24-71]	79.6



## Liberty Utilities – Fire Mitigation Protection System Study

Table 3. The effects of HIF uncertainties for nonlinear resistances under different surface types with arcing sensitivity = 1

Surface Type	Uncertainties (%)	Total cases	Number of Arc detected	Ave. arc detection time (sec) [min-max]	Dependability (%)
Dry Cement	10%	7	5	45 [44-46]	71.4
	5%	7	6	50 [36-61]	85.7
	2.5%	7	7	44 [33-56]	100
Dry asphalt concrete	10%	7	6	44 [38-54]	85.7
	5%	7	6	48 [39-59]	85.7
	2.5%	7	7	38 [30-42]	100
Wet cement	10%	7	6	43 [36-61]	85.7
	5%	7	5	46 [45-49]	71.4
	2.5%	7	7	44 [31-56]	100
Dry soil	10%	7	3	46 [40-50]	42.8
	5%	7	4	52[46-56]	57.1
	2.5%	7	7	29 [20-58]	100
Wet soil	10%	7	7	46 [37-53]	100
	5%	7	7	44[28-56]	100
	2.5%	7	7	46[40-54]	100
Dry reinforced concrete	10%	7	6	49 [43-55]	85.7
	5%	7	6	41 [30-49]	85.7
	2.5%	7	7	44[28-56]	100
Wet reinforced concrete	10%	7	7	39 [35-49]	100
	5%	7	6	45 [34-52]	85.7
	2.5%	7	6	43 [36-66]	85.7
Total	10%	49	42	45 [35-61]	85.7
	5%	49	40	47 [28-61]	81.6
	2.5%	49	48	41 [20-66]	97.9

For a better assessment, the results presented in Table 2 and

Table 3 are shown in Figure 12-Figure 13. These figures show the relay performance under different surface types and Figure 14 shows the relay detection rate for different level of HIF uncertainties. It is shown that the relay fault detection rate is independent of uncertainty levels in the HIF model.





# Liberty Utilities – Fire Mitigation Protection System Study

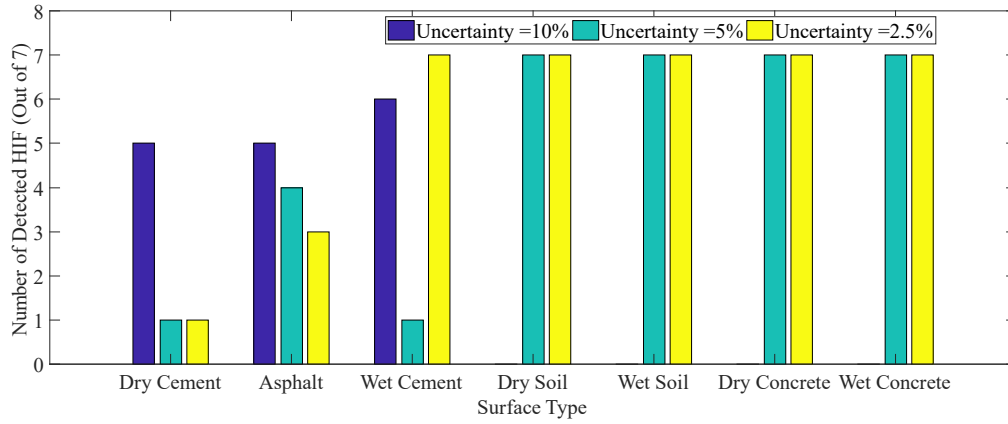

Figure 12. Ground surface type analysis (Sensitivity =0)

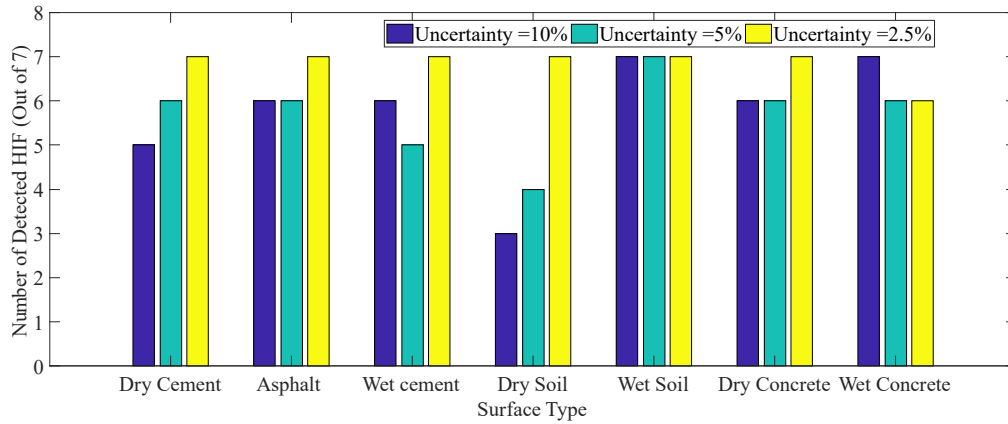

Figure 13. Ground surface type analysis (Sensitivity =1)

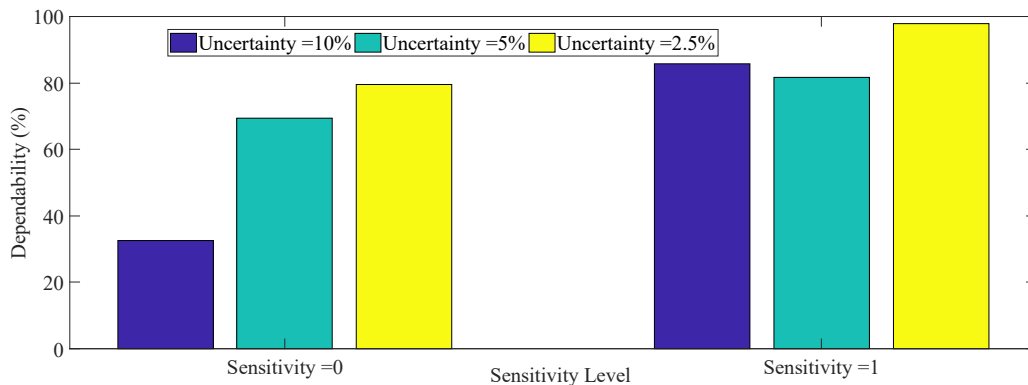

Figure 14. Uncertainty effect on the relay performance



## Liberty Utilities – Fire Mitigation Protection System Study

Final assessment on the uncertainty effect for the SEL relay are presented below:

- 1- The SEL relay detection performance is independent from arc current uncertainty. The relay shows approximately the same detection rate for different values of uncertainty.
- 2- The SEL relay HIF detection time is independent from uncertainty level. On the average, it detects HIF cases in approximately 50 seconds. (min= 20 sec, max=77 sec).

### 4.2. Effects of HIF position along the lines

This section presents the effect of the fault position along the lines on the SEL relay performance. For this purpose, 7 different HIF surface types in 3 different positions (10%, 50% and 90%) of the 7 different lines are simulated. A total of 882 tests are simulated where each test is run for 10 seconds under normal condition and 70 seconds under HIF condition. Table 4 presents the detailed descriptions for this study.

Table 4. Detailed descriptions of scenarios for analysis of HIF position along the lines for SEL relay

Parameter	No.	Description
Surface types	7	Dry Cement, Dry asphalt concrete, Wet cement, Dry soil, Wet soil, Dry reinforced concrete, Wet reinforced concrete
Lines	7	Lines: L <sub>1-2</sub> , L <sub>3-4</sub> , L <sub>6-8</sub> , L <sub>9-10</sub> , L <sub>10-11</sub> , L <sub>11-12</sub> , L <sub>11-13</sub>
Position along the lines	3	X% position along each line: 10%, 50%, 90%
Uncertainties	3	Uncertainties in nonlinear HIF resistances: A) 0.75 - 0.95 10% B) 0.85 – 0.95 5% C) 0.9 – 0.95 2.5%
Sensitivity	2	HIF arcing sensitivity levels: 1, 0
Total	882	

#### 4.2.1. Effects of HIF position for sensitivity level = 1

This scenario analyzes the effects of HIF position on the SEL relay performance with different uncertainty levels when sensitivity is set to 1. For this purpose, the ground surfaces are simulated with 3 uncertainty values for sensitivity level set to 1. The results are categorized based on various lines and presented in

Table 5 to Table 7. The following results can be concluded.

- 1- In general, the SEL relay detects about 56% of HIF cases.
- 2- On the average, the relay detection time is approximately 50 seconds.
- 3- The relay detection rate for different level of uncertainties is in the range of 40% to 70%.
- 4- In general, the HIF detection rate is independent of HIFs position along each line.



## Liberty Utilities – Fire Mitigation Protection System Study

Table 5. The effects of HIF position along the lines with 10% uncertainty for arcing sensitivity level = 1

Line	HIF position X% of total	Total cases	Number of Arc detected	Ave. arc detection time (sec) [min-max]	Dependability (%)
<b>L<sub>1-2</sub></b>	10%	7	0	-	0
	50%	7	7	43 [33-60]	100
	90%	7	6	52[46-56]	85.7
<b>L<sub>3-4</sub></b>	10%	7	3	49 [43-55]	42.8
	50%	7	4	46 [40-50]	57.1
	90%	7	7	44 [31-56]	100
<b>L<sub>6-8</sub></b>	10%	7	2	43 [37-58]	28.6
	50%	7	7	44[28-56]	100
	90%	7	7	46[40-54]	100
<b>L<sub>9-10</sub></b>	10%	7	7	45[28-60]	100
	50%	7	5	38[30-45]	71.4
	90%	7	5	56 [50-64]	71.4
<b>L<sub>10-11</sub></b>	10%	7	5	46 [42-50]	71.4
	50%	7	7	48 [42-50]	100
	90%	7	4	49 [42-55]	57.1
<b>L<sub>11-12</sub></b>	10%	7	4	43 [36-52]	57.1
	50%	7	5	51[44,56]	71.4
	90%	7	2	51[46,56]	28.6
<b>L<sub>11-13</sub></b>	10%	7	0	-	0
	50%	7	0	-	0
	90%	7	0	-	0
<b>Total</b>	10%	49	21	46[28-60]	42.8
	50%	49	35	48[28-60]	71.42
	90%	49	31	52[31,64]	63.26
<b>Final</b>	-----	147	87	49[28-64]	59.18

Table 6. The effects of HIF position along the lines with 5% uncertainty for arcing sensitivity level = 1

Line	HIF position X% of total	Total cases	Number of Arc detected	Ave. arc detection time (sec) [min-max]	Dependability (%)
<b>L<sub>1-2</sub></b>	10%	7	0	-	0
	50%	7	7	44[31-62]	100
	90%	7	6	47[39-53]	85.7
<b>L<sub>3-4</sub></b>	10%	7	6	48[42-56]	85.7
	50%	7	6	42[38-58]	85.7
	90%	7	7	46[32-55]	100
<b>L<sub>6-8</sub></b>	10%	7	2	36[32-40]	28.6



## Liberty Utilities – Fire Mitigation Protection System Study

	50%	7	3	50[39-53]	42.8
	90%	7	1	42[42-42]	14.3
<b>L<sub>9-10</sub></b>	10%	7	0	-	0
	50%	7	0	-	0
	90%	7	0	-	0
<b>L<sub>10-11</sub></b>	10%	7	0	-	0
	50%	7	5	45[40-50]	71.4
	90%	7	4	48[36-53]	57.1
<b>L<sub>11-12</sub></b>	10%	7	4	43[39-46]	57.1
	50%	7	5	48[38-56]	71.4
	90%	7	5	40 [34-54]	71.4
<b>L<sub>11-13</sub></b>	10%	7	0	-	0
	50%	7	0	-	0
	90%	7	0	-	0
<b>Total</b>	10%	49	12	44[32-56]	24.4
	50%	49	26	48[31-62]	53.1
	90%	49	23	47[32-55]	46.9
<b>Final</b>	-----	147	61	47[31-62]	41.5

Table 7. The effects of HIF position along the lines with 2.5% uncertainty for arcing sensitivity level = 1

Line	HIF position X% of total	Total cases	Number of Arc detected	Ave. arc detection time (sec) [min-max]	Dependability (%)
<b>L<sub>1-2</sub></b>	10%	7	6	37 [24-48]	85.7
	50%	7	7	46 [42-59]	100
	90%	7	1	45[45-45]	14.3
<b>L<sub>3-4</sub></b>	10%	7	3	45[28-63]	42.9
	50%	7	3	48 [42-50]	42.9
	90%	7	4	49 [41-55]	57.1
<b>L<sub>6-8</sub></b>	10%	7	6	46[42-54]	85.7
	50%	7	6	45[40-54]	85.7
	90%	7	2	37[36-38]	28.6
<b>L<sub>9-10</sub></b>	10%	7	7	43 [36-52]	100
	50%	7	7	44[28-56]	100
	90%	7	7	49 [47-58]	100
<b>L<sub>10-11</sub></b>	10%	7	0	-	0
	50%	7	0	-	0
	90%	7	5	44[30-56]	71.4
<b>L<sub>11-12</sub></b>	10%	7	4	46[42-54]	57.1
	50%	7	4	40[33-56]	57.1
	90%	7	4	41[34-48]	57.1



## Liberty Utilities – Fire Mitigation Protection System Study

L <sub>11-13</sub>	10%	7	7	40 [38-41]	100
	50%	7	7	38[30-45]	100
	90%	7	7	56 [50-67]	100
Total	10%	49	36	46 [24-63]	73.5
	50%	49	34	44[28-59]	69.4
	90%	49	30	49 [30-67]	61.2
Final	-----	147	100	46[24-67]	68.01

### 4.2.2. Effects of HIF position for sensitivity level = 0

The SEL relay performance is investigated for different HIF positions along the lines with different levels of uncertainty when the sensitivity is set to 0. The results obtained for uncertainties equal to 10%, 5%, and 2.5% are presented in Table 8 to Table 10, respectively. Based on these Tables, the following results can be concluded.

- 1- In general, the relay detection rate for sensitivity level equals to zero is approximately 53%.
- 2- The relay detection time is independent from the HIF positions and uncertainty levels. It is about 50 seconds.
- 3- The relay detection rate is varied for the HIFs occurring in different positions along each line.

Table 8. The effects of HIF position along the lines with 10% uncertainty for arcing sensitivity level = 0

Line	HIF position X% of total	Total cases	Number of Arc detected	Ave. arc detection time (sec) [min-max]	Dependability (%)
L <sub>1-2</sub>	10%	7	1	56 [56-56]	14.3
	50%	7	5	49[33-59]	71.4
	90%	7	6	42[38-58]	85.7
L <sub>3-4</sub>	10%	7	4	34[27-46]	57.1
	50%	7	5	47[38-57]	71.4
	90%	7	5	43[32-55]	71.4
L <sub>6-8</sub>	10%	7	2	52 [50-54]	28.6
	50%	7	7	44[31-62]	100
	90%	7	7	47[39-53]	100
L <sub>9-10</sub>	10%	7	7	48[42-56]	100
	50%	7	5	42[38-58]	71.4
	90%	7	5	39[33-46]	71.4
L <sub>10-11</sub>	10%	7	0	-	0
	50%	7	5	38[33-58]	71.4



## Liberty Utilities – Fire Mitigation Protection System Study

	90%	7	4	36[29-53]	57.1
<b>L<sub>11-12</sub></b>	10%	7	4	48[42-54]	57.1
	50%	7	5	45[38-58]	71.4
	90%	7	5	40[30-62]	71.4
<b>L<sub>11-13</sub></b>	10%	7	0	-	0
	50%	7	0	-	0
	90%	7	0	-	0
<b>Total</b>	10%	49	18	45[27-56]	36.7
	50%	49	32	47[31-62]	65.3
	90%	49	32	40[29-62]	65.3
<b>Final</b>	-----	147	82	44[27-62]	55.8

Table 9. The effects of HIF position along the lines with 5% uncertainty for arcing sensitivity level = 0

Line	HIF position X% of total	Total cases	Number of Arc detected	Ave. arc detection time (sec) [min-max]	Dependability (%)
<b>L<sub>1-2</sub></b>	10%	7	0	-	0
	50%	7	7	46 [42-59]	100
	90%	7	6	45[42-49]	85.7
<b>L<sub>3-4</sub></b>	10%	7	6	45[28-63]	85.7
	50%	7	6	48 [42-50]	85.7
	90%	7	7	49 [41-55]	100
<b>L<sub>6-8</sub></b>	10%	7	2	44[40-48]	28.6
	50%	7	2	60[55-65]	28.6
	90%	7	2	60[59-61]	28.6
<b>L<sub>9-10</sub></b>	10%	7	0	-	0
	50%	7	0	-	0
	90%	7	0	-	0
<b>L<sub>10-11</sub></b>	10%	7	0	-	0
	50%	7	5	38[33-58]	71.4
	90%	7	4	36[29-53]	57.1
<b>L<sub>11-12</sub></b>	10%	7	4	48[42-54]	57.1
	50%	7	4	45[38-58]	57.1
	90%	7	5	38[33-58]	71.4
<b>L<sub>11-13</sub></b>	10%	7	0	-	0
	50%	7	0	-	0
	90%	7	0	-	0
<b>Total</b>	10%	49	12	46[28-63]	24.5
	50%	49	24	50[33-65]	49
	90%	49	24	52[29-61]	49
<b>Final</b>	-----	147	60	50 [28-65]	40.8



## Liberty Utilities – Fire Mitigation Protection System Study

Table 10. The effects of HIF position along the lines with 2.5% uncertainty for arcing sensitivity level = 0

Line	HIF position X% of total	Total cases	Number of Arc detected	Ave. arc detection time (sec) [min-max]	Dependability (%)
L <sub>1-2</sub>	10%	7	1	64[64-64]	14.3
	50%	7	5	46 [38-50]	71.4
	90%	7	5	46 [36-48]	71.4
L <sub>3-4</sub>	10%	7	7	52[43-66]	100
	50%	7	6	56[36-67]	85.7
	90%	7	7	46 [24-51]	100
L <sub>6-8</sub>	10%	7	3	48[43-58]	42.9
	50%	7	5	46[39-53]	71.4
	90%	7	6	58[52-64]	85.7
L <sub>9-10</sub>	10%	7	7	55[48-58]	100
	50%	7	4	50[40-62]	57.1
	90%	7	3	58[43-68]	42.9
L <sub>10-11</sub>	10%	7	0	-	0
	50%	7	5	49[46-54]	71.4
	90%	7	5	46[30-60]	71.4
L <sub>11-12</sub>	10%	7	5	48 [42-56]	71.4
	50%	7	7	52 [41-65]	100
	90%	7	7	47[44-61]	100
L <sub>11-13</sub>	10%	7	0	-	0
	50%	7	2	64[62-66]	28.6
	90%	7	4	54[48-58]	57.1
Total	10%	49	23	56[43-66]	46.9
	50%	49	34	59[36-67]	69.4
	90%	49	37	48[24-68]	75.5
Final	-----	147	94	54[24-68]	63.9

The following results are observed based on above Tables.

- 1- In general, the relay detection rate is approximately 40% and 63% for sensitivity equal to 1 and 0, respectively.
- 2- The relay detection rate is independent of HIF uncertainty levels.
- 3- The average arc detection time is approximately 50 seconds regardless of sensitivity level values.



## Liberty Utilities – Fire Mitigation Protection System Study

### 4.3. SEL relay performance analysis for HIF phase detection

This section investigates the SEL relay performance for the detection of correct HIF phase using 294 simulation tests. To perform this analysis, 7 different types of HIF ground surfaces are simulated for 7 different lines in 3 different phases of A, B, and C. The detailed description of this analysis is given in Table 11.

Table 11. Detailed descriptions of the HIF phase detection scenarios

Parameter	Value	Description
Surface types	7	Dry Cement, Dry asphalt concrete, Wet cement, Dry soil, Wet soil, Dry reinforced concrete, Wet reinforced concrete
Lines	7	Lines: L <sub>1-2</sub> , L <sub>3-4</sub> , L <sub>6-8</sub> , L <sub>9-10</sub> , L <sub>10-11</sub> , L <sub>11-12</sub> , L <sub>11-13</sub>
HIF Phase	3	HIF Phases: A, B, C
Uncertainties	1	Uncertainties in nonlinear HIF resistances: 0.85 – 0.95 5%
Sensitivity	2	HIF arcing sensitivity levels: 0, 1
Total	294	

The results are presented in Table 12 and Table 13 for arcing sensitivity level equal to 1, respectively. Based on the results presented in the Table 12 and Table 13, the following observations are made:

- 1- The HIF phase detection accuracy rate depends on the arc current magnitude.
- 2- In general, the relay arc phase determination accuracy is almost 63% and 55 % for arcing sensitivity level equals to 1 and 0, respectively.

Table 12. The effects of HIF phases on SEL relay performance under different surface types with arc sensitivity = 1

Surface Type	Total cases	Number of Arc detected	Dependability (%)	Number of correct detected phase	Phase detection percentage (%)
Dry asphalt concrete	21	12	57.1	7	58.3
Wet cement	21	14	66.7	10	71.4
Dry soil	21	17	80.9	11	64.7
Wet soil	21	15	71.4	13	86.7
Dry reinforced concrete	21	18	85.7	11	61.1
Wet reinforced concrete	21	18	85.7	7	38.9
Total	147	94	63.9	59	62.8

Table 13. The effects of HIF phases on SEL relay performance under different surface types with arc sensitivity = 0

Surface Type	Total cases	Number of Arc detected	Dependability (%)	Number of correct detected phase	Phase detection percentage (%)
Dry asphalt concrete	21	9	42.9	6	66.7
Wet cement	21	14	66.7	8	57.1





## Liberty Utilities – Fire Mitigation Protection System Study

Dry soil	21	16	76.2	10	62.5
Wet soil	21	14	66.7	7	50
Dry reinforced concrete	21	14	66.7	10	71.4
Wet reinforced concrete	21	18	85.7	6	33.3
Total	147	85	57.8	47	55.3

### 4.4. Effects of arc sensitivity level

This section investigates the effects of arc sensitivity on the relay performance. To carry out the sensitivity analysis, one hundred tests are performed for each level of arc sensitivity. Table 14 shows detailed description for this study.

Table 15 presents a total of 200 tests categorized based on various arcing sensitivity levels. Based on Table 15, it can be concluded that increasing arcing sensitivity level leads to an increase in HIF arc detection rate.

Table 14. Detailed descriptions of scenarios for Arc sensitivity level effect on SEL relay performance

Parameter	No.	Description
Sensitivity	2	HIF arcing sensitivity levels: 1, 0
Test number	100	100 tests are performed for each arcing sensitivity level.
Total	200	

Table 15. The effects of Arcing sensitivity level on SEL relay performance

Surface Type	Arcing sensitivity level	Total cases	No. of Arc detected	Ave. arc detection time (sec) [min-max]	Dependability (%)
Dry Soil	1	100	68	50 [42-68]	68
	0	100	53	52 [48-65]	53
Total	-----	200	121	49 [42-68]	60.5

As shown in Table 15, increasing the arcing sensitivity level leads to detecting more HIFs with lower detection times.

### 4.5. SEL relay security analysis

To assess the security of the HIF detection method, the effects of load variation, capacitor switching, and synchronous motor starting are investigated. Based on



## Liberty Utilities – Fire Mitigation Protection System Study

Table 16, five different load steps are considered for balanced and unbalanced loads placed at five different positions along the network. The capacitors are placed in different lines and switched several times with different time intervals. Also, two synchronous motors are placed at two lines to check their starting effects on the performance of the relay. All the above scenarios are investigated for both arc sensitivity levels of 1 and 0. Analysis of the total 60 cases shows that the relay security rate under uncertainties such as load variation, capacitor switching, and synchronous motor starting is acceptable and there is no misdetection.

Table 16. Detailed descriptions of scenarios for SEL relay reliability analysis

Parameter	No.	Description
Load Variation	5 steps	The load is varied between 200 to 400 Amperes
Load Position	3	Lines: L <sub>10-11</sub> , L <sub>11-12</sub> , L <sub>11-13</sub>
Capacitor Position	1	Lines: L <sub>11-13</sub>
Synchronous Motor	2	Lines: L <sub>11-12</sub> , L <sub>11-13</sub>
Sensitivity	2	HIF arcing sensitivity levels: 1, 0
Total	60	

### 5. Fast Tripping

Many utilities have implemented fast trip settings for several years. SDG&E has had some form of fast trip settings for about 10 years, SCE started implementing their fast trip schemes in 2018, and Avista has had fast trip settings for several years. PacifiCorp performed their first systemwide implementation in 2021. BC Hydro has only performed testing a limited pilot fast tripping scheme on one distribution circuit.

Other utilities are also looking at new technologies to detect high impedance faults, detecting falling or broken conductors and sensitive ground settings. SDG&E has implemented Sensitive Ground Fault (SGF) and High Impedance Fault detection settings on their system. Most other of these are in the testing or pilot phase in evaluating these new technologies.



## Liberty Utilities – Fire Mitigation Protection System Study

Table 17. Utility Comparison: Service Area, Voltages, and configuration

	<b>PG&amp;E</b>	<b>SCE</b>	<b>SDG&amp;E</b>	<b>PacifiCorp (for CA)</b>	<b>Avista</b>	<b>BC Hydro</b>
<b>Location</b>	Northern & Central California	Southern & Central California	Southern California	Northern California, Oregon, Washington	Eastern Washington, N. Idaho	BC Canada
<b>Customers</b>	5,200,000	5,000,000	1,400,000	45,000 (780,000 total)	400,000	1,800,000
<b>Service Area (sq. mi)</b>	70,000	50,000	4,100	11,000	30,000	NA
<b>Total Dist. Subs</b>	651	900	134	63	NA	NA
<b>Total Dist. Circuits</b>	3,074	4,600	1,035	NA	NA	NA
<b>Total Dist. Circuits Miles</b>	108,000	69,800	17,085	NA	19,100	NA
<b>UG Circuit-Miles</b>	27,000	31,000	10,558	Mostly OH	Mostly OH	Mostly OH
<b>OH Circuit-Miles</b>	81,000	38,800	6,527	Mostly OH	Mostly OH	Mostly OH
<b>Circuits in HFTD</b>	800	1,074	70	260	154	NA
<b>Voltages (kV)</b>	21, 12, 17, 4	33, 16, 12, 4	12, 4	12, 24	13.2, 24, 34	12, 25
<b>Config./Grounding</b>	3-wire uni-ground, 4-wire multi-ground	3-wire uni-ground, 4-wire multi-ground	3-wire uni-ground, 3-wire multi-ground via line-installed ground banks, 4-wire multi-ground	4-wire multi-ground	4-wire multi-ground	4-wire multi-ground



## Liberty Utilities – Fire Mitigation Protection System Study

Table 18. Utility Comparison: Fast Trip Settings Comparison

	<b>PG&amp;E</b>	<b>SCE</b>	<b>SDG&amp;E</b>	<b>PacifiCorp (for CA)</b>	<b>Avista</b>	<b>BC Hydro</b>
<b>Fast Trip</b>	Yes	Yes	Yes	Yes	Yes	Testing & Pilot
<b>Fast Trip Designation</b>	Enhanced Powerline Safety Settings (EPSS)	Fast Curve (FC)	Sensitive Relay Profile (SRP)	Sophisticated Program Control Settings (SPCS)	Dry Land Mode (DLM)	NA
<b>Year in Service</b>	2021	2018	~2010	2021	~2018	NA
<b>Operating Mode(s)</b>	1	2 (Normal and Fast Curves)	4	2	3	1
<b>Settings Applied:</b>	Circuit Specific	Circuit Specific	Circuit Specific	Standard	Standard	Circuit Specific
<b>Schedule</b>	Daily (was seasonal in 2021)	Daily and Seasonal	Daily	Daily	Daily	Season
<b>Fuse Over-reach (upstream 3-ph ganged trip operation for back feed prevention)</b>	Yes	No	Yes	Yes	Yes	None
<b>Activation Methods</b>	Manual & Remote	Mostly Remote	Mostly Remote	Mostly Manual	Mostly Remote	Manual
<b>Trigger</b>	Weather Conditions, circuit and fire risk designation	Weather Conditions, Fuel Conditions, circuit & fire risk designation	Extreme Fire Potential Index (FPI) or PSPS Forecasted	Weather Conditions	Fire Risk Potential Score (Risk = Prob. x Impact)	Weather Conditions



## Liberty Utilities – Fire Mitigation Protection System Study

	PG&E	SCE	SDG&E	PacifiCorp (for CA)	Avista	BC Hydro
<b>Settings Description</b>	<p>Set phase and ground instantaneous pickups to see EOL for fused taps within the device protective zone (DPZ). Set definite time with delay not to exceed 0.1 seconds and use 0.02-second margin for coordinating between devices.</p>	<p>Used multiples of normal minimum trip to set fast curve settings with a time delay of typically 2 cycles. These settings typically help coordinate with other line protection devices, including fuses, while balancing ignition risk. SCE currently is using more sensitive multiple of pickup settings with a time delay of 4 cycles at a circuit-specific level.</p> <p>All reclosing is blocked during High Fire conditions.</p>	<p>Phase elements are set to trip at a minimum of 50% above peak historical load. Ground elements are based on peak historical trends and set utilizing a specific table contained within the settings methodology. Set definite time with 0.5-cycle delay. Multiple devices set with SRP may operate for downstream faults due to sensitivity and reduced protection margins.</p>	<p>To improve coordination, use definite time delays (12-cycles for substation breakers, 6-cycles between reclosers). Also, implement fuse overreach and harmonic blocking schemes.</p> <p>Modes:</p> <p>Elevated Risk: Instantaneous trip followed by single reclose attempt after sufficient time to limit the persistence of fire</p> <p>Extreme Risk: Instantaneous trip with no reclose attempt</p>	<p>The settings profiles include:</p> <p>Base Dry Land Mode:</p> <p>Fast Trip on instantaneous overcurrent followed by single reclose attempt after with time-overcurrent element after sufficient time to limit the persistence of fire</p> <p>Fire 2-Shot: Fast Trip on instantaneous overcurrent followed by single reclose attempt after with instantaneous overcurrent element after sufficient time to limit the persistence of fire</p> <p>Fire 1-Shot: Fast Trip on instantaneous overcurrent with no reclosing</p>	<p>Fast Trip tested in one area using Siemens Fuse Savers (FS). Similar to Hot Line tag settings, used for worker safety: 50ms Phase, 500 ms Ground (less false trips, better coord.). Also Implemented single shot lockout</p>



## Liberty Utilities – Fire Mitigation Protection System Study

Table 19: Utility Comparison: Other Technologies being evaluated or in service

	<b>PG&amp;E</b>	<b>SCE</b>	<b>SDG&amp;E</b>	<b>PacifiCorp (for CA)</b>	<b>Avista</b>	<b>BC Hydro</b>
<b>Sensitive Ground Fault (SGF) Detection Schemes</b>	In service, thresholds set at 15 Amp, 15 sec	Generally, none; however, SCE has several dozen stations in service with impedance grounding to limit ground faults to less than 150 amps (low ground) or 50 amps (sensitive ground) where sensitive ground relay settings are applied	In service year-round. Set by evaluating peak neutral imbalance current on specific line section to set the SGF setting. SGF settings reviewed once per year for each device or when device operates in the field.	None	None	None
<b>High Impedance Fault (HIF) or Down Conductor Detection (DCD) Schemes</b>	Testing, Pilot	Pilot, in monitor/alarm mode only. Under specific circumstances, they apply these setting modes on line reclosers as part of their normal settings.	In service since 2011	Pilot, enabled in monitoring mode only	None	None
<b>Falling Conductor &amp; Open Phase Detection</b>	AMI Voltage Detection	Piloting AMI Abnormal Voltage Detection to identify possible blown fuse locations, Piloting Open Phase Detector scheme (sequence voltage based system) in a non-tripping mode	AMI Voltage Detection, Pilot on several feeders with falling wires scheme (voltage synchrophasor based system)	None	None	None



## Liberty Utilities – Fire Mitigation Protection System Study

### 5.1. San Diego Gas & Electric (SDG&E)

SDG&E operates an electric distribution system that serves approximately 3.6 million people through about 1.4 million meters. SDG&E's service territory spans more than 4,100 square miles from the California-Mexico border north to Southern Orange County and Riverside County and from the San Diego County Coastline east to Imperial County. SDG&E's system includes 134 distribution substations, 1,035 distribution circuits, 225,697 poles, 10,558 circuit miles of underground systems and 6,527 circuit miles of overhead systems. Approximately 3,500 circuit miles of overhead circuits are operated within the High Fire Threat District (HFTD). The electric distribution system consists of predominantly underground facilities (62%), but significant overhead facilities span the high-risk fire areas. The primary distribution voltage is mostly 12 kV, with some large areas of 4 kV. Grounding configurations for the distribution system include 3-wire uni-grounded, 3-wire multi-grounded via line-installed ground banks and a 4-wire multi-grounded configuration.

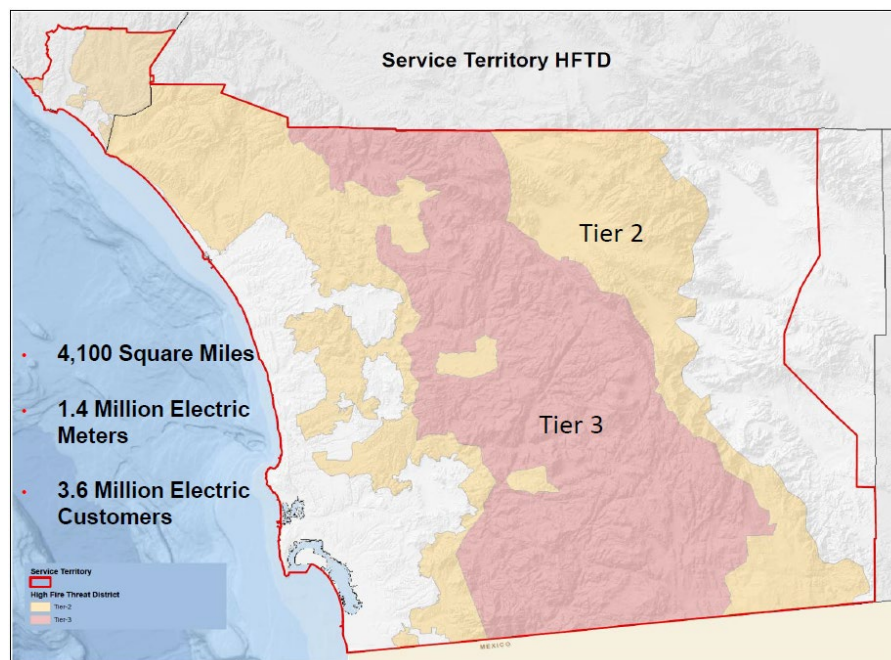

Figure 15. SDG&E Service Territory with HFTDs

When extreme fire weather conditions or PSPS events are forecasted, SDG&E remotely enables Sensitive Relay Profile (SRP) on its system; SRP includes settings which make protective devices such as reclosers and circuit breakers more sensitive to faults on the overhead distribution system and activate quickly to interrupt power. SDG&E pre-identifies and maintains



## Liberty Utilities – Fire Mitigation Protection System Study

a list of these devices and can quickly communicate with its distribution operations control center to enable SRP when conditions warrant and in observance of wildfire safety efforts. SRP settings include standard settings for all HFTD circuits:

- The phase minimum to trip set is at 50% above peak load on the circuit spanning a 5-year history
- The ground minimum to trip is based on peak historical trends and set using a specific table contained within the settings methodology.
- Definite time set with 0.5 cycle delay

The advantage of these settings is that there is a definite tripping time for all fault currents above minimum to trip. The disadvantage is that devices potentially do not coordinate, so downstream faults may lock out multiple devices. If multiple devices trip during an event when sensitive settings are enabled, SDG&E retains protection engineers and field resources available 24/7 to review event records to help determine if mis-coordination contributed to the event. These standby resources review each event in real-time and provide detailed information back to our operations teams and the EOC for situational awareness.

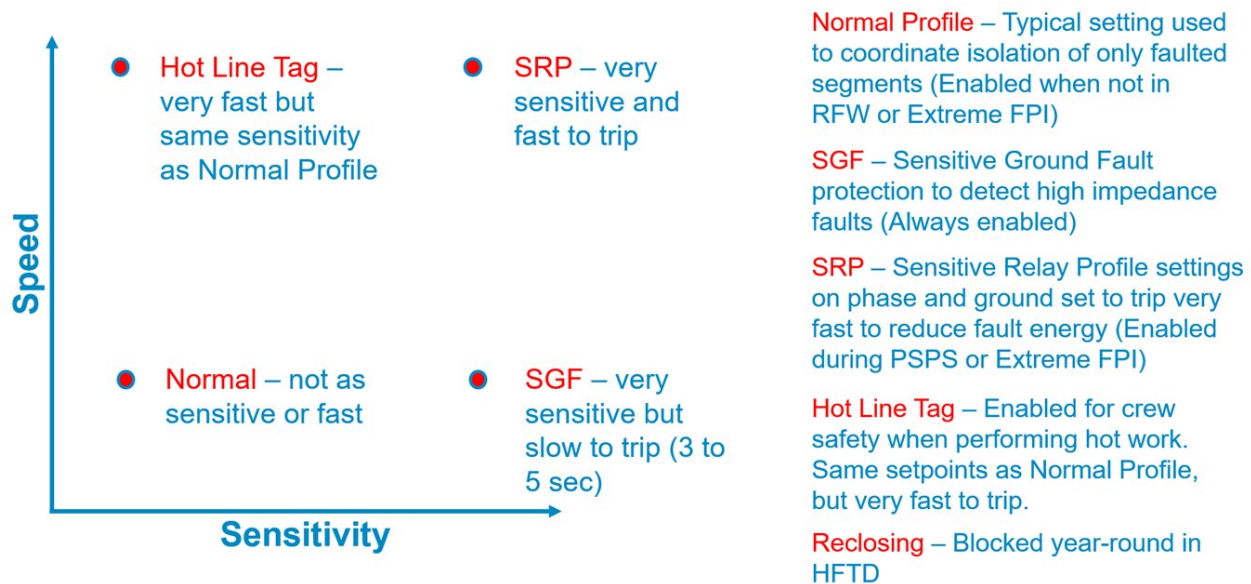

Figure 16. SDG&E Sensitive Settings Comparison

### 5.2. Southern California Edison (SCE)

SCE operates an electric transmission/subtransmission/distribution system that serves approximately 15 million people through about 5 million customer accounts. SCE's service area





## Liberty Utilities – Fire Mitigation Protection System Study

spans about 50,000 square miles across central, coastal and Southern California, excluding the city of Los Angeles (served by LADWP) and other small cities served by municipal utilities. SCE's system includes about 900 distribution substations, 1.2 million distribution poles, 69,800 circuit miles of distribution primary lines, 31,000 circuit miles of distribution underground lines and 38,800 circuit miles of distribution overhead lines. The primary distribution voltage is predominantly 12 kV, with some large areas of 33kV, 16kV and 4 kV. Grounding configurations include both 3-wire uni-grounded and a 4-wire multi-grounded configuration. SCE mixes both 3-wire and 4-wire configurations on the same circuits.

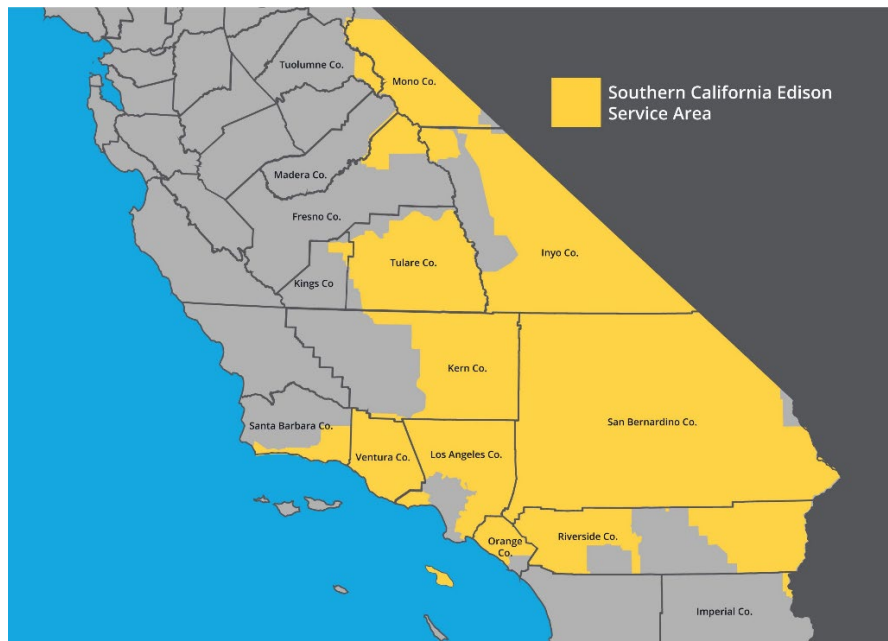

Figure 17. SCE Service Territory

In 2018, SCE initiated a program to deploy fast-curve settings at substation circuit breaker relays and automatic reclosers and developed a plan for upgrading non-compatible and older vintage electromechanical and microprocessor relays for feeder circuits in high fire risk areas between 2020-2024.

SCE expects to complete upgrades to over 90% of all circuit breaker relays in high fire risk areas by 2022, with the remaining circuits upgraded by 2024.

SCE uses multiples of normal minimum trip to set fast-curve settings with a time delay of typically two cycles. Normal minimum trip for each device is set to 150% of peak load. These settings typically help coordinate with other line protection devices, including fuses. SCE is presently evaluating its fast-curve settings to provide increased circuit coverage while maintaining reliability and coordination with fuses.



## Liberty Utilities – Fire Mitigation Protection System Study

### 5.3. PacifiCorp

PacifiCorp serves more than 780,000 customers in 243 communities across Oregon, Washington, and Northern California. In California, PacifiCorp provides electricity to approximately 45,000 customers via 63 substations, 2,520 circuit miles of distribution lines, and 800 circuit miles of transmission lines. The service territory spans nearly 11,000 square miles, with just under half in HFTDs. Approximately 1,200 miles (36%) of all overhead lines are located within the HFTDs, with about 850 miles of overhead distribution lines (260 circuits) and 350 miles of transmission lines in HFTDs. PacifiCorp's distribution system comprises 12.5 kV and 24 kV circuits and uses a 4-wire multi-ground configuration.



Figure 18. PacifiCorp Service Territory

PacifiCorp conducted a pilot of Sophisticated Program Control Settings (SPCS) in 2021. This pilot evaluated the optimal approaches in using sensitive and sophisticated device settings to reduce wildfire risk and improve reliability. Devices, including relays, reclosers, and fuses, all have methods by which they are programmed to operate in response to a fault condition. If there is limited coordination between devices, it can increase the probability of equipment damage or



## Liberty Utilities – Fire Mitigation Protection System Study

delayed device operations, creating and extending an ignition risk. After experimenting and making minor modifications, PacifiCorp has adopted these settings as standard.

The settings profiles include:

- Normal: Time-overcurrent trip followed by reclosing attempts
- Elevated Risk: Instantaneous trip followed by single reclose attempt after sufficient time to limit the persistence of fire
- Extreme Risk: Instantaneous trip with no reclose attempt
- Safety Hold: for line worker usage during line operations where no reclosing occurs.

These settings use definite time delays (12-cycles for substation breakers, 6-cycles between reclosers) to improve coordination. The settings also implement fuse overreach and harmonic blocking schemes. They are not currently enabling any sensitive ground fault detection.

PacifiCorp is also piloting the use of radio communications between substation relays and their associated first zone line reclosers (mirrored bits). This pilot is aimed to reduce device-to-device coordination time, which can reduce arc energy. Initial results indicate this approach is highly valuable in locations where coordination delays are needed for proper device coordination; such delays increase the duration during which arc energy is being experienced and reduce the fault duration and the probability of ignition. The goal is to maintain a high level of reliability while still reducing potential arc ignition time or magnitude.

PacifiCorp has also piloted high impedance fault detection, which is currently configured to alarm upon detection. As PacifiCorp gains more experience with alarming versus device operation, settings will be modified; also, during high fire risk periods, the high impedance element is functioning in a tripping (not just alarm) mode.

### 5.4. Avista

Avista Utilities generates and transmits electricity and distributes natural gas to residential, commercial, and industrial customers. The service territory covers 30,000 square miles in eastern Washington, northern Idaho, and parts of southern and eastern Oregon. Avista provides electricity to 359,000 customers in three western states.



## Liberty Utilities – Fire Mitigation Protection System Study



Figure 19. Avista Service Territory

Avista experiences a fire season beginning around mid-July and lasting until late September or early October. During this season, Avista has historically disabled time-overcurrent (50) tripping and reclosing on its distribution protection system, seeking to reduce spark ignition potential while maintaining coordination via time-overcurrent (51) elements.

As part of its ongoing effort to strengthen its wildfire resiliency program, Avista devised a new approach to its distribution operations during the fire season that seeks to calculate circuit-specific fire risks and allow operators to alter relay operating behaviors in response to the fire risk dynamically. The feeder relays and reclosers are programmed with three different "Dry Land Modes". Each mode further reduces electrical fault energy by reprioritizing instantaneous overcurrent (50) elements over time-overcurrent (51) elements. In addition, reclosing is reduced or disabled.

The settings profiles include:

- Base Dry Land Mode: Fast Trip on instantaneous overcurrent followed by single reclose attempt after with time-overcurrent element after sufficient time to limit the persistence of fire



## Liberty Utilities – Fire Mitigation Protection System Study

- Fire 2-Shot: Fast Trip on instantaneous overcurrent followed by single reclose attempt after with instantaneous overcurrent element after sufficient time to limit the persistence of fire
- Fire 1-Shot: Fast Trip on instantaneous overcurrent with no reclosing

Avista calculates a fire risk potential considering various weather, environmental, and operational data for the different distribution circuits. Based on real-time fire risk calculations.

The protective devices on a specific circuit can be moved into the appropriate "Dry Land Mode", allowing for a dynamic scheme that attempts to balance fire resiliency with service reliability.

### Normal Operation (Off-Fire Season)



### Old Dry Land Mode



### Base Dry Land Mode



### Fire 2-Shot



### Fire 1-Shot



Increasing  
Circuit  
Fire  
Risk

New  
Dry  
Land  
Modes

Figure 20. Avista's Fast Trip Approach (" indicates seconds)



## Fire Risk Potential

- Risk = Probability · Impact
- Probability Factors
  - Wind Gusts
  - Sustained Winds
  - Wind Direction
  - Relative Humidity
  - Fuel Type
  - USDM Drought Index
  - Fire Preparedness Levels
  - Feeder OMS Data
  - Feeder Health
- Impact Factors
  - Public Safety
  - Societal Costs
  - WUI Map
    - Infrastructure
    - Development
    - Fuel Type
    - Ignition Probability
    - Fire-Spread Risk
    - WUI Tier 0-3
- Fire Risk Score for each distribution circuit
  - 8-Day Forecast

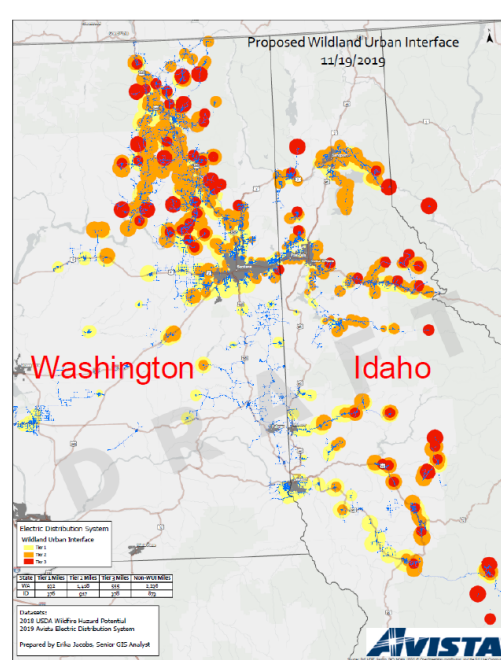

Figure 21. Avista's Fire Risk Potential Methodology



### 5.5. British Columbia Hydro (BC Hydro)

BC Hydro is a Crown corporation owned by the government and the people of British Columbia, Canada. They generate and deliver electricity to 95% of the population of BC. They serve over four million people. Electricity is delivered over 11,362 miles of transmission lines and 34,333 miles of distribution lines. The distribution system comprises 12.5 kV and 25 kV circuits and uses a 4-wire multi-ground configuration. Historically, BC Hydro experiences a fire season beginning around August and lasting until late September. However, the fire seasons have been starting earlier in recent years due to drier conditions.



Figure 22. BC Hydro Service Territory

BC Hydro performed lab testing and conducted a field pilot of distribution circuit fast trip settings. Their implementation used Siemens Fuse Saver (FS) devices. FS devices are capable of very fast tripping (1/2 cycle or 0.01s). However, these devices have limited load current ratings and fault duty capability (100A and 4kA, respectively), restricting their use to taps and lateral sections of circuits. The FS are programmed with coordinated tripping, fast tripping mode, and single-shot reclosing lockout settings. BC Hydro envisions using circuit specific settings that



provide some level of coordination between devices. The Fast Trip settings were tested at Powertech before the field pilot. They do not implement any sensitive ground fault settings or high-impedance (HIF) fault detection schemes.

The fast trip settings are like hot line tag settings used for worker safety: 50ms Phase-overcurrent and 500 ms Ground-overcurrent. The settings are tailored to minimize false trips and provide better coordination.

## 6. Conclusions and Future Works

In this report, wildfire mitigations practices in utilities were discussed. Also, a literature review of HIF detection algorithms introduced in academic papers were given. The MAY3400 feeder was modeled in RSCAD software in RTDS platform. An arc model that uses actual HIFs to apply nonlinear distortions in the arc currents was simulated. Also, HIFs for different ground surfaces such as dry cement, dry asphalt concrete, wet cement, dry soil, wet soil, dry reinforced concrete and wet reinforced concrete were modeled. The hardware-in-the-loop setup at the UNR power system lab has been used to send current and voltage signals from the simulated MAY3400 feeder to the SEL-451 relay using sample value (SV) protocol.

We have tested the SEL-451 relay for about 1500 HIF cases and obtained the event reports from the relay. The relay detected 67.6% of these test cases. The average detection time of HIF detection methods of SEL relay is around 50 seconds. Therefore, even though the relay can reduce human safety risks, the high detection time makes it less effective for mitigating wildfire hazards. The test results show that the dependability rate and detection time of the HIF methods of the relay are independent of the fault positions along the feeder and arc resistance uncertainty. The dependability rate for SEL 451 is better for high sensitivity setting of 1 as opposed to 0 for low sensitivity. In addition, the relay phase determination accuracy is almost 63% and 55 % for arcing sensitivity level equals to 1 and 0, respectively. **Based on the extensive RTDS simulations and results shown in this report, we strongly recommend that a fast-tripping scheme be implemented in high fire risk areas to reduce the fault clearing time; thereby significantly mitigating the fire risk.**





## 7. References

- [1] D. H. Lubich, Sr, “High resistance grounding and fault finding on three phase three wire (Delta) power systems,” *IEEE Paper-7803-4090-6/97*, 1997.
- [2] J. P. Nelson, “High-resistance grounding of low-voltage systems: Standard for the petroleum and chemical industry,” *IEEE Trans. Ind. Applicat.*, vol. 35, pp. 941–948, July/Aug. 1999.
- [3] J. C. Das and R. H. Osman, “Grounding of AC and DC low-voltage and medium-voltage drive systems,” *IEEE Trans. Ind. Applicat.*, vol. 34, pp. 205–216, Jan./Feb. 1998.
- [4] J. Carr, G. L. Hood, “High Impedance Fault Detection on Primary Distribution systems,” CEA Final Report, Project No. 78–75, Nov. 1979.
- [5] IEEE Power Engineering Society, *Downed Power Lines: Why They Can’t Always Be Detected*, New York: IEEE, 1989.
- [6] PP&L, “Report of Distribution Conductor Staged Fault Tests,” Oct. 1973.
- [7] J. Carr, G. L. Hood, “High Impedance Fault Detection on Primary Distribution Systems,” CEA Final Report, Project No. 78–75, Nov. 1979.
- [8] I. Lee, “High Impedance Fault Detection Using Third Harmonic Current,” EPRI Final Report, EPRI EL-2430, June 1982.
- [9] S. J. Balsler, K. A. Clements, E. Kallaur, “Detection of High Impedance Faults,” EPRI Final Report, EPRI EL-2413, June 1982.
- [10] B. D. Russell, B. M. Aucoin, T. J. Talley, “Detection of Arcing Faults on Distribution Feeders,” EPRI Final Report, EPRI EL-2757, Dec. 1982.
- [11] S. J. Balsler, K. A. Clements, D. J. Lawrence, “A Microprocessor-Based Technique for Detection of High Impedance Faults,” *IEEE Trans. Power Delivery*, vol. 3, pp. 252–258, July 1986.
- [12] C. J. Kim, B. D. Russell, “Classification of Faults and Switching Events by Inductive Reasoning and Expert System Methodology,” *IEEE Trans. Power Delivery*, vol. 3, pp. 1631–1637, July 1989.
- [13] S. Ebron, D. L. Lubkeman, M. White, “A Neural Network Approach to The Detection of Incipient Faults on Power Distribution Feeders,” *IEEE Trans. Power Delivery*, vol. 2, pp. 905–914, April 1990.
- [14] A. P. Apostolov, J. Bronfeld, C. H. M. Saylor, P. B. Snow, “An Artificial Neural Network Approach to the Detection of High Impedance Faults,” in *1993 International Conference on Expert System Applications for the Electrical Power Industry Proceedings*.
- [15] D. I. Jeerings, J. R. Linders, “A Practical Protective Relay for Down-Conductor Faults,” *IEEE Trans. Power Delivery*, vol. 2, pp. 565–574, April 1991.
- [16] J. Liang, S. Elangovan, J. B. X. Devotta, “A Wavelet Multiresolution Analysis Approach to Fault Detection and Classification in Transmission Lines,” *International Journal of Electrical Power and Energy Systems*, vol. 20, Issue 5, pp. 327–332, June 1998.
- [17] T. M. Lai, L. A. Snider, E. Lo, “Wavelet Transformation Based Algorithm for the Detection of Stochastic High Impedance Faults,” in *Proc. International Conference on Power System Transients (IPST 2003)*, New Orleans, LA, September 2003.
- [18] Y. Sheng and S. M. Rovnyak, “Decision Tree-Based Methodology for High Impedance Fault Detection,” *IEEE Trans. Power Delivery*, vol. 2, pp. 533–536, April 2004.



## Liberty Utilities – Fire Mitigation Protection System Study

- [19] F. G. Jota and P. R. S. Jota, “High-Impedance Fault Identification Using a Fuzzy Reasoning System,” *IEE Proceedings – Generation, Transmission and Distribution*, vol. 145, Issue 6, pp. 656–661, Nov. 1998.
- [20] *Detection of Downed Conductors on Utility Distribution Systems*, IEEE PES Tutorial Course, 90EH0310-3-PWR, Piscataway, NJ: IEEE, 1989.
- [21] “The Interruption of Downed Conductors on Low Voltage Distribution Systems,” Report prepared by the IEEE Power System Relaying Committee for the Electric Power Research Institute, Oct. 1976.
- [22] J. T. Tengdin, E. E. Baker, J. J. Burke, B. D. Russell, R. H. Jones, and T. E. Wiedman, “Application of High Impedance Fault Detectors: a Summary of the Panel Session Held at the 1995 IEEE PES Summer Meeting” in *Proc. Transmission and Distribution Conference*, Los Angeles, CA, Sept. 1996.
- [23] “High Impedance Fault Detection Technology,” Report of IEEE PSRC Working Group D15, March 1996. [Online] Available: <http://grouper.ieee.org/groups/td/dist/documents/highz.pdf>.
- [24] “Final Report,” 2009 Victorian Bushfires Royal Commission. 2010.
- [25] D. Thompson, “Homeowner equipment caused California wine country fire,” January 25, 2019.
- [26] A. Robertson, “Investigators confirm that PG&E power lines started the deadly Camp Fire,” *The Verge*, May 15, 2019.
- [27] I. Penn, T. Fuller, and L. Friedman, “PG&E bankruptcy tests who will pay for California wildfires,” *New York Times*, Jan. 14, 2019.
- [28] C. Isidore, “PG&E, utility tied to wildfires, will file for bankruptcy,” *CNN Business*, Jan. 14, 2019.
- [29] K. Pimlott, J. Laird, E. G. Brown, “2015 Wildfire Activity Statistics, California Department of Forestry and Fire Protection,” 2015.
- [30] S. Jazebi, F. de Leon, A. Nelson “Review of Wildfire Management Techniques, Part II: Urgent Call for Investment in Research and Development of Preventative Solutions,” *IEEE Trans. Power Deliv.*, 2019.
- [31] S. Yong, et al, "Decision tree-based methodology for high impedance fault detection." *IEEE Trans. Power Deliv.*, vol. 19, no. 2, pp. 533-536, 2004.
- [32] T. M. Lai, et al. "High-impedance fault detection using discrete wavelet transform and frequency range and RMS conversion." *IEEE Trans. Power Deliv.*, vol. 20, no. 1, pp. 397-407, 2005.
- [33] K. Moses, et al, "High-impedance fault detection and classification in power system distribution networks using morphological fault detector algorithm." *IET Gen., Trans. & Distr.*, 12. (15), 3699-3710, 2018.
- [34] W. Bin, J. Geng, X. Dong, "High-impedance fault detection based on nonlinear voltage–current characteristic profile identification." *IEEE Trans. Smart Grid*, vol. 9, no. 4, pp. 3783-3791, 2016.
- [35] O. A. Gashteroodkhani, S. Aznavi, M. Majidi, M. Etezadi-Amoli, "An Intelligent Protection Scheme for Microgrids based on S-transform and Deep Belief Network," *IEEE Power and Energy Society General Meeting (PESGM)*, Atlanta, GA, USA, Aug 2019.



- [36] O. A. Gashteroodkhani, M. Majidi, M. Etezadi-Amoli, "A Combined Deep Belief Network and Time-Time Transform based Intelligent Protection Scheme for Microgrids," *Electric Power System Research*, Vol. 182, 106239, 2020.
- [37] W. Xiaowei, G. Jie, et al, "High Impedance Fault Detection Method Based on Variational Mode Decomposition and Teager-Kaiser Energy Operators for Distribution Network", *IEEE Trans. Smart Grid*, 2019.
- [38] M. Sarlak, S. M. Shahrtash, "High impedance fault detection using combination of multi-layer perceptron neural networks based on multi-resolution morphological gradient features of current waveform." *IET Gen. Trans. Distr.*, vol. 5, no. 5, 588-595, 2011.
- [39] S. R. Samantaray, et al, "High impedance fault detection in power distribution networks using time–frequency transform and probabilistic neural network," *IET Gen. Trans. Distr.*, vol. 2, no. 2, pp. 261-270, 2008.
- [40] O. A. Gashteroodkhani, M. Majidi, M. S. Fadali, M. Etezadi-Amoli, E. M. Amiri, "A Protection Scheme for Microgrids Using Time-Time matrix Z-score Vector", *International Journal of Electrical Power and Energy Systems*, vol. 110, pp. 400-410, 2019.
- [41] A. H. Etemadi, M. Sanaye-Pasand, "High-impedance fault detection using multi-resolution signal decomposition and adaptive neural fuzzy inference system." *IET Gen. Trans. Distr.*, 2(10), pp. 110-118, 2008.
- [42] M. Apostolos, et al, "Detection and location of high impedance faults in multiconductor overhead distribution lines using power line communication devices." *IEEE Trans. Smart Grid*, 6. (2), 894-902, 2014.
- [43] A. R., Sedighi, et al, "High impedance fault detection based on wavelet transform and statistical pattern recognition." *IEEE Trans. Power Deliv.* vol. 20, no. 4, pp. 2414-2421, 2005.
- [44] L., É. Mangueira, et al. "High impedance fault detection method based on the short-time Fourier transform." *IET Generation, Transmission & Distribution*, vol. 12, no.11, pp. 2577-2584, 2018.
- [45] S. Kumari, et al, "High-impedance fault detection in electrical power distribution systems using moving sum approach." *IET Science, Meas. & Technology*, vol. 12, no. 1, pp. 1-8, 2017.
- [46] M, Marek, et al, "New ANN-based algorithms for detecting HIFs in multigrounded MV networks." *IEEE Trans. Power Deliv*, 2.1, 58-66, 2017.
- [47] S. Chakraborty, S. Das, "Application of Smart Meters in High Impedance Fault Detection on Distribution Systems," *IEEE Trans. Smart Grid*, vol. 10, no. 3, pp. 3465-3473, 2018.
- [48] Texas A&M University, <https://www.tamu.edu>.
- [49] ASEA Brown Boveri (ABB), <https://new.abb.com>.
- [50] Siemens, <https://new.siemens.com>.
- [51] Schweitzer Engineering Laboratories (SEL), <https://selinc.com>.
- [52] W. Mingjie, et al. "Distortion-Controllable Arc Modelling for High Impedance Arc Fault at the Distribution Network." *IEEE Transactions on Power Delivery* (2020).

## **8. Appendix C: Eagle Rock Analytics Analysis on Weather Stations**

# Weather station optimization

Developed in support of EPC-18-026  
Owen Doherty, PhD  
Grace Di Cecco, PhD



# Project goals

- Given existing networks of weather stations, evaluate how well these networks capture the diversity of climate conditions within IOU territories
  - Also conducted analyses at fire weather region level and statewide
- Capture analysis results in a single index that can be used for prioritization decisions

# Methods: climate data

- BioClim variables
  - 19 variables at 1km x 1km resolution
  - Captures annual mean conditions, seasonality, and extremes or limiting conditions in temperature and precipitation
  - Based on 30-year climate normals (1971-2000)

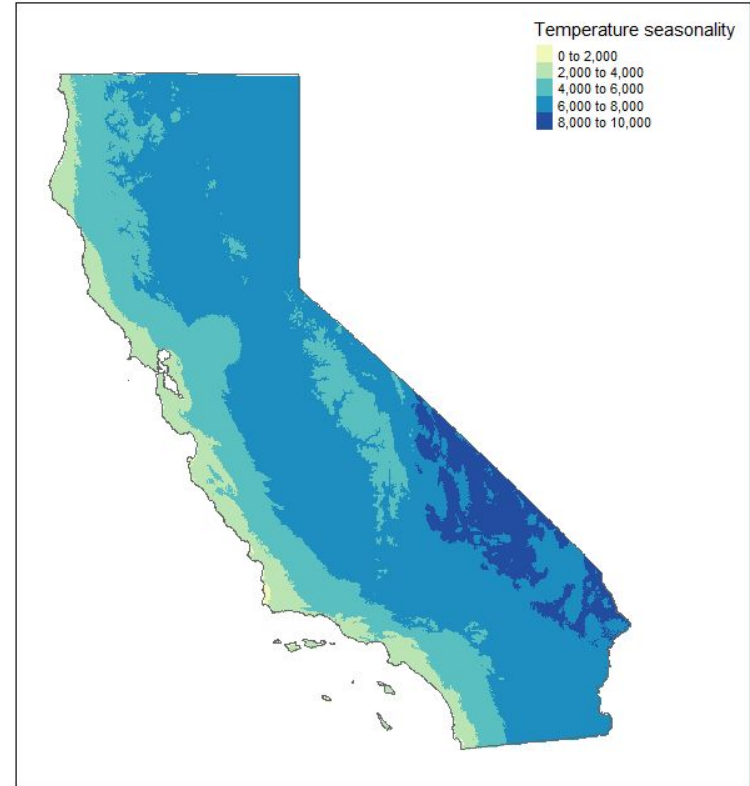

Example BioClim variable: std deviation of temperature x 100

# Methods: similarity score

- MaxEnt algorithm
  - Based on BioClim variables at sites with and without weather stations (black dots on right)
  - Machine learning classification algorithm to sort sites with and without weather stations
  - Lower likelihood of wx station presence = lower similarity in climate conditions to areas with stations

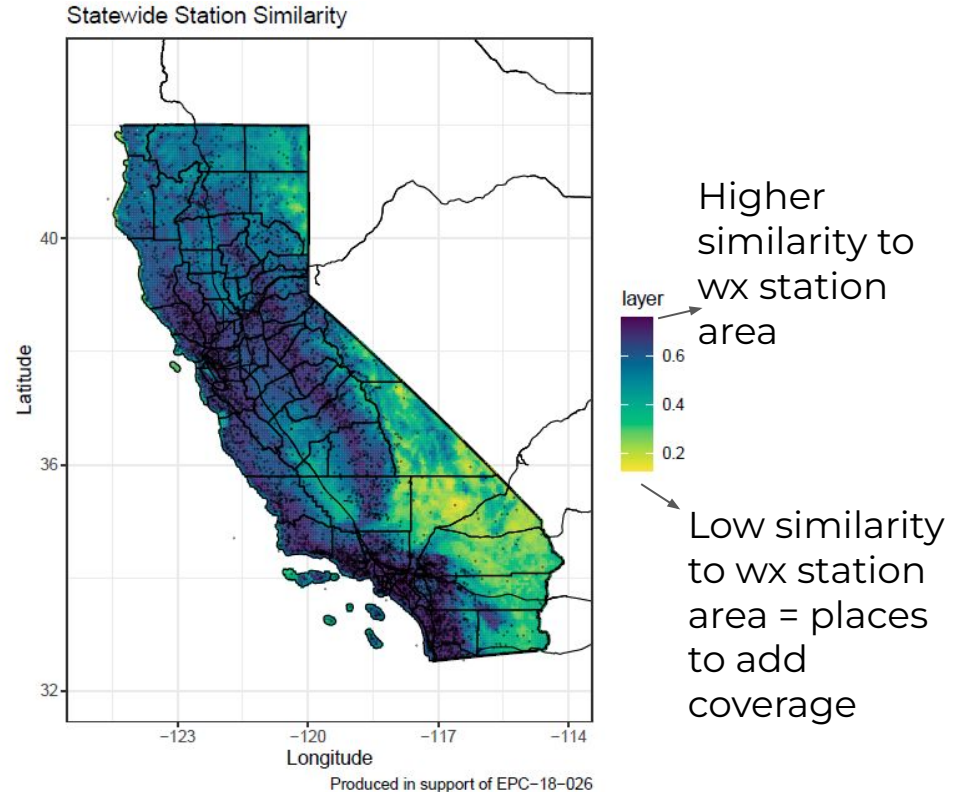



# Liberty Utilities results

Similarity Score For Liberty Utilities  
Weather Station Quality Threshold 2 of 5: iou/state

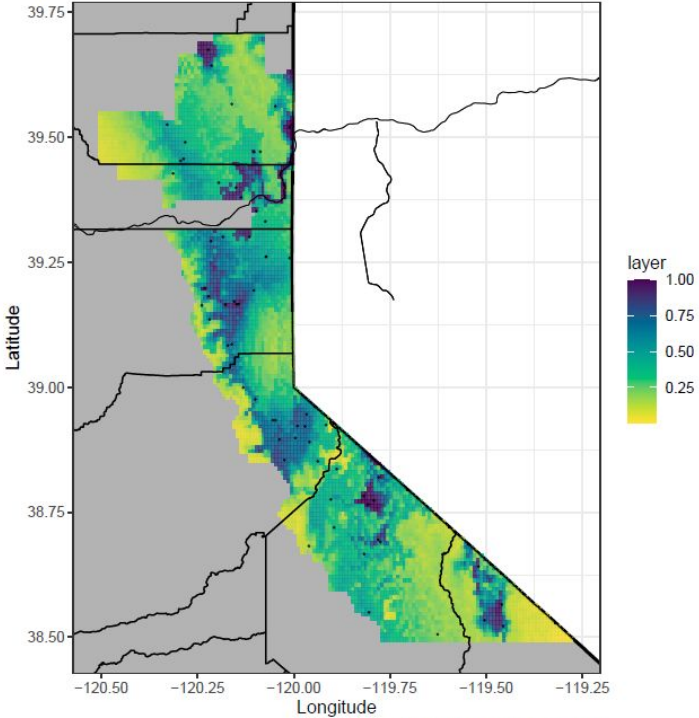

Pyregence.org [EPC-18-026]



# Possible updates to analysis or next steps

- Re-run model to evaluate potential sites with weather station optimization algorithm to identify which improve climate conditions captured the most
- Consider alternative input variables if a gridded data source is available
- Rasters of similarity score outputs available now from Pyregence FTP site

**9. Appendix D: Scope of Work for Weather Station Maintenance and Calibration**

## Proposal for Liberty Utilities

### I. Specification:

This proposal is for the survey of existing Liberty Utilities weather stations, 34 surveys.

Western Low Voltage (WLV) fixed bundled rate includes all costs for ground support technicians to survey the weather stations, and project management associated with this work.

Technician Qualifications of WLV Technician:

- General knowledge of telecommunications operations and principles
- General knowledge of AC/DC principles and power systems
- Valid driver's license/commercial driver's license as needed, and ability operate a motor vehicle
- WWG/WLV trained ground technician

### II. Regions of Work:

Work to be executed prioritizing from Southern to Northern regions

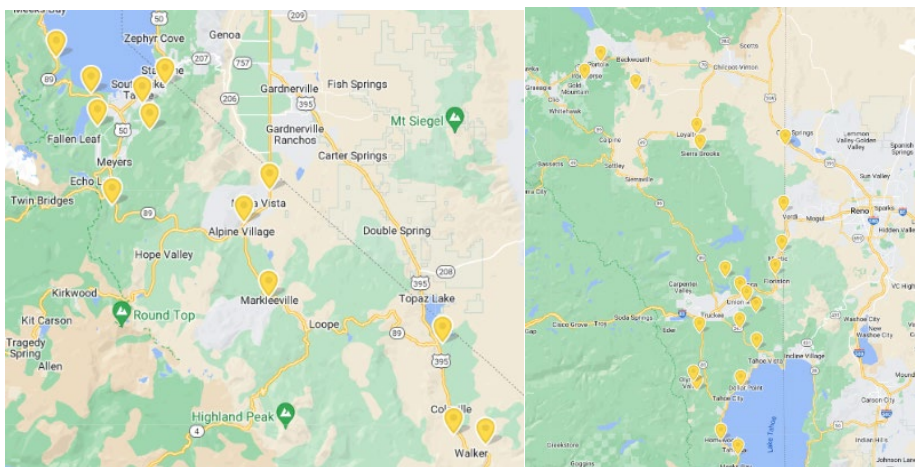

Figure 1: Southern and Northern Regions

### III. Schedule:

The work will be completed Monday-Sunday between 6am and 6pm.

A proposed schedule for all work will be provided 1 weeks before work starts. This schedule will be subject to change pending weather, station work completion rate and other variables.

Weekly schedules will be shared 1 week in advance of the work once started and will provide updated schedules as needed.

Weekly schedules will include:

- Updated SOW Summary table with updated Schedule Target Completion column
- Excel summary of upcoming 2 weeks of work (see appendix B)

Target Completion to be 30 days after start of work.

### IV. Invoicing:

The invoicing will monthly. We will invoice for completed scope and request 30 day payment terms.

Completions for invoicing will be documented by submittal of:

- Survey datasheets (blue portions only)

### V. Procedures/ Deliverables:

- Survey datasheets
- Photos of stations from 2-4 sides pending safety and private land considerations
- Sololocator photos, timestamped, with bearing and GPS Lat/Long (Cell service permitting)

Electronic Copies will be provided for items agreed upon in this SOW above. The default delivery method will be emailing summaries and SharePoint links.

APPENDIX

A. Draft Pricing

<b>Liberty Energy DRAFT PRICING PENDING SOW FINAL ALIGNMENT</b>				
*Discounts provided for multi-year contracts with 5-15% decrease in pricing after 1st year. To be evaluated after first year calibrations/ SOW is completed.				
South and North	Task	Qty By Year	Cost	Totals
	Surveys		34 \$ 400	\$ 13,600
	Total			\$ 13,600

Figure 1: Draft Pricing

B. Weekly updated schedule with 2-week lookahead

May 2023

SUNDAY	MONDAY	TUESDAY	WEDNESDAY	THURSDAY	FRIDAY	SATURDAY
14	15	16	17	18	19	20
Stations: XX, XX, XX, XX,	Stations: XX, XX, XX, XX,	Stations: XX, XX, XX, XX,	Stations:	Stations: XX, XX, XX, XX,	Stations: XX, XX, XX, XX,	Stations: XX, XX, XX, XX,
21	22	23	24	25	26	27
Stations: XX, XX, XX, XX,	Stations: XX, XX, XX, XX,	Stations: XX, XX, XX, XX,	Stations: XX, XX, XX, XX,	Stations: XX, XX, XX, XX,	Stations: XX, XX, XX, XX,	

Figure 2: 2-Week Schedule

C. Survey Example (will include detailed GPS/Bearing/Timestamped photos of existing and proposed locations pending survey type requested):

Station Name		Date	
Lat.			
Long.			
Site Access Notes			
		Item Present?	Repair needed?
		Y	N
		Y	N
Station Condition	Rain Gauge (RG)		
	Temp/Humidity (T/H)		
	Anemometer (A)		
	Fuel Moisture (FM)		
	Fuel Temp (FT)		
	Solar Panel (SP) (+ direction)		
	Guard or conduit over cables (U/C to ground or sensors)		
Calibration Access Existing	height (+/- 1.6 ft)		Comments
	Top Sensor		
	Bottom Sensor		
	Telecoms		
	Neutral		
	Cabinet Height		
	Lowest Utility Line		
	Horizontal Offset		
General Notes/Comments			
		Photo? (Y/N)	Comments
Sololocator Photos	Bearing 1		
	Bearing 2		
	Bearing 3		
	Bearing 4		
	Overview		
Equipment Photos	Sensor Arm		
	Ground sensors		
	Box and Solar panel		
	Photos with Bearing/GPS from 3-4 varying cardinal directions. *NOTE in some cases private property, proximity to traffic, or other obstructions prevent us from not being able to get photos form all sides of the station. Thereis no gaurantee that we will be able to get photos form all sides of a station.		



Principle Address:  
38243 Middle Ridge RD  
Lebanon OR 97355 USA  
Western Lovo Inc. California  
Principle Address:  
485 Jil AV  
Bay Point CA 94565 USA

*Figure 3: Survey Datasheet Example*



## Proposal for Liberty Utilities

### I. Specification:

This proposal is for the calibration, survey, and addition of a Fuel sensor on existing Liberty Energy weather stations. For this proposal, these stations are broken into 2 regions.

- 34 Calibrations and repairs as needed
- Optional Scope:
  - Relocation service options can be provided with post calibrations, or with a pre-survey of the locations. Western Weather Group (WWG) currently does not have enough data to propose this.
  - Repairs (calibrations may be limited or ineffective if the station is not in working order
  - Installation option (Liberty to provide any Pole specification and installation procedure)

Western Low Voltage (WLV) fixed bundled rate includes all costs for Technicians, QTW or QEW, which includes meals and lodging. Rate is all inclusive and includes cost of insulated bucket truck, which includes all fuel, tires, maintenance and or repair of bucket truck as needed and any other associated vehicle costs. Rate also includes providing all tools needed to survey, calibrate, and repair weather stations.

WWG will provide sparing for the work on weather stations. Liberty Energy will pay for any approved sparing necessary for repairs direct to WWG.

WLV will provide QTW or QEW (telecommunications tech or linemen and pay for all wages, compensation, per-diem and associated costs for linemen.

WLV is responsible for all material and hardware once the material is delivered or picked up from Liberty Energy or Western Weather Group (WWG). WLV will be responsible for returning any unused material or hardware to a Liberty Energy or WWG warehouse.

Technician Qualifications of WLV Technician:

- General knowledge of telecommunications operations and principles
- Valid driver's license/commercial driver's license as needed and ability to work from a bucket truck.
- WWG/WLV trained ground technician

Western Low Voltage Supplied Lineman and/or Telecommunications technician:

- Availability- 12-hour days with more authorized if needed to finish work. Monday-Saturday schedule. Sundays could be used with the manager's approval.

#### Telecommunications Technician Qualifications:

- General knowledge of telecommunications operations and principles
- General knowledge of AC/DC principles and power systems
- Valid driver's license/commercial driver's license and ability to work from a bucket truck
- Qualified communication electrician with at least two years of experience in that classification
  - Depending on experience may be required to have a valid FCC general class radiotelephone operator's license or valid NABER or NARTE certification.

#### Minimum Working Distances for Telecommunications Technician:

- Adhere to National Electric Safety Code (NESC) table 124-1 Clearance from Live Parts during weather station calibration and/or maintenance repairs.
  - 12/15kV System
    - Vertical Clearance of Unguarded Parts
      - 9 ft
    - Horizontal Clearance of Unguarded Parts
      - 3 ft 6 in
  - 25kV System
    - Vertical Clearance of Unguarded Parts
      - 9 ft 3in
    - Horizontal Clearance of Unguarded Parts
      - 3 ft 9 in
  - 35kV System
    - Vertical Clearance of Unguarded Parts
      - 9 ft 6 in
    - Horizontal Clearance of Unguarded Parts
      - 4 ft

QEW/ Lineman Qualifications: If weather station is within the electrical space and cannot adhere to the minimum clearance requirements established in NESC table 124-1. In this case a journeyman level lineman or equivalent experienced QEW will do the calibrations. This lineman will be approved by IBEW 1245.

## II. Regions of Work:

Work to be executed prioritizing from Southern to Northern regions

### Southern Region:

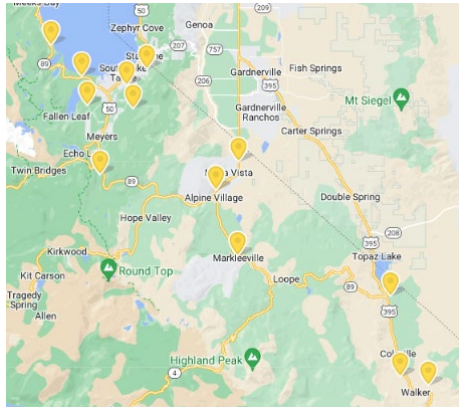

### Northern Region:

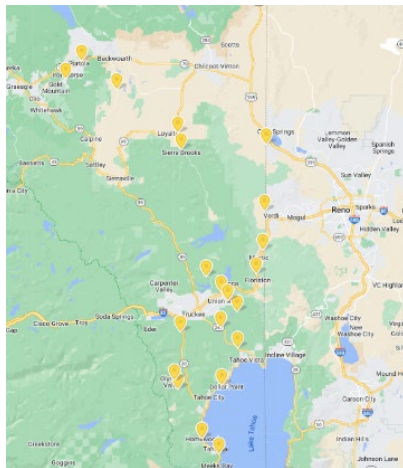



Principle Address:  
 38243 Middle Ridge RD  
 Lebanon OR 97355 USA  
 Western Lovo Inc. California  
 Principle Address:  
 485 Jil AV  
 Bay Point CA 94565 USA

III. Station Repair Scope of Work Summary:

Station Name	Preliminary Schedule Target Completion	Latitude	Longitude	Serial Number/ Station code	Survey	Calibration	Repair	Pole Voltage	Elev. (ft)
GLS7600-Walden		39.3313950	-120.0738600	LIB-3101	TBD	Yes	system power check/ replace battery; modem check		6836
TAH7300-DL Bliss		38.9756123	-120.1002738	LIB-3102	TBD	Yes			6827
MUL1296-Woodfords		38.7826498	-119.8178619	LIB-3103	TBD	Yes			5529
BKY4201-Summit		39.2611958	-120.0720169	LIB-3104	TBD	Yes	system power check/ replace battery		7205
TPZ1261-Park Ranch		38.6412031	-119.5202320	LIB-3105	TBD	Yes			5047
TPZ1261-Walker		38.5339241	-119.5041624	LIB-3106	TBD	Yes	system power check/ replace battery		5484
Meyers3400-Uplands		38.8956320	-120.0374430	LIB-3107	TBD	Yes			6965
111Line-Columbine Trail		38.8906167	-119.9596544	LIB-3108	TBD	Yes	system power check/ replace battery; Systems check, wiring check,		6496



Principle Address:  
 38243 Middle Ridge RD  
 Lebanon OR 97355 USA  
 Western Lovo Inc. California  
 Principle Address:  
 485 Jil AV  
 Bay Point CA 94565 USA

							tem sensor, rain gauge.		
POR31-Iron Horse		39.7789752	-120.5028402	LIB-3109	TBD	Yes	system power check/ replace battery		5001
619Line-Sierra Valley West		39.7593701	-120.3740839	LIB-3110	TBD	Yes			4884
SQV8200-Squaw Valley		39.1984658	-120.2303231	LIB-3111	TBD	Yes			6200
CEM41-Garbage Pit Rd		39.67508348	-120.2219678	LIB-3112	TBD	Yes			5013
CAL204-Dog Valley		39.5248552	-120.0044286	LIB-3113	TBD	Yes			4987
TRK7203-Northstar Golf Course		39.3006112	-120.1155367	LIB-3114	TBD	Yes			5848
Hobart Sub		39.39920727	-120.1499195	LIB-3115	TBD	Yes			5856
SRB51-Smithneck Rd		39.6434879	-120.2137370	LIB-3116	TBD	Yes			5190
TRK7202-Cabin Tree		39.29200719	-120.2151983	LIB-3117	TBD	Yes	system power check/ replace battery		6305
Muller1296-Emigrant Trail		38.8199467	-119.7794951	LIB-3118	TBD	Yes			5006



Principle Address:  
 38243 Middle Ridge RD  
 Lebanon OR 97355 USA  
 Western Lovo Inc. California  
 Principle Address:  
 485 Jil AV  
 Bay Point CA 94565 USA

STL3101 Ledge Ct.		38.9430511	-119.9357251	LIB-3119	TBD	Yes			6858
TAH7300- Homewood		39.08579117	-120.161063	LIB-3120	TBD	Yes			6240
7400-Glen Shire		39.3520770	-120.0974000	LIB-3121	TBD	Yes			5872
MEY3300- Grass Lake Road		38.8033820	-120.0156489	LIB-3122	TBD	Yes	system power check/ replace battery		6462
WSH201- Floriston		39.4047949	-120.0254608	LIB-3123	TBD	Yes			5240
Washoe204- Fariad		39.44982692	- 120.00981206994	LIB-3124	TBD	Yes			5265
MEY3400- Camp Richardson		38.93403398	-120.0474929	LIB-3125	TBD	Yes			6265
MEY3500- STPD Office		38.9216	-119.971	LIB-3126	TBD	Yes			6253
621-Mine I- 80 Gravel Pit		39.3693500	-120.1136120	LIB-3127	TBD	Yes			5606
7201-Alpine Meadows		39.1816896	-120.2214429	LIB-3128	TBD	Yes	system power check/ replace battery		6458
MUL1296- Markleyville		38.6946224	-119.7806787	LIB-3129	TBD	Yes			5534
TPZ1261- Eastside Lane		38.5219480	-119.4560856	LIB-3130	TBD	Yes			5519
TAH-5201 Lake Forest		39.1887565	-120.1127945	LIB-3132	TBD	Yes			6325



Principle Address:  
 38243 Middle Ridge RD  
 Lebanon OR 97355 USA  
 Western Lovo Inc. California  
 Principle Address:  
 485 Jil AV  
 Bay Point CA 94565 USA

Tahoe-7300 Sugar Pine Point		39.0558915	-120.1187513	LIB-3133	TBD	Yes			6329
SOK-257 Reno Park		39.6535427	-120.0009687	LIB-3134	TBD	Yes			5195
POR32 4th Avenue		39.8134331	-120.4623821	LIB-3140	TBD	Yes			4901

Figure 1- Scope of Work Summary Table

#### IV. Schedule:

The work will be completed Monday-Sunday between 6am and 6pm.

A proposed schedule for all work will be provided 2 weeks before work starts. This schedule will be subject to change pending weather, station work completion rate and other variables.

Weekly schedules will be shared 1 week in advance of the work once started and will provide updated schedules as needed.

Weekly schedules will include:

- Updated SOW Summary table with updated Schedule Target Completion column
- Excel summary of upcoming 2 weeks of work (see appendix B)

Target Completion Schedules:

- All stations to be completed by XXX-TBD with prioritizations from Southern to Northern locations.

#### V. Invoicing:

The invoicing will be bi-weekly or monthly.

Completions for invoicing will be documented by submittal of:

- Calibrations datasheet (see appendix D)
- GPS and date/timestamped station photo
- Any additional survey or repair data sheets

#### VI. Procedures/ Deliverables:

1. Procedures: (Procedures will be forwarded to Liberty Energy PM for approval once completed)
  - Calibration Procedures with Datasheet for documentation of results
2. Survey Report (See appendix C):
  - GPS and bearing photos including Equipment, pole and surrounding areas
  - Alternate pole selection photos and location (if requested)
  - Station access notes
  - NESC serviceability criteria for current service or future counting purposes
  - Pole marking if requested.
  - See (Appendix item XX)
3. Repair documentation
  - Photos, repair notes

Electronic Copies will be provided bi-weekly of items agreed upon in for this SOW above. The default delivery method will be email summaries for invoicing and native files in zip drive or hard drives by mail.



APPENDIX

A. Draft Pricing:

Pending review and discussion of SOW

<b>Liberty Energy DRAFT PRICING PENDING SOW FINAL ALIGNMENT</b>				
*Discounts provided for multi-year contracts with 5-15% decrease in pricing after 1st year. To be evaluated after first year calibrations/ SOW is completed.				
South and North	Task	Qty By Year	Cost	Totals
	Calibrate	34	\$ 1,800	\$ 61,200
	Lineman training (per lineman)	TBD	\$ 3,500	TBD
	Ground Technician	2	\$ 4,500	\$ 9,000
	Installation	TBD	\$ 3,500	
	<b>Total</b>			<b>\$ 61,200</b>
	Repairs or sensor installations on calibrations jobs (Rain Gauge Bracket, Fuel sensor, Temp/RH sensor, Soil Moisture, Battery, Site preparation- all these take ~1 hour)	TBD	\$ 300/hr.	Total TBD off actual work done
	<b>Total Repair Estimated</b>	30	300	<b>\$ 9,000</b>
	Cost for used spare parts (Liberty to buy from WWG direct)		NA	NA
	<b>Total (with estimsted repair scope)</b>			<b>\$ 70,200</b>
	Flat fixed rate for failed attempt due to lack of access beyond our control (Weather, private access, or other significant reason- documentation will be provided in this instance with GPS stamped photo and access notes)		\$ 300	TBD

Figure 2: Draft Pricing

B. Weekly updated schedule with 2-week lookahead

May 2023

SUNDAY	MONDAY	TUESDAY	WEDNESDAY	THURSDAY	FRIDAY	SATURDAY
14 Stations: XX, XX, XX, XX,	15 Stations: XX, XX, XX, XX,	16 Stations: XX, XX, XX, XX,	17 Stations:	18 Stations: XX, XX, XX, XX,	19 Stations: XX, XX, XX, XX,	20 Stations: XX, XX, XX, XX,
21 Stations: XX, XX, XX, XX,	22 Stations: XX, XX, XX, XX,	23 Stations: XX, XX, XX, XX,	24 Stations: XX, XX, XX, XX,	25 Stations: XX, XX, XX, XX,	26 Stations: XX, XX, XX, XX,	27

Figure 3: 2-Week Schedule

C. Survey Example (will include detailed GPS/Bearing/Timestamped photos of existing and proposed locations pending survey type requested):

Figure 4: Survey Datasheet Example

D. Calibration Datasheet:

**XXX**

**Automated Meteorological Monitoring Station  
Calibration-Maintenance Worksheet (WWG 530-342-1700)**

Western Wx ID \_\_\_\_\_ Station Name: \_\_\_\_\_  
Performed by: \_\_\_\_\_ Date / Time: \_\_\_\_\_

Wind Direction Orientation - Check on the ground <i>before</i> doing calibration		
Sensor Orientation Check to True North	Yes / No ?	Error should be < +/- 5 degrees
Junction plate on wind sensor should be facing True South. Check w/GPS hand unit &/or Compass App on phone. <b>Correct orientation is CRITICAL</b> for accurate Wind Dir readings.		

With Keypad, on station datalogger, set Cal\_Timer (in Public Table) to 1 - Make sure station clock and cal kit clock are sync'd

**RM Young Wind Monitor - Wind Speed and Wind Direction Performance**

Wind Vane 180° Check	
<i>Dir Reading when pointed South</i>	
Before Removal	After Testing

**Torque Test**

Use 1 gram metal screw @ 1cm on torque disc  
Does the disc turn ( Yes / No )? If No, call Western Weather

WIND SPEED			
Test Points	RPM	MPH Ref	MPH Stn
1	0	0.000	
2	200	3.726	
3	300	5.589	
4	500	9.315	
5	1000	18.630	
6	2000	37.260	
7	3000	55.890	
8	4000	74.520	

Check Wind Speed & Wind Dir in the Public Table

WIND DIRECTION		
Ref Angle	Rotation (+- 5°)	Dir Bearing
0	Start @ 0 degrees	
45	cw	
90	cw	
135	cw	
180	cw	
225	cw	
270	cw	
315	cw	
355	cw	
0	cw	
355	ccw	
315	ccw	
270	ccw	
225	ccw	
180	ccw	
135	ccw	
90	ccw	
45	ccw	
0	ccw	

√ in MPH Stn Column indicates exact match w/ Ref

Rain Gauge - TE-525USW				
Gauge Test	Millimeters H2O	Inches Ref	Inches Station	
1	412	0.50	.48-.52?	Yes / No?

Fuel Temp/Moisture & Soil Moisture Check				
New Stick?	Fuel T (°)	Fuel M (%)	Soil Moist.	Soil Temp.
Yes / No				

If Rain Gauge test fails, adjust to meet spec. If Fuel or Soil sensors appear faulty, Call Western Weather

**Temperature & RH Test**

Use Cal\_Data Tables to get 2min Avgs

Sensor	Model No:
Temperature (°F)	EE181
Rel Humidity (%)	EE181

Station Sensor Performance vs Reference Sensor (2 minute Avg)						
Test			To pass	Test After Replacement		
Station Value	Reference Value	Diff	Factory Spec.	Station Value	Reference Value	Diff
			± 1.8°F			
			± 5%			

Replace IF existing sensor fails

Upon completion, call Western Weather Group - they will verify communications with check datalogger for errors.

Figure 5: Calibration Datasheet



Principle Address:  
38243 Middle Ridge RD  
Lebanon OR 97355 USA  
Western Lovo Inc. California  
Principle Address:  
485 Jill AV  
Bay Point CA 94565 USA

E. Repair Datasheet:

XXX\_TBD

*Figure 6: Repair Datasheet*

## **10. Appendix E: Weather Station Calibrations Completed in 2024**

Station ID	Station Name and Location	Calibration Date	All Test Pass	Battery Replaced	Fuel Installed	Fuel Replaced	Cell Wire Updated	Temp Wire Updated	Resistor Added	Modem Updated	Sensor Power Check	Polling Method	Default Program	Rain Updated	Batt Type
LIB-3101	GLS7600-Walden	8/3/2024	No	Battery healthy; not needed	Yes, Fuel Moisture Only	Yes, Sticks Replaced	Yes, moved wire	Yes, moved wire	Yes, added	Yes	Comms/Power data verified	Websocket	Yes	Yes	SLA
LIB-3102	TAH7300-DL Bliss	7/26/2024	Yes	Battery healthy; not needed	Yes, Fuel Moisture Only	Yes, Sticks Replaced	Yes, moved wire	Yes, moved wire	Yes, added	Yes	Comms/Power data verified	Websocket	Yes	Yes	SLA
LIB-3103	MUL1296-Woodfords	7/24/2024	Yes	Battery healthy; not needed	Yes, Fuel Moisture Only	Yes, Sticks Replaced	Not needed; already moved	Yes, moved wire	Yes, added	Yes	Comms/Power data verified	Websocket	Yes	Yes	SLA
LIB-3104	BKY4201-Summit	8/3/2024	Yes	Battery healthy; not needed	Yes, Fuel Moisture Only	Yes, Sticks Replaced	Yes, moved wire	Yes, moved wire	Yes, added	Yes	Comms/Power data verified	Websocket	Yes	Yes	SLA
LIB-3105	LIB-3105 - TPZ1261-Park Ranch	7/23/2024	Yes	Battery healthy; not needed	Yes, Fuel Moisture Only	Yes, Sticks Replaced	Already Done	Yes	Yes	Yes	Comms/Power data verified	Websocket	Yes	Yes	SLA
LIB-3106	TPZ1261-Walker	7/23/2024	Yes	Yes, replaced	Yes, Fuel Moisture Only	Yes, Sticks Replaced	Already Done	Already done	Yes	Yes	Comms/Power data verified	Websocket	Yes	Yes	SLA
LIB-3107	Meyers3400-Uplands	7/26/2024	No	Battery healthy; not needed	Yes, Fuel Moisture Only	Yes, Sticks Replaced	Yes, moved wire	Yes, moved wire	Yes, added	Yes	Comms/Power data verified	Websocket	Yes	Yes	SLA
LIB-3108	111Line-Columbine Trail	7/25/2024	Yes	Yes, replaced	Yes, Fuel Moisture Only	Yes, Sticks Replaced	Not needed; already moved	Not needed; already moved	Yes, added	Yes	Comms/Power data verified	Websocket	Yes	No	SLA
LIB-3109	POR31-Iron Horse	7/30/2024	Yes	Yes, replaced	Yes, Fuel Moisture Only	Not Replaced during calibration	Yes, moved wire	Yes, moved wire	Yes, added	Yes	Comms/Power data verified	Websocket	Yes	No	SLA
LIB-3110	619Line-Sierra Valley West	7/30/2024	Yes	Battery healthy; not needed	Yes, Fuel Moisture Only	Yes, Sticks Replaced	Yes, moved wire	Yes, moved wire	Yes, added	Yes	Comms/Power data verified	Websocket	Yes	No	SLA
LIB-3111	SQV8200-Squaw Valley	8/1/2024	No	Battery healthy; not needed	Yes, Fuel Moisture Only	Yes, Sticks Replaced	Yes, moved wire	Yes, moved wire	Yes, added	Yes	Comms/Power data verified	Websocket	Yes	Yes	SLA
LIB-3112	CEM41-Garbage Pit Rd	7/30/2024	No	Battery healthy; not needed	Yes, Fuel Moisture Only	Yes, Sticks Replaced	Yes, moved wire	Yes, moved wire	Yes, added	Yes	Comms/Power data verified	Websocket	Yes	Yes	SLA
LIB-3113	CAL204-Dog Valley	7/31/2024	Yes	Battery healthy; not needed	Yes, Fuel Moisture Only	Yes, Sticks Replaced	Yes, moved wire	Yes, moved wire	Yes, added	Yes	Comms/Power data verified	Websocket	Yes	No	SLA
LIB-3114	TRK7203-Northstar Golf Course	8/3/2024	Yes	Battery healthy; not needed	Yes, Fuel Moisture Only	Yes, Sticks Replaced	Yes, moved wire	Yes, moved wire	Yes, added	Yes	Comms/Power data verified	Websocket	Yes	Yes	SLA
LIB-3115	Hobart Sub	8/2/2024	Yes	Battery healthy; not needed	Yes, Fuel Moisture Only	Yes, Sticks Replaced	Yes, moved wire	Yes, moved wire	Yes, added	Yes	Comms/Power data verified	Websocket	Yes	Yes	SLA
LIB-3116	SRB51-Smithneck Rd	8/2/2024	Yes	Battery healthy; not needed	Yes, Fuel Moisture Only	Yes, Sticks Replaced	Yes, moved wire	Yes, moved wire	Yes, added	Yes	Comms/Power data verified	Websocket	Yes	Yes	SLA
LIB-3117	TRK7202-Cabin Tree	8/1/2024	Yes	Yes, replaced	Yes, Fuel Moisture Only	Yes, Sticks Replaced	Yes, moved wire	Yes, moved wire	Yes, added	Yes	Comms/Power data verified	Websocket	Yes	No	SLA
LIB-3118	Muller1296-Emigrant Trail	7/24/2024	No	Battery healthy; not needed	Yes, Fuel Temp & Moisture	Yes, Sticks Replaced	Not needed; already moved	Yes, moved wire	Yes, added	Yes	Comms/Power data verified	Websocket	Yes	No	SLA
LIB-3119	STL3101 Ledge Ct.	7/25/2024	Yes	Battery healthy; not needed	Yes, Fuel Moisture Only	Yes, Sticks Replaced	Yes, moved wire	Yes, moved wire	Yes, added	Yes	Comms/Power data verified	Websocket	Yes	Yes	SLA
LIB-3120	TAH7300-Homewood	7/27/2024	Yes	Battery healthy; not needed	Yes, Fuel Temp & Moisture	Not Replaced during calibration	Yes, moved wire	Yes, moved wire	Yes, added	Yes	Comms/Power data verified	Websocket	Yes	No	SLA
LIB-3121	7400-Glen Shire	8/3/2024	Yes	Battery healthy; not needed	Yes, Fuel Moisture Only	Yes, Sticks Replaced	Yes, moved wire	Yes, moved wire	Yes, added	Yes	Comms/Power data verified	Websocket	Yes	Yes	SLA
LIB-3122	MEY3300-Grass Lake Road	7/25/2024	Yes	Yes, replaced	Yes, Fuel Temp & Moisture	Yes, Sticks Replaced	Yes, moved wire	Yes, moved wire	Yes, added	Yes	Comms/Power data verified	Websocket	Yes	No	SLA
LIB-3123	WSH201-Floriston	7/31/2024	Yes	Battery healthy; not needed	Yes, Fuel Moisture Only	Yes, Sticks Replaced	Yes, moved wire	Yes, moved wire	Yes, added	Yes	Comms/Power data verified	Websocket	Yes	Yes	SLA
LIB-3124	Washoe204-Fariad	7/31/2024	Yes	Battery healthy; not needed	Yes, Fuel Moisture Only	Yes, Sticks Replaced	Yes, moved wire	Yes, moved wire	Yes, added	Yes	Comms/Power data verified	Websocket	Yes	Yes	SLA
LIB-3125	MEY3400-Camp Richardson	7/26/2024	Yes	Battery healthy; not needed	Yes, Fuel Moisture Only	Yes, Sticks Replaced	Yes, moved wire	Yes, moved wire	Yes, added	Yes	Comms/Power data verified	Websocket	Yes	Yes	SLA
LIB-3126	MEY3500-STPD Office	7/26/2024	Yes	Battery healthy; not needed	Yes, Fuel Moisture Only	Yes, Sticks Replaced	Yes, moved wire	Yes, moved wire	Yes, added	Yes	Comms/Power data verified	Websocket	Yes	Yes	SLA
LIB-3127	621-Mine I-80 Gravel Pit	7/31/2024	No	Battery healthy; not needed	No Fuel Sensors Installed	No Fuel Sensors Installed	Yes, moved wire	Yes, moved wire	Yes, added	Yes	Comms/Power data verified	Websocket	Yes	Yes	SLA
LIB-3128	7201-Alpine Meadows	8/1/2024	Yes	Yes, replaced	Yes, Fuel Moisture Only	Yes, Sticks Replaced	Yes, moved wire	Yes, moved wire	Yes, added	Yes	Comms/Power data verified	Websocket	Yes	Yes	SLA
LIB-3129	MUL1296-Markkeyville	7/24/2024	Yes	Battery healthy; not needed	No Fuel Sensors Installed	No Fuel Sensors Installed	Not needed; already moved	Yes, moved wire	Yes, added	Yes	Comms/Power data verified	Websocket	Yes	Yes	SLA
LIB-3130	TPZ1261-Eastside Lane	7/23/2024	No	Battery healthy; not needed	Yes, Fuel Moisture Only	Yes, Sticks Replaced	Yes, moved wire	Yes, moved wire	Yes, added	Yes	Comms/Power data verified	Websocket	Yes	Yes	LiFePo
LIB-3131	MEY3300-Tolteca	7/25/2024	Yes	Battery healthy; not needed	No Fuel Sensors Installed	No Fuel Sensors Installed	Not needed; already moved	Not needed; already moved	Yes, added	Yes	Comms/Power data verified	Websocket	Yes	Yes	LiFePo
LIB-3132	TAH5201 Lake Forest	8/1/2024	Yes	Battery healthy; not needed	Yes, Fuel Moisture Only	Yes, Sticks Replaced	Yes, moved wire	Yes, moved wire	Not needed; already wired	Yes	Comms/Power data verified	Websocket	Yes	No	LiFePo
LIB-3133	Tahoe-7300 Sugar Pine Point	7/27/2024	No	Battery healthy; not needed	No Fuel Sensors Installed	No Fuel Sensors Installed	Not needed; already moved	Not needed; already moved	Not needed; already wired	Yes	Comms/Power data verified	Websocket	Yes	No	LiFePo
LIB-3134	SOK-257 Reno Park	7/29/2024	Yes	Battery healthy; not needed	No Fuel Sensors Installed	No Fuel Sensors Installed	Yes, moved wire	Yes, moved wire	Not needed; already wired	Yes	Comms/Power data verified	Websocket	Yes	Yes	LiFePo
LIB-3135	SMP8700-Firecamp	8/2/2024	No	Battery healthy; not needed	No Fuel Sensors Installed	No Fuel Sensors Installed	Yes, moved wire	Yes, moved wire	Not needed; already wired	Yes	Comms/Power data verified	Websocket	Yes	No	LiFePo
LIB-3137	TAH5201-Fairway	7/27/2024	Yes	Battery healthy; not needed	No Fuel Sensors Installed	No Fuel Sensors Installed	Not needed; already moved	Yes, moved wire	Not needed; already wired	Yes	Comms/Power data verified	Websocket	Yes	No	LiFePo
LIB-3138	LIB-3138 - TPZ1261 Cunningham	7/23/2024	Yes	Battery healthy; not needed	No Fuel Sensors Installed	No Fuel Sensors Installed	Yes, moved wire	Yes, moved wire	Yes, added	Yes	Comms/Power data verified	Websocket	Yes	Yes	LiFePo
LIB-3139	MUL1296-Sorensens	7/24/2024	Yes	Battery healthy; not needed	No Fuel Sensors Installed	No Fuel Sensors Installed	Not needed; already moved	Yes, moved wire	Yes, added	Yes	Comms/Power data verified	Websocket	Yes	Yes	LiFePo
LIB-3140	POR32 4th Avenue	7/30/2024	Yes	Battery healthy; not needed	No Fuel Sensors Installed	No Fuel Sensors Installed	Yes, moved wire	Yes, moved wire	Not needed; already wired	Yes	Comms/Power data verified	Websocket	Yes	Yes	LiFePo