



2023-2025 WILDFIRE MITIGATION PLAN

San Diego Gas & Electric
July 5, 2024 (Revision 5)



Table of Contents

1	EXECUTIVE SUMMARY	1
1.1	Summary of 2020–2022 WMP Cycle	1
1.1.1	Major Lessons Learned	4
1.1.1.1	Risk Methodology and Assessment	4
1.1.1.2	Wildfire Mitigation Strategy.....	5
1.1.1.3	Grid Design, Operations, and Maintenance.....	5
1.1.1.4	Vegetation Management and Inspections.....	6
1.1.1.5	Situational Awareness and Forecasting	6
1.1.1.6	Emergency Preparedness.....	7
1.1.1.7	Community Outreach and Engagement	7
1.1.1.8	PSPS.....	7
1.2	Summary of 2023–2025 Base WMP	8
1.2.1	Framework.....	8
1.2.2	Goal of the WMP.....	9
1.2.3	Plan Objectives.....	9
2	RESPONSIBLE PERSONS.....	11
3	STATUTORY REQUIREMENTS CHECKLIST	13
4	OVERVIEW OF WMP	16
4.1	Primary Goal	16
4.2	Plan Objectives.....	16
4.2.1	Risk Methodology and Assessment	16
4.2.2	Wildfire Mitigation Strategy.....	16
4.2.3	Grid Design, Operations, and Maintenance.....	17
4.2.4	Vegetation Management and Inspections.....	17
4.2.5	Situational Awareness and Forecasting	17
4.2.6	Emergency Preparedness.....	17
4.2.7	Community Outreach and Engagement	18
4.2.8	Public Safety Power Shutoff.....	18
4.3	Proposed Expenditures	18
4.4	Risk Informed Framework.....	19
4.4.1	Risk Assessment: Identification, Analysis, Evaluation, and Prioritization.....	21

4.4.2	Risk Strategy: Plan Development, Investment Decisions, Implementation, and Review ...	22
5	OVERVIEW OF THE SERVICE TERRITORY	25
5.1	Service Territory.....	25
5.2	Electrical Infrastructure	26
5.3	Environmental Settings.....	27
5.3.1	Fire Ecology	27
5.3.1.1	Ecological Regions.....	27
5.3.1.2	Climate and Weather Conditions.....	28
5.3.1.3	Fire Return Intervals.....	28
5.3.2	Catastrophic Wildfire History.....	29
5.3.3	High Fire Threat Districts.....	31
5.3.4	Climate Change	33
5.3.4.1	General Climate Conditions	33
5.3.4.2	Climate Change Phenomena and Trends.....	34
5.3.5	Topography	38
5.4	Community Values at Risk.....	39
5.4.1	Urban, Rural, and Highly Rural Customers.....	39
5.4.2	Wildland-Urban Interfaces.....	40
5.4.3	Communities at Risk from Wildfire	40
5.4.3.1	Individuals at Risk from Wildfire	40
5.4.3.2	Social Vulnerability and Exposure to Electrical Corporation Wildfire Risk	41
5.4.3.3	Sub-Divisions with Limited Egress or No Secondary Egress.....	42
5.4.4	Critical Facilities and Infrastructure at Risk from Wildfire	43
5.4.5	Environmental Compliance and Permitting.....	45
5.4.5.1	Processes to Ensure Compliance	45
5.4.5.1.1	Environmental Services.....	45
5.4.5.1.2	Programmatic Endangered Species Act Permitting/Authorization	45
5.4.5.1.3	Cultural Resources Program	47
5.4.5.1.4	Municipal and State Agency Permits	48
5.4.5.2	Overcoming Roadblocks.....	49
5.4.5.3	Notable Changes to Environmental Compliance and/or Permitting Procedures	50
6	RISK METHODOLOGY AND ASSESSMENT.....	51
6.1	Methodology.....	51

6.1.1	Overview	51
6.1.2	Summary of Risk Models.....	54
6.2	Risk Analysis Framework.....	59
6.2.1	Risk and Risk Component Identification	59
6.2.2	Risk and Risk Components Calculation	64
6.2.2.1	Likelihood	68
6.2.2.2	Consequence.....	70
6.2.2.3	Risk.....	72
6.2.3	Key Assumptions and Limitations	73
6.3	Risk Scenarios.....	75
6.3.1	Design Basis Scenarios	76
6.3.2	Extreme-Event/High Uncertainty Scenarios	79
6.4	Risk Analysis Results and Presentation.....	80
6.4.1	Top Risk Areas within the HFRA.....	81
6.4.1.1	Geospatial Maps of Top-Risk Areas within the HFRA	83
6.4.1.2	Proposed Updates to HFTD.....	83
6.4.2	Top Risk-Contributing Circuits/Segments/Spans	84
6.4.3	Other Key Metrics	90
6.4.3.1	FPI (WMP.450)	90
6.4.3.2	Red Flag Warning (WMP.082).....	90
6.4.3.3	High Wind Warnings	90
6.5	Enterprise System for Risk Assessment (WMP.1332).....	91
6.6	Quality Assessment and Control.....	92
6.6.1	Independent Review	92
6.6.2	Model Controls, Design, and Review	95
6.6.2.1	Modularization.....	95
6.6.2.2	Reanalysis.....	95
6.6.2.3	Version Control	96
6.7	Risk Assessment Improvement Plan.....	96
6.7.1	RA-1-A Evaluate Additional Wildfire and PSPS Risk Assessment Factors	100
6.7.1.1	Problem Statement.....	100
6.7.1.2	Planned Improvement	100
6.7.1.3	Anticipated Benefit	101

6.7.1.4	Region Prioritization.....	101
6.7.2	RA-1-B Enhance Model Design and Architecture	101
6.7.2.1	Problem Statement.....	101
6.7.2.2	Planned Improvement	101
6.7.2.3	Anticipated Benefit	101
6.7.3	RA-2-A Evaluate Design and Extreme-Event Scenarios.....	102
6.7.3.1	Problem Statement.....	102
6.7.3.2	Planned Improvement	102
6.7.3.3	Anticipated Benefit	102
6.7.4	RA-3-A Establish Process to Continuously Evaluate HFTD Boundaries.....	102
6.7.4.1	Problem Statement.....	102
6.7.4.2	Planned Improvement	103
6.7.4.3	Anticipated Benefit	103
6.7.5	RA-3-B Enhance Model Documentation	103
6.7.5.1	Problem Statement.....	103
6.7.5.2	Planned Improvement	103
6.7.5.3	Anticipated Benefit	103
6.7.6	RA-4-A Improve Procedure for Independent Reviews of Data and Models.....	103
6.7.6.1	Problem Statement.....	103
6.7.6.2	Planned Improvement	104
6.7.6.3	Anticipated Benefit	104
6.7.7	RA-4-B Enhance Model Validation Process.....	104
6.7.7.1	Problem Statement.....	104
6.7.7.2	Planned Improvement	104
6.7.7.3	Anticipated Benefit	104
6.7.8	RA-5-A Deploy and Enhance WiNGS-Ops and WiNGS-Planning Visualization Platforms .	105
6.7.8.1	Problem Statement.....	105
6.7.8.2	Planned Improvement	105
6.7.8.3	Anticipated Benefit	105
6.7.8.4	Region Prioritization.....	105
7	WILDFIRE MITIGATION STRATEGY DEVELOPMENT	106
7.1	Risk Evaluation	106
7.1.1	Approach.....	106

7.1.2	Key Stakeholders for Decision Making.....	106
7.1.3	Risk-Informed Prioritization	108
7.1.3.1	Selection of Areas for Mitigation	108
7.1.3.1.1	Geographic Scale used in Prioritization	108
7.1.3.1.2	Statistical Approach used to Select Candidates.....	108
7.1.3.1.3	Feasibility Constraints.....	109
7.1.3.2	Prioritized List of Risks	110
7.1.4	Mitigation Selection Process.....	110
7.1.4.1	Identifying and Evaluating Mitigation Initiatives	111
7.1.4.1.1	Procedures to Develop Mitigation Initiatives	111
7.1.4.1.2	Mitigation Initiatives that Address Local Wildfire Risk Drivers.....	111
7.1.4.1.3	Characterization of Uncertainties and Incorporation into the Decision-Making Process	112
7.1.4.1.4	Potential Mitigation Initiatives	112
7.1.4.1.5	MAVF and other Specific Risk Factors	114
7.1.4.2	Mitigation Initiative Prioritization.....	114
7.1.4.2.1	Evaluation of Potential Mitigation Initiatives	114
7.1.4.2.2	Identification of Mitigation Initiatives	115
7.1.4.2.3	Resource Optimization.....	118
7.1.4.2.4	Mitigation Initiative Prioritization to Reduce both Wildfire and PSPS Risk	120
7.1.4.3	Mitigation Initiative Scheduling	123
7.1.4.3.1	Mitigation Initiative Scheduling	123
7.1.4.3.2	Interim Mitigation Process.....	123
7.1.4.3.3	Monitoring Progress toward Targets with Known Limitations and Constraints.....	123
7.1.4.3.4	Measuring Effectiveness of Mitigation Initiatives	123
7.2	Wildfire Mitigation Strategy	124
7.2.1	Overview of Mitigation Initiatives and Activities	125
7.2.2	Anticipated Risk Reduction	127
7.2.2.1	Projected Overall Risk Reduction.....	127
7.2.2.2	Risk Impact of Mitigation Initiatives	129
7.2.2.3	Projected Risk Reduction on Highest-Risk Circuits Over the Three-Year WMP Cycle ..	131
7.2.3	Interim Mitigation Activities	133
8	WILDFIRE MITIGATIONS.....	135

8.1	Grid Design, Operations, and Maintenance.....	135
8.1.1	Overview	135
8.1.1.1	Objectives.....	137
8.1.1.2	Targets.....	147
8.1.1.3	Performance Metrics	151
8.1.1.3.1	Distribution Inspection Findings and Open Work Orders.....	153
8.1.1.3.2	Distribution Equipment related HFTD Ignitions and Outages Rate	154
8.1.1.3.3	Transmission Inspection Findings and Open Work Orders in HFTD	154
8.1.1.3.4	Transmission Equipment related HFTD Outages and Ignitions	155
8.1.2	Grid Design and System Hardening.....	156
8.1.2.1	Covered Conductor Installation (WMP.455).....	156
8.1.2.1.1	Utility Initiative Tracking ID.....	156
8.1.2.1.2	Overview of the Activity.....	156
8.1.2.1.3	Impact of the Activity on Wildfire Risk	157
8.1.2.1.4	Impact of the Activity on PSPS Risk.....	158
8.1.2.1.5	Updates to Initiative	158
8.1.2.2	Undergrounding of Electric Lines and/or Equipment (WMP.473).....	158
8.1.2.2.1	Utility Initiative Tracking ID.....	158
8.1.2.2.2	Overview of the Activity.....	158
8.1.2.2.3	Impact of the Activity on Wildfire Risk	159
8.1.2.2.4	Impact of the Activity on PSPS Risk.....	159
8.1.2.2.5	Updates to the Activity	160
8.1.2.3	Distribution Pole Replacements and Reinforcements (WMP.458).....	161
8.1.2.3.1	Utility Initiative Tracking ID.....	161
8.1.2.3.2	Overview of the Activity.....	161
8.1.2.3.3	Impact of the Activity on Wildfire Risk	162
8.1.2.3.4	Impact of the Activity on PSPS Risk.....	162
8.1.2.3.5	Updates to the Activity	162
8.1.2.4	Transmission Pole/Tower Replacements and Reinforcements (WMP.472).....	162
8.1.2.4.1	Utility Initiative Tracking ID.....	162
8.1.2.4.2	Overview of the Activity.....	162
8.1.2.4.3	Impact of the Activity on Wildfire Risk	162
8.1.2.4.4	Impact of the Activity on PSPS Risk.....	162

8.1.2.4.5	Updates to the Activity	163
8.1.2.5	Traditional Overhead Hardening	163
8.1.2.5.1	Distribution Overhead System Hardening (Traditional) (WMP.475).....	163
8.1.2.5.2	Transmission System Hardening Program (WMP.543, WMP.544, WMP.545).....	164
8.1.2.6	Emerging Grid Hardening Technology Installations and Pilots.....	167
8.1.2.7	Microgrids (WMP.462).....	167
8.1.2.7.1	Utility Initiative Tracking ID.....	167
8.1.2.7.2	Overview of the Activity.....	167
8.1.2.7.3	Impact of the Activity on Wildfire Risk	167
8.1.2.7.4	Impact of the Activity on PSPS Risk.....	167
8.1.2.7.5	Updates to the Activity	168
8.1.2.8	Installation of System Automation Equipment.....	169
8.1.2.8.1	Advanced Protection (WMP.463)	169
8.1.2.8.2	Early Fault Detection (WMP.1195)	172
8.1.2.8.3	Distribution Communications Reliability Improvements (WMP.549)	175
8.1.2.9	Line Removal (in HFTD)	177
8.1.2.9.1	Utility Initiative Tracking ID.....	177
8.1.2.9.2	Overview of the Activity.....	177
8.1.2.9.3	Impact of the Activity on Wildfire Risk	177
8.1.2.9.4	Impact of the Activity on PSPS Risk.....	177
8.1.2.9.5	Updates to the Activity	177
8.1.2.10	Other Grid Topology Improvements to Minimize Risk of Ignitions	178
8.1.2.10.1	Avian Protection Program (WMP.972)	178
8.1.2.10.2	Strategic Pole Replacement Program (WMP.1189).....	179
8.1.2.11	Other Grid Topology Improvements to Mitigate or Reduce PSPS Events	181
8.1.2.11.1	PSPS Sectionalizing Enhancement Program (WMP.461)	181
8.1.2.11.2	Standby Power Program (Fixed Backup Power: Residential/Commercial) (WMP.468) 181	
8.1.2.11.3	Generator Grant Program (WMP.466)	184
8.1.2.11.4	Generator Assistance Program (WMP.467).....	185
8.1.2.12	Other Technologies and Systems not Listed Above.....	187
8.1.2.12.1	Utility Initiative Tracking ID.....	187
8.1.2.12.2	Overview of the Activity	187

8.1.2.12.3	Impact of the Activity on Wildfire Risk	187
8.1.2.12.4	Impact of the Activity on PSPS Risk	187
8.1.2.12.5	Updates to the Activity	187
8.1.3	Asset Inspections	187
8.1.3.1	Distribution Overhead Detailed Inspections (WMP.478)	189
8.1.3.2	Transmission Overhead Detailed Inspections (WMP.479)	191
8.1.3.3	Distribution Infrared Inspections (WMP.481).....	195
8.1.3.4	Transmission Infrared Inspections (WMP.482).....	197
8.1.3.5	Distribution Wood Pole Intrusive Inspections (WMP.483).....	199
8.1.3.6	Transmission Wood Pole Intrusive Inspections (WMP.1190).....	202
8.1.3.7	Drone Assessments (WMP.552).....	202
8.1.3.8	Distribution Overhead Patrol Inspections (WMP.488)	208
8.1.3.9	Transmission Overhead Patrol Inspections (WMP.489)	210
8.1.3.10	Transmission 69 kV Tier 3 Visual Inspections (WMP.555)	213
8.1.3.11	Substation Patrol Inspections (WMP.492)	215
8.1.3.12	Discontinued Asset Inspection Programs	217
8.1.3.12.1	LiDAR Inspections of Distribution Electric Lines and Equipment.....	217
8.1.3.12.2	HFTD Tier 3 Distribution Pole Inspections	217
8.1.4	Equipment Maintenance and Repair (WMP.1130).....	218
8.1.4.1	Maintenance, Repair, and Replacement Strategies.....	218
8.1.4.2	Impact of Inspection Programs	220
8.1.4.3	SCADA Capacitors Maintenance and Replacement Program (WMP.453).....	221
8.1.4.3.1	Utility Initiative Tracking ID.....	221
8.1.4.3.2	Overview of the Activity.....	221
8.1.4.3.3	Impact of the Activity on Wildfire Risk	221
8.1.4.3.4	Impact of the Activity on PSPS Risk.....	222
8.1.4.3.5	Updates to the Activity	222
8.1.4.4	Expulsion Fuse Replacement Program (WMP.459)	222
8.1.4.4.1	Utility Initiative Tracking ID.....	222
8.1.4.4.2	Overview of the Activity.....	222
8.1.4.4.3	Impact of the Activity on Wildfire Risk	223
8.1.4.4.4	Impact of the Activity on PSPS Risk.....	223
8.1.4.4.5	Updates to the Activity	223

8.1.4.5	Hotline Clamp Replacement Program (WMP.464)	224
8.1.4.5.1	Utility Initiative Tracking ID	224
8.1.4.5.2	Overview of the Activity	224
8.1.4.5.3	Impact of the Activity on Wildfire Risk	225
8.1.4.5.4	Impact of the Activity on PSPS Risk	225
8.1.4.5.5	Updates to the Activity	225
8.1.4.6	Lightning Arrester Removal and Replacement (WMP.550)	226
8.1.4.6.1	Utility Initiative Tracking ID	226
8.1.4.6.2	Overview of the Activity	226
8.1.4.6.3	Impact of the Activity on Wildfire Risk	226
8.1.4.6.4	Impact of the Activity on PSPS Risk	227
8.1.4.6.5	Updates to the Activity	227
8.1.5	Asset Management and Inspection Enterprise System(s)	227
8.1.5.1	Distribution Systems (WMP.1332)	227
8.1.5.2	Transmission Systems	228
8.1.5.3	Substation Systems	229
8.1.5.4	Integrated Asset Management Systems (WMP.1332)	229
8.1.5.4.1	WMP Data Platform (WMP.519)	229
8.1.5.4.2	Asset 360 (WMP.1341)	230
8.1.5.4.3	Intelligent Image Processing (WMP.1342)	232
8.1.6	Quality Assurance and Quality Control	233
8.1.6.1	QA/QC of Transmission Inspections (WMP.1191)	234
8.1.6.2	QA/QC of Distribution Detailed Inspections (WMP.491)	235
8.1.6.3	QA/QC of Distribution Drone Assessments (WMP.1192)	235
8.1.6.4	QA/QC of Transmission & Distribution Wood Pole Intrusive Inspections (WMP.1193)	235
8.1.6.5	QA/QC of Substation Inspections (WMP.1194)	235
8.1.7	Open Work Orders (WMP.1065)	236
8.1.7.1	Procedures/Programs Documenting the Work Order Process	236
8.1.7.2	Prioritization of Work Orders	238
8.1.7.3	Plan for Eliminating a Backlog of Work Orders, if Applicable	238
8.1.7.4	Trends with Respect to Open Work Orders	238
8.1.7.5	Open work orders over time	238

8.1.7.6	Aging report for work orders past due	240
8.1.8	Grid Operations and Procedures	241
8.1.8.1	Equipment Settings to Reduce Wildfire Risk	241
8.1.8.1.1	Protective Equipment and Device Settings (WMP.991)	241
8.1.8.1.2	Automatic recloser settings (WMP.1018).....	241
8.1.8.1.3	Settings of other Emerging Technologies	242
8.1.8.2	Grid Response Procedures and Notifications	243
8.1.8.3	Personnel Work Procedures and Training in Conditions of Elevated Fire Risk (WMP.515) 243	
8.1.8.3.1	Procedures for Determining Operating Conditions	243
8.1.8.3.2	Crew Accompanying Ignition Prevention and Suppression Resources and Services (WMP.514)	244
8.1.8.3.3	Aviation Firefighting Program (WMP.557)	245
8.1.9	Workforce Planning	247
8.1.9.1	Asset Inspection Workforce Planning Improvement Plans (WMP.1334)	257
8.1.9.1.1	Extended Reality	257
8.1.9.1.2	Line Checker Program	257
8.1.9.1.3	Safety Observations	257
8.1.9.1.4	Near Misses Reported.....	258
8.1.9.2	Grid Hardening Workforce Planning Improvement Plans (WMP.1331)	259
8.1.9.3	Risk Event Inspection Workforce Planning Improvement Plans (WMP.1206)	259
8.2	Vegetation Management and Inspection	259
8.2.1	Overview	259
8.2.1.1	Objectives.....	261
8.2.1.2	Targets.....	264
8.2.1.3	Performance Metrics Identified by the Electrical Corporation.....	266
8.2.1.3.1	Vegetation Inspections and Clearance in the HFTD.....	266
8.2.1.3.2	Vegetation Outages and Ignitions in the HFTD.....	267
8.2.2	Vegetation Inspections	268
8.2.2.1	Detailed Vegetation Inspections (WMP.494).....	268
8.2.2.1.1	Process	269
8.2.2.1.2	Frequency or Triggers	272
8.2.2.1.3	Accomplishments, Roadblocks, and Updates	272
8.2.2.2	Off-Cycle Patrol Inspections (WMP.508)	273

8.2.2.2.1	Process	273
8.2.2.2.2	Frequency or Triggers	274
8.2.2.2.3	Accomplishments, Roadblocks, and Updates	275
8.2.3	Vegetation and Fuels Management (WMP.497)	276
8.2.3.1	Pole Clearing (WMP.512)	278
8.2.3.1.1	Utility Initiative Tracking ID.....	278
8.2.3.1.2	Overview of the Initiative	278
8.2.3.1.3	Governing Standards and Electrical Corporation Standard Operating Procedures	280
8.2.3.1.4	Updates to the Initiative	280
8.2.3.2	Wood and Slash Management (WMP.497)	281
8.2.3.2.1	Utility Initiative Tracking ID.....	281
8.2.3.2.2	Overview of the Initiative	281
8.2.3.2.3	Governing Standards and Electrical Corporation Standard Operating Procedures	281
8.2.3.2.4	Updates to the Initiative	281
8.2.3.3	Clearance (WMP.501)	282
8.2.3.3.1	Utility Initiative Tracking ID.....	282
8.2.3.3.2	Overview of the Initiative	282
8.2.3.3.3	Governing Standards and Electrical Corporation Standard Operating Procedures	283
8.2.3.3.4	Updates to the Initiative	284
8.2.3.4	Fall-in Mitigation (WMP.494).....	284
8.2.3.4.1	Utility Initiative Tracking ID.....	284
8.2.3.4.2	Overview of the Initiative	284
8.2.3.4.3	Governing Standards and Electrical Corporation Standard Operating Procedures	284
8.2.3.4.4	Updates to the Initiative	284
8.2.3.5	Substation Defensible Space.....	284
8.2.3.6	High-Risk Species.....	284
8.2.3.7	Fire-Resilient Right-of-Ways	285
8.2.3.8	Emergency Response Vegetation Management (WMP.496)	286
8.2.3.8.1	Utility Initiative Tracking ID.....	286
8.2.3.8.2	Overview of the Initiative	286
8.2.3.8.3	Governing Standards and Electrical Corporation Standard Operating Procedures	287
8.2.3.8.4	Updates to the Initiative	287
8.2.4	Vegetation Management Enterprise System (WMP.511)	287

8.2.4.1	Vegetation Inventory and Condition Database(s)	287
8.2.4.2	Internal Documentation of the Database(s)	287
8.2.4.3	Integration with Systems in Other Lines of Business	287
8.2.4.4	Integration with the Auditing System(s)	287
8.2.4.5	Internal Processes for Updating the System and Planned Updates	288
8.2.4.6	Changes Since the Last WMP Submission.....	288
8.2.5	Quality Assurance / Quality Control (QA/QC).....	288
8.2.5.1	QA/QC Procedure/Program (WMP.505).....	288
8.2.5.2	Sample Size	289
8.2.5.3	Who Performs QA/QC.....	290
8.2.5.4	Auditor Qualifications	290
8.2.5.5	QA/QC Findings and Incorporation of Lessons Learned	290
8.2.5.6	Process Changes Since the Last WMP Submission	290
8.2.6	Open Work Orders (WMP.1329).....	290
8.2.6.1	Work Order Procedures	290
8.2.6.2	Work Order Prioritization	291
8.2.6.3	Work Order Backlogs	291
8.2.6.4	Work Order Trends	291
8.2.7	Workforce Planning (WMP.506)	292
8.3	Situational Awareness and Forecasting	297
8.3.1	Overview	297
8.3.1.1	Objectives.....	298
8.3.1.2	Targets.....	304
8.3.1.3	Performance Metrics	304
8.3.2	Environmental Monitoring Systems	305
8.3.2.1	Existing Systems, Technologies, and Processes	305
8.3.2.1.1	Weather Stations and Normalized Difference Vegetation Index (NDVI) Cameras (WMP.447)	305
8.3.2.1.2	Fuel Moisture (WMP.1334)	306
8.3.2.1.3	Air Quality Management Program (WMP.970)	306
8.3.2.2	Evaluation and Selection of New Systems	307
8.3.2.3	Planned Improvements.....	308
8.3.2.3.1	Weather Station Network and NDVI Cameras (WMP.447)	308

8.3.2.3.2	Fuel Moisture (WMP.1334)	308
8.3.2.3.3	Air Quality Management Program (WMP.970)	308
8.3.2.4	Evaluating Mitigation Initiatives	310
8.3.2.4.1	Weather Stations and NDVI Cameras (WMP.447).....	310
8.3.2.4.2	Fuel Moisture (WMP.1334)	311
8.3.2.4.3	Air Quality Management Program (WMP.970)	311
8.3.3	Grid Monitoring Systems	311
8.3.3.1	Existing Systems, Technologies, and Procedures.....	311
8.3.3.2	Evaluation and Selection of New Systems	315
8.3.3.3	Planned Improvements.....	315
8.3.3.4	Evaluating Mitigation Initiatives	315
8.3.3.5	Enterprise System for Grid Monitoring.....	316
8.3.3.5.1	Database(s) Utilized for Storage	316
8.3.3.5.2	Internal Documentation of Database(s)	316
8.3.3.5.3	Integration with Systems in other Lines of Business	316
8.3.3.5.4	QA/QC or Auditing of the System	317
8.3.3.5.5	Updating the Enterprise System Including Database(s)	317
8.3.3.5.6	Changes to the Initiative since the Last WMP Submission	318
8.3.4	Ignition Detection Systems	318
8.3.4.1	Existing Ignition Detection Sensors and Systems.....	318
8.3.4.1.1	Satellite Based Remote Sensing (WMP.971)	319
8.3.4.1.2	Cameras (WMP.1343).....	320
8.3.4.1.3	WFA - Fire Growth Potential Software	321
8.3.4.1.4	AI Smoke Detection Algorithm	321
8.3.4.2	Evaluation and Selection of New Detection Systems	323
8.3.4.2.1	Impact of new Detection Technologies	323
8.3.4.2.2	Efficacy of New Technologies	323
8.3.4.2.3	Budgeting Process.....	324
8.3.4.3	Planned Integration of New Detection Technologies.....	324
8.3.4.4	Evaluating Mitigation Initiatives	324
8.3.4.4.1	Satellite Based Remote Sensing (WMP.971)	324
8.3.4.4.2	Cameras (WMP.1343).....	324
8.3.4.4.3	Fire Growth Potential Software	324

8.3.4.4.4	AI Smoke Detection	325
8.3.4.5	Enterprise System for Ignition Detection.....	325
8.3.4.5.1	Database(s) Utilized for Storage	325
8.3.4.5.2	Internal Documentation of Database(s)	325
8.3.4.5.3	Integration with Systems in other Lines of Business	325
8.3.4.5.4	QA/QC or Auditing of the System	325
8.3.4.5.5	Internal Processes for Updating Enterprise System Including Database(s).....	325
8.3.4.5.6	Changes to the Initiative since the Last WMP Submission	326
8.3.5	Weather Forecasting (WMP.541)	326
8.3.5.1	Existing Modeling Approach	326
8.3.5.1.1	Weather Research and Forecasting (WRF) (WMP.532).....	327
8.3.5.1.2	SAWTI (WMP.540)	327
8.3.5.2	Known Limitations of Existing Approach	328
8.3.5.3	Planned Improvements.....	328
8.3.5.4	Evaluating Mitigation Initiatives	330
8.3.5.5	Enterprise System for Weather Forecasting.....	333
8.3.5.5.1	Database(s) Utilized for Storage	333
8.3.5.5.2	Internal Documentation of Database(s)	334
8.3.5.5.3	Integration with Systems in other Lines of Business	334
8.3.5.5.4	QA/QC or Auditing of the System	334
8.3.5.5.5	Internal Processes for Updating Enterprise System Including Database(s).....	335
8.3.5.5.6	Changes to the Initiative since the Last WMP Submission	335
8.3.6	Fire Potential Index (WMP.450).....	335
8.3.6.1	Existing Calculation Approach and Use.....	335
8.3.6.1.1	Efficacy Study: Determination of Average Distribution Ignition Percentages by Location and Operating Risk Condition.....	338
8.3.6.2	Known Limitations of Existing Approach	339
8.3.6.3	Planned Improvements.....	340
8.4	Emergency Preparedness.....	340
8.4.1	Overview	340
8.4.1.1	Objectives.....	342
8.4.1.2	Targets.....	346
8.4.1.3	Performance Metrics Identified by the Electrical Corporation.....	346

8.4.2	Emergency Preparedness Plan.....	347
8.4.2.1	Overview of Wildfire and PSPS Emergency Preparedness.....	347
8.4.2.1.1	Purpose and Scope of the Plan	347
8.4.2.1.2	Overview of Wildfire and PSPS Protocols, Policies, and Procedures.....	348
8.4.2.1.3	Key Personnel, Qualifications, and Training	351
8.4.2.1.4	Resource Planning and Allocation	351
8.4.2.1.5	Drills, Simulations, and Tabletop Exercises.....	351
8.4.2.1.6	Coordination and Collaboration with Public Safety Partners	351
8.4.2.1.7	Notification of and Communication during and after a Wildfire or PSPS Event.....	351
8.4.2.1.8	Improvements/Updates since the Last WMP Submission.....	352
8.4.2.2	Key Personnel, Qualifications, and Training	352
8.4.2.2.1	Personnel Qualifications (WMP.1335).....	352
8.4.2.2.2	Personnel and External Contractor Training.....	364
8.4.2.3	Drills, Simulations, and Tabletop Exercises.....	366
8.4.2.4	Schedule for Updating and Revising Plan	369
8.4.3	External Collaboration and Coordination	371
8.4.3.1	Emergency Planning.....	371
8.4.3.2	Communication Strategy with Public Safety Partners	373
8.4.3.3	Mutual Aid Agreements.....	377
8.4.3.4	Wildfire and Climate Resilience Center (WCRC)	379
8.4.4	Public Emergency Communication Strategy (WMP.563)	380
8.4.4.1	Protocols for Emergency Communications.....	381
8.4.4.2	Messaging	383
8.4.4.3	Current Gaps and Limitations	384
8.4.5	Preparedness and Planning for Service Restoration.....	384
8.4.5.1	Overview of Service Restoration Plan.....	384
8.4.5.2	Planning and Allocation of Resources.....	386
8.4.5.3	Drills, Simulations, and Tabletop Exercises.....	387
8.4.6	Customer Support in Wildfire and PSPS Emergencies.....	390
8.4.6.1	Outage Reporting.....	390
8.4.6.2	Support for Low-Income Customers.....	390
8.4.6.3	Billing Adjustments	390
8.4.6.4	Deposit Waivers	391

8.4.6.5	Extended Payment Plans.....	391
8.4.6.6	Suspension of Disconnection and Nonpayment Fees.....	391
8.4.6.7	Repair Processing and Timing	391
8.4.6.8	Medical Baseline Support Services	391
8.4.6.9	Access to Electrical Corporation Representatives	392
8.5	Community Outreach and Engagement	393
8.5.1	Overview	393
8.5.1.1	Objectives.....	394
8.5.1.2	Targets.....	396
8.5.1.3	Performance Metrics Identified by the Electrical Corporation.....	397
8.5.2	Public Outreach and Education Awareness Program	398
8.5.2.1	Description of the program(s).....	398
8.5.2.1.1	Wildfire and PSPS Safety Communications Prior to Events.....	398
8.5.2.1.2	Wildfire Safety Communications During PSPS Events	399
8.5.2.1.3	PSPS Notifications	399
8.5.2.1.4	Wildfire Safety Communications After an Event	400
8.5.2.2	Target Community Groups across the Service Territory.....	400
8.5.2.3	Community Partners	401
8.5.2.4	Outreach and Awareness Programs (WMP.1337)	403
8.5.3	Engagement with Access and Functional Needs Populations (WMP.1336)	407
8.5.3.1	Overview	407
8.5.3.2	Summary of Key AFN Demographics	407
8.5.3.3	Evaluation of Challenges and Needs during a Wildfire or PSPS Event.....	408
8.5.3.4	Plans to Address Needs of the AFN Customer Base	408
8.5.3.5	Ongoing Feedback Practices (WMP.1337).....	408
8.5.4	Collaboration on Local Wildfire Mitigation Planning (WMP.1337)	409
8.5.5	Best Practice Sharing with Other Electrical Corporations (WMP.1340)	411
9	PUBLIC SAFETY POWER SHUTOFF.....	413
9.1	Overview	413
9.1.1	Key PSPS Statistics.....	413
9.1.2	Identification of Frequently De-energized Circuits.....	414
9.1.3	Objectives.....	418
9.1.4	Targets.....	420

9.1.5	Performance Metrics	424
9.2	Protocols on PSPS	425
9.2.1	Protocols that Determine the Need for PSPS	425
9.2.2	Method that Evaluates Relative Consequences of PSPS and Wildfires	428
9.2.3	Decision-Making Process for Initiating a PSPS	428
9.2.4	Protocols for Mitigating Public Safety Impacts of PSPS	430
9.3	Communication Strategy for PSPS	431
9.4	Key Personnel, Qualifications, and Training for PSPS	431
9.5	Planning and Allocation of Resources for Service Restoration due to PSPS.....	431
10	LESSONS LEARNED.....	432
10.1	Summary	432
10.2	Identification of Lessons Learned	432
10.2.1	Internal Monitoring and Evaluation.....	432
10.2.2	Feedback from Energy Safety or Other Authoritative Bodies.....	434
10.2.3	Collaborations with Other Electrical Corporations	435
10.2.4	Lessons Learned from Catastrophic Wildfires	435
10.3	Lessons Learned	438
11	CORRECTIVE ACTION PROGRAM	443
11.1	Prevent Recurrence of Risk Events	443
11.2	Address Findings from Internal and External Wildfire Investigations	444
11.3	Address Areas for Continued Improvement Identified by Energy Safety as Part of the WMP Evaluation.....	445
11.4	Process for Reviewing Improvement Area.....	445
11.4.1	Identify Insufficient Occurrence and Response	445
11.4.2	Identify Actions to Reduce Recurrence.....	445
11.4.3	Track Implementation.....	446
11.4.4	Improve External Communication	446
11.4.5	Integrate Lessons Learned Across Industry	447
11.4.6	Share Lessons Learned with Others	447
12	NOTICES OF VIOLATION AND DEFECT	448

List of OEIS Tables

OEIS Table 3-1: Statutory Requirements Checklist	13
OEIS Table 4-1: Summary of WMP Expenditures	18
OEIS Table 4-2: Risk-Informed Approach Components	23
OEIS Table 5-1: Service Territory High-Level Statistics	25
OEIS Table 5-2: Overview of Key Electrical Equipment.....	27
OEIS Table 5-3: Existing Vegetation Types in the Service Territory	28
OEIS Table 5-4: Catastrophic Electrical Corporation Wildfires	30
OEIS Table 5-5: HFTD Statistics	32
OEIS Table 5-6: Relevant State and Federal Environmental Laws, Regulations, and Permitting Requirements for Implementing the WMP	48
OEIS Table 6-1: Summary of Risk Models	54
OEIS Table 6-2: Risk Modeling Assumptions and Limitations	73
OEIS Table 6-3: Summary of Design Basis Scenarios	76
OEIS Table 6-4: Summary of Extreme-Event Scenarios	80
OEIS Table 6-5: Summary of Top-Risk Circuits, Segments, or Spans	84
OEIS Table 6-6: Summary of Key Metrics by Statistical Frequency	91
OEIS Table 6-7: Utility Risk Assessment Improvement Plan	98
OEIS Table 7-1: Stakeholder Roles and Responsibilities in the Decision-Making Process.....	107
OEIS Table 7-2: Prioritized Areas in the Service Territory Based on Overall Utility Risk	110
OEIS Table 7-3: List and Description of Electrical Corporation-Specific WMP Mitigation Initiatives for 3-year and 10-year Outlooks.....	125
OEIS Table 7-4: Summary of Risk Reduction for Top-Risk Circuits.....	132
OEIS Table 8-1: Grid Design, Operations, and Maintenance Objectives (3-year plan).....	137
OEIS Table 8-2: Grid Design, Operations, and Maintenance Objectives (10-year plan).....	142
OEIS Table 8-3: Grid Design, Operations, and Maintenance Targets by Year	147
OEIS Table 8-4: Asset Inspections Targets by Year	149
OEIS Table 8-5: Grid Design, Operations, and Maintenance Performance Metrics Results by Year	152
OEIS Table 8-6: Asset Inspection Frequency, Method, and Criteria	188
OEIS Table 8-7: Grid Design and Maintenance QA/QC Program	233
OEIS Table 8-8: Number of Past Due Work Orders Categorized by Age.....	240
OEIS Table 8-9: Workforce Planning, Asset Inspections	247
OEIS Table 8-10: Workforce Planning, Grid Hardening	251
OEIS Table 8-11: Workforce Planning, Risk Event Inspection	256
OEIS Table 8-12: Vegetation Management Initiative Objectives (3-year plan)	261
OEIS Table 8-13: Vegetation Management Initiative Objectives (10-year plan)	262
OEIS Table 8-14: Vegetation Management Initiative Targets by Year	264
OEIS Table 8-15: Vegetation Inspections Targets by Year	265
OEIS Table 8-16: Vegetation Management and Inspection Performance Metrics Results by Year	266
OEIS Table 8-17: Vegetation Management Inspection Frequency, Method, and Criteria	268
OEIS Table 8-18: Vegetation Management QA/QC Program.....	290
OEIS Table 8-19: Number of Past Due Vegetation Management Work Orders (Tree Units) Categorized by Age	292

OEIS Table 8-20: Vegetation Management Qualifications and Training	294
OEIS Table 8-21: Situational Awareness Initiative Objectives (3-year plan).....	298
OEIS Table 8-22: Situational Awareness Initiative Objectives (10-year plan).....	302
OEIS Table 8-23: Situational Awareness Initiative Targets by Year	304
OEIS Table 8-24: Situational Awareness and Forecasting Performance Metrics Results by Year	304
OEIS Table 8-25: Environmental Monitoring Systems	305
OEIS Table 8-26: Planned Improvements to Environmental Monitoring Systems	309
OEIS Table 8-27: Grid Operation Monitoring Systems.....	313
OEIS Table 8-28: Planning Improvements to Grid Operation Monitoring Systems.....	315
OEIS Table 8-29: Ignition Detection Systems Currently Deployed	318
OEIS Table 8-30: Planning Improvements to New Fire Detection and Alarm Systems	324
OEIS Table 8-31: Planned Improvements to Weather Forecasting Systems	328
OEIS Table 8-32: Fire Potential Features	337
OEIS Table 8-33: Emergency Preparedness Initiative Objectives (3-year plan).....	342
OEIS Table 8-34: Emergency Preparedness Initiative Objectives (10-year plan).....	344
OEIS Table 8-35: Emergency Preparedness Initiative Targets by Year	346
OEIS Table 8-36: Emergency Preparedness Performance Metrics Results by Year	346
OEIS Table 8-37: Key Gaps and Limitations in Integrating Wildfire- and PSPS-Specific Strategies into Emergency Plan.....	352
OEIS Table 8-38: Emergency Preparedness Staffing and Qualifications.....	354
OEIS Table 8-39: Electrical Corporation Personnel Training Program	364
OEIS Table 8-40: Contractor Training Program	365
OEIS Table 8-41: Internal Drill, Simulation, and Tabletop Exercise Program.....	366
OEIS Table 8-42: External Drill, Simulation, and Tabletop Exercise Program	366
OEIS Table 8-43: Wildfire-Specific Updates to the CEADPP.....	370
OEIS Table 8-44: State and Local Agency Collaboration(s)	372
OEIS Table 8-45: Key Gaps and Limitations in Collaboration Activities with State and Local Agencies ...	372
OEIS Table 8-46: High-Level Communication Protocols, Procedures, and Systems with Public Safety Partners*	374
OEIS Table 8-47: Key Gaps and Limitations in Communication Coordination with Public Safety Partners	376
OEIS Table 8-48: High-Level Mutual Aid Agreement for Resources During a Wildfire or De-Energization Incident	378
OEIS Table 8-49: Protocols for Emergency Communication to Stakeholder Groups	382
OEIS Table 8-50: Key Gaps and Limitations in Public Emergency Communication Strategy	384
OEIS Table 8-51: Internal Drill, Simulation, and Tabletop Exercise Program for Service Restoration.....	387
OEIS Table 8-52: External Drill, Simulation, and Tabletop Exercise Program for Service Restoration	388
OEIS Table 8-53: Community Outreach and Engagement Initiative Objectives (3-year plan).....	394
OEIS Table 8-54: Community Outreach and Engagement Initiative Objectives (10-year plan).....	395
OEIS Table 8-55: Community Outreach and Engagement Initiative Targets by Year	396
OEIS Table 8-56: PSPS Outreach and Engagement Initiative Targets by Year	396
OEIS Table 8-57: Community Outreach and Engagement Performance Metrics Results by Year.....	397
OEIS Table 8-58: List of Target Communities.....	400
OEIS Table 8-59: List of Community Partners	401

OEIS Table 8-60: Community Outreach and Education Programs.....	404
OEIS Table 8-61: Collaboration in Local Wildfire Mitigation Planning*	409
OEIS Table 8-62: Key Gaps and Limitations in Collaborating on Local Wildfire Mitigation Planning	410
OEIS Table 8-63: Table does not exist per OEIS guidelines.....	411
OEIS Table 8-64: Best Practice Sharing with Other Electrical Corporations	412
OEIS Table 9-1: PSPS Event Statistics	413
OEIS Table 9-2: Frequently De-energized Circuits*	415
OEIS Table 9-3: PSPS Objectives (3-year plan)	418
OEIS Table 9-4: PSPS Objectives (10-year plan).....	419
OEIS Table 9-5: PSPS Targets	420
OEIS Table 9-6: PSPS Performance Metrics Results by Year	424
OEIS Table 10-1: Lessons Learned.....	438
OEIS Table 12-1: List of Open Compliance Violations and Defects.....	448

List of SDG&E Tables

SDG&E Table 1-1: Successes and Lessons Learned for the 2020-2022 WMP Cycle	2
SDG&E Table 2-1: WMP Section Program Owners	11
SDG&E Table 5-1: CFI Customers in Tier 2 of the HFTD.....	43
SDG&E Table 5-2: CFI Customers in Tier 3 of the HFTD.....	44
SDG&E Table 6-1: Enterprise CoRE MAVF Attributes	52
SDG&E Table 6-2: Sub-Attributes of Health & Safety	52
SDG&E Table 6-3: Sub-Attributes of Reliability.....	52
SDG&E Table 6-4: Risk Components for LoRE.....	68
SDG&E Table 6-5: Risk Components for Consequence.....	70
SDG&E Table 6-6: Pre-Mitigation Analysis Risk Quantification Scores.....	72
SDG&E Table 6-7: Summary of Design Parameters in WiNGS-Planning Visualization Application	78
SDG&E Table 6-8: WiNGS-Planning Qualitative Risk Modeling Updates.....	87
SDG&E Table 6-9: WiNGS-Planning and WiNGS-Ops Review Findings and Recommendations.....	94
SDG&E Table 6-10: Version Control Hierarchy for WiNGS-Planning 3.0 (in development)	96
SDG&E Table 7-1: Risk Segment Scoped Mileage 2022-2027.....	109
SDG&E Table 7-2: Mitigation Prioritization	117
SDG&E Table 7-3: Wildfire Risk Reduction Projection.....	130
SDG&E Table 7-4: Interim Mitigations Initiatives	133
SDG&E Table 8-1: Risk reduction estimation of the Covered Conductor Program	157
SDG&E Table 8-2: Risk Reduction Estimation for the Strategic Undergrounding Program.....	159
SDG&E Table 8-3: Risk Reduction Estimation for Distribution Overhead Hardening.....	164
SDG&E Table 8-4: Risk Reduction Estimation for Transmission Overhead Hardening.....	165
SDG&E Table 8-5: Risk Reduction Estimation for Transmission-Distribution Underbuilt.....	166
SDG&E Table 8-6: Risk Reduction Estimation for Advance Protection.....	170
SDG&E Table 8-7: Risk Reduction Estimation for Early Fault Detection.....	174
SDG&E Table 8-8: Risk Reduction Estimation for Avian Covers.....	178
SDG&E Table 8-9: Risk Reduction Estimation for the Strategic Pole Replacement Program	180
SDG&E Table 8-10: GO 95, Rule 18 Inspection Finding Priority Levels.....	189

SDG&E Table 8-11: Risk Reduction Estimation Methodology for the CMP	191
SDG&E Table 8-12: Risk Reduction Estimation Methodology for the Transmission Overhead Inspection Program.....	194
SDG&E Table 8-13: Risk Reduction Methodology for Distribution Infrared Inspections Program.....	196
SDG&E Table 8-14: Risk Reduction Estimation for Transmission Infrared Inspections	199
SDG&E Table 8-15: Risk Reduction Methodology for Distribution Wood Pole Intrusive Inspections.....	201
SDG&E Table 8-16: Risk Reduction Methodology for the DIAR Program	207
SDG&E Table 8-17: Risk Reduction Estimation Methodology for Distribution Overhead Patrol Inspections	210
SDG&E Table 8-18: Risk Reduction Methodology for Transmission Overhead Patrol Inspections	213
SDG&E Table 8-19: Risk Reduction Estimation for Transmission 69 kV Tier 3 Visual Inspections.....	215
SDG&E Table 8-20: Findings that Trigger Autogenerated Corrective Maintenance Order	217
SDG&E Table 8-21: Maintenance and Replacement Strategies	219
SDG&E Table 8-22: Risk Event Rate with Pending Infractions	220
SDG&E Table 8-23: Risk Reduction Estimation for SCADA Capacitors.....	221
SDG&E Table 8-24: Risk Reduction Estimation for the Expulsion Fuse Replacement Program	223
SDG&E Table 8-25: CAL FIRE and Expulsion Fuse Operation 2015-2021.....	224
SDG&E Table 8-26: CAL FIRE and Expulsion Fuse Operation 2015-2021 by HFTD Tier	224
SDG&E Table 8-27: Risk Reduction Estimation for the HLC Program	225
SDG&E Table 8-28: Risk Reduction Estimation for Lightning Arrester Program.....	226
SDG&E Table 8-29: Ignition Rate with SRP Enabled	241
SDG&E Table 8-30: Results of Reclosure Protocols in Ignition Avoidance	242
SDG&E Table 8-31: Effect of Special Work Procedures on Ignitions	244
SDG&E Table 8-32: Effect of CFRs on Ignitions	245
SDG&E Table 8-33: Employee-Conducted Safety Observations.....	257
SDG&E Table 8-34: Employee-Submitted Near Misses	258
SDG&E Table 8-35: 5-Year Average Ignition Rate	338
SDG&E Table 8-36: CRC Locations and Services	391
SDG&E Table 10-1: Double Down Initiatives	433
SDG&E Table 10-2: Areas for Continued Improvement.....	434

List of Figures

Figure 1-1: Enterprise Risk Management Framework for Development of the WMP	9
Figure 4-1: Summary of WMP Expenditures.....	19
Figure 4-2: Enterprise Risk Management Framework	21
Figure 5-1: Utility Service Territory of the Enterprise Risk Management Framework	25
Figure 5-2: Service Territory (polygons) and Distribution of Customers Served	26
Figure 5-3: Catastrophic Wildfire Map.....	31
Figure 5-4: Map of HFTD in the Service Territory	32
Figure 5-5: Annual Mean Climatology for the Service Territory	33
Figure 5-6: Mean Annual Temperature for the Service Territory 1900s-2020s	35
Figure 5-7: Mean Annual Precipitation for the Service Territory 1900s-2020s.....	35
Figure 5-8: Projected Change in Minimum and Maximum Daily Temperatures	36

Figure 5-9: Extreme Fire Weather Days in the Service Territory	38
Figure 5-10: AFN Customers in the Service Territory	41
Figure 5-11: Communities at Risk in the Service Territory	42
Figure 6-1: Enterprise CoRE MAVF.....	51
Figure 6-2: Risk Identification Step of the Enterprise Risk Management Framework.....	59
Figure 6-3: Enterprise Utility Risk Overview	60
Figure 6-4: WiNGS-Planning Risk Calculation Process Flow Diagram	61
Figure 6-5: WiNGS-Ops Calculation Process Flow Diagram	63
Figure 6-6: Risk Analysis Step of the Enterprise Risk Management Framework	65
Figure 6-7: WiNGS-Planning Calculation Schematic	66
Figure 6-8: WiNGS-Ops Calculation Schematic.....	67
Figure 6-9: WiNGS Visualization Interface.....	79
Figure 6-10: Risk Evaluation & Prioritization Step of the Enterprise Risk Management Framework.....	81
Figure 6-11: Higher-Risk Urban Areas in Relation to HFTD.....	82
Figure 6-12: Map of Service Territory with Circuits Categorized in terms of Wildfire Risk	83
Figure 6-13: Independent Review Process	93
Figure 7-1: Risk Evaluation & Prioritization Step of the Enterprise Risk Management Framework.....	106
Figure 7-2: WiNGS-Planning: Wildfire Hardening Targets	114
Figure 7-3: Circuit 358-682F: Example of Prior Hardening	117
Figure 7-4: High-Level Mitigation Prioritization to Reduce Wildfire and PSPS Risk.....	120
Figure 7-5: Risk Mitigation Plan Development & Documentation Step of the Enterprise Risk Management Framework.....	124
Figure 7-6: Projected Overall Wildfire and PSPS Risk Reduction	129
Figure 8-1: Risk-Informed Investment decision & Risk Mitigation Implementation Step of the Enterprise Risk Management Framework.....	135
Figure 8-2: Distribution Inspection Findings and Open Work Orders.....	153
Figure 8-3: Distribution Equipment related HFTD Ignitions and Outages Rate.....	154
Figure 8-4: Transmission Inspection Findings and Open Work Orders in HFTD	155
Figure 8-5: Transmission Equipment related HFTD Outages and Ignitions	156
Figure 8-6: Projected PSPS Impact Reduction	160
Figure 8-7: FPB Installation at Mobile Home Park Community	182
Figure 8-8: Distribution Detailed Overhead Inspections Process Flow.....	190
Figure 8-9: Transmission Detailed Overhead Inspections Process Flow.....	193
Figure 8-10: Distribution Infrared Inspections Process Flow	195
Figure 8-11: Transmission Infrared Inspections Process Flow	198
Figure 8-12: Wood Pole Intrusive Inspections Process Flow (Transmission and Distribution)	200
Figure 8-13: Distribution Drone Inspections Process Flow	204
Figure 8-14: DIAR Inspection Prioritization Model	206
Figure 8-15: Distribution Patrol Inspections Process Flow	209
Figure 8-16: Transmission Patrol Overhead Inspections Process Flow	212
Figure 8-17: Transmission Tier 3 69 kV Inspections Process Flow	214
Figure 8-18: Substation Patrol Inspection Workflow.....	216
Figure 8-19: Asset Criticality and Maintenance/Replacement Strategies	219
Figure 8-20: WMP Data Platform.....	230

Figure 8-21: Asset 360 3-Year Roadmap.....	232
Figure 8-22: IIP 3-Year Roadmap	233
Figure 8-23: Open Work Orders: Corrective Maintenance.....	237
Figure 8-24: Distribution Open Work Orders.....	239
Figure 8-25: Transmission Open Work Orders – Not Past Due.....	240
Figure 8-26: Results of Reclosure Protocols in Fault Avoidance.....	242
Figure 8-27: Vegetation Inspections and Clearance in the HFTD	267
Figure 8-28: Vegetation Outages and Ignitions in the HFTD.....	268
Figure 8-29: Detailed Vegetation Inspections Process Flow.....	271
Figure 8-30: Fuels Modification Sites Using Risk Assessment and Mapping and WRRM	277
Figure 8-31: Pole Clearing (Brushing) Process Flow.....	279
Figure 8-32: Enhanced Clearance Process Flow.....	283
Figure 8-33: Auditing Pre-Inspection, Tree Trim, and Pole Clearing Process Flow.....	289
Figure 8-34: Open Work Orders in the HFTD.....	292
Figure 8-35: Smoke Detection Image Identified by AI Smoke Detection Algorithm	323
Figure 8-36: SAWTI Across Time and Incidences of Major Wildfires	331
Figure 8-37: Wind Gust Machine Learning Validation for West Alpine.....	332
Figure 8-38: Example of ML Gust Forecast Model Output	333
Figure 8-39: Historical Major Wildfire Correlation to FPI	339
Figure 8-40: EOC Activation Levels	349
Figure 8-41: SDG&E Response Phases	350
Figure 8-42: WCRC Floor Plan	380
Figure 8-43: Key Components of Service Restoration Procedures	385
Figure 9-1: Risk-Informed Investment Decision & Risk Mitigation Implementation Step of the Enterprise Risk Management Framework.....	413
Figure 9-2: Frequently De-Energized Circuits	417
Figure 9-3: Cumulative Historical PSPS Score	423
Figure 9-4: PSPS Customers Impact by RFW.....	425
Figure 9-5: PSPS System Impact by RFW	425
Figure 9-6: PSPS Decision-Making Framework	429
Figure 10-1: Monitoring & Review Step of the Enterprise Risk Management Framework	432
Figure 11-1: Monitoring & Review Step of the Enterprise Risk Management Framework	443
Figure 12-1: Monitoring & Review Step of the Enterprise Risk Management Framework	448

List of Appendices

Appendix A: Definitions

Appendix B: Supporting Documentation for Risk Methodology and Assessment

Appendix C: Additional Maps

Appendix D: Areas for Continued Improvement

Appendix E: Referenced Regulations, Codes, and Standards

Appendix F: Tables

Appendix G: AFN Plan

List of Abbreviations

Abbreviation	Name
AAR	After-Action Review
ABI	Advanced Baseline Imager
ADA	Americans with Disabilities Act
ADO	Azure DevOps
AFN	Access and Functional Needs
AI	Artificial Intelligence
AMI	advanced metering infrastructure
APP	Advanced Protection Program
APS	Arizona Public Service
AQI	Air Quality Index
ARFS	Advanced Radio Frequency Sensors
ARPA	Archaeological Resources Protection Act
AWS	Amazon Web Services
BBS	Behavior Based Safety
BIA	Bureau of Indian Affairs
BMP	Best management practices
BPA	Bonneville Power Administration
C&I	Commercial and Industrial
CAB	Change Advisory Board
CAIDI	Customer Average Interruption Duration Index
CAL FIRE	California Department of Forestry and Fire Protection
Caltrans	California Department of Transportation
CARB	Cloud Architecture Review Board
CARE	California Alternate Rates for Energy
CBM	Condition Based Maintenance
CBO	Community Based Organization
CCC	California Conservation Corps
CDFW	California Department of Fish and Wildlife
CEADPP	Company Emergency and Disaster Preparedness Plan
CEQA	California Environmental Quality Act
CFI	Critical Facilities & Infrastructure
CFR	Contract Fire Resources
CFR	Code of Federal Regulations
CHARM	Change Request Management
CHI	Circuit Health Index
CIP	Communication Infrastructure Provider
CMP	Corrective Maintenance Program

CoF	consequence of failure
CoRE	consequence of a risk event
CPUC	California Public Utilities Commission
CRC	Community Resource Centers
CRI	Circuit Risk Index
CSTI	California Specialized Training Institute
CUEA	California Utilities Emergency Association
CW3E	Center for Western Weather and Water Extremes
D	Decision
DBH	diameter at breast height
DCRI	Distribution Communications Reliability Improvement
DER	Distributed Energy Resources
DFM	dead fuel moisture
DHS	Department of Homeland Security
DIAR	Drone Investigation, Assessment and Repair
DSDD	Design Standard Decision Document
DWO	Dispatch Work Orders
EDF	Early Fault Detection
EMAP	Emergency Management Accreditation Program
EMT	Executive Management Team
ENS	Enterprise Notification System
EOC	Emergency Operations Center
EOD	Emergency On-Duty
EPA	Environmental Protection Agency
EPE	Encroachment Policy Exception
EPRI	Electric Power Research Institute, Inc
ERR	Enterprise Risk Registry
ESA	Endangered Species Act
ESA	Energy Savings Assistance
ESH	Electric System Hardening
ESP	Electric Standard Practice
FAA	Federal Aviation Administration
FACT	Facilitating Access to Coordinated Transportation
FBP	Fixed Backup Power
FCC	Federal Communications Commission
FCP	Falling Conductor Protection
FDC	Fire Detection and Characterization
FEMA	Federal Emergency Management Agency
FERA	Federal Emergency Relief Administration

FPI	Fire Potential Index
FRP	Fire Radiative Power
FSCA	Fire Science and Climate Adaptation
FSI	Fire Science and Innovation
FTZ	Fire Threat Zone
FWI	Fire Weather Index
GAP	Generator Assistance Program
GCM	global climate models
GGP	Generator Grant Program
GIS	geographic information system
GO	General Order
GOES	Geostationary Operational Environmental Satellite
GRC	General Rate Case
GTAC	Geospatial Technology and Applications Center
HCP	Habitat Conservation Plan
HFE	Human Factors Engineering
HFTD	High Fire Threat District
HLC	hotline clamps
HPWREN	High Performance Wireless Research and Education Network
HRFA	High-Risk Fire Area
HSEEP	Homeland Security Exercise and Evaluation Program
HWW	high wind warning
IBEW	International Brotherhood of Electrical Workers
ICS	Incident Command System
IEEE	Institute of Electrical and Electronics Engineers
IIP	Intelligent Image Processing
IMP	Ignition Management Program
IOU	Investor Owned Utilities
IPCC	Intergovernmental Panel on Climate Change
ISA	International Society of Arboriculture
ITP	incidental take permit
IWRMC	Code of Federal Regulations
km	kilometer
kV	Kilovolt
kVA	kilovolt-ampere
kW	kilowatts
LEP	Limited English Proficiency
LFM	Live Fuel Moisture
LIDAR	Light detection and ranging

LoRE	likelihood of a risk event
LPCN	Low Power Communication Network
LRA	Local Responsibility Area
MAVF	Multi Attribute Value Framework
MBL	Medical Baseline
MDT	Mobile Data Terminal
MHRP	Mobile Home Park Resilience Program
ML	Machine Learning
MODIS	Moderate Resolution Imaging Spectroradiometer
MOU	memoranda of understanding
mph	miles per hour
MW	megawatt
MWh	megawatt-hours
NAGRPA	Native American Graves Protection and Repatriation Act
NCAR	National Center for Atmospheric Research
NCCP	Natural Communities Conservation Plan
NDVI	Normalized Difference Vegetation Index
NEPA	National Environmental Protection Act
NERC	North American Electric Reliability Corporation
NFDRS	National Fire Danger Rating System
NHPA	National Historic Preservation Act
NIMS	National Incident Management System
NMS	Network Management System
NOD	notices of defect
NOV	notices of violation
NWS	National Weather Service
OCM	overhead circuit miles
OEIS or Energy Safety	Office of Energy Infrastructure Safety
OES	Office of Emergency Services
OIC	officer in charge
OIR	Order Instituting Rulemaking
OMS	Outage Management System
OPI	Outage Prediction Index
OSHA	Occupational Safety and Health Administration
PG&E	Pacific Gas & Electric
PLS-CADD	Power Line Systems – Computer Aided Drafting and Design
PM _{2.5}	Particulate Matter 2.5 microns or smaller in diameter
PMO	Program Management Office
PMU	phasor measurement unit

PoF	probability of failure
Pol	probability of ignition
PQ	Power Quality
PRC	Public Resource Code
PS&E	Pacific Science & Engineering
psf	pounds per square foot
PSPP	Public Safety Partner Portal
PSPS	Public Safety Power Shutoff
PTZ	Pan-Tilt-Zoom
PUC	Public Utilities Code
QA/QC	Quality Assessment/Quality Control
QDR	Quarterly Data Report
QEW	qualified electrical worker
RAMP	Risk Assessment Mitigation Phase
RAWS	Remote Automated Weather Station
RCP	Representative Concentration Pathway
RDF	Risk-Based Decision-Making Framework
RFP	Request for Proposal
RFW	Red Flag Warning
RMAG	Regional Mutual Assistance Group
ROW	Right Of Way
RSE	Risk Spend Efficiency
RTU	Remote Terminal Units
S-MAP	Safety Model and Assessment Proceeding
SA	Settlement Agreement
SAP PM	Systems Applications and Processes Plant Maintenance
SAIDI	System Average Duration Index
SAFI	System Average Interruption Frequency Index
SAWTI	Santa Ana Wind Threat Index
SCADA	supervisory control and data acquisition
SCE	Southern California Edison
SDG&E or Company	San Diego Gas & Electric
SDSC	San Diego Supercomputing Center
SEMS	Standardized Emergency Management Systems
SGF	Sensitive Ground Fault
SIF	Serious Injuries and Fatalities
SIR	System Investigation Report
SMS	Safety Management System
SOP	Standard Operating Procedure

SQL	Structured Query Language
SRA	State Responsibility Area
SRP	Sensitive Relay Profile
SSEC	Space Science and Engineering Center
SWO	Scheduling Work Orders
TCM	Transmission Construction and Maintenance
USFWS	U.S. Fish & Wildlife Service
VMA	Vegetation Management Area
VRI	Vegetation Risk Index
WCAG	Web Content Accessibility Guidelines
WCRC	Wildfire & Climate Resiliency Center
WDD	Wire Down Detection
WFA-E	Wildfire Analyst™ Enterprise
WFABBA	Wildfire Automated Biomass Burning Algorithm
WFI	Wireless Fault Indicator
WFM	Workforce Management
WiNGS	Wildfire Next Generation System Planning
WMP	Wildfire Mitigation Plan
WMPMA	Wildfire Mitigation Plan Memorandum Account
WRF	Weather Research and Forecast
WRRM	Wildfire Risk Reduction Model
WSCAC	Wildfire Safety Community Advisory Council
WUI	Wildland Urban Interface

1 Executive Summary

1.1 Summary of 2020–2022 WMP Cycle

The safety of our customers, employees, and the communities we serve is San Diego Gas & Electric’s (SDG&E or Company) highest priority. Over the past decade, SDG&E has invested billions of dollars in a variety of safety measures to prevent utility-related catastrophic wildfires and inform the public about emergency preparedness. SDG&E’s commitment to the safety of our communities was continually demonstrated in our efforts to strengthen and protect infrastructure, improve situational awareness and data analysis, enhance weather technology, and provide community outreach over the course of its 2020 to 2022 Wildfire Mitigation Plan (WMP) cycle. The Company implemented its 2020-2022 WMP and achieved key goals and objectives aimed at reducing the risk of catastrophic wildfire and mitigating the impacts of Public Safety Power Shutoffs (PSPS). The 2023-2025 WMP builds on these successes and incorporates lessons learned to remedy identified areas for improvement.

SDG&E’s major risk reduction initiatives remain its large grid hardening initiatives, specifically distribution overhead hardening, installation of covered conductor, and strategic undergrounding of electric lines. Across the 2020 to 2022 WMP cycle, SDG&E exceeded its targets for all three of these initiatives, hardening over 225 miles with traditional hardening, installing 85 miles of covered conductor, and undergrounding 105 miles of electric lines. Hardening work within Cleveland National Forest was also completed, which included hardening an additional 53 distribution circuit miles and undergrounding 14 miles of distribution infrastructure.

SDG&E made advancements in its risk modeling capabilities to better inform its investment strategies and initiative selections and to optimize its ability to target the areas of highest wildfire risk. During the 2020 to 2022 WMP cycle, SDG&E transitioned from utilizing the Wildfire Risk Reduction Model (WRRM) model to the Wildfire Next Generation System (WiNGS)-Planning model to evaluate the risk of wildfire and the likelihood and impacts of PSPS at the circuit segment level. In 2022, SDG&E incorporated new data inputs to the WiNGS-Planning model to, among other things, capture additional cost efficiencies, update ignition and weather data, and capture any risk reduction of existing infrastructure. These updates led SDG&E to re-shape its grid hardening strategy to perform additional undergrounding of electric lines over the next 10 years and reduce corresponding covered conductor installation. By executing on this plan, SDG&E predicts it will significantly reduce the risk of utility-related wildfire and the impacts of PSPS within the service territory.

SDG&E improved upon its world-class situational awareness tools over the 2020 to 2022 WMP cycle. The Weather Station Network was expanded to include 222 weather stations across the service territory, and stations were upgraded with the capacity to provide wind speed data at up to 30 second intervals. SDG&E’s artificial intelligence forecasting technology is now integrated with 216 weather stations, providing the latest technology and improved ability to forecast impending wind events. SDG&E’s Artificial Intelligence (AI) smoke detection algorithm was developed in partnership with the Space Science and Engineering Center (SSEC) at the University of Wisconsin-Madison to identify fires soon after ignition by operationalizing satellite fire detection coupled with mountaintop cameras. SDG&E’s Fire Potential Index (FPI) was further enhanced by obtaining data from five 10-hr-dead-fuel

moisture sensors, nine normalized difference vegetation index (NDVI) cameras in strategic locations, and weekly NDVI values from low earth orbiting satellites.

SDG&E developed and implemented the Drone Investigation, Assessment and Repair (DIAR) Program to perform inspections utilizing drones. The DIAR Program inspection capabilities offer increased ability to reveal potential risks on hard-to-reach infrastructure. From 2020 to 2022, SDG&E performed drone inspections of every overhead distribution structure within the High Fire Threat District (HFTD), totaling over 86,000 inspections. The program was successful in identifying additional risks that were not visible utilizing ground-based inspections. To enhance its review of these inspections, SDG&E developed the Intelligent Image Processing (IIP) tool. IIP leverages machine learning to automatically identify damage found in imagery captured via drone. To date, IIP has assessed over one million images to identify twenty different types of damage with an accuracy rate of over 85 percent. To continue to capture the enhanced risk reduction realized through the DIAR Program on a more permanent basis, risk modeling will be incorporated to identify the top 15 percent of HFTD structures by risk and drone inspections will be performed on those assets each year.

SDG&E built upon the successes of its Vegetation Management Program over the 2020 to 2022 WMP cycle. Every tree within SDG&E’s tree inventory—totaling nearly 450,000—is inspected annually and a second inspection is performed on each inventory tree within the HFTD each year. Additionally, high-risk trees are targeted for enhanced clearances exceeding minimum regulatory requirements when prudent and achievable. The effectiveness of these additional clearances has been demonstrated through data analysis and collaboration with Energy Safety and other utilities. Vegetation Management activities continue to demonstrate success, with a clear downward trend in vegetation-caused outages and ignitions when reviewing data back to 2015.

SDG&E Table 1-1: Successes and Lessons Learned for the 2020-2022 WMP Cycle

WMP Category	Areas of Success	Areas for Improvement	Lessons Learned
Risk methodology and assessment	<p>Incorporated new data to improve the performance of the WiNGS-Planning model for risk assessment and investment planning.</p> <p>Incorporated new data and retrained WiNGS-Ops models to improve performance during PSPS events.</p>	<p>SDGE-22-01</p> <p>SDGE-22-02</p> <p>SDGE-22-04</p> <p>SDGE-22-05</p> <p>SDGE-22-06</p> <p>SDGE-22-08</p> <p>SDGE-22-09</p> <p>SDGE-22-18</p> <p>SDGE-22-19</p> <p>SDGE-22-25</p> <p>SDGE-22-26</p> <p>SDGE-22-28</p>	<p>Transitioning models to the cloud and upgrading high-performance computing infrastructure can optimize the running of granular models on an hourly basis.</p> <p>Risk modeling automation is needed to enable more real-time updates and facilitate “what-if” scenario planning.</p>
Wildfire mitigation strategy	<p>Utilized updated WiNGS-Planning data to redefine the 10-year grid hardening strategy. Updated portfolio achieves greater wildfire risk and PSPS impact reduction through expansion of strategic undergrounding.</p>	<p>SDGE-22-07</p> <p>SDGE-22-10</p> <p>SDGE-22-14</p> <p>SDGE-22-15</p> <p>SDGE-22-27</p>	<p>Ongoing coordination with the Electric System Hardening (ESH) team is needed for the most up-to-date information on costs, feasibility, and other factors to be included for scoping wildfire mitigation initiatives.</p>

WMP Category	Areas of Success	Areas for Improvement	Lessons Learned
Grid design, operations, and maintenance	Met or exceeded targets for major grid hardening initiatives by completing 27 miles of traditional overhead hardening, installing 63 miles of covered conductor, and 65 miles of undergrounding in 2022. Completed drone inspections of all HFTD distribution structures.	SDGE-22-11 SDGE-22-12 SDGE-22-13 SDGE-22-16 SDGE-22- 17 SDGE-22-24	Continued to improve processes that streamline the pre-construction process for permitting, design, and material purchasing. Risk-based inspection can be leveraged to continue the success of DIAR Program in identifying additional risks.
Vegetation management and inspections	Achieved targets for all vegetation management inspections, pole brushing, and fuels management activities.	SDGE-22-03 SDGE-22-20 SDGE-22-21 SDGE-22- 22	Continued analysis of SDG&E's enhanced vegetation management program will inform updated forecasts and program scope
Situational awareness and forecasting	Integrated AI forecasting system across 215 weather stations, providing the latest available forecasting technology to help serve communities in the highest risk fire areas. Partnered with academia to develop and operationalize an infrared camera smoke detection algorithm for ignition detection capabilities utilizing satellite imagery to improve situational awareness and response.	n/a	The AI infrared camera smoke detection algorithm assists in identifying fires soon after ignition by operationalizing satellite fire detection coupled with mountaintop cameras. The Machine Learning Wind Gust model for all weather stations in the HFTD (215 out of 222) is vital for situational awareness 72 hours prior to a PSPS or Red Flag Warning (RFW) event.
Emergency preparedness	Enhanced the Company Emergency and Disaster Preparedness Plan (CEADPP) to increase focus on all hazards. Planned for the 2023 completion of the Wildfire & Climate Resilience Center (WCRC) that will serve as a physical space committed to understanding evolving wildfire and climate impacts and to building climate-informed grid resilience.	n/a	Implementation of process flow process tools is necessary to improve the efficiency of notifications with public safety and other state partners. Through coordination with other Investor-Owned Utilities (IOUs), preregistering public safety partner information on a secure website is important to improve completeness of data. Safety stand-downs at all operating centers aid in enhancing preparedness.
Community outreach and engagement	Collaborated with other utilities to develop the use of the statewide website: prepareforpowerdown.com. Currently the site promotes PSPS and wildfire resiliency information that supports Access and Functional Needs (AFN) communities. This site will continue to be the focus of IOU collaboration in 2023 as well as additional promotional support for public awareness.	n/a	Surveying customers, particularly affected customers, to assess campaign effectiveness and communication preferences is key to informing the development of future campaigns. Optimizing partnerships with 40 HFTD-focused Community Based Organizations (CBOs) and enhancing CBO partnerships in key areas (e.g., healthcare) can assist in achieving promotion and amplification of PSPS-related preparedness information to vulnerable populations.
PSPS	Pioneered backup resiliency programs (Standby Power Program, GGP, GAP)	SDGE-22-23 SDGE-22-29	WiNGS-Ops model enhanced by retraining existing models with new historical observations, incorporating

WMP Category	Areas of Success	Areas for Improvement	Lessons Learned
	<p>benefitting over 7,000 customers between 2020-2022.</p> <p>Established a network of 11 Community Resource Centers (CRCs) located at fixed facilities to help communities in real-time during PSPS events.</p> <p>Launched the Alerts by SDG&E app to provide communication to customers for real-time notifications leading up to and through a de-energization event.</p> <p>Launched the Public Safety Partner Portal for more effective, up-to-date communication with Public Safety Partners during a PSPS event, including training sessions and video tutorials.</p>	SDGE-22-30	<p>AFN customer impact scaling factors, and improving consequence calculations.</p> <p>Customer participation in PSPS resiliency programs is largely driven by the occurrence of PSPS events. SDG&E created a dedicated reserve of backup battery units to provide support to those qualified customers who have not yet participated in resiliency programs, as well as prior participants who have received a unit and need additional capacity.</p>

1.1.1 Major Lessons Learned

SDG&E’s wildfire mitigation efforts have continued to evolve since the submission of the 2022 WMP Update. Areas of focus include the continuous enhancement of data analytics and modeling capabilities, continued evaluation of technologies and efficacy studies to assess various strategies for mitigating wildfire and PSPS risk, and enhanced preparedness for PSPS events.

In 2022, SDG&E solicited feedback from frontline employees engaged in wildfire mitigation efforts to identify and complete additional preparedness activities. This “double down” initiative yielded an additional 13 activities that were completed in 2022. Key lessons learned from ongoing WMP initiatives as well as the “double down” challenge are included below and in Section 10 Lessons Learned.

1.1.1.1 Risk Methodology and Assessment

In 2022, SDG&E focused on enhancing its culture of continuous improvement by embracing change to its models, increasing collaboration with Joint IOUs, and participating in Office of Energy Infrastructure Safety (OEIS or Energy Safety) risk modeling workshops. This led to more accurate wildfire risk assessment and increased the effectiveness of the portfolio of proposed mitigations. As examples, during 2022, SDG&E learned:

- The transition of models from static excel files to the cloud allows for centralized, dynamic data that improves transparency, reproducibility, and allows a more agile risk assessment.
- Moving the WiNGS-Planning model output to a visual platform will allow for dissemination of the model and enhance design scenario building to better guide investment planning decisions.
- The WiNGS-Ops application dynamic risk modeling will be visualized to easily access information during events which will strengthen confidence in PSPS decision-making.
- Technosylva’s Wildfire Analyst™ Enterprise (WFA-E) product has been updated to conduct modeling, deliver modeling outputs, and monitor and visualize results with software applications that are incorporated directly into operations wildfire risk modeling efforts.

- WiNGS-Planning can be improved by incorporating life cycle costs of vegetation management, asset management, and PSPS activations to allow for more accurate mitigation selection.

Refer to Section 6 Risk Methodology and Assessment for additional details.

1.1.1.2 Wildfire Mitigation Strategy

A core of SDG&E’s comprehensive wildfire mitigation strategy remains SDG&E’s commitment to reduce wildfire risk, promote reliability, and enhance situational awareness and preparedness. SDG&E’s wildfire mitigation strategy utilizes the WiNGS-Planning model as a tool in a multi-layered decision process that aids in the selection and application of wildfire mitigations for investment planning decisions. During 2022, SDG&E learned:

- In the face of growing climate change and to reflect its combined focus on reduction of PSPS events and wildfire risk reduction, the WiNGS-Planning model increasingly points to strategic undergrounding of infrastructure as the optimal grid hardening strategy.
- SDG&E’s retroactive review of mitigation selection shows that segments currently scoped for mitigation fall within the highest risk-bins across the overhead circuit segments in the HFTD, indicating the mitigation scoping process targets wildfire risk reduction.
- The long-term outlook of the WiNGS-Planning portfolio shows the deployment of strategic undergrounding and covered conductor not only reduces current wildfire risk but also combats the increasing wildfire risk due to climate change.

Refer to Section 7 Wildfire Mitigation Strategy Development for additional details.

1.1.1.3 Grid Design, Operations, and Maintenance

SDG&E continues to analyze its electric system to develop longer-term strategies that consider the changing climate and increasing wildfire risk, with a continued focus on mitigating PSPS impacts to customers. During 2022, SDG&E learned:

- Through joint IOU collaboration, covered conductor installation was tested in the lab environment to determine its effectiveness at reducing the risk of ignition. Collaboration and testing have continued to improve SDG&E’s understanding of covered conductor’s ability to raise PSPS wind speed thresholds, which (although not finalized) are expected to increase to 55 to 60 miles per hour. Testing is still ongoing, and details can be found in the response to Areas for Continued Improvement SDGE-22-11 in Appendix D.
- The Strategic Undergrounding Program continues to achieve its targets in undergrounding distribution infrastructure. Permitting delays continue to impact project schedules and SDG&E has partnered with neighboring utilities and created a permitting strike team to manage and expedite WMP-related permitting and agency approvals.
- Drone inspections can be utilized to perform detailed inspections and assess for damage that is not visible using ground-based inspections alone. The use of drones to perform risk-based inspections at locations with elevated fire risk can be an efficient replacement for time-based inspections when paired with intelligent models with the ability to process large amounts of data quickly with less dependency on human resources.
- The Strategic Pole Replacement Program will focus on the replacement of gas-treated poles in fire prone areas of the service territory, including Tier 2 and 3 of the HFTD and the Wildland

Urban Interface (WUI). The purpose of this program is to target high-risk poles that are gas treated and are set in concrete and steel reinforced, steel reinforced and set in soil, or set in soil, and are not scoped to be addressed by other programs such as the Covered Conductor Program or the Strategic Undergrounding Program.

Refer to Section 8.1 Grid Design, Operations, and Maintenance for additional details.

1.1.1.4 Vegetation Management and Inspections

SDG&E's Vegetation Management Program continues to reduce wildfire risk by exceeding regulatory requirements related to enhanced clearances, pole clearing, and additional inspection activities. SDG&E continues in its Fuels Management Program as a component of vegetation management to proactively mitigate the risk of ignition and propagation that could result from electrical equipment. In 2022, SDG&E learned:

- The Circuit Risk Index (CRI) and WRRM were effective in identifying higher-risk areas in the HFTD to prioritize and perform fuels modification activities. Aerial imagery was also determined to be a valuable tool to further refine targeted work locations.
- Customer engagement and the notification process for fuels modification was further streamlined to schedule and execute operations. In 2022, virtual townhall webinars were conducted to educate customers about the Fuels Management Program.
- Fuels modification activities begin in September after bird nesting season; however, this leaves a relatively condensed timeframe to complete the annual targeted goal of 500 poles. SDG&E will work with Environmental Services to determine earlier start dates for work locations where nesting birds would not be impacted.
- The current off-cycle patrol, which includes prioritizing the completion of the entire HFTD prior to September, posed some scheduling and resource challenges to meet that goal. The Company engaged a third-party to review the off-cycle schedule to determine whether there were advantages to modify the schedule based on a risk comparison of the Vegetation Management Areas (VMAs).

Refer to Section 8.2 Vegetation Management and Inspection for additional details on vegetation management and inspection initiatives.

1.1.1.5 Situational Awareness and Forecasting

Utilization of situational awareness tools such as weather stations, cameras, wireless fault indicators (WFIs), and the FPI has proven beneficial to system planning, emergency operations, and the safe implementation of PSPS. During 2022, SDG&E learned:

- The AI smoke detection algorithm can assist in identifying fires soon after ignition by operationalizing satellite fire detection coupled with mountaintop cameras.
- The Machine Learning Wind Gust model for HFTD weather stations (215 out of 222) promotes situational awareness beginning 72 hours prior to a PSPS or RFW event.
- There is a need for a technology strategy to support scalable complex modeling that performs dynamically in supporting operational decisions.

1.1.1.6 Emergency Preparedness

SDG&E enhanced its emergency preparedness plan in collaboration with key internal business units and external public safety partners. In 2022, SDG&E learned:

- Implementation of process flow tools can be used to improve the efficiency of notifications with public safety and other state partners.
- Through coordination with other IOUs, preregistering public safety partner information on a secure website improves completeness of data.
- Safety stand-downs at all operating centers were key to enhancing preparedness.

Refer to Section 8.4 Emergency Preparedness for additional details on emergency planning and preparedness initiatives.

1.1.1.7 Community Outreach and Engagement

SDG&E understands the important role all stakeholders play in achieving wildfire prevention and mitigation. In 2022, SDG&E increased its lines of communication and learned:

- Surveying customers, particularly affected customers, to assess campaign effectiveness and communication preferences can inform the development of future campaigns.
- Optimizing partnerships with 40 HFTD-focused CBOs and enhancing CBO partnerships in key areas (e.g., healthcare) is necessary to achieve the promotion and amplification of PSPS-related preparedness information to vulnerable populations.

Refer to Section 8.5 Community Outreach and Engagement for additional details.

1.1.1.8 PSPS

Given relatively temperate weather conditions in 2022, SDG&E did not experience any PSPS events during the calendar year. However, SDG&E continued its preparation and enhancements to PSPS readiness and response. In 2022, SDG&E learned:

- The WiNGS-Ops model was enhanced by retraining existing models with new historical observations, incorporating AFN customer impact scaling factors, and improving consequence calculations by estimating the impact of a risk event that could result in an ignition versus a proactive de-energization.
- Customer participation in PSPS resiliency programs is largely driven by the occurrence of PSPS events. To make certain that customers, especially vulnerable customers, experience the benefits of these programs, SDG&E created a dedicated reserve of backup battery units to deliver during PSPS events. This provides support to those qualified customers who have not yet participated in resiliency programs, as well as prior participants who have received a unit and need additional capacity.
- The Vegetation Risk Index (VRI) is a situational awareness tool that categorizes circuits and transmission lines based on tree species, tree height, tree count, and historical vegetation-related outages. To date, SDG&E has used the VRI as a component of its PSPS decision making. SDG&E is seeking to supplant the VRI with a predictive component of the WiNGS-Ops model to assess the likelihood of vegetation-related failures. SDG&E will maintain the use of the VRI for other operations, including vegetation management.

1.2 Summary of 2023–2025 Base WMP

For the 2023-2025 WMP cycle, SDG&E will continue to innovate and improve wildfire mitigation initiatives to promote community safety through enhancing risk-informed strategies, advancing technology integration, and enhancing stakeholder engagement. Enhancing risk-informed strategies includes continuous evolution and improvement of risk modeling approaches and further expansion of the use of risk models and analytics to inform mitigation selection and prioritization. Within this WMP cycle SDG&E will explore the use of models to develop risk-informed strategies for asset management and integration of risk analysis into annual, off-cycle HFTD and at-risk patrols for electric distribution infrastructure and vegetation management.

Advancing technology integration spans multiple areas of the WMP and includes continuous evaluation and implementation of new technologies to enhance mitigation efforts such as further advancing data science methodologies to improve predictive analytics and explore further automation of fire detection capabilities. Finally, wildfire mitigation and preparedness are community efforts that spans disciplines, jurisdictions, and tools; therefore, stakeholder engagement continues to be a key component of the WMP. SDG&E aims to continue and expand collaboration with academia and agencies to continue to support communities and protect customers from the risks of wildfire and PSPS impacts.

1.2.1 Framework

Safety is SDG&E’s highest priority and is reflected in its mission to “improve lives and communities by building the cleanest, safest, and most reliable energy infrastructure company in America.” Safety is at the heart of SDG&E’s enterprise goals and objectives and drives the framework under which this WMP is developed. The Enterprise Risk Management Framework shown in Figure 1-1 demonstrates the relationship between safety, wildfire risk identification and assessment, and the development of wildfire mitigation initiatives. The Enterprise Risk Management Framework is discussed in more detail in Section 4.4 Risk Informed Framework.

Figure 1-1: Enterprise Risk Management Framework for Development of the WMP

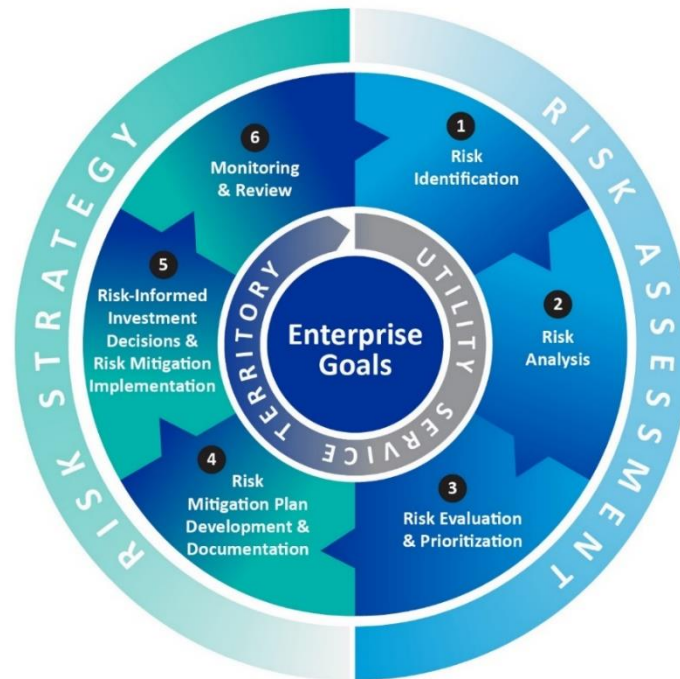

1.2.2 Goal of the WMP

In accordance with California Public Utilities Code (PUC) § 8386(a), SDG&E constructs, maintains, and operates its electric system in a manner that minimizes the risk of catastrophic wildfire posed by its electric power lines and equipment. Building on over 10 years of wildfire prevention and mitigation work, the 2023 WMP continues to focus on reducing wildfire risk and reducing the impact of PSPS events on customers.

1.2.3 Plan Objectives

SDG&E continually pursues opportunities to enhance risk modeling and reflect upon real-world lessons to inform its wildfire mitigation initiatives and strategies. The WINGS-Planning model has incorporated additional inputs and refinements leading to an anticipated portfolio of approximately 1,500 miles of strategic undergrounding of electric lines and 370 miles of covered conductor to be installed between 2022 and 2032. SDG&E anticipates continued refinement of its strategy as new information including climate change, weather patterns, and mitigation effectiveness is studied and validated.

SDG&E’s grid hardening programs are aimed at reducing the risk of wildfires caused by utility equipment and minimizing impacts from PSPS events. Progress in the Covered Conductor and Strategic Undergrounding Programs will continue in an effort to prevent risk events from occurring such as energized wire downs and foreign object contacts and to mitigate the likelihood of risk events evolving into an ignition. In addition to these grid hardening efforts, SDG&E will continue the implementation of specific equipment risk mitigation upgrades such expulsion fuse replacements, installation of additional

sectionalizing, and upgrading to supervisory control and data acquisition (SCADA) devices across the system. SDG&E will further advance implementation of new technologies such as Advance Radio Frequency Sensors (ARFS), which officially kicked-off in mid-2022 after completing a 2-year demonstration. By expanding the use and development of enhanced inspection technologies such as infrared inspections of overhead distribution, drone assessments, and IIP, SDG&E will improve its ability to detect damage and collect data on distribution and vegetation.

Enhancements to the Vegetation Management Program include tracking and maintaining its asset (tree and pole) database for all activities including detailed and off-cycle inspection, trimming and removals and enhanced vegetation management, pole brushing, and auditing. Improvements to the work management system on the server side of the application (CitiWorks) and the mobile application (Epoch) have enabled the creation of specialized Dispatch Work Orders (DWOs) to support off-cycle patrol inspections and enhanced vegetation management. Additional data collection enhancements include the collection of inventory tree Genus-species, electronic customer refusal tracking, and additional GIS mapping layers for improved situational awareness.

In the 2023 to 2025 WMP cycle, technological advancements for fire science modeling and weather analysis will continue, including automation in fire detection capabilities, exploring sensor technologies for portable monitoring in field trucks, exploring smoke plume modeling technology, and building new machine learning wind speed and gust models. Additionally, SDG&E plans to continue its partnership with academia to further develop fire science for integration into the Santa Ana Wind Threat Index (SAWTI) and FPI models as well as explore and evaluate large computational resources to include a module for impact of large eddy scale weather. Through the creation of the WCRC in 2023, SDG&E will also work to bring together leading thinkers and problem solvers in academia, government, and the community to create forward-looking solutions, helping prevent ignitions, mitigating the impacts of fires, and ultimately build a more resilient and prepared region.

The Emergency Management business unit continues to coordinate safe and effective emergency preparedness for the Company, customers, and emergency response personnel. As part of its commitment to continuous improvement, SDG&E has established a comprehensive After-Action Review (AAR) process that follows Emergency Operations Center (EOC) activations, which includes workshops with both internal and external stakeholders to gather lessons learned to inform any corrective actions. SDG&E plans to expand Emergency Management Operations by increasing staff dedicated to enhancing various emergency programs, modifying workforce training, streamlining processes and documentation management, improving collaboration by developing a software solution allowing for third-party access, and creating dashboards that incorporate Human Factors Engineering (HFE) into PSPS decision-making tools. In addition to continuing the implementation of grid hardening initiatives and resiliency programs to reduce the likelihood and consequences of PSPS events for customers, SDG&E is committed to expanding its education and communication efforts related to promote additional preparedness and resiliency during PSPS events.

2 Responsible Persons

Executive-level owner with overall responsibility

Name, Title	Brian D’Agostino, Vice President – Wildfire & Climate Science
Email	BDAgostino@sdge.com
Phone	(619)372-8010

Program owners specific to each section of the plan

SDG&E Table 2-1 provides the program owner for each section of the 2023-2025 Wildfire Mitigation Plan (WMP). For any questions related to this WMP or the activities described herein, San Diego Gas & Electric’s (SDG&E or Company) designated single point of contact is Kari Kloberdanz, Regulatory Business Manager: kkloberdanz@sdge.com, (415) 346-2386.

SDG&E Table 2-1: WMP Section Program Owners

Section	Name	Title	Email	Phone Number	Component
Section 1: Executive Summary	Jonathan Woldemariam	Director – Wildfire Mitigation	JWoldemariam@sdge.com	(858) 650-4084	Entire Section
Section 2: Responsible Persons	Jonathan Woldemariam	Director – Wildfire Mitigation	JWoldemariam@sdge.com	(858) 650-4084	Entire Section
Section 3: Statutory Requirements Checklist	Kari Kloberdanz	Regulatory Business Manager	kkloberdanz@sdge.com	(415) 346-2386	Entire Section
Section 4: Overview of WMP	Jonathan Woldemariam	Director – Wildfire Mitigation	JWoldemariam@sdge.com	(858) 650-4084	Entire Section
Section 5: Overview of the Service Territory	Shaun Gahagan	Wildfire Mitigation Program Manager	SGahagan@sdge.com	(858) 503-5124	Section 5.1 Section 5.2
Section 5: Overview of the Service Territory	Sandeep Aujla	Director – Fire Science & Climate Adaptation	SAujla@sdge.com	(646) 662-0197	Section 5.3
Section 5: Overview of the Service Territory	Thomas Porter	Director – Emergency Management	TPorter@sdge.com	(619) 936-5553	Section 5.4
Section 6: Risk Methodology and Assessment	Joaquin Sebastian Peral	Risk Analytics Manager	jsebasti@sdge.com	(619) 676-6616	Entire Section
Section 7: Wildfire Mitigation Strategy Development	Nisha Menon	Wildfire Mitigation Program Strategy Manager	nmenon@sdge.com	(858) 654-8237	Entire Section
Section 8.1: Wildfire Mitigations	Shaun Gahagan	Wildfire Mitigation Program Manager	SGahagan@sdge.com	(858) 503-5124	Section 8.1

Section	Name	Title	Email	Phone Number	Component
(Grid Design, Operations, and Maintenance)					
Section 8.2: Wildfire Mitigations (Vegetation Management)	Oliva Reyes	Director – Construction & Vegetation Management	OReyes@sdge.com	(510) 579-6948	Section 8.2
Section 8.3: Wildfire Mitigations (Situational Awareness and Forecasting)	Sandeep Aujla	Director – Fire Science & Climate Adaptation	SAujla@sdge.com	(646) 662-0197	Section 8.3
Section 8.4: Wildfire Mitigations (Emergency Preparedness)	Thom Porter	Director – Emergency Management	TPorter@sdge.com	(619) 676-4286	Section 8.4
Section 8.5: Wildfire Mitigations (Community Outreach and Engagement)	Allison Torres	Senior Communications Manager	ATorres@sdge.com	(858) 650-4025	Section 8.5
Section 9: Public Safety Power Shutoff	Jonathan Woldemariam	Director – Wildfire Mitigation	JWoldemariam@sdge.com	(858) 650-4084	Entire Section
Section 10: Lessons Learned	Jonathan Woldemariam	Director – Wildfire Mitigation	JWoldemariam@sdge.com	(858) 650-4084	Entire Section
Section 11: Corrective Action Program	Shaun Gahagan	Wildfire Mitigation Program Manager	SGahagan@sdge.com	(858) 503-5124	Entire Section
Section 12: Notices of Violation and Defect	Shaun Gahagan	Wildfire Mitigation Program Manager	SGahagan@sdge.com	(858) 503-5124	Entire Section

3 Statutory Requirements Checklist

OEIS Table 3-1: Statutory Requirements Checklist

PUC ¹ § 8386	Description	WMP Section/Page
(c)(1)	An accounting of the responsibilities of person(s) responsible for executing the plan	Section 2, p. 11
(c)(2)	The objectives of the plan.	Section 4.2, p. 16
(c)(3)	A description of the preventive strategies and programs to be adopted by the electrical corporation to minimize the risk of its electrical lines and equipment causing catastrophic wildfires, including consideration of dynamic climate change risks.	Section 8.1, p. 135 Section 8.2, p. 259 Section 8.3, p. 297 Section 8.4, p. 340 Section 8.5, p. 393
(c)(4)	A description of the metrics the electrical corporation plans to use to evaluate the plan's performance and the assumptions that underlie the use of those metrics.	Section 8.1.1.1, p. 137 Section 8.1.1.3, p. 151 Section 8.2.1.1, p. 261 Section 8.2.1.3, p. 266 Section 8.3.1.1, p. 298 Section 8.3.1.3, p. 304 Section 9.1.4, p.420 Section 9.1.5, p.424
(c)(5)	A discussion of how the application of previously identified metrics to previous plan performances has informed the plan.	Section 10, p. 432
(c)(6)	A description of the electrical corporation's protocols for disabling reclosers and deenergizing portions of the electrical distribution system that consider the associated impacts on public safety. As part of these protocols, each electrical corporation shall include protocols related to mitigating the public safety impacts of disabling reclosers and deenergizing portions of the electrical distribution system that consider the impacts on all of the aspects listed in PU Code 8386c	Section 8.1.8.1.1, p. 241 Section 9.2, p. 425
(c)(7)	A description of the electrical corporation's appropriate and feasible procedures for notifying a customer who may be impacted by the deenergizing of electrical lines, including procedures for those customers receiving medical baseline allowances as described in paragraph (6). The procedures shall direct notification to all public safety offices, critical first responders, health care facilities, and operators of telecommunications infrastructure with premises within the footprint of potential de-energization for a given event.	Section 8.4.4 p. 380 Section 8.4.2.1.7 p. 351 Section 8.5.2.1.3 p. 399
(c)(8)	Identification of circuits that have frequently been deenergized pursuant to a de-energization event to mitigate the risk of wildfire and the measures taken, or planned to be taken, by the electrical corporation to reduce the need for, and impact of, future de-energization of those circuits, including, but not limited to, the estimated annual decline in circuit de-energization and de-energization impact on customers, and replacing, hardening, or undergrounding any portion of the circuit or of upstream transmission or distribution lines.	Section 9.1.2, p. 414
(c)(9)	Plans for vegetation management	Section 8.2, p. 259

¹ California Public Utilities Code

PUC ¹ § 8386	Description	WMP Section/Page
(c)(10)	Plans for inspections of the electrical corporation's electrical infrastructure	Section 8.1.5, p. 227
(c)(11)	A description of the electrical corporation's protocols for the de-energization of the electrical corporation's transmission infrastructure, for instances when the de-energization may impact customers who, or entities that, are dependent upon the infrastructure.	Section 9.2, p. 425
(c)(12)	A list that identifies, describes, and prioritizes all wildfire risks, and drivers for those risks, throughout the electrical corporation's service territory, including all relevant wildfire risk and risk mitigation information that is part of the Safety Model Assessment Proceeding and the Risk Assessment Mitigation Phase filings	Section 7.1.3 p. 108 Section 7.1.4 p. 110
(c)(13)	A description of how the plan accounts for the wildfire risk identified in the electrical corporation's Risk Assessment Mitigation Phase filing	Section 6, p. 51
(c)(14)	A description of the actions the electrical corporation will take to ensure its system will achieve the highest level of safety, reliability, and resiliency, and to ensure that its system is prepared for a major event, including hardening and modernizing its infrastructure with improved engineering, system design, standards, equipment, and facilities, such as undergrounding, insulating of distribution wires, and replacing poles	Section 4.2, p. 16
(c)(15)	A description of where and how the electrical corporation considered undergrounding electrical distribution lines within those areas of its service territory identified to have the highest wildfire risk in a commission fire threat map	Section 8.1.2.2, p. 158
(c)(16)	A showing that the electrical corporation has an adequately sized and trained workforce to promptly restore service after a major event, taking into account employees of other utilities pursuant to mutual aid agreements and employees of entities that have entered into contracts with the electrical corporation.	Section 8.4.2.2, p. 352
(c)(17)	Identification of any geographic area in the electrical corporation's service territory that is a higher wildfire threat than is currently identified in a commission fire threat map, and where the commission should consider expanding the high fire threat district based on new information or changes in the environment.	Section 5.3.3, p. 31
(c)(18)	A methodology for identifying and presenting enterprise-wide safety risk and wildfire-related risk that is consistent with the methodology used by other electrical corporations unless the commission determines otherwise.	Section 4.4, p. 19 Section 6.1, p. 51
(c)(19)	A description of how the plan is consistent with the electrical corporation's disaster and emergency preparedness plan prepared pursuant to Section 768.6, including plans to restore service and community outreach	Section 8.4, p. 340 Section 8.5, p. 393
(c)(20)	A statement of how the electrical corporation will restore service after a wildfire.	Section 8.4.5.1, p. 384
(c)(21)	Protocols for compliance with requirements adopted by the commission regarding activities to support customers during and after a wildfire, outage reporting, support for low-income customers, billing adjustments, deposit waivers, extended payment plans, suspension of disconnection and nonpayment fees, repair processing and timing, access to electrical corporation representatives, and emergency communications.	Section 8.4.6, p. 390 Section 8.5.2, p. 398
(c)(22)	A description of the processes and procedures the electrical corporation will use to do the following: A. Monitor and audit the implementation of the plan. B. Identify any deficiencies in the plan or the plan's implementation and correct those deficiencies.	Section 10, p. 432 Section 11, p. 443 Section 12, p. 448

PUC ¹ § 8386	Description	WMP Section/Page
	C. Monitor and audit the effectiveness of electrical line and equipment inspections, including inspections performed by contractors, carried out under the plan and other applicable statutes and commission rules.	

4 Overview of WMP

4.1 Primary Goal

In accordance with California Public Utilities Code (PUC) § 8386(a), an electrical corporation must satisfy the following primary goal:

Each electrical corporation shall construct, maintain, and operate its electrical lines and equipment in a manner that will minimize the risk of catastrophic wildfire posed by those electrical lines and equipment.

In accordance with PUC § 8386(a), SDG&E constructs, maintains, and operates its electric system in a manner that minimizes the risk of catastrophic wildfire posed by its electric power lines and equipment. Building on over 10 years of wildfire prevention and mitigation work, the 2023-2025 WMP continues to focus on reducing wildfire risk and reducing the impact of Public Safety Power Shutoff (PSPS) events on customers. Each year, SDG&E identifies ways to improve its wildfire prevention and mitigation efforts through enhancing or expanding existing programs and developing and implementing new efforts. Three-year and ten-year objectives for each category are described in Section 4.2 Plan Objectives.

4.2 Plan Objectives

4.2.1 Risk Methodology and Assessment

SDG&E continues to explore opportunities to enhance its risk models to improve its analytics capabilities and further utilize its models to inform decision-making. A risk modeling improvement plan has been developed that includes evaluation of additional factors in risk models such as social vulnerability, impacts of climate change, and further breaking out the assessment of risk drivers. Additionally, modeling design and architecture will continue to be enhanced, enabling tracking and validation of various model risk components, establishing a formalized process for conducting independent reviews, and further exploring the expanded use of models to inform selection and prioritization of initiatives other than covered conductor and undergrounding.

4.2.2 Wildfire Mitigation Strategy

SDG&E's wildfire mitigation strategy continues to evolve with the improvements and enhancements made to risk modeling and the real-world lessons learned through initiative implementation. The Wildfire Next Generation System Planning (WiNGS)-Planning model has incorporated additional inputs and refinements leading to a portfolio of approximately 1,500 miles of strategic undergrounding and 370 miles of covered conductor to be installed between 2022 and 2032. This portfolio will reduce the risk of wildfire by 83 percent and will significantly reduce the impacts of PSPS events to customers on frequently impacted circuits. This strategy will continue to be refined as new information including climate change, weather patterns, and mitigation effectiveness is studied and validated.

4.2.3 Grid Design, Operations, and Maintenance

SDG&E's grid hardening programs are aimed at reducing the risk of wildfires caused by utility equipment and minimizing impacts to customers from mitigations such as PSPS events. Programs such as the Covered Conductor Program (WMP.455) will prevent risk events from occurring across several drivers such as energized wire down and foreign object contact. SDG&E will continue to advance its covered conductor and strategic undergrounding efforts in addition to implementing specific equipment upgrades such as expulsion fuse replacements, installation of additional sectionalizing, and upgrading to supervisory control and data acquisition (SCADA) devices across the system (WMP.453). SDG&E will further advance implementation of new technologies such as Advanced Radio Frequency Sensors (ARFS) which officially kicked-off in mid-2022 after completing a 2-year demonstration. Additionally, by expanding the use and development of enhanced inspection technologies such as infrared inspections of overhead distribution (WMP.481), drone assessments (WMP.552), and Intelligent Image Processing (IIP) (WMP.1342), SDG&E will be able to detect damage and collect data on distribution and vegetation.

4.2.4 Vegetation Management and Inspections

Enhancements to the Vegetation Management Program include tracking and maintaining its asset (tree and pole) database (WMP.511) for all activities including detailed (WMP.494) and off-cycle inspection (WMP.508), trimming and removals and enhanced vegetation management (WMP.501), pole brushing (WMP.512), and auditing (WMP.505). Improvements to the work management system on the server side of the application (CitiWorks) and the mobile application (Epoch) have enabled the creation of specialized Dispatch Work Orders (DWOs) to support off-cycle patrol inspections and enhanced vegetation management. Additional data collection enhancements include the collection of inventory tree Genus-species, electronic customer refusal tracking, and additional GIS mapping layers for improved situational awareness.

4.2.5 Situational Awareness and Forecasting

The Fire Science and Climate Adaptation (FSCA) business unit continues to play a critical role in SDG&E's wildfire mitigation efforts responding to and strategizing for fire preparedness activities and climate resilience related programs. In this WMP cycle, SDG&E plans to continue technological advancements for fire science modeling and weather analysis including fully automating fire detection capabilities, exploring sensor technologies for portable monitoring in field trucks, exploring smoke plume modeling technology, and building new machine learning wind speed and gust models. Additionally, SDG&E plans to continue its partnership with academia to further develop fire science for integration into Santa Ana Wind Threat Index (SAWTI) (WMP.540) and Fire Potential Index (FPI) (WMP.450) as well as evaluate large computational resources to include a module for impact of large eddy scale weather. The creation of a Wildfire & Climate Resiliency Center (WCRC) in 2023 will also bring together leading thinkers and problem solvers in academia, government, and the community to create forward-looking solutions to help prevent ignitions, mitigate the impacts of fires, and ultimately help build a more resilient region.

4.2.6 Emergency Preparedness

As part of its commitment to continuous improvement, SDG&E has established a comprehensive After-Action Review (AAR) process that follows Emergency Operations Center (EOC) activations, which

includes workshops with both internal and external stakeholders to gather lessons learned to inform any corrective actions. SDG&E plans to expand Emergency Management Operations by increasing staff dedicated to enhancing various emergency programs, modifying workforce training, streamlining processes and documentation management, improving collaboration by developing a software solution allowing for third-party access, and creating dashboards that incorporate Human Factors Engineering (HFE) into PSPS decision-making tools (WMP.1335). Emergency preparedness also entails working with community partners and stakeholders by incorporating effectiveness outreach survey feedback, expanding Tribal and Access and Functional Needs (AFN) campaigns, Community Based Organizations (CBOs) and local school districts.

4.2.7 Community Outreach and Engagement

SDG&E recognizes that collaboration, the sharing of best practices, and the exchange of lessons learned is of the utmost importance to protect public safety. In an effort to identify gaps in its processes and outreach efforts, SDG&E regularly solicits feedback from its partners and communities it serves (WMP.1337). SDG&E continues to refine and augment its year-round safety education and communication campaigns, enhancing mobile application and communication platforms, leveraging school communication platforms, and expanding public education to AFN, Limited English Proficiency (LEP) populations and Tribal communities (WMP.1336)

4.2.8 Public Safety Power Shutoff

Reducing the impacts of PSPS continues to be a core goal for SDG&E. In addition to continuing the implementation of grid hardening initiatives and resiliency programs to reduce the likelihood and consequences of PSPS for customers, SDG&E is committed to expanding its education and communication efforts related to wildfire safety to PSPS targeted customers throughout the service territory (WMP.563). Furthermore, SDG&E evaluates many factors before deciding to shutoff power by the weather network and is committed to enhancing assessment strategies to further opportunities to increase PSPS thresholds. WiNGS-Ops will evolve to assess wildfire risk and study customer impacts of PSPS events. As technology becomes more sophisticated, modeling efforts will be improved by increasing granularity and accuracy in PSPS risk assessments in WiNGS-Ops and integrating the FPI into the Network Management System (NMS) for future protective equipment threshold setting improvements (WMP.1338).

4.3 Proposed Expenditures

OEIS Table 4-1: Summary of WMP Expenditures

Year	Spend (thousands \$USD)
2020	Planned (as reported in the 2020 WMP) = \$444,544 Actual = \$569,237 $\Delta = +\$124,693$
2021	Planned (as reported in the 2021 WMP) = \$646,466 Actual = \$543,912 $\Delta = -\$102,554$
2022	Planned (as reported in the 2022 WMP) = \$770,393

Year	Spend (thousands \$USD)
	Actual = \$639,443 △ = -\$130,950
2023	Planned = \$769,741
2024	Planned = \$760,622
2025	Planned = \$811,323

Figure 4-1: Summary of WMP Expenditures

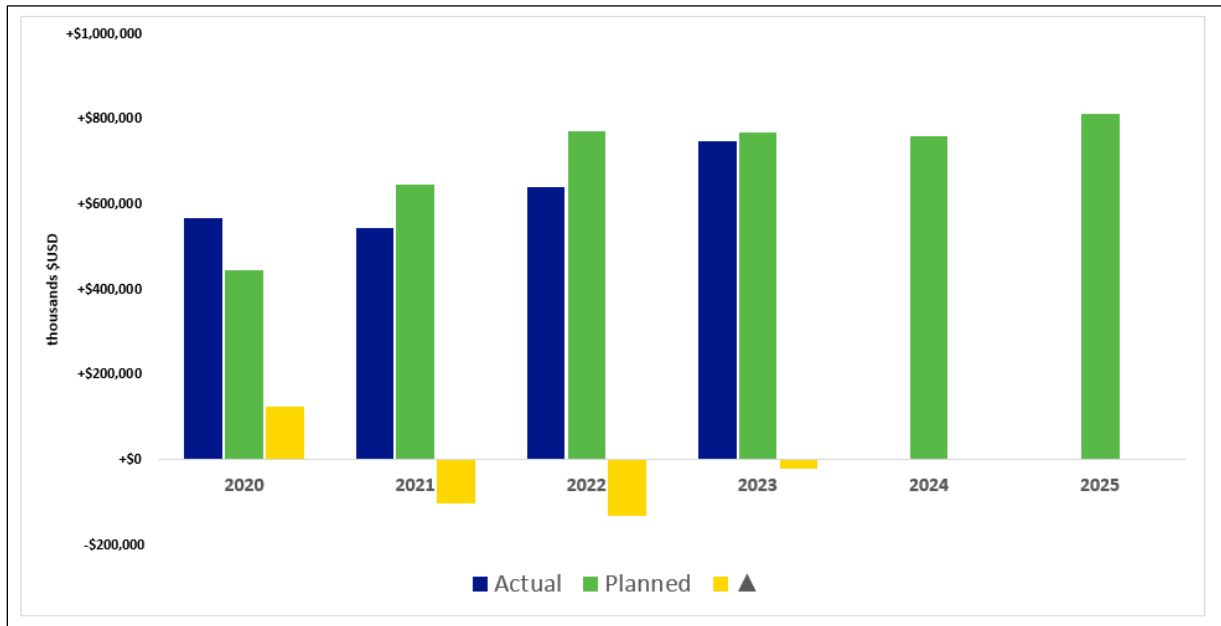

4.4 Risk Informed Framework

This WMP is developed using SDG&E’s Enterprise Risk Management Framework, which is modeled after an internationally recognized risk management standard, ISO 31000. The framework consists of an enterprise risk management governance structure. This addresses the roles of employees at various levels up to SDG&E’s Board of Directors, along with various risk processes and tools. One such procedure is the enterprise risk management process, which defines enterprise goals, analyzes the service territory, identifies, manages, and mitigates enterprise risks, and provides consistent, transparent, and repeatable results.

This process is aligned with the Cycla Corporation’s 10-Step Evaluation Method, which was adopted by the California Public Utilities Commission (CPUC) “as a common yardstick for evaluating maturity, robustness, and thoroughness of utility Risk Assessment and Mitigation Models and risk management frameworks.”² While the lexicon used by Cycla differs slightly from that of SDG&E, the content is largely aligned. SDG&E initiates its enterprise risk management process annually, resulting in the Enterprise Risk

² D.16-08-018 at 195, Ordering Paragraph 4.

Registry (ERR), an inventory of enterprise risks. The CPUC defines an ERR as “[a]n inventory of enterprise risks at a snapshot in time that summarizes (for a utility’s management and/or stakeholders such as the CPUC) risks that a utility may face. The ERR must be refreshed on a regular basis and can reflect the changing nature of a risk; for example, risks that were consolidated together may be separated, new risks may be added, and the level of risks may change over time.”³

The ERR thus presents enterprise-level risks, including safety-related and wildfire-related risks. Each risk has one or more risk owner(s)—a member of the senior management team who is ultimately responsible and accountable for the risk—and one or more risk manager(s) responsible for ongoing risk assessments and overseeing implementation of risk management plans. See Section 2 Responsible Persons.

Input from risk managers and risk owners is used to ultimately finalize the ERR. Therefore, the Enterprise Risk Management Framework is both a “bottom-up” and “top-down” approach.

In addition, each risk in the ERR has an associated set of mitigations (i.e., projects or programs that reduce the likelihood of the risk and/or negative consequences should the risk occur). Notwithstanding these risk management and mitigation efforts, however, adverse events will occur. When that happens, efforts, including implementation of response plans, development of role and responsibility descriptions and checklists, and facilitation of training and exercises, are designed to prepare the Company to respond safely and effectively to those adverse events that occur despite mitigation efforts.

Figure 4-2 describes SDG&E’s Enterprise Risk Management Framework.

³ D.18-12-014 at 16-17.

Figure 4-2: Enterprise Risk Management Framework

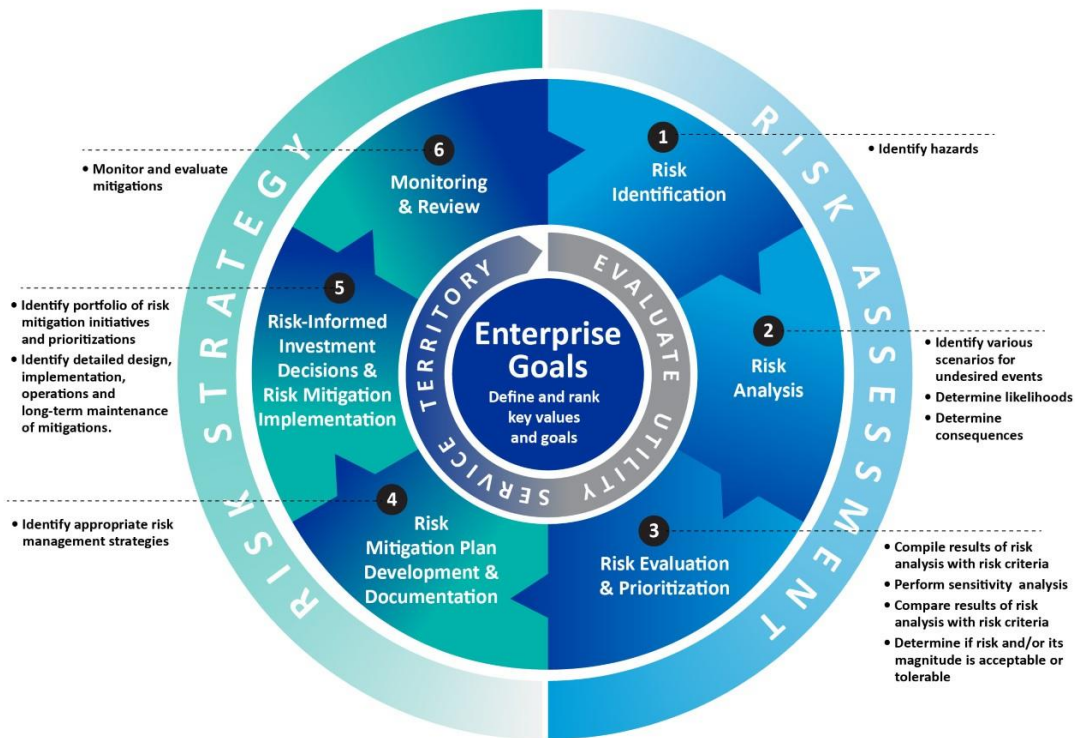

4.4.1 Risk Assessment: Identification, Analysis, Evaluation, and Prioritization

In the Enterprise Risk Management Framework, as explained in SDG&E’s 2021 Risk Assessment Mitigation Phase (RAMP),⁴ risk identification is the process of finding, recognizing, and describing risks. The Enterprise Risk Management organization first works with various business units to update existing risk information and identify enterprise-level risks that have emerged or accelerated since the last assessment. This includes the identification of risk events, their causes, and potential consequences. This is then summarized in a "Risk Bow Tie" as shown in Figure 6-7: WiNGS Planning Calculation Schematic and Figure 6-8: WiNGS-Ops Calculation Schematic. The Risk Bow Tie is “[a] tool that consists of a Risk Event in the center, a listing of drivers on the left side that potentially lead to the Risk Event occurring, and a listing of Consequences on the right side that show the potential outcomes if the Risk Event occurs.”⁵

The Enterprise Risk Management Framework also includes risk evaluation.⁶ For the ERR, risks are evaluated using a 7 X 7 matrix with impact and frequency as the risk dimensions. The evaluation of the Enterprise risks using the 7 X 7 matrix is performed on a residual basis (i.e., after considering controls) resulting in a residual risk score. For purposes of SDG&E’s 2021 RAMP filing, the methodology or framework utilized to calculate risk scores, including for Wildfire risk, was the Multi-attribute Value

⁴ Application 21-05-011, Application of SDG&E to Submit its 2021 RAMP Report (May 17, 2021) (2021 RAMP), Chapter RAMP-B at B-3.

⁵ D.18-12-014 at 16.

⁶ See 2021 RAMP, Chapter RAMP-B at B-5 - B-6.

Function (MAVF) method adopted by the Safety Model and Assessment Proceeding (S-MAP)⁷ and resulting Settlement.

The S-MAP puts forth a consistent framework to be applied in future RAMP and General Rate Case (GRC) filings for identifying and evaluating risk across all California utilities, making the Enterprise Risk Management Framework generally consistent with other utilities' approaches. Notably, SDG&E was the first utility to apply the new quantitative risk methodology adopted in the S-MAP and is continuing to review opportunities for improvement and lessons learned from the new approach, including the feedback received in the open RAMP review process.

4.4.2 Risk Strategy: Plan Development, Investment Decisions, Implementation, and Review

The WMP is developed by reviewing and understanding the risk within the service territory and identifying and prioritizing mitigations to address that risk. Information on the service territory is gathered through the use of weather stations, equipment failure reporting, and other means and is able to draw upon over a decade's worth of data. The mitigations within this WMP are developed utilizing information currently available to subject matter experts and are continuously reviewed and updated as new information becomes available.

SDG&E's initial plans were based on the known risk drivers and consequence information available over 10 years ago. For example, SDG&E's initial distribution overhead hardening program targeted the locations of small wire which was known to have a higher failure rate. Hardening was performed only on locations with the riskiest wire. It was prioritized based on location information such as the High-Risk Fire Area (HRFA) and Fire Threat Zones (FTZ) that predated the HFTD and the initial implementation of the Wildfire Risk Reduction Model (WRRM). Similarly, asset replacement programs such as fuse replacements and hot line clamps prioritized locations based on consequence risk by prioritizing assets in Tier 3 of the HFTD before moving into Tier 2.

SDG&E's mitigation efforts are now informed by evolving risk models that utilize more granular analysis at the circuit segment level. SDG&E has transitioned to hardening full segments, not partial ones, to achieve full risk reduction along with additional PSPS benefits. The WINGS-Planning model is consistently updated and improved with the latest information on both the risk of wildfire within the service territory and evolving data on the cost and efficacy of installing covered conductor and strategic undergrounding of electric lines. The modeling provides insight into how wildfire and PSPS risk reduction can be achieved across the service territory to protect the safety of customers and the environment, while maintaining reliability and affordability for ratepayers. The modeling results are reviewed by subject matter experts to provide real-world expertise on the feasibility of performing the chosen mitigation (installing covered conductor or undergrounding) considering constraints such as environmental concerns, geography, and community impacts.

Other SDG&E areas are also beginning to rely on risk models to improve programs. For example, SDG&E's distribution infrastructure inspections are moving to performing risk-based inspections. Following the success utilizing drones for inspections within the HFTD over the past 3 years, the time-based HFTD Tier 3 inspections will be replaced with drone inspections performed on the riskiest

⁷ D.18-12-014

structures within the HFTD. Structures where inspections are likely to have the biggest impact will be identified with a newly created risk. Similarly, the Vegetation Management Program will pursue the use of newly developed risk models to identify areas with the greatest risk and the prioritization of secondary inspections on these areas to be performed by the end of Q3 (September).

As new information or technology becomes available, new mitigations can be proposed by stakeholders throughout the company. New ideas and initiatives are obtained through collaborating with regulators and other utilities, evaluating risk event trends, and reviewing emerging technology. Each proposed mitigation is reviewed for feasibility and its potential costs and benefits before being approved and implemented.

Mitigations are reviewed throughout the year to understand if initiatives are achieving risk reduction targets, and the actual and forecasted costs for the year are also reviewed. Internal metrics dashboards are updated weekly to ensure all employees have visibility into the progress of wildfire mitigation initiatives. The estimated and recorded efficacy of risk-reducing mitigations are also reviewed using real-world information as it becomes available. This information will inform what changes, if any, are required for a specific mitigation or the portfolio. For example, as the per-mile costs of undergrounding has continued to reduce and the reduction of PSPS impacts are further considered, SDG&E’s risk modeling now recommends more mileage of undergrounding as compared to installing covered conductor.

SDG&E strives to provide clear and transparent decision-making processes as shown in its participation and collaboration in workshops, joint utility working groups, and throughout this WMP. SDG&E will continue to take feedback and make improvements based on guidance and lessons learned from Energy Safety, other utilities, and various other stakeholders.

OEIS Table 4-2 demonstrates the alignment of SDG&E’s Enterprise Risk Management Framework with the risk-informed framework established by Energy Safety in the 2023-2025 WMP Technical Guidelines.⁸

OEIS Table 4-2: Risk-Informed Approach Components

Component	Component Description	SDG&E Risk Management Process	WMP Section
1. Goals and plan objectives	Identify the primary goal(s) and plan objectives of the electrical corporation’s WMP.	Enterprise Goals	4.1 4.2
2. Scope of application	Define the physical characteristics of the system in terms of its major elements: electrical corporation service territory characteristics, electrical infrastructure, wildfire environmental settings, and various assets-at-risk. Knowledge and understanding of how individual system elements interface are essential to this step.	Evaluate Service Territory	5.1
3. Hazard Identification	Identify hazards and determine their likelihoods.	1. Risk Identification	6.2.1
4. Risk Scenario identification	Develop risk scenarios that could lead to an undesirable event. Risk scenario techniques that may be employed include event tree	2. Risk Analysis	6.3

⁸ Office of Energy Infrastructure Safety, 2023-2025 Wildfire Mitigation Plan Technical Guidelines (December 6, 2022), available at <https://efiling.energysafety.ca.gov/eFiling/Getfile.aspx?fileid=53286&shareable=true>.

Component	Component Description	SDG&E Risk Management Process	WMP Section
	analysis, fault tree analysis, preliminary hazard analysis, and failure modes and effects analysis.		
5. Risk analysis	Evaluate the likelihood and consequences of the identified risk scenarios to understand the potential impact on the desired goal(s) and plan objectives. The consequences are based on an array of risk components that are fundamental to overall utility risk, wildfire risk, and PSPS risk given the electrical corporation's scope of application and portfolio of wildfire mitigation initiatives.	2. Risk Analysis	6.2.2
6. Risk presentation	Consider how the risk analysis is presented to the various stakeholders involved.	3. Risk Evaluation & Prioritization	6.4
7. Risk evaluation	Identify criteria and procedures for identifying critical risk both spatially and temporally. Risk evaluation must also include, as a minimum, evaluating the seriousness, manageability, urgency, and growth potential of the wildfire hazard/risk. Risk evaluation should be used to determine whether the individual hazard/risk should be mitigated. Risk evaluation and risk-informed decision making should be done using a consensus approach involving a range of key stakeholder groups.	3. Risk Evaluation & Prioritization	7.1
8. Risk mitigation and management	Identify which risk management strategies are appropriate given practical constraints such as limited resources, costs, and time. The electrical corporation must indicate the high-level risk management approach, as determined in Step 7.	4. Risk Mitigation Plan Development & Documentation	7.2
8. Risk mitigation and management	Identify risk mitigation initiatives (or a portfolio of initiatives) and prioritize their spatial and temporal implementation. This step includes consideration of what risk mitigation strategies are appropriate and most effectively meet the intent of the WMP goal(s) and plan objectives, while still in balance with other performance objectives. Include the procedures and strategies to develop, review, and execute schedules for implementation of mitigation initiatives and activities	5. Risk-Informed Investment Decisions & Risk Mitigation Implementation	8 9
	Monitor and evaluate mitigations. Determine effectiveness of plan to inform ongoing risk management.	6. Monitoring & Review	10 11 12

5 Overview of the Service Territory

5.1 Service Territory

A crucial part of the Enterprise Risk Management Framework is the evaluation of the Utility Service Territory (see Figure 5-1). Understanding the territory under which SDG&E operates and the community it serves enables the necessary risk assessment and development of strategies. See Section 4.4 Risk Informed Framework for details on the Enterprise Risk Management Framework.

Figure 5-1: Utility Service Territory of the Enterprise Risk Management Framework

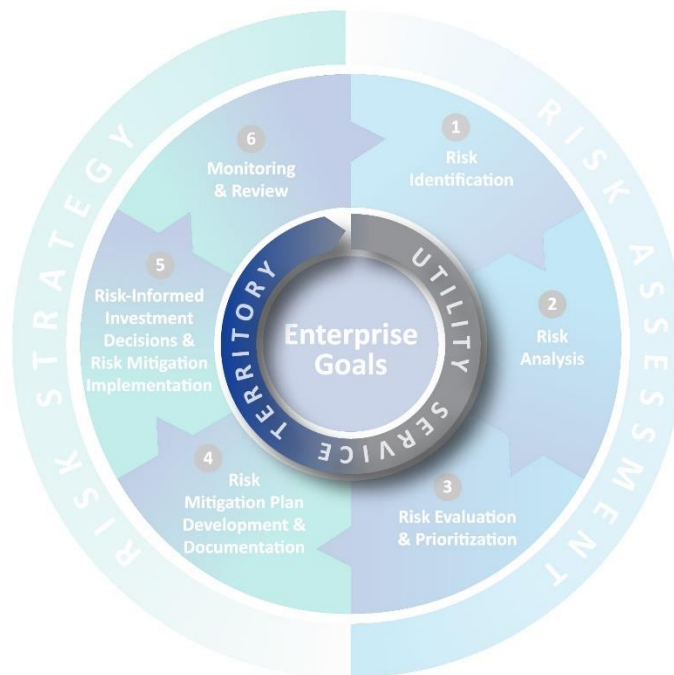

SDG&E supplies power to a population of 3.7 million people through 1.5 million electric meters across 25 communities in San Diego and southern Orange Counties. SDG&E’s service territory spans approximately 4,100 square miles of which 69 percent is located within the HFTD.

OEIS Table 5-1: Service Territory High-Level Statistics

Characteristics	HFTD	Non-HFTD	Total
Area Served (square miles)	2,821 square miles	1,275 square miles	4,096 square miles
Beach Cities District	14,056 meters	250,805 meters	264,861 meters
Eastern District	21,254 meters	199,825 meters	221,079 meters
Metro District	10,379 meters	373,962 meters	384, 341 meters
North Coast District	10,814 meters	234,717 meters	245,531 meters

Characteristics	HFTD	Non-HFTD	Total
Northeast District	90,570 meters	133,876 meters	224,446 meters
Orange County District	35,565 meters	97,027 meters	132,592 meters
Ramona Sub-District	18,850 meters	3,167 meters	22,017 meters
Mountain Empire Sub-District	8,225 meters	8 meters	8,233 meters
Total Customers Served	209,713 meters	1,293,387 meters	1,503,100 meters

Figure 5-2: Service Territory (polygons) and Distribution of Customers Served

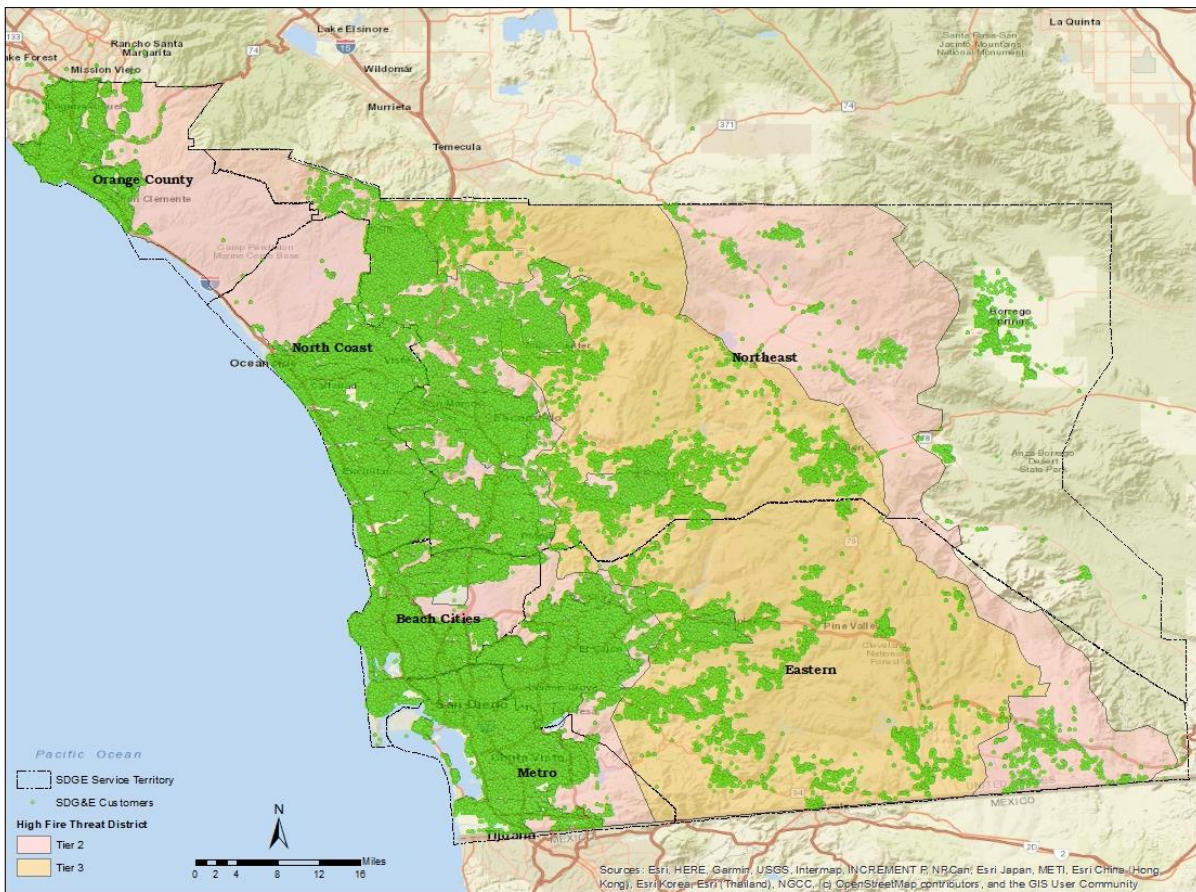

5.2 Electrical Infrastructure

SDG&E’s distribution infrastructure consists of 17,467 circuit miles (6,190 within the HFTD) across 1,056 circuits. Overhead distribution includes 6,393 circuit miles (3,434 within the HFTD) and 183,437 structures. Overhead distribution structures within the HFTD include 73,722 poles, of which 22,410 are steel.

SDG&E’s federal-jurisdictional transmission infrastructure consists of 1,993 circuit miles (1,037 within the HFTD) across 244 transmission lines. Overhead transmission includes 1,815 circuit miles (993 within

the HFTD) and 13,790 structures. Overhead transmission structures within the HFTD include 6,295 structures, of which 5,055 are steel poles or towers.

SDG&E’s substation infrastructure includes 134 distribution substations and 24 transmission substations for a total of 158 electric substations. Within these substations SDG&E operates and maintains seven synchronous condensers, 321 power transformers, 2,443 circuit breakers, and 263 capacitor banks.

SDG&E’s generation infrastructure includes four power generation plants. Located within the service territory SDG&E operates the Palomar Energy Center, a 588-megawatt gas-fired combined-cycle plant, the Miramar Energy Facility, a 92-megawatt peaking plant, and the Cuyamaca Peak Energy Plant, a 45-megawatt peaking plant. SDG&E also owns and operates the Desert Star Energy Center, a 480-megawatt combined-cycle plan located in Boulder City, NV.

OEIS Table 5-2: Overview of Key Electrical Equipment

Type of Equipment	HFTD	Non-HFTD	Total
Substations (#)	48	110	158
Power generation facilities (#)	1	3	4
Overhead transmission lines (circuit miles)	993	822	1,815
Overhead distribution lines (circuit miles)	3,434	2,959	6,393
Hardened overhead distribution lines (circuit miles)	944	67	1011
Hardened overhead transmission lines (circuit miles)	876	329	1,205
Underground transmission and distribution lines (circuit miles)	2,800	8,452	11,252
Distribution transformers (#)	52,038	118,514	170,552
Reclosers (#)	266	178	444
Poles (#)	78,711	116,425	195,136
Towers (#)	1,280	811	2,091
Microgrids (#)	5	1	6

5.3 Environmental Settings

5.3.1 Fire Ecology

5.3.1.1 Ecological Regions

Due to its diverse topography, geological conditions, and moderate climate, the San Diego region contains several rare and unique ecological and biological resources. The region encompasses a variety of habitats, such as marsh, coastal sage scrub, chaparral, grassland, riparian, woodlands, forest, and desert. See OEIS Table 5-3 for a list of existing vegetation types in the service territory. Several habitats and species in the region are considered sensitive by state and federal agencies, local jurisdictions, and conservation organizations. In fact, the San Diego region is considered a biological “hot spot” for

biodiversity and species endangerments, as many unique and endangered plant and animal species are found only in this region. One example is the region’s unique coastal sage scrub vegetation community. An important habitat for many species, coastal sage scrub is found from the coast to the mountain regions.

5.3.1.2 Climate and Weather Conditions

San Diego County is home to a diverse climate, given the complex topography and close proximity to the Pacific Ocean. Given that the prevailing westerly winds lead to onshore flow across the service territory, the Pacific Ocean significantly modifies temperatures. Typically, this area has cooler summers and warmer winters in comparison to other cities at similar latitudes, such as Dallas, TX or Montgomery, AL. The marine layer, which develops from onshore flow, brings increased humidity values and more mild temperatures into coastal areas.

Occasionally during the fall and winter months, synoptic weather systems bring offshore (easterly) flow across the service territory. Offshore flow tends to bring breezy winds and arid air from the deserts into the foothills, valleys, and coastal areas. This tends to increase fire potential when grass and fuels are dried out from the spring and summer months without any measurable rain. The highest fire potential usually occurs during the autumn months since this coincides with the climatologically hottest time of the year and the preceding dry season. An increase in “cut-off low” systems has also been seen over the past few years, which has increased complexity to the forecast. Small track shifts in these cutoff low systems can lead to significant shifts in wind flow across the service territory, allowing for more frequent chances for offshore wind events.

Average annual rainfall varies significantly across San Diego County, ranging from roughly 10 inches along the coast to 20 to 40 inches across the mountains. Most of the annual rainfall occurs during the late autumn and winter months via atmospheric river events. Monsoonal thunderstorms also bring rainfall during the summer months, but these storms are usually too localized to bring widespread changes to the fuel moisture content and fire potential landscape. It is important to note that over the past several years, San Diego has been below the 30-year climatological mean annual rainfall as drought continues to affect the Western U.S.

5.3.1.3 Fire Return Intervals

The area’s fire history, in combination with the service territory’s flora and fauna, has shown that fire burn areas return to a condition capable of carrying fire within 5 to 10 years. They return to peak burn potential within 15 to 20 years. There are numerous variables impacting these calculations including precipitation patterns, fuels management projects, and subsequent fires.

OEIS Table 5-3: Existing Vegetation Types in the Service Territory

Vegetation Type	Acres	Percentage of Service Territory
Mixed Chaparral	663,090.0	23.58%
Desert Scrub	420,101.3	14.94%
Coastal Scrub	310,435.7	11.04%
Chamise-Redshank Chaparral	230,637.0	8.20%
Annual Grassland	146,159.5	5.20%

Vegetation Type	Acres	Percentage of Service Territory
Coastal Oak Woodland	91,299.2	3.25%
Perennial Grassland	60,768.9	2.16%
Juniper	45,071.9	1.60%
Montane Hardwood	30,494.0	1.08%
Valley Foothill Riparian	29,549.7	1.05%
Lacustrine	24,825.8	0.88%
Desert Succulent Shrub	21,246.6	0.76%
Montane Chaparral	12,056.2	0.43%
Montane Hardwood-Conifer	11,987.0	0.43%
Montane Riparian	10,561.5	0.38%
Pinyon-Juniper	9,939.9	0.35%
Alkali Desert Scrub	7,246.5	0.26%
Jeffrey Pine	6,447.0	0.23%
Sagebrush	6,050.7	0.22%
Wet Meadow	5,509.8	0.20%
Sierran Mixed Conifer	4,911.6	0.17%
Desert Riparian	4,421.6	0.16%
Saline Emergent Wetland	3,101.5	0.11%
Closed-Cone Pine-Cypress	3,099.7	0.11%
Eucalyptus	2,916.9	0.10%
Fresh Emergent Wetland	2,822.6	0.10%
Estuarine	848.9	0.03%
White Fir	387.9	0.01%
Eastside Pine	194.4	0.01%
Palm Oasis	56.9	0.002%
Bitterbrush	19.6	0.001%
Other (Urban, Cropland, Barren, etc.)	645,599.6	22.96%
Total		100.00%

5.3.2 Catastrophic Wildfire History

There have been two utility-ignited fire events in the service territory in the past 20 years that met the given definition of a catastrophic fire (See Appendix A for definition). Both events occurred during the same storm in October of 2007. The Witch Creek-Guejito Fire⁹ and the Rice Fire¹⁰ began during an extremely strong Santa Ana wind event. That wind event resulted in at least 15 fires in the southern

⁹ Source: https://web.archive.org/web/20190115032722/http://cdfdata.fire.ca.gov/incidents/incidents_details_info?incident_id=225

¹⁰ Source: <https://www.fire.ca.gov/incidents/2007/10/22/rice-fire/>

California region that reached over 1,000 acres in the span of 10 days. Since 2007, there has not been a fire in the service territory that meets the definition of a catastrophic fire.

Since 2007, SDG&E has continued to report utility related ignition consistent with Decision (D.)19-07-015¹¹ on an annual basis and has built a culture of fire prevention and mitigation.

The service territory has experienced catastrophic fires attributed to non-utility causes during since 2007 including the May Fires of 2014 (26,001 acres), Border Fire of 2016 (7,609 acres), and Valley Fire of 2020 (16,390 acres). Other fires have impacted the service territory but did not meet the stated thresholds.

OEIS Table 5-4: Catastrophic Electrical Corporation Wildfires

Ignition Date	Fire Name	Official cause (if known)	Fire Size (acres)	No. of Fatalities	No. of Structures Destroyed and Damaged	Financial Loss (US\$)
10/21/2007	Witch Creek – Guejito Fire (fires merged)	CAL FIRE Reports determined that the causes of the ignition were, among other factors, power lines	197,990	2	1,736	\$2.4 billion*
10/22/2007	Rice Fire	CAL FIRE Reports determined that the causes of the ignition were, among other factors, power lines	9,472	0	248	\$2.4 billion*

**\$2.4 billion represents the consolidated settlement of claims and associated costs related to the Witch Creek and Rice fires.*

¹¹ [D.19-07-015](#).

Figure 5-3: Catastrophic Wildfire Map

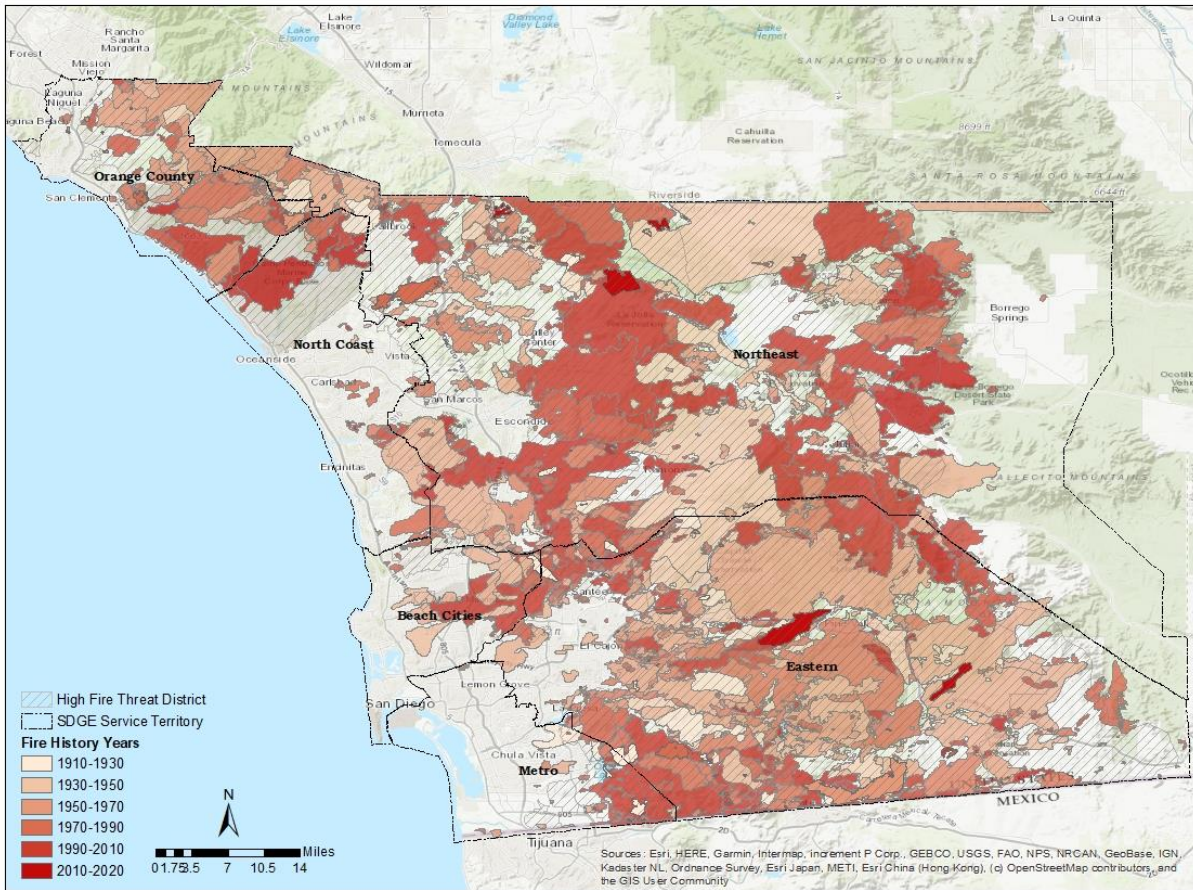

5.3.3 High Fire Threat Districts

About two-thirds of the service territory is within Tier 2 and Tier 3 of the HFTD, with portions of the non HFTD in areas defined as Wildland Urban Interface (WUI) by the California Department of Forestry and Fire Protection (CAL FIRE). “In 2018, the CPUC adopted a fire threat map to identify areas of heightened fire risk for use by utilities in planning risk reduction activities. Developed in collaboration with CAL FIRE, the Office of Emergency Services, utilities, and stakeholders, this map breaks down the wildfire risk in a utility’s service district into three tiers. Tier 1 areas of the service territory have an acceptable level of wildfire risk, Tier 2 areas have an elevated risk, and Tier 3 areas have an extreme risk.”¹²

Prior to the implementation of the HFTD, SDG&E utilized internal shapes called the FTZ and the HRFA which were first implemented in 2011. As with the HFTD, the FTZ and HRFA were based on variables such as environmental conditions, urban growth, and fire history. Historical weather conditions were also considered by using an internally generated 50-year wind map that highlighted the territory-wide wind potential. These maps were produced using a 30-year weather reanalysis dataset that was bias corrected using weather station data and extended to 50 years by applying a generalized extreme value probability distribution function to the data. This allowed subject matter experts to analyze where the

¹² Source: <https://www.cpuc.ca.gov/industries-and-topics/wildfires>

potential for the most extreme weather conditions aligned with terrain and fuels to better inform the FTZ and HRFA boundaries. Through the process of the HFTD’s creation, SDG&E collaborated with the above stakeholders to incorporate 7 years of lessons learned from the FTZ and HFRA into the new HFTD. The HFTD is now utilized as the guiding map for mitigation and project planning.

Annually, subject matter experts assess the HFTD and consider potential changes. The variables used to create the HFTD are weighed, and any suggested modifications or new information is discussed. To date, SDG&E has not suggested any adjustments to the HFTD. The fire history and fire environment are still consistent with the conditions that were present when the original HFTD shape was created, and any new information has not warranted a change. For details on the evaluation of wildfire risk outside the HFTD, see response to Areas for Continued Improvement SDGE-22-08 in Appendix D.

Figure 5-4: Map of HFTD in the Service Territory

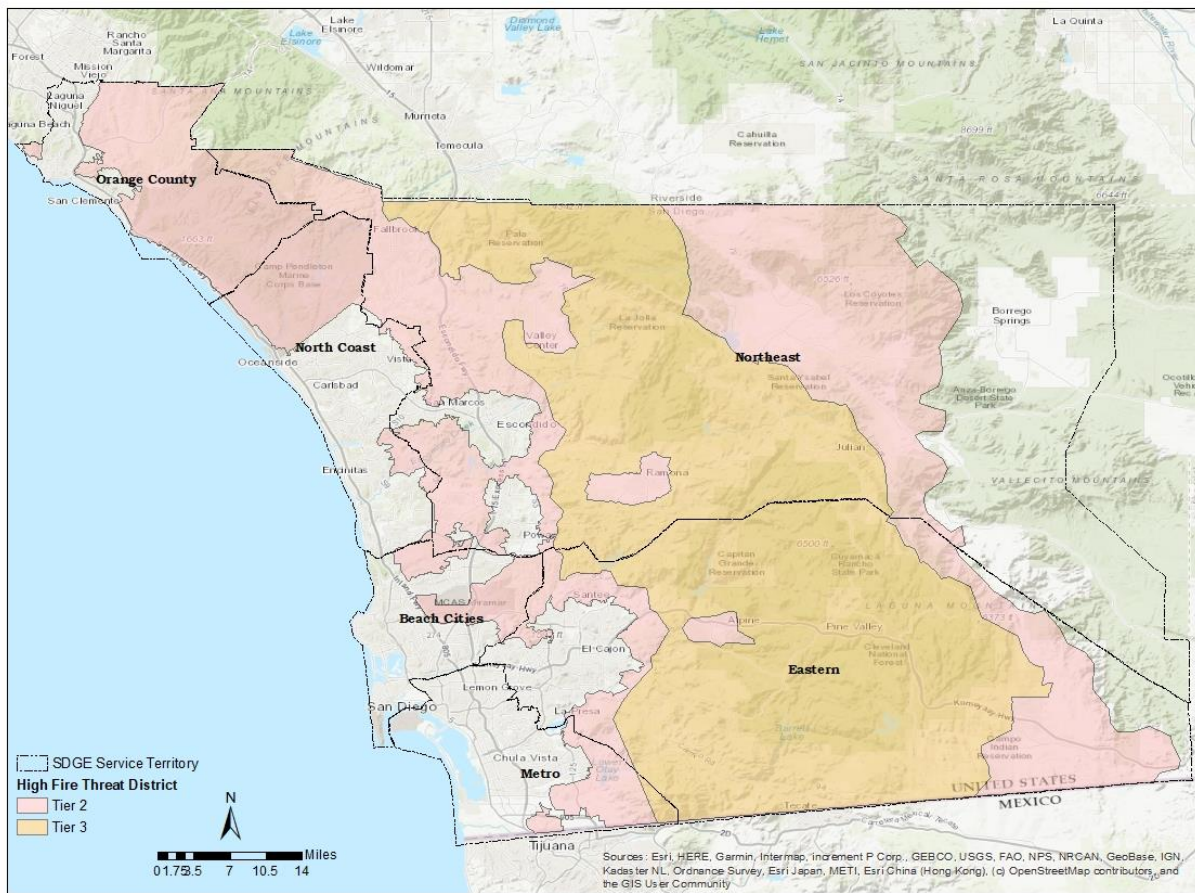

OEIS Table 5-5: HFTD Statistics

High Fire Threat District	Total Area (sq. mi.)	% of Total Service Area
Non-HFTD	1,275	31%
Tier 2	1,395	34%
Tier 3	1,426	35%

High Fire Threat District	Total Area (sq. mi.)	% of Total Service Area
Total	4,096	100%

5.3.4 Climate Change

5.3.4.1 General Climate Conditions

Generally speaking, prevailing winds and weather for San Diego are tempered by the Pacific Ocean, resulting in cool summers and warm winters in comparison with other places along the same general latitude. A marked feature of the climate is the wide variation in temperature within short distances. In nearby valleys, daytimes are much warmer in summer and nights noticeably cooler in winter and freezing occurs much more frequently than in the city of San Diego. Although records show unusually small daily temperature ranges, only about 15 degrees between the highest and lowest readings, a few miles inland these ranges increase to 30 degrees or more.

The seasonal rainfall increases with elevation and distance from the coast, with the preponderance of rain falling on the mountains to the north and east depending on slope and elevation. Most of the precipitation falls in winter, except in the mountains where there is an occasional thunderstorm in the summer. Eighty-five percent of the rainfall occurs from November through March, but wide variations take place in monthly and seasonal totals.

Figure 5-5: Annual Mean Climatology for the Service Territory

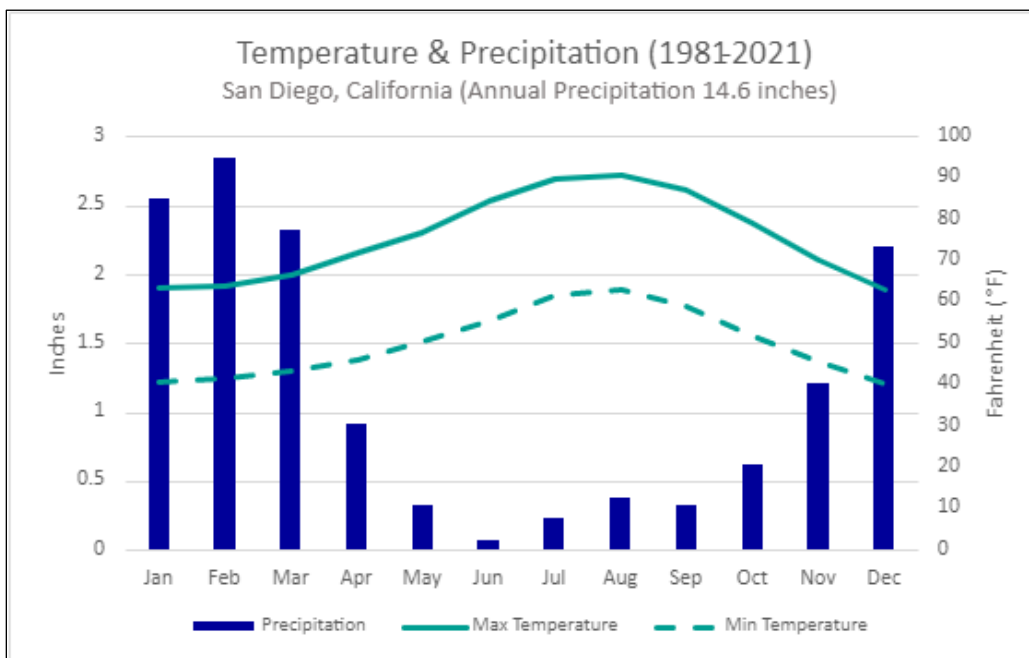

San Diego has four distinct climates:

Coastal: This San Diego climate is characterized as moderate with little temperature change and generally light breezes. It is the zone most strongly influenced by the ocean, with a mild marine climate

resulting from the Pacific Ocean. Winters are mild, summers are cool, and there is almost always moisture in the air. Early morning cloudiness and fog can occur in the San Diego coastal climate, mostly in the spring and early summer. The low clouds may extend inland over the coastal valleys and foothills, but usually dissipate by mid-morning. Afternoons in the coastal climate are usually clear until late in the day when the marine layer may return. Fire risk is generally low due to high humidity associated with proximity to ocean, and predominately onshore flow. In the fall when fuel moistures are lowest, coastal canyons can present a fire risk.

Inland Valleys: Moving inland from the coast, the daytime temperature increases and the nighttime temperature decreases. On average, the temperature will increase by almost one degree for every mile inland from the coast. Summer months in the San Diego inland valley climate can get very hot. The higher elevation areas are influenced both by moist coastal air and dry interior air. Humidity, morning fog, and wind are moderate, with low annual rainfall. In the winter months the inland valley climate is quite a bit cooler at night than the San Diego coastal climate and may experience occasional frost. Isolated afternoon thunderstorms can pop up during the hottest part of the summer. The San Diego inland valley climate gets more rain from winter storms than the coastal climate. Inland valleys present a fire risk upon the conclusion of winter rain. Grass fires are common during the summer but are not catastrophic in nature. In the fall, dry fuel moisture coupled with seasonal Santa Ana winds can increase fire potential from moderate to high for short periods of time.

Mountains: This San Diego climate is typical of mountain areas. Summer nights are cool and the days are warm with occasional afternoon thundershowers. The winters can be cold with occasional snow accumulation that ranges from a trace to 6 inches. Snow usually melts away within days. Significantly more precipitation falls in the San Diego Mountain climate than in the coastal climate (approximately 10.3 inches per year). Steep slopes, variation in sun and wind exposure, shallow soils, and heavier rainfall affect plants in the Mountain regions. Average annual rainfall is 30 inches, and wet years can bring 45 inches or more. Also, winds in the mountains can be gusty at times, particularly during Santa Ana conditions. Despite receiving the most rainfall during winter months, the mountain regions can be prone to fire risk in the fall especially upon ignition fires can grow rapidly using the terrain to spread.

Desert: Like most desert climates, this climate features extremes with very hot summers and cooler winter nights. The mountains capture most of the rain, creating the arid desert landscape. Dry and hot daytime conditions combine with cold nighttime temperatures in the Desert zone. Humidity is very low, and water is scarce. Average annual rainfall in the desert is 6 inches and due to lack of vegetation fire risk is low.

5.3.4.2 Climate Change Phenomena and Trends

Figure 5-6, Figure 5-7, and Figure 5-8 represent mean annual temperature, annual precipitation, and projected change in maximum temperature for the San Diego region over the past century and projected through the end of the current century. As is the case with projections, variability must be factored into any conclusions, and conclusions within this discussion assume little to no abatement of human-caused greenhouse gas emissions, consistent with Representative Concentration Pathway (RCP) 8.5 which is being used for California Investor Owned Utility (IOU) vulnerability assessments pursuant to the Climate Change Adaptation Order Instituting Rulemaking (OIR). Current climate models appear to present a relatively stable average annual rainfall, but research in California's Fourth Climate Change Assessment suggests that precipitation in the region will increasingly come from fewer, stronger storms,

which presents both flooding and water retention concerns, the latter of which could further exacerbate the increasing extreme wildfire conditions.

Figure 5-6: Mean Annual Temperature for the Service Territory 1900s-2020s

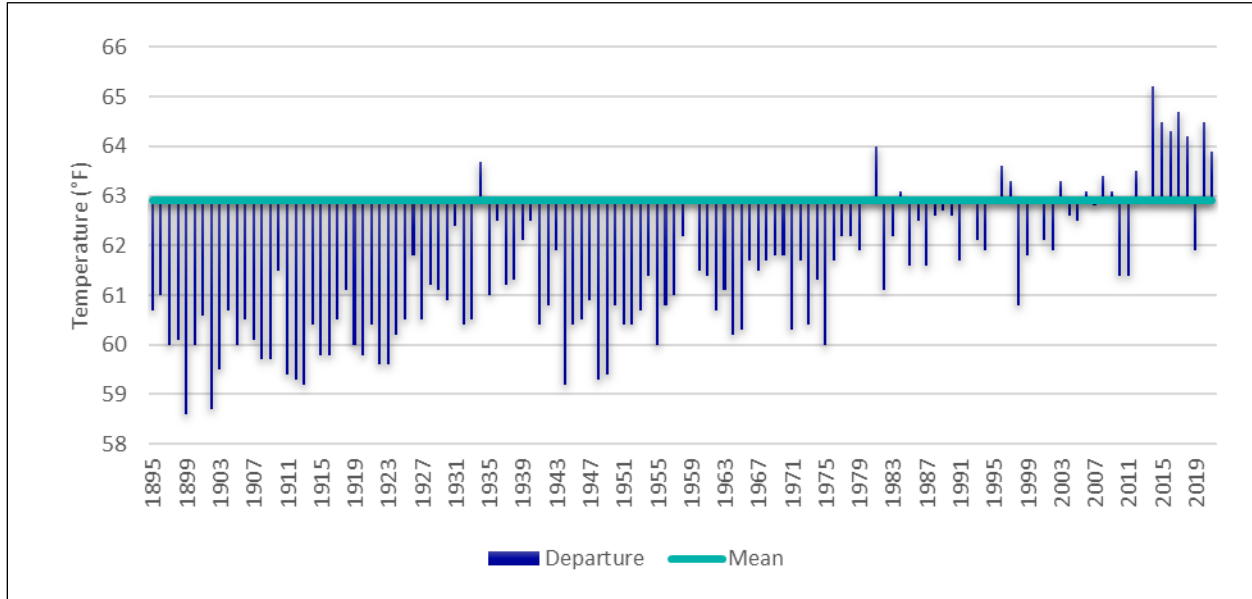

Figure 5-7: Mean Annual Precipitation for the Service Territory 1900s-2020s

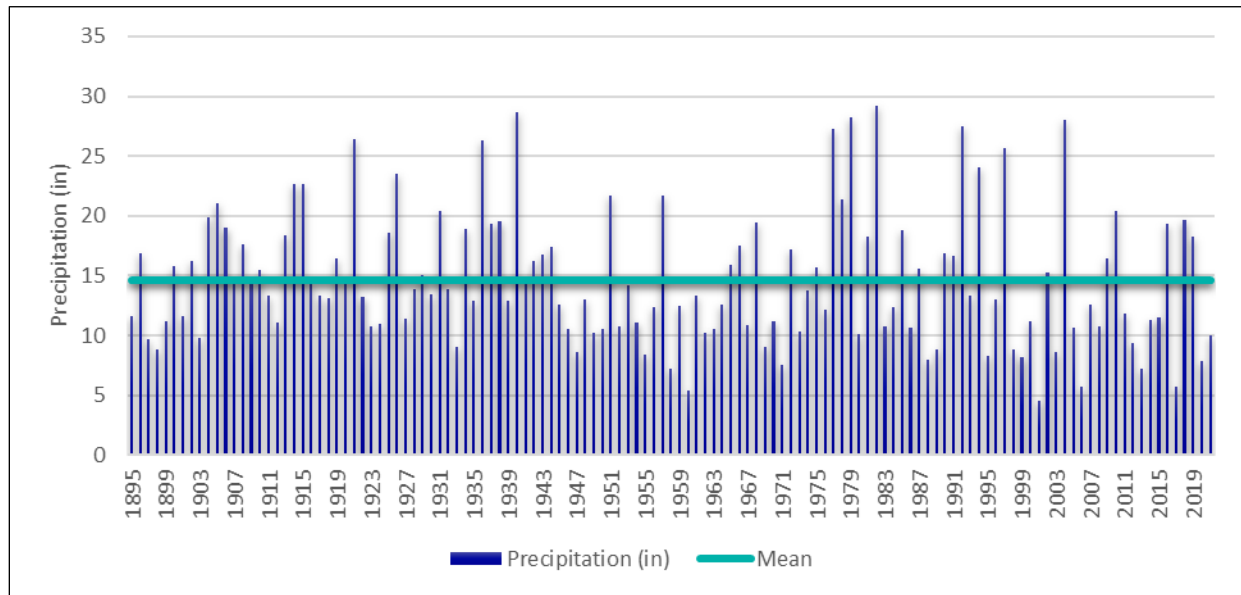
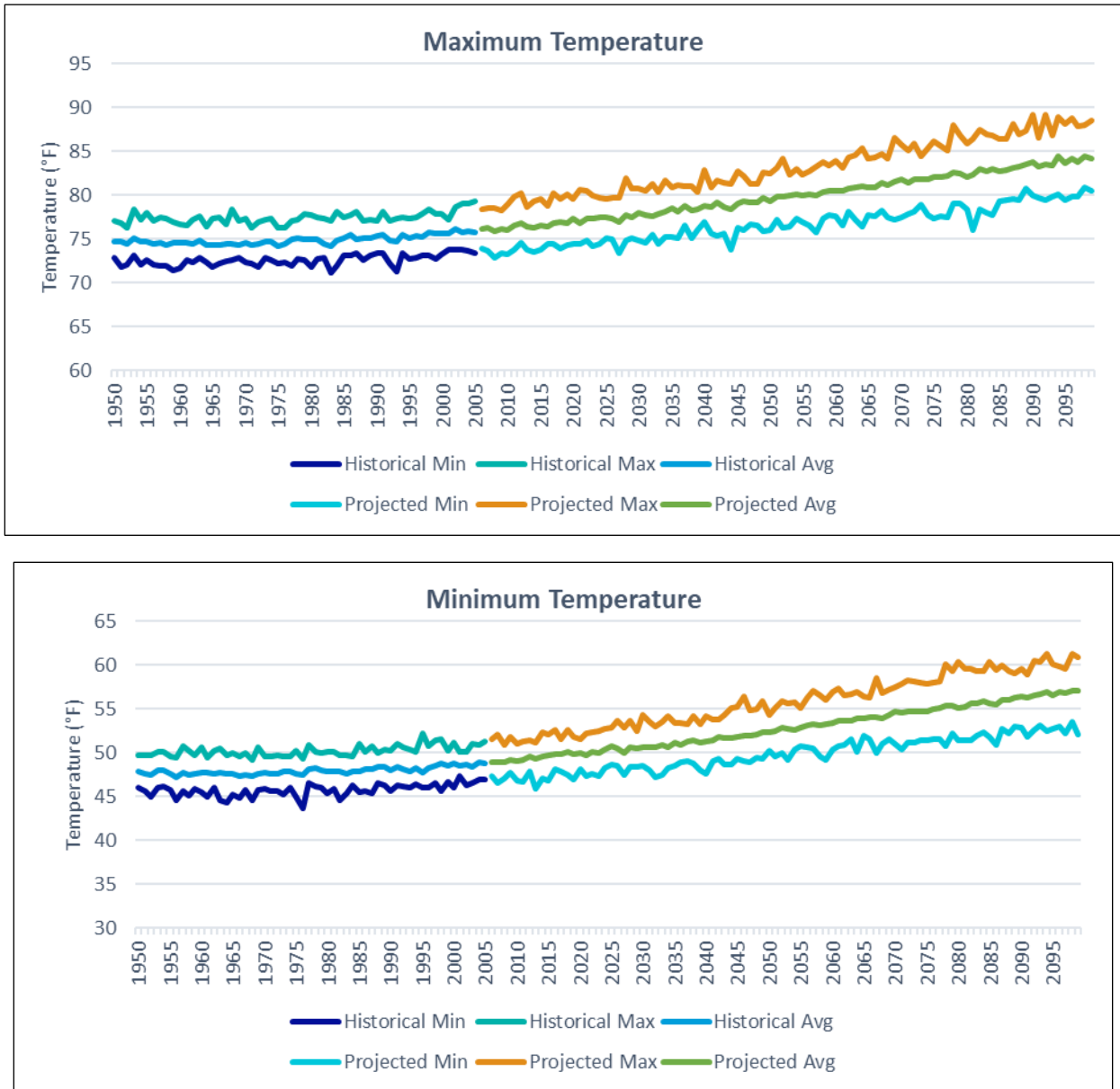

Figure 5-8: Projected Change in Minimum and Maximum Daily Temperatures



SDG&E is conducting a system-wide climate change vulnerability assessment looking at mid- and end-of-century climate change projections. To do this, the latest available climate science was analyzed to determine the most applicable analysis to inform the internal wildfire risk modeling. Based on this analysis, the following research was determined to be most applicable due to the focus on increased occurrence of fire weather conditions during the fall months, which represent the period with the

highest risk events across San Diego County and Orange County. For SDG&E's Fire Weather Index (FWI) projections, SDG&E used the scientific paper of Michael Gross et al.¹³

As a part of this research, projected 95th percentile FWI values and the number of future days above the current baseline 95th percentile FWI are modeled (note that FWI values are unitless). This dataset calculates daily FWI using the statistically downscaled maximum temperature, minimum relative humidity, wind speed, and precipitation fields. Fuel aridity is a component of the calculation done to model the raw FWI data, meaning it is not an extractable variable in the downscaled version of the model. While not entirely analogous, fuel aridity and fuel moisture are related and indicative of similar processes. The data this research presents reflects fuel aridity, given its incorporation in the initial data calculation.

When assessing wildfire risk, the regions prioritized are primarily the HFTD, though analysis is conducted across the entire service territory to better understand the potential impacts across coastal canyons and the WUI. The FWI analysis, in conjunction with research from California's Fourth Climate Change assessment, are being used in SDG&E's Risk Narrative to give a more complete picture of the potential impacts of climate change on wildfire risk and SDG&E's mitigation activities.

¹³ See Michael Goss et al, Environmental Research Letters, Climate change is increasing the likelihood of extreme autumn wildfire conditions across California, (August 20, 2020), available at <https://iopscience.iop.org/article/10.1088/1748-9326/ab83a7>.

Figure 5-9: Extreme Fire Weather Days in the Service Territory

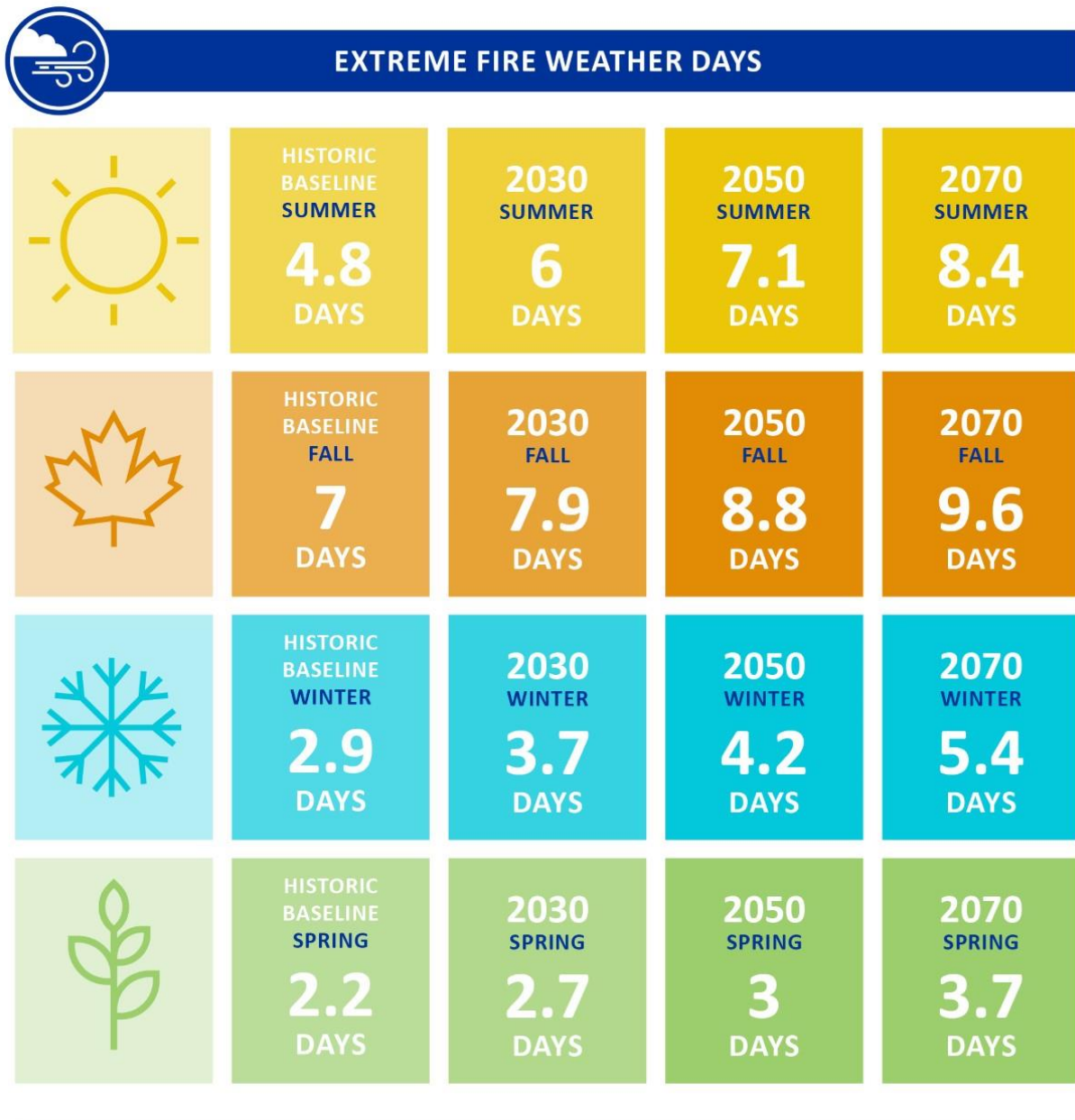

5.3.5 Topography

San Diego County covers an area of 4,225 square miles, 65 miles from north to south and 86 miles from east to west. The topography of the service territory is widely varied, ranging from over 80 miles of coastline on its western flank to mountains greater than 6,500 feet in elevation to its east. The coastline includes both sandy beaches and coastal bluffs with steep drop-offs to the water. Just inland from the coastline are the mesas, which include multiple small canyons, plateaus, and a few mountains that peak at nearly 1,600 feet in elevation. The terrain continues to rise eastward through the inland valleys and

foothills, eventually reaching the mountains roughly 30 to 50 miles inland. There, national forest land and multiple peaks greater than 6,000 feet in elevation can be found. The mountain zone makes a sharp transition to desert land to its east, where the elevation falls to 500 to 700 feet.

The vastness and varied terrain create a wide range in San Diego weather around the county. These different local weather conditions are known as the San Diego climates. The official San Diego weather forecast and weather statistics are for the San Diego International Airport, located on the coast. Moving inland, San Diego's climate changes quickly due to the topography of the land. The general rule is that rainfall increases at higher elevations and moving inland from the coast. North San Diego County also gets more rain than South San Diego County. Another characteristic of San Diego's climates is that the inland areas experience larger temperature changes than coastal areas. Inland summer temperatures often exceed 90 degrees and winter temperatures may fall below freezing at night. In contrast, summer temperatures at the coast rarely go above 80 degrees and almost never go below 45 degrees in the winter.

5.4 Community Values at Risk

Climate vulnerability, environmental social justice, and equity relative to the San Diego and Southern Orange County regions is of particular interest as the concept of risk is reviewed. SDG&E's customer base stands to face extensive challenges in the face of climate change over the next century and relative to that change, ensuring prioritization of equitable investments across the region will be key. Disadvantaged Vulnerable Communities, as defined in the Climate Change Adaptation OIR, may lack the adaptive capacity demanded by the climate and electrification challenges of the future, but through proactive policy support and continued innovation in clean energy technologies, the region can work towards an equitable path to a sustainable future.

Ensuring the prioritization of equity in the utilities investments and policies is a challenging task, and the direct input of communities is paramount to its success in preserving each community's values in an ever-changing future. Doing this outreach and subsequent decision-making, understanding the inequities of the communities we serve, and understanding these issues and values at risk are not uniform across the service territory, best positions the Company to make informed, effective, and equitable decisions during all phases of the climate adaptation and wildfire mitigation processes. Through equitable outreach, relationships with key community stakeholders, and an ever-developing internal subject matter expertise, SDG&E is striving to truly be key contributor and leader in creating a more clean, safe, and equitable future for the San Diego Region.

5.4.1 Urban, Rural, and Highly Rural Customers

Census tracts for San Diego and Orange counties were utilized to develop urban, rural, and highly rural layers by census tract. The number of customers was provided by the 2010 census data. To determine population density for each census tract, the total number of customers was divided by the total square miles of the tract. Each tract was then categorized as Urban, Rural, or Very Rural according to General Order (GO) 165 and Title 38 of the Code of Federal Regulations (CFR), Section 17.701 definitions. The Rural definition was modified to be 7 to 999 people per square mile in order to distinguish between Rural (7 to 999 people per square mile) and Highly Rural (0 to 6 people per square mile).

Of the roughly 1.23 million customers in the service territory, 91.7 percent (1.13 million customers) reside in Urban areas. Of those customers, 92.2 percent reside in areas outside of the HFTD. Approximately 98,000 customers are located in areas that are considered Rural, accounting for 7.9 percent of the overall customer population, and 0.34 percent (4,714 customers) of customers are in Highly Rural areas. Of the roughly 1.23 million customers within the service territory, 87.1 percent are located outside of the HFTD. In Rural and Highly Rural areas, there is a significantly higher percentage of customers in the HFTD (69.2 percent) versus areas outside of the HFTD (7.8 percent).

5.4.2 Wildland-Urban Interfaces

CAL FIRE is the state authority on areas designated as WUI. The WUI in the service territory is both within and outside of the HFTD and includes many of the coastal canyons within San Diego County. In part because there are areas outside the HFTD that are identified as WUI, certain mitigations, such as construction and maintenance fire prevention requirements, are applied service territory wide and focus on all at-risk activities being performed adjacent to wildland fuels. Additionally, asset inspection programs are enhanced in many of these WUI areas to identify potential issues not visible by traditional ground inspections, where terrain or other constraints may limit the ability to perform a detailed ground inspection or where the high-resolution imagery captured by drones provides better visibility of a potential fire hazard. These WUI areas may not have the potential for a large catastrophic fire, but a fire in these areas does pose a risk to the surrounding customers.

5.4.3 Communities at Risk from Wildfire

5.4.3.1 Individuals at Risk from Wildfire

There are approximately 420,000 customer accounts associated with AFN. Of those, approximately 44,000 are located within HFTDs. While the primary methodology for identifying AFN populations is through SDG&E's databases, customers can also self-identify through the Customer Contact Center and various marketing campaigns. Additionally, AFN customers may be reached through local community partners who represent or provide services to these constituencies (e.g., 211 San Diego). SDG&E does not receive a number of customers from these partners, and as such, they are not included in the count.

Figure 5-10: AFN Customers in the Service Territory

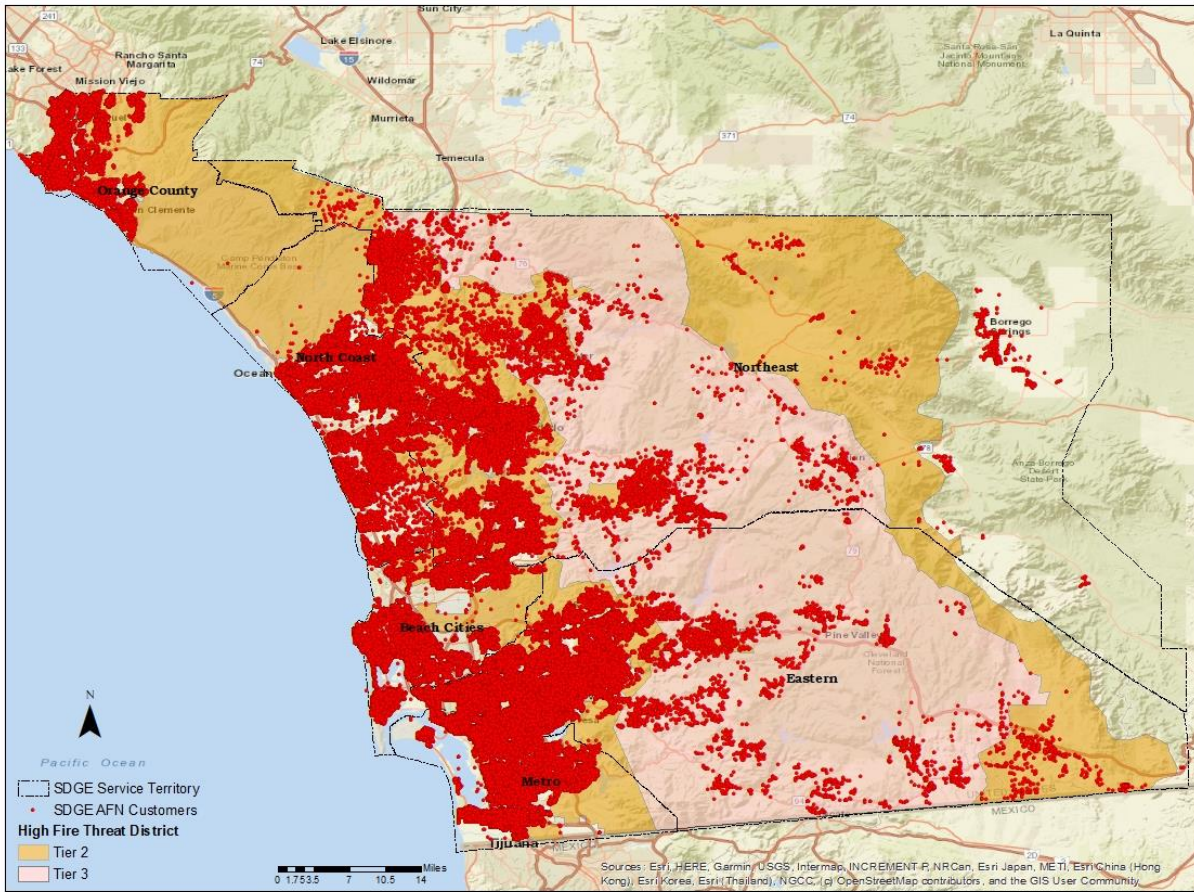

5.4.3.2 Social Vulnerability and Exposure to Electrical Corporation Wildfire Risk

Social vulnerability relates to the circumstances of an individual or community that affects their capacity to anticipate, confront, repair, and recover from the effects of a disaster. The higher the level of social vulnerability potentially makes recovering from a disaster more difficult. SDG&E continues to focus on understanding the needs of the most vulnerable customers, as this helps address the inequities in emergency preparedness. SDG&E leverages relationships with key community stakeholders and partners, internal subject matter expertise and market data. SDG&E will continue the use of data paired with local knowledge to provide a mechanism to bring social and community resilience into the discussions.

Figure 5-11: Communities at Risk in the Service Territory

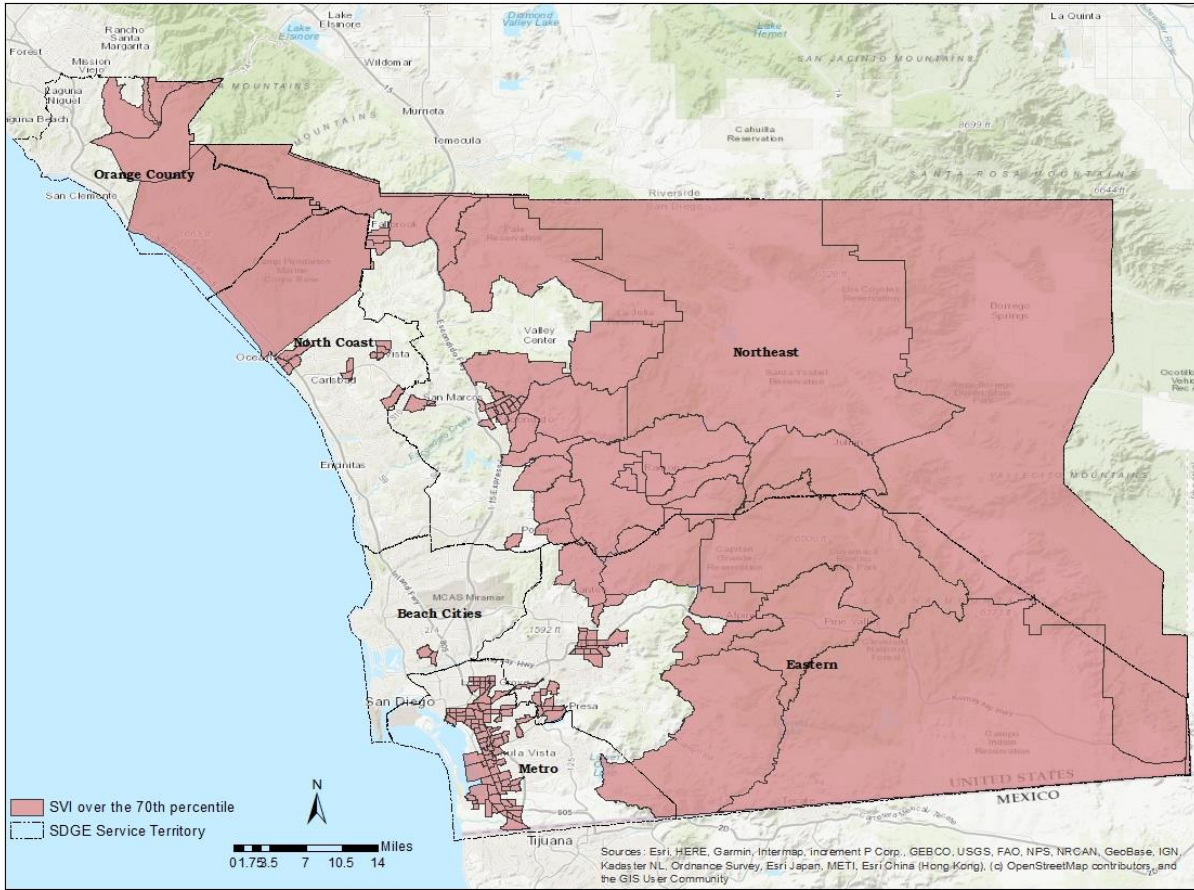

5.4.3.3 Sub-Divisions with Limited Egress or No Secondary Egress

The communities identified by CAL FIRE as Communities at Risk span from areas adjacent to the Pacific Ocean to the desert reaches of the service territory, and each has unique challenges associated with evacuation and repopulation. Some of the unique challenges include multiple military bases with restricted access, agricultural development, border security, and a wide gap in resources between certain communities. There are also varied levels of fire danger in each community with some being most at risk during specific weather conditions.

SDG&E partners with local, state, and federal resources on the San Diego County Evacuation Committee to support the regional evacuations plan and ensure that situational awareness is enhanced by the agencies charged with keeping the public safe during an evacuation. In addition, the Strategic Undergrounding Program (WMP.473) considers egress during design and construction in case of any emergencies. Local fire departments and police stations provide input for emergency plans, especially when work performed is in the HFTD, access is limited during an evacuation, and/or for any medical emergencies.

5.4.4 Critical Facilities and Infrastructure at Risk from Wildfire

Critical Facilities & Infrastructure (CFI) customers are widely distributed across the service territory. As of November 2022, there was a total of 4,582 CFI customer accounts within the HFTD; 3,246 of which are located in Tier 2 of the HFTD and 1,336 of which are located in Tier 3 of the HFTD. SDG&E Table 5-1 shows CFI customers in Tier 2 and SDG&E Table 5-2 shows CFI customers in Tire 3.

SDG&E Table 5-1: CFI Customers in Tier 2 of the HFTD

Facility/Infrastructure Type	Number of CFI Type in HFTD Tier 2
Blood Bank	1
Chemical	13
Communications	1367
Community Center	13
Cooling Center (Cool Zone)	6
Cooling Center-Voting	6
Covid Related Site	10
Emergency Food Organization	4
Federal Account	94
Federal Account-Covid	4
Fire Station	57
Fire Station-Voting	1
Healthcare-Public Health	9
Hospital	10
Hospital-Covid	4
Jail	18
Police Station	10
Prison	8
Public Health Department	3
School	249
School-Voting	17
SDG&E Critical	50
Senior Center	6
Senior Center-Cool Zone	1
Senior Center-Voting	1
Skilled Nursing-Nursing Hm	8
Transportation	510
Tribal Government Provider	6
Tribe	68

Facility/Infrastructure Type	Number of CFI Type in HFTD Tier 2
Utilities	28
Voting Center	11
Water & Wastewater Systems	653
Total	3246

SDG&E Table 5-2: CFI Customers in Tier 3 of the HFTD

Facility/Infrastructure Type	Number of CFI Type in HFTD Tier 3
Chemical	1
Communications	390
Community Center	24
Cooling Center (Cool Zone)	6
Dialysis Center-Covid	1
Federal Account	22
Fire Station	66
Fire Station-Voting	2
Healthcare-Public Health	1
Police Station	9
Public Health Department	5
School	75
School-Voting	4
SDG&E Critical	11
Senior Center	1
Senior Center-Voting	1
Skilled Nursing-Nursing Hm	1
Transportation	68
Tribal Government Provider	29
Tribe	394
Tribe-Voting	1
Utilities	2
Voting Center	3
Water & Wastewater Systems	219
Total	1336

5.4.5 Environmental Compliance and Permitting

5.4.5.1 Processes to Ensure Compliance

5.4.5.1.1 Environmental Services

Environmental Services has a long-standing, robust environmental review process that ensures all activities that may impact the environment are appropriately reviewed prior to construction. The Director of Environmental Services oversees approximately 80 employees who collectively support the operations and maintenance of Company facilities as well as capital improvement projects to ensure all activities maintain compliance with applicable ordinances, regulations, and law. Environmental Services includes industry experts in air, water quality, hazardous materials, biological resources, cultural resources, and environmental planners. The Environmental Services review process includes a screening system where the Operational Group (e.g., Vegetation Management) submit projects for environmental review along with responses to screening questions about details of their project and project location. Environmental Services then researches, field-verifies (when necessary), and documents any potential impacts that activities may have on environmental resources. It may also support acquisition of discretionary state or federal permits as applicable. SDG&E employees and its contractors are responsible for maintaining compliance with applicable ordinances, regulations, and laws.

Environmental Services conducts reviews for every project proposed to occur in a natural area (i.e., any space that is “uncultivated” or “undeveloped” and in its natural state) that involves ground disturbance (digging), vegetation trimming, driving off existing access roads into natural areas, or impacts to natural waterways. These internal environmental reviews are undertaken for all applicable projects, even in the absence of a legal requirement to do so, including for some routine inspections, work on distribution lines, and other projects with little potential for environmental impact.

In its review, Environmental Services assesses potential impacts of the project to the environment and articulates appropriate avoidance measures or constraints to eliminate or reduce potential impacts, including onsite environmental monitoring that must be implemented as part of the project. Environmental Services maintains tracking of the environmental review and status for every project that it reviews. See OEIS Table 5-6 for examples of relevant state and federal laws, regulations, and permits applicable to WMP projects.

5.4.5.1.2 Programmatic Endangered Species Act Permitting/Authorization

Work is performed in an environmentally sensitive manner under SDG&E’s Subregional Natural Communities Conservation Plan (NCCP) and Habitat Conservation Plan (HCP), which was developed in collaboration with the U.S. Fish & Wildlife Service (USFWS) and the California Department of Fish and Wildlife (CDFW).

The NCCP/HCP expressly aims to preserve intact the biological and physical resources comprising sensitive habitats (ecosystems) to the greatest extent possible and afford all species within managed habitats the maximum possible protections. The NCCP/HCP avoids and/or minimizes impacts to 110 Covered Species and their habitats while allowing the installation, maintenance, operation, and repair of the existing gas and electric system and expansion of the electric grid (Covered Activities). Specifically, the USFWS issued an incidental take permit (ITP) (ITP No. PRT-809637) under section 10 of the Endangered Species Act (ESA) that authorized the “incidental take of 110 species in San Diego County

and portions of Orange and Riverside County, California.” Permits and authorizations issued by the wildlife agencies with the NCCP/HCP authorized incidental take associated with a fixed amount of habitat modification over 55 years of Covered Activities. The NCCP/HCP includes more than 60 operational protocols that are implemented for Covered Activities, including pre-activity surveys to document pre-construction site conditions and to identify recommended measures to avoid potential impacts.

The agencies approved the NCCP/HCP in 1995, with CDFW determining that it would “mitigate [] impacts to endangered species,” and that, with implementation of NCCP/HCP-prescribed mitigation, “protect [covered] species from further degradation” by “minimizing and mitigating the impacts of the taking of the enumerated species (including, without limitation, the modification of their habitat).¹⁴” The USFWS issued an ITP (ITP No. PRT-809637) under section 10 of the ESA that authorized the “incidental take of 110 species in San Diego County and portions of Orange and Riverside County, California.¹⁵” Permits and authorizations issued by the wildlife agencies with the NCCP/HCP authorized incidental take associated with a fixed amount of habitat modification over 55 years of Covered Activities.

In 2022, CDFW granted SDG&E’s requested amendment to the NCCP and CDFW’s associated management authorization (Bridge Amendment), issuing a Notice of Exemption explaining “CDFW approved the Bridge Amendment relying on the California Environmental Quality Act (CEQA) statutory exemption for specific actions necessary to prevent or mitigate an emergency¹⁶” (California Public Resource Code (PRC) § 21080(b)(4); Cal. Code Regs., tit. 14, § 15269). The Bridge Amendment allowed additional habitat modification and associated incidental take of covered species related to activities performed to mitigate wildfire risk. These activities, collectively termed “Wildfire Safety Activities,” were included in the 1995 NCCP, and were detailed in the WMP (as updated) or Application of San Diego Gas & Electric Company to Submit Its 2021 RAMP Report.

In February 2022, CDFW approved the Bridge Amendment and amended its management authorization for Wildfire Safety Activities, issuing a Notice of Exemption explaining “CDFW approved the Bridge Amendment relying on the CEQA statutory exemption for specific actions necessary to prevent or mitigate an emergency¹⁶” (California PRC § 21080(b)(4); Cal. Code Regs., tit. 14, § 15269).

In March 2022, SDG&E applied to USFWS for an amended ITP. The application included the required conservation plan, titled HCP 2022, which amends the existing federal portion of the NCCP/HCP. Under the HCP Amendment, Covered Activities would continue to be implemented in an environmentally sensitive manner by following both the original 1995 Plan Operation Protocols and additional Operation Protocols as along with various new Species-Specific Protocols. The HCP Amendment would permit additional acres of habitat impacts, including up to 210 acres of habitat impacts from Wildfire Fuels Management, across the service area through 2050. USFWS’s decision on that application, which is pending before the agency, is expected in early 2023.

¹⁴ Source: San Diego Gas & Electric Subregional Natural Community Conservation Plan and Habitat Conservation Plan, 1995.

¹⁵ Source: section 10 of the Endangered Species Act (ESA)

¹⁶ Source: Citation No. 2. Amendment to San Diego Gas & Electric Company Subregional Natural Community Conservation Plan and California Endangered Species Act and Natural Communities Conservation Planning Act Management Authorization Regarding Wildfire Safety Activities, 2/17/2022

5.4.5.1.3 Cultural Resources Program

Environmental Services includes a dedicated Cultural Resources program and team. The program follows a comprehensive and consistent approach for reviewing activities to ensure compliance with applicable laws and regulations and to avoid, minimize, or mitigate impacts on cultural resources, where feasible. Standard practices and procedures are expressly designed to protect cultural resources throughout the service territory. For example, an internal review system is used to intake, screen, and document the necessary measures that must be implemented at the project site once a project has been released to construction from the Cultural Resources Team.

Cultural Resource Specialists, along with appropriately qualified contractors, work with representatives of Tribal lands as well as Federal, State and Local Agency staff to obtain applicable permits or authorizations to conduct cultural resource investigations on both Public or Tribal Lands to ensure compliance with federal, state and local laws and regulations. These include, but are not limited to, the Native American Graves Protection and Repatriation Act (NAGRPA), National Historic Preservation Act (NHPA), Archaeological Resources Protection Act (ARPA) of 1979, National Environmental Protection Act (NEPA), CEQA, and San Diego County Resource Protection Ordinance.

Environmental Services has a screening system where project proponents submit projects for environmental review along with responses to screening questions about details of their project and project location. Projects with ground disturbing activities in areas of cultural resource sensitivity are reviewed by a Cultural Resource Specialist. Desktop analyses include conducting in-house records searches via subscription services, an internal confidential database, and document libraries. The Cultural Resource Specialist also consults historic maps, updates from agencies, recent listings for the California and National Registers, published literature, and publicly available documents. Intensive pedestrian surveys are conducted if determined to be required after the desktop analysis.

Best management practices (BMPs) are also implemented to avoid and protect resources, including:

- Having an archaeological and/or Native American monitor onsite if appropriate
- Immediately reporting archaeological or historical artifacts or features that are discovered to the Cultural Resource Specialist for evaluation
- Leaving artifacts where they are found
- Containing ground disturbance to the extent of the project area
- Keeping vehicles on existing roads as feasible
- Keeping information about cultural discoveries and archaeological site data confidential to the extent allowed under applicable law
- Not collecting or otherwise touching or disturbing these resources without prior coordination with relevant agencies
- Requiring archaeological and Native American monitoring in areas that have or have the potential for prehistoric resources as identified during desktop and/or field review
- Stopping activities at a discovery location until a qualified archaeologist can assess the significance of the find and, if necessary, develop appropriate treatment measures in consultation with a Cultural Resource Specialist
- Complying with the requirements of Sections 5097.98 and 7050.5 of the California PRC should human remains be inadvertently discovered within the project area

- Having the Tribal Liaison coordinate with the tribe to apprise them of the work and schedule

5.4.5.1.4 Municipal and State Agency Permits

Various municipal and state agency permits are required prior to construction. These permits (e.g., Right Of Way (ROW) Encroachment permit, traffic control permit, construction permit, noise permit) are typically ministerial permits that are granted upon determinations that the project scope complies with established standards by the cities and/or state agencies.

SDG&E has a designated Permitting Department that is responsible for acquiring municipal and state agency permits for all construction, maintenance, and inspection projects. The team consists of 40 Municipality Advisors, Traffic Control Planners, Permit Services Specialists, and Technical Advisors.

The Permitting Department determines when a permit is required, develops traffic control plans, populates the proper application forms, and submits to the appropriate cities and/or agencies. SDG&E acquires permits from over 30 municipalities and agencies. Wildfire Mitigation projects span across multiple jurisdictions. Most WMP projects are located with the County of San Diego and the California Department of Transportation’s (Caltrans) ROW. Median turnaround time for these ministerial permits is 12.5 business days, however, SDG&E has experienced significant delays, up to 18 months, for permit issuance for certain municipalities and agencies (See Section 5.4.5.2 Overcoming Roadblocks).

OEIS Table 5-6: Relevant State and Federal Environmental Laws, Regulations, and Permitting Requirements for Implementing the WMP

Environmental Law, Regulation, or Permit	Responsible Permittee/Agency
Endangered Species Act Section 10(a)(1)(B) Incidental Take Permit	USFWS
NEPA, 42 U.S.C. § 4321 et seq and implementing regulations	Federal agencies taking discretionary action/approvals
Endangered Species Act, 16 U.S.C. § § 1531-1544 and implementing regulations	Federal agencies taking discretionary action/approvals
NHPA, 54 U.S.C. § 3001 et seq	Federal agencies taking discretionary action/approvals
ARPA, at 16 U.S.C. §§ 470aa–470mm	Federal land manager
NAGRPA, 25 U.S.C. § 3001 et seq.	Federal agencies taking discretionary action/approvals
Clean Water Act, 33 U.S.C. § 1151 et seq.	U.S. Army Corps of Engineers (Section 404 permit)
Clean Water Act, NPDES Permits	State and Regional Water Boards
Clean Water Act, Municipal Stormwater Ordinances	Regional Water Boards, Municipalities and Special Districts
California Porter Cologne, Waste Discharge Permits	Regional Water Boards
Clean Water Act, Industrial User Discharge Permits	Municipalities and Sewer Districts
Cal. Fish and Game Code § 1602	California Department of Fish and Wildlife

Environmental Law, Regulation, or Permit	Responsible Permittee/Agency
Natural Community Conservation Planning Act, Cal. Fish and Game Code §§ 2800-2835	California Department of Fish and Wildlife
California ESA, Cal. Fish and Game Code § 2081	California Department of Fish and Wildlife
California PRC § 5097 et seq	State of California Native American Heritage Commission
Cal. Health and Safety Code § 7050.5	California Department of Public Health
Cal. Native Plant Protection Act, Cal. Fish and Game Code §§ 1900-1913	California Department of Fish and Wildlife
Cal. Desert Native Plants Act, Cal. Fish and Game Code §§ 1925-1926	California Department of Fish and Wildlife
CEQA	State agencies taking discretionary action/approvals
AB 52: Native American Historic Resource Protection Act	Projects subject to CEQA review
Traffic Control Permit, Construction Permit, Encroachment Permit, etc.	Various municipalities (e.g., cities, counties) and Agency Having Jurisdictions (e.g., Caltrans, Metrolink, Metropolitan Transit System, North County Transit District, etc.)

5.4.5.2 Overcoming Roadblocks

CEQA applies to “discretionary projects proposed to be approved or carried out by public agencies,” including zoning changes, variances, conditional use permits, and tentative subdivision maps (PRC § 21080(a)). The CEQA guidelines (Title 14, Division 6, Chapter 3 of the California Code of Regulations), as amended, however, exempt “emergency projects” that include “[s]pecific actions necessary to prevent or mitigate an emergency,” including certain long-term projects.

CDFW ultimately concluded that the approval of a Bridge Amendment and amended management authorization for SDG&E Wildfire Safety Activities was statutorily exempt from CEQA as a specific action necessary to prevent or mitigate an emergency. (California PRC, § 21080(b)(4); Cal. Code Regs., tit. 14, § 15269.). SDG&E thereafter worked with Caltrans to similarly exempt appropriate permits needed for wildfire safety activities from CEQA review.

On the federal level, unlike CEQA, the NEPA contains no similar statutory exemption for appropriate long-term projects that are needed to prevent or mitigate wildfire. Absent such an exemption, critical wildfire safety activities may require environmental review that is long enough to pose a risk to human health and safety.

One of the most challenging areas of permitting for the WMP is encroachment permit acquisition from Caltrans. When a utility installation (e.g., pole installation or replacement) is noncompliant with Caltrans’ road safety design standards per Caltrans design guidance (e.g., Highway Design Manual), a Design Standard Decision Document (DSDD) is required. Currently, the DSDD process takes 9 to 12 months. Similarly, an Encroachment Policy Exception (EPE) request and evaluation process is required for the undergrounding of electric lines and for pole replacement projects in Caltrans’ ROW. The EPE

process also takes 9 to 12 months. These processes delay construction of wildfire mitigation infrastructure.

Over the past several years, SDG&E experienced delays in permit issuance from various local municipalities (cities and counties) due to high staff turnover and/or staff shortages. There has also been heavy “competition” for permitting resources at the municipal level as the same resources are often assigned to review and issue permits for private development and 5G/telecommunication infrastructure construction. For some municipalities, the average turnaround time increased exponentially. Certain permits now take close to 6 months to acquire compared to weeks prior to the COVID-19 pandemic.

5.4.5.3 Notable Changes to Environmental Compliance and/or Permitting Procedures

To address Caltrans permitting delays, SDG&E established a Caltrans – Utilities Partnership with Caltrans HQ, Pacific Gas & Electric (PG&E), and Southern California Edison (SCE). The goal of this partnership is to resolve both Caltrans and the utilities’ challenges on permitting, undergrounding, and relocation. The partnership consists of division chiefs from traffic operations, design, construction, ROW, and land surveys. Six major challenge areas were identified, with each area being addressed by a working group consisting of Caltrans and utility experts.

6 Risk Methodology and Assessment

This section provides an overview of the scope and methodologies applied for the purpose of risk quantification. The Enterprise Risk Management Framework is based on the Settlement Agreement (SA) that the utilities and intervenors reached in the S-MAP proceeding and which was adopted by the CPUC as the guiding framework for conducting risk assessments for RAMP. This structure was used in quantifying and analyzing the RAMP Risks.

6.1 Methodology

6.1.1 Overview

SDG&E quantifies risk by estimating the likelihood and consequences of a risk event. The likelihood of a risk event (LoRE) is estimated as the annual frequency of such risk event in a given year, while the consequence of a risk event (CoRE) is estimated based on the MAVF. This risk quantification process is used to discuss and inform quantitative risk assessments, including for Wildfire and PSPS baseline risk estimations and risk models. Figure 6-1 shows the Enterprise CoRE MAVF process.

Figure 6-1: Enterprise CoRE MAVF

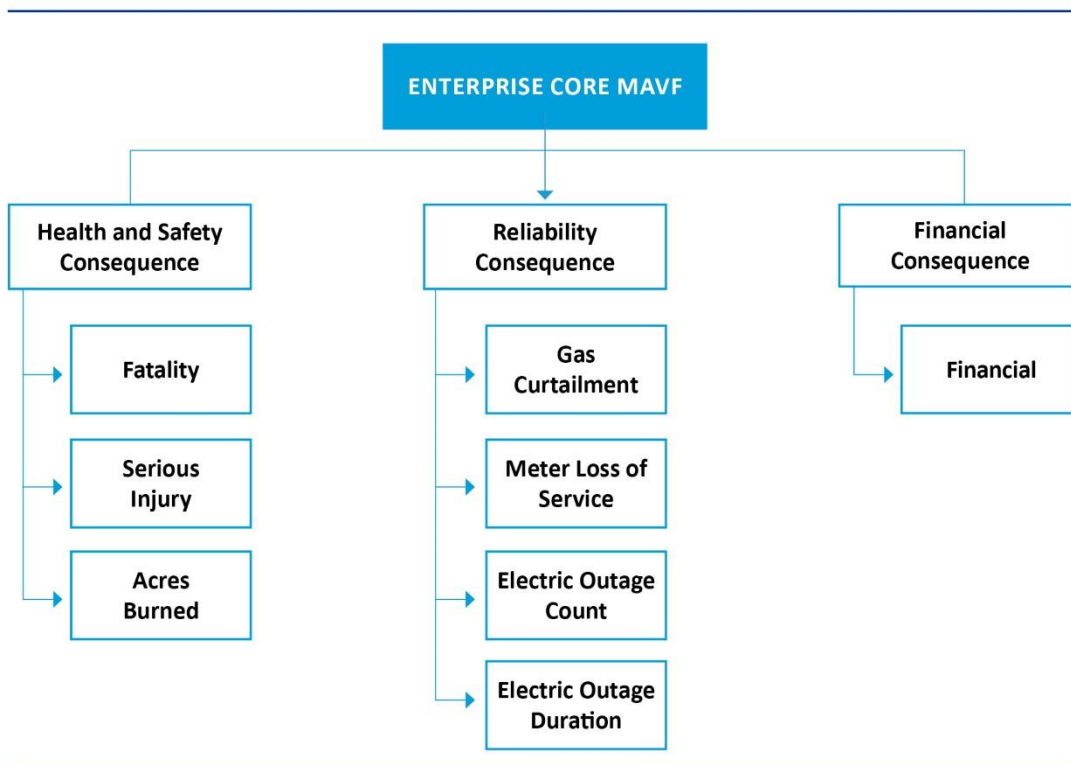

To calculate a risk score, the following steps are followed:

- 1) The LoRE occurring in a given year is estimated based on historical data when it exists. If data does not exist, subject matter experts estimate LoRE values.
- 2) The average consequence for each attribute and sub-attribute is estimated based on the range of known possible consequences.
- 3) The Enterprise Risk Management Framework is used to obtain a single consequence value known as CoRE.
- 4) Finally, the risk score is calculated by multiplying the LoRE and the CoRE. To ease readability, the risk score is multiplied by 100,000, then rounded to the nearest whole number, or decimal, if less than 1.

Note that averages or expected values are used for LoRE and CoRE estimations.

The Enterprise MAVF CoRE model consists of three main attributes (Safety, Reliability, and Financial) and sub attributes that are combined into a generic unitless risk score. This allows comparison between risks and mitigation alternatives on a uniform scale.

The attributes, and their units, range, and weight are shown in SDG&E Table 6-1. The sub-attributes of Health & Safety are shown in SDG&E Table 6-2 and the sub-attributes of Reliability are shown in SDG&E Table 6-3.

SDG&E Table 6-1: Enterprise CoRE MAVF Attributes

Attribute	Unit	Range	Weight
Health & Safety	Index	0-20	60%
Reliability	Index	0-1	23%
Financial	\$M	\$0-\$500M	17%

SDG&E Table 6-2: Sub-Attributes of Health & Safety

Sub-attribute	Value
Fatality	1
Serious Injury	0.25
Acres Burned	0.00005

SDG&E Table 6-3: Sub-Attributes of Reliability

Sub-attribute	Value	Weight
Gas Curtailment	0-333 million cubic feet	25%
Meters Loss of Service	0-50,000 meters	25%
Electric Outage Count	0-1 SAFI Outages	25%
Electric Outage Duration	0-100 SADI Minutes	25%

The process for calculating Wildfire Risk and PSPS risk is detailed in Section 6.2.1 including Figure 6-4 and Figure 6-5. Briefly:

The Wildfire risk score is the product of Wildfire LoRE and Wildfire CoRE

$$WF Risk = WF LoRE \times WF CoRE$$

The PSPS Risk Score is the product of PSPS LoRE and PSPS CoRE

$$PSPS Risk = PSPS LoRE \times PSPS CoRE$$

The Overall Wildfire and PSPS Risk is the summation of WF Risk and PSPS Risk

$$Overall Wildfire and PSPS Risk = WF Risk + PSPS Risk$$

6.1.2 Summary of Risk Models

OEIS Table 6-1: Summary of Risk Models

ID (Model Name)	Risk Component	Design Scenario(s)	Key Inputs	Source of Inputs (Data and/or Models)	Key Outputs	Units
WiNGS-Planning	Wildfire Consequence	Maximum buildings destroyed combined with maximum acres affected per segment	<ul style="list-style-type: none"> Maximum buildings destroyed Maximum acres affected MAVF constants 	WRRM model	<ul style="list-style-type: none"> MAVF outputs Safety Reliability Financial impact 	MAVF natural units. See SDG&E RAMP-C-14
WiNGS-Planning	WRRM Conditional Impact Model	See WRRM 2022 documentation	See WRRM 2022 documentation	See WRRM 2022 documentation	See WRRM 2022 documentation	See WRRM 2022 documentation
WiNGS-Planning	Wildfire Likelihood	<ul style="list-style-type: none"> SDG&E defined Wind Load Condition 3 – Extreme Weather Condition 1 – Anticipated Conditions Weather Condition 2 – Long-Term Conditions Vegetation Condition 1 – Existing Fuel Load 	<ul style="list-style-type: none"> Max wind gust Tree strike potential Mean conductor age Mean pole age Wildfire adjustment factor 1:15 	<ul style="list-style-type: none"> GIS Production via AWS. See Section 6.5 for details GSI tree strike data Ignition data report 	Wildfire LoRE	Unitless Probability
WiNGS-Planning	PSPS Consequence	Customers downstream of sectionalizer	<ul style="list-style-type: none"> Customer data MAVF attributes PSPS probabilities 	<ul style="list-style-type: none"> Meteorology GIS production via AWS 	PSPS CoRE	MAVF natural units. See SDG&E RAMP-C-14
WiNGS-Planning	Customer Type Value Model	Total customers downstream of sectionalizer by categories	Customer counts for: <ul style="list-style-type: none"> Medical baseline Urgent Essential, Sensitive Life support 	GIS production via AWS	Customer counts per category	Integers
WiNGS-Planning	PSPS Likelihood	Probabilities based on past events	PSPS probabilities	Meteorology	PSPS Likelihood	Unitless probability

ID (Model Name)	Risk Component	Design Scenario(s)	Key Inputs	Source of Inputs (Data and/or Models)	Key Outputs	Units
WiNGS-Ops WiNGS-Planning	Safety Impacts	See WiNGS-Planning and WINGS-Ops sections in Appendix B for a detailed description of design scenarios.	<ul style="list-style-type: none"> • Expected number of customers affected by Wildfire or PSPS de-energization event • Scaling factors for AFN customer impacts • PSPS event duration • Number of Acres Burned • Conversion factors to estimate the number of Serious Injuries and Fatalities from customers impacted • MAVF Conversion factors 	RAMP-C Risk Quantification Framework and Risk Spend Efficiency	<ul style="list-style-type: none"> • The expected number of Serious Injuries and Fatalities for a Wildfire or PSPS de-energization event • Unitless risk score for the Safety attribute 	Unitless (Risk Score)
WiNGS-Ops WiNGS-Planning	Reliability Impacts	See WiNGS-Planning and WINGS-Ops sections in Appendix B for a detailed description of design scenarios.	<ul style="list-style-type: none"> • Expected number of customers affected by Wildfire or PSPS de-energization event • Scaling factors for AFN customer impacts • PSPS event duration • Restoration duration estimate • SAIDI and SAIFI estimates • MAVF Conversion factors 	RAMP-C Risk Quantification Framework and Risk Spend Efficiency	Unitless risk score for the Reliability attribute	Unitless (Risk Score)
WiNGS-Ops WiNGS-Planning	Financial Impacts	See WiNGS-Planning and WINGS-Ops sections in Appendix B for a detailed description of design scenarios.	<ul style="list-style-type: none"> • Expected number of customers affected by Wildfire or PSPS de-energization event • Scaling factors for AFN customer impacts • PSPS event duration • Restoration duration estimate 	RAMP-C Risk Quantification Framework and Risk Spend Efficiency	Unitless risk score for the Financial attribute	Unitless (Risk Score)

ID (Model Name)	Risk Component	Design Scenario(s)	Key Inputs	Source of Inputs (Data and/or Models)	Key Outputs	Units
			<ul style="list-style-type: none"> Financial estimate per customer de-energized Financial estimate per acre burned, suppression activities, and structures destroyed MAVF Conversion factors 			
WiNGS-Ops WiNGS-Planning	MAVF Conversion factors (scales and weights)	n/a	Safety, Reliability, and Financial normalization factors	RAMP-C Risk Quantification Framework and Risk Spend Efficiency	n/a	Unitless (Risk Score)
WiNGS-Ops	Ignition Risk	Wildfire and PSPS risk are calculated based on a 72-hour weather forecast during severe weather conditions that could lead to a PSPS event	<ul style="list-style-type: none"> Probability of Failure Probability of Ignition Consequence of Ignition 	See likelihood and consequence model section in Appendix B	Overall Wildfire Risk at span level that can be rolled up to sectionalizing device or feeder level.	Unitless (Risk Score)
WiNGS-Ops	Wildfire Consequence Models	Wildfire and PSPS risk are calculated based on a 72-hour weather forecast during severe weather conditions that could lead to a PSPS event	Estimates of acres burned, building destroyed, and derived SIF estimation at asset location	WRRM 2022 outputs	Unit-less consequence value	Unitless (Risk Score)
WiNGS-Ops	Conditional Ignition Likelihood Models	Wildfire and PSPS risk are calculated based on a 72-hour weather forecast during severe weather conditions that could lead to a PSPS event	<ul style="list-style-type: none"> Weather conditions Asset level probability of failure models (PoF) and ignition probability models (PoI) 	See Appendix B	Likelihood of ignition at the asset level for the next 72 hours of weather forecast	Unitless (Probability)
WiNGS-Ops	Span-based Ignitions	Wildfire and PSPS risk are calculated based on a 72-hour weather forecast during severe weather conditions that could lead to a PSPS event	<ul style="list-style-type: none"> Weather conditions Asset level probability of failure models (PoF) and ignition probability models (PoI) Fuels layer 	See Appendix B	Likelihood of ignition at the asset level for the next 72 hours of weather forecast	Unitless (Probability)

ID (Model Name)	Risk Component	Design Scenario(s)	Key Inputs	Source of Inputs (Data and/or Models)	Key Outputs	Units
WiNGS-Ops	Pole-based Ignitions	Wildfire and PSPS risk are calculated based on a 72-hour weather forecast during severe weather conditions that could lead to a PSPS event	<ul style="list-style-type: none"> Weather conditions Asset level likelihood of failure models (PoF) and ignition likelihood models (Pol) Fuels layer 	See Appendix B	Likelihood of ignition at the asset level for the next 72 hours of weather forecast	Unitless (Probability)
WiNGS-Ops	Conductor Probability of Failure	Wildfire and PSPS risk are calculated based on a 72-hour weather forecast during severe weather conditions that could lead to a PSPS event	<ul style="list-style-type: none"> Historical Weather conditions Historical conductor failures Asset location and attributes 	See Appendix B	Likelihood of failure at the asset level for the next 72 hours of weather forecast	Unitless (Probability)
WiNGS-Ops	Vegetation	Wildfire and PSPS risk are calculated based on a 72-hour weather forecast during severe weather conditions that could lead to a PSPS event	<ul style="list-style-type: none"> Historical Weather conditions Historical conductor failures Asset and Vegetation location and attributes 	See Appendix B	Likelihood of failure at the asset level for the next 72 hours of weather forecast	Unitless (Probability)
WiNGS-Ops	Balloon	Wildfire and PSPS risk are calculated based on a 72-hour weather forecast during severe weather conditions that could lead to a PSPS event	<ul style="list-style-type: none"> Historical Weather conditions Historical balloon contacts Asset location and attributes 	See Appendix B	Likelihood of failure at the asset level for the next 72 hours of weather forecast	Unitless (Probability)
WiNGS-Ops	Animal	Wildfire and PSPS risk are calculated based on a 72-hour weather forecast during severe weather conditions that could lead to a PSPS event	<ul style="list-style-type: none"> Historical Weather conditions Historical animal contacts Asset location and attributes 	See Appendix B	Likelihood of failure at the asset level for the next 72 hours of weather forecast	Unitless (Probability)
WiNGS-Ops	Vehicle	Wildfire and PSPS risk are calculated based on a 72-hour weather forecast during severe weather	<ul style="list-style-type: none"> Historical Weather conditions Historical vehicle contacts Asset location and attributes Nearby road conditions 	See Appendix B	Likelihood of failure at the asset level for the next 72 hours of weather forecast	Unitless (Probability)

ID (Model Name)	Risk Component	Design Scenario(s)	Key Inputs	Source of Inputs (Data and/or Models)	Key Outputs	Units
		conditions that could lead to a PSPS event				
WiNGS-Ops	PSPS Risk	Wildfire and PSPS risk are calculated based on a 72-hour weather forecast during severe weather conditions that could lead to a PSPS event	<ul style="list-style-type: none"> • Weather conditions • Expected PSPS duration • Financial impact • Customers affected downstream of SCADA Sectionalizing Device 	See Appendix B	Risk score values at SCADA Sectionalizing devices	Unitless (Probability)

6.2 Risk Analysis Framework

This WMP is developed using SDG&E’s Enterprise Risk Management Framework, which is modeled after an internationally recognized risk management standard, ISO 31000. The Enterprise Risk Management Framework includes, risk identification, risk analysis, risk evaluation and prioritization, risk mitigation plan development and documentation, risk-informed investment decision and risk mitigation implementation and lastly, monitoring and review. In addition, see Section 4.4 Risk Informed Framework for details on the overall Enterprise Risk Management Framework.

6.2.1 Risk and Risk Component Identification

The first step of the Enterprise Risk Management Framework is Risk Identification (see Figure 6-2).

Figure 6-2: Risk Identification Step of the Enterprise Risk Management Framework

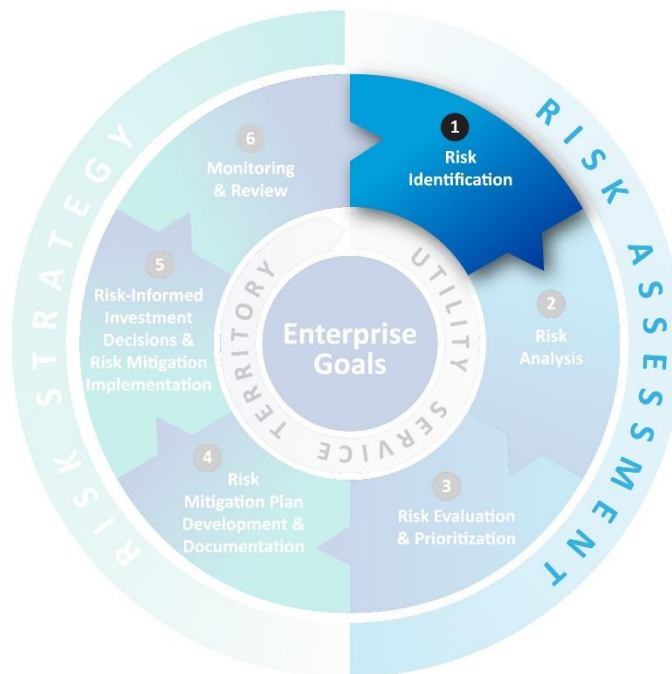

The Risk Identification step involves the identification of hazards and the determination of the likelihood of hazards. Figure 6-3 shows the process for identifying overall utility risk.

Figure 6-3: Enterprise Utility Risk Overview

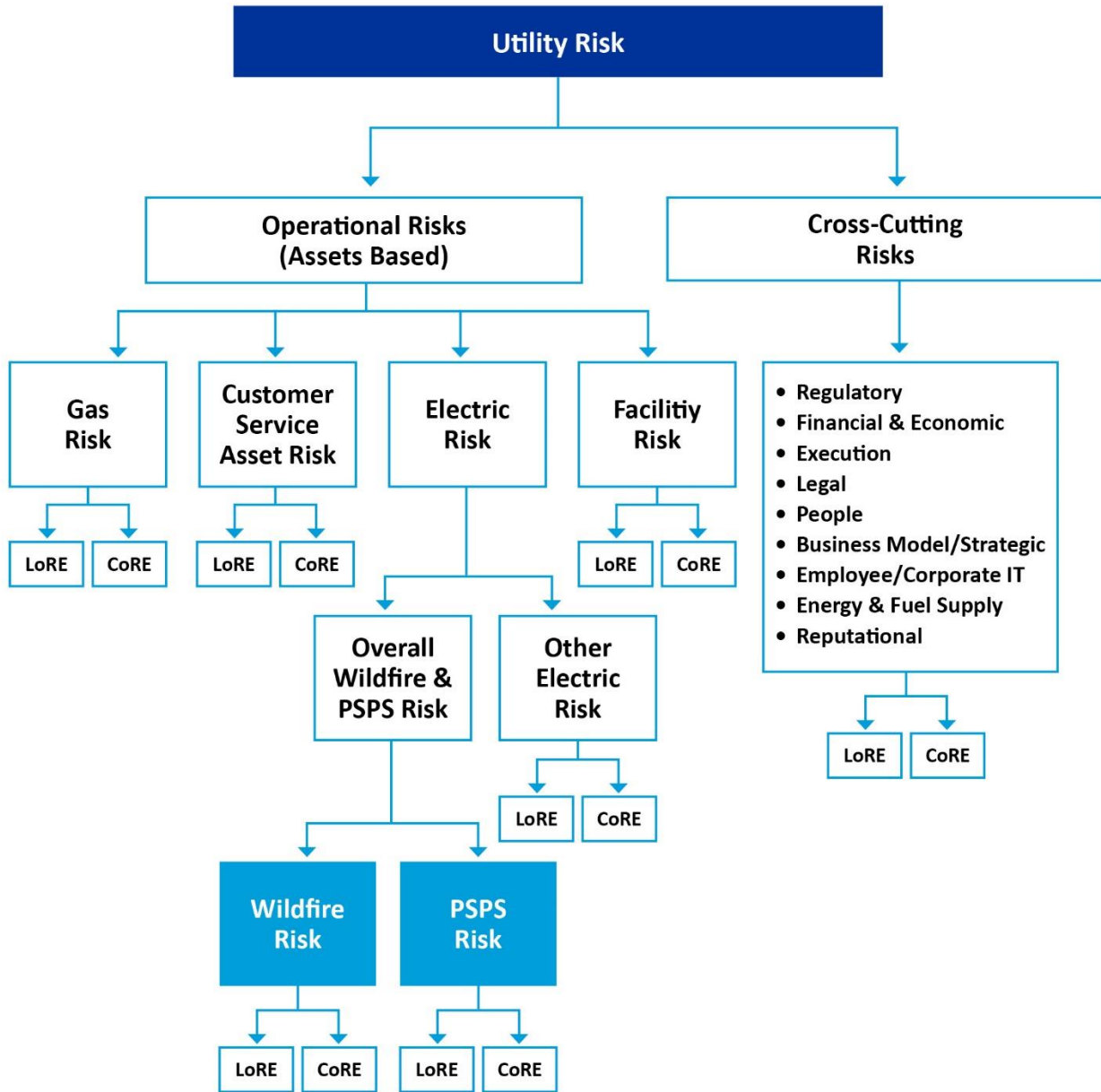

Utility Risk: Risks that arise from the operation and delivery of potentially inherently hazardous commodities (electricity and gas).

Operational Risks (Assets Based): Risks associated with the safe and reliable operation of assets designed to deliver commodities (electricity and gas) that provide energy to a wide customer base, with an emphasis on safety and reliability. These include Gas Risk, Customer Service Asset Risk, Electric Risk, and Facility Risk.

Cross-Cutting Risks: Risks to those support functions that may impact one or more aspects of the Operational (Asset Based) risks. That is, risks that may not necessarily be directly associated with one risk, but could affect all operational risks.

Overall Wildfire and PSPS Risk: Part of Electric Risk, reflecting the aggregate potential of adverse impacts to people, property, critical infrastructure, or other valued assets. It is made up of the total expected annualized impact from ignition and PSPS events at a specific location. This metric is a summation of the Wildfire and PSPS risk scores.

Wildfire Risk: The total expected annualized impacts from ignitions at a specific location.

PSPS Risk: The total expected annualized impacts from PSPS at a specific location. PSPS Risk is highly dependent on the topology of the circuit.

The WiNGS Planning model is used to calculate the Wildfire Risk and PSPS Risk scores used in the Overall Wildfire and PSPS Risk component. It was developed to aid with the allocation of grid hardening initiatives across the HFTD by assessing both wildfire risk and PSPS impacts. The WiNGS-Planning model risk calculation process is described in Figure 6-4.

Figure 6-4: WiNGS-Planning Risk Calculation Process Flow Diagram

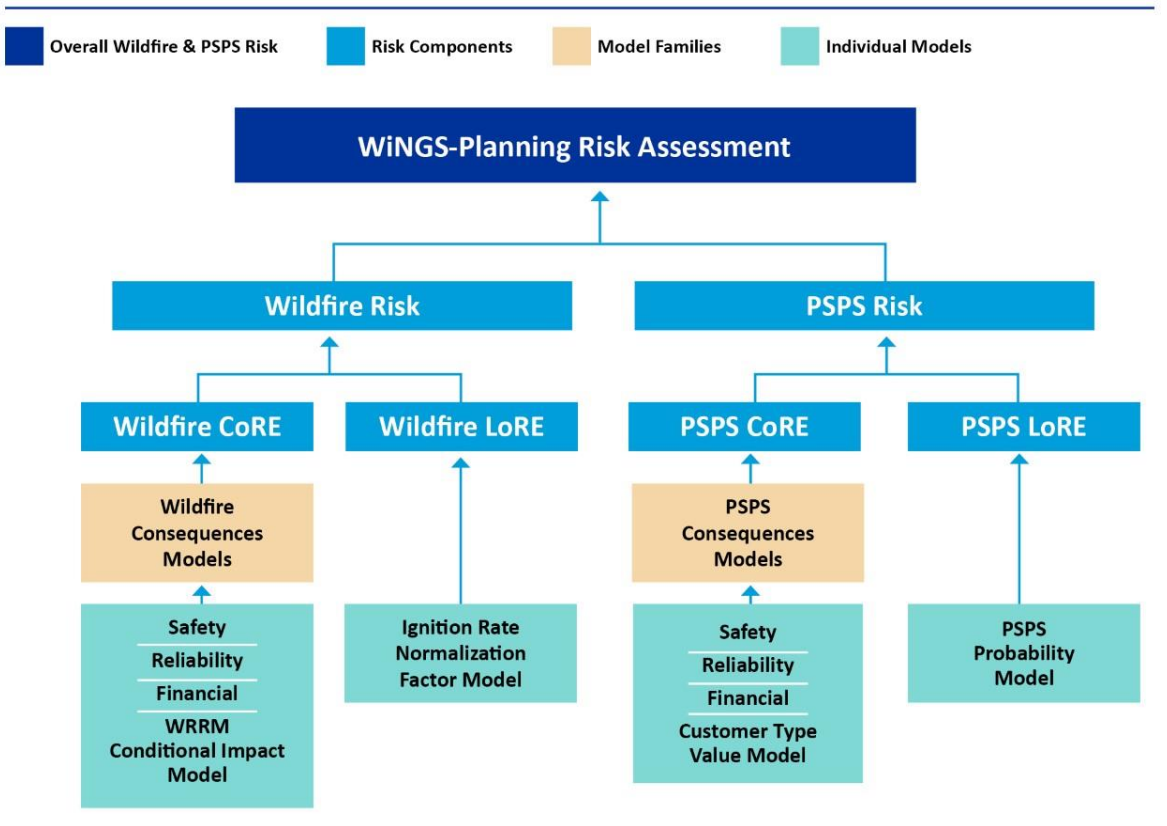

WiNGS-Planning is built upon the MAVF framework in RAMP and evaluates both wildfire and PSPS impacts at the sub-circuit/segment level. The segment level of data granularity is required to establish

the segment parameters. Information is used to inform investment decisions by determining and prioritizing mitigation based on cost-benefit analysis, improving wildfire safety, and limiting the impact of PSPS on customers.

Through its participation in Energy Safety-led joint IOU risk modeling working groups and internally driven improvements, SDG&E incorporated several updates and enhancements to the WiNGS-Planning models. The WiNGS-Planning model versions referred to in this document span versions 1.0, 2.0, and latest version 3.0. WiNGS-Planning 1.0 is relevant to circuit segments that have been scoped for mitigation in the years 2022 through 2024. Version 2.0 is the is relevant to scoping years 2025 and 2026. WiNGS-Planning 3.0, released in 2023 for 2027 mitigation scoping, is the latest version and is referred to when describing the most recent improvements to the model.

Between WiNGS-Planning 1.0 and 2.0, data quality was enhanced by more accurately capturing hardening miles within the HFTD, improving the methodology behind calculating the overhead-to-underground mileage conversion contingency factor, and updating the data incorporated from WRRM. Updated data has also been incorporated, such as the effectiveness of different mitigations at reducing wildfire risk and refreshing historical ignition counts to enhance the model's estimated ignition rates. A data refresh between model versions presents the most up to date and accurate information to inform decisions regarding grid hardening strategy. Components like historical wind, weather station additions, PSPS history, system assets, information regarding vulnerable customers, and vegetation data have all been updated.

Updated data has also been incorporated that reflects additional information gained through implementation of wildfire mitigations projects. For instance, additional data associated with the Strategic Undergrounding Program (WMP.473), such as avoided costs associated with fewer vegetation management activities, reduced PSPS scope, and reduced maintenance costs are all included, which allow for life cycle costs to be modeled. In addition, undergrounding cost per mile has decreased by approximately 12 percent, resulting in an increased Risk Spend Efficiency (RSE) associated with undergrounding.

Enhancements from WiNGS-Planning 2.0 to 3.0 focused on reproducibility with major architectural changes from Excel to Python, allowing for code version control. Another major enhancement was the ability to directly gauge risk reduction over time with the inclusion of scoping data. It is important to note that WiNGS-Planning versions 1.0, 2.0, and 3.0 use fundamentally similar logic and changes have been kept minimal during the architectural transition from Excel to Python. The current development version of the WiNGS-Planning model is referred to as version 4.0. The upcoming release is expected to include changes designed to improve risk calculation scores.

The WiNGS-Ops model assesses overall Wildfire and PSPS Risk, which are aligned to the Electric and Operations (Asset Based) subcomponents of Overall Utility Risk. The WiNGS-Ops model risk calculation process is described in Figure 6-5.

Figure 6-5: WiNGS-Ops Calculation Process Flow Diagram

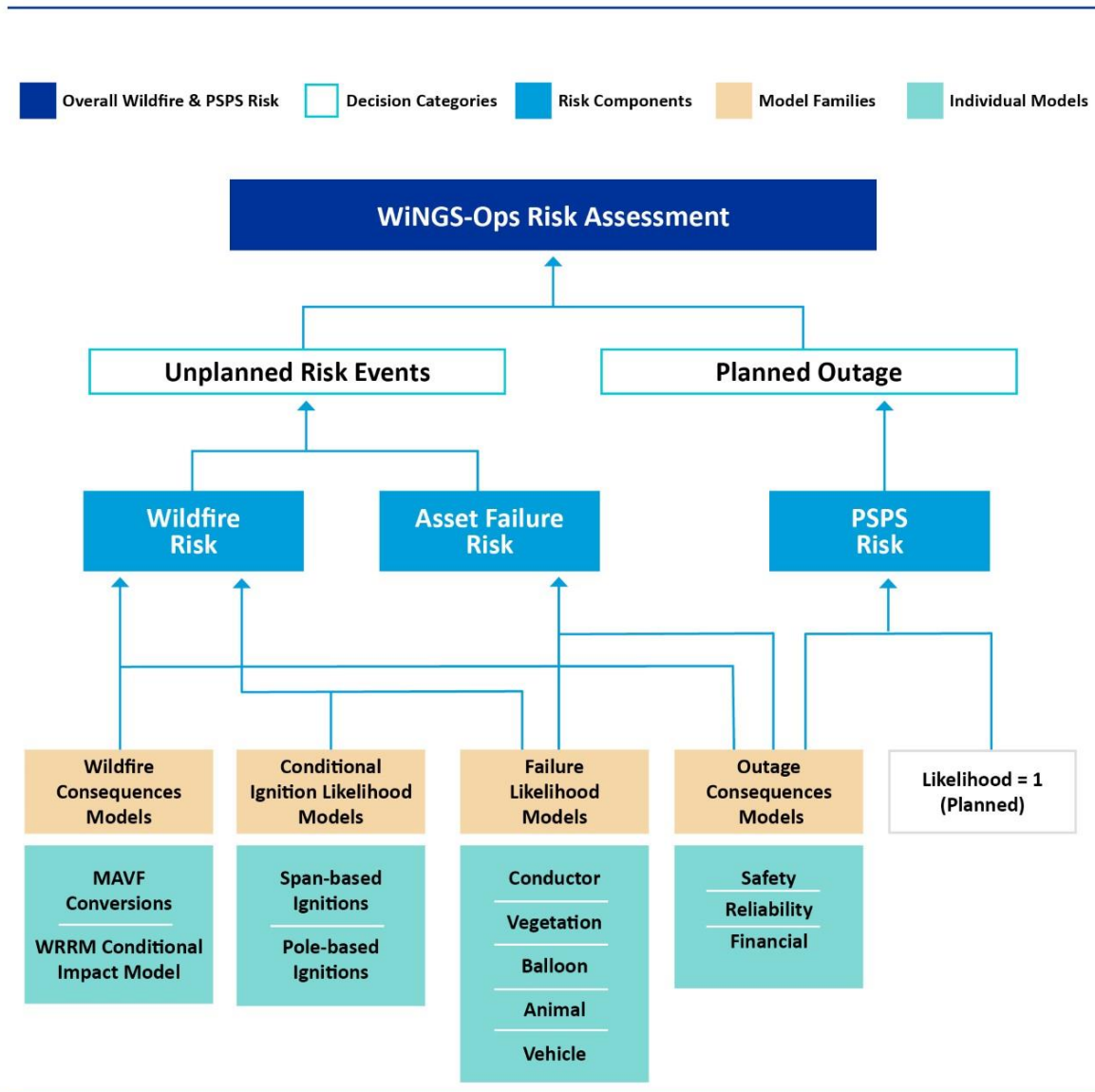

WiNGS-Ops is a real-time risk assessment model built to evaluate and compare Wildfire and PSPS risks at the asset level (pole/span) and the sub-circuit/segment level at hourly intervals. The primary purpose of the model is to help inform decision makers in real-time about Wildfire and PSPS risks, which will guide risk-based de-energization decisions during risk events. The model outputs used to help guide decision makers are understood to represent a range of potential risk of Wildfire versus PSPS comparisons.

Several model families inform the WiNGS-Ops management of Wildfire and PSPS events.

- Wildfire Consequence Models: Rely on simulations of wildfire impacts
- Conditional Ignition Likelihood Models: Model likelihood of span- and pole-based ignitions
- Failure Likelihood Models: Model failures of assets and drivers

- Outage Consequence Models: Use the MAVF attributes to assess consequences of utility outages

These model families integrate numerous inputs across weather, asset, customer information, event-specific assumption, and other external source data categories, as shown in Figure 6-5. The model outputs are then used when considering whether to initiate a PSPS event, e.g., when potential Wildfire risk consequences outweigh potential PSPS risk consequences, de-energization might be advisable.

WINGS-Ops 2.0 presents several updates compared to its previous version. The most relevant updates are:

- Retrained existing models with new historical observations
- Incorporated AFN customer impact scaling factors
- Improved consequence calculation by estimating the impact of an unplanned outage (wildfire) versus a proactive deenergization (PSPS event)
- Improvements to reproducibility, code version control, and audibility
- Models migrated to a cloud-based, Amazon Web Services (AWS) architecture that meets internal cybersecurity requirements

Technosylva's Wildfire Analyst™ Enterprise (WFA-E) product is used to conduct the modeling, deliver modeling outputs, and monitor and visualize results with software applications.

The wildfire behavior modeling and risk analysis is applied to address two different, yet similar, scenarios. First, the modeling is used with historical re-analysis Weather Research and Forecast (WRF) (WMP.532) weather data to support the mitigation planning process. The WFA-E WRRM is used to quantify risk metrics from millions of wildfire simulations using the numerous WRF weather scenarios defined. This wildfire consequence data is then combined with probability of failure and ignition analysis developed internally to define composite risk values to support prioritization decision making for asset hardening and related mitigation.

Secondly, the modeling is also used with daily WRF-based weather forecast data to calculate consequence-based risk metrics for all assets as possible ignition sources to support operational requirements. Other key input datasets such as surface and canopy fuels, and live fuel moisture (LFM) and dead fuel moisture (DFM), is developed daily using Machine Learning (ML) models to calculate the wildfire behavior outputs as part of the risk analysis model. Wildfire risk forecasts are derived daily, or sometimes twice daily, with a multi-day outlook on an hourly basis. This information is used as input into key decision making related to operational requirements, such as PSPS, resource allocation and deployment, field operations, etc.

6.2.2 Risk and Risk Components Calculation

The second step of the Enterprise Risk Management Framework is Risk Analysis (see Figure 6-6). Part of Risk Analysis is calculating risks and risk components. See Section 4.4 Risk Informed Framework for details on the Enterprise Risk Management Framework.

Figure 6-6: Risk Analysis Step of the Enterprise Risk Management Framework

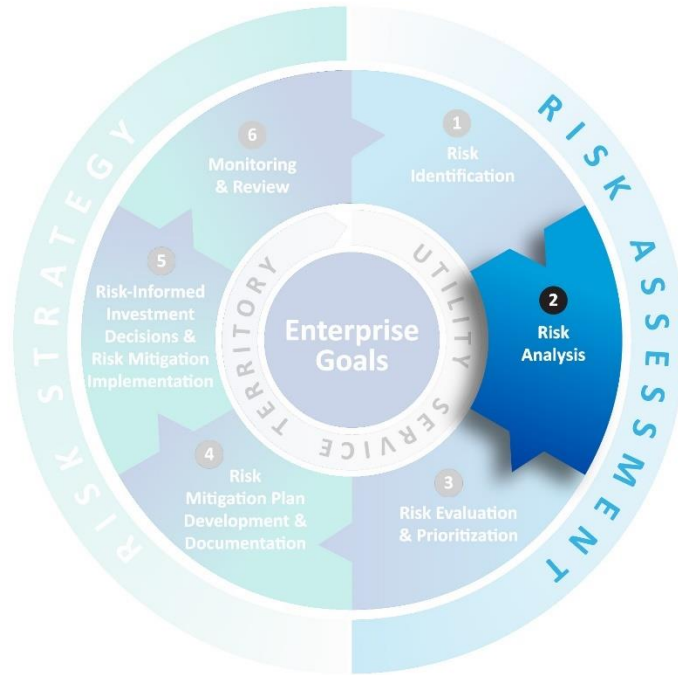

SDG&E continually evaluates its wildfire risk assessments regarding the probability of ignitions and the consequences of wildfires. This section provides an explanation of how Wildfire Risk and PPS Risk LoRE and CoRE are estimated to establish baseline risk estimates. For details on how LoRE and CoRE are estimated in WiNGS-Planning and WiNGS-Ops, see Appendix B.

Wildfire risk has an extremely wide range of impacts (i.e., some fires have no impact while others can cause catastrophic devastation); is situationally dependent on many changing variables (e.g., climate change, weather, and vegetation); has risk drivers that are frequently outside a utility’s control (e.g., man-made debris, animal, human, and vegetation contacts); and has rare significant impacts, leading to some low-confidence estimations of future risk. SDG&E regularly works with industry experts, academia, government agencies, and other stakeholders to better understand and quantify the impact of catastrophic wildfires, e.g., through analyses on estimated wildfire spread, acres burned, and buildings impacted or destroyed.

General WiNGS-Planning and WiNGS-Ops model process flow diagrams depicting the various model elements and process steps and their interactions is detailed in Figure 6-7 and Figure 6-8.

Figure 6-7: WiNGS-Planning Calculation Schematic

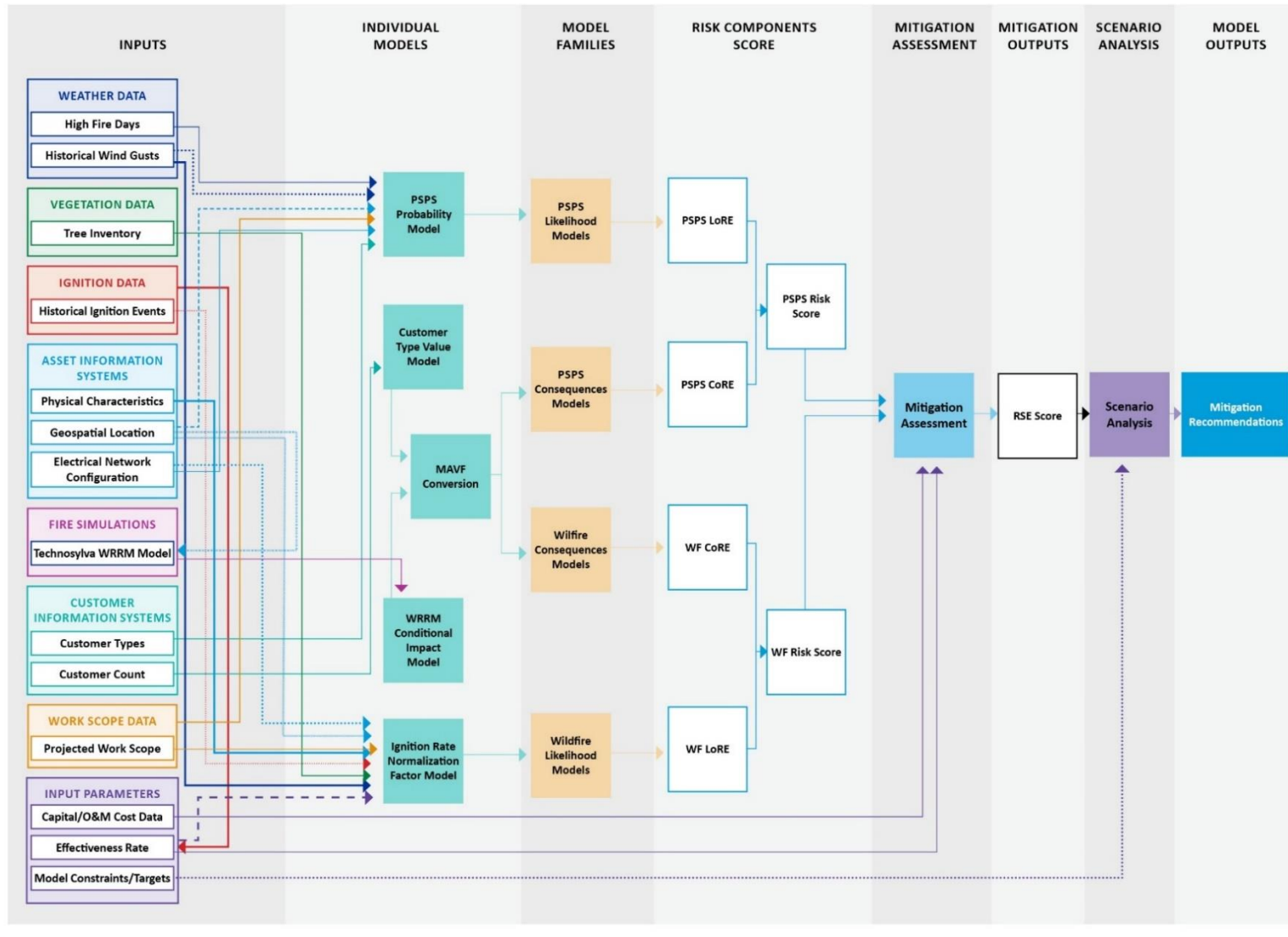

Note: RSE Score currently incorporates Wildfire Risk Score only. In future versions, RSE Score will incorporate both Wildfire and PPS Risk Score.

Figure 6-8: WiNGS-Ops Calculation Schematic

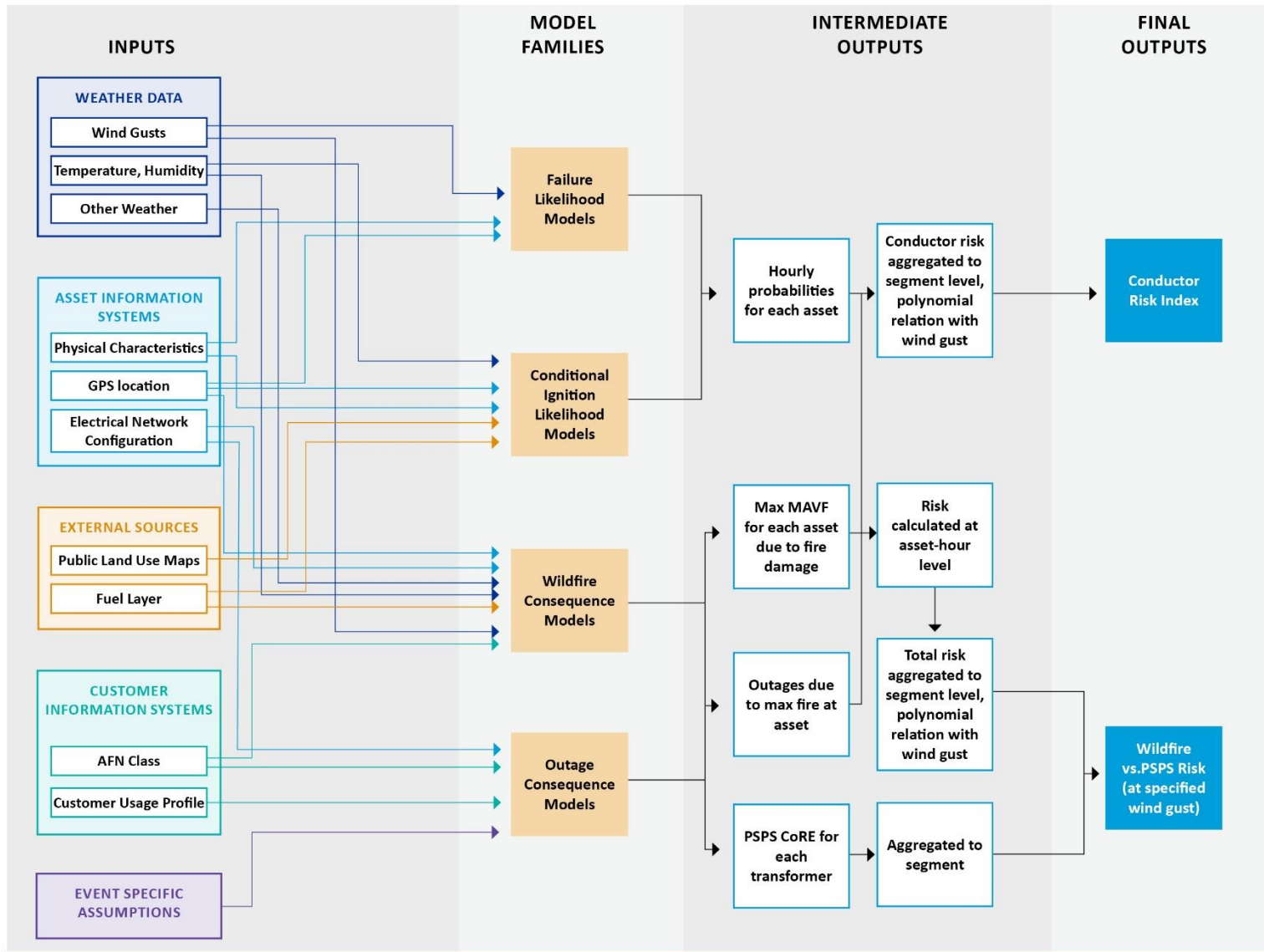

6.2.2.1 Likelihood

Within the WiNGS-Planning model, the LoRE component leverages a variety of data to calculate the likelihood of a risk event occurring in a year. The unit of this metric is the expected annual rate of a risk event occurring as detailed in RAMP-C Risk Quantification Framework and RSE from May 21, 2021, page C-21. SDG&E Table 6-4 shows the risk components for LoRE.

SDG&E Table 6-4: Risk Components for LoRE

Risk Component	Description
Ignition Likelihood	Annual ignition rate in the HFTD adjusted to account for wind speed, historical tree strikes, vegetation density, asset hardening, and asset health.
Equipment Failure Likelihood of Ignition	Asset health adjustment score to the annual ignition rate based local geographic characteristics of equipment. Applied to mitigation effectiveness scores for covered conductor, traditional hardening, and undergrounding.
Contact from Vegetation Likelihood of Ignition	Annual ignition rate adjustment based on tree strike analysis. Applied to mitigation effectiveness scores for covered conductor, traditional hardening, and undergrounding.
Contact from Object Likelihood of Ignition	Applied to mitigation effectiveness scores for covered conductor, traditional hardening, and undergrounding.
Burn Probability	Part of the WRRM model. Used in Wildfire LoRE. Not used in CoRE.
PSPS Likelihood	The probability represents the likelihood that the wind speeds measured at the weather station closest to the segment will exceed a set wind speed threshold (e.g., 50 mph) in a year.
Wind Gust	Annual ignition rate adjustment based on the maximum recorded wind gust based for the associated weather station.
Percent Hardening	Annual ignition rate adjustment based on the existing and future projected hardening state mileage percentages for each circuit-segment.
Significant Wildfire Rate	Annual ignition rate based on the expected frequency of wildfire in the service territory.

How Wildfire LoRE is modeled and used for developing the WMP is outlined in the following steps:

Ignition Likelihood: Ignition Likelihood is created using an annual ignition rate for the HFTD. The annual ignition rate is adjusted to account for local conditions including wind speed, historical tree strikes, vegetation density, asset hardening, and asset health. Historical data from both reportable ignitions (since 2014) and large fire history (since 1970) reports was used to generate the annual ignition rate.

Equipment failure likelihood of ignition: Equipment failure likelihood of ignition is accounted for in the WiNGS-Planning model as an asset health adjustment score to the annual ignition rate based local geographic characteristics of equipment.

The asset health adjustment factor captures the effect of known asset conditions that may affect the likelihood of a fault or ignition. The two key inputs to this adjustment factor are the average conductor age and a Circuit Health Index (CHI). The average conductor age serves as a proxy for wire-down

incidents due to conductor deterioration related conditions. The CHI serves as a proxy for wire-down incidents due to pole deterioration related conditions. The value is a unitless index calculated at an individual pole level and the median pole value and is used to determine the segment CHI. For non-HFTD segments with no CHI value, the average CHI value of all of the non-HFTD pole values was used in place. Similarly, for HFTD segments with no CHI value, the average CHI value of HFTD pole values were used in place.

Both the conductor age and CHI values are first normalized by dividing the individual factor by its average value in the WiNGS-Planning analysis. The normalized conductor age is weighted twice as high compared to the normalized CHI since more wire downs due to aging conductors are prevalent than those due to deteriorated poles. The asset health adjustment factor is the sum of the normalized conductor age and normalized CHI.

Contact from vegetation likelihood of ignition: The WiNGS-Planning annual ignition rate is further adjusted by the Tree Strike variable. Both the number of historical tree strikes that have occurred over the past 5 years and the length of overhead mileage susceptible to tree strikes are captured. This variable is created by buffering Tree Inventory data by the height attribute of each tree record. The buffered tree polygons are then intersected with the circuit segment lines to derive both the count of intersecting tree buffers and the length of conductor that is covered by non-overlapping tree buffers.

Contact from object likelihood of ignition: Contact from object likelihood of ignition is part of the annual ignition rate and is incorporated into the mitigation effectiveness scores for covered conductor, traditional hardening, and undergrounding. Contact from object is incorporated into improvement plan as an enhancement to the ignition rate. See Section 6.7 Risk Assessment Improvement Plan for details.

Wildfire spread likelihood: Wildfire spread likelihood is accounted for in the WRRM model developed by Technosylva. The rate of spread variable is an output of the WRRM model. WRRM is the main component of Wildfire CoRE.

PSPS likelihood: The likelihood of a PSPS event occurring is determined using several probabilities of a PSPS event being initiated on that segment. The probabilities are determined by Meteorology. The probability represents the likelihood that wind speeds measured at the weather station closest to a segment will exceed a set wind speed threshold (e.g., 50 mph) in a year. Thresholds are determined by analyzing 5 years of historical data. In order to determine the baseline PSPS risk, each segment utilizes the segment-specific probability and the maximum upstream probability.

Recent improvements to PSPS quantification include the following:

- PSPS risk reduction is updated and incorporated into WiNGS-Planning 3.0. It tracks PSPS risk mitigated via covered conductor and undergrounding projects per year over multiple years.
- PSPS probability within PSPS Risk Score quantification is now dynamically updated per hardening state assessment.
- PSPS risk reduction quantification has been automated in Python.
- PSPS probability criteria has been updated to expand the wind climatology and more accurately reflect the wind potential present during PSPS events. This involves limiting the scope to the highest fire season, from September 1 through December 30, with the additional inclusion of any Red Flag Warning (RFW) days that occur in spring.

Significant Wildfire Adjustment rate: For the last step in the ignition likelihood calculation, a wildfire adjustment is applied to obtain the Wildfire LoRE score. The adjustment equates to a scenario stating one substantial fire will occur every 15 years.

For further information on how LoRE is used in Wings-Planning and WiNGS-Ops (including ignition likelihood, burn probability, and PSPS likelihood), see Appendix B.

6.2.2.2 Consequence

CoRE is calculated utilizing the MAVF framework. Given the occurrence of a risk event (Wildfire or PSPS), this framework is used to estimate the potential consequences across attributes (Safety, Reliability, and Financial) to determine a total consequence value.

Refer to Section 6.1.1 Overview for a discussion and justification of each parameter. Risk components and how Wildfire and PSPS CoRE are modeled and used for developing the WMP are detailed in SDG&E Table 6-5.

SDG&E Table 6-5: Risk Components for Consequence

Risk Component	Description
Wildfire consequence	Unitless risk score calculated per SDG&E’s MAVF
Wildfire hazard intensity	Technosylva WRRM 2022 acres burned and structures destroyed estimates at each asset location in the service territory
Wildfire exposure potential	The potential impact of a Wildfire event quantified based on Safety, Reliability, and Financial attributes. Currently, SDG&E only models the direct and short-term impacts of de-energization events.
Wildfire vulnerability	The potential impact of a Wildfire event at the Sectionalizing Device level is quantified based on customer types and expected outage duration and utilizes subject matter expertise for conservative assumptions to estimate serious injuries and fatalities, SAIDI and SAIFI values, and financial impacts from Technosylva WRRM 2022 outputs.
PSPS consequence	Unitless risk score calculated per SDG&E’s MAVF
PSPS exposure potential	The potential impact of a PSPS event quantified based on Safety, Reliability, and Financial attributes. Currently, only direct and short-term impacts of de-energization events are modeled.
PSPS vulnerability	The potential impact of PSPS event at the Sectionalizing Device level is quantified based on customer types and expected PSPS duration and utilized subject matter expertise for conservative assumptions to estimate serious injuries and fatalities, SAIDI and SAIFI values, and financial impacts.
Significant Wildfire Adjustment rate	Ignition rate adjustment to account for expected wildfire frequency

How Wildfire CoRE is modeled and used for developing the WMP is outlined in the following steps:

Safety: Assumptions for Serious Injuries and Fatalities (SIF) estimates are based on review of historical wildfire data and updated when new data is available.

Reliability: Assumptions for System Average Duration Index (SAIDI) and System Average Interruption Frequency Index (SAIFI) estimates are based on review of historical outage data and updated when new data is available.

Financial Consequence: Calculated from historical wildfire records (acres burned and structures destroyed). Due to the difficulty to determine the precise financial losses of wildfire events and the lack of a single source of financial impacts from wildfire, subject matter expert assumptions are made when translating acres burned and buildings destroyed into a financial dollar estimate. Wildfire events primarily have costs related to property damage, personal injury or fatality, suppression costs, environmental damage and remediation, lost economic output for various reasons (including work closures and employee unavailability), and personal relocation. Available data is used to approximate financial impacts and assumptions will continue to be modified as new information becomes available. In addition, partnerships with industry leader companies and academia institutions will continue in order to better estimate the financial impact of a catastrophic wildfire in its communities.

WRRM: The WRRM model is used as the basis for wildfire consequence in the WiNGS-Planning model. This model was developed by Technosylva and consists of outputs relating to buildings, acres, and population affected based on numerous model simulations using SDG&E assets as ignition points. In addition to the affected conditions, attributes such as fire behavior index and flame length are also provided to gauge wildfire spread. The current model derives outputs using an 8-hour simulation duration, which is the assumed typical first burning period. Other burn periods are currently being evaluated.

The WRRM model is delivered annually prior to fire season and undergoes a comparison with the previous year's submission. This involves the examination of column header changes, measurement changes, quantile changes, and general format changes. Error detection is currently automated within the WiNGS-Planning 3.0 version model, which will be released in 2023 for future scoping. This error detection tracks changes to output columns including every quantile for acres, buildings, population, fire behavior index, flame length, rate of spread, and buildings destroyed upon every model run. Thus, if an unwanted change in one of the WRRM columns were to occur, it would be caught via this detection method and further examined by staff data scientists.

How PSPS CoRE is modeled and used for developing the WMP is outlined in the following steps:

Safety Consequence: Safety Consequence is estimated based on historical PSPS events across California and reviewed to understand the frequency, duration, and magnitude (customer affected) of PSPS activations. As the safety impact of a PSPS event is not the same for all customer types, a Customer Type Value Consequence is estimated to represent different levels of Safety impacts. Based on subject matter expert assumptions, different weighting (or scaling factors) is applied to each customer meter to increase the number of SIFs downstream of each SCADA Sectionalizing device. Customer Type Value Consequence includes:

- Critical Facilities and Critical Infrastructure: Customers based on the CPUC's De-Energization proceeding definition.
- Community Vulnerability: AFN customers based on CPUC's definition of AFN customers
- Other: All other customers that do not fall in either the critical or AFN categories
- The WiNGS-Planning model includes Medical Baseline (MBL), Urgent, Essential, Sensitive, and Life support customers in its PSPS Consequence module. AFN customers are expected to be incorporated within the current WMP cycle.

See response to Areas for Continued Improvement SDGE-22-04 in Appendix D.

Reliability: Subject matter expert assumptions for SAIDI and SAIFI estimates are based on review of historical SAIDI and SAIFI values associated with past PSPS events in the service territory.

Financial: Per customer and per PSPS event, a potential financial impact is estimated based on subject matter expert assumptions.

The Safety, Reliability, and Financial modeling approach for the PSPS Risk model continues to be refined as new data, assumptions, or additional information is evaluated.

SDG&E regularly works with industry experts, academia, government agencies, and other stakeholders to better understand and quantify the impact of catastrophic wildfires, e.g., through analyses on estimated wildfire spread, acres burned, and buildings impacted or destroyed. For further information on how CoRE is used in Wings-Planning and WiNGS-Ops (including wildfire consequence, wildfire hazard intensity, wildfire exposure potential, wildfire vulnerability, PSPS consequence, PSPS exposure potential, PSPS vulnerability), see Appendix B.

6.2.2.3 Risk

Risk values for Overall Wildfire and PSPS Risk are calculated as the product of LoRE and CoRE.

Since the MAVF framework is used to estimate both the Wildfire and PSPS consequence scores, they can be combined to estimate the Overall Wildfire and PSPS Utility Risk as shown in SDG&E Table 6-6.

SDG&E Table 6-6: Pre-Mitigation Analysis Risk Quantification Scores¹⁷

	Wildfire Risk	PSPS Risk	Overall Wildfire and PSPS Risk
LoRE	19.2	4	n/a
CoRE*	805.9	1,268.7	n/a
Pre-Mitigation Risk Score (LoRE x CoRE)	15,473.3	3,907	19,381.01

For further information on how Risk is used in Wings-Planning and WiNGS-Ops see Appendix B.

¹⁷ The term "pre-mitigation analysis," in the language of the Settlement Decision refers to required preactivity analysis conducted prior to implementing control or mitigation activity, see D.18-12-014 at Attachment A, A-12 ("Determination of Pre-Mitigation LoRE by Tranche," "Determination of PreMitigation CoRE," "Measurement of Pre-Mitigation Risk Score").

6.2.3 Key Assumptions and Limitations

OEIS Table 6-2: Risk Modeling Assumptions and Limitations

Assumption	Rationale/Justification	Limitation	Applicable Models
Average duration of PSPS event for every SCADA Sectionalizing Device	Subject matter expert estimate based on historical average of PSPS events in the service territory	Estimating the potential duration of a PSPS event at each SCADA Sectionalizing Device is a complex task as multiple variables are in play (weather forecast, firefighting resources, existing wildfires, crew availability, etc.) SDG&E plans to continue evaluating and improving this assumption as part of its continuous improvement approach towards its wildfire and PSPS modeling initiatives	WiNGS-Ops, PSPS Risk, WiNGS-Planning
Customer Impact scaling factor	Subject matter expert estimate to increase the PSPS impact to Critical and Vulnerable population	Lack of reliable data on how to quantify PSPS impacts on SDG&E customers	WiNGS-Ops, PSPS Risk, WiNGS-Planning
Serious Injuries and Fatalities per customer minute de-energized	Subject matter expert conservative assumption to estimate the potential number of fatalities and serious injuries because of a PSPS event. The assumption is estimated based on a review of historical PSPS events in California (2018-2022)	Lack of historical serious injuries or fatalities due to PSPS events in California	WiNGS-Ops, PSPS Risk, WiNGS-Planning
Financial impact during a PSPS event	Subject matter expert conservative estimate to estimate the potential financial loss of customers affected by a PSPS de-energization event. Assumption is estimated based on review of Value of Lost Load estimations, the potential cost of a customer finding alternative generation (batteries or generators), and proxies derived from the Federal per Diem rate for lodging, meals, and incidentals in San Diego County.	SDG&E plans to continue evaluating and improving these financial assumptions as part of its continuous improvement approach. In addition, SDG&E will work with LBNL in its refinement of its ICE Calculator 2.0 model as recommended by the Final Decision in Phase II of the S-MAP OIR.	WiNGS-Ops, PSPS Risk, WiNGS-Planning
Number of Serious Injuries and Fatalities (SIFs) per structure destroyed in case of a catastrophic wildfire	Subject matter expert conservative estimate to quantify the potential number of SIFs based on worst-case estimations of acres burned calculated by WRRM 2022	Lack of historical data	WiNGS-Ops, Wildfire Risk, WiNGS-Planning
Safety attribute to account for the	Described in detail in RAMP report		WiNGS-Ops, Wildfire Risk, WiNGS-Planning

Assumption	Rationale/Justification	Limitation	Applicable Models
detrimental impacts of pollution to human health			
Outage duration in case of a catastrophic wildfire	Subject matter expert conservative estimate to estimate SAIDI and SAIFI values based on estimates of outage duration and assumed restoration duration.		WiNGS-Ops, Wildfire Risk, WiNGS-Planning
Financial impacts in case of a catastrophic wildfire	Subject matter expert conservative estimate to translate buildings destroyed and acres impacted based on values from WRRM 2022 output simulations to financial dollars.		WiNGS-Ops, Wildfire Risk, WiNGS-Planning
Significant Wildfire Probability	Wildfire frequency adjustment to ignition rate based on the effect that climate change has on wildfire frequency.	Based on Monte Carlo analysis, not standard climate change scenarios.	WiNGS-Planning
Segment level attributes	To account for localized conditions describing the predominant characteristics for a circuit segment.	Singular attributes for variables such as wind gusts and tree strike potential are aggregated to the entire segment and can vary greatly between the spans on a segment.	WiNGS-Planning
Ignition Rate Annual	Average number of ignitions per year	Starting ignition total does not take into account localized conditions	WiNGS-Planning
Santa Ana Days	Average number of Santa Ana wind event days per year	Based on past events	WiNGS-Planning
PSPS Duration	Length of historical PSPS data	None	WiNGS-Planning
Red flag days	Assumed red flag days per year	Based on prior years' red flag warnings	WiNGS-Planning
Red flag hours	Assumed duration of PSPS during a red flag day	Based on prior years' red flag warnings	WiNGS-Planning
PSPS UG Flag	Variable to indicate whether undergrounding completely removes the need for PSPS	Network connectivity must be considered	WiNGS-Planning
UG contingency	Additional static contingency applied to non-roadway miles to account for additional miles to underground	Roadway miles based on buffer of roadway with intersecting spans	WiNGS-Planning
Life TH	Traditional hardening lifetime	Based on subject matter expertise	WiNGS-Planning
Life CC	Covered conductor lifetime	Based on subject matter expertise	WiNGS-Planning
Life TH2CC	Conversion of TH to CC lifetime	Based on subject matter expertise	WiNGS-Planning
Life UG	Undergrounding lifetime	Based on subject matter expertise	WiNGS-Planning

6.3 Risk Scenarios

The second step of the Enterprise Risk Management Framework is Risk Analysis (see Section 6.2.2 Risk and Risk Components Calculation). Part of Risk Analysis is developing risk scenarios. See Section 4.4 Risk Informed Framework for details on the Enterprise Risk Management Framework.

Risk scenarios considered in WMP models relate to wildfire and PSPS mitigation investment planning as well as refined strategic shutoff of sectionalizing devices during PSPS events. While the scenarios are related, the modeling aspects require special consideration for each model.

WiNGS-Planning

Design considerations for WiNGS-Planning center around a long-term vision for reducing wildfire risk and PSPS risk in the HFTD. To determine primary design considerations, an accurate representation of field conditions that could contribute to wildfire ignition and/or spread is necessary. Ignition rate variables that are factored include wind gust, vegetation risk, percent hardening, and asset health. Wildfire consequence is derived from WRRM 2022.

The model versions referred to in this document span WiNGS-Planning versions 1.0, 2.0, and the latest version 3.0. Version 1.0 is relevant to circuit segments that have been scoped for mitigation in the years 2022 through 2024. Version 2.0 is relevant to scoping years 2025 and 2026. Both of those models are excel based. WiNGS-Planning 3.0, released in 2023 for 2027 mitigation scoping, is cloud based, and is referred to when describing the most recent improvements to the model.

WiNGS-Ops

WiNGS-Ops is a real-time risk assessment model built to evaluate and compare Wildfire and PSPS risks at the asset and customer level to help inform de-energization decisions during severe weather conditions.

Statistical and machine learning probability of failure (PoF) and probability of ignition (PoI) models are trained and tested on historical observations (weather, outages, asset attributes) and estimate likelihoods based on current and forecasted weather conditions. The consequence of wildfire for each MAVF attribute is assumed to be the worst-case condition, based on WRRM 2022 consequence simulation outputs.

While PSPS is an effective mitigation against potential ignitions under extreme wildfire conditions, it also has negative customer impacts. To model PSPS impacts, a 100-percent likelihood of de-energization is assumed for those areas experiencing severe weather conditions. The consequence of a PSPS event is modeled assuming subject matter expert conservative estimates on each MAVF attribute (Safety, Reliability, and Financial).

WiNGS Ops development will continue based on partnerships with industry, academia, government agencies and other stakeholders that provide new data on the consequences of catastrophic wildfires and PSPS events.

6.3.1 Design Basis Scenarios

The WiNGS-Planning model currently uses a single set of criteria for each variable. Both models undergo continual refinement and tuning for the purposes of creating the most accurate models possible. While the models are in a state of development, it is important to keep variables as constant as possible in order to gauge the impact of each singular change, whether it be architectural or design related. The design scenarios used in the current models are detailed in OEIS Table 6-3.

The initial design scenarios are based on the worst probable conditions during Santa Ana events. For instance, the WiNGS-Planning model uses the highest recorded wind gust per segment as recorded via the segment’s associated weather station. This practice coincides with the description for SDG&E defined Wind Load Condition 3 – Extreme. The maximum recorded wind gust is used to gauge the possible wind speeds that a circuit segment could experience during Santa Ana wind events. The maximum wind gust is not based on conjecture of climate change and is therefore not considered an extreme situation as the weather station has recorded these speeds in the past. It is important for the WiNGS-Planning model to use this design scenario so that the reliable worst-case scenario is accounted for in the ignition rate adjustment.

At this point in the evolution of the WiNGS-Planning models, Weather Condition 1 – Anticipated Conditions is used. The rationale behind this approach is that weather conditions can only be based on the lifespan of the circuit segments’ weather stations. The majority of these devices were installed starting in 2009, so a full 30-year history at the fine spatial granularity needed by the model is unavailable until approximately 2040.

In addition to weather condition design scenarios, SDG&E is currently evaluating climate change models with multiple design scenarios to help account for changing climate conditions over the decades to come. The WiNGS-Planning model currently employs an adjustment factor for expected wildfire frequency to account for climate change conditions. This approach results in an adjustment factor equating to one wildfire occurring every 15 years. This methodology is expected to be replaced within the current WMP cycle with an accepted climate change model.

The vegetation design scenario currently focuses on field conditions, which corresponds to Vegetation Condition 1 – Existing Fuel Load (based on potential fire season conditions). The variable used in WiNGS-Planning for vegetation strike vulnerability is called Tree Strikes and is based the tree inventory database.

OEIS Table 6-3: Summary of Design Basis Scenarios

Scenario ID	Design Scenario	Purpose
n/a	Wind Load Condition 1 – Baseline	The baseline wind load condition the electrical corporation uses in design, construction, and maintenance relative to General Order 95, Rule 31.1
n/a	Wind Load Condition 2 – Very High	95 th -percentile wind gusts based on maximum daily values over the 30-year history
n/a	Wind Load Condition 3 – Extreme	Wind gusts with a probability of exceedance of 5% over the 3-year WMP cycle (i.e., 60-year return interval)

Scenario ID	Design Scenario	Purpose
n/a	SDG&E defined Wind Load Condition 3 – Extreme	Historical max wind gusts at each weather station during Santa Ana Conditions. The ignition rate adjustment is based on recorded past wind speeds.
n/a	Wind Load Condition 4 – Credible Worst Case	Wind gusts with a probability of exceedance of 1% over the 3-year WMP cycle (i.e., 300-year return interval)
n/a	Weather Condition 1 – Anticipated Conditions WRRM worst fire weather days	The statistical weather analysis limited to fire seasons expected to be the most relevant to the next 3 years of the WMP cycle
n/a	Weather Condition 2 – Long-Term Conditions SDG&E’s expected wildfire rate ignition adjustment	The statistical weather analysis representative of fire seasons covering the full 30-year history. Adjustment: 1 wildfire per 15-year interval
n/a	Vegetation Condition 1 – Existing Fuel Load (based on potential fire season conditions) Tree Strike Risk Vegetation Risk	Existing fuel load within the service territory Ignition rate adjustment based on maximum credible tree strike risk PoI adjustment factor based on vegetation PoF
n/a	Vegetation Condition 2 – Short-Term Forecasted Fuel Load	Changes in expected fuel load over the 3-year Base WMP cycle (2023-2025)
n/a	Vegetation Condition 3 – Long-Term Extreme Fuel Load	Long-term potential changes in fuels throughout the service territory
n/a	Circuit Health Index	Ignition rate adjustment based on CRI
n/a	Average Conductor Age	Ignition rate adjustment based on the average age of spans in a segment
n/a	Average Structure Age	Ignition rate adjustment based on the average age of poles in a segment
n/a	Percent Hardening	Ignition rate adjustment based on percent hardening
n/a	Conductor Risk	PoI adjustment factor based on conductor PoF
n/a	Balloon Risk	PoI adjustment factor based on mylar balloon contact PoF
n/a	Vehicle Contact Risk	PoI adjustment factor based on vehicle contact with electric assets
n/a	Buildings Destroyed 100 Percentile	Wildfire consequence variable based on the maximum number of buildings destroyed based on WRRM simulations per segment
n/a	Acres affected 100 Percentile	Wildfire consequence variable based on the maximum number of acres affected based on WRRM simulations per segment

In 2022, SDG&E began developing two applications to visualize the output of the WiNGS-Ops and WiNGS-Planning models.

The WiNGS-Planning Visualization application will be used for design scenarios. It will contain an interactive map view that provides circuit and segment risk insight as well as a portfolio scoping tool that compares modeled mitigation portfolios. In addition to common design scenarios, SDG&E is developing a platform for subject matter expert-defined scenarios. Within the WiNGS-Planning model

architecture, there are a myriad of constants that can be adjusted for different parameters, allowing for various design adjustments. Settings are currently available in Python scripts and will soon be exposed to multiple users of the WiNGS-Planning Visualization application. SDG&E Table 6-7 details the most common variables that may be fine tuned in Python via the WiNGS-Planning Visualization application that is currently in development for 2023 deployment.

See Section 6.5 Enterprise System for Risk Assessment for details regarding the WiNGS-Planning and WiNGS-Ops Models Visualization platforms.

SDG&E Table 6-7: Summary of Design Parameters in WiNGS-Planning Visualization Application

Setting Type	Parameter
Basic settings	Traditional hardening unit cost
Basic settings	Covered conductor unit cost
Basic settings	Conversion of TH to CC unit cost
Basic settings	Undergrounding unit cost
Basic settings	Applied RSE threshold
Basic settings	Wildfire Risk Reduction Target Percentage
Basic settings	Snapshot date of the input data. Defaults to the latest available date.
Advanced settings	Target Undergrounding miles per year
Advanced settings	Target Covered Conductor miles per year
Advanced settings	Assumed Santa Ana Wind days per year
Advanced settings	Estimated annual high fire days from historical records from the seasonal window ranging Sept. 1 through Dec. 31 plus any winter/spring RFW days.
Advanced settings	Assumed duration hours of PSPS event during a RFW day.
Advanced settings	Safety multiplier for PSPS
Advanced settings	Reliability multiplier for PSPS
Advanced settings	Financial multiplier for PSPS
Advanced settings	Reliability SAIFI weight
Advanced settings	Reliability SAIDI weight
Advanced settings	Reliability RAMP weight
Advanced settings	Financial weight
Advanced settings	Safety weight
Advanced settings	Safety normalization factor
Advanced settings	Reliability normalization factor
Advanced settings	Benefit discount
Advanced settings	Traditional hardening lifetime
Advanced settings	Covered conductor lifetime
Advanced settings	Conversion of TH to CC lifetime
Advanced settings	Undergrounding lifetime

Setting Type	Parameter
Advanced settings	Undergrounding contingency non-roadway multiplier
Advanced settings	Estimated hours taken to restore a pole after a fire
Advanced settings	SAIDI normalizing factor
Advanced settings	SAIFI normalizing factor
Advanced settings	MAVF Sub-Attributes of Health & Safety multipliers

Figure 6-9 shows the interface in the development version of the WiNGS-Planning Visualization application for altering design scenarios. Values presented in Figure 6-9 do not reflect any assumptions made in the WiNGS-Planning optimization analysis but show the ability to adjust inputs such as cost of mitigations.

Figure 6-9: WiNGS Visualization Interface

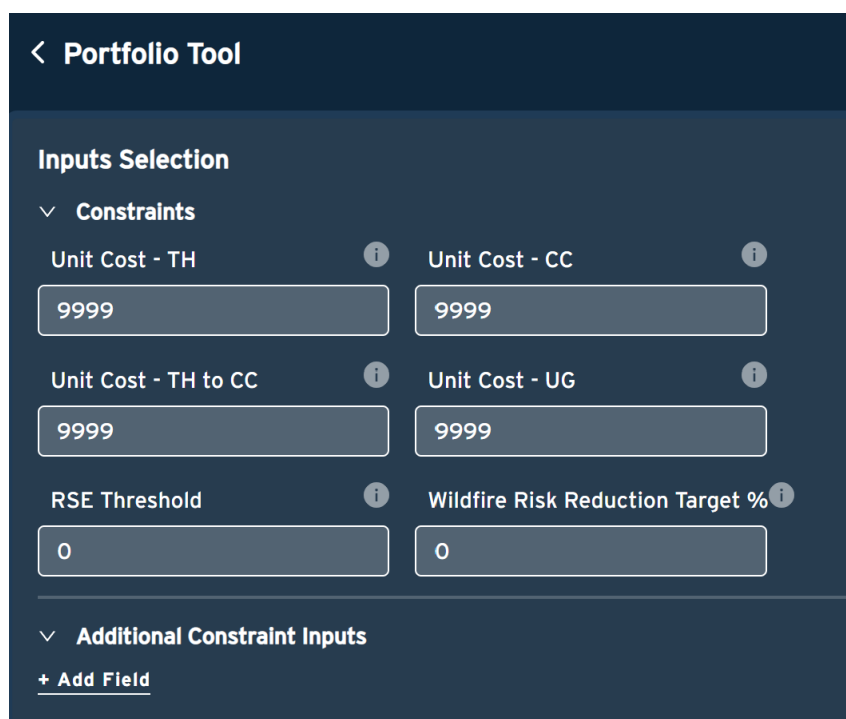

6.3.2 Extreme-Event/High Uncertainty Scenarios

SDG&E does not currently analyze extreme events or highly uncertain scenarios. Rather, the WiNGS-Planning model was designed using SDG&E-defined Wind Load Condition 3 – Extreme as detailed in Section 6.3.1 Design Basis Scenarios. Enhancements for 2022 focused on reproducibility with a conversion from Excel to Python, Azure DevOps (ADO) version control, and cloud architecture. See Section 6.5 Enterprise System for Risk Assessment for details regarding ADO. In keeping with software development best practices, these settings were kept constant so that the new development environment could be compared to the old Excel version. Once the new platform has demonstrated

stability, these settings may be altered to perform more probabilistic scenarios and improve model accuracy.

For future development of extreme scenarios, SDG&E is evaluating the feasibility of incorporating climate change scenarios RCP 4.5 and RCP 8.5. As defined by CalAdapt, “RCP 4.5 is described by the Intergovernmental Panel on Climate Change (IPCC) as a moderate scenario in which emissions peak around 2040 and then decline. RCP 8.5 is the highest baseline emissions scenario in which emissions continue to rise throughout the twenty-first century.”¹⁸ Today, one extreme event scenario is accounted for as a climate change adjustment to the WiNGS-Planning ignition rate. Based on a Monte Carlo analysis, an adjustment factor has been defined, which states that one catastrophic wildfire event will occur approximately every 15 years in the service territory. This logic is expected to mature and become more refined in the current WMP cycle as extreme event scenarios relating to wildfire expectancy in conjunction with climate change are further studied.

The WiNGS-Ops model was originally designed for extreme weather events where a likelihood of a potential PSPS event is high. Every individual model that is part of WiNGS-Ops is reviewed, updated through training and testing with new observations, and documented multiple times.

OEIS Table 6-4: Summary of Extreme-Event Scenarios

Scenario ID	Extreme Event Scenario	Purpose
n/a	Climate Change Adjustment	Wildfire frequency adjustment to ignition rate based on the effect that climate change has on wildfire frequency.

6.4 Risk Analysis Results and Presentation

The third step of the Enterprise Risk Management Framework is Risk Evaluation and Prioritization (see Figure 6-10). See Section 4.4 Risk Informed Framework for details on the Enterprise Risk Management Framework.

¹⁸ CalAdapt available at <https://cal-adapt.org/help/faqs/which-rcp-scenarios-should-i-use-in-my-analysis/>.

Figure 6-10: Risk Evaluation & Prioritization Step of the Enterprise Risk Management Framework

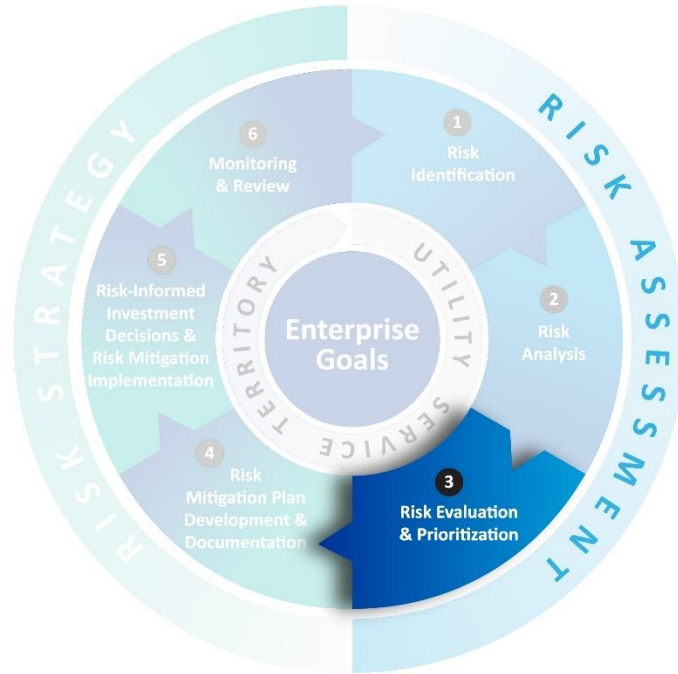

HFTD polygons are used to identify the geographic scope of mitigation planning. This includes Tiers 2 and 3 of the HFTD as defined in the requirements of D.17-01-009.¹⁹ In addition, portions of circuits that have experienced a PSPS event have been included within the risk mitigation scope. Within the service territory, the HFTD largely comprises the inland and mountainous regions west of the deserts.

6.4.1 Top Risk Areas within the HFRA

SDG&E has evaluated high fire areas outside of the HFTD. These areas include the WUI as defined by CAL FIRE²⁰ and higher-risk urban areas such as costal canyons or wildland open spaces as defined by SDG&E Operational departments in conjunction with Fire Science. Within the service territory, the WUI boundary largely exists to the west side of Tier-2 of the HFTD but overlaps the HFTD in many areas. Urban areas are focused exclusively in the coastal areas or wildland open spaces of the service territory and comprise a much smaller area than the HFTD as shown in Figure 6-11.

¹⁹ [172762082.PDF \(ca.gov\)](#)

²⁰ Source: https://frap.fire.ca.gov/media/10300/wui_19_ada.pdf

Figure 6-11: Higher-Risk Urban Areas in Relation to HFTD

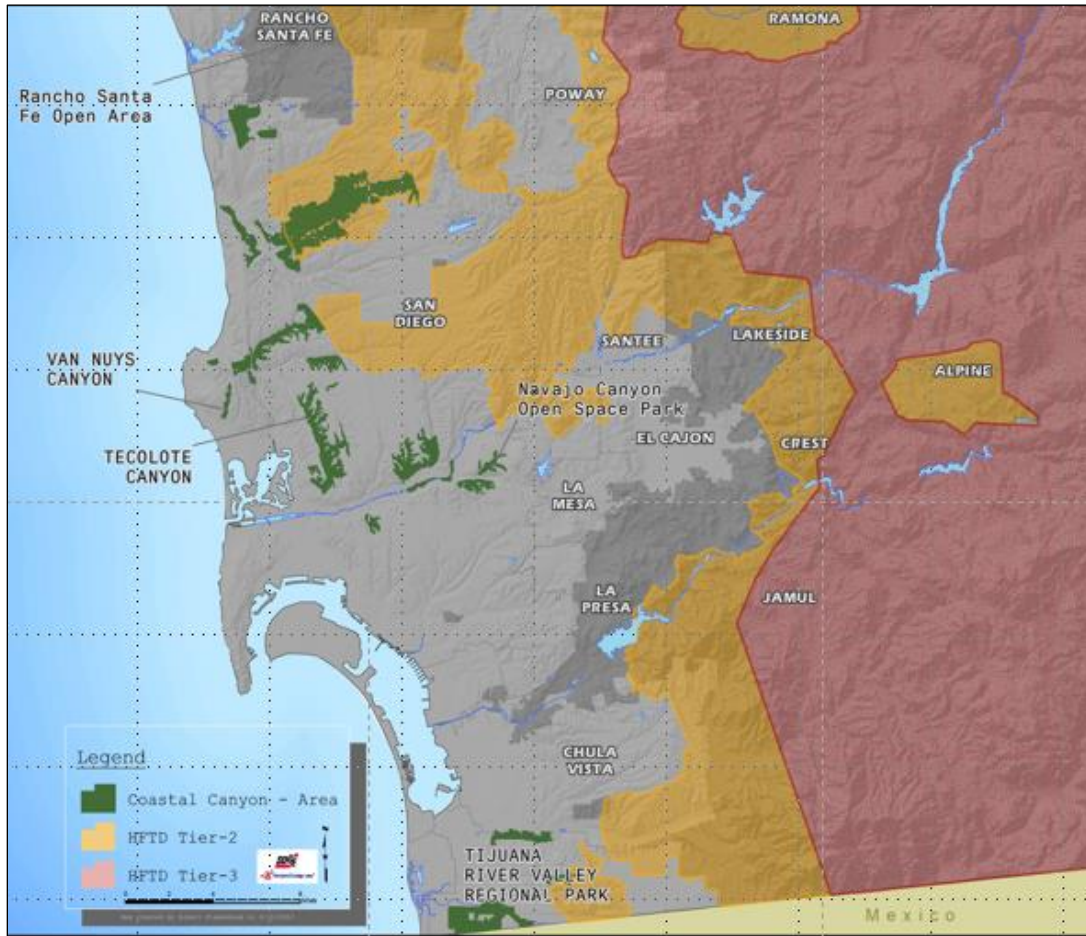

6.4.1.1 Geospatial Maps of Top-Risk Areas within the HFTA

Figure 6-12: Map of Service Territory with Circuits Categorized in terms of Wildfire Risk

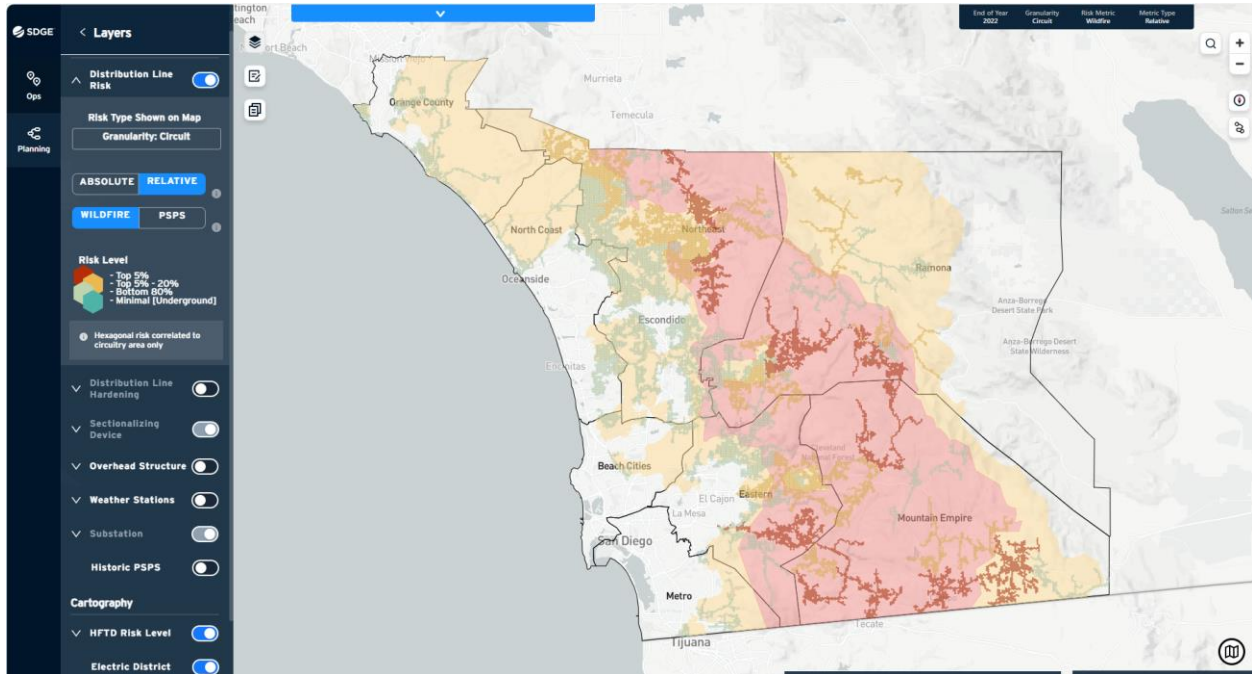

Note: Image extracted from WiNGS-Planning Visualization Platform (in development)

6.4.1.2 Proposed Updates to HFTD

There are no proposed changes to the HFTD at this time. Recent modeling initiatives evaluated the wildfire risk of coastal canyons and the WUI for mitigation. Both efforts resulted in the exclusion of each proposed addition. Polygons in the WUI layer focused on the developed areas near vegetated areas and did not include the vegetated areas themselves. In addition, these areas did not necessarily have overhead electric lines. While this layer may serve to prioritize the adjacent developed areas for fire infrastructure and suppression planning, it does not yield a usable layer for identifying areas where an energized wire down could spark a wildfire, or areas at heightened risk for ignition due to interference from vegetation.

The coastal canyon analysis evaluated risk areas identified by subject matter experts, CAL FIRE data, and historical fire history. The analysis found that wildfire risk associated with coastal canyons was lower than that associated with current HFTD segments, making scoping of grid-hardening initiatives within coastal canyon segments a lower priority. Based on these two analyses, SDG&E does not propose any additions or removals from the HFTD. SDG&E will continue to monitor risk in the service territory to analyze the need for adjustment of risk boundaries.

See response to Areas for Continued Improvement SDGE-22-08 Evaluation of Wildfire Risk Outside of the HFTD in Appendix D.

6.4.2 Top Risk-Contributing Circuits/Segments/Spans

OEIS Table 6-5 shows the top 5 percent of high-risk segments from the latest version of WiNGS-Planning. This includes segments that contribute more than 1 percent of the total overall risk. Wildfire risk rank is used when prioritizing investment decisions and PSPS risk score is highly dependent on the topology of the circuit. It is used in scoping to better identify segment mitigation dependencies. For more information, see Section 7.1.3 Risk-Informed Prioritization. To avoid double counting customer impact, the PSPS likelihood is measured as compared to the upstream overhead risk and isolating devices. Therefore, a zero PSPS risk score does not suggest there is zero risk of these customers experiencing PSPS event but rather it is used to better identify segment dependencies. Top risk contributors are overhead circuit miles, max wind gust, tree strike, percent hardening, and asset health.

OEIS Table 6-5: Summary of Top-Risk Circuits, Segments, or Spans

Risk Ranking	Segment ID	Overall Wildfire and PSPS Risk Score	Wildfire Risk Score	PSPS Risk Score
1	237-30R	67.38	67.25	0.13
2	909-805R	68.23	67.14	1.09
3	222-1401R	64.78	64.78	0.00
4	524-69R	52.88	51.39	1.49
5	222-1364R	48.94	44.18	4.76
6	448-11R	30.04	29.78	0.26
7	217-983R	28.68	28.31	0.37
8	222-1370R	32.06	27.09	4.97
9	358-682F	29.46	26.26	3.20
10	157-81R	24.62	23.89	0.73
11	1030-989R	23.77	23.54	0.23
12	79-808R	21.71	21.45	0.26
13	73-643R	21.26	21.26	0.00
14	237-1765R	21.86	20.68	1.18
15	214-1122R	22.84	20.26	2.58
16	1215-32R	19.25	19.25	0.00
17	220-298R	18.52	18.52	0.00
18	237-17R	18.18	18.18	0.00
19	448-47R	17.47	17.47	0.00
20	217-837R	16.98	16.98	0.00
21	157-232R	21.07	16.72	4.35

Risk Ranking	Segment ID	Overall Wildfire and PSPS Risk Score	Wildfire Risk Score	PSPS Risk Score
22	445-1311R	15.01	15.01	0.00
23	235-899R	14.79	14.79	0.00
24	222-2013R	14.39	14.39	0.00
25	521-14R	14.84	14.18	0.66
26	970-1341R	13.52	13.52	0.00
27	217-835R	13.45	13.45	0.00
28	216-1857	13.65	13.38	0.27

Note: This table is a snapshot in time of risk at the beginning of 2023. Numbers are rounded to the nearest hundredths place and an additional coefficient factor of x10000 is applied to the scores for readability.

OEIS Table 6-5.B: Summary of Top-Risk Circuits, Segments, or Spans – Updated

Risk Ranking	Segment ID	Overall Wildfire and PSPS Risk Score	Wildfire Risk Score	PSPS Risk Score
1	237-30R	71.38	70.12	1.25
2	909-805R	70.52	69.86	0.66
3	222-1401R	69.14	67.63	1.51
4	524-69R	54.61	53.59	1.03
5	222-1364R	48.74	45.72	3.01
6	448-11R	34.27	30.75	3.53
7	217-983R	29.98	29.50	0.48
8	222-1370R	30.84	28.08	2.76
9	358-682F	29.47	27.39	2.08
10	157-81R	25.86	24.85	1.01
11	1030-989R	25.17	24.43	0.73
12	79-808R	22.85	22.19	0.66
13	73-643R	24.06	22.10	1.96
14	237-1765R	22.58	21.65	0.93
15	214-1122R	22.37	21.26	1.11
16	1215-32R	20.94	19.93	1.01
17	237-17R	21.46	18.93	2.53
18	220-298R	20.34	18.87	1.47
19	217-837R	19.79	17.70	2.10
20	73-683R	18.44	17.47	0.96
21	157-232R	19.80	17.15	2.65
22	445-1311R	17.24	15.47	1.76

Risk Ranking	Segment ID	Overall Wildfire and PSPS Risk Score	Wildfire Risk Score	PSPS Risk Score
23	235-899R	17.58	15.27	2.32
24	222-2013R	15.99	14.91	1.08
25	521-14R	16.34	14.88	1.46
26	970-1341R	15.91	13.96	1.96
27	217-835R	14.36	13.96	0.40
28	216-1857	14.24	13.80	0.44

Differences between tables are due to updates made to the WiNGS-Planning model.

The following significant updates were made to the WiNGS-Planning model:

1. Upgrade PSPS Likelihood of Risk Event (LoRE) Risk Assessment

Updated Methodology and Models: This model enhancement update was performed in response to Key Risk Assessment Area RA-1-A (see Section 6.7). It implemented 4 kilovolt (kV) to 12 kV connectivity to account for circuit segment dependencies, leading to a more precise representation of PSPS risk upstream of 4 kV circuit segments.

Justification: Previously, 4 kV circuits were disconnected from their feeding 12 kV circuit segments. Prior to the change, the only attribute available to account for a 4 kV circuit’s upstream 12 kV circuit was the circuit ID, which affected the model by generalizing the upstream PSPS LoRE.

Shift in Risk: This enhancement affected PSPS LoRE and variables calculated using PSPS LoRE. The updated model connects parent and child feeders together and assesses their connectivity more accurately, thereby improving current PSPS LoRE risk assessment. As a result, 206 4 kV circuit segments are now connected to their 12 kV upstream circuit segment counterparts. On average, PSPS LoRE was reduced by a rate of 0.16.

Resulting Prioritization Changes: None

2. Update Weather Station Wind Gust Attribute

Updated Methodology and Models: This model enhancement update was performed in response to Key Risk Assessment Area RA-1-A (see Section 6.7). Revision of historical weather station data during fire season periods has influenced historical wind gust values for circuit segments, consequently impacting the calculation of PSPS LoRE.

Justification: As part of the annual process to refresh the weather station statistics utilized throughout the fire season, certain historical wind gust thresholds and the association between weather stations and supervisory control and data acquisition (SCADA) Sectionalizing Devices were revised. These modifications impacted the computation of PSPS LoRE within the WiNGS-Planning model.

Shift in Risk: The maximum wind gust variable was reduced by an average of 1.7 miles per hour, which had downstream effects on PSPS LoRE.

Resulting Prioritization Changes: None

3. Enable Dynamic Upstream Tracing to Calculate Maximum Upstream PSPS Probability

Updated Methodology and Models: This model enhancement update was performed in response to Key Risk Assessment Area RA-1-B (see Section 6.7). The update implemented dynamic upstream tracing to enhance the accuracy of upstream PSPS probability estimates for each sectionalizing device.

Justification: PSPS probability was a derived value that required a manual assessment from Meteorology. Network tracing now dynamically assesses the risk upstream of each circuit segment and dynamically calculates the PSPS LoRE for each segment.

Shift in Risk: This enhancement affected PSPS LoRE and variables calculated using PSPS LoRE. By design, PSPS LoRE is now dynamically shifted upstream or downstream when a segment is mitigated.

Resulting Prioritization Changes: None

Qualitative updates for the WiNGS-Planning model are included in SDG&E Table 6-8.

SDG&E Table 6-8: WiNGS-Planning Qualitative Risk Modeling Updates

	Key Area	Update	Benefit of Update	Source for Update	Status*
1	Model enhancements	Automate hardening-informed PSPS wind speed threshold assessment	Automate the calculation process for PSPS wind speed thresholds, aligning with specific hardening types. This automation introduces efficiency, accuracy, and adaptability to different hardening strategies, streamlining the overall process and contributing to more effective PSPS risk quantification.	<ul style="list-style-type: none"> Key Risk Assessment Area RA-1-A** 	Complete
2	Model Enhancements	Update starting constants	Update starting constants with the latest available information based on subject matter expertise and the latest study results. Constants updated include PSPS calibration factor, wildfire frequency rate, wind speed thresholds for hardening types, fire season starting month, and underground to Remove From Service (RFS) ratio	<ul style="list-style-type: none"> Key Risk Assessment Area RA-1-A** Third-party review recommendations 	Complete
3	Model Enhancements	Incorporate Social Vulnerability Index (SVI)	Conduct research and development to integrate social vulnerability data into both the wildfire CoRE and PSPS CoRE risk assessments. This initiative seeks to enrich the risk assessment process by incorporating insights from social vulnerability metrics, seeking to promote equity in evaluation of potential impacts on communities during both wildfire and PSPS de-energizations.	<ul style="list-style-type: none"> Key Risk Assessment Area RA-1-A** Third-party review recommendations 2023-2025 WMP Technical Guidelines Maturity Model: Risk Assessment and Mitigation Strategy 	In progress

	Key Area	Update	Benefit of Update	Source for Update	Status*
4	Model Enhancements	Update tree strike model	Update tree strike model to encapsulate entire service territory. Add additional filters to remove trees which are below typical pole height.	<ul style="list-style-type: none"> Key Risk Assessment Area RA-1-B** Third-party review recommendations 	In progress
5	Model Enhancements	Incorporate egress when evaluating wildfire risk	Develop an egress impact factor to integrate into the Wildfire CoRE calculation. This enhancement will assess added wildfire consequence risk relating to customer egress impacts.	<ul style="list-style-type: none"> Key Risk Assessment Area RA-1-A** Third-party review recommendations Maturity Model: Risk Assessment and Mitigation Strategy 	In progress
6	Model Enhancements	Initiate scenario analysis for different wind conditions	Research and development on the wind speed percentiles and how they affect downstream mitigation recommendations.	<ul style="list-style-type: none"> Key Risk Assessment Area RA-2-A** 	In progress
7	Model Enhancements	Evaluate probability distributions instead of maximum values for consequence	Assess probability distributions for consequence of wildfire at the span and segment level. The span level considers the probability distributions created by Technosylva simulations. Each span-level simulation value within a segment forms the segment-level distribution. Both levels resulted in potentially using the so-called "tail-value-at-risk" (TVaR) for its benefit in summarizing and capturing distributional properties.	<ul style="list-style-type: none"> ACI SDGE-23-02 	In progress
8	Model Enhancements	Retrain models and explore new methodologies	Expand existing collaboration with Moody's RMS to comprehend and assess their stochastic approach to fire consequence modeling. Integrating this methodology and inputs in the wildfire consequence model may lead to insights into long-duration fires that incorporate fire suppression activities.	<ul style="list-style-type: none"> Key Risk Assessment Area RA-1-B and RA-3-B** Maturity Model: Risk Assessment and Mitigation Strategy 	In progress
9	Model Enhancements	Estimate of PSPS de-energization duration	Estimate PSPS de-energization duration and customer minutes impacted for each segment. Estimates include all customers and the medical baseline, Access and Functional Needs (AFN), and socially vulnerable subsets.	<ul style="list-style-type: none"> Maturity Model: Risk Assessment and Mitigation Strategy 	In progress
10	Data Governance and Data Architecture	Refactor WINGS-Planning aggregation functions	Convert Python functions from complex SQL statements into more efficient Python functions for improved readability, maintainability, and performance.	<ul style="list-style-type: none"> Key Risk Assessment Area RA-1-B** Third-party review recommendations 	Complete

	Key Area	Update	Benefit of Update	Source for Update	Status*
11	Data Governance and Data Architecture	Repoint flat files to Enterprise data sources	Shift data sourcing from flat files to Enterprise data sources whenever feasible. This shift will promote enhanced consistency through adherence to Enterprise quality assurance protocols, promoting reliability and standardized data management within the model.	<ul style="list-style-type: none"> • Key Risk Assessment Area RA-1-B** • Third-party review recommendations 	Complete
12	Data Governance and Data Architecture	Implement parallelization of model run tasks	Refactor code to improve computational speed of the model by allowing parallel task runs.	<ul style="list-style-type: none"> • Key Risk Assessment Area RA-1-B** 	Complete
13	Data Governance and Data Architecture	Standardize model approach	Develop templates for standardizing the creation, validation, and deployment of models in cloud environments, aiming to streamline and expedite the modeling process. This initiative enhances efficiency, promotes consistency, and facilitates easier management of models, ultimately contributing to more effective decision-making and resource optimization within SDG&E's environments.	<ul style="list-style-type: none"> • Third-party review recommendations 	In progress
14	Data Governance and Data Architecture	Develop model documentation	Document the model including its technical and mathematical foundation, limitations, data libraries, and substantiation. This thorough documentation serves to provide clarity, transparency, and a reliable reference for understanding the model's structure, constraints, data sources, and the rationale behind its design and implementation.	<ul style="list-style-type: none"> • Data Governance Framework Guide 	Complete
15	Data Governance and Data Architecture	Create/update technical model code with documentation	Populate doc strings with descriptive metadata for all python functions in the aggregations.py and ingest.py scripts to clarify the purpose and function of each code block.	<ul style="list-style-type: none"> • Third-party review recommendations 	Complete
16	Data Governance and Data Architecture	Integrate span level risk scores	Upgrade model capabilities to conduct all calculations at span-level granularity. This improvement aims to provide a more detailed and precise analysis, allowing for a more accurate understanding of factors impacting the system at the span level.	<ul style="list-style-type: none"> • Key Risk Assessment Area RA-1-B** 	In progress
17	Data Governance and Data Architecture	Expand to full-territory model	Upgrade model to generate risk scores for the entire service territory, including outside of the HFTD.	<ul style="list-style-type: none"> • Key Risk Assessment Area RA-1-A** 	In progress

	Key Area	Update	Benefit of Update	Source for Update	Status*
18	Data Governance and Data Architecture	Refactor WiNGS-Planning risk score functions	Develop code refactoring process to improve computational speed and functional dependencies of model risk calculation tasks.	<ul style="list-style-type: none"> Key Risk Assessment Area RA-1-B** Third-party review recommendations 	In progress
19	Model Validation and User Acceptance	Formalize model validation and verification	Enhance the Pytest report to capture model deviations. Additionally, create validation notebooks to gauge the perceived accuracy of model inputs and outputs.	<ul style="list-style-type: none"> Key Risk Assessment Area RA-4-B** Third-party review recommendations 	Complete
20	Visualization Platform	Continue improving and enhancing visualization platform	Continue to develop the WiNGS-Planning Visualization Platform.	<ul style="list-style-type: none"> Key Risk Assessment Area RA-5-A** 	In progress

**Updates with a "Complete" status were performed on Version 3.0 of the model and updates with a "In progress" status are being performed on Version 4.0.*

***See Section 6.7*

6.4.3 Other Key Metrics

6.4.3.1 FPI (WMP.450)

The FPI (WMP.450) was developed by SDG&E to communicate the wildfire potential on any given day to promote safe and reliable operations. This 7-day forecast product, which is produced daily, classifies the fire potential based on weather and fuel conditions and historical fire occurrences. High FPI ratings, defined as Elevated or Extreme FPI ratings, are associated with an increase in the probability of large wildfires. High FPI-OCM is the average of annual total overhead circuit miles (OCM) with Elevated or Extreme ratings.

Refer to Appendix B for further information on the FPI.

6.4.3.2 Red Flag Warning (WMP.082)

The National Weather Service (NWS) issues RFW by zones. These zones are overlaid with the service territory to generate circuit miles within each zone. The RFW active period issued by NWS is converted into the number of days by taking the date difference. This date count is multiplied by the number of circuit miles in each zone to derive the total circuit miles affected each RFW event. The annual average is then divided by the total overhead circuit miles in each tier to get the RFW-OCM per OCM per tier.

6.4.3.3 High Wind Warnings

The NWS issues high wind warnings (HWW) by zones. These zones are overlaid with the service territory to generate circuit miles within each zone. The HWW active period issued by NWS is converted into number of days by taking the date difference. This date count is multiplied by circuit miles in each zone to derive the total circuit miles affected each RFW (WMP.082) event. The annual average is then divided by the total overhead circuit miles in each Tier to get the RFW-OCM per Tier. HWW includes wet wind events and dry wind events; SDG&E includes only Santa Ana wind events for this HWW metric.

OEIS Table 6-6 shows data for these metrics in 2022. This data shows:

- 80 percent of overhead circuit miles that experienced elevated or extreme FPI ratings were in the HFTD
- 81 percent of overhead circuit miles that experienced RFW were in HFTD
- 85 percent of overhead circuit miles that experienced HWW were in HFTD

OEIS Table 6-6: Summary of Key Metrics by Statistical Frequency

Metric	Non-HFTD	HFTD Tier 2	HFTD Tier 3	Total	Total HFTD Only	% of HFTD
High FPI-OCM/OCM (Elevated)	70.68	119.60	141.80	332.08	261.40	79%
High FPI-OCM/OCM (Extreme)	2.45	5.11	7.14	14.70	12.25	83%
High-FPI-OCM/OCM Sub-total	73.13	124.71	148.94	346.78	273.65	80%
RFW-OCM/OCM	2.61	5.07	5.98	13.66	11.05	81%
HWW-OCM/OCM	1.19	2.98	3.60	7.77	6.58	85%

6.5 Enterprise System for Risk Assessment (WMP.1332)

The database utilized for storage of risk assessment data is AWS.

Data is stored with Amazon’s S3 service and queried using Amazon’s Athena service. Documentation of the database architecture and the model metadata is done using Athena and S3 data. The cloud environment is managed by internal IT including the Cloud Architecture Review Board (CARB), and WMP Advanced Analytics team.

AWS is integrated with enterprise on-premise source databases (Oracle and SAP HANA), source systems, and other flat files, which are updated on a regular basis depending on the use case.

Changes to the enterprise system are done by SDG&E IT using the Agile Change management processes. Change orders are submitted and requirements documented, configured in a Development environment, tested, and then moved to the Production environment. Changes at the source system, source database, or flat file level are handled through the data owner’s change management process.

Changes to the Enterprise Risk Assessment system since the last WMP include:

- Centralized, cloud-based database (AWS) from prior disparate databases and flat files
- Utilized Athena and s3 for a central metadata repository
- Implemented Python 3.0 analytics software, replacing Excel
- Project management and version control leverages ADO
- Traceability of data from source data to final models is nearly complete with the remaining deficiencies dependent upon consultant-managed data and subject matter expert-supplied data.

Updates to the Enterprise Risk Assessment System will include:

- 2023
 - Additional data sources added to the enterprise system with a focus on geographic information system (GIS), Customer Information, and PSPS data
 - Improvements to the governance process for both data owners and machine learning model data
- 2024
 - Additional data sources to be added depending on new requirements for data science and other business needs
 - Update connections to source systems where possible, removing dependencies on other on-premise database systems
- 2025
 - Add additional data from SDG&E partners to inform future machine learning use cases
 - Improve granularity of data ownership and governance
 - Continue migration away from other on-premise database systems

The Enterprise System for Risk Assessment makes use of ADO for Python code version control as well as project management. ADO incorporates documented enhancements attached to repository branches for logical and traceable model updates. Used in conjunction with model taxonomy (see Section 6.6.2.2 Reanalysis), model changes are thoroughly accounted for.

In conjunction with the Enterprise risk environment, a platform for the visualization of analytics results is currently in development. The WiNGS-Planning and WiNGS-Ops Visualization platforms will be used to visually display and to disseminate the output of the WiNGS models to various user groups from top level executives to scoping analysts to EOC decision makers, and other stakeholders. The application consists of dashboards for WiNGS-Ops and WiNGS-Planning with dynamic web maps linked to informative widgets designed for use cases including PSPS decision making as well as investment planning. Within the Visualization applications, users will be able to view circuit and segment-level risk in the context of wildfire and PSPS events. Users will be able to run the WiNGS-Planning model with an expanded number of design-level scenarios to help guide investment decisions. The application is expected to go live in 2023. The WiNGS Ops application will be a real-time, interactive application that utilizes comprehensive and dynamic risk modeling at the segment level based on forecasted fire conditions. The primary function of WiNGS-Ops is to provide the ability to weigh the quantified risks of a binary choice of actions: de-energization or not. This machine plus human experience strengthens the PSPS decision-making confidence by enabling a more targeted approach to asset-level reporting and real time weather updates.

6.6 Quality Assessment and Control

6.6.1 Independent Review

The independent review process, as depicted in Figure 6-13, can be triggered routinely on an annual basis and/or following a major model change(s) per model versioning standards detailed in Section 6.6.2.3 Version Control. Initial activities include identifying the model and model components requiring the review as well as engaging an independent contractor with a defined scope. The contractor then

conducts an in-depth discovery phase consisting of stakeholder interviews, data gathering, and model evaluation. Findings and recommendations are provided by the contractor when their analysis is complete. An internal review then takes place to assess and prioritize findings and recommendations for enhancements or model improvements. An implementation timeline and plan are then developed for the prioritized findings and recommendations. The risk model(s) are continuously monitored and reviewed internally throughout the year, while evaluating major model changes and identifying new model improvement opportunities. Subsequent independent reviews will build upon the framework and evaluation of prior independent reviews to ensure an efficient review process with timely deliverables.

Figure 6-13: Independent Review Process

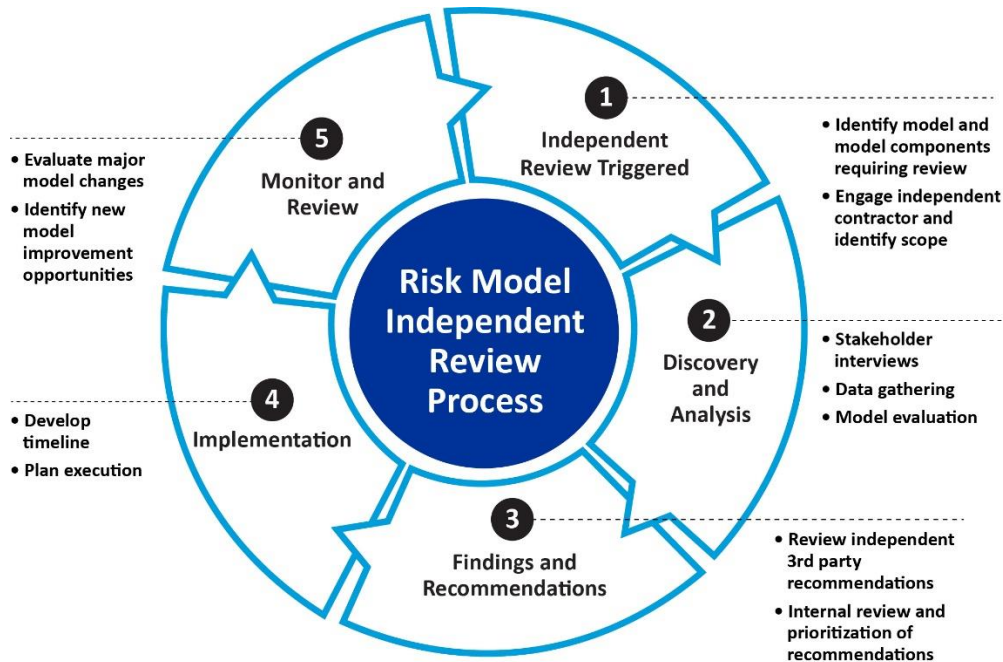

The WiNGS-Planning model has undergone a thorough review spanning several months and multiple iterations concerning logic as well as architecture. An independent third-party review of data and inputs took place in August 2022, which resulted in several data and model governance findings. Recommendations included:

1. Migrate Excel + Frontline to Python
2. Control the source with Git
3. Version model releases
4. Apply coding standards
5. Automate manual steps in code
6. Decompose functionality into discrete, testable components
7. Create unit and end-to-end testing
8. Convert optimization to Python

Many of these recommendations have been implemented by the Python and AWS migration or are in progress.

In November 2022, another third-party review took place, which evaluated model code, infrastructure, and data management processes according to best practices. Industry-recognized standards, such as the AWS Well Architected Approach and the 12-factor application development pattern, were referenced in this review process to assemble industry recognized best practices.

In 2022 WiNGS-Ops underwent an internal review to determine areas of improvement. The model was updated to align with software development best practices by integrating source control, code optimization, and a multi-stage production environment. In 2023 WiNGS-Planning and WiNGS-Ops underwent formal independent third-party reviews of their software implementation.

These reviews highlight how WiNGS-Planning and WiNGS-Ops currently align to best practices across key competency areas. SDG&E Table 6-9 shows findings and recommendations focused on testing and automation in future enhancements, which are in the process of being assessed, prioritized, and road mapped.

SDG&E Table 6-9: WiNGS-Planning and WiNGS-Ops Review Findings and Recommendations

Review Category	Current Highlights	Future Recommendations
Data Management and Governance	Input files are automatically versioned and promoted across environments using a pipeline	Structure results in a database (e.g., Glue DB or RDS) for easier access and use parquet format Describe model output results with data cataloging tool Collibra Leverage S3 to align to enterprise data retention policies
Development Practices	Source control with Git is used to enforce versioning and audit trail Functional programming practices are observed for readability and performance READ.ME and other documentation are generated and updated	Organize updates to codebase in release notes and development notes to document changes over time
Enterprise Standards and Security	Enterprise templates are used for CI/CD pipelines and Infrastructure as Code (IaC) to reduce development time and streamline updates The Company's Cloud Architecture Review Board (CARB) approved the WiNGS-Ops AWS architecture to ensure use of white-listed services and alignment with IT standards Only enterprise approved third-party packages are used in code	Leverage DevSecOps pipeline templates for testing, where applicable Use a scanning tool on third-party packages to detect security risks, e.g., malicious code
Observation and Monitoring	Console logging and logging to AWS CloudWatch are enabled for easy debugging	Visualize logging with a dashboard for easy and more transparent identification of issues Leverage Prefect 2.0 functionality for enhanced monitoring, logging, and native visualization
Automation	Task orchestrator, Prefect.io. is used to establish how model calculations and dataflow are executed	Establish ground truth for testing and use as basis for unit, integration, and environment testing to: <ul style="list-style-type: none"> • Ensure input data is being transformed and aggregated as expected

Review Category	Current Highlights	Future Recommendations
		<ul style="list-style-type: none"> • Ensure calculations are creating intermittent outputs as expected • Detect variance in results (against ground truth) • Test changes to code to compare results against ground truth (integration testing can be added to CI/CD pipeline) • Integrate testing in PR process so issues are caught earlier, before merge

In addition to independent reviews, SDG&E collaborates with technical advisors, explores internal review boards, is involved with the International Wildfire Risk Modeling Consortium (IWRMC), collaborates with other IOUs and external vendors, and seeks best practices when developing risk models. Refer to Section 6.7.6 RA-4-A Improve Procedure for Independent Reviews of Data and Models for more details around planned improvements in this area.

6.6.2 Model Controls, Design, and Review

6.6.2.1 Modularization

The WiNGS-Planning model contains four main components of risk, Wildfire LoRE, Wildfire CoRE, PSPS LoRE, and PSPS CoRE. Each of these components can be viewed as separate models with independent variables integrating into each model. Wildfire LoRE and CoRE are combined into an overall Wildfire risk score. Likewise, PSPS LoRE and CoRE are combined into an overall PSPS risk score. Wildfire and PSPS risk scores are combined to form an overall Wildfire and PSPS risk score. See Appendix B for details on model components, families, computation, and propagation.

The WiNGS-Ops model has similar components to the WiNGS-Planning model; however, WiNGS-Ops employs a series of machine learning models that propagate into higher level models. See Appendix B for details on model components, families, computation and propagation.

6.6.2.2 Reanalysis

SDG&E in its cloud migration initiative has created the capability to provide the results of its risk models based on the operational version of the software used on a specific historic data (post 2022). All input variables, Python libraries, and assumptions feeding the WiNGS-Planning and WiNGS-Ops models are timestamped and securely archived, enabling reproducibility of results.

To respond to evolving regulatory requirements, SDG&E works to update the WINGS-Planning model to incorporate enhanced capabilities and additional data. Currently in development is a WiNGS-Planning model with architectural improvements and new Python version control taxonomy that can run different versions of a model using system data dating back to September 2022. September 2022 was the inception of analytics data archiving to store historical system conditions.

WiNGS-Planning model versions 1.0 and 2.0, used for scoping during the current WMP cycle, are static models and represent snapshots in time based upon the distribution system’s state. They are not

designed to be re-run for prior year states and to do so would require an overhaul of their designed functionality due to model limitations of the Excel environment and changing data schema.

6.6.2.3 Version Control

The WiNGS-Planning model versions used for this WMP cycle were designed with limitations that will be resolved with new model developments. Scoping efforts for projects spanning the years 2022 to 2024 use WiNGS-Planning 1.0, while the WiNGS-Planning 2.0 model is currently used for scoping work in 2025 and beyond. Each of these models use the Excel framework and therefore have limitations for reanalysis. WiNGS-Planning 1.0 and 2.0 must therefore be viewed as models that were developed in distinct time periods using similar albeit different datasets due to changes to system configuration and data schema. The WiNGS-Planning model currently in development will have taxonomy for version control. The components of version control standard are detailed in SDG&E Table 6-10.

SDG&E Table 6-10: Version Control Hierarchy for WiNGS-Planning 3.0 (in development)

Release Type	Description
Major	<ul style="list-style-type: none"> • Addition or removal of an analytics dataset item • Addition or removal of a post-analytics dataset calculation • Change of base model decision algorithm
Minor	<ul style="list-style-type: none"> • Addition/change/update/removal of inputs or calculations that are associated to the analytics dataset • Change/update to the post-analytics dataset calculations • Update/tuning of existing model decision algorithm • When input stays the same between two different Minor versions, the data outputs will be different
Patch	<ul style="list-style-type: none"> • Modifications that do not affect data outputs values • Refactoring/Renaming <ul style="list-style-type: none"> ○ Repointing of source input data locations ○ Change of column/field names in data frames ○ Any addition/removal/change/update to the reporting metrics ○ If inputs are the same, the data outputs will be the same
Post	<ul style="list-style-type: none"> • Modifications that do not change the model source code • Repo updates to the readme • Repo updates that do not affect the src folder • To the model, it is as if these changes did not even occur • Denoted with “.post#” at the end of the version with “#” being the number of versions since the last MAJOR.MINOR.PATCH version.

6.7 Risk Assessment Improvement Plan

SDG&E continuously evaluates the maturity of its risk modeling approach and proactively seeks opportunities to enhance its Wildfire and PSPS risk assessments. Considering the updated requirements

for wildfire risk modeling issued in the 2023-2025 WMP Technical Guidelines,²¹ SDG&E conducted a gap assessment of its risk models and identified opportunities for improvement in the 2023 to 2025 WMP cycle and beyond. These improvement actions were evaluated and prioritized for implementation based on an assessment of the following:

- Ease of implementation: data availability, resource availability, and current capabilities
- Value: a qualitative and relative assessment of the value added by implementing the improvement in terms of further advancing risk mitigation efforts or improving efficiencies

The gap assessment resulted in the identification of timeframes for implementing each action as outlined in OEIS Table 6-7. Actions are assigned to one of the following areas of improvements:

- RA-1: Risk assessment methodology
- RA-2: Design basis
- RA-3: Risk presentation
- RA-4: Risk event tracking
- RA-5: Risk-informed decision-making

²¹ OEIS, 2023-2025 Wildfire Mitigation Plan Technical Guidelines (December 6, 2022) (2023-2025 WMP Technical Guidelines), available at <https://efiling.energysafety.ca.gov/eFiling/Getfile.aspx?fileid=53286&shareable=true>.

OEIS Table 6-7: Utility Risk Assessment Improvement Plan

Key Risk Assessment Area	Proposed Improvement	Type of Improvement	Expected Value Add	Timeframe and Key Milestones
RA-1-A	Evaluate additional factors in the assessment of wildfire and PSPS risk	Technical	Improved likelihood of failure and ignition models, as well as event consequence models	2023-2025: Integrate factors where data is readily available 2023-2028: Gather data for additional factors 2026-2031: Integrate additional factors
RA-1-B	Enhance existing model design and architecture	Technical	Streamlined risk components assessment, validation, and expand scenario analysis capabilities	2023: Continue building and expanding initial design and architecture 2023-2025: Execute existing plan and identify opportunities to improve
RA-2-A	Evaluate design and extreme-event scenarios	Technical	Improved assessment of uncertainty and overall risk calculations	2023: Initiate scenario analysis for different wind conditions 2024-2025: Enhance analysis and apply lessons learned to incorporate weather conditions into scenario analysis 2026-2028: Enhance analysis and apply lessons learned to improve fuel conditions assessment and incorporate extreme-events
RA-3-A	Establish a more formalized process to continuously evaluate HFTD boundaries	Programmatic	Improved identification of high fire risk areas (HFRAs)	2026-2028: Develop yearly process to continuously evaluate HFTD boundaries
RA-3-B	Enhance model documentation	Programmatic	Improved transparency, reproducibility, and auditability	2023: Expand existing model documentation based on latest guidelines 2024: Make model documentation available as requested by the OEIS
RA-4-A	Establish a more formalized procedure for conducting independent reviews of data and models	Programmatic	Improved risk modeling capabilities	2023: Develop a more comprehensive procedure and initiate third-party reviews for all models 2023-2024: Document results, develop an action tracking system, and address potential findings.

Key Risk Assessment Area	Proposed Improvement	Type of Improvement	Expected Value Add	Timeframe and Key Milestones
RA-4-B	Enhance model validation process	Programmatic	Identify areas of improvement	2023: Formalize current model validation process 2024: Expand and improve annual model validation process 2025-2028: Incorporate additional factors for model validation
RA-5-A	Deploy and enhance WiNGS-Ops and WiNGS-Planning visualization platforms	Technical and Programmatic	Provide easy and quick access to reliable data to inform decision making	2023-2028: Refine and expand

6.7.1 RA-1-A Evaluate Additional Wildfire and PSPS Risk Assessment Factors

6.7.1.1 Problem Statement

The new risk modeling requirements issued in the 2023-2025 WMP Technical Guidelines introduce additional factors and data points into risk models that were either not previously incorporated or could benefit from further refinements. These factors span multiple areas of risk modeling such as wildfire likelihood, wildfire consequence, PSPS likelihood, and PSPS consequence. These factors were not fully integrated in the models due to limited data availability, relative importance for internal subject matter experts, and the primary need to focus risk modeling efforts on key model elements to optimize data-driven investment and operational decisions.

SDG&E regularly works with industry experts, academia, government agencies, and other stakeholders to better understand and quantify the impact of catastrophic wildfires, through analyses on estimated wildfire spread, acres burned, and buildings impacted or destroyed. The current PoF and PoI models in the WiNGS-Planning model do not yet incorporate all the factors outlined in the 2023-2025 Technical Guidelines and/or capture all the asset types listed. Similarly, the current wildfire consequence assessment is derived from the Technosylva WRRM model and does not currently capture certain factors such as social vulnerability, physical vulnerability, or coping capacities of customers. Furthermore, the current version of the model conducts 8-hour fire spread simulations which could impact the accuracy of the consequence modeling outputs.

The current PSPS likelihood assessment is relatively new and is expected to be revamped in 2023. Future enhancements already identified will include how weather conditions and ignition risk affects the annual likelihood of implementing PSPS. Although in the WiNGS-Planning Model the PSPS consequence assessment considers type of customers, it can be improved with further development of social vulnerability or availability of redundant back-up power systems that could reduce the impacts of a PSPS.

6.7.1.2 Planned Improvement

SDG&E plans to explore and evaluate the addition of missing model factors based on the assessment of data and resource availability as well as incremental value added. In the 2023 to 2025 WMP cycle, factors will be integrated where data is available and resources will be engaged to incorporate those factors into the models. These include, but are not limited to, creating more granular statistical or machine learning models to estimate the likelihood of equipment-related ignitions by equipment type, vegetation species, and foreign object contacts. Additional factors to be evaluated include PSPS likelihood and wildfire and PSPS consequence. Factors such as social vulnerability and the potential impact of long-term-duration fires will be evaluated to see if PSPS likelihood, wildfire consequence, and PSPS consequence can be improved. SDG&E also plans to identify opportunities for additional factors and initiate data gathering in the 2023 to work towards integrating those factors in future WMP cycles. This will be a continuous process of evaluating what can be integrated meaningfully and what may need to be considered in future years to enhance quality and quantity of data over time. Where possible, proxies may be leveraged, and assumptions will be tracked and documented to fulfill the requirements.

6.7.1.3 Anticipated Benefit

Incorporating these additional factors is expected to improve the overall calculation of likelihood and consequences in the risk assessment. For instance, incorporating specific equipment types and vegetation species in the assessment of PoF could support further targeting of assets or vegetation at-risk in the service territory. Additionally, incorporating social vulnerability and coping capacities in the consequence assessment could further enhance risk mitigation efforts for communities that may potentially be more at-risk than others. Ideally, these improvements to the risk models would result in further risk reductions and/or efficiencies in how the work is executed; however, this can only be determined upon testing and continuous evaluation of the value of these improvements over time.

6.7.1.4 Region Prioritization

SDG&E is currently focused on creating, validating, and enhancing its models for the HFTD; however, a flexible visualization platform and architecture to expand model capabilities to the rest of the service territory is being developed. This will require automation of remaining subject matter expertise-driven inputs to the model and further output validation.

6.7.2 RA-1-B Enhance Model Design and Architecture

6.7.2.1 Problem Statement

The risk modeling requirements issued in the 2023-2025 WMP Technical Guidelines require the calculation of five intermediate risk components and nine fundamental risk components. Additionally, the guidelines introduce new requirements to further modularize the software architecture that will enable changes to be tracked over time. Examples include the requirement to have separate modules for weather analysis, fire behavior analysis, and other analyses. While SDG&E's models assess the various components required in the guidelines, the current design and architecture does not separate out those components individually in certain sections of the models.

6.7.2.2 Planned Improvement

SDG&E will continue to improve its modularity in the risk models over the next several years. Similar to the level of modularity and flexibility achieved by WINGS-Ops, SDG&E will evaluate and work towards expanding and creating new modules in WINGS-Planning in areas like weather, vegetation, customer, and equipment failure analysis. Determination of which modules to expand or add will need to take into consideration components of the assessment that will continue to be part of vendor-provided models such as fire behavior analysis which is currently performed by Technosylva's WRRM 2022 model. As SDG&E continues to improve its models and its cloud environment, further enhancements to the design and architecture will be implemented to meet the requirements. Additionally, version control practices will be aligned according to industry standards. SDG&E plans to continue enhancing its model architecture designed in 2022 and expects to be working on it iteratively for the next few years.

6.7.2.3 Anticipated Benefit

Updates to the model design and architecture are intended to streamline risk component assessment and validation. Since risk modeling approaches are complex and the current level of granularity can be improved, the modularization effort is expected to enable SDG&E to evaluate the propagation of small changes in assumptions or inputs through the models. For example, it is anticipated that a more

modularized model configuration will enable validation scripts to gauge the overall effects that changes to vegetation risk assumptions and/or data sources will have on overall risk scores. With the integration of a modularized model format, updates to modeling assumptions and data sources could be made and evaluated.

6.7.3 RA-2-A Evaluate Design and Extreme-Event Scenarios

6.7.3.1 Problem Statement

The risk modeling requirements issued in the 2023-2025 WMP Technical Guidelines introduce new risk scenarios to analyze. These scenarios include four wind load conditions, two weather conditions, and three vegetation conditions that will need to be evaluated to inform long-term mitigation initiatives and planning. Additionally, further evaluation of extreme-event scenarios is necessary and may affect the Company's decisions to implement incremental mitigations. Although SDG&E currently evaluates various fuel conditions in its risk assessment, the current approach could be revamped based on requirements outlined in the 2023-2025 WMP Technical Guidelines. For further discussion regarding how the WiNGS-Planning model as designed today, refer to Section 6.3.2 Extreme-Event/High Uncertainty Scenarios.

6.7.3.2 Planned Improvement

SDG&E will begin to evaluate additional design and extreme-event scenarios over the next several years. The weather scenario analysis for wind loading conditions will be initiated in 2023, which will explore the four wind load conditions that are defined in the 2023-2025 WMP Technical Guidelines. Subsequently, weather conditions will be incorporated into the scenario analysis between 2024 and 2025. This will align with efforts to continuously enhance the assessment of climate change impacts in risk models. Once weather conditions are incorporated, additional lessons learned will be used to enhance the current assessment of fuel conditions and incorporate into extreme-event scenarios. The effects of this analysis will be evaluated throughout the implementation process to determine if and how changes to the mitigation plan are needed.

This improvement applies only to the WiNGS-Planning model and will not be implemented in WiNGS-Ops as the WiNGS-Ops model is an operational tool used to inform PSPS decisions based on near-term severe weather forecasts and extreme fire conditions.

6.7.3.3 Anticipated Benefit

By modeling additional design and extreme-event scenarios, the assessment for uncertainty and overall risk calculations could be improved. Evaluating these scenarios could help further refine mitigation targeting and planning solutions. While the primary risk analysis will be based on the design scenarios, SDG&E's ability to assess potential for low-probability, high-consequence events could further strengthen resiliency and preparedness efforts and offer insights into mitigation prioritization.

6.7.4 RA-3-A Establish Process to Continuously Evaluate HFTD Boundaries

6.7.4.1 Problem Statement

The 2023-2025 WMP Technical Guidelines suggest that utilities should have an established process for continuously evaluating HFTD boundaries, comparing them to the Company's assessment of fire risk

across its system and proposing changes as needed to the CPUC. SDG&E currently does this as needed but does not have a formally established process to evaluate HFTD boundaries on a recurring basis.

6.7.4.2 Planned Improvement

SDG&E will begin developing a more formalized process and timeline for evaluating HFTD boundaries on a recurring basis this WMP cycle and plan to implement this process in the 2026 to 2028 WMP cycle. See Section 6.4.1 Top Risk Areas within the HFRA for information on HFTD evaluation and analysis of risk outside of HFTD.

6.7.4.3 Anticipated Benefit

Establishing a more formal process to review and update the HFTD boundary will allow continuous monitoring and improve the identification of the highest risk areas across the service territory for targeting of mitigation efforts.

6.7.5 RA-3-B Enhance Model Documentation

6.7.5.1 Problem Statement

The risk modeling requirements issued in the 2023-2025 WMP Technical Guidelines introduce new documentation requirements based on model quality assurance guidance developed by many agencies such as the Institute of Electrical and Electronics Engineers (IEEE). While SDG&E has been continuously refining its model documentation approach, the new guidelines introduce additional documentation requirements that will be addressed as part of SDG&E's roadmap for improvement. SDG&E will continue to improve transparency of the models and will make data available as requested by the Office of Energy Infrastructure Safety (OEIS or Energy Safety).

6.7.5.2 Planned Improvement

To improve maturity level and transparency, risk model documentation will be updated based on the latest guidelines in 2023. SDG&E will continue to improve in future years to bring clarity to risk modeling and statistics as requested by OEIS.

6.7.5.3 Anticipated Benefit

Enhanced documentation improves transparency both internally and externally. Internally, it provides a record of modeling approaches, assumptions, and changes that enable knowledge transfer of information within the Company. Externally, when provided with the correct context, it can educate and provide additional information to better understand modeling approaches and potential limitations.

6.7.6 RA-4-A Improve Procedure for Independent Reviews of Data and Models

6.7.6.1 Problem Statement

The risk modeling requirements issued in the 2023-2025 WMP Technical Guidelines introduce new quality assurance and control requirements, which include independent, third-party reviews. Data and model reviews are currently conducted internally and via third-party on an as-needed basis. To-date, a third-party has been engaged to review WiNGS-Planning and WiNGS-Ops models. For further discussion regarding initial third-party review findings and recommendations, refer to Section 6.6.1 Independent Review.

6.7.6.2 Planned Improvement

SDG&E will continue to engage third parties to review data inputs, model assumptions, methodologies, and cybersecurity and will develop a procedure for conducting these reviews on a regular basis, beginning in 2023. Following the 2023 review and procedure establishment, SDG&E will enter each accepted recommendation from independent reviews into an action tracking system for resolution (assignment by responsibility, development of technical plan, schedule for development and deployment, etc.) in accordance with the requirements discussed in the 2023-2025 WMP Technical Guidelines.

6.7.6.3 Anticipated Benefit

The additional reviews, documentation, and action tracking system will help refine risk models, identify priorities, and improve risk modeling capabilities. The procedures for additional reviews will be used to confirm that data collected and processed for risk assessments are accurate and comprehensive.

6.7.7 RA-4-B Enhance Model Validation Process

6.7.7.1 Problem Statement

SDG&E continuously monitors and evaluates the validity of data inputs and assumptions that feed into its risk models; however, further improvements can be considered for implementation over time as the Company evolves and expands its modeling capabilities. The requirements outlined in the 2023-2025 WMP Technical Guidelines suggest that more mature programs regularly monitor and evaluate the scope and validity of modeling assumptions that include several factors not included in SDG&E's current models or models validation process (e.g., adaptation of weather history to current and forecasted climate conditions, availability of suppression resources, height of wind driving fire spread, etc.)

Additionally, according to the 2023-2025 maturity model, higher maturity includes conducting annual model validation by analyzing model performance for the previous year based on the data available at the time of WMP submission and on the assumptions presented in the WMP accepted prior to the fire season.

6.7.7.2 Planned Improvement

To elevate the maturity in the model validation area, SDG&E will formalize the current model validation process in 2023. Following the formalization process, an annual validation process will be established in 2024. Additional factors for the model validation will then be incorporated from 2025 to 2028 as described in OEIS Table 6-7.

6.7.7.3 Anticipated Benefit

The quantification of risk and the accuracy of analysis improves by refining the process of validating models. Substantiated data will lead to better quality of output for confidence in the models and results.

6.7.8 RA-5-A Deploy and Enhance WiNGS-Ops and WiNGS-Planning Visualization Platforms

6.7.8.1 Problem Statement

The WiNGS-Ops and WiNGS-Planning model outputs are not easily accessible without a visualization to disseminate information in a user-friendly platform. The visualization platform will present a lucid view of the service territory risk from both an operations standpoint as well as from a mitigation point of view. This visualization platform is expected to go live in 2023 and its capabilities will be expanded in future years.

6.7.8.2 Planned Improvement

Improvements to risk presentation are currently in development with the first phase of the WiNGS-Ops visualization platform currently deployed to be followed by the WiNGS-Planning visualization platform in early 2023. These applications will be available in the WCRC for both internal analysis as well as a version for public viewing to provide a transparent view of SDG&E's wildfire and PSPS risk profile, mitigation analysis, and monitoring of mitigation deployment. For further discussion the visualization platform, refer to Section 6.5 Enterprise System for Risk Assessment.

6.7.8.3 Anticipated Benefit

Within the visualization platform, users will be able to view circuit- and segment-level risk in the context of wildfire and PSPS events. Users will be able to interact with the data and run the WiNGS-Planning model with a range of different design-level scenarios to help guide investment decisions. The primary function of the WiNGS-Ops visualization platform is to support the PSPS de-energization decision during severe weather conditions by providing quick and easy platform to reliable data. This machine plus human experience strengthens the PSPS decision-making confidence by enabling a more targeted approach to risk analysis and real time weather updates.

6.7.8.4 Region Prioritization

The WiNGS-Ops and WiNGS-Planning visualization platform will cover the entire service territory.

For other details on Risk Assessment Improvement Plan, see response to Areas for Continued Improvement SDGE-22-06 Eight-Hour Fire Spread Simulations, SDGE-22-07 Risk Prioritization for Mitigation Measures and SDGE-22-09 Evaluation of Wind Gust Effects on Vegetation-Related Failures in Appendix D.

7 Wildfire Mitigation Strategy Development

7.1 Risk Evaluation

7.1.1 Approach

SDG&E uses a comprehensive approach to wildfire mitigation in its effort to promote public and system safety in the face of changing climate risks. SDG&E is committed to doing its part to reduce wildfire risk and promote reliability by preparing for and minimizing risks through a company-wide, risk informed focus, collaborative efforts, and drive for continuous improvement.

The third step of the Enterprise Risk Management Framework is Risk Evaluation and Prioritization (see Figure 7-1). See Section 4.4 Risk Informed Framework for details on the Enterprise Risk Management Framework.

Figure 7-1: Risk Evaluation & Prioritization Step of the Enterprise Risk Management Framework

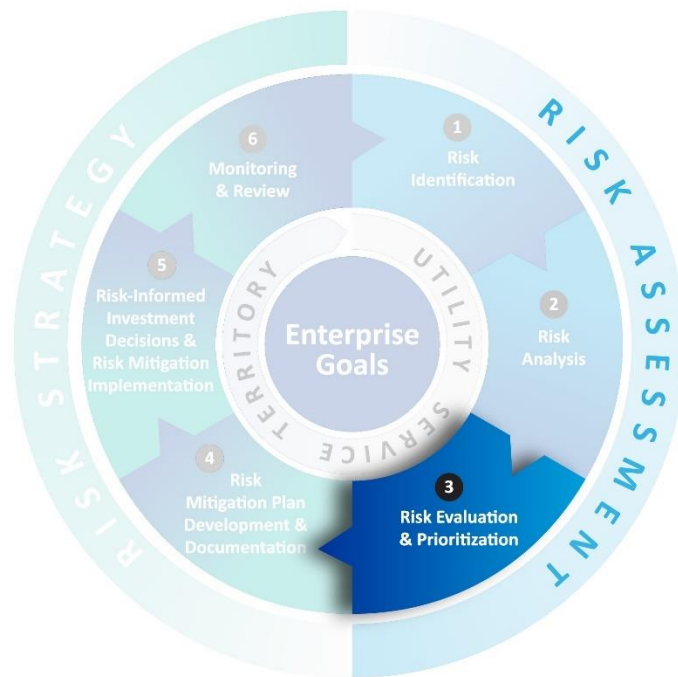

7.1.2 Key Stakeholders for Decision Making

SDG&E works closely with public and community partners to share wildfire-related information. Stakeholders are kept informed and educated through meetings, phone calls, and workshops. Community partners also share feedback on wildfire mitigation efforts and SDG&E continues to engage the public and have strong, long-standing partnerships with our community. OEIS Table 7-1 lists stakeholders and their roles in wildfire mitigation decision making.

OEIS Table 7-1: Stakeholder Roles and Responsibilities in the Decision-Making Process

Stakeholder	Stakeholder Point of Contact	Electrical Corporation Point of Contact	Stakeholder Role	Engagement Methods
SDG&E Wildfire Council	Executive Leadership	SDG&E VP - Wildfire & Climate Science	<ul style="list-style-type: none"> Provide executive-level review and direction of wildfire mitigation activities 	Bi-monthly meetings
SDG&E Board Safety Committee	Executive Leadership	SDG&E Board Safety Committee Chair	<ul style="list-style-type: none"> Provide executive-level review and direction of safety priorities 	Quarterly meeting
Wildfire Safety Community Advisory Council	Executive Leadership	SDG&E Chief Operating Officer	<ul style="list-style-type: none"> Provide open line of communication between teams. 	Quarterly meeting
Fire Directors Steering Team	Director members at SDG&E	Director of Wildfire Mitigation	<ul style="list-style-type: none"> Provide input and review wildfire mitigation and PSPS mitigation initiatives 	Monthly meeting
Regional Emergency Manager Working Group	Working Group Lead	Emergency Operations Services Manager	<ul style="list-style-type: none"> Working group provides information on local jurisdictional planning efforts Electrical corporation provides information on wildfire mitigations within local jurisdictions 	Bi-monthly meetings
County Fire Chiefs	Committee members and leadership	Fire Science and Coordination Program and OFER	<ul style="list-style-type: none"> Provide open line of communication between teams 	Monthly Meetings
Local, State, and Federal Fire Agencies	Specific to Agencies, typically chief level and above. Can include other ranks within departments depending on need and complexity of a request.	Fire Science and Coordination	<ul style="list-style-type: none"> Annual review of standard practice is performed internally and all external review of fire prevention plans is coordinated with the agencies having jurisdiction All Agencies have the ability to call and discuss incidents, plans, and mitigations at any time and input is incorporated as needed 	24/7 On Call and various professional relationships
San Diego County Evacuation Planning Committee	Committee members and leadership (Members include Fire agencies, Law Enforcement, and emergency operations)	Fire Science and Coordination Program Manager	<ul style="list-style-type: none"> SDG&E serves as a cooperator during evacuations and repopulation operations. SDG&E provides utility related expertise and other agencies provide information based on their area of expertise. 	Monthly and Quarterly Meetings
San Diego County Training Chiefs	Training Chiefs	Fire Science and Coordination and OFER	<ul style="list-style-type: none"> SDG&E coordinates with and trains local first responder personnel on utility safety and emerging technologies SDG&E sponsors and participates in the planning and execution of 	Monthly meetings and at training events

Stakeholder	Stakeholder Point of Contact	Electrical Corporation Point of Contact	Stakeholder Role	Engagement Methods
			an annual County wide Wildland drill providing subject matter expertise and participants	
Unified Disaster Council	Director of San Diego County Office of Emergency Services	Director of Emergency Management	<ul style="list-style-type: none"> County provides information on regional emergency/disaster mitigation programs Electrical corporation provides information on wildfire mitigations within county 	Bi-monthly meetings
Southern CA Tribal Emergency Managers Group	Working Group Lead	Tribal Relations Manager	<ul style="list-style-type: none"> Working group coordinates and shares planning efforts Electrical corporations provide information on wildfire mitigation 	Bi-monthly meetings
Tribal Working Group	Climate Science Alliance	Tribal Relations Manager	<ul style="list-style-type: none"> Working group coordinates and shares planning efforts SDG&E provides support and information on wildfire mitigation 	Bi-monthly meetings

7.1.3 Risk-Informed Prioritization

7.1.3.1 Selection of Areas for Mitigation

7.1.3.1.1 Geographic Scale used in Prioritization

SDG&E performs its WiNGS-Planning analysis at the circuit-segment level. The segment level of data granularity is required to establish segment parameters. The WiNGS-Planning model has been used to analyze segments in Tier 2 and Tier 3 of the HFTD, segments with historical PSPS event occurrences, and higher-risk urban areas such as coastal canyons or wildland open spaces. The higher-risk urban areas were specifically identified with input from the FSCA, overlaying the WUI from CAL FIRE and with review of historical wildfire. The use of WiNGS-Planning to inform priorities in the WMP is limited to the Covered Conductor and Strategic Undergrounding Programs (WMP.455 and WMP.473 respectively). This segment approach to execute mitigations and scoping the whole circuit segment not only addresses wildfire risk but reduces the impact of PSPS events. See Section 6.2 Risk Analysis Framework for details on WiNGS-Planning.

See response to Areas for Continued Improvement SDGE-22-07 Risk Prioritization for Mitigation Measures in Appendix D.

7.1.3.1.2 Statistical Approach used to Select Candidates

An approach used by SDG&E to retroactively look at mitigation selection was to create bins by riskiest overhead circuit-segment in the HFTD. This approach shows the distribution of wildfire risk across the HFTD and shows the deployment of mitigation in the highest wildfire risk areas. The method for scope selection is to prioritize hardening by wildfire risk rank while identifying all WiNGS-Planning mitigations on that circuit. See Section 7.1.3 Risk-Informed Prioritization Mitigation Selection for more details. This

circuit analysis is done to evaluate PSPS risk score and PSPS dependencies when selecting a mitigation. It also helps to limit mobilization, effectively survey, support long-term plan considerations, and optimize community impact. See response to Areas for Continued Improvement SDGE-22-07 Risk Prioritization for Mitigation Measures in Appendix D.

This statistical approach for mitigation review is shown in SDG&E Table 7-1 which highlights different versions of the WiNGS-Planning model used for scoping identified risk areas.

SDG&E Table 7-1: Risk Segment Scoped Mileage 2022-2027

Riskiest Overhead Circuit Segments in HFTDs (Ranked by Decreasing Per-Segment Risk)	Total Distribution Circuit Miles Scoped for Hardening 2022 - 2024	Total Distribution Circuit Miles Scoped for Hardening 2025-2027
Top 10%	437.9	377.9
Top 20%	161.9	148.2
Top 30%	27.9	77.4
Top 40%	1.7	0.0
Top 50%	0.3	11.6
Top 60%	2.8	0.0
Top 70%	9.1	0.0
Top 80%	0.0	0.0
Top 90%	0.0	0.0
Top 100%	0.0	0.0
Total	641.6	615.1

Note: WiNGS 1.0 was used for 2022-2024 hardening and WiNGS 2.0 was used for 2025-2027

7.1.3.1.3 Feasibility Constraints

The WiNGS-Planning Model has some feasibility constraints in the data. One of these constraints is the PSPS risk score which is highly dependent on segment configuration. While PSPS risk reduction is a high-priority goal of the WiNGS-Planning model, PSPS risk reduction cannot be achieved for a particular circuit segment without data on the mitigation of its upstream segments. Considering this limitation, the PSPS risk score is valuable to gauge how each segment mitigation will ultimately reduce PSPS risk.

Data is combined to create a single wildfire and PSPS risk score. When grouping many assets together, the WiNGS-Planning model must make decisions based on group rather than individual asset conditions. While individual asset conditions make up the circuit segment statistics, information is generalized as part of the aggregation process. For instance, the WiNGS-Planning model uses the average conductor age to adjust the ignition rate, however, the average conductor age simplifies the characteristics of the individual spans that comprise the circuit segment. Due to the nature of the circuit segment configuration, it is possible that a new span will skew the average towards a newer average age rather than the majority age for the segment. Improvements to WiNGS-Planning model statistics are expected to mature during the current WMP cycle. Considering the limitations of the segment-level aggregation process, the circuit segment continues to remain the most viable unit of measure for the application of mitigation decisions. Span-level mitigation applications are impractical because network connectivity is

obfuscated at this granular level when individual spans are mitigated without the consideration of the electric network. In addition, PSPS mitigation is difficult to accomplish when mitigating individual spans without mitigating the segment and upstream segments. On the other hand, whole circuit mitigations may take years to accomplish and could leave high risk spans outside of the circuits being mitigated without a timely mitigation plan. Considering the drawbacks of span level and whole circuit solutions, the circuit segment is the most practical unit for the application of mitigation decisions.

7.1.3.2 Prioritized List of Risks

The Wildfire Risk and PSPS risk score are combined to form an overall segment risk score. Wildfire Risk, PSPS Risk, and Overall Wildfire Risk are all analyzed to help identify high and low risk segments across the service territory according to the risk score. SDG&E considers the associated risk drivers to be overhead circuit miles, max wind gust, tree strike, percent hardening, asset health.

OEIS Table 7-2: Prioritized Areas in the Service Territory Based on Overall Utility Risk

Priority	Area	Description	Overall Utility Risk*
1	Tier 3	Per the CPUC Fire-Threat Map, the “Tier 3 fire-threat areas depict areas where there is an extreme risk (including likelihood and potential impacts on people and property) from utility associated wildfires.” For the purposes of this WMP, Tier 3 represents all of the Tier 3 HFTD area within the service territory. Note: If any part of the segment crosses into Tier-3 the area is classified as Tier-3.	1492.7
3	Tier 2	Per the CPUC Fire-Threat Map, the “Tier 2 fire-threat areas depict areas where there is an elevated risk (including likelihood and potential impacts on people and property) from utility associated wildfires.” For the purposes of this WMP, Tier 2 represents all of the Tier 2 HFTD area within the service territory.	532.1

Note: Based version 3.0 of WiNGS-Planning capturing risk snapshot at the beginning of 2023.

**Numbers are rounded to nearest tenth place and an additional coefficient factor of x10000 is applied to the scores for readability.*

7.1.4 Mitigation Selection Process

The WiNGS-Planning model is utilized to obtain segment risk ranking, segment RSE analysis, and portfolio analysis. This informs scoping for higher-capital programs, including grid hardening initiatives in the HFTD. The mitigations proposed in the WiNGS-Planning model results are strategic undergrounding of electric lines and installing covered conductor; these initiatives are the most effective at reducing risk events on utility equipment and thus lowering the likelihood of ignition. In the face of growing climate change and with the benefit of continually evolving data, the WiNGS-Planning model increasingly points to increased use of strategic undergrounding of electric lines as the optimal grid hardening strategy in identified areas. Strategic undergrounding of electric lines is uniquely equipped to mitigate both the risk of catastrophic wildfire and reduce the impacts and necessity of PSPS events when winds reach top speeds. WiNGS-Planning continues to provide a hybrid grid hardening approach, aimed at balancing risk and cost-benefit of installing covered conductor and strategic undergrounding of electric infrastructure. For more information on WiNGS-Planning, see Appendix B.

7.1.4.1 Identifying and Evaluating Mitigation Initiatives

7.1.4.1.1 Procedures to Develop Mitigation Initiatives

WiNGS-Planning makes use of the MAVF as described in SDGE RAMP-C Risk Quantification Framework and RSE, page C-5, dated May 17, 2021, and evaluates both wildfire and PSPS impacts at the sub-circuit/segment level. SDG&E refers to its MAVF as the Enterprise Risk Management Framework. The segment level of data granularity is required to establish segment parameters. Investment and prioritization decisions for risk mitigations are informed by calculating risk reduction benefits, which include improvements to wildfire safety and reductions of PSPS impacts on customers. The WiNGS-Planning model is essentially a weighted sum model that incorporates high-level variables of wildfire LoRE, wildfire CoRE, PSPS LoRE, and PSPS CoRE with associated weightings and scaling factors for each variable. It is used to analyze risk by estimating current risk scores (pre-mitigation risk scores) and forecasting future risk scores if new activities are started or current ones are ceased (post-mitigation risk scores). For more information on the Enterprise Risk Management Framework, see SDGE 2021 RAMP filing, dated May 17, 2021. For more information on WiNGS-Planning, see Appendix B.

In D.18-12-014, issued on December 21, 2022, the CPUC replaced the 2018 S-MAP SA with a new Risk-Based Decision-Making Framework (RDF). The decision and new framework direct SDG&E to conduct new community-based analyses on risk mitigation impacts and to replace the MAVF with a Cost-Benefit approach that includes standardized dollar valuations of risk event consequences. These changes will be informed by CPUC-authorized Technical Working Groups in 2023 and by the completion of methodology refinement studies. The Commission directed SDG&E to transition from the 2018 S-MAP RDF methodology to the new approach in time for its 2025 RAMP filing. To the extent that it is practicable, future WiNGS-Planning risk quantification methodologies will be aligned with those implemented in SDG&E's 2025 RAMP filing and pre-work.

7.1.4.1.2 Mitigation Initiatives that Address Local Wildfire Risk Drivers

Local wildfire drivers include, but are not limited to, downed conductors, nature events, foreign object/vegetation contacts, and equipment failures. Of these, overhead line exposures represent the greatest risk. Strategic undergrounding of electric lines is the most effective way of reducing wildfire risk as it reduces the likelihood for high winds to adversely impact grid assets. Given the high number of miles that overhead lines cover, cost-benefit calculations developed in the WiNGS-Planning model suggest prioritization of strategic undergrounding of electric lines within HFTDs. PSPS risk is also more effectively mitigated as there will not be a need for a PSPS event if all overhead exposure is removed to that circuit segment and it is undergrounded back to the substation.

Data on historic PSPS events, wind conditions, and other criteria is reviewed to determine where strategic undergrounding of electric lines will have the largest strategic impact. As climate change continues to increase the potential for wildfires, strategic undergrounding will likely remain the most effective strategy for reducing risk. While it is highly effective, its associated costs are higher than with other mitigations such as installation of covered conductor. The installation of covered conductor has the potential to raise the threshold for PSPS events to higher wind speeds compared to bare conductor hardening, but to date no PSPS wind speed threshold increases have been implemented. The WiNGS-Planning model is utilized to both evaluate mitigation alternatives and prioritize the deployment of mitigations at the circuit segment level.

SDG&E is evaluating recent changes ordered by the CPUC²² regarding the transition from RSEs to Cost-Benefit ratios for incorporation into the risk models. This transition will not affect inputs and risk drivers that are considered in the context of wildfire and PSPS risks.

7.1.4.1.3 Characterization of Uncertainties and Incorporation into the Decision-Making Process

The WiNGS-Planning model is one tool in a multi-layered decision process that aids in the application of wildfire mitigations for investment planning decisions. While the WiNGS-Planning model presents a quantitative mitigation decision, it is vital that proposed mitigations undergo subject matter expert review. This is accomplished via the desktop feasibility analysis that accompanies the scoping process. This feasibility analysis includes geography, loading, specific standards, environmental, and other projects (see Figure 7-4 for additional details). The latest CPUC decision requires the use of standardized dollar valuations for risk consequences which will be reflected in future WiNGS-Planning methodologies. However, as with the current decision-making process leveraged in WiNGS-Planning, proposed mitigations and inputs will continue to need additional subject matter expertise and review.

7.1.4.1.4 Potential Mitigation Initiatives

The WiNGS-Planning model considers areas in Tier 2 and Tier 3 of the HFTD and circuit-that have experienced a historical PSPS event to focus on areas with the highest risk of wildfire. The WiNGS-Planning model considers two mitigations: strategic undergrounding of electric lines and the installation of covered conductor.

Strategic Undergrounding Program (WMP.473)

Strategic undergrounding of electric lines converts overhead systems to underground, providing the dual benefits of nearly eliminating wildfire risk and the need for PSPS events in these areas. Risk models are constantly evolving by improving data quality and integrating new methods for analysis. These improvements lead to more accurate wildfire risk assessment and increase the effectiveness of proposed mitigations. SDG&E has been able to identify areas of cost-efficiencies and overall lifecycle cost reductions. The current cost of undergrounding is approximately \$2.3 million per mile. Cost savings reflected in updated versions of the WiNGS-Planning model were obtained by gaining efficiencies without compromising safety using reduced trench depths, reduced conduit size when applicable, implementing new construction technology when needed, strategically bidding and bundling projects, avoiding and coordinating resurfacing conflicts, and streamlining and updating the processes, procedures, and policies.

To calculate the wildfire risk reduction for strategic undergrounding of electric lines, data on historical ignitions associated with underground equipment, pre-mitigation overhead system risk event rate, and ignitions rates were analyzed. Specifically, the effectiveness of strategic undergrounding was measured by taking total CPUC-reportable ignitions associated with undergrounded electric lines and dividing by total ignitions. For more information on risk reduction and impact on risk components reference metrics in Section 8.1.1.3 Performance Metrics.

²² [SCG SDGE RAMP-C Risk Quantification Framework and Risk Spend Efficiency 5-17-21.pdf](#)

Covered Conductor Program (WMP.455)

Covered conductor is a widely accepted term to distinguish from bare conductor. The term indicates that the installed conductor utilizes triple extruded layers consisting of a semi-conducting sheath, an insulating polyethylene sheath, and an abrasion resistant XLPE external cover to provide incidental contact protection. For additional information, see Section 8.1.2.1 Covered Conductor Installation. The current cost of installing covered conductor is approximately \$1.4 million per mile.

Installing covered conductor is expected to reduce ignitions by 0.25 ignitions between 2023 and 2025. This estimate is derived by evaluating different causes of ignitions using 5-year ignition data from 2017 to 2021 and estimating a potential reduction in each cause based on estimates of effectiveness of installing covered conductor (e.g., ignitions caused by animal contact, balloon contact, and vegetation contact have an estimated reduction of approximately 90 percent while ignitions caused by vehicle contact have an estimated reduction of 0 percent). This results in an overall estimated effectiveness of 65 percent. For more information on risk reduction and impact on risk components see Section 8.1.1.3 Performance Metrics.

Relevant Uncertainties for the Strategic Underground and Covered Conductor Programs (WMP.473 and WMP.455)

Constraints such as land rights, environmental, permitting, and design are considered, as these are often outside of the utility's control and may require changes to the original design and scope of a project. Other limitations and uncertainties relating to the WiNGS-Planning model are summarized below. More detailed information can be found in Section 6.2.3 Key Assumptions and Limitations.

- Annual Ignition Rate
- Significant Wildfire Likelihood
- WRRM Financial, Safety, and Reliability Adjustment Factors
- Underground contingency mileage
- Maximum wind speeds at each segment
- Regulatory approval

Implementation Schedule for the Strategic Underground and Covered Conductor Programs (WMP.473 and WMP.455)

Figure 7-2 shows the long-term portfolio mitigation targets for both Strategic Underground and Covered Conductor Programs (WMP.473 and WMP.455 respectively). The annual targets reflect the total mileage for each mitigation type as recommended by WiNGS-Planning. Achievement of the total mileage targets for both programs supports their fire risk reduction goals. Year-to-year targets were established after considering the miles hardened per year to date (i.e., prior to 2023), a practical ramp-up period, and then achievement of a program “steady-state”.

Figure 7-2: WiNGS-Planning: Wildfire Hardening Targets

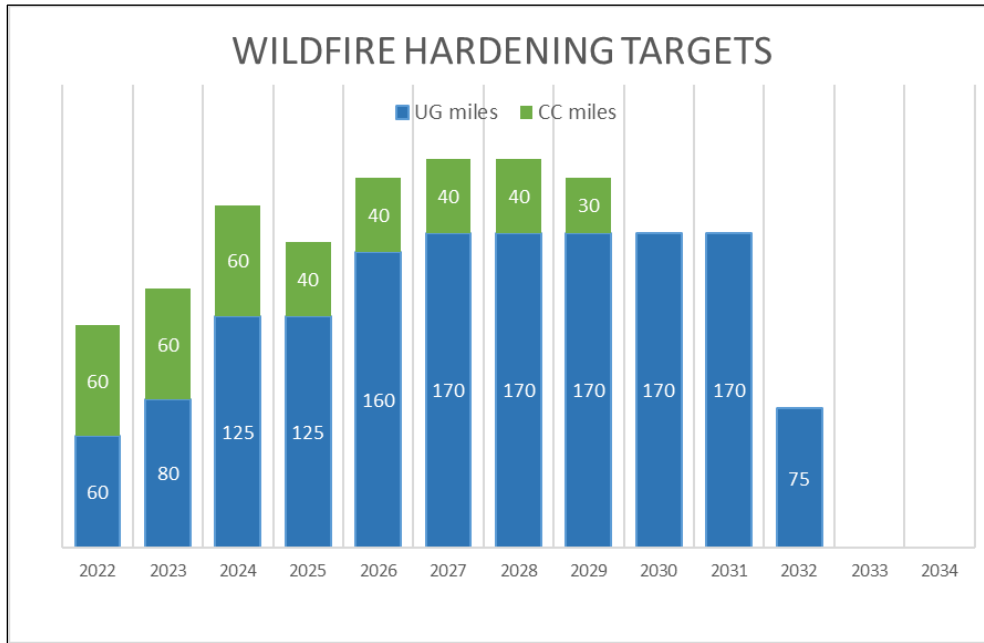

7.1.4.1.5 MAVF and other Specific Risk Factors

The WiNGS-Planning model was developed to aid with the allocation of grid hardening initiatives across the HFTD based on an assessment of both wildfire risk and PSPS impacts. WiNGS-Planning is built upon the MAVF framework in RAMP and evaluates both wildfire and PSPS impacts at the sub-circuit/segment level. A segment is composed of one or many spans located between two SCADA sectionalizers in the electric network. The segment level of data granularity is required to establish the segment parameters. Information is used to inform investment decisions by determining and prioritizing mitigation based on RSEs, improving wildfire safety, and limiting the impact of PSPS on customers.

See Section 6.1.1 Overview for further information on the MAVF.

7.1.4.2 Mitigation Initiative Prioritization

Initiatives identified by WiNGS-Planning, namely, covered conductor and strategic undergrounding (WMP.455 and WMP.473 respectively), are currently informed by the RSE methodology outlined in the 2018 S-MAP Settlement Agreement. CPUC D.18-12-014 requires transition to a new RDF for the 2025 RAMP. This decision recognizes that the utilities will not be bound to select mitigation strategies based solely on model outputs, and may consider other factors that inform initiative prioritization. Risk mitigation impacts will be quantified using monetized and standardized risk consequences to the most practicable extent; however, final prioritization choices will continue to be influenced by factors such as labor resources, technology, and modeling limitations and/or uncertainties affecting the analyses.

7.1.4.2.1 Evaluation of Potential Mitigation Initiatives

Once the baseline risk per segment has been established, the next step is evaluating the effect and costs of different mitigations. For each mitigation in the model there is an associated percentage decrease in wildfire risk and PSPS impact. For wildfire risk mitigation effectiveness, internal and external subject matter expertise is used to estimate the impact of a mitigation on various wildfire triggers (e.g., animal

contact, vegetation contact). Where possible, additional analyses are conducted using internal data (e.g., historical fault data). For PSPS impact reduction, internal subject matter expertise and historical event data are used to estimate the reduction in PSPS likelihood for the individual segment probability tied to each mitigation. The cost of the mitigation is determined by utilizing the average cost per mile and applying it to the circuit-segment. For strategic undergrounding of electric lines, a mileage contingency related to conversion is also considered. With risk reduction and cost assessment analyzed at the granularity of the circuit-segment, a cost benefit value is calculated for each mitigation tied to each circuit-segment in the WiNGS-Planning model scope.

Because the PSPS risk on a segment is influenced by the maximum upstream segment PSPS probability, mitigations that occur upstream of segments will also influence the risk of PSPS on downstream segments. Thus, PSPS impact on a segment cannot be looked at in isolation and must be considered with other segments on the same circuit and their respective mitigations. The dynamic nature of the WiNGS-Planning model updates the maximum upstream probability of a segment as mitigations upstream are determined.

The CPUC's December 2022 decision²³ maintains that PSPS events must be modeled within the RDF as a risk, not just as a mitigation. For instance, in order to quantify the potential impact of PSPS de-energizations, the Lawrence Berkeley National Laboratory is currently studying the impacts of outages in participating territories nationwide. The CPUC has directed California IOUs to participate in the study as well. In preparation for its 2025 RAMP, SDG&E plans to work with Lawrence Berkeley National Laboratory in its refinement and definition of standardized and monetized risk consequences, e.g., reliability, and this external subject matter expertise may be incorporated into future WiNGS-Planning PSPS risk assessments where applicable.

7.1.4.2.2 Identification of Mitigation Initiatives

The primary goal of the WiNGS-Planning model is to analyze and compare different long-term investment planning portfolios and scenarios. Utilizing varied constraints and risk target goals, including risk reduction percentages, total scenario cost, and RSE thresholds for mitigation considerations, different scenarios can be run across the full scope of circuit-segments considered. This results in a unique set of mitigations chosen across the full scope of circuit-segments and the scenario outputs (e.g., total risk reduction, total cost, strategic underground mitigation mileage) that result from their implementation. WiNGS-Planning analyzes each circuit-segment for installation of covered conductor, strategic undergrounding of electric lines, or no-mitigation to optimize and compare the risk reduction and associated cost. Currently, RSE outputs from WiNGS-Planning are used to inform how to invest in mitigations that reduce risk. Although the risk reduction targets are often aimed at cost effectiveness, annual performance objectives, mileage targets, and other limitations and constraints are also considered to inform investment decisions.

Sensitivity analyses are employed to validate the RSEs and mitigation sections of the WiNGS-Planning model. In this analysis, constants, including cost per mile estimates and RSE thresholds, are adjusted to determine how sensitive the mitigation recommendations are to different size variable adjustments.

²³ <https://docs.cpuc.ca.gov/PublishedDocs/Published/G000/M500/K014/500014668.PDF>

The Electric System Hardening (ESH) team provides a realistic assessment of proposed mitigations and variables that should feed into the WiNGS-Planning model. The ESH team is critical in this regard and is in frequent communication with the WiNGS-Planning team during development. Their feedback is utilized to help better inform WiNGS-Planning model optimization and interpretability.

The December 2022 CPUC decision to transition to a new RDF for 2025 RAMP may result in new cost-effectiveness measures and investment decisions for mitigations, though this will not be completely defined until the new framework is fully developed. At that time, WiNGS-Planning models will reflect the new CPUC-mandated methodologies where practicable. It is important to note that the CPUC, in its decision, recognized that cost-benefit ratios will not and should not be the sole determinative factors to prioritize investments. Non-quantitative factors, regulatory requirements, and other factors will continue to be considered in the context of choosing the best risk mitigation investment strategies.

In the early phases of SDG&E's wildfire mitigation efforts and prior to the use of WiNGS-Planning, SDG&E's overhead bare conductor hardening programs focused on targeted only the spans identified as containing certain high-risk assets (e.g., bare conductor, aged wood poles). These programs were aimed at reducing the highest level of risk, focused specifically on the replacement of the identified high-risk assets, and did not address entire segments. Therefore, most circuit segments were left only partially hardened in the top risk areas. While these efforts reduced the wildfire risk associated with the span or asset, the ability to mitigate PSPS impacts and fully address the wildfire risk associated with the entire segment was limited. With the assistance of more advanced risk modeling and the use of WiNGS-Planning, SDG&E now evaluates risk based on an entire segment, i.e., between isolating devices, to mitigate wildfire risk and to support the reduction of PSPS impacts.

In the example pictured below, for circuit 358-682F the WiNGS-Planning model takes into consideration prior bare hardening efforts, yet it is still ranked number 9 on the top segments risk list and is planned for undergrounding in this WMP cycle. As shown in Figure 7-3, there has been minimal prior bare hardening completed on the segment, depicted by the light blue color. Customers served by this segment have experienced PSPS six times between 2019 and 2021. Deployment of underground and covered conductor throughout the entire segment, as shown by the yellow and black in Figure 7-3, will significantly reduce the wildfire risk and minimize the need for future PSPS for these customers.

Figure 7-3: Circuit 358-682F: Example of Prior Hardening

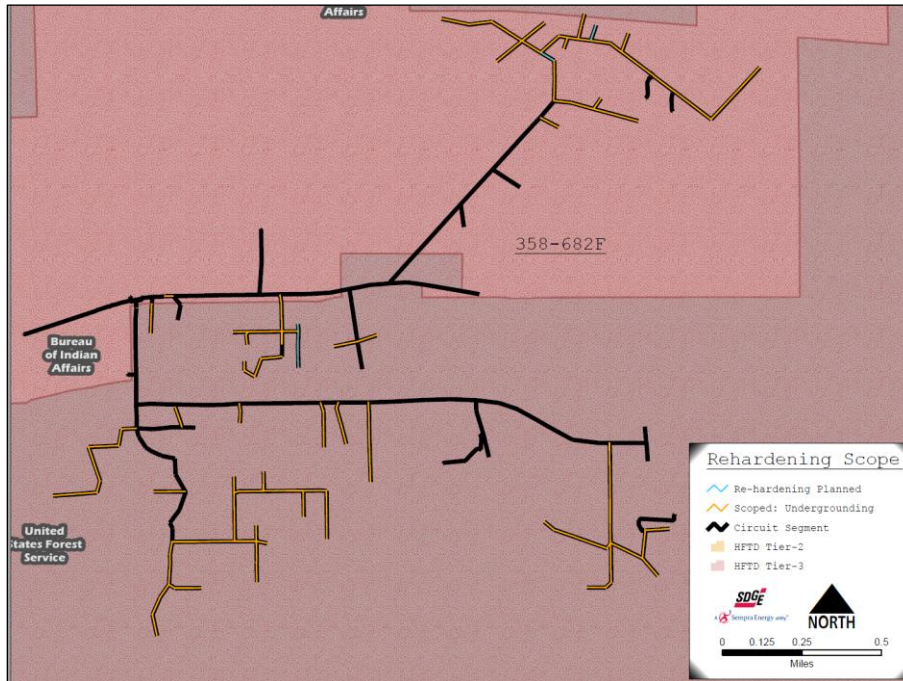

Mitigation initiatives are not necessarily prioritized by geographic area. Given the size and scale of the service territory, a risk-based approach is used for targeting the grid hardening strategy. Wildfire and PSPS mitigations are prioritized within the HFTD, with a focus on work within HFTD Tier 3 before proceeding to HFTD Tier 2. This approach utilizes the defined HFTD Tiers as a proxy for more detailed risk-modeling to prioritize the areas of extreme risk from wildfires first, followed by the areas of elevated risk from wildfires. In some cases, however, the WiNGS-Planning model may recommend a scope of work that prioritizes HFTD Tier 2 areas over HFTD Tier 3 based on the risk of the circuit segment.

See SDG&E Table 7-2 for a breakdown of initiative prioritization, which includes other initiatives not informed by WiNGS-Planning.

SDG&E Table 7-2: Mitigation Prioritization

Mitigation	Utility Initiative Tracking ID	Prioritization
Covered Conductor Installation	WMP.455	Work prioritized utilizing WiNGS-Planning Model.
Undergrounding of Electric Lines and/or Equipment	WMP.473	Work prioritized utilizing WiNGS-Planning Model.
Transmission System Hardening Program	WMP.543, WMP.544, WMP.545	Work prioritized within HFTD. Tier 3 prioritized over Tier 2.
Advanced Protection	WMP.463	Work prioritized within HFTD. Tier 3 prioritized over Tier 2.
Early Fault Detection	WMP.1195	Work prioritized within HFTD.

Mitigation	Utility Initiative Tracking ID	Prioritization
SCADA Capacitors Maintenance and Replacement Program	WMP.453	Work prioritized in HFTD. Tier 3 prioritized over Tier 2.
Expulsion Fuse Replacement Program	WMP.459	Work prioritized in HFTD. Tier 3 prioritized over Tier 2.
Hotline Clamp Replacement Program	WMP.464	Work prioritized in HFTD. Tier 3 prioritized over Tier 2.
Lightning Arrester Removal and Replacement	WMP.550	Work prioritized in HFTD. Tier 3 prioritized over Tier 2.
Avian Protection Program	WMP.972	Work prioritized within HFTD.
Strategic Pole Replacement Program	WMP.1189	Work prioritized within HFTD with additional risk criteria.
Drone Assessments	WMP.552	Work prioritized utilizing Inspection Prioritization Model.
Vegetation and Fuels Management – Pole Clearing	WMP.512	Work performed within the State Responsibility Area (SRA).
Vegetation Management Off-Cycle Patrol Inspections	WMP.508	Additional inspections performed on inventory trees within HFTD.

7.1.4.2.3 Resource Optimization

SDG&E optimizes resources while maximizing risk reduction using the WiNGS-Planning Model. RSEs are incorporated into the final WiNGS-Planning decision-making process to maximize the risk reduction and use resources appropriately. The WiNGS-Planning model selects the more efficient use of SDG&E’s funding and resource allocation to focus mitigation deployment on wildfire risk reduction. As described in RAMP, RSEs are numerical values that attempt to portray changes in risk scores per dollar spent. For more information on RSEs see SDGE RAMP-C Risk Quantification Framework and RSE, page C-26, dated May 17,2021.²⁴

To optimize workforce resources, a project management team has been established that oversees a portfolio of wildfire mitigations. For strategic undergrounding projects, the project management team works with supply management to bundle and bid projects strategically, expediting schedules while maintaining construction quality. Fixed pricing can be a strategic option with contractors that have demonstrated outstanding performance. Fixed pricing leverages efficiencies and the contractor’s direct knowledge of site conditions in exchange for a fixed price. Projects in the same area are often bundled to streamline supply management efforts and reduce overall cost. In addition, civil and electrical work are bid out separately to minimize cost and expedite schedules.

The Strategic Undergrounding Program (WMP.473) works with the Logistics business unit to provide material forecasting for long lead time materials or low quantities of material in stock. Ordering material ahead of time reduces the chance of delays to construction and energization planned dates. Working closely with Logistics allows the project management team to minimize any foreseeable issues with material acquisition and find solutions before the schedule is impacted.

²⁴ [SCG SDGE RAMP-C Risk Quantification Framework and Risk Spend Efficiency 5-17-21.pdf](#)

Continuous process improvements are also one of the major cost reductions. By improving current processes and/or creating new ones, the project team can effectively support the Strategic Undergrounding Program (WMP.473) and show immediate benefits. Examples of these process improvements are:

- Removing unnecessary data in the design documents
- Going to the field with construction, design, and environmental personnel to review the design package at 30 percent completion
- Developing new design standards that make construction more efficient
- Planning and scoping for the next 3 years, which includes prioritization, and creating an execution plan and map

Most notably, in 2022 SDG&E issued a Request for Proposal (RFP) to several qualified firms to solicit input on further developing the Strategic Undergrounding Program. This includes workload levelling, workforce planning, material forecasting and management, pre-construction and construction management, and building out the Program Management Office (PMO) to scale up the program to complete over 1,400 miles of strategic undergrounding by 2032.

The Covered Conductor Program uses a similar schedule and process as traditional hardening. Currently three primary construction contractors and multiple internal crews perform electrical construction work associated with installation of covered conductor. The civil work (pole hole and anchor digging), helicopter, traffic control, and dedicated fire watch are typically sub-contracted. In 2022, 50 percent of the electric work was performed by contractors and 50 percent by internal crews. In 2023, about 30 percent of the electric work is expected to be completed by contractors and about 70 percent by internal crews. By working with more internal crews to perform the electrical work, time and effort required to bid and manage contractors is avoided, making the process more efficient.

For both the Strategic Underground and Covered Conductor Programs, processes have been updated and streamlined to shorten the design duration while maintaining technical quality and integrity. Examples include:

- Completing field constructability reviews earlier in the process
- Resurfacing coordination to avoid repaving
- Implementing a permit strike team
- Collaboration and partnering with design firms to define expectations and processes
- Building a relationship with San Diego County and their inspectors
- Re-evaluating program contracting strategy

For more details on Covered Conductor and Strategic Undergrounding Programs see Section 8.1.2 Grid Design and System Hardening.

Figure 7-4: High-Level Mitigation Prioritization to Reduce Wildfire and PSPS Risk

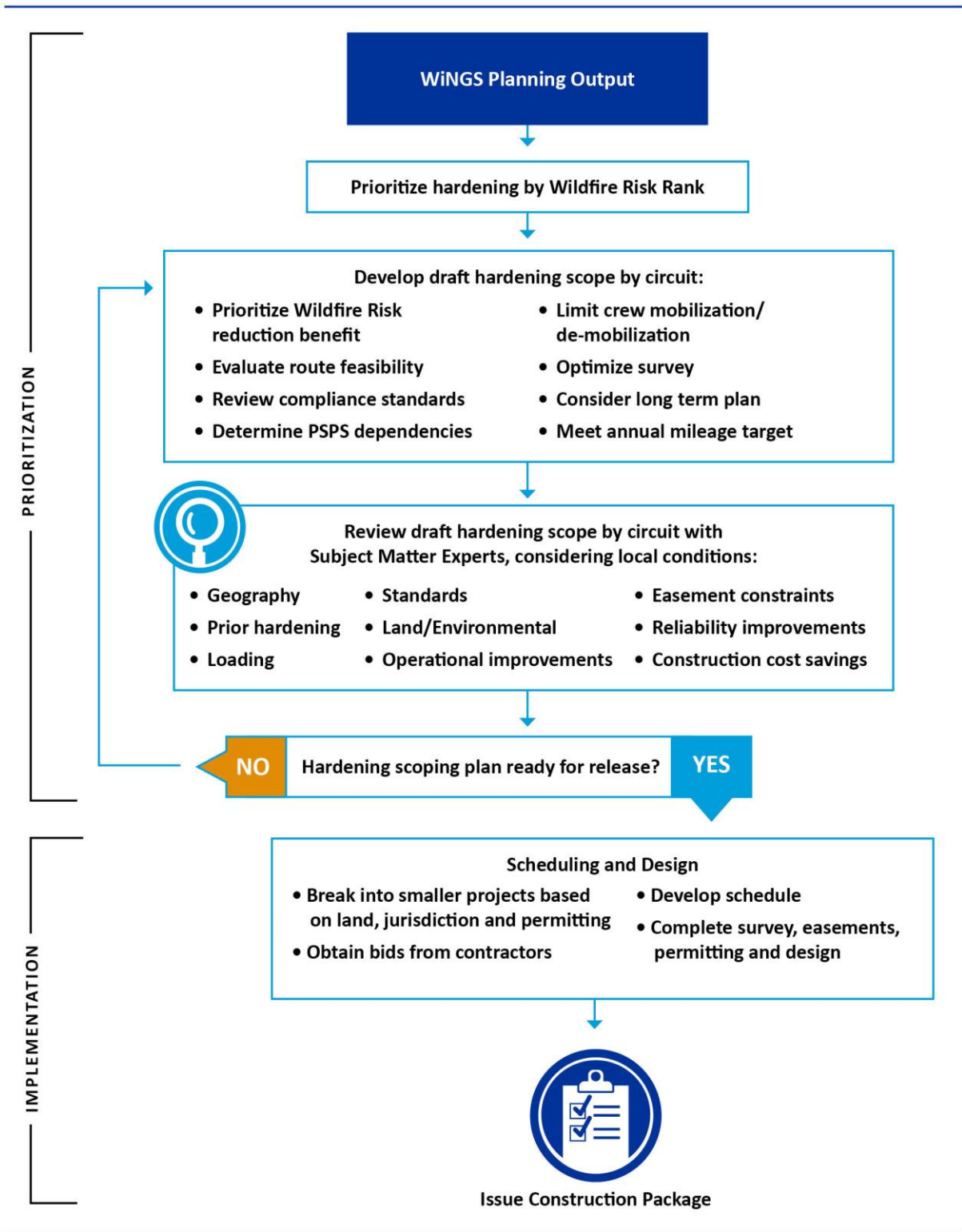

The WiNGS-Planning Model makes one of three recommendations to mitigate risk for each circuit-segment with overhead exposure in the HFTD: 1) strategic undergrounding of electric lines, 2) installation of covered conductor, 3) no strategic undergrounding or covered conductor mitigation. For segments that WiNGS Model select a mitigation, SDG&E may implement interim or alternative mitigations outside of undergrounding and covered conductor to reduce the risk, see Section 7.2.3 Interim Mitigation Activities and Section 8 Wildfire Mitigations for more information on other Grid Hardening Efforts. The primary drivers for selecting a circuit-segment mitigation project are the wildfire risk rank (a direct output from WiNGS-Planning) and the PSPS history and risk of the circuit. The PSPS review considers both upstream and downstream topography, wind speeds, and recommended mitigations to optimize the overall mitigation plan for the circuit. For more information, see Section 7.1.3 Risk-Informed Prioritization.

Additionally, efficiencies that can reduce the resource burden are considered. Limiting projects to geographically proximate locations can optimize survey time (reducing travel times for teams fielding the fire hardening scope), limit mobilization/demobilization for construction crews, and optimize use of existing laydown yards. Long-term planning is also considered to ensure that year-over-year mileage targets are met.

After the circuit-segment mitigation projects have been selected and prioritized, a desktop scoping and feasibility study is performed which includes geography, prior hardening, loading, standards, land/environmental, operational improvements, easement constraints, reliability improvements, and construction cost savings.

Geography

A desktop analysis is performed that includes geospatially accurate information in order to assess optimal routing and terrain considerations for feasibility. For example, strategic underground routing is best achieved along existing roads and often requires a reroute if the existing overhead goes up a mountain or cross country. Additionally, awareness of rivers and streams helps avoid water crossings and provides the ability to identify areas to avoid, such as preserves. Beyond the scoping stage, geotechnical investigation is usually conducted at each job location to identify soil conditions in the area. For example, rocky subsurface, which is common in the back country, is a difficult subsurface for underground construction. A rocky subsurface should be identified early in the design process to minimize design changes.

Loading

Distribution Planners are engaged in early scoping stages to incorporate appropriate conductor and cable sizing for anticipated load growth as well as to provide input on cutovers and necessary rerouting.

Standards

SDG&E Construction Standards indicate appropriate situations for each mitigation type. For example, in extra heavy loading districts above 5,000 feet, covered conductor cannot be installed and therefore a strategic underground solution would need to be selected. Standards also dictate available cable and conductor sizes to scope.

Land/Environmental

Land/environmental overlap is assessed early in each project. By knowing the jurisdiction up front, projects can be broken into sections with similar timelines. Sections are reviewed by Environmental Management who assigns each a score based on any environmental constraints that could negatively impact the project schedule. These issues include avoiding cultural resources, water resources, and biological resources by rerouting or going trenchless. At the 30 percent design submittal stage, every project team performs a constructability walk, where experienced strategic underground construction experts walk the entire route with the design and environmental teams and other necessary stakeholders to identify and resolve any potential construction and environmental issues before final design to reduce instances of field change orders.

Operational Improvements

Strategic undergrounding projects are conducted in the areas of highest wildfire risk, typically in rural areas of the service territory. There are numerous narrow and remote roads and paths on these projects. The design team considers egress and ingress as they progress through the design phase and selects the most appropriate design for the specific location. For example, if egress and ingress is an issue at a construction site, the designer may consider using native backfill instead of slurry fill, working space, traffic coordination, and the type of equipment used to minimize potential traffic issues.

Easement Constraints

Permitting requirements are identified as early as possible to accurately scope and schedule each project. Agencies such as Cleveland National Forest, Caltrans, and the Bureau of Indian Affairs typically have longer permitting lead times compared to San Diego County permits and those timelines need to be accurately reflected in the project schedule. When working with these agencies, project managers get involved early to define a clear permitting approach and strategy.

Reliability Improvement

Hardening projects provide an opportunity where appropriate to make engineering enhancements, driven by wildfire risk reduction, that also contribute to improved reliability. This may include additional circuit ties or additional sectionalizing.

Construction cost savings

The scoping team seeks to optimize routes, especially in the case of ungrounding, to provide service to customers in the most efficient manner possible. Optimization includes following existing rights of way and avoiding known environmental or permitting challenges.

After the desk top feasibility study, the scope is typically divided into smaller projects based on land jurisdiction and permitting. A finalized scope is then developed for each project and sent out to contractors to bid. The finalized scope is also used to develop schedules for each project.

See response to Areas for Continued Improvement SDGE-22-14 Grid Hardening Decision-Making Process Transparency in Appendix D.

7.1.4.3 Mitigation Initiative Scheduling

7.1.4.3.1 Mitigation Initiative Scheduling

For both Covered Conductor and Strategic Undergrounding projects (WMP.455 and WMP.473 respectively), project scheduling is completed by dedicated resources working in conjunction with project teams to routinely build and update project schedules. Once the project scope is finalized, a project schedule is created using Primavera P6, starting with a standard template which is based on typical activities and durations for each step of the project lifecycle. The schedule is then updated for each project based on the history of projects and adjusting activities, durations, and activity relationships based on the specific constraints and requirements of each project. Throughout the project lifecycle, the project schedule is routinely reviewed and updated based on input from project team members.

7.1.4.3.2 Interim Mitigation Process

See Section 7.2.3 Interim Mitigation Activities

7.1.4.3.3 Monitoring Progress toward Targets with Known Limitations and Constraints

Progress toward annual targets is monitored in several ways. For the Strategic Underground and Covered Conductor Programs (WMP.473 and WMP.455 respectively), project schedules are developed based on typical activities and durations for each step in the project lifecycle and based on the history and known industry timeframes. Activities that drive the schedule include land rights, research, interpretation, acquisition, environmental review, and permitting. When a resource constraint is identified that would impact multiple programs within the electric portfolio, the Portfolio Management and Project Controls business unit is notified. This business unit collects project forecasts across the electric portfolio and creates and applies prioritization framework. Custom reports for tracking are developed and meetings to discuss issues and resolution are planned. These measures are usually short term and transferred to responsible business units to maintain once the resource becomes less constrained. All projects are tracked weekly through an internal WMP Dashboard to stay informed of all activities in the project life cycle.

Projects are planned based on reasonable historical timelines; however, there are limitations and constraints that are outside of the utility's control, or the constraints and timeline may be unique to a specific project. Land rights acquisitions, environmental processes, and permitting often dictate the final schedule for construction. Some permitting processes can take from 6 months to 1 year to complete. In some cases, obtaining land rights can take months or even years, especially if legal processes must be used to obtain proper land rights and/or gain access. Knowing that some of these constraints are out of the utilities control, progress is monitored by meeting with the agency or land owner regularly to get updates and provide information as necessary to not only move the process along, but also to utilize additional scope to help meet annual targets.

7.1.4.3.4 Measuring Effectiveness of Mitigation Initiatives

To determine the effectiveness of initiatives to prevent wildfires, several efficacy studies have been completed. These studies are refreshed using the most updated data from 2021 to show continued effectiveness and will be updated annually, with the addition of new studies as needed. See the 2022 WMP Update for details on efficacy studies. Updates to studies are as follows:

- Determination of Average Distribution Ignition Percentages by Location and Operating Risk Condition – Section 8.3.6.1.1
- Understanding the Effectiveness of Recloser Protocols - Section 8.1.8.1.2
- CAL FIRE Approved Expulsion Fuses (WMP.459) vs Other Expulsion Fuses – Section 8.1.4.4
- Impact of Sensitive Relay Settings at Reducing Ignitions from Risk Events – Section 8.1.8.1.1
- Impact of Inspection Programs at Finding and Repairing Equipment Issues – Section 8.1.4.2
- Impact of Other Special Work Procedures on Ignitions – Section 8.1.8.3.1
- Impact of Contract Fire Resources (CFR) on Ignitions – Section 8.1.8.3.2

7.2 Wildfire Mitigation Strategy

The fourth step of the Enterprise Risk Management Framework is Risk Mitigation Plan Development & Documentation (see Figure 7-5). See Section 4.4 Risk Informed Framework for details on the Enterprise Risk Management Framework.

Figure 7-5: Risk Mitigation Plan Development & Documentation Step of the Enterprise Risk Management Framework



7.2.1 Overview of Mitigation Initiatives and Activities

OEIS Table 7-3: List and Description of Electrical Corporation-Specific WMP Mitigation Initiatives for 3-year and 10-year Outlooks

WMP Category	Within 3 Years	Within 10 Years	Location in WMP
Grid design, operations, and maintenance	<p>Install CAL FIRE-approved equipment (e.g., power fuses WMP.459 lightning arresters WMP.550, avian protection equipment WMP.972)</p> <p>Complete Tier 3 overhead hardening efforts including installation of Falling Conductor Protection on 21 circuits within the HFTD areas and ARFS and Power Quality (PQ) meters on 30 circuits within the HFTD areas, continue work on Tier 2 hardening (WMP.1195)</p> <p>Expand the use and development of enhanced inspection technologies such as infrared inspections of overhead distribution (WMP.481), drone assessments (WMP.552), and IIP (WMP.1342) to detect damage and collect data on distribution and vegetation</p> <p>Continue to provide fixed and portable backup power solutions and rebates on portable backup power solutions to residential and commercial customers who experience frequent PSPS.</p>	<p>Complete hardening within the HFTD, begin hardening efforts for high risk WUI areas.</p> <p>Optimize inspection cycles based on risk, end distribution intrusive inspection 10-year cycle, and enhance inspection capabilities to identify high risk assets</p> <p>Replace legacy transmission asset management system with industry standard technology</p>	Section 8.1
Vegetation Management	<p>Complete design and development of new electronic work management system (Epoch) to enhance data management performance. Move all tree inventory data to the Cloud (WMP.511).</p> <p>Continue to implement the vegetation management work plan with enhanced clearances (WMP.501) in high-risk areas, (going above regulatory requirements in HFTD and non-HFTD).</p> <p>Continue Fuels Management Program (WMP.497) to thin flammable vegetation around select poles subject to PRC § 4292 using risk and environmental impact criteria. Pilot alternate methods of thinning such as the cultural use of goats for sustainability goals (WMP.1327).</p>	<p>Continue annual, required, internal contractor training for Hazard Tree, Environmental, Fire Preparedness, and Environmental Regulation. Develop and document internal training material for new Vegetation Management personnel (WMP.506).</p> <p>Continue multiple inspection activities in HFTD including off-cycle patrol (WMP.508) and targeted species. Conduct analyses using RSE and VRI to identify most efficient and effective trimming and removal activities within the HFTD.</p>	Section 8.2
Situational Awareness and Forecasting	<p>Develop full automation in fire detection capabilities.</p> <p>Continue improving existing models (FPI WMP.450, SAWTI WMP.540) by noting and evaluating discrepancies between predictions and observed reality.</p> <p>Partner with academia to explore and evaluate large computational resource to include a module for impact of large eddy scale weather</p>	<p>Explore partnering with local air pollution/quality districts to make data publicly available</p> <p>Continue the production and sharing of forecast products as well as the prioritization of data analytics and modeling. Working with the SDSC, data science advancements will be monitored to ensure that this technology can provide the advanced analytics required to maximize operations.</p>	Section 8.3

WMP Category	Within 3 Years	Within 10 Years	Location in WMP
	Continue to replace and/or update existing weather stations to improve weather data and ultimately provide more accurate forecasting (WMP.443).		
Emergency Preparedness	<p>Expand Emergency Management Operations by increasing staff dedicated to enhancing various emergency programs.</p> <p>Enhance Human Factors Engineering (HFE) into the design of current and future PSPS decision-making tools.</p> <p>Enhance collaboration and engagement with public safety partners and the community through the use of the new Wildfire Climate Resiliency Center (WCRC).</p>	<p>Increase granularity and customization of response plans—augment the Company Emergency and Disaster Preparedness Plan (CEADPP) to include specific plans/continuity of operations/annexes based on the appropriate identified risks.</p> <p>Enhance post event documentation and application of lessons learned to update plans and exercises.</p> <p>Develop Training Environments to better simulate hazards and allow for more realistic exercises and training.</p>	Section 8.4
Community Outreach and Engagement	<p>Continue community outreach and public awareness efforts with year-round wildfire safety education and communication campaign.</p> <p>Refine and augment campaign and notifications for annual public education; expand reach based on customer/stakeholder feedback. Expand public education to AFN, LEP populations and Tribal communities.</p> <p>Continue promotion and amplification of PSPS, wildfire, and readiness messaging through CBO partnership activities.</p> <p>Continue activation of CRCs.</p> <p>Develop Public Safety Partner Mobile Application.</p>	<p>Continued enhancement of mobile apps and communication platforms including school communication platforms.</p> <p>Continue activation of CRCs.</p>	Section 8.5
Public Safety Power Shutoff	<p>Continue improving customer notifications by enhancing the Enterprise Notification System</p> <p>Continue to develop WINGS Ops to assess wildfire risk and study customer impacts of PSPS events.</p>	<p>Explore new platforms and technologies that could improve customer notifications during PSPS events.</p> <p>Incorporate strategic grid design and localization that includes microgrid solutions and location of lines away from highest risk areas.</p>	Section 9

7.2.2 Anticipated Risk Reduction

7.2.2.1 Projected Overall Risk Reduction

For SDG&E's projected overall risk reduction, the overall Wildfire and PSPS risk scores were projected in the service territory. Both Wildfire risk and PSPS risk values used to develop the graph shown in Figure 7-6 are outputs of the WiNGS-Planning model, version 3.0, as described in Section 6.1 Methodology. The estimated overall Wildfire and PSPS risk reduction is based on the effects of planned covered conductor and undergrounding mitigations across the service territory. These effects are used to estimate the long-term overall utility risk reduction from the beginning of 2022 through the end of year 2032.

The scope of work per year is based on mileage targets for covered conductor and undergrounding mitigations. The mitigation selection incorporates work scoped for segments from 2022 to 2024 (based on WiNGS-Planning 1.0 outputs) and segments being scoped for work from 2025 to 2026 (based on WiNGS-Planning 2.0 outputs). For consistency in the long-term risk portfolio, all risk values shown in Figure 7-6 are derived from the WiNGS-Planning 3.0 model released in Q1 2023. In Q3 of 2023, SDG&E transitioned to the latest cloud-based WiNGS-Planning model for scoping.

The overall Wildfire and PSPS risk reduction per year is the sum of the risk reduction values derived from the WiNGS-Planning 3.0 model for the segments planned for covered conductor and undergrounding mitigations. The scoped miles were adjusted to actual target miles to capture the risk reduction per year more accurately. See Section 7.1.4.1.4 Potential Mitigation Initiatives for target mileage for both covered conductor and undergrounding mitigations. Based on these overall Wildfire and PSPS risk estimates derived from the WiNGS-Planning 3.0 model and targeted mileage scope per year, SDG&E estimates a reduction of approximately 80 percent of wildfire risk from the start of 2022 through the end of 2032. This is not including PSPS risk, probability of a PSPS occurring on a segment, and the estimation for climate change impacts to risk reduction.

At this time, SDG&E has assessed potential proxies for estimating the long-term impact of climate change on wildfire risk, not Wildfire and PSPS risk, in its service territory. For this assessment, two suitable proxies were identified: the FWI as calculated by projected meteorological conditions and acres burned as determined through the wildfire simulations available on Cal-Adapt,²⁵ described further below.

The FWI is an established meteorologically-based index used worldwide to estimate fire danger of a certain area. FWI is a unitless index that is scaled so that the higher the score, the more likely conditions are to trigger a wildfire. Inputs into the FWI are temperature, relative humidity, precipitation, and wind conditions. Using 18 global climate models (GCMs), climate conditions are estimated at a 6-kilometer (km)-by-6-kilometer grid cell level to determine the FWI for each grid cell over a range of years.

To use the FWI to assess the climate change impact to wildfire risk over the long-term risk assessment period to 2032, the change in FWI over a baseline period was compared to 2030, with the assumption that 2030 values closely approximate climate conditions in 2032. Specifically, the 95th percentile FWI score for each grid cell was calculated across the full set of historical data within the baseline period. For this assessment, the average territory-wide number of days that surpassed the 95th percentile was used as the basis of comparison between the baseline period and 2030 to estimate change in wildfire risk.

²⁵ https://www.energy.ca.gov/sites/default/files/2019-11/Projections_CCCA4-CEC-2018-014_ADA.pdf

A baseline period of 1975 to 2005 was selected in keeping with climate normal principles of using three decades of data and based on latest historical data available. For this baseline period, the average territory wide number of days in the 95th percentile was calculated to be 18.0 days.

For 2030 and using the RCP 8.5 scenario, the average number of days above the baseline 95th percentile is 20.0 (a 11.11 percent increase from the baseline). The RCP 8.5 scenario was used in keeping with the CPUC guideline²⁶ for utilities to use the RCP 8.5 for planning, investment, and operational purposes.

The climate adaptation vulnerability assessment, required by the Climate Change Adaptation OIR is discussed in Section 5.4.3.2 Social Vulnerability and Exposure to Electrical Corporation Wildfire Risk. There is a slight difference in baseline values used in these analyses (16.9 vs 18.0) because the seasonal baselines are products of the model and the 10-year projection baseline is based off a theoretical notion that the top 5 percent of FWI days will occur on 5 percent of days in a given year which is closely approximated by a value of 18.

The other proxy used was area burned by wildfires as determined through the study “Wildfire Simulations for California’s Fourth Climate Change Assessment: Projecting Changes in Extreme Wildfire Events with a Warming Climate” (Westerling 2018²⁷). Data available for this study is available for use through Cal-Adapt. This model simulates meteorological conditions across four GCMs and two RCP emissions scenarios (RCP 4.5 and RCP 8.5). Cal-Adapt is a clearinghouse for climate data, models and projections, presenting research developed under California’s Fourth Climate Change Assessment. The CPUC has directed that energy utilities shall adhere to at least the same climate scenarios and projections used in the most recently available climate change assessment²⁸. The datasets are made available for use by utilities for the study and analysis of climate impacts, climate risk, and climate vulnerability on utility systems, operations, and customers²⁸.

For its assessment, SDG&E evaluated monthly data from the wildfire simulation study using data from the four GCMs and the RCP 8.5 emissions scenario. For each month in the dataset, the average area burned across all four GCMs was calculated and aggregated into an annual area burned projection. To align with the FWI analysis and to adhere to climate normal principles, a baseline period of 30 years was selected from 1975 to 2005. The average annual area burned as predicted by the model for this period was 17,956 acres.

Based on Cal-Adapt recommendations to not use the projections as a point-in-time estimator, a rolling, centered average was calculated for each year of projection using the previous 4 years, the current year, and the next 4 years of the modeled data. This 9-year rolling, centered average was selected as an appropriate approach to compare historical data to future projections because it is neither inherently forward nor backward looking; the time scale is long enough to capture trending data without surpassing and extending far beyond the 10-year projection; and the current period is not impacted by the extremes of the time scale available in the dataset. The average annual area burned area across the baseline (17,956 acres) was compared against the 2032 rolling, centered average to determine the percent increase in area burned from baseline to 10-year projection. For 2032, the rolling, centered average was 18,957 acres, which equates to a 5.58 percent increase.

²⁶ CPUC decision 19-10-054, October 24, 2019; pg 57

²⁷ https://www.energy.ca.gov/sites/default/files/2019-11/Projections_CCCA4-CEC-2018-014_ADA.pdf

²⁸ CPUC decision 19-10-054, October 24,2019; pg 56

Using the two proxy value increases, 11.11 percent for FWI analysis and 5.58 percent for area burned analysis, SDG&E adjusted the 2032 wildfire risk in the overall risk reduction forecast accordingly. As these impacts were only applied to the wildfire risk and not the PSPS risk, the 11.11 percent FWI analysis increases the overall remaining risk in 2032 from 32.1 percent to 33.9 percent, and the 5.58 percent area burned analysis increases the overall remaining risk in 2032 from 32.1 percent to 33.0 percent. This provides an estimate that considering climate change over the projection period and SDG&E’s current risk mitigation programs, the remaining risk as compared to the end of 2021 will be 33.0 percent to 33.9 percent. This increase does not represent the cumulative climate change impact on wildfire risk; however, it is the residual impact remaining in 2032 after accounting for the effects of Covered Conductor and Strategic Undergrounding Programs (WMP.455 and WMP.473 respectively) through the long-term projection period.

Figure 7-6: Projected Overall Wildfire and PSPS Risk Reduction

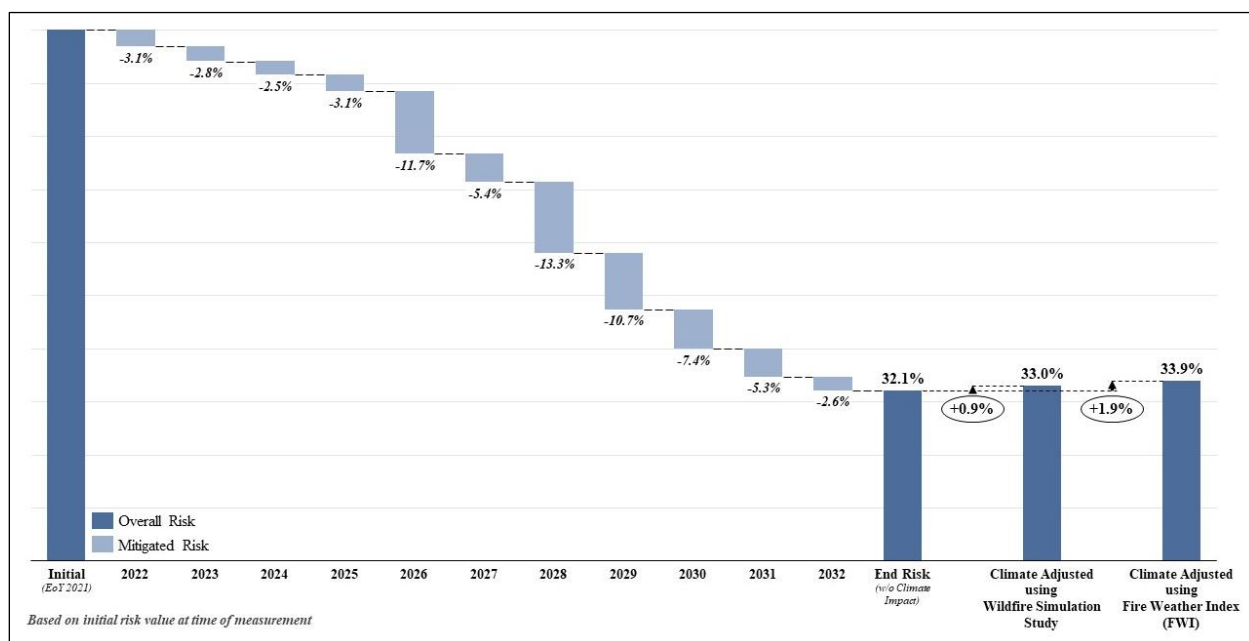

7.2.2.2 Risk Impact of Mitigation Initiatives

SDG&E Table 7-3 shows the wildfire risk reduction projection from the WiNGS-Planning Model for Covered Conductor and Strategic Undergrounding Programs (WMP.455 and WMP.473 respectively). Note that these wildfire risk reduction estimates are based on wildfire hardening target mileage (see Section 7.1.4.1.4 Potential Mitigation Initiatives) and not scoped mileage. The percent impact of risk listed in SDG&E Table 7-3 is calculated using the following formula:

$$\% \text{ Risk Impact} = \frac{\text{risk before} - \text{risk after}}{\text{risk before}} \times 100$$

SDG&E Table 7-3: Wildfire Risk Reduction Projection

Mitigation	Total Risk Start 2023	Risk Mitigated 2023	% Risk Impact 2023	Total Risk Start 2024	Risk Mitigated 2024	% Risk Impact 2024	Total Risk Start 2025	Risk Mitigated 2024	% Risk Impact 2024	Total Risk End 2025
UG Wildfire Risk Mitigation	1531.6	12.6	0.82%	1481.7	30.7	2.07%	1431.2	49.5	3.46%	1372.8
CC Wildfire Risk Mitigation	1531.6	19.1	1.24%	1481.7	16.9	1.14%	1431.2	8.9	0.62%	1372.8

Note: Total Risk includes both undergrounding of electric lines and installation of covered conductor. Numbers are rounded to nearest tenth place and an additional coefficient factor of x10000 is applied to the scores for readability.

7.2.2.3 Projected Risk Reduction on Highest-Risk Circuits Over the Three-Year WMP Cycle

OEIS Table 7-4 shows the risk reduction from WiNGS-Planning model version 3.0 for Covered Conductor and Strategic Undergrounding Programs (WMP.455 and WMP.473 respectively). The Overall Risk is the sum of the Wildfire risk and PSPS risk scores. These projects are based on currently scoped work, note that SDG&E over-scopes above yearly targets to anticipate changes in schedule or scope. Furthermore, some segments found in the list of segments with the highest risk (see Section 6.4.2 Top Risk-Contributing Circuits/Segments/Spans) show the top 5 percent of high-risk segments are currently scoped outside of this WMP cycle for mitigation due to prior hardening, permitting, and/or complexity for these projects, therefore will not be found in OEIS Table 7-4.

OEIS Table 7-4: Summary of Risk Reduction for Top-Risk Circuits

Circuit ID*	Jan. 1, 2023 Overall Risk	Jan. 1, 2023-Dec. 31, 2023 Mitigation Initiatives	Jan. 1, 2024 Overall Risk	Jan. 1, 2024-Dec. 31, 2024 Mitigation Initiatives	Jan. 1, 2025 Overall Risk	Jan. 1, 2025-Dec. 31, 2025 Mitigation Initiatives	Jan. 1, 2026 Overall Risk
237-30R	67.4	n/a	67.4	n/a	67.4	Undergrounding	0
222-1401R	64.8	Undergrounding Covered Conductor	50.3	n/a	50.3	n/a	50.3
524-69R	52.9	n/a	52.9	n/a	52.9	Undergrounding	32.8
222-1364R	48.9	Undergrounding	42.7	n/a	42.7	Undergrounding	0
448-11R	30	Covered Conductor	22.5	Covered Conductor	19.9	n/a	19.9
217-983R	28.7	n/a	28.7	Undergrounding	18.1	n/a	18.1
222-1370R	32.1	Undergrounding	28.3	n/a	28.3	n/a	28.3
358-682F	29.5	Undergrounding	26.4	Undergrounding	21.8	n/a	21.8
157-81R	24.6	n/a	24.6	n/a	24.6	Covered Conductor	20.6
1030-989R	23.8	Covered Conductor	22.6	n/a	22.6	n/a	22.6
73-643R	21.3	Undergrounding	16.3	n/a	16.3	n/a	16.3
1215-32R	19.2	n/a	19.2	Undergrounding	0	n/a	0
220-298R	18.5	Undergrounding	14	n/a	14	n/a	14
217-837R	17	n/a	17	Covered Conductor	17	n/a	17
445-1311R	15	Undergrounding	12.6	Covered Conductor	8.5	n/a	8.5
222-2013R	14.4	Undergrounding	10.6	n/a	10.6	n/a	10.6
521-14R	14.8	n/a	14.8	Covered Conductor	14.7	n/a	14.7

*First column values listed are segment IDs

Note: Utility initiative tracking IDs for Covered Conductor Program Strategic Undergrounding Program are WMP.455 and WMP.473. Numbers are rounded to nearest tenth and an additional coefficient factor of x10000 applied to the scores for readability.

7.2.3 Interim Mitigation Activities

For circuits scheduled for strategic undergrounding or covered conductor installation, interim mitigations are assessed by cross-functional teams to consider the various risks attributed to the electrical infrastructure and initiate corrective actions such as the replacement of high-risk equipment or the implementation of operational procedures. This work is being performed in the HFTD to address wildfire risk and may occur on circuits that are part of the long-term deployment of Covered Conductor or Strategic Undergrounding Programs (WMP.455 and WMP.473 respectively). Projects are limited in size and scope dependent on the type of interim mitigation. See SDG&E Table 7-4 for a summary of interim mitigation initiatives and for more details see the relevant section.

SDG&E Table 7-4: Interim Mitigations Initiatives

Interim Mitigation Initiative	Interim Risk	Goal of Interim Mitigation	Section
Microgrids (WMP.462)	Some customers have a higher potential to be affected by PSPS	Decrease number of customers affected by a PSPS event by constructing Microgrids that can be electrically isolated during PSPS events	8.1.2.7
Sensitive Relay Profile (SRP)	High amount of energy available when faults occur during times of extreme fire risk could lead to ignitions	Change settings to reduce fault energy and fire risk	8.1.2.8.1
Capacitor Maintenance and Replacement (WMP.453)	Some equipment has a higher risk to cause faults which could lead to ignitions	Replace of high-risk equipment	8.1.4.3
Expulsion Fuse Replacements (WMP.459)	Some equipment has a higher risk to cause faults which could lead to ignitions	Replace of high-risk equipment	8.1.4.4
Hotline Clamp Replacements (WMP.464)	Some equipment has a higher risk to cause faults which could lead to ignitions	Replace of high-risk equipment	8.1.4.5
Lightning Arrester Removal and Replacement (WMP.550)	Some equipment has a higher risk to cause faults which could lead to ignitions	Replace of high-risk equipment	8.1.4.6
Strategic Pole Replacement Program (WMP.1189)	Poles nearing the end of their useful life and known to have a higher failure potential	Replace of high-risk equipment	8.1.2.10.2
PSPS Sectionalizing Enhancements (WMP.461)	Large customer counts between sectionalizing devices have more exposure to overhead risk and potential for PSPS	Decrease number of customers affected by a PSPS event by increasing precision of sectionalizing during PSPS events	8.1.2.11.1
Fixed Backup Power Program (WMP.468)	Customers in rural areas have a higher potential to be affected by PSPS	Provide backup power generation during a PSPS event for rural, backcountry residences	8.1.2.11.2
Generator Grant Program (WMP.466)	Some customers have a higher potential to be affected by PSPS	Provide battery backup power; focused on MBL and Life Support customers	8.1.2.11.3

Interim Mitigation Initiative	Interim Risk	Goal of Interim Mitigation	Section
Generator Assistance Program (WMP.467)	Some customers have a higher potential to be affected by PSPS	Provide rebates for portable generators to enhance customer preparedness for PSPS	8.1.2.11.4
Disabling Reclosing in HFTD	High amount of energy available when faults occur during times of extreme fire risk	Reduce the potential for unwanted energy release after fault has occurred	8.1.8.1.2
Contracted Fire Resources (CFRs)	Electric crews risk events while performing work during elevated and extreme conditions	If risk event occurs which leads to an ignition, work to suppress the ignition before it can grow in an attempt to limit the impacts	8.1.8.3.2
PSPS	High wind events and high fire potential	Reduce potential for asset-caused ignitions during extreme weather events	9

8 Wildfire Mitigations

8.1 Grid Design, Operations, and Maintenance

Once a risk mitigation plan is developed and documented, SDG&E uses a comprehensive approach to identify a portfolio of risk mitigation initiatives. This includes identification of detailed design, implementation, operations, and long-term maintenance of mitigations. The fifth step of the Enterprise Risk Management Framework is Risk-Informed Investment Decisions & Risk Mitigation Implementation (see Figure 8-1). See Section 4.4 Risk Informed Framework for details on the Enterprise Risk Management Framework. “

Figure 8-1: Risk-Informed Investment decision & Risk Mitigation Implementation Step of the Enterprise Risk Management Framework



8.1.1 Overview

SDG&E’s grid hardening programs are aimed at reducing the risk of wildfires caused by utility equipment and minimizing impacts to customers from mitigations such as PSPS. Programs such as the Covered Conductor Program (WMP.455) will prevent risk events from occurring across several drivers like energized wire down and foreign object contact. Other programs such as Protection and equipment programs including advanced protection, the Expulsion Fuse Replacement Program (WMP.459), and the Lightning Arrester Program (WMP.550) do not prevent risk events from occurring, but instead reduce the chance that a risk event will result in an ignition by utilizing protection settings and/or equipment that addresses a specific failure mode known to lead to the ignition. Other programs reduce PSPS

impacts to customers, including the PSPS Sectionalizing Program (WMP.461), installation of microgrids (WMP.462), and generator programs. Strategic undergrounding—a system hardening effort—reduces the need for mitigations such as PSPS while also reducing the risk of utility-caused wildfires. SDG&E’s grid hardening programs, operations, and maintenance programs have contributed significantly to the Company earning the ReliabilityOne® Award for “Outstanding Reliability Performance” among utilities in the West for 17 consecutive years.

8.1.1.1 Objectives

OEIS Table 8-1: Grid Design, Operations, and Maintenance Objectives (3-year plan)

Objective Number	Objectives for Three Years (2023–2025)	Applicable Initiative(s), Tracking ID(s)	Applicable Regulations, Codes, Standards, and Best Practices (See Note)	Method of Verification (i.e., program)	Completion Date	Reference (section & page #)
8.1.01	Continue to provide fixed backup power solutions to residential and commercial customers who experience frequent PSPS.	Standby Power Programs; WMP.468	Transmission standard practice (confidential)	Third-party data submission	12/31/2025	8.1.2.11.2, p. 181.
8.1.02	Continue to provide portable backup power solutions to vulnerable, electricity-dependent customers.	Generator Grant Program; WMP.466	Transmission standard practice (confidential)	Third-party data submission	12/31/2025	8.1.2.11.3, p. 184
8.1.03	Continue to provide rebates on portable backup power solutions to customers who experience PSPS.	Generator Assistance Program; WMP.467	Transmission standard practice (confidential)	Third-party data submission	12/31/2025	8.1.2.11.4, p. 185
8.1.04	Build 185 Base Stations to deploy a privately-owned LTE network	Distribution Communications Reliability Improvements; WMP.549	IEEE 802	Completed work orders/Primavera P6 Site Schedule.	12/31/2033	8.1.2.8.3, p. 175
8.1.05	Install avian protection equipment on distribution poles in HFTD	Avian Protection; WMP.972	<ul style="list-style-type: none"> SDG&E Overhead Construction Standard (OHCS) 1600 Migratory Bird Treaty Act Bald and Golden Eagle Protection Act Codes defined by California Department of Fish and Game 	Completed work orders/ GIS Data Submission(s)	12/31/2099 (Ongoing)	8.1.2.10.1, p. 178
8.1.06	Replace existing non-SCADA Capacitors with a more modern SCADA switchable Capacitor or remove non-SCADA Capacitor if not required for voltage or reactive support, to reduce potential for	Capacitor Maintenance and Replacement Program; WMP.453	<ul style="list-style-type: none"> GO 95 SDG&E OHCS 1320 SDG&E OHCS 1325 	Completed work orders/ GIS Data Submission(s)	12/31/2025	8.1.4.3, p. 221

Objective Number	Objectives for Three Years (2023–2025)	Applicable Initiative(s), Tracking ID(s)	Applicable Regulations, Codes, Standards, and Best Practices (See Note)	Method of Verification (i.e., program)	Completion Date	Reference (section & page #)
	fire caused by faulted capacitors in the HFTD and WUI Areas					
8.1.07	Install new CAL FIRE-approved power fuses to replace existing expulsion fuse equipment in the HFTD.	Expulsion Fuse Replacement; WMP.459	<ul style="list-style-type: none"> GO 95 SDG&E OHCS 1207 	Completed work orders/ GIS Data Submission(s)	12/31/2025	8.1.4.4, p. 222
8.1.08	Replace HLC connections that are connected directly to overhead primary conductors with compression connections	Maintenance, repair, and replacement of connectors, including hotline clamps; WMP.464	<ul style="list-style-type: none"> GO 95 SDG&E OHCS 788 	Completed work orders/ GIS Data Submission(s)	12/31/2028	8.1.4.5, p. 224
8.1.09	Install CAL FIRE-approved lightning arresters in the HFTD	Lightning arrester removal and replacement; WMP.550	<ul style="list-style-type: none"> GO 95 SDG&E OHCS 1247 	Completed work orders/ GIS Data Submission(s)	12/31/2099 (Ongoing)	8.1.4.6, p. 226
8.1.10	Install switches in strategic locations improving the ability to isolate high-risk areas for potential de-energizations and minimize PSPS exposure to customers	PSPS Sectionalizing Enhancements; WMP.461	<ul style="list-style-type: none"> GO 95 PU Code Section 451 	Completed work orders/ GIS Data Submission(s)	12/31/2099 (Ongoing)	8.1.2.11.1, p. 181
8.1.11	Test devices that have been installed and identify the devices that do not have sufficient signals and low batteries, so they can be replaced in 2024 and 2025 by new material/WFI devices.	Wireless fault indicators; WMP.449	<ul style="list-style-type: none"> GO 95 SDG&E Electric Standard Practice (ESP) 322 SDG&E OHCS 1276.1 	Completed work orders/ GIS Data Submission(s)	12/31/2028	8.3.3, p. 311
8.1.12	Expand microgrid off-grid solutions in the new Backup Power for Resilience Program	Microgrids; WMP.462	PU Code Section 8370(d)	Completed work orders/ GIS Data Submission(s)	12/31/2099 (Ongoing)	8.1.2.7, p. 167
8.1.13	Utilize strategic undergrounding to reduce or eliminate the threat of wildfire and the use of PSPS mitigation measures during extreme weather events.	Strategic Undergrounding Program; WMP.473	<ul style="list-style-type: none"> GO 95 GO 128 SDG&E Underground Construction Standards (UGCS) SDG&E OHCS Standards 	Completed work orders/ GIS Data Submission(s)	12/31/2099 (Ongoing)	8.1.2.2, p. 158

Objective Number	Objectives for Three Years (2023–2025)	Applicable Initiative(s), Tracking ID(s)	Applicable Regulations, Codes, Standards, and Best Practices (See Note)	Method of Verification (i.e., program)	Completion Date	Reference (section & page #)
			<ul style="list-style-type: none"> • SDG&E Electric Distribution Design Manual • SDG&E Service Standard and Guide • ESP 113.1 – SDG&E Operations & Maintenance Wildland Fire Prevention Plan 			
8.1.14	Install automation equipment on 21 circuits within the HFTD areas, with emphasis on Tier 3.	Falling Conductor Protection, Advanced Protection; WMP.463	<ul style="list-style-type: none"> • SDG&E OHCS 540, 590, 1274 • IEEE 1547-2014, C37.118, 802 • Electronic Industries Alliance (EIA) • International Electrical Commission (IEC) 61850 • Inter-Range Instrumentation Group (IRIG) B Timing Standard • National Electrical Code (NEC) • SDG&E UGCS 3552, 3555, 3560 	Completed work orders/ GIS Data Submission(s)	12/31/2099 (Ongoing)	8.1.4.3, p. 221
8.1.15	Complete installation of advanced radio frequency sensors (ARFS) and Power Quality (PQ) meters on 30 circuits within the HFTD areas, with emphasis on Tier 2 and Tier 3.	Early Fault Detection; WMP.1195	<ul style="list-style-type: none"> • SDG&E OHCS 540, 590, 1274 • IEEE 1159 • Electronic Industries Alliance (EIA) • International Electrical Commission (IEC) 61850 • Inter-Range Instrumentation Group (IRIG) B Timing Standard • National Electrical Code (NEC) • SDG&E UGCS 3552, 3555, 3560 	Completed work orders/ GIS Data Submission(s)	12/31/2099 (Ongoing)	8.1.2.8.2, p. 172
8.1.16	Complete Tier 3 overhead hardening efforts, continue work on Tier 2 hardening.	Overhead Transmission Hardening, WMP.543	GO 95	Completed work orders/ GIS Data Submission(s)	Tier 3 – 12/31/2023 Tier 2 – 12/31/2027	8.1.2.5.2, p. 164

Objective Number	Objectives for Three Years (2023–2025)	Applicable Initiative(s), Tracking ID(s)	Applicable Regulations, Codes, Standards, and Best Practices (See Note)	Method of Verification (i.e., program)	Completion Date	Reference (section & page #)
		Underground Transmission Hardening, WMP.544 Distribution-underbuild, WMP.545				
8.1.17	Utilize data science methodologies to improve data integrity and develop predictive asset health analyses (Asset 360, IIP)	Asset 360, WMP.1341 IIP, WMP.1342	n/a	Technology roadmaps	12/31/2099 (Ongoing)	8.1.5.4, p. 229
8.1.18	Utilize models to develop, enhance, and expand risk-informed strategies for asset management	Integrated Asset management Systems, WMP.1332	n/a	Technology roadmaps	12/31/2099 (Ongoing)	8.1.5.4 p.229
8.1.19	Continue development of Asset 360 data analytics foundation and integration	Asset 360, WMP.1341	n/a	Asset 360 roadmap	12/31/2099 (Ongoing)	8.1.5.4, p. 229
8.1.20	Utilize LiDAR imagery and Intelligent Image Processing (IIP) for inventory of secondary conductor and services	IIP, WMP.1342	n/a	Inventory of secondary and services	12/31/2025	8.1.5.4, p. 229
8.1.21	Begin integrating digital asset imagery collected from drones, LiDAR, and other assessments into Asset 360	Integrated Asset Management Systems, WMP.1332	n/a	Technology roadmaps	12/31/2099 (Ongoing)	8.1.5.4.2, p. 230
8.1.22	Begin assessing accumulated data and utilizing/adopting geospatial platform	Integrated Asset Management Systems, WMP.1332	n/a	Spatial QDR	12/31/2099 (Ongoing)	8.1.5.4, p. 229
8.1.23	Automate creation of corrective work orders (substation)	Substation Patrol Inspections, WMP.492	n/a	Substation system of record	12/31/2022	8.1.3.11, p. 215
8.1.24	Continue infrastructure inspections per regulatory requirements while exceeding requirements in certain high-risk areas (HFTD and WUI)	Distribution Drone Assessments, WMP.552	<ul style="list-style-type: none"> • GO 165 • GO 174 • GO 95 		12/31/2099 (Ongoing)	8.1.3, p. 187

Objective Number	Objectives for Three Years (2023–2025)	Applicable Initiative(s), Tracking ID(s)	Applicable Regulations, Codes, Standards, and Best Practices (See Note)	Method of Verification (i.e., program)	Completion Date	Reference (section & page #)
		Transmission 69 kV Tier 3 Visual Inspections, WMP.555 Distribution infrared Inspections, WMP.481				
8.1.25	Expand the use and development of enhanced inspection technologies such as Infrared inspections of overhead distribution, drone assessments, and IIP to detect damage and collect data on distribution and vegetation	Distribution Infrared Inspections, WMP.481 Transmission Infrared Inspections, WMP.482 Distribution Drone Assessments, WMP.552	n/a	QDR Table 1; QDR Table 2	12/31/2099 (Ongoing)	8.1.3, p. 187 8.1.5.4.3, p. 232
8.1.26	Perform electric distribution drone inspections on 15% of HFTD and WUI structures prioritized on risk	Distribution Drone Assessments, WMP.552	n/a	QDR Table 1	12/31/2099 (Ongoing)	8.1.3.7, p. 202
8.1.27	Continue the implementation of transmission wood pole intrusive inspections on an 8-year cycle (reduced from 10 years)	Transmission Wood Pole Intrusive inspections, WMP.1190	GO 165	QDR Table 1	12/31/2099 (Ongoing)	8.1.3.6, p. 202
8.1.28	Continue intelligent image processing, utilizing artificial intelligence and innovation to detect damage to high fire risk distribution assets and vegetation	IIP, WMP.1342	n/a	IIP roadmap	12/31/2099 (Ongoing)	8.1.5.4.3, p. 232
8.1.29	Regularly perform internal audits of inspections	QA/QC of Distribution Detailed Inspections, WMP.491 QA/QC of Transmission Inspections, WMP.1191 QA/QC of Distribution Drone Assessments, WMP.1192	n/a	QDR Table 1	12/31/2099 (Ongoing)	8.1.6, p. 233

Objective Number	Objectives for Three Years (2023–2025)	Applicable Initiative(s), Tracking ID(s)	Applicable Regulations, Codes, Standards, and Best Practices (See Note)	Method of Verification (i.e., program)	Completion Date	Reference (section & page #)
		QA/QC of Wood Pole Intrusive Inspections, WMP.1193 QA/QC of Substation Inspections, WMP.1194				
8.1.30	Explore and implement virtual reality/augmented reality around the proper operation of field and substation equipment	Workforce Planning-Asset Inspections WMP.1334	n/a	TBD	12/31/2025	8.1.9.1, p. 257
8.1.31	Implement dedicated line inspector program to perform routine inspection types	Workforce Planning-Asset Inspections WMP.1334	n/a	Implementation of Line Inspector job classification	12/31/2023	8.1.9.1, p. 257
8.1.32	Examine electric line crew field personnel and first responder training for possible improvements	Workforce Planning-Asset Inspections WMP.1334	n/a	TBD	12/31/2099 (Ongoing)	8.1.9.1, p. 257

OEIS Table 8-2: Grid Design, Operations, and Maintenance Objectives (10-year plan)

Objective Number	Objectives for Ten Years (2026–2032)	Applicable Initiative(s), Tracking ID(s)	Applicable Regulations, Codes, Standards, and Best Practices (See Note)	Method of Verification (i.e., program)	Completion Date	Reference (section & page #)
8.1.33	Continue to provide fixed backup power solutions to residential and commercial customers who experience frequent PSPS.	Standby Power Programs; WMP.468	Transmission standard practice (confidential)	Third-party data submission	12/31/2099 (Ongoing)	8.1.2.11.2, p. 181
8.1.34	Continue to provide portable backup power solutions to vulnerable, electricity-dependent customers.	Generator Grant Program; WMP.466	Transmission standard practice (confidential)	Third-party data submission	12/31/2099 (Ongoing)	8.1.2.11.3, p. 184

Objective Number	Objectives for Ten Years (2026–2032)	Applicable Initiative(s), Tracking ID(s)	Applicable Regulations, Codes, Standards, and Best Practices (See Note)	Method of Verification (i.e., program)	Completion Date	Reference (section & page #)
8.1.35	Continue to provide rebates on portable backup power solutions to customers who experience PSPS.	Generator Assistance Program; WMP.467	Transmission standard practice (confidential)	Third-party data submission	12/31/2099 (Ongoing)	8.1.2.11.4, p. 185.
8.1.36	Build 550 Base Stations to deploy a privately-owned LTE network	Distribution Communications Reliability Improvements; WMP.549	IEEE 802	Completed work orders/Primavera P6 Site Schedule.	12/31/2028	8.1.2.8.3, p. 175
8.1.37	Install avian protection equipment on distribution poles in HFTD	Avian Protection; WMP.972	<ul style="list-style-type: none"> • SDG&E OHCS 1600 • Migratory Bird Treaty Act • Bald and Golden Eagle Protection Act • Codes defined by California Department of Fish and Game 	Completed work orders/ GIS Data Submission(s)	12/31/2099 (Ongoing)	8.1.2.10.1, p. 178
8.1.38	Install CAL FIRE-approved lightning arresters in the HFTD	Lightning arrester removal and replacement; WMP.550	<ul style="list-style-type: none"> • GO 95 • SDG&E OHCS 1247 	Completed work orders/ GIS Data Submission(s)	12/31/2099 (Ongoing)	8.1.4.6, p. 226
8.1.39	Install switches in strategic locations improving the ability to isolate high-risk areas for potential de-energizations	PSPS Sectionalizing Enhancements; WMP.461	<ul style="list-style-type: none"> • GO 95 • PU Code Section 451 	Completed work orders/ GIS Data Submission(s)	12/31/2032	8.1.2.11.1, p. 181
8.1.40	Expand microgrid off-grid solutions in the new Backup Power for Resilience Program	Microgrids; WMP.462	PU Code Section 8370(d)	Completed work orders/ GIS Data Submission(s)	12/31/2099 (Ongoing)	8.1.2.7, p. 167
8.1.41	Reduce or eliminate the threat of wildfire and the use of PSPS mitigation measures during extreme weather events.	Undergrounding of electric lines and/or equipment; WMP.473	<ul style="list-style-type: none"> • GO 95 • GO 128 • SDG&E UGCS • SDG&E OHCS • SDG&E Electric Distribution Design Manual 	Completed work orders/ GIS Data Submission(s)	12/31/2099 (Ongoing)	8.1.2.2, p. 158

Objective Number	Objectives for Ten Years (2026–2032)	Applicable Initiative(s), Tracking ID(s)	Applicable Regulations, Codes, Standards, and Best Practices (See Note)	Method of Verification (i.e., program)	Completion Date	Reference (section & page #)
			<ul style="list-style-type: none"> • SDG&E Service Standard and Guide • ESP 113.1 – SDG&E Operations & Maintenance Wildland Fire Prevention Plan 			
8.1.42	Complete installation of automated equipment on 82 circuits within the HFTD 2 and 3 areas, with emphasis on completing Tier 3 by 2026.	Falling Conductor Protection; Advanced Protection; WMP.463	<ul style="list-style-type: none"> • SDG&E OHCS 540, 590, 1274 • IEEE 1547-2014, C37.118, 802 • Electronic Industries Alliance (EIA) • International Electrical Commission (IEC) 61850 • Inter-Range Instrumentation Group (IRIG) B Timing Standard • National Electrical Code (NEC) • SDG&E UGCS 3552, 3555, 3560 	Completed work orders/ GIS Data Submission(s)	12/31/2099 (Ongoing)	8.1.4.3, p. 221
8.1.43	Install advanced radio frequency sensors (ARFS) and Power Quality (PQ) meters on 100 circuits within the HFTD areas, with emphasis on Tier 2 and Tier 3.	Early Fault Detection; WMP.1195	<ul style="list-style-type: none"> • SDG&E OHCS 540, 590, 1274 • IEEE 1159 • Electronic Industries Alliance (EIA) • International Electrical Commission (IEC) 61850 • Inter-Range Instrumentation Group (IRIG) B Timing Standard • National Electrical Code (NEC) 	Completed work orders/ GIS Data Submission(s)	12/31/2099 (Ongoing)	8.1.2.8, p. 169

Objective Number	Objectives for Ten Years (2026–2032)	Applicable Initiative(s), Tracking ID(s)	Applicable Regulations, Codes, Standards, and Best Practices (See Note)	Method of Verification (i.e., program)	Completion Date	Reference (section & page #)
			<ul style="list-style-type: none"> SDG&E UGCS 3552, 3555, 3560 			
8.1.44	Complete hardening within the HFTD, begin hardening efforts for high risk WUI areas.	Overhead Transmission Hardening, WMP.543 Underground Transmission Hardening, WMP.544 Distribution-underbuild, WMP.545	GO 95	Completed work orders/ GIS Data Submission(s)	12/31/2026	8.1.2.5.2, p. 164
8.1.45	Enhance data collection of wildfire-related attributes to more granular asset levels with greater frequency	WMP.478, WMP.479, WMP.481, WMP.482, WMP.483, WMP.1190, WMP.552, WMP.488, WMP.489, WMP.555, WMP.492	n/a	TBD	12/31/2099 (Ongoing)	8.1.5.4.1, p. 229 8.1.4.2, p. 220
8.1.46	Evaluate geospatial technology evolution and capability to submit circuit vulnerabilities and automate prioritization to streamline follow-up process.	WMP.478, WMP.479, WMP.481, WMP.482, WMP.483, WMP.1190, WMP.552, WMP.488, WMP.489, WMP.555, WMP.492	n/a	TBD	12/31/2099 (Ongoing)	8.1.5.4.1, p. 229 8.1.4.2, p. 220
8.1.47	Replace legacy transmission asset management system with industry standard technology	WMP.478, WMP.479, WMP.481, WMP.482, WMP.483, WMP.1190, WMP.552, WMP.488, WMP.489, WMP.555, WMP.492	n/a	Transmission system replacement	12/31/2032	8.1.5.2, p. 228
8.1.48	Develop a test case on predictive asset health analyses and risk modeling utilizing integrated asset data to inform asset inspections	WMP.478, WMP.479, WMP.481, WMP.482, WMP.483, WMP.1190, WMP.552, WMP.488, WMP.489, WMP.555, WMP.492	n/a	TBD	12/31/2099 (Ongoing)	8.1.5.4.1, p. 229

Objective Number	Objectives for Ten Years (2026–2032)	Applicable Initiative(s), Tracking ID(s)	Applicable Regulations, Codes, Standards, and Best Practices (See Note)	Method of Verification (i.e., program)	Completion Date	Reference (section & page #)
8.1.49	Optimize inspection cycles based on risk	WMP.478, WMP.479, WMP.481, WMP.482, WMP.483, WMP.1190, WMP.552, WMP.488, WMP.489, WMP.555, WMP.492	GO 165	Evolution of inspection programs and cycles	12/31/2099 (Ongoing)	8.1.3.1, p. 189
8.1.50	End distribution intrusive inspection 10-year cycle	Distribution Wood Pole Intrusive Inspections, WMP.483	GO 165	TBD	12/31/2032	8.1.3.5, p. 199
8.1.51	Enhance inspection capabilities to identify high risk assets	WMP.478, WMP.479, WMP.481, WMP.482, WMP.483, WMP.1190, WMP.552, WMP.488, WMP.489, WMP.555, WMP.492	n/a	TBD	12/31/2099 (Ongoing)	8.1.3, p. 187
8.1.52	Explore LiDAR use cases in advancing QA/QC processes to inform other asset management strategies	Covered Conductor, WMP.455 Strategic Undergrounding, WMP.473	n/a	TBD	12/31/2099 (Ongoing)	8.1.3.12.1, p. 217
8.1.53	Utilize technology such as Asset360 and the development of asset health indices to perform analysis and determine data-driven, risk-informed maintenance and repair strategies.	Integrated Asset Management Systems, WMP.1332	n/a	Development of risk-informed strategies	12/31/2099 (Ongoing)	8.1.4, p. 218 8.1.5.4.1, p. 229
8.1.54	Develop more robust processes, training, and technologies to monitor and validate work performed	WMP.478, WMP.479, WMP.481, WMP.482, WMP.483, WMP.1190, WMP.552, WMP.488, WMP.489, WMP.555, WMP.492	n/a	TBD	12/31/2099 (Ongoing)	8.1.6, p. 233

Objective Number	Objectives for Ten Years (2026–2032)	Applicable Initiative(s), Tracking ID(s)	Applicable Regulations, Codes, Standards, and Best Practices (See Note)	Method of Verification (i.e., program)	Completion Date	Reference (section & page #)
8.1.55	Establish a method to track QA/QC results dependent on replacement of legacy system (transmission) and integrate into a system to be developed in the future.	QA/QC of Transmission Inspections, WMP.1191	n/a	TBD	12/31/2032	8.1.6.1, p. 234

8.1.1.2 Targets

OEIS Table 8-3: Grid Design, Operations, and Maintenance Targets by Year

Initiative Activity	Tracking ID	2023 Target & Unit	% Risk Impact 2023	2024 Target & Unit	% Risk Impact 2024	2025 Target & Unit	% Risk Impact 2025	Method of Verification
Wireless Fault Indicators	WMP.449 (8.3.3)	0 WFIs	0%	300 WFIs	0.3395%	0 WFIs	0%	Completed work order/GIS Data Submission(s)
SCADA Capacitors	WMP.453 (8.1.4.3)	15 capacitors	0.0040%	0 capacitors	0%	0 capacitors	0%	Completed work order/GIS Data Submission(s)
Microgrids	WMP.462 (8.1.2.7)	0 microgrids	0%	4 microgrids	98.8932%	0 microgrids	0%	Completed work order/GIS Data Submission(s)
Advanced Protection	WMP.463 (8.1.2.8.1)	5 circuits	0.5755%	8 circuits	0.9207%	8 circuits	0.9207%	Completed work order/GIS Data Submission(s)
Hotline Clamps	WMP.464 (8.1.4.5)	250 HLCs	0.0309%	250 HLCs	0.0309%	950 HLCs	0.1320%	Completed work order/GIS Data Submission(s)
Standby Power Programs	WMP.468 (8.1.2.11.2)	300 generators	33.33%	300 generators	33.33%	89 generators	19.9105%	Third-party data submission

Initiative Activity	Tracking ID	2023 Target & Unit	% Risk Impact 2023	2024 Target & Unit	% Risk Impact 2024	2025 Target & Unit	% Risk Impact 2025	Method of Verification
Strategic Undergrounding	WMP.473 (8.1.2.2)	84 miles	4.7972%	125 miles	7.1387%	125 miles	7.6234%	Completed work order/GIS Data Submission(s)
Traditional Hardening	WMP.475 (8.1.2.5.1)	1.9 miles	0.0037%	0 miles	0%	0 miles	0%	Completed work orders/GIS Data Submission(s)
Distribution Underbuild	WMP.545 (8.1.2.5.2)	7.1 miles	0.0379%	1 mile	0.0053%	1.8 miles	0.0130%	Completed work order/GIS Data Submission(s)
Lightning Arresters	WMP.550 (8.1.4.6)	1,848 Arresters	0.5099%	1,848 Arresters	0.5099%	1,848 Arresters	0.4681%	Completed work order/GIS Data Submission(s)
Covered Conductor	WMP.455 (8.1.2.1)	60 miles	0.8142%	60 miles	0.8142%	40 miles	0.5428%	Completed work orders/GIS Data Submission(s)
PSPS Sectionalizing	WMP.461 (8.1.2.11.1)	10 switches	16.6667%	10 switches	16.6667%	10 switches	16.6667%	Completed work orders/GIS Data Submission(s)
Avian Protection	WMP.972 (8.1.2.10.1)	200 poles	0.0204%	200 poles	0.0204%	200 poles	0.0204%	Completed work orders/GIS Data Submission(s)
Expulsion fuse replacement	WMP.459 (8.1.4.4)	40 fuses	0.0849%	0 fuses	0%	700 fuses	6.0335%	Completed work orders/GIS Data Submission(s)
Transmission OH Hardening	WMP.543 (8.1.2.5.2)	14.1 miles	0.3982%	10.2 miles	0.2880%	4.64 miles	0.1310%	Completed work orders/GIS Data Submission(s)
Strategic Pole Replacement Program	WMP.1189 (8.1.2.10.2)	60 poles	0.0538%	267 poles	0.2852%	291 poles	0.2747%	Completed work orders/GIS Data Submission(s)

Initiative Activity	Tracking ID	2023 Target & Unit	% Risk Impact 2023	2024 Target & Unit	% Risk Impact 2024	2025 Target & Unit	% Risk Impact 2025	Method of Verification
Early Fault Detection	WMP.1195 (8.1.2.8.2)	60 nodes	2.6493%	60 nodes	2.6493%	60 nodes	3.5297%	Completed work orders/GIS Data Submission(s)
DCRI	WMP.549 (8.1.2.8.3)	35 stations	n/a	60 stations	n/a	42 stations	n/a	Completed work orders/Primavera P6 Site Schedule

OEIS Table 8-4: Asset Inspections Targets by Year

Initiative Activity	Tracking ID	Target End of Q2 2023 & Unit	Target End of Q3 2023 & Unit	End of Year Target 2023 & Unit	% Risk Impact 2023	Target End of Q2 2024 & Unit	Target End of Q3 2024 & Unit	End of Year Target 2024 & Unit	x% Risk Impact 2024	Target End of Q2 2025 & Unit	Target End of Q3 2025 & Unit	End of Year Target 2025 & Unit	% Risk Impact 2025	Method of Verification
Distribution Overhead Detailed Inspections	WMP.478 (8.1.3.1)	8,450	9,650	11,100	1.6258%	14,850	15,350	15450	2.2629%	7,294	10,940	13,275	1.9433%	Asset management system
Transmission Overhead Detailed Inspections	WMP.479 (8.1.3.2)	850	1,672	2,387	1.555%	1,121	1,442	1,960	0.9488%	1,239	1,899	2,479	0.9580%	Asset management system
Distribution Infrared Inspections	WMP.481 (8.1.3.3)	6,343	8,147	9,578	1.5678%	4,766	7,149	9,532	1.5603%	150	300	300	n/a	Asset management system
Transmission Infrared Inspections	WMP.482 (8.1.3.4)	0	0	6,179	0.1848%	0	0	6,179	0.1848%	0	0	7,331	0.1848%	Asset management system
Distribution Wood Pole Intrusive Inspections	WMP.483 (8.1.3.5)	0	50	50	0.0049%	0	0	0	0%	0	344	344	0.03%	Asset management system

Initiative Activity	Tracking ID	Target End of Q2 2023 & Unit	Target End of Q3 2023 & Unit	End of Year Target 2023 & Unit	% Risk Impact 2023	Target End of Q2 2024 & Unit	Target End of Q3 2024 & Unit	End of Year Target 2024 & Unit	x% Risk Impact 2024	Target End of Q2 2025 & Unit	Target End of Q3 2025 & Unit	End of Year Target 2025 & Unit	% Risk Impact 2025	Method of Verification
Transmission Wood Pole Intrusive Inspections	WMP.1190 (8.1.3.6)	0	0	73	n/a	0	0	0	n/a	50	75	114	n/a	Asset management system
Distribution Drone Assessments	WMP.552 (8.1.3.7)	6,848	10,270	13,692	14.1108%	6,548	9,822	13,500	13.9129%	4,500	9,000	13,500	13.9129%	Asset management system
Distribution Overhead Patrol Inspections	WMP.488 (8.1.3.8)	61,800	86,500	86,880	4.3853%	71,047	83,247	86,197	4.3508%	70,756	83,236	86,535	4.3679%	Asset management system
Transmission Overhead Patrol Inspections	WMP.489 (8.1.3.9)	6,008	6,008	6,337	0.0298%	6,008	6,008	6,337	0.0298%	3,766	5,650	7,533	0.0298%	Asset management system
Transmission 69kV Tier 3 Visual Inspections	WMP.555 (8.1.3.10)	0	1,632	1,632	0.0193%	0	1,632	1,632	0.0193%	0	1,632	1,632	0.0193%	Asset management system
Substation Patrol Inspections	WMP.492 (8.1.3.11)	192	281	384	n/a	192	281	384	n/a	189	277	384	n/a	Asset management system

8.1.1.3 Performance Metrics

Performance metrics rely on data from a variety of systems. The Ignition Management Program (IMP) (WMP.558) is considered a foundational component of grid design operations and maintenance. This activity alone does not mitigate the risk of wildfire but is critical in understanding the overall wildfire risk in relation to SDG&E equipment assets. See Section 8.1.2.12.2 for details on the IMP.

OEIS Table 8-5: Grid Design, Operations, and Maintenance Performance Metrics Results by Year

Performance Metrics	2020	2021	2022	2023 Projected	2024 Projected	2025 Projected	Method of Verification
Distribution Equipment-caused ignitions HFTD	14	6	3	2.73	2.31	2.27	QDR Table 6
Transmission Equipment-caused ignitions HFTD	1	0	0	0.2	0.2	0.2	QDR Table 6
Distribution Equipment-caused outages HFTD	134	164	131	135.42	128.96	120.39	QDR Table 5
Transmission Equipment-caused outages HFTD	5	3	3	3.3	3.13	3.13	QDR Table 5
Distribution inspection findings HFTD	7,565	7,815	7,367	2,250	2,250	2,250	QDR Table 2
Distribution open work orders HFTD	2,734	6,507	8,865	5,000	2,000	2,000	QDR Table 2
Transmission inspection findings HFTD	414	312	515	412	412	412	QDR Table 2
Transmission open work orders HFTD	313	195	165	180	180	180	QDR Table 2

8.1.1.3.1 Distribution Inspection Findings and Open Work Orders

SDG&E’s distribution inspection findings have been relatively constant prior to the 2019 WMP, as shown in Figure 8-2. Since then, there has been a clear increase in the number of inspection findings and the number of open work orders within the HFTD. This increase is directly attributable to additional inspections being performed in the HFTD, specifically drone inspections that began in 2019.

The Drone Investigation, Assessment and Repair (DIAR) Program (WMP.552) performed inspections on every HFTD overhead distribution structure between 2019 and 2022. As a result, SDG&E saw an increased rate of DIAR Program findings of about 25 percent compared to approximately 6 percent for ground-based inspections. The above-average influx of open work orders generated from these additional drone inspections is being prioritized and corrected. All 216 emergency items have been repaired and closed and SDG&E continues to work through the lower priority and non-critical items that have been identified. The number of findings from drone inspections is expected to stabilize as the DIAR Program revisits poles that have been previously inspected by drone. The DIAR Program will be inspecting 15 percent of the structures within the HFTD each year, and the finding rate is expected to drop from 25 percent to approximately 15 percent for future inspections.

Figure 8-2: Distribution Inspection Findings and Open Work Orders

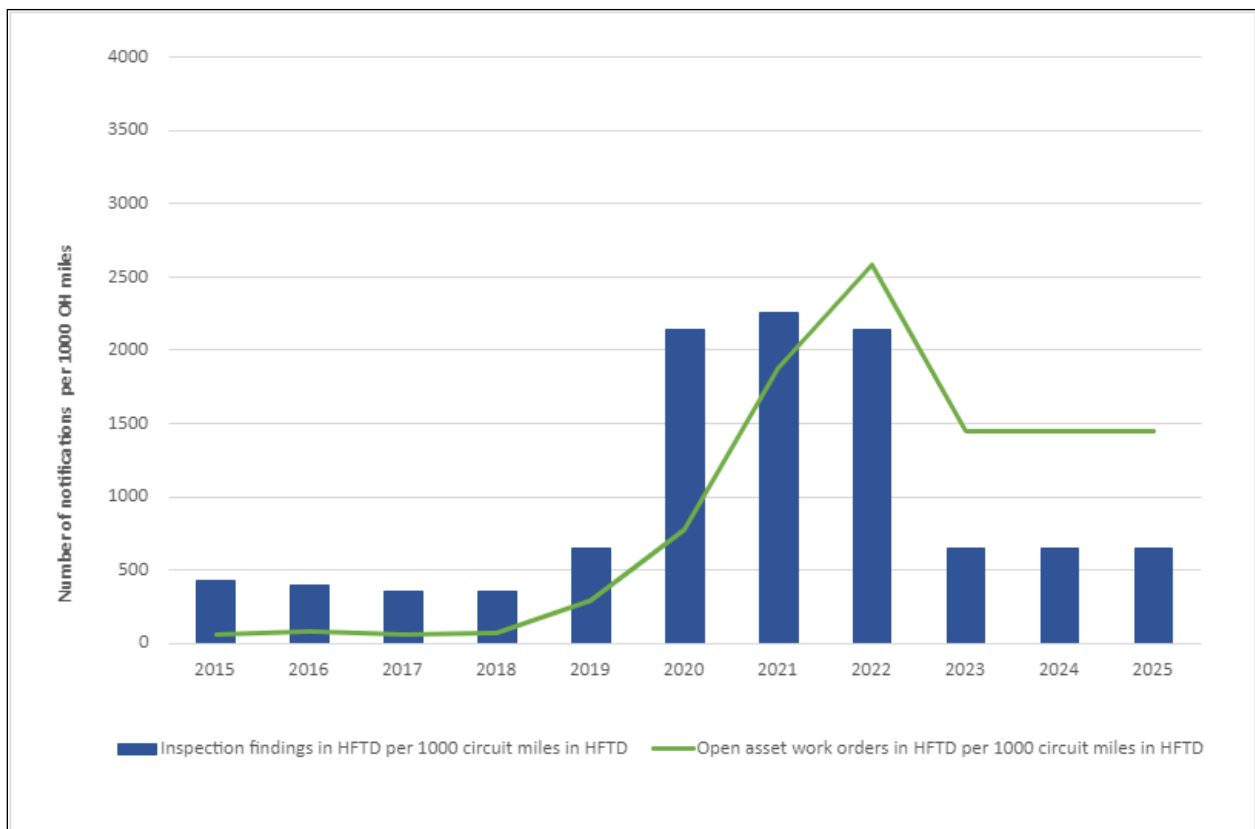

8.1.1.3.2 Distribution Equipment related HFTD Ignitions and Outages Rate

Outage and ignition data has been normalized to events that occur within the HFTD during days with an FPI rating of elevated or extreme (collectively termed “high FPI day”) per the number of high FPI days. This normalization provides a way to review risk events and ignitions that occur during times when wildfire risk is highest, and normalizes them according to the number of days when high wildfire risk days was present. On average, SDG&E has 1.09 overhead outages in the HFTD during high FPI conditions per high FPI day. As shown in Figure 8-3, this rate has been above normal since 2019 although a downward trend was observed in 2022. The spike in 2021 can be explained by the higher-than-normal number of lightning events experienced that year. Despite this increase in lightning events, the number of equipment-related ignitions remained low. Equipment related outages have been relatively flat outside of an increase in 2020 due to a prolonged heat event. The heat event which drove the equipment failures also explains the above average number of equipment-related ignitions in 2020. SDG&E recorded zero equipment-related ignitions in the HFTD during high FPI conditions even though the number of overhead distribution outages was above average. Although this is just one year, SDG&E will continue to monitor this trend as it demonstrates the effectiveness of the grid design, operations, and maintenance initiatives.

Figure 8-3: Distribution Equipment related HFTD Ignitions and Outages Rate

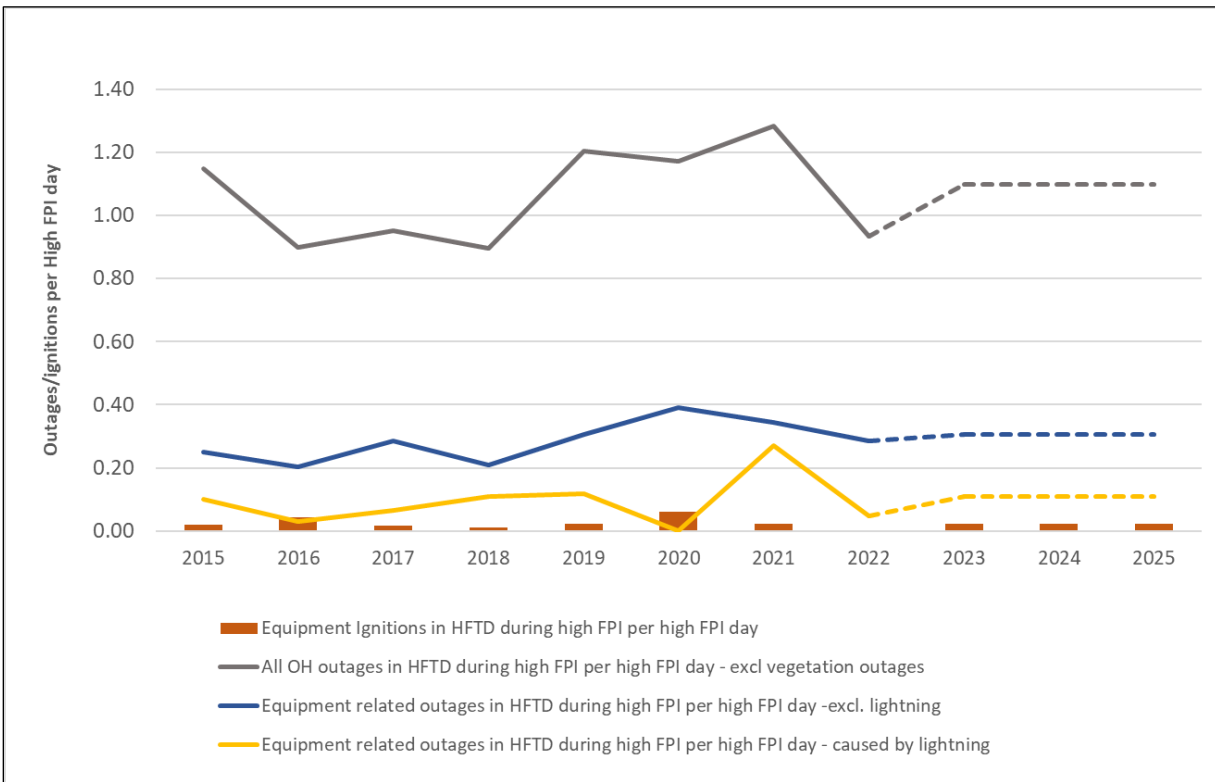

8.1.1.3.3 Transmission Inspection Findings and Open Work Orders in HFTD

Transmission inspections averaged 365 findings per 1,000 HFTD circuit miles in the HFTD over the past 8 years. As shown in Figure 8-4, the number has some fluctuations, but recently has remained steady

demonstrating that the transmission maintenance practice is a mature and effective program. On average, less than 1 percent of the findings identified are Level 1 conditions and approximately 90 percent are Level 2 conditions. The number of open work orders in the HFTD has also remained steady over recent history with a decline in the number of open work orders over the past 3 years. SDG&E forecasts that the number of findings and open work orders will remain at or near current levels for the next 3 years.

Figure 8-4: Transmission Inspection Findings and Open Work Orders in HFTD

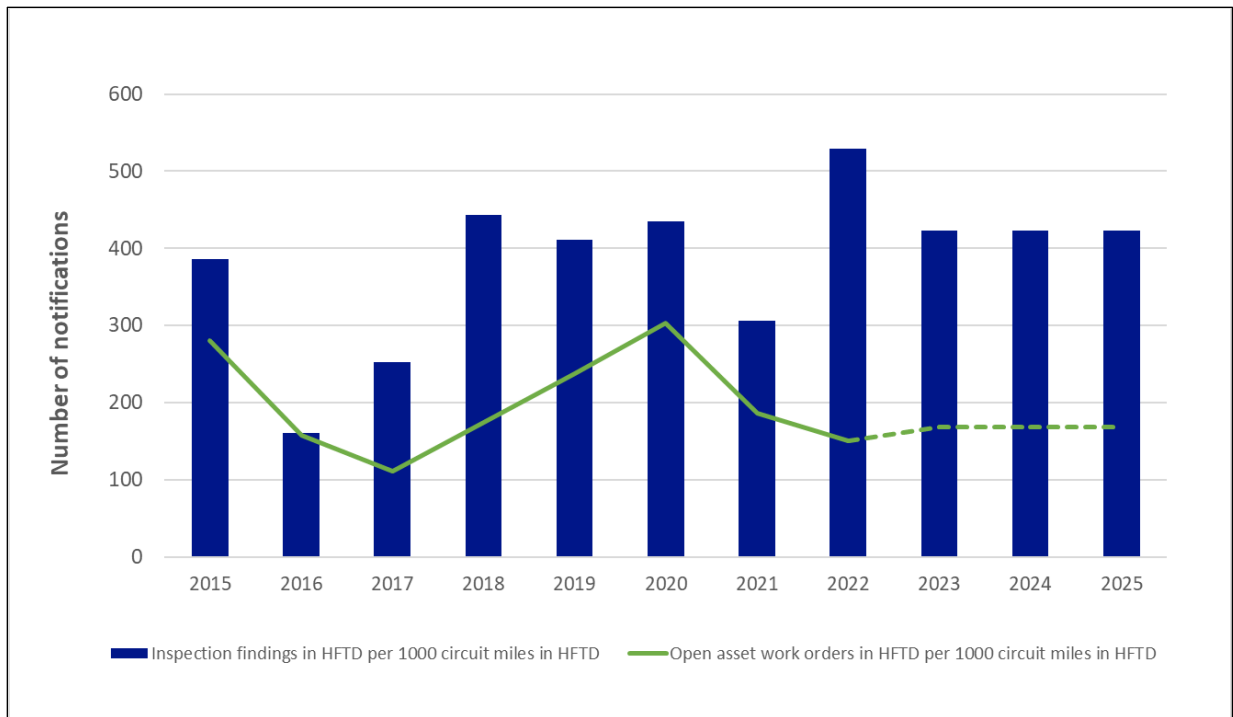

8.1.1.3.4 Transmission Equipment related HFTD Outages and Ignitions

SDG&E’s transmission system has been a relatively low source of wildfire risk over the past 8 years. As shown in Figure 8-5, there has been a clear downward trend in the number of equipment-related outages in the HFTD per 1,000 overhead circuit miles. This is in line with SDG&E’s studies on the effectiveness of its Transmission Overhead Hardening Program (WMP.543), which has been estimated to be 84 percent.

SDG&E has only recorded two instances of transmission equipment-related ignitions in the HFTD over the past 8 years. Again, this result demonstrates the effectiveness of SDG&E’s efforts to harden the transmission system over the past 10 years.

Figure 8-5: Transmission Equipment related HFTD Outages and Ignitions

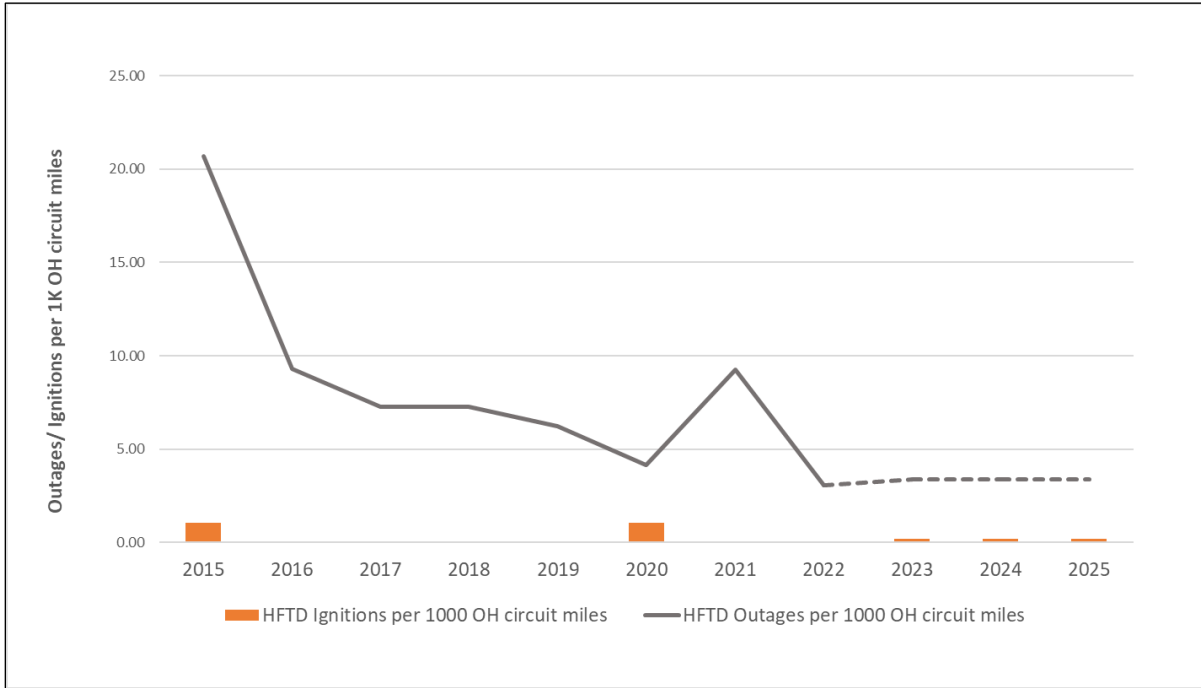

8.1.2 Grid Design and System Hardening

8.1.2.1 Covered Conductor Installation (WMP.455)

8.1.2.1.1 Utility Initiative Tracking ID

WMP.455

8.1.2.1.2 Overview of the Activity

SDG&E operates and maintains nearly 3,500 miles of overhead distribution circuit miles within the HFTD. This infrastructure was originally designed to meet GO 95 requirements of 8 pounds per square foot (psf) or 55 miles per hour (mph) transverse wind load for elevations below 3,000 feet and 6 psf or 48 mph transverse wind load with a half inch of radial ice on conductor for elevations above 3,000 feet. Wind speeds can meet or exceed 85 mph in certain areas of the HFTD. Aging infrastructure, combined with these extreme weather conditions, can increase the possibility of equipment failure on these lines. Further, high winds and outdated design techniques make these lines more vulnerable to foreign object in line contacts, both risk events that could lead to ignitions. To support its initial wildfire resiliency and hardening efforts, SDG&E performed a study to calculate design wind speeds such that SDG&E infrastructure could withstand potential extreme wind events. Infrastructure must be designed to a higher wind speed to allow for a design and safety factor. Based on the study, design wind speeds for infrastructure to withstand the impacts of wind speeds over 85 mph with a max of 111 mph were adopted.

The Covered Conductor Program (WMP.455) is a program that replaces bare conductors with covered conductors in the HFTD. Covered conductors are manufactured with an internal semiconducting layer and external insulating ultraviolet-resistant layers to provide incidental contact protection.

Covered conductor is a widely accepted term to distinguish from bare conductor. The Covered Conductor Program has the potential to raise the threshold for PSPS events to higher wind speeds compared to bare conductor hardening; however, as of the end of 2022 no circuits have been fully hardened with covered conductor and therefore the threshold for PSPS events has not been raised on any circuits with covered conductor installed. RSE calculations developed in the WiNGS-Planning model are utilized to prioritize installation within the HFTD.

Targets for 2023 and performance metrics for 2022 are provided in Section 8.1.1.2 Targets and Section 8.1.1.3 Performance Metrics respectively.

8.1.2.1.3 Impact of the Activity on Wildfire Risk

Over the 3-year period of the 2023 WMP cycle, the Covered Conductor Program (WMP.455) is expected to reduce 0.246 ignitions. This estimate is derived by evaluating different causes of ignitions using 5-year ignition data from 2017 to 2021 and estimating a potential reduction for each cause. The effectiveness of the Covered Conductor Program varies based on each ignition cause (e.g., ignitions caused by animal contact, balloon contact, and vegetation contact have an estimated reduction of approximately 90 percent while ignitions caused by vehicle contact have an estimated reduction of 0 percent). This results in an overall effectiveness estimate of 65 percent. Calculations are shown in SDG&E Table 8-1.

SDG&E Table 8-1: Risk reduction estimation of the Covered Conductor Program

Calculation Component	Component Value
Pre-mitigation risk events per 100 miles Tier 3	8.81
Pre-mitigation risk events per 100 miles Tier 2	8.1
Effectiveness Estimate	65.00%
Post-mitigation risk events per 100 miles Tier 3	$8.81 - (65\% \times 8.81) = 3.08$
Post-mitigation risk events per 100 miles Tier 2	$8.10 - (65\% \times 8.10) = 2.835$
Ignition rate in Tier 3	2.91%
Ignition rate in Tier 2	2.56%
Pre-mitigation Tier 3 ignitions per 100 miles	$8.81 \times 2.91\% = 0.2564$
Pre-mitigation Tier 2 ignitions per 100 miles	$8.1 \times 2.56\% = 0.207$
Post-mitigation Tier 3 ignitions per 100 miles	$3.08 \times 2.91\% = 0.089628$
Post-mitigation Tier 2 ignitions per 100 miles	$2.835 \times 2.56\% = 0.072576$
Ignitions reduced in Tier 3 per 100 miles	$0.2564 - 0.089628 = 0.1668$
Ignitions reduced in Tier 2 per 100 miles	$0.207 - 0.072576 = 0.134244$
Miles of mitigation in Tier 3 (2023-2025)	97
Miles of mitigation in Tier 2 (2023-2025)	63
Ignitions reduced in Tier 3 Post Mitigation	$97 \times (0.1668/100) = 0.161796$
Ignitions reduced in Tier 2 Post Mitigation	$63 \times (0.134244/100) = 0.084574$
Total Ignition Reduction Estimate	$0.161796 + 0.084574 = 0.24637$

8.1.2.1.4 Impact of the Activity on PSPS Risk

The Covered Conductor Program (WMP.455) has the potential to raise the threshold for PSPS events to higher wind speeds compared to bare conductor hardening; however, as of the end of 2022 no circuits have been fully hardened with covered conductor and therefore the threshold for PSPS events has not been raised on any circuits with covered conductor installed. Based on benchmarking with other IOUs and SDG&E's testing of covered conductors, the PSPS wind speed threshold for fully covered circuit segments is expected to be set to between 55 and 60 mph. As discussed in the response to Areas for Continued Improvement SDGE-22-11 in Appendix D, SDG&E expects to complete covered conductor testing and finalize this threshold by December 2023.

8.1.2.1.5 Updates to Initiative

In 2022 SDG&E continued its participation in the covered conductor effectiveness workstream in collaboration with other utilities. The goal of the workstream collaboration is to provide a common effectiveness value for covered conductor and a long-term plan to continually update the data sets that inform this value in respective WMPs. Progress is also expected on comparing the covered conductor mitigation to alternatives, determining the covered conductor mitigation's ability to reduce the need for PSPS (in comparison to alternatives), and developing an initial assessment of the differences in costs. For further discussion regarding the effectiveness of covered conductors, see response to Areas for Continued Improvement Statement SDGE-22-12 in Appendix D. For more information on applying joint lessons learned from the covered conductor effectiveness joint study see response to Areas for Continued Improvement Statement SDGE-22-11 in Appendix D.

As covered conductors become a larger part of the system, performance indicators that impact the efficacy of this mitigation will continue to be monitored and measured, including the measured effectiveness (number of faults per operating year per mile relative to the unhardened system averages) and the cost per mile. SDG&E will also continue to participate in the joint IOU covered conductor workstreams to further develop the estimated and calculated effectiveness of covered conductor.

8.1.2.2 Undergrounding of Electric Lines and/or Equipment (WMP.473)

8.1.2.2.1 Utility Initiative Tracking ID

WMP.473

8.1.2.2.2 Overview of the Activity

SDG&E operates and maintains nearly 3,500 miles of overhead distribution circuit miles within the HFTD. This infrastructure was originally designed to meet GO 95 requirements of an 8 psf or 55 mph transverse wind load, however winds can exceed 85 mph in certain areas of the HFTD during extreme Santa Ana conditions. Aging infrastructure also makes the remaining lines more susceptible to equipment failures during high winds and outdated design techniques make these lines more vulnerable to foreign object in line contacts, all of which could lead to ignitions.

The Strategic Undergrounding Program (WMP.473) is a program that converts overhead systems to underground, providing the dual benefits of significantly reducing wildfire risk and the need for PSPS events in these areas. Strategic undergrounding is deployed in the HFTD as well as in areas where substantial PSPS-event reductions can be gained through strategic installation of the underground electric system.

Data on historic PSPS events, wind conditions, and others are reviewed to determine where undergrounding will have the largest impact. Constraints such as environmental, permitting, and design are also taken into consideration. RSE calculations developed in the WiNGS-Planning model are also utilized to prioritize undergrounding within the HFTD.

Strategic undergrounding is the most expensive major hardening alternative on a per mile basis, therefore undergrounding is strategically deployed. For more information on Undergrounding RSE, see response to Areas for Continued Improvement Statement SDGE-22-15 in Appendix D.

Targets for 2023 and performance metrics for 2022 are provided in Section 8.1.1.2 Targets and Section 8.1.1.3 Performance Metrics respectively.

8.1.2.2.3 Impact of the Activity on Wildfire Risk

To calculate the wildfire risk reduction for the Strategic Undergrounding Program (WMP.473), data on historical ignitions associated with underground equipment, pre-mitigation overhead system risk event rate and ignitions rates, and underground mileage to be completed within the current 3-year period of the WMP cycle were analyzed. Specifically, the effectiveness of strategic undergrounding was measured by taking total CPUC-reportable ignitions associated with undergrounding and dividing by total ignitions. Based on this analysis, strategic undergrounding is expected to reduce 0.765 ignitions by the end of 2025.

Calculations are shown in SDG&E Table 8-2.

SDG&E Table 8-2: Risk Reduction Estimation for the Strategic Undergrounding Program

Calculation Component	Component Value
Pre-mitigation risk events per 100 miles Tier 3	8.81
Pre-mitigation risk events per 100 miles Tier 2	8.1
Undergrounding effectiveness	98%
Ignition rate in Tier 3	2.91%
Ignition rate in Tier 2	2.56%
Miles of mitigation in Tier 3 (2023-2025)	180
Miles of mitigation in Tier 2 (2023-2025)	154
Per Mile Baseline	100
Ignitions reduced in Tier 3	$(180 \div 100) \times 8.81 \times 2.91\% \times 98\% = 0.452$
Ignitions reduced in Tier 2	$(154 \div 100) \times 8.1 \times 2.56\% \times 98\% = 0.313$
Total Ignition Reduction Estimate	$0.452 + 0.313 = 0.765$

8.1.2.2.4 Impact of the Activity on PSPS Risk

Circuit segments that are fully undergrounded back to the substation source are no longer considered to have a PSPS risk. Undergrounding of electric lines is estimated to reduce PSPS impacts for 3,300 customers from 2023 to 2025.

In 2023, a customer impact study was started to examine how the two most effective grid hardening initiatives, strategic undergrounding and covered conductor, affect PSPS customer impact reduction. To date, three approaches to the study have been attempted with varying results. All three approaches look at the most impactful PSPS de-energization event, which affected 73,000 customers in December 2020, with current conditions to see how accomplishments from these two grid hardening initiatives would reduce PSPS impacts to the same group of customers if the same weather event were to occur annually.

In the most exact approach to the study, weather stations connected to de-energized segments from the December 2020 PSPS de-energization were matched to the segment structure in 2023. These matched segments and their associated 73,000 customers serve as the study population. The actual and planned hardening of these segments, which includes both undergrounding and covered conductor, was then compared to a hypothetical covered conductor only hardening in terms of annual customer impact.

Preliminary results in Figure 8-6 show that if the 2020 PSPS event hypothetically occurred annually, undergrounding of electric lines combined with covered conductor installation on these segments would reduce annual PSPS impacts for more customers than covered conductor installation alone. By 2031, PSPS impacts would be reduced for approximately 34% or 24,643 of the 73,000 affected customers when considering both strategic undergrounding of electric lines and covered conductor installation mitigations. Alternatively, if only covered conductor mitigations are considered, preliminary results show that by 2031, PSPS impacts would be reduced for approximately 26% or 18,908 of the 73,000 affected customers.

Figure 8-6: Projected PSPS Impact Reduction

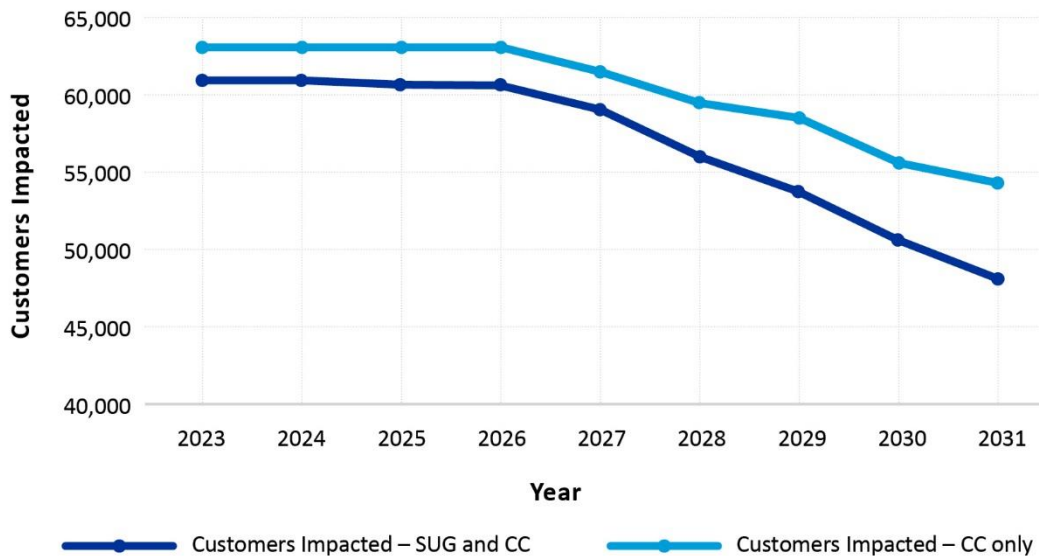

8.1.2.2.5 Updates to the Activity

Enhancements in 2023 will include:

- Implement various types of equipment such as trenchers and rock saws to reduce the cost of civil construction, especially in rocky terrains.

- Benchmark with neighboring utilities on different construction methods and design guidelines to improve existing design deliverables.
- Continue to look for ways to reduce trench dimensions where possible to reduce costs and schedule impacts.
- Partner with neighboring utilities strategically to tackle permit delays with Caltrans.
- Partner with communication entities such as Cox and Caltrans middle mile projects on the broadband initiatives where opportunities exist to joint trench.
- Create permitting strike team to manage and expedite WMP-related permitting and agency approvals.
- Re-evaluate Strategic Undergrounding Program (WMP.473) contracting strategy to address resource constraints and workload increase. On board a contracted alliance partner to help support the expansion of the overall program and create a robust PMO to support significantly scaling up the program to meet the increase volume of work.

Over the next 10 years, the scope of the Strategic Undergrounding Program is expected to increase as the understanding of costs and constraints improve. Installations in the HFTD remain challenging due to difficult terrain, environmental constraints, permitting timelines, and acquisition of easements and land rights. Facilitating productive engagement with stakeholders in the telecommunication field will help streamline resources and obtain more support for undergrounding efforts. Lessons learned from each year’s undergrounding accomplishments will help alleviate constraints through process improvements and stakeholder engagement.

For further discussion regarding the Strategic Undergrounding Program, see response to Areas for Continued Improvement SDGE-22-15 in Appendix D.

8.1.2.3 Distribution Pole Replacements and Reinforcements (WMP.458)

8.1.2.3.1 Utility Initiative Tracking ID

WMP.458

8.1.2.3.2 Overview of the Activity

The Distribution Pole Replacement and Reinforcement Program (WMP.458) is a program that replaces deteriorated wood distribution poles and other asset-related components identified through inspection programs (e.g., Corrective Maintenance Program (CMP) and wood pole intrusive inspections WMP.1190 and WMP.483) to reduce the risk of ignitions. See Section 8.1.3 Asset Inspections Asset Inspections and 8.1.7 Open Work Orders for more information on inspection programs and corrective work.

Replaced poles are constructed to site-specific design criteria (e.g., wood poles will be replaced with steel poles that meet the known local wind conditions of a particular area). Power Line Systems – Computer Aided Drafting and Design (PLS-CADD) modeling is used to design pole replacement work in the HFTD. In addition, pole loading calculations are reviewed by a designated engineering team.

For poles identified in Tier 3 of the HFTD, replacement is accelerated faster than the 6-month timeframe required by GO 95. In addition to pole replacement, any other identified issues are remediated to clear potential infractions and vulnerabilities in the system. All distribution pole replacements are audited by Civil/Structural Engineering. This audit can consist of desktop and/or field audits. Any issues found are routed back to the district or contractor who performed the work for resolution.

8.1.2.3.3 Impact of the Activity on Wildfire Risk

By replacing deteriorated wood distribution poles, this program reduces the likelihood of equipment failures which could lead to an ignition. This initiative does not have its own Risk Reduction Estimation Methodology because its risk reduction is included with asset inspection programs. Risk Reduction Estimation Methodology for asset inspection programs is provided in Section 8.1.3 Asset Inspections.

8.1.2.3.4 Impact of the Activity on PSPS Risk

The Distribution Pole Replacement and Reinforcement Program (WMP.458) focuses on reducing wildfire risk. It has no impact on the risk of PSPS.

8.1.2.3.5 Updates to the Activity

The Distribution Pole Replacement and Reinforcement Program (WMP.458) does not have specific targets set as all replacement work is reactive and based on findings from asset inspection programs. Proactive pole replacements are performed with other grid hardening initiatives. No changes were made to this Program in 2022 and none are expected to be made in 2023.

8.1.2.4 Transmission Pole/Tower Replacements and Reinforcements (WMP.472)

8.1.2.4.1 Utility Initiative Tracking ID

WMP.472

8.1.2.4.2 Overview of the Activity

The Transmission Pole/Tower Replacement and Reinforcement Program (WMP.472) is a program that replaces deteriorated wood transmission poles and other asset-related components identified through inspection programs (e.g., CMP and wood pole intrusive inspections WMP.1190 and WMP.483) to reduce the risk of ignitions. See Section 8.1.3 Asset Inspections Asset Inspections and 8.1.7 Open Work Orders for more information on inspection programs and corrective work.

Replaced poles are constructed to site-specific design criteria (e.g., wood poles will be replaced with steel poles that meet the known local wind conditions of a particular area). PLS-CADD modeling is used to design pole replacement work in the HFTD. In addition, pole loading calculations are reviewed by a designated engineering team.

Poles identified for replacement in Tier 3 of the HFTD are accelerated to a 6-month timeframe required by GO 95. In addition to pole replacement, other issues are identified and prioritized to remediate potential infractions and vulnerabilities in the system.

8.1.2.4.3 Impact of the Activity on Wildfire Risk

By replacing deteriorated transmission poles, this program reduces the likelihood of equipment failures which could lead to an ignition. This initiative does not have its own Risk Reduction Estimation Methodology because its risk reduction is included with asset inspection programs. Risk Reduction Estimation Methodology for those programs is provided in Section 8.1.3 Asset Inspections.

8.1.2.4.4 Impact of the Activity on PSPS Risk

The Transmission Pole/Tower Replacement and Reinforcement Program focuses on reducing wildfire risk. It has no impact on the risk of PSPS.

8.1.2.4.5 Updates to the Activity

The Transmission Pole/Tower Replacement and Reinforcement Program does not have specific targets set as all replacement work is reactive and based on findings from the various asset inspection programs. Proactive pole/tower replacements are performed with other grid hardening initiatives. No changes were made to this Program in 2022 and none are expected to be made in 2023.

8.1.2.5 Traditional Overhead Hardening

8.1.2.5.1 Distribution Overhead System Hardening (Traditional) (WMP.475)

Utility Initiative Tracking ID

WMP.475

Overview of the Activity

SDG&E operates and maintains nearly 3,500 miles of overhead distribution circuit miles within the HFTD. This infrastructure was originally designed to meet GO 95 requirements of an 8 psf or 55 mph transverse wind load, however winds can exceed 85 mph in certain areas of the HFTD during extreme Santa Ana conditions. Aging infrastructure makes lines more susceptible to equipment failures and outdated design techniques make these lines more vulnerable to foreign object in line contacts during high winds, all of which could lead to ignitions.

The ESH Program (WMP.459, WMP.453, WMP.550, WMP.464) (previously the FiRM, PRiME, and WISE programs) is a program whose scope includes the replacement of wood poles with steel, the replacement of conductors with uncovered or covered conductors, and in some cases the permanent removal of overhead facilities. It targets fire prone areas including the HFTD and WUI.

The consolidation of overhead hardening programs into the ESH Program resulted in the execution of projects based on a circuit-by-circuit approach that weighs risk inputs alongside the need to reduce PSPS impacts, rather than scoping projects based on specific wire or at-risk poles. Combining overhead distribution hardening programs makes project engineering, design, construction, and management more efficient and minimizes impacts to customers during job walks, construction, and post construction close-out activities.

In 2021, the WiNGS-Planning model was introduced. Traditional Hardening work that was started prior to this model is expected to be completed by 2024 and any new work that is scoped will be developed utilizing the WiNGS-Planning model. Completion of approximately 1.9 miles is expected in 2023 and approximately 0.6 miles is expected in 2024. Currently, the ESH Program is not expected to continue in 2025 or beyond.

Targets for 2023 and performance metrics for 2022 are provided in Section 8.1.1.2 Targets and Section 8.1.1.3 Performance Metrics respectively.

Impact of the Activity on Wildfire Risk

To determine the estimated ignition reduction for overhead system hardening, data on average historical pre-mitigation risk events, mitigation effectiveness, historical ignition rates, and the amount of overhead hardening planned to be completed in the 2023 to 2025 timeframe of the WMP cycle was

analyzed. Based on this analysis, the ESH Program is estimated to reduce ignitions by 0.00048 by the end of 2025. Calculations are shown in SDG&E Table 8-3.

SDG&E Table 8-3: Risk Reduction Estimation for Distribution Overhead Hardening

Calculation Component	Component Value
Pre-mitigation risk events per 100 miles Tier 3	8.8
Pre-mitigation risk events per 100 miles Tier 2	8.1
Post-mitigation risk events per 100 miles Tier 3	6.9
Post-mitigation risk events per 100 miles Tier 2	3.3
Ignition rate in Tier 3	2.91%
Ignition rate in Tier 2	2.56%
Risk events reduced Tier 3	$8.8 - 6.9 = 1.9$
Risk events reduced Tier 2	$8.1 - 3.3 = 4.8$
Miles of mitigation in Tier 3	1.5
Miles of mitigation in Tier 2	0.4
Per Mile Baseline	100
Effectiveness estimate Tier 3	22%
Effectiveness estimate Tier 2	60%
Ignitions reduced in Tier 3	$(1.5 \div 100) \times 1.9 \times 2.91\% \times 22\% = 0.000182$
Ignitions reduced in Tier 2	$(0.4 \div 100) \times 4.8 \times 2.56\% \times 60\% = 0.000295$
Total Ignition Reduction Estimate	$0.000182 + 0.000295 = 0.000477$

Impact of the Activity on PSPS Risk

The ESH Program focuses on reducing the risk of wildfire. It has no impact on the risk of PSPS.

Updates to the Activity

Enhancements in 2023 will include fully transitioning the ESH Program prioritization process to the WiNGS-Planning model. Legacy traditional hardening projects will continue to be closed out in the future.

8.1.2.5.2 Transmission System Hardening Program (WMP.543, WMP.544, WMP.545)

Utility Initiative Tracking ID

WMP.543, WMP.544, WMP.545

Overview of the Activity

SDG&E operates and maintains approximately 1,993 miles of transmission infrastructure, including 993 miles of overhead transmission infrastructure in the HFTD. Aging infrastructure makes lines more susceptible to equipment failures and outdated design techniques make these lines more vulnerable to foreign object in line contacts during high winds, all of which could lead to ignitions.

The Transmission System Hardening Program is comprised of three parts: Overhead Transmission Hardening (WMP.543), Underground Transmission Hardening (WMP.544), and Distribution Underbuild (WMP.545). Overhead Transmission hardening utilizes enhanced design criteria to replace wood poles with steel poles, replace aging conductors with high-strength conductors, and increase conductor spacing in the HFTD to reduce the chance of risk events and ignitions. Underground Transmission Hardening replaces the overhead structures altogether and nearly eliminates the risk of wildfire from those tie line segments. The Distribution Underbuild Program replaces the overhead distribution equipment that is attached to the same poles and along the same route as the work that is completed in the overhead transmission hardening jobs. By including distribution underbuild work with overhead transmission work, costs are reduced due to the ability to combine charges such as design and labor.

The Transmission System Hardening Program prioritizes hardening activity in the HFTD, starting with Tier 3 and moving into Tier 2.

Targets for 2023 and performance metrics for 2022 are provided in Section 8.1.1.2 Targets and Section 8.1.1.3 Performance Metrics respectively.

Impact of the Activity on Wildfire Risk

Hardening overhead transmission lines in the HFTD reduces ignition risk due to foreign object line contacts, wire slaps, and equipment failure during high wind conditions. By replacing wood poles with steel poles, replacing aging conductors with high strength conductors, and designing to known local wind conditions, the risk of equipment failure is reduced during adverse weather conditions. Correspondingly, increasing conductor spacing reduces the risk of vegetation contact and wire slaps during adverse weather conditions.

To determine the estimated ignition reduction for the Transmission System Hardening Program, data on average historical transmission risk events, average historical transmission ignition rates, the measured effectiveness of hardened transmission lines, and the amount of hardening expected to be completed in the 2023 to 2025 WMP cycle was analyzed. For the distribution underbuilt components, historical information used for distribution hardening was applied to the miles of distribution underbuilt on transmission. Utilizing this methodology, a reduction of 0.125 transmission ignitions and 0.0084 distribution ignitions for the associated underbuilt was estimated. Calculations are shown in SDG&E Table 8-4 and SDG&E Table 8-5 respectively.

SDG&E Table 8-4: Risk Reduction Estimation for Transmission Overhead Hardening

Calculation Component	Component Value
Pre-mitigation risk events per 100 miles Tier 3	33.069
Pre-mitigation risk events per 100 miles Tier 2	4.222
Effectiveness Estimate Tier 3	85%
Effectiveness Estimate Tier 2	96%
Post-mitigation risk events per 100 miles Tier 3	$33.069 \times (1-85\%) = 4.96$
Post-mitigation risk events per 100 miles Tier 2	$4.22 \times (1-96\%) = 0.1688$
Transmission Ignition Rate Tier 3	13.64%
Transmission Ignition Rate Tier 2	11.11%

Calculation Component	Component Value
Risk Event Reduced Tier 3	$33.069 - 4.96 = 28.126$
Risk Event Reduced Tier 2	$4.22 - 0.1699 = 4.051$
Miles of mitigation Tier 3	0
Miles of mitigation Tier 2	28.94
Per Mile Baseline	100
Ignitions reduced Tier 3	$28.126 \times (0 \div 100) \times 13.64\% \times 85\% = 0.0$
Ignitions reduced Tier 2	$4.051 \times (28.94 \div 100) \times 11.11\% \times 96\% = 0.125039$
Total Ignitions reduced Overhead	$0 + 0.125039 = 0.125039$

SDG&E Table 8-5: Risk Reduction Estimation for Transmission-Distribution Underbuild

Calculation Component	Component Value Tier 3	Component Value Tier 2
Numbers of Faults Prior Mitigation	4.43	4.8
Numbers of Faults After Mitigation	2.46	2.66
Numbers of Average HFTD Faults	213	227
Numbers of Total HFTD Faults	132.9	145.4
Average HFTD Faults Prior Mitigation	$4.43 \times 213 \div 132.9 = 7.10$	$4.8 \times 227 \div 145.4 = 7.49$
Average HFTD Faults After Mitigation	$2.46 \times 213 \div 132.9 = 3.94$	$2.66 \times 227 \div 145.4 = 4.16$
Historical Ignition Rate	2.91%	2.56%
Numbers of Ignitions before Migration	$7.10 \times 2.91\% = 0.21$	$7.49 \times 2.56\% = 0.19$
Numbers of Ignitions after Migration	$3.94 \times 2.91\% = 0.11$	$4.16 \times 2.56\% = 0.11$
Total Ignition Reduction by Hardening	$0.21 - 0.11 = 0.092$	$0.19 - 0.11 = 0.085$
Installation/Repairment/Replacement	0	9.9
Per Mile Baseline	100	100
Effectiveness Estimate	100%	100%
Total Ignition Reduced	$(0 \div 100) \times 0.092 \times 100\% = 0$	$(9.9 \div 100) \times 0.085 \times 100\% = 0.008415$

Impact of the Activity on PSPS Risk

The Transmission Overhead System Hardening Program focuses on reducing the risk of wildfire. It does not have a PSPS risk reduction value associated with it.

Updates to the Activity

SDG&E plans to complete approximately 50 miles of transmission overhead system hardening, including distribution underbuild, by the end of the 2023-2025 WMP cycle.

8.1.2.6 Emerging Grid Hardening Technology Installations and Pilots

SDG&E is not currently piloting additional grid hardening technologies. However, grid hardening initiatives such as Advanced Protection Program (APP) (WMP.463) and Early Fault Detection (EFD) (WMP.1195) utilize emerging and advanced technologies to enable system automation and failure detection.

As described in Section 8.1.2.8.1, APP employs various technologies aimed to prevent and mitigate the risks of fire incidents, provide better transmission and distribution sectionalization, and create higher visibility and situational awareness in fire-prone areas.

EFD employs technologies such as ARFS and Power Quality (PQ) Meters (WMP.1195) to detect and prevent significant equipment failures before they occur. See Section 8.1.2.8.2 for more information on EFD.

The Distribution Communications Reliability Improvement (DCRI) Program (WMP.549) enables APP and EFD technologies as a reliable communication network is necessary for initiatives that require continuous communication. See Section 8.1.2.8.3 for more information on DCRI.

8.1.2.7 Microgrids (WMP.462)

8.1.2.7.1 Utility Initiative Tracking ID

WMP.462

8.1.2.7.2 Overview of the Activity

The Microgrid Program (WMP.462) is a program that designs and builds microgrids that can be electrically isolated during a PSPS event, thereby maintaining electric service to customers who would otherwise be affected. While alternative hardening solutions, such as strategic undergrounding, may be better at simultaneously mitigating wildfire risk, those options are not always technically feasible or cost-effective. For instance, customers who are located far away from a substation or central source of generation would require additional mileage of undergrounding that can be cost-prohibitive. Additionally, undergrounding may not be feasible, whether due to hard rock, environmental, or cultural concerns.

A combination of data including the risk of wildfire from overhead infrastructure, feasibility of traditional overhead hardening solutions, alternative solutions such as undergrounding distribution infrastructure, and historical PSPS impact data is used to guide the installation of microgrids. Additional information such as identification of critical facilities or AFN customers is incorporated into prioritizing targeted locations for a potential microgrid project. The majority of microgrid installations are in the HFTD.

8.1.2.7.3 Impact of the Activity on Wildfire Risk

The focus of the Microgrid Program (WMP.462) is to mitigate the consequences of PSPS events on customers that would otherwise be affected by de-energization.

8.1.2.7.4 Impact of the Activity on PSPS Risk

Over the 3-year period of the 2023 WMP cycle, microgrids are expected to reduce PSPS impacts to a total of 356 customers. This number is calculated based on the locations of microgrids and the

customers they serve and is used to estimate the reduction in PSPS impact to calculate the RSE. Because microgrids are designed to keep customers energized throughout the duration of a PSPS event, the effectiveness of the mitigation is estimated to be 100 percent. This number does not include nearby customers who are not energized by the microgrid (and could experience a PSPS event), but nevertheless benefit from critical locations being energized by the microgrid.

8.1.2.7.5 Updates to the Activity

Currently, 4 microgrids are planned to be completed by 2024. Locations currently under review include Cameron Corners, Butterfield Ranch, Shelter Valley, and potentially an off-grid solution (the name is still being determined). The Cameron Corners microgrid is located on Circuit 448, while the remaining three are located on Circuit 221.

The Cameron Corners microgrid, located in Tier 3 of the HFTD, is a remote, low-income community in the eastern part of San Diego County. The microgrid has been supporting 13 customers in its temporary configuration (e.g., conventional generators) since 2020. Customers range from residential, commercial, essential, and MBL. The permanent renewable solutions [875 kilowatts (kW) solar and 2.4 megawatt-hours (MWh) energy storage resource] are planned to be completed in 2024. In addition to the customers already identified, the microgrid will provide significant benefits to the surrounding rural community during de-energization events.

The Butterfield Ranch microgrid is a desert community in the eastern part of the service territory. Although the microgrid itself is not located in the HFTD, the circuit that feeds Butterfield Ranch is within Tier 2 and Tier 3 of the HFTD. The microgrid has been supporting 119 customers in its temporary configuration (e.g., conventional generators) since 2020. Customers range from residential, commercial, essential, and medical baseline. The permanent renewable solutions (2.1 megawatts (MW) solar and 4 MWh energy storage resource) are planned to be completed in 2025.

The Shelter Valley microgrid is a desert community in the far eastern section of the service territory. Although the microgrid itself is not located in the HFTD, the circuit that feeds Shelter Valley is within Tier 2 and Tier 3 of the HFTD. The microgrid has been supporting 223 customers in its temporary configuration (e.g., conventional generators) since 2020. Customers range from residential, commercial, essential, and MBL. The permanent renewable solutions (2.4 MW solar and 4.8 MWh energy storage resource) are planned to be completed in 2025.

Off-grid technologies (also referred to as Remote Grid) are being evaluated as an additional solution to mitigate costly hardening efforts for long lines with minimal customer loading.

Additionally, mobile battery solutions are, and will continue to be, deployed to create temporary microgrid solutions in order to support communities as well as Community Resource Centers (CRCs) and minimize traditional generator run-time during extended PSPS events.

The WiNGS-Planning model is utilized to explore the potential use of segment-level risk analysis to inform the identification of additional microgrid sites as a potential alternative to other initiatives such as grid hardening.

8.1.2.8 Installation of System Automation Equipment

8.1.2.8.1 Advanced Protection (WMP.463)

Utility Initiative Tracking ID

WMP.463

Overview of the Activity

SDG&E operates and maintains nearly 3,500 miles of overhead distribution circuit miles within the HFTD. This infrastructure was originally designed to meet GO 95 requirements of an 8 psf or 55 mph transverse wind load, however winds can exceed 85 mph in certain areas of the HFTD during extreme Santa Ana conditions. Aging infrastructure also makes the remaining lines more susceptible to equipment failures and outdated design techniques, making these lines more vulnerable to foreign object in line contacts during high winds, all of which could lead to ignitions.

The APP (WMP.463) develops and implements advanced protection technologies within electric substations and on the electric distribution system. It aims to prevent and mitigate the risks of fire incidents, provide better transmission and distribution sectionalization, create higher visibility and situational awareness in fire-prone areas, and allow for the implementation of new relay and automation standards in locations where protection coordination is difficult due to lower fault currents attributed to high impedance faults.

More advanced technologies, such as microprocessor-based relays with synchrophasor/phasor measurement unit (PMU) capabilities, real-time automation controllers, auto-sectionalizing equipment, line monitors, direct fiber lines, Private LTE and wireless communication radios comprise the portfolio of devices that are installed in substations and on distribution circuits to allow for a more comprehensive protection system and greater situational awareness in the fire-prone areas of the HFTD. Advanced protection technologies implemented by this program include:

- Falling Conductor Protection (FCP) designed to trip distribution and transmission overhead circuits before broken conductors can reach the ground energized
- Sensitive Ground Fault (SGF) Protection for detecting high impedance faults resulting from downed overhead conductors that result in very low fault currents
- Sensitive Relay Profile (SRP) Settings enabled remotely on distribution equipment to reduce fault energy and fire risk
- High Accuracy Fault Location for improved response time to any incident on the system
- Remote Relay Event Retrieval and Reporting for real-time and post-event analysis of system disturbances or outages
- SCADA Communication to all field devices being installed for added situational awareness
- Increased Sensitivity and Speed of Transmission Protection Systems to reduce fault energies and provide swifter isolation of transmission system faults
- Protection Integration with emerging telecommunications technologies such as direct fiber, Private LTE and wireless radios as a means of facilitating the communication infrastructure needs of APP

APP replaces aging substation infrastructure such as obsolete 138 kilovolt (kV), 69 kV, and 12 kV substation circuit breakers, electro-mechanical relays, aging solid-state relays, aging microprocessor relays and Remote Terminal Units (RTUs). New circuit breakers incorporating microprocessor-based relays, RTUs, and the latest in communication equipment are also installed in substations within the HFTD. On distribution circuits within the HFTD, APP coordinates with the overhead system hardening programs to strategically install or replace sectionalizing devices, line monitors, direct fiber lines, and communication radios to facilitate the requirements of SDG&E’s advanced protection systems.

Impact of the Activity on Wildfire Risk

By replacing aging infrastructure, installing distribution sectionalizing devices, increasing the sensitivity and speed of protection systems, and utilizing high accuracy, high speed communication networks, APP (WMP.463) reduces fault energies and provides swifter isolation of system faults, resulting in lower wildfire risk.

The ignitions reduced by 2025 was calculated using the 5-year average risk events caused by wire downs, the 5-year average ignitions, the assumed effectiveness of 100 percent, and the number of planned APP installations for the WMP timeframe. The mitigation will have an estimated 100 percent reduction in ignitions based on the technology and what the product is designed to accomplish. Based on this data, a reduction of 0.203 and 0.056 ignitions in Tier 3 and Tier 2, respectively, are expected by the end of 2025. Calculations are shown in SDG&E Table 8-6.

SDG&E Table 8-6: Risk Reduction Estimation for Advance Protection

Calculation Component	Component Value
Tier 3 wire downs (2017-2021 average)	15.8
Tier 2 wire downs (2017-2021 average)	21.6
Wire down with connection failures Tier 3	2.75
Wire down with connection failures Tier2	3
Wire Down Mitigated Tier 3	$15.8 - 3.75 = 13.050$
Wire Down Mitigated Tier 2	$21.6 - 3 = 18.6$
Ignition rate Tier 3 (2017 – 2021 average)	2.91%
Ignition rate Tier 2 (2017 – 2021 average)	2.56%
No of Pre-mitigation ignitions Tier 3	$13.050 \times 2.91\% = 0.3795$
No of Pre-mitigation ignitions Tier 2	$18.6 \times 2.56\% = 0.4762$
Mitigation Effectiveness Estimate	100%
Ignitions reduction estimate Tier 3	$0.3795 \times 100\% = 0.3795$
Ignitions reduction estimate Tier 2	$0.4762 \times 100\% = 0.4762$
Installed in Tier 3	15
Installed in Tier 2	6
Total Tier 3 circuits	28
Total Tier 2 circuits	54
Ignitions reduced Tier 3	$0.3795 \times (15 \div 28) = 0.203304$

Calculation Component	Component Value
Ignitions reduced Tier 2	$0.4762 \times (6 \div 54) = 0.056$
Total Ignitions reduced	$0.203304 + 0.056 = 0.259304$

Impact of the Activity on PSPS Risk

Upgrades associated with APP (WMP.463) and increased sectionalization can also lead to reduced PSPS impacts. The reduction in PSPS impacts is directly related to the greater number of sectionalizing devices installed on the system as a part of this program. This reduces customer counts between sectionalizing devices, which can reduce the number of customers de-energized during weather events.

Updates to the Activity

Coordination with adjacent programs such as the Strategic Undergrounding Program (WMP.473) and the Covered Conductor Program (WMP.455) has continued in order to further refine efficient deployment of FCP on distribution circuits in the HFTD. Teams meet on a recurring basis to review target circuits for FCP, strategic undergrounding and installation of covered conductor scope to ensure FCP is not deployed on segments of circuits planned to be undergrounded. FCP still provides effective protection of circuits converted to covered conductor, and when possible, both are deployed simultaneously. Between 2023 and 2025, SDG&E plans to complete installation of FCP on 21 circuits within the HFTD areas, with emphasis on Tier 3.

The following next steps have been identified as countermeasures to the risks encountered in 2022:

- SDG&E's Land team is currently working with tribal land representatives to establish new process and timelines on achieving new easements.
- Processes have been adjusted to proactively research locations in the Bureau of Indian Affairs (BIA) and other potentially challenging jurisdictions to identify locations which may require extended permitting durations. When this occurs, the permitting task duration and downstream in-service dates are adjusted to reflect realistic completion dates.
- The number of circuit designs initiated will be increased to be at least 150 percent over our initiative targets to reduce the risk of missing our forecasted goal.

SDG&E successfully detected a broken conductor which occurred on a recently enabled FCP circuit in October of 2022. On October 29, 2022, SDG&E responded to reports of a wire down on 12 kV Circuit C217 out of Rincon Substation. Upon arrival, it was confirmed there was a wire down and repairs were needed to restore the circuit to normal configuration.

Upon investigation of FCP event records, it was discovered that the SDG&E FCP scheme on C217 successfully detected the broken conductor. The scheme was still in test mode at the time and did not act to trip the circuit segment, as SDG&E has not yet enabled full tripping mode. However, this event which shows the system not only works in lab and field-testing environments, but also in real world scenarios. SDG&E is continuing its strategic deployment of FCP throughout the HFTD and will continue to validate real-world scenarios which improve the efficacy of the technology.

In addition, Wire Down Detection (WDD) and EFD demonstration projects were completed in 2022.

Early Fault Detection (EFD) (WMP.1195)

The EFD demonstration project was successfully completed in 2022 with positive results. An EFD Program is currently being created as detailed in Section 8.1.2.8.2.

Wire Down Detection (WDD)

WDD is an innovative concept which leverages existing advanced metering infrastructure (AMI) network, providing “near time” analysis of circuit events. The goal of this project was to use AMI data to detect wire down in distribution networks. Preliminary analysis of WDD data showed promising results. The advanced analytics developed as part of this project have demonstrated energized downed conductors and single-phase faults can be identified in near real time. When the analytic programs detect a wire down with high confidence, an alert is emailed to the distribution list and also shows as an icon on a GIS map.

During the demonstration phase, WDD test data was validated via field inspection and root cause was compared to how the WDD system responded in the test environment. Test results demonstrated that if the AMI Workforce Management (WFM) application was operational in a production environment, the time savings provided by the application may have yielded significant wildfire risk reduction. In addition, the AMI WFM application can identify single-phase fault incidents. Currently, the only way to discover single-phase fault incidents is by a customer calling for having partial lights out. The automatic detection of these incidents may provide time-savings and reliability benefits, resulting in improved SAIDI/Customer Average Interruption Duration Index (CAIDI) metrics.

The AMI WFM application can also be leveraged to identify distribution transformers experiencing issues or that are highly likely to fail. With this ability, issues can be addressed before a transformer failure, providing the opportunity to mitigate potential wildfires and prevent reliability and public safety issues. Lastly, the project found that voltage anomalies occurred before a tree branch caused a fault. This offers the possibility of using AMI data to identify vegetation incursion and predict vegetation-related faults.

[8.1.2.8.2 Early Fault Detection \(WMP.1195\)](#)

Utility Initiative Tracking ID

WMP.1195

Overview of the Activity

Electrical equipment failures can cause significant damage, customer and employee safety impacts, high costs of repair, and extended outages to customers. Equipment failures, specifically those in fire-prone areas, can cause significant loss of life and property and should be avoided at all costs. Through years of research and development, SDG&E has developed, alongside its strategic vendor partnerships, ways to successfully detect what are known as incipient faults on the system with enough time to locate and potentially fix or replace equipment prior to it permanently failing. These incipient faults occur on failing pieces of equipment long before they fail violently and cause damage to the surrounding area. Recent advances in power quality, relaying, radio frequency, and other technologies have made it possible for utilities to identify and predict failures long before they occur.

The EFD Program (WMP.1195) aims to utilize these technologies to detect and prevent significant equipment failures in order to address fire risk while also gaining the benefits of reducing customer forced outages.

Technologies implemented by the EFD Program include:

- ARFS
- PQ Meters

Advanced Radio Frequency Sensors (ARFS)

ARFS use radio frequency monitoring of partial discharge from primary conductors to find, replace, and/or repair damaged components before they ultimately fail. Sensors are installed for each phase at 4-km intervals along a circuit extending from just outside the substation to the end of its furthest branches. Data is collected every second and backhauled on commercial cell communication networks to web servers. Software analysis eliminates spurious signals and isolates signals which are generated by the electrical facilities. Comparing the timing of the arrival of the signals at two adjacent installations (nodes) allows the location of the equipment generating the signal to be determined within 10 meters on the path between the nodes. The developer analyses the data and provides monthly reports showing low-medium-high risk ratings for each structure on the path, allowing targeted inspections of the facilities to find the damaged equipment generating the signal.

The objective is to identify components of the electrical system that are deteriorating. For example, an aging insulator that is beginning to “track” from the conductor to the crossarm. The sensors find damage that is much more subtle than what is normally found in traditional visual inspections.

PQ Meters

The PQ Meter Deployment, Replacement, and Expansion portion of the EFD Program represents the continued deployment of PQ meters which can remotely monitor, capture, and transmit high-resolution electric system data supporting electric transmission, distribution, and substation asset management, operations, power quality investigations, distributed energy integration, reliability improvement, fire risk reduction, fault location, and predictive fault analytics. Applications are being evaluated which will have a direct positive impact on system reliability, customer service, fire risk reduction, and asset management.

These projects provide expansion to the PQ monitoring system (PQ Nodes) and associated communication and back-office systems. Goals of the project are to:

- Expand monitoring capability to circuits and field locations
- Provide field wiring and network connections to existing monitors
- Upgrade existing PQ nodes and support equipment
- Install new IT integration and interface for new equipment
- Install field and substation relay and communication systems
- Install new PQ support communication equipment
- Provide time synchronization for existing monitors

The PQ monitoring system provides the following benefits:

- Provides distribution, transmission, and substation system health information, including RMS voltage, voltage and current transient events, system harmonics (including spectra), real and reactive power flow, power factor, and flicker
- Provides logging and notification for events occurring on transmission, distribution, and customer systems that are perceptible at the distribution substation and customer locations
- Provides advanced analytics processes, including incipient fault detection (aka, fault anticipation or predictive fault analysis) and advanced fault locating
- Provides a data source with analytics for historical events and steady state trends
- Provides data collected via the substation PQ monitoring system that is regularly utilized by several groups, including Commercial and Industrial (C&I) Services, Electric Transmission, and Distribution Engineering and Planning

Continued deployment of PQ meters that can remotely monitor and capture data will support transmission, distribution, and substation asset management, fire risk reduction, Distributed Energy Resources (DER) integration, reliability enhancements, customer service, and power quality investigations. Use cases under development will support momentary or incipient fault detection and advanced fault locating.

Impact of the Activity on Wildfire Risk

Though the EFD Program (WMP.1195), damaged components can be identified before they catastrophically fail causing sparks, wire downs or outages that could result in an ignition. ARFS and PQ hardware is being installed on older circuits that are not expected to be significantly hardened in the next few years. One of the advantages of the ARFS technology is that the sensors are mounted 30 inches from the primary conductor so there is no contact with high voltage other than the small 1 kilovolt-ampere (kVA) transformer to power the control unit.

The ignitions reduced by 2025 was calculated using the 5-year average risk events. The 5-year average ignitions, the assumed effectiveness of 72 percent, and the number of planned EFD installations for the WMP timeframe. The mitigation will have an estimated 72 percent reduction in ignitions based on the technology and what the product is designed to accomplish. Based on this data, a reduction of 0.45 and 0.24 ignitions in Tier 3 and Tier 2, respectively, are expected by the end of 2025. Calculations are shown in SDG&E Table 8-7.

SDG&E Table 8-7: Risk Reduction Estimation for Early Fault Detection

Calculation Component	Component Value
Risk Events Tier 3-5 yr avg (2017-2021)	104
Risk Events Tier 2-5 yr avg (2017-2021)	114.8
Risk Events 5 yr avg Ignition Tier 3	2.91%
Risk Events 5 yr avg Ignition Tier 2	2.55%
5 yr Avg Ignition Rate Tier 3	$104 \times 2.91\% = 3.02$
5 yr Avg Ignition Rate Tier 2	$114.8 \times 2.55\% = 2.93$
Ignition reduction estimate Tier 3	$3.02 \times 72\% = 2.1776$
Ignition reduction estimate Tier 2	$2.93 \times 72\% = 2.1082$

Calculation Component	Component Value
Mitigation Effectiveness	72%
Total units In The Network Tier 3	420
Total units In The Network Tier 2	810
Actuals to be repaired or replaced Tier 3	86
Actuals to be repaired or replaced Tier 2	94
Ignition Reduced Tier 3	$(86 \div 420) \times 2.1776 = 0.44589$
Ignition Reduced Tier 2	$(94 \div 810) \times 2.1082 = 0.244655$
Total Ignition reduced	$0.44589 + 0.244655 = 0.6905$

Impact of the Activity on PSPS Risk

The EFD Program (WMP.1195) focuses on reducing the risk of wildfire. It does not have a quantifiable PSPS risk reduction.

Updates to the Activity

The EFD Program (WMP.1195) began as a 2-year demonstration project and transitioned to a regular project in mid-2022. The project began installation of the new fourth-generation ARFS control units in late 2022. The initial five circuits have third-generation ARFS. Third-generation ARFS can monitor 4 percent of each second compared to 96 percent of each second for fourth-generation units. The additional data generated by the fourth-generation ARFS will allow detection of damage earlier and in less time.

Initial deployment used one cell provider which resulted in some difficulty locating sufficient cell signal to place nodes at the far end of branches. New cell signal detection equipment is now being used to field cell signals from all three large commercial networks, allowing more optimal placement of ARFS units using the network with the best signal. SDG&E plans to continue with ARFS installation and Power Quality meters on 30 circuits within the HFTD areas, with emphasis in tiers 2 and 3.

A significant transition was made to solar power for most of the ARFS installations which will eliminate any added connection to the primary conductors for those locations. Some locations not suitable for solar still require one or two connections for a small transformer.

The use of more sophisticated analytic tools is being investigated to gain more value from the data generated by the ARFS units.

8.1.2.8.3 Distribution Communications Reliability Improvements (WMP.549)

Utility Initiative Tracking ID

WMP.549

Overview of the Activity

The current communication system within the HFTD does not have the bandwidth to support some of the technologies deployed as wildfire mitigations, including APP (WMP.463) and FCP. In addition, there

are gaps in coverage of third-party communication providers in the rural areas of eastern San Diego County that limit the ability to communicate with field personnel during RFW crew deployments and EOC activations.

To mitigate this risk, the DCRI Program (WMP.549) was developed to deploy a privately-owned LTE network using licensed radio frequency spectrum, enhancing the reliability of the communication network. A reliable communication network is necessary for many initiatives that require continuous communication.

Targets for 2023 and performance metrics for 2022 are provided in Section 8.1.1.2 Targets and Section 8.1.1.3 Performance Metrics respectively.

Impact of the Activity on Wildfire Risk

This initiative does not have a Risk Reduction Estimation because it is foundational to supporting wildfire mitigation efforts. Quantifying a Risk Reduction Estimation would be difficult and not beneficial because it cannot be directly tied to reducing a risk driver and measuring the effectiveness of that reduction.

Impact of the Activity on PSPS Risk

This initiative does not have a Risk Reduction Estimation because it is foundational to supporting wildfire mitigation efforts. Quantifying a Risk Reduction Estimation would be difficult and not beneficial because it cannot be directly tied to reducing a risk driver and measuring the effectiveness of that reduction.

Updates to the Activity

Updates made to the DCRI Program (WMP.549) in 2022 include:

- Ongoing Spectrum clearing for second Spectrum licensing
- Ongoing radio frequency design and analysis in the HFTD
- Continued development of site design standards for quicker designs and deployments
- Ongoing siting surveys, land rights, and environmental analysis
- Continued community outreach and communications
- Completion of 22 base stations
- Ongoing use case testing and validation

Enhancements in the 2023 to 2025 WMP cycle will include installations of additional base stations.

As the DCRI Program progresses, initial build sites will be analyzed, and deployment strategies will be adjusted based on the analysis.

In alignment with the proposed settlement agreement with Public Advocates Office in SDG&E's pending GRC, SDG&E is reducing the scope of this program.

Most sites planned for base station installation have engineered steel foundation poles that will have telecommunication antennas at the top of the pole and electric (12 kV and below) attachments in the middle of the pole. Poles are currently undergoing standardization, and development of pole specifications, including workspace, operational, and manufacturing requirements, has taken longer than expected. To complete the pole standardization, three pilot sites were selected and pole orders were placed at the end of 2023. In 2024, construction of these three pilot sites and standardization of

pole designs is expected to be completed, which will accelerate the initiative in 2025 and beyond. In addition, process improvements with substation and transmission facility engineering and operations groups are being developed to ensure proper design and construction.

Workplan modifications will delay improvements expected from the SDG&E-owned private LTE network backbone that supports some Advanced Protection initiatives including Falling Conductor Protection (FCP) and Early Fault Detection (EFD). FCP and EFD work will continue to be deployed in the interim and will be enhanced once the LTE backbone is completed. This change is not expected to impact expected wildfire risk reduction within the 2023-2025 WMP cycle.

8.1.2.9 Line Removal (in HFTD)

8.1.2.9.1 Utility Initiative Tracking ID

N/A – Line removals are related to Strategic Undergrounding (WMP.473), Covered Conductor Installations (WMP.455), or Overhead Traditional Hardening and as such, do not have a separate Utility Initiative Tracking ID.

8.1.2.9.2 Overview of the Activity

SDG&E proactively removes overhead lines as part of the Strategic Undergrounding Program (WMP.473) and occasionally during certain overhead hardening initiatives such as covered conductor installations. For example, if a circuit segment is planned to be undergrounded, all associated overhead infrastructure would be removed. For covered conductor installations, overhead distribution lines are removed from service only if they are no longer in use.

SDG&E does not track Line removal in the HFTD as a reportable metric because these mileages are already associated with the new installations under other programs. SDG&E has recently begun to quantify line miles removed as a result of underground and overhead hardening initiatives; however, because the GIS mapping system is ‘as-built’, it is not possible to retroactively quantify these line miles removed.

8.1.2.9.3 Impact of the Activity on Wildfire Risk

Impacts to wildfire risk associated to line removals are summarized in the following initiatives:

- Strategic Undergrounding Program (WMP.473) (see Section 8.1.2.2)
- Covered Conductor Program (WMP.455) (see Section 8.1.2.1)
- Overhead Traditional Hardening (WMP.475 and WMP.543) (see Section 8.1.2.5)

8.1.2.9.4 Impact of the Activity on PSPS Risk

Impacts to PSPS risk associated to line removals are summarized in the following initiatives:

- Strategic Undergrounding Program (WMP.473) (see Section 8.1.2.2)
- Covered Conductor Program (WMP.455) (as a future enhancement) (see Section 8.1.2.1)

8.1.2.9.5 Updates to the Activity

No updates since the last WMP submission.

8.1.2.10 Other Grid Topology Improvements to Minimize Risk of Ignitions

8.1.2.10.1 Avian Protection Program (WMP.972)

Utility Initiative Tracking ID

WMP.972

Overview of the Activity

The Avian Protection Program (WMP.972) involves installing avian protection equipment on distribution poles in the service territory to prevent electrocution of birds and to facilitate compliance with Federal and State Laws. The Program is aimed at improving reliability and reducing the risk of faults and wire-down events associated with avian contact that can lead to ignitions. Avian protection equipment will be installed concurrently with other asset replacement initiatives across the HFTD such as hot line clamp replacements (WMP.464), fuse replacements, and lightning arrester replacements (WMP.550).

Impact of the Activity on Wildfire Risk

Animal contacts represent a total of 7.8 percent of overall risk events in the HFTD between 2017 and 2021. Reducing the number of animal contacts by installing avian protection will, in turn, reduce the likelihood of subsequent ignitions from occurring. The estimated percent reduction in wildfire ignitions due to the installation of avian covers is 90 percent. This is based on field observations in the Tier 3 area.

The ignitions reduced by 2025 was calculated using the 5-year average risk events caused by animal contact, the 5-year average ignitions caused by animal contacts, and number of planned Avian Protection installations for the WMP timeframe. Based on this data, a reduction of 0.004 and 0.003 ignitions in Tier 3 and Tier 2, respectively, are expected by the end of 2025. Calculations are shown in SDG&E Table 8-8.

SDG&E Table 8-8: Risk Reduction Estimation for Avian Covers

Calculation Component	Component Value
Animal Contact Tier 3-5 yr avg (2017-2021)	23.2
Animal Contact Tier 2-5 yr avg (2017-2021)	26.2
Animal Contact Non-HFTD 5-yr avg (2017-2021)	34.8
Animal Contact 5-yr avg Ignition Tier 3	0.8
Animal Contact 5-yr avg Ignition Tier 2	0.6
Animal Contact 5-yr avg Ignition Non-HFTD	0.2
5-yr Avg Ignition Rate Tier 3	3.45%
5-yr Avg Ignition Rate Tier 2	2.29%
5-yr Avg Ignition Rate Non-HFTD	0.57%
Total Avian Protection in the Network Tier 3	39,575
Total Avian Protection in the Network Tier 2	46,955
Total Avian Protection in the Network Non HFTD	136,835
Avian Protection actuals to be repaired or replaced Tier 3	240

Calculation Component	Component Value
Avian Protection actuals to be repaired or replaced Tier 2	240
Avian Protection actuals to be repaired or replaced Non HFTD	120
Mitigation Effectiveness	90%
Ignition Reduced Tier 3	$0.8 \times (240 \div 39,575) \times 90\% = 0.004$
Ignition Reduced Tier 2	$0.6 \times (240 \div 46,955) \times 90\% = 0.00276$
Ignition Reduced Non-HFTD	$0.2 \times (120 \div 136,835) \times 90\% = 0.000158$
Total Ignition reduced	$0.004 + 0.00276 + 0.000158 = 0.007$

Impact of the Activity on PSPS Risk

The purpose of the Avian Protection Program (WMP.972) is to reduce the risk of wildfire. This program does not affect the PSPS risk.

Updates to the Activity

Between 2023-2025, SDG&E plans to install avian protection equipment at 1,000 locations in the HFTD.

8.1.2.10.2 Strategic Pole Replacement Program (WMP.1189)

Utility Initiative Tracking ID

WMP.1189

Overview of the Activity

The Strategic Pole Replacement Program (WMP.1189) will focus on the replacement of gas-treated poles in fire prone areas of the service territory, including Tier 2 and 3 of the HFTD and the WUI. The purpose of this program is to target high-risk poles located throughout the service territory that are gas treated (also known as Cellon treatment) and are set in concrete and steel reinforced, steel reinforced and set in soil, or set in soil, and are not being addressed by other programs such as the Covered Conductor Program (WMP.455) or the Strategic Undergrounding Program (WMP.473). These poles are nearing the end of their useful life and are known to have a higher failure potential. Gas treated poles have a higher propensity for dry rot due to the pole's interaction with the moisture in the soil, and poles set in concrete are more difficult to inspect and determine the integrity of the pole. The average age of these gas treated poles is nearing 50 years.

The program will have multiple risk categories and will be prioritized based on these categories.

- Phase 1 (approximately 85 poles): Pole set in concrete and steel reinforced or pole set in concrete and not steel reinforced
- Phase 2 (approximately 58 poles): Pole set in soil and steel reinforced
- Phase 3 (approximately 1,379 poles): Pole set in soil and not steel reinforced
- Total poles in scope: Approximately 1,522 poles

Phase 1 poles would be addressed first, followed by Phase 2 then Phase 3. However, permitting, land rights, environmental mitigation, customer concerns, or a combination of these factors will drive the

ultimate schedule on each pole’s replacement. Where feasible, poles will be bundled together in a single work package to minimize the impact to the community and gain efficiency in the design, environmental, permitting, land rights, and construction process. In most cases a single work order package will bundle poles that are adjacent or within a few spans of each other and will require similar land rights, permitting, and/or land rights.

Impact of the Activity on Wildfire Risk

The ignitions reduced by 2025 were calculated using the 5-year average risk events caused by pole damage or failure. Based on this data, a reduction of 0.025 and 0.05 ignitions in Tier 3 and Tier 2, respectively, are expected by the end of 2025. Calculations are shown in SDG&E Table 8-9.

SDG&E Table 8-9: Risk Reduction Estimation for the Strategic Pole Replacement Program

Calculation Component	Component Value
Pre-Mitigation Average Numbers of Faults Tier 3	14.4
Pre-Mitigation Average Numbers of Faults Tier 2	12.6
Pre-Mitigation Average Numbers of Faults Non HFTD	19.6
Average Ignition Rate Tier 3	2.91%
Average Ignition Rate Tier 2	2.56%
Average Ignition Rate Non HFTD	1.13%
Numbers of Pre-Mitigation Ignition Tier 3	$14.4 \times 2.91\% = 0.41904$
Numbers of Pre-Mitigation Ignition Tier 2	$12.6 \times 2.56\% = 0.32256$
Numbers of Pre-Mitigation Ignition Non HFTD	$19.6 \times 1.13\% = 0.22148$
Mitigation Effectiveness Estimate (%)	100%
Ignition Reduction Estimate Tier 3	$0.41904 \times 100\% = 0.41904$
Ignition Reduction Estimate Tier 2	$0.32256 \times 100\% = 0.32256$
Ignition Reduction Estimate Non HFTD	$0.22148 \times 100\% = 0.22148$
Poles Replacement Tier 3	115
Poles Replacement Tier 2	302
Poles Replacement Non HFTD	110
Numbers of Total Poles to be Replaced Tier 3	1940
Numbers of Total Poles to be Replaced Tier 2	1940
Numbers of Total Poles to be Replaced Non HFTD	1940
Total Ignition Reduced Tier 3	$(115 \div 1940) \times 0.41904 = 0.02484$
Total Ignition Reduced Tier 2	$(302 \div 1940) \times 0.32256 = 0.050213$
Total Ignition Reduced Non HFTD	$(110 \div 1940) \times 0.22148 = 0.012558$
Total Ignition Reduced	$0.02484 + 0.050213 + 0.012558 = 0.087611$

Impact of the Activity on PSPS Risk

The purpose of the Strategic Pole Replacement Program (WMP.1189) is to reduce the risk of ignitions and wildfire. This program does not affect the PSPS risk.

Updates to the Activity

Through the CMP and grid hardening initiatives, an increase in the scope, and therefore target, of this initiative was identified. In addition to replacing cellon-treated wood poles, this initiative will also target poles that require pole loading remediation.

8.1.2.11 Other Grid Topology Improvements to Mitigate or Reduce PSPS Events

8.1.2.11.1 PSPS Sectionalizing Enhancement Program (WMP.461)

Utility Initiative Tracking ID

WMP.461

Overview of the Activity

The PPS Sectionalizing Enhancement Program (WMP.461) installs switches in strategic locations, improving the ability to isolate high-risk areas for potential de energization. For example, switches are installed on circuits that have significant sections underground, allowing customers with this lower-risk infrastructure to remain energized during weather events. Another example is combining weather stations with sectionalizing devices to de-energize only sections of circuits that are experiencing extreme wind events.

Targets for 2023 and performance metrics for 2022 are provided in Section 8.1.1.2 Targets and Section 8.1.1.3 Performance Metrics respectively.

Impact of the Activity on Wildfire Risk

The purpose of the PPS Sectionalizing Enhancement Program (WMP.461) is to reduce the risk of PPS. This program does not affect the Wildfire risk.

Impact of the Activity on PPS Risk

By increasing the number of remotely operated sectionalizing devices on higher risk circuits, SDG&E can reduce the number of customers that have the potential to be impacted by a PPS event or potentially reduce the duration of de-energization based on local wind events. Between 2023 and 2025 it is estimated that these new sectionalizing devices could impact over 17,500 customers.

Updates to the Activity

No changes were made to this Program in 2022 and none are expected to be made in 2023.

8.1.2.11.2 Standby Power Program (Fixed Backup Power: Residential/Commercial) (WMP.468)

Utility Initiative Tracking ID

WMP.468

Overview of the Activity

The Standby Power Program (WMP.468), which is an umbrella program that includes several other programs, targets customers and communities that will not directly benefit from other grid hardening programs. These customers reside in the backcountry and are generally widely distanced from one another, therefore traditional grid hardening initiatives will not reduce potential PSPS exposure. The Standby Power Program consists of the Fixed Backup Power (FBP) Program targeting residential customers, FBP Program targeting commercial customers, and the Mobile Home Park Resilience Program (MHRP) which targets mobile home park clubhouses.

Standby Power Program was introduced to assist rural customers in the HFTD that may not benefit from near- or long-term traditional hardening initiatives. Other hardening initiatives in these communities would be ineffective and costly, with no guarantee that power would not be shut off during a PSPS event. Instead, providing fixed standby generators is the most efficient remedy for certain rural customers that are likely to experience PSPS events.

Customers are identified based on meter, circuit and PSPS event exposure. Outreach letters and communication are sent to customers inviting them to participate and, depending on site requirements, feasibility, and cost, a customer could receive a fixed installation backup generator, a business could receive a critical facility generator on a temporary basis during an active PSPS event, or a clubhouse or central community building at a mobile home park could receive a solar panel and battery backup system to provide resilient access to electricity during power outages, particularly during a PSPS event. The program manages site permitting, construction, and final inspection to ensure the equipment is installed properly.

Figure 8-7 shows the display the FPB installation at a mobile home park community.

Figure 8-7: FPB Installation at Mobile Home Park Community



Impact of the Activity on Wildfire Risk

The purpose of the Standby Power Program (WMP.468) is to reduce the impact of PSPS consequences, namely the loss of power. This program does not directly affect Wildfire risk.

Impact of the Activity on PSPS Risk

PSPS events can have negative customer impacts and should be limited as much as feasible to the specific areas that are experiencing extreme risk. This is especially important for customers who may require medical devices to be powered 24 hours a day, 7 days a week. The Standby Power Program (WMP.468) does not reduce PSPS risk but reduces the impact of PSPS for vulnerable customers. Through 2022, the Standby Power Program provided backup power solutions to approximately 820 residential and nine commercial customers thereby reducing PSPS consequences. For 2023, the program plans for an additional participation of approximately 300 residential and six commercial customers, bringing the estimated total to 1,135. This number is calculated based on how many customers would receive generators and is used to estimate the reduction in PSPS impacts to calculate the RSE. Because the generators provided to customers as a part of this program are whole-facility solutions that are expected to keep the customers energized throughout a PSPS event, the effectiveness of the mitigation is estimated to be 100 percent.

Updates to the Activity

Enhancements and progress made in 2022 include:

Residential:

- Enhanced coordination between the program team and the hardening analysis teams to identify communities that may benefit from fixed backup power solutions
- Increased system automation to streamline customer application processing and workflow tracking
- Strengthened relationship with County to support permitting and inspection processes
- Targeted all MBL customers in HFTD Tier 2 and Tier 3 of the HFTD that experienced a PSPS event between 2019 and 2021

Updates for 2023:

Residential:

- Evaluate non-fossil fuel backup battery technology options for residential customer installations
- Continue to provide fixed backup power solutions to residential and commercial customers who experience frequent PSPS

Commercial:

- Strengthen the process of promoting participation and delivering resources in partnership with tribal community partners
- Develop plans to offer to additional AFN population and tribal communities

Updates for 2024 and 2025:

In alignment with the proposed settlement agreement with Public Advocates Office in SDG&E's pending GRC, SDG&E is reducing the scope of this program.

In 2024, the Standby Power Programs will reach their intended goal, including mitigations of over 1,200 residential customers and 19 commercial sites, and provide valuable strategic and operational lessons learned. In 2025, the programs will build on 2024 efforts to explore and evaluate additional mitigation approaches, continuing to support customer resilience while focusing on climate adaptation outcomes such as renewable backup power options. Program adjustments will be made to support these design enhancements and the 2025 target was adjusted accordingly.

8.1.2.11.3 Generator Grant Program (WMP.466)

Utility Initiative Tracking ID

WMP.466

Overview of the Activity

The Generator Grant Program (GGP) (WMP.466) focuses on enhancing resiliency among the most vulnerable customer segments to enable access to electricity for medical devices and critical appliances during a PSPS event. This program was previously referred to as the Resiliency Grant Program.

The GGP offers portable backup battery units with solar charging capacity to customers, leveraging cleaner, renewable generator options to give vulnerable customers a means to keep small devices and appliances charged and powered during PSPS events. The GGP, launched in 2019, focuses on the needs of MBL and Life Support customers in addition to other customers with access and functional needs in Tiers 2 and 3 of the HFTD who have experienced an outage due to a PSPS event. Eligible customers are proactively contacted and educated about the GGP.

The Emergency Backup Battery Program is a reserve of backup batteries established specifically for expedited delivery during active PSPS events. These units are pre-charged and delivered within 1 to 4 hours of eligible requests to customers who call into SDG&E's Customer Care Centers or 211 in need of emergency power backup that cannot be met through other AFN services such as hotel stays and accessible transportation. SDG&E also partners with Indian Health Councils to promote the availability of these backup battery units to vulnerable customers in tribal nation communities.

Impact of the Activity on Wildfire Risk

The purpose of the GGP (WMP.466) is to reduce the risk of PSPS. This program does not affect the Wildfire risk.

Impact of the Activity on PSPS Risk

The GGP (WMP.466) does not reduce PSPS risk but reduces the impact of PSPS for vulnerable customers. Through 2022, the GGP reduced the impact of PSPS events by providing portable backup battery units to approximately 4,700 customers. This represents the total number of customers who have received units, though a portion of these customers may have experienced subsequent changes in location, MBL standing, or other eligibility status. For 2023, the program plans for additional

participation of approximately 1,000 customers, bringing the estimated total to 5,700. This number is calculated based on the count of eligible customers likely to request portable backup battery units and is used to estimate the reduction in PSPS impact to calculate the RSE. Because the generators provided to customers as a part of this program are not whole-facility solutions, the effectiveness of the mitigation is estimated to be 40 percent.

Updates to the Activity

Enhancements and progress made in 2022 include:

- Solidified a dedicated reserve of backup battery units to deliver during active PSPS events. This provides support to those qualified customers who have not yet participated in the program, as well as prior participants who have received a unit and need additional capacity.
- Expanded program to a broader audience to include AFN customers in Tiers 2 and 3 of the HFTD who have experienced a PSPS outage, ensuring those who are most vulnerable during PSPS events are captured, specifically:
 - Individuals with disabilities, those that are blind/low vision and deaf/hard of hearing
 - Those that are temperature-sensitive
 - Those that have self-identified as AFN
- Established an online request form to enable interested customers to learn more about the program and apply, ensuring all eligible customers have the opportunity to participate
- Reviewed additional product technologies for inclusion into the program
- Began contacting customers that have received a backup power unit in previous program years to provide key safety reminders regarding their usage, care and maintenance

Updates for 2023:

- Continue working with tribal community leaders and liaisons to ensure vulnerable customers are aware of the program
- Continue contacting customers with a backup power unit to provide key safety reminders regarding usage, care and maintenance

8.1.2.11.4 Generator Assistance Program (WMP.467)

Utility Initiative Tracking ID

WMP.467

Overview of the Activity

The Generator Assistance Program (GAP) (WMP.467) focuses on enhancing resiliencies for all customers who reside in Tiers 2 and 3 of the HFTD and may be impacted by PSPS events. While the GGP (WMP.466) addresses the needs of the most medically vulnerable and the Standby Power Program (WMP.468) focuses on customers that do not have other grid hardening initiatives planned in their area, the GAP expands resilience opportunities to the general market in Tiers 2 and 3 of the HFTD. This program was previously referred to as the Resiliency Assistance Program.

The GAP launched in 2020 and offers rebates for portable fuel generators and portable power stations to encourage customers to acquire backup power options to enhance preparedness and mitigate the

impacts of PSPS. The target audience are customers who reside within Tiers 2 and 3 of the HFTD and have experienced at least one PSPS event since 2019. Eligible customers receive program materials via mail and email campaigns and are directed to an online portal to verify account information and learn more about the program. Upon verification, the program offers a \$300 rebate to customers who meet the basic eligibility criteria of residing in an HFTD zone and experiencing a recent PSPS event. In addition, customers enrolled in the California Alternate Rates for Energy (CARE) program are eligible for an enhanced rebate amount of \$450, providing a 70 to 90 percent discount on average portable generator models. The program also includes portable power stations and offers rebates of \$100, with an additional \$50 for CARE customers. The program provides the option for customers to receive one rebate for a fuel generator and one rebate for a portable power station to accommodate various backup power needs. To date, GAP has provided over 2,100 rebates. Customers may receive a rebate for a fuel generator as well as for a portable power station.

Impact of the Activity on Wildfire Risk

The purpose of the GAP (WMP.467) is to reduce the risk of PSPS. This program does not affect the Wildfire risk.

Impact of the Activity on PSPS Risk

The GAP (WMP.467) does not reduce PSPS risk but reduces the impact of PSPS for customers. Through 2022, GAP reduced the impact of PSPS events by providing rebates to approximately 2,100 customers. This represents the total number of customers who have received rebates, though a portion of these customers may have experienced subsequent changes in location or other eligibility status. A primary driver of a customer participating in this program and purchasing a backup power solution is the anticipation of power shutoff due to high winds, wildfire risk, or other weather emergency. In 2022, the number of anticipated power shutoffs was relatively low and therefore customer participation was also low. For 2023, the program plans for additional participation of approximately 700 customers, bringing the estimated total to 2,800. This number is based on how many customers are expected to purchase generators through the rebate program and is used to estimate the reduction in PSPS impact to calculate the RSE. Because generators purchased through this program vary depending on the customer's preferences, the effectiveness of the mitigation is estimated to be 75 percent.

Updates to the Activity

Enhancements and progress made in 2022 include:

- Enhanced the program process and portal to provide rebates on purchases made at any retailer so customers have more choice and inventory options. Prior year rebates were limited to two major retailers
- Updated the qualified product list for fuel generators to only include models that are CARB compliant and have carbon monoxide sensor and auto shutoff
- Increased the rebate amount for portable power stations from \$50 to \$100 per customer and introduced an additional \$50 rebate for CARE customers
- Promoted program to local agencies to spread awareness for qualified constituents

Updates for 2023:

- Continue to identify models that meet the program requirements and update the qualified product list
- Consider partnering more with CBOs and local agencies to promote the program's offerings.

8.1.2.12 Other Technologies and Systems not Listed Above

8.1.2.12.1 Utility Initiative Tracking ID

WMP.558

8.1.2.12.2 Overview of the Activity

The IMP (WMP.558) is foundational; this activity alone does not mitigate the risk of wildfire but is critical in understanding the overall wildfire risk in relation to SDG&E equipment assets. This activity, in conjunction with other foundational activities, allows for mitigation prioritization, the calculation of RSEs, and aids to effectively select and implement the right mitigations and controls to reduce the risk of wildfires.

The IMP has built processes to collect data from all internal stakeholders to track ignition and potential ignitions, perform root cause analysis of incidents in an effort to determine the exact cause of the failure, and detect patterns or correlations. When the cause of the failure is determined, the mode of failure is reported to the appropriate mitigation owner for remedy.

The program is managed by the IMP Manager within the FSCA.

8.1.2.12.3 Impact of the Activity on Wildfire Risk

The IMP (WMP.558) is a program foundational to supporting wildfire mitigation efforts. It has no direct impact on the risk of wildfire.

8.1.2.12.4 Impact of the Activity on PSPS Risk

The IMP (WMP.558) is a program foundational to supporting wildfire mitigation efforts. It has no direct impact on the risk of PSPS.

8.1.2.12.5 Updates to the Activity

This program was started in 2019, and has continued to build processes to mature. Data gathering processes and quality of the data are continually reviewed with enhancements implemented as soon as they are identified.

8.1.3 Asset Inspections

SDG&E's asset management and inspection programs are designed to promote safety for the general public, SDG&E personnel, and contractors by providing a safe operating and construction environment while maintaining system reliability. Inspection and maintenance programs identify and repair conditions and components to reduce potentially defective equipment on the electric system, minimizing hazards and maintaining system reliability. These programs continue to identify ways to improve the safety of the electric system. This includes developing new programs such as the evolving

DIAR Program (WMP.552) and supplementing existing programs such as patrol and detailed inspections with non-routine, risk-informed inspections.

SDG&E implements comprehensive, multi-faceted transmission and distribution inspection and patrol programs. These programs consist of detailed inspections, visual patrols, infrared inspections, and other various specialty patrols, inspections, and assessments. Inspections and patrols of all structures, attachments, and conductor spans are performed to identify facilities and equipment that may not meet PRC § 4292 and 4293 or GO 95 rules. OEIS Table 8-6 outlines transmission and distribution asset inspection programs by type.

OEIS Table 8-6: Asset Inspection Frequency, Method, and Criteria

Tracking ID	Type	Inspection Program	Frequency or Trigger	Method of Inspection per OEIS QDR Guidelines	Governing Standards & Operating Procedures
WMP.478 (8.1.3.1)	Distribution	Distribution Overhead Detailed Inspections	5 years	Ground	GO 165, 95
WMP.479 (8.1.3.2)	Transmission	Transmission Overhead Detailed Inspections	3 years	Ground	GO 165, 95 FAC-501-WECC
WMP.481 (8.1.3.3)	Distribution	Distribution Infrared Inspections	Risk-based	Ground	GO 165, 95
WMP.482 (8.1.3.4)	Transmission	Transmission Infrared Inspections	Annual	Aerial (helicopter) Ground	GO 165, 95
WMP.483 (8.1.3.5)	Distribution	Distribution Wood Pole Intrusive Inspections	10 years	Ground	GO 165, 95
WMP.1190 (8.1.3.6)	Transmission	Transmission Wood Pole Intrusive Inspections	8 years	Ground	GO 165, 95
WMP.552 (8.1.3.7)	Distribution	Drone Assessments	Risk-based in HFTD & WUI	Aerial - drone Ground	n/a
WMP.488 (8.1.3.8)	Distribution	Distribution Overhead Patrol Inspections	Annual	Ground	GO 165, 95
WMP.489 (8.1.3.9)	Transmission	Transmission Overhead Patrol Inspections	Annual	Aerial - helicopter	GO 165, 95 FAC-501-WECC
WMP.555 (8.1.3.10)	Transmission	Transmission 69kV Tier 3 Visual Inspections	Annual	Aerial - helicopter	GO 95
WMP.492 (8.1.3.11)	Substation	Substation Patrol Inspections	Monthly or Bi-monthly	Ground	GO 174

In general, priority levels for inspection findings are defined by GO 95, Rule 18 as shown in SDG&E Table 8-10. Correction timeframes are also established by GO 95, Rule 18 and are described in more detail in Section 8.1.7 Open Work Orders. Correction timeframes may be extended under reasonable circumstances per GO 95, Rule 18.

SDG&E Table 8-10: GO 95, Rule 18 Inspection Finding Priority Levels

Priority Level	Definition
Level 1	Immediate safety and/or reliability risk with high probability for significant impact
Level 2	Variable (non-immediate high to low) safety and/or reliability risk
Level 3	Acceptable safety and/or reliability risk

8.1.3.1 Distribution Overhead Detailed Inspections (WMP.478)

GO 165 requires SDG&E to perform a service territory-wide inspection of its electric distribution system, generally referred to as the CMP (WMP.478). The CMP helps mitigate wildfire risk by providing additional information about the condition of the electric distribution system, including the HFTD. With this information, potential infractions can be addressed before they develop into issues.

GO 165 establishes inspection cycles and record-keeping requirements for utility distribution equipment. In general, utilities must patrol their systems once a year in urban areas and in Tier 2 and Tier 3 of the HFTD (see Section 8.1.3.8 Distribution Overhead Patrol Inspections (WMP.488)). In addition to patrols, utilities must conduct detailed inspections at a minimum of every 5 years for overhead structures and sub-equipment. The 5-year detailed inspections of overhead facilities are mandated by GO 165. The corrective work resulting from detailed inspections is described in Section 8.1.7 Open Work Orders. Figure 8-8 outlines this process.

Figure 8-8: Distribution Detailed Overhead Inspections Process Flow

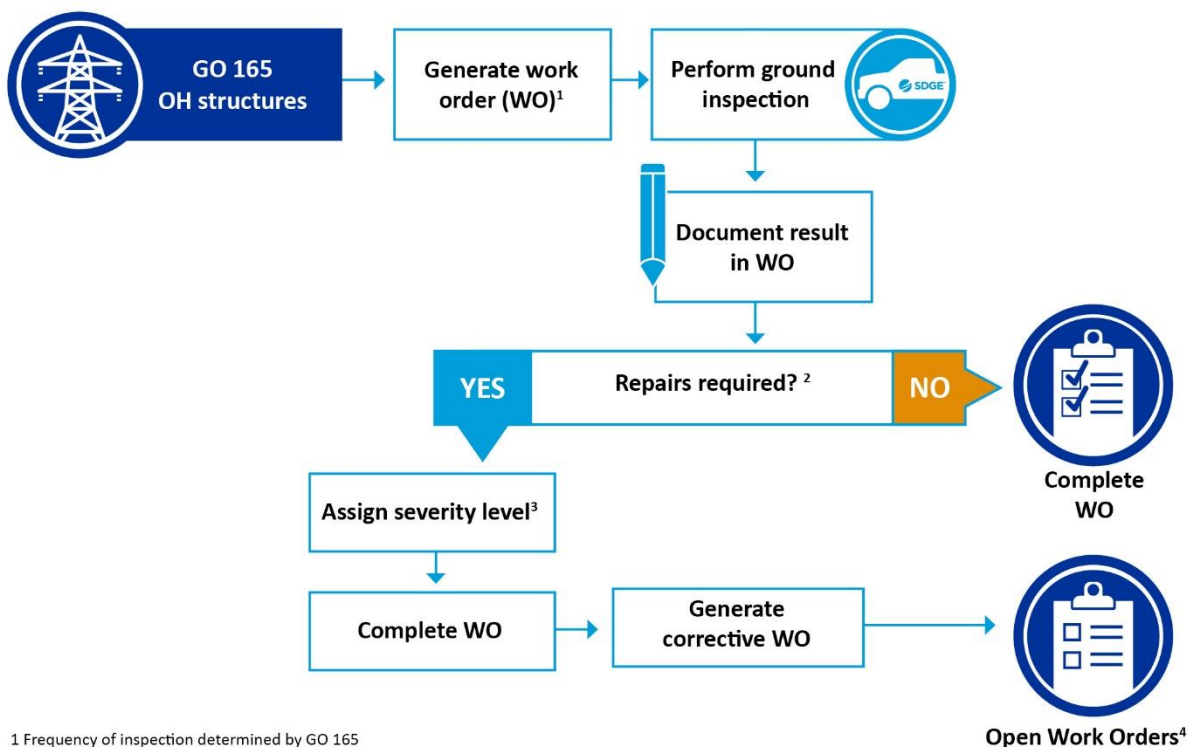

1 Frequency of inspection determined by GO 165

2 Repairs are required if work is needed to bring asset into compliance with GO

3 Severity Levels 1-3 per GO 95 Rule 18

4 See Open Work Order Process Flow

Per GO 165, detailed inspections of overhead facilities are currently completed on a 5-year cycle for all overhead structures, including those in the HFTD. Non-routine, ad hoc inspections may be conducted for operational or reliability purposes. Additionally, SDG&E prioritizes detailed inspections in the HFTD prior to fire season (as defined in Appendix A). Detailed inspections are also supplemented by risk-informed drone inspections as described in Section 8.1.3.7 Drone Assessments (WMP.552). There are no plans to change the frequency of this program. However, beginning in 2025, inspections performed in the WUI will be incorporated into the WMP reporting.

For existing programs, a 5-year historical average of hit rates (number of issues found at a given priority level divided by total inspections) was calculated and utilized to forecast future years based on the number of inspections in the HFTD for these programs. Failure rate calculations (i.e., how many risk events would occur within a year if there were no inspections or repairs within the prescribed timeframes) were utilized to convert issues found into risk events. Finally, the average distribution ignition rates broken down by HFTD Tier were utilized to calculate ignitions avoided due to the program. The ignitions avoided are calculated on an annual basis and can change depending on the inspection cycle. For 2023, an estimated 0.188 ignitions would occur if inspections and repairs were not completed in the prescribed timeframes as part of the 5-year detailed distribution inspection program (WMP.478). Calculations are shown in SDG&E Table 8-11.

SDG&E Table 8-11: Risk Reduction Estimation Methodology for the CMP

Calculation Component	Component Value
5-year average hit rate Emergency (0-3 days)	0.001
5-year average hit rate Priority (4-30 days)	0.001
5-year average hit rate Non-Critical	0.055
Fail Rate Emergency	48%
Fail Rate Priority	4.8%
Fail Rate Non-Critical	0.40%
2023 Projected Inspection Findings Tier 3	$3 + 4 + 206 = 213$
2023 Projected Inspection Findings Tier 2	$6 + 7 + 403 = 416$
Risk events Avoided Tier 3	$(3 \times 48\%) + (4 \times 4.8\%) + (206 \times 0.4\%) = 2.456$
Risk events Avoided Tier 2	$(6 \times 48\%) + (7 \times 4.8\%) + (403 \times 0.4\%) = 4.828$
Distribution Ignition rate Tier 3	2.91%
Distribution Ignition rate Tier 2	2.56%
Ignitions Avoided Tier 3	$2.456 \times 2.91\% = 0.069$
Ignitions Avoided Tier 2	$4.828 \times 2.56\% = 0.119$
Total ignitions avoided HFTD	$0.119 + 0.069 = 0.188$

The CMP was successfully completed in 2022. The Electric Safety and Reliability Branch of the CPUC also conducted an electric distribution audit of SDG&E’s Beach Cities District on August 1-5, 2022. The results of the audit yielded 26 non-emergency, Level 2 maintenance items that were corrected immediately upon discovery.

Targets for 2023 and performance metrics for 2022 are provided in Section 8.1.1.2 Targets and Section 8.1.1.3 Performance Metrics, respectively.

Challenges in performing detailed inspections are centered around access issues related to customers, difficult terrain, and labor resources.

The CMP will continue in compliance with GO 165. Results from 2022 Light detection and ranging (LiDAR) inspections and high-definition imagery from drone inspections (discussed in the 2022 WMP Update) will be reviewed to provide feedback and enhance ground GO 165 detailed overhead visual inspections and patrols.

8.1.3.2 Transmission Overhead Detailed Inspections (WMP.479)

GO 165 requires SDG&E to perform a service territory-wide inspection of its electric transmission system, generally referred to as the CMP. The CMP helps mitigate wildfire risk by providing additional information about the condition of the electric transmission system, including the HFTD. With this information, potential infractions can be addressed before they develop into issues.

For detailed inspections, experienced internal linemen (patrollers) physically visit every structure scheduled for the year, looking at all components of the structure and conductor. By physically visiting

the structures, patrollers can assess each structure for current and future maintenance requirements. As conditions are identified, internal severity codes are assigned to ensure supervisors properly prioritize assessment of conditions found. This prioritization considers the component identified, the location of the structure and surrounding terrain, and the severity of the condition. It also ensures that conditions are corrected in timeframes that meet or exceed GO 95 requirements. The corrective work resulting from detailed inspections is described in Section 8.1.7 Open Work Orders (WMP.1065). Figure 8-9 outlines the process for transmission detailed inspections.

Figure 8-9: Transmission Detailed Overhead Inspections Process Flow

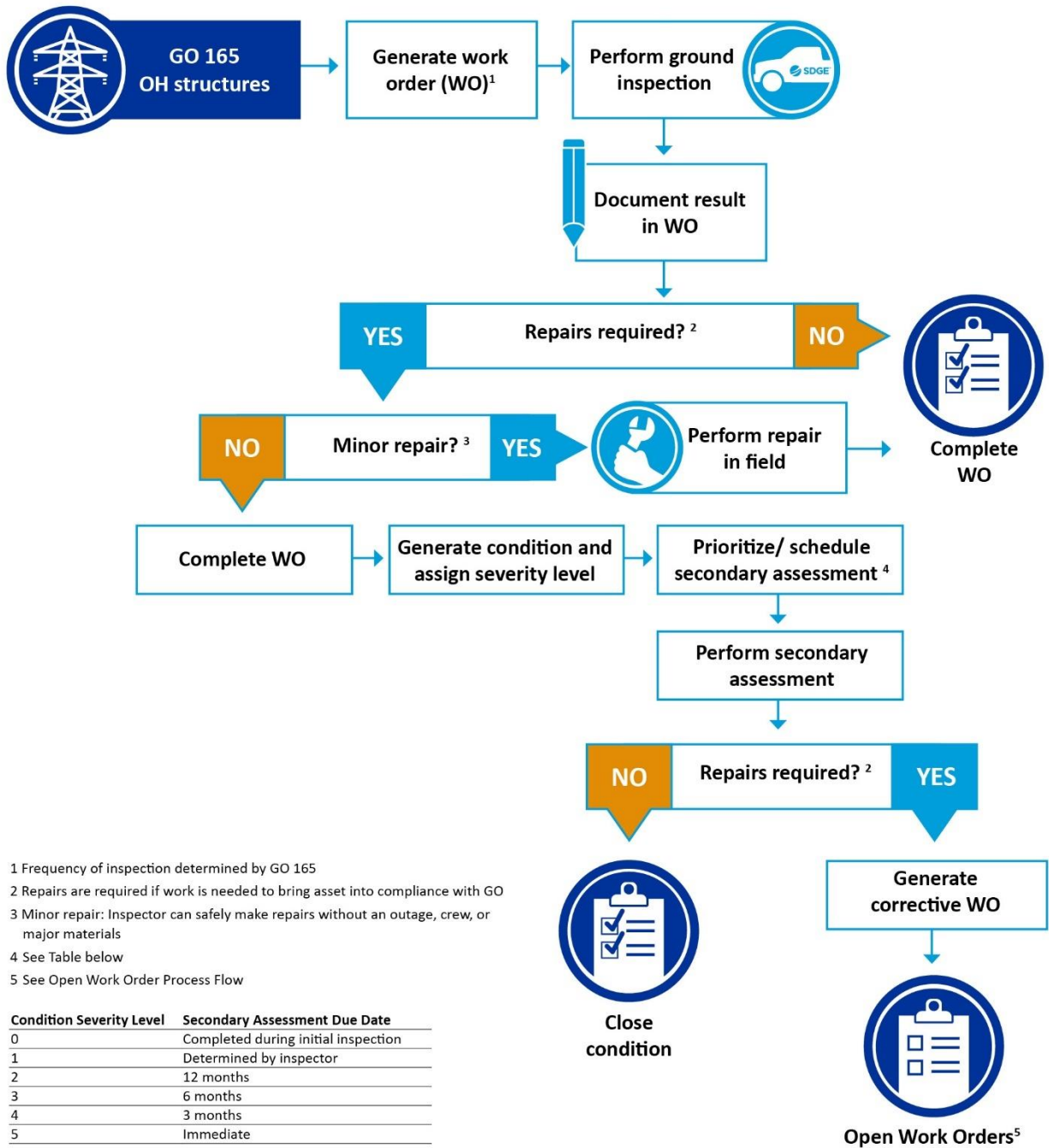

Detailed inspections are currently completed on a 3-year cycle for all overhead structures, including those in the HFTD. Inspections are prioritized and scheduled based on safety, reliability, and operational need.

For existing programs, a 5-year historical average of hit rates (number of issues found at a given priority level divided by total inspections) was calculated and utilized to forecast future years based on the number of inspections in the HFTD for these programs.

Failure rate calculations (i.e., how many risk events would occur within a year if there were no inspections or repairs within the prescribed timeframes) were utilized to convert issues found into risk events. Finally, the average transmission ignition rate for risk events and ignitions in the HFTD was used to convert risk events avoided to ignitions avoided. The number of ignitions avoided is calculated on an annual basis and can change depending on the inspection cycle. For 2023, an estimated 0.15 ignitions would occur if inspections and repairs were not completed in the prescribed timeframes as part of the detailed transmission inspection program (WMP.479). Calculations are shown in SDG&E Table 8-12.

SDG&E Table 8-12: Risk Reduction Estimation Methodology for the Transmission Overhead Inspection Program

Calculation Component	Component Value
5-year average hit rate Emergency (0-3 days)	0
5-year average hit rate Priority (4-30 days)	0.016
5-year average hit rate Non-Critical	0.09
Fail Rate Emergency	48%
Fail Rate Priority	4.80%
Fail Rate Non-Critical	0.40%
2023 Projected Inspection Findings Tier 3	$0 + 14 + 82 = 96$
2023 Projected Inspection Findings Tier 2	$0 + 23 + 132 = 155$
Risk events Avoided Tier 3	$0 \times 48\% + 14 \times 4.8\% + 82 \times 0.4\% = 1$
Risk events Avoided Tier 2	$0 \times 48\% + 23 \times 4.8\% + 132 \times 0.4\% = 1.632$
Transmission Ignition rate HFTD	5.58%
Ignitions Avoided Tier 3	$1 \times 5.58\% = 0.06$
Ignitions Avoided Tier 2	$1.632 \times 5.58\% = 0.09$
Total ignitions avoided HFTD	$0.06 + 0.09 = 0.15$

SDG&E has a mature transmission inspection and maintenance program and participates in internal and external desktop and field audits with positive results. Industry standards and emerging technologies are also reviewed to ensure best maintenance practices are utilized. Detailed inspections were successfully completed in 2022.

Targets for 2023 and performance metrics for 2022 are provided in Section 8.1.1.2 Targets and Section 8.1.1.3 Performance Metrics, respectively.

There were no roadblocks encountered during 2022 and there are no plans to change the scope or frequency of this program. However, beginning in 2025, inspections performed in the WUI will be incorporated into the WMP reporting.

Results of the DIAR Program (WMP.552), discussed in the 2022 WMP Update, revealed the effectiveness of this program with only a 1 to 3 percent findings rate.

8.1.3.3 Distribution Infrared Inspections (WMP.481)

Distribution Infrared Inspections (WMP.481) utilize infrared technology to examine the radiation emitted by connections to determine if there are potential issues with a connection before failure. Thermographers perform the ground inspection to capture and assess thermal imagery that may indicate an abnormality on the system. Findings are documented and required repair work is tracked through completion. The corrective work resulting from infrared inspections is described in Section 8.1.7 Open Work Orders. Figure 8-10 outlines the process for distribution infrared inspections.

Figure 8-10: Distribution Infrared Inspections Process Flow

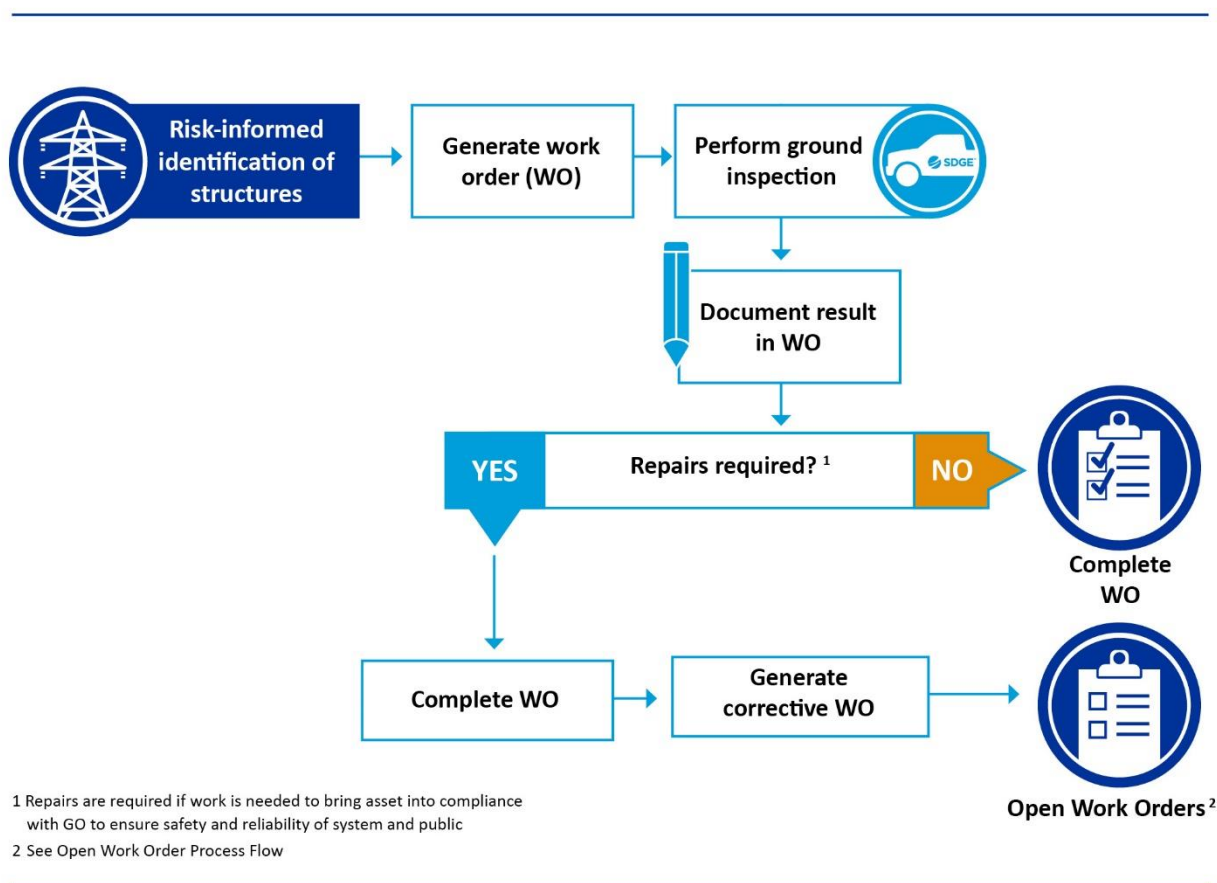

The scope of this program includes approximately 300 distribution structures each year. In 2022, Tier 3 structures were selected based on higher wildfire consequence; however, minimal findings resulted. In 2023, structures will be selected considering HFTD Tier 2 location, recent reliability concerns, and subject matter expertise.

For existing programs, a 5-year historical average of hit rates (number of issues found at a given priority level divided by total inspections) was calculated and utilized to forecast future years based on the number of inspections in the HFTD for these programs.

Failure rate calculations (i.e., how many risk events would occur within a year if there were no inspections or repairs within the prescribed timeframes) were utilized to convert issues found into risk events. Finally, the average distribution ignition rate for risk events and ignitions in the HFTD was used to convert risk events avoided to ignitions avoided. The ignitions avoided is calculated on an annual basis and can change depending on the inspection cycle. For 2023, an estimated 0.002 ignitions would occur if inspections and repairs were not completed in the prescribed timeframes as part of the Distribution Infrared Inspection Program (WMP.481). Calculations are shown in SDG&E Table 8-13.

SDG&E Table 8-13: Risk Reduction Methodology for Distribution Infrared Inspections Program

Calculation Component	Component Value
Fail Rate Emergency	48%
Fail Rate Priority	4.8%
Fail Rate Non-Critical	0.40%
2023 Projected Inspection Findings Tier 3	0 + 0 + 0 = 0
2023 Projected Inspection Findings Tier 2	0 + 2 + 0 = 2
Risk events Avoided Tier 3	$(0 \times 48\%) + (0 \times 4.8\%) + (0 \times 0.4\%) = 0$
Risk events Avoided Tier 2	$(0 \times 48\%) + (2 \times 4.8\%) + (0 \times 0.4\%) = 0.096$
Distribution Ignition rate Tier 3	2.91%
Distribution Ignition rate Tier 2	2.56%
Ignitions Avoided Tier 3	$0 \times 2.91\% = 0$
Ignitions Avoided Tier 2	$0.096 \times 2.56\% = 0.002458$
Total ignitions avoided HFTD	$0 + 0.002458 = 0.002458$

Infrared inspections of Tier 2 and Tier 3 overhead structures and wires yielded limited findings. However, targeted inspections following undetermined outages or following a result of automated sensor indications proved infrared, combined with other inspection techniques, is useful in determining the source of an outage or a potential for future failure. Infrared inspections will continue on targeted overhead structures and will be expanded to investigate sensor indications of decreased system performance and undetermined outages.

This program exceeded its targets for 2022. Targets for 2023 and performance metrics for 2022 are provided in Section 8.1.1.2 Targets and Section 8.1.1.3 Performance Metrics, respectively.

There were no roadblocks encountered during 2022 when performing infrared inspections and there are no plans to change the amount or frequency of inspections for this program. In 2020, the program was focused within Tier 3 and had very little findings due to minimal loading in the backcountry area; thus, in 2021 and 2022 inspections were refocused within Tier 2. Circuits were selected by each district's Operations & Engineering Manager and were based on high SAIDI values, Construction Supervisor feedback, and outage history. Circuits selected by the districts were then prioritized based on the total structure counts per Tier and were compared to circuits that had an infrared inspection already performed since 2020.

In 2024, the selection of structures for distribution infrared inspections will evolve into a risk-informed strategy. Prior to 2024, structures were selected based on the recommendations of subject matter experts with knowledge and experience of the service territory based on their perceived “risk”. However, this method of inspection yielded a low findings rate of 0.2%. To promote efficiency, the initiative is therefore being optimized to target specific areas in the WUI that demonstrate higher loads during peak season (summer). In addition, a limited number of infrared inspections will be performed on covered conductor circuit segments to determine whether thermography is useful in identifying potential damage conditions to the covered conductor.

8.1.3.4 Transmission Infrared Inspections (WMP.482)

Transmission Infrared Inspections (WMP.482) utilize infrared technology to examine the radiation emitted by connections to determine if there are potential issues with a connection before failure. Findings are documented and required repair work is tracked through completion. Infrared patrols on transmission lines are most effective during higher loading conditions, therefore they typically begin in the warmer months prior to San Diego’s wildfire season. As corrosion, rust, and other structural impacts may cause hotspots on structures and equipment, all energized transmission lines are included in the scope of this program. The corrective work resulting from infrared inspections is described in Section 8.1.7 Open Work Orders. Figure 8-11 outlines the process for transmission infrared inspections.

Figure 8-11: Transmission Infrared Inspections Process Flow

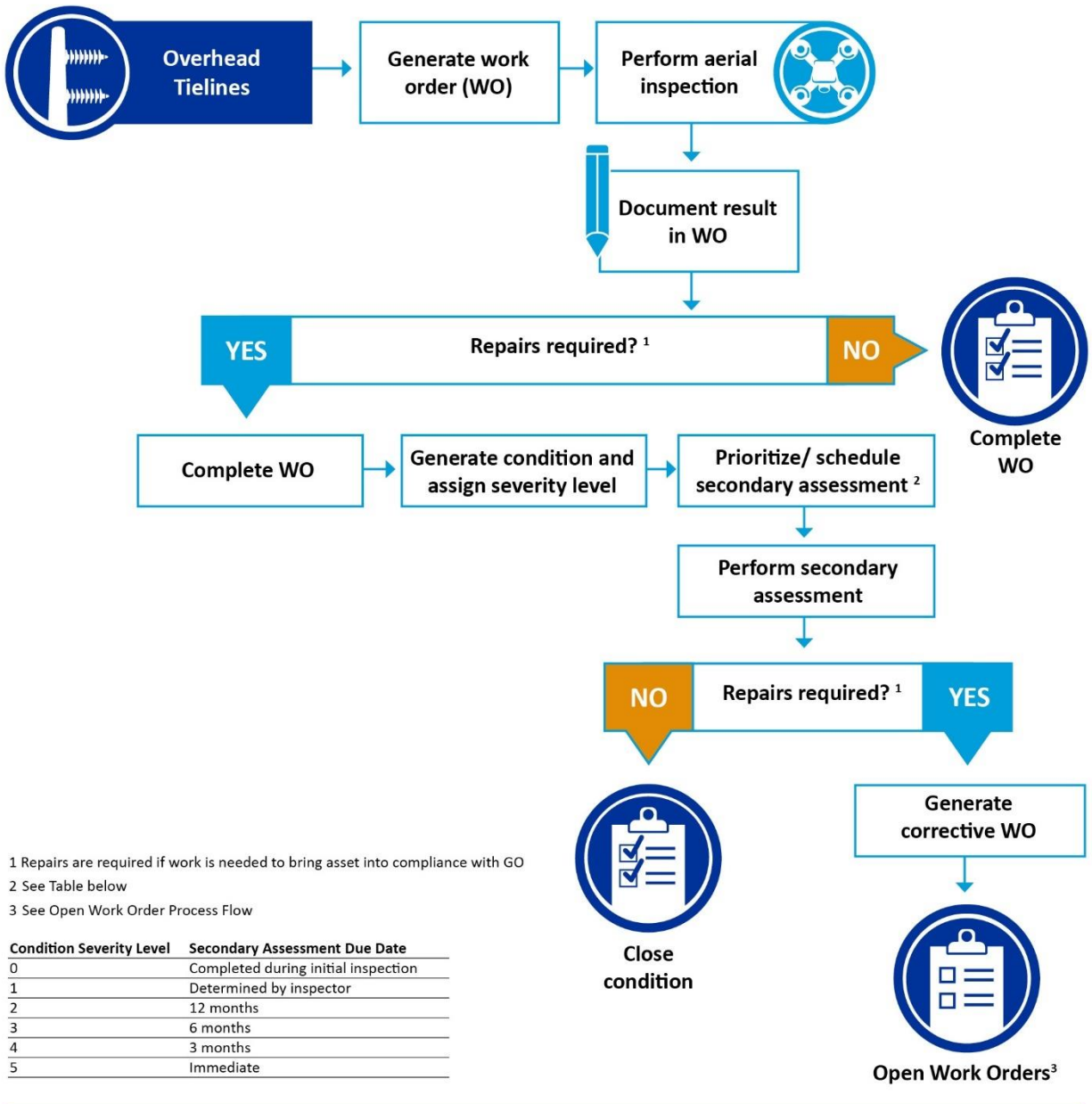

Transmission infrared inspections are currently completed on an annual basis for all energized tielines, including those in the HFTD. Non-routine infrared inspections may be performed prior to weather events based on meteorological data. Wind speed, FPI, and other factors are also analyzed to prioritize inspections prior to RFW or other events.

For existing programs, a 5-year historical average of hit rates (number of issues found at a given priority level divided by total inspections) was calculated and utilized to forecast future years based on the number of inspections in the HFTD for these programs.

Failure rate calculations (i.e., how many risk events would occur within a year if there were no inspections or repairs within the prescribed timeframes) were utilized to convert issues found into risk events. Finally, the average Transmission ignition rate for risk events and ignitions in the HFTD was used to convert risk events avoided to ignitions avoided. The ignitions avoided is calculated on an annual basis and can change depending on the inspection cycle. For 2023, an estimated 0.00 ignitions would occur if inspections and repairs were not completed in the prescribed timeframes as part of Transmission Infrared Inspections (WMP.482). Calculations are shown in SDG&E Table 8-14.

SDG&E Table 8-14: Risk Reduction Estimation for Transmission Infrared Inspections

Calculation Component	Component Value
Fail Rate Emergency	48%
Fail Rate Priority	4.80%
Fail Rate Non-Critical	0.40%
2023 Projected Inspection Findings Tier 3	0 + 0 + 0 = 0
2023 Projected Inspection Findings Tier 2	0 + 0 + 0 = 0
Risk events avoided Tier 3	$(0 \times 48\%) + (0 \times 4.8\%) + (0 \times 0.04\%) = 0$
Risk events avoided in Tier 2	$(0 \times 48\%) + (0 \times 4.8\%) + (0 \times 0.04\%) = 0$
Transmission ignition rate HFTD	5.58%
Ignitions avoided Tier 3	$0 \times 5.58\% = 0$
Ignitions avoided Tier 2	$0 \times 5.58\% = 0$
Total ignitions avoided HFTD	0 + 0 = 0

SDG&E has a mature transmission inspection and maintenance program and participates in internal and external desktop and field audits with positive results. Industry standards, emerging technologies are also reviewed to ensure best maintenance practices are utilized.

This program was successfully completed in 2022. Targets for 2023 and performance metrics for 2022 are provided in Section 8.1.1.2 Targets and Section 8.1.1.3 Performance Metrics, respectively.

There were no roadblocks encountered during 2022 and there are no plans to change the scope or frequency of this program. However, beginning in 2025, inspections performed in the WUI will be incorporated into the WMP reporting.

8.1.3.5 Distribution Wood Pole Intrusive Inspections (WMP.483)

GO 165 requires all wood poles over 15 years of age to be intrusively inspected within 10 years and all poles which previously passed intrusive inspection to be inspected intrusively again on a 20-year cycle. Distribution wood pole intrusive inspections (WMP.483) are performed on a 10-year cycle.

An intrusive inspection typically involves an excavation around the pole base and/or a sound and bore of the pole at ground-line. Depending on the cavities found or the amount of rot observed, an estimate of the remaining pole strength is determined utilizing industry-wide standards. Depending on the severity of the deterioration, the pole either passes inspection with greater than 80 percent strength remaining or is replaced. The corrective work for replacement is described in Section 8.1.7 Open Work Orders. Figure 8-12 outlines the wood pole intrusive inspection process.

Figure 8-12: Wood Pole Intrusive Inspections Process Flow (Transmission and Distribution)

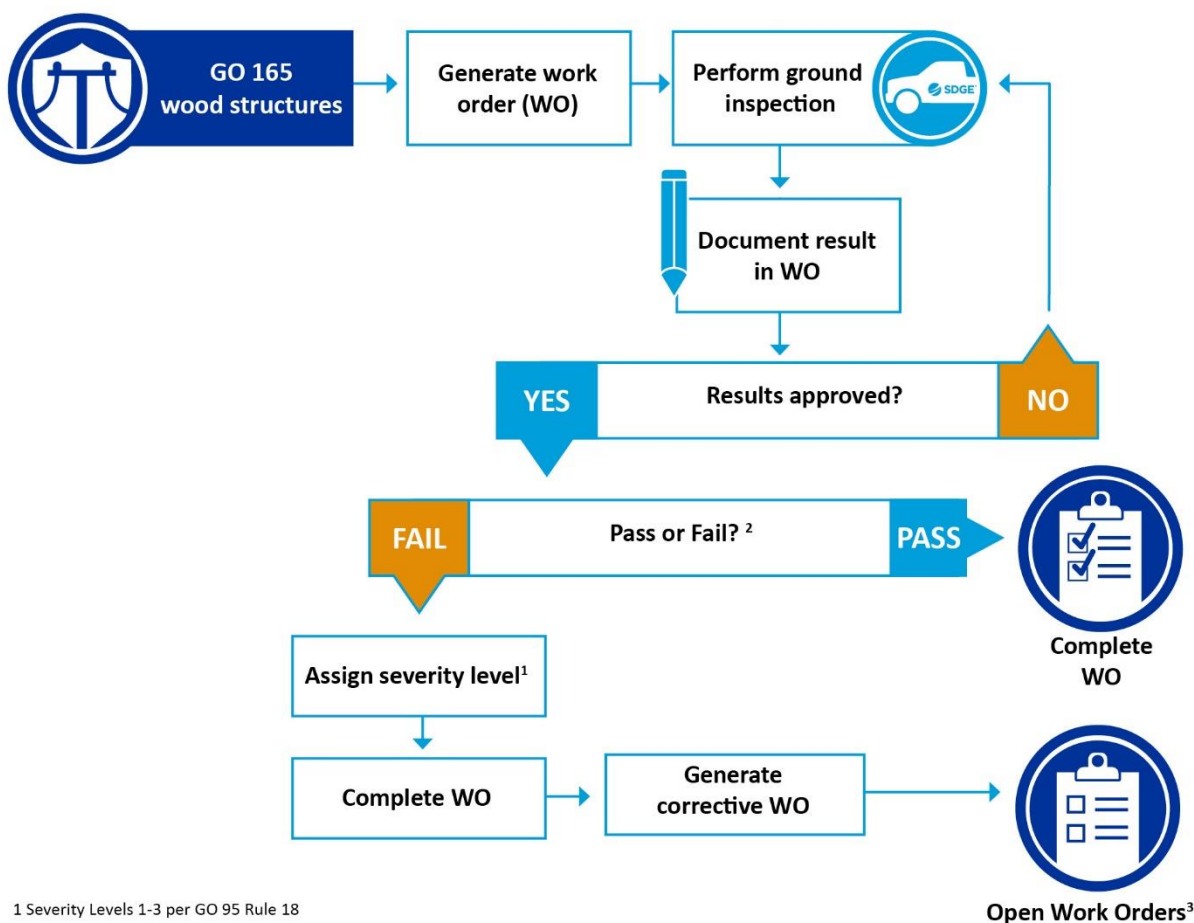

1 Severity Levels 1-3 per GO 95 Rule 18
 2 Pass pole: strength remaining greater than 80%
 Fail pole: strength remaining less than or equal to 80%
 3 See Open Work Order Process Flow

Distribution Wood Pole Intrusive inspections are currently performed on a 10-year cycle. Non-routine intrusive inspections may occur when current pole strength (percent strength remaining) information is needed for pole loading calculations during design work per GO 95.

For existing programs, a 5-year historical average of hit rates (number of issues found at a given priority level divided by total inspections) was calculated and utilized to forecast future years based on the

number of inspections in the HFTD for these programs. Failure rate calculations (i.e., how many risk events would occur within a year if inspections and repairs were not performed within the prescribed timeframes) were utilized to convert issues found into risk events. Finally, the average distribution ignition rates broken down by HFTD tier were utilized to calculate ignitions avoided due to the program. The ignitions avoided is calculated on an annual basis and can change depending on the inspection cycle. Distribution wood pole intrusive inspections (WMP.483) can vary from year to year, as some cycles do not involve many inspections in the HFTD, and some cycles can be over 90 percent within the HFTD. Given the inspection cycle for 2023, an estimated 0.0001 ignitions would be avoided in relation to the 10-year intrusive wood pole inspection program. Calculations are shown in SDG&E Table 8-15.

SDG&E Table 8-15: Risk Reduction Methodology for Distribution Wood Pole Intrusive Inspections

Calculation Component	Component Value
Fail Rate Emergency	48%
Fail Rate Priority	4.8%
Fail Rate Non-Critical	0.40%
2023 Projected Inspection Findings Tier 3	0 + 0 + 0 = 0
2023 Projected Inspection Findings Tier 2	0 + 0 + 1 = 1
Risk events Avoided Tier 3	$(0 \times 48\%) + (0 \times 4.8\%) + (0 \times 0.4\%) = 0$
Risk events Avoided Tier 2	$(0 \times 48\%) + (0 \times 4.8\%) + (1 \times 0.4\%) = 0.004$
Distribution Ignition rate Tier 3	2.91%
Distribution Ignition rate Tier 2	2.56%
Ignitions Avoided Tier 3	$0 \times 2.91\% = 0$
Ignitions Avoided Tier 2	$0.004 \times 2.56\% = 0.000102$
Total ignitions avoided HFTD	$0 + 0.000102 = 0.000102$

This program was successfully completed in 2022. Targets for 2023 and performance metrics for 2022 are provided in Section 8.1.1.2 Targets and Section 8.1.1.3 Performance Metrics, respectively.

Access issues can present challenges in performing intrusive inspections. Because intrusive inspections typically involve a minimal amount of ground disturbance around the base of the pole, authorizations to perform this work in environmentally sensitive areas can be a challenge and require added time and resources to perform. The frequency of non-routine inspections to support other WMP initiatives, such as grid hardening and asset replacement programs, can also impact routine work (reference GO 95 rule).

This program will continue in compliance with GO 165. A risk-informed approach to the performance of wood pole intrusive inspections will be evaluated to decide whether inspection cycles should be modified. SDG&E is planning to include data relative to steel poles in its risk-modeling in order to determine whether steel pole intrusive inspections should be included in our routine intrusive inspection efforts, including the frequency and scope of those steel pole inspections.

In 2022, this program was updated to remove the option of reinforcing a failed pole with less than 80 percent strength remaining in the HFTD. Instead, failed poles in the HFTD will be replaced. However, pole reinforcements that are in-flight will still be completed.

In addition, the internal audit program will be refined for distribution wood pole inspections and assessing modifications to reporting and work management through enhanced automation tools and technology. See Section 8.1.6.4 QA/QC of Transmission & Distribution Wood Pole Intrusive Inspections (WMP.1193) for additional details on the internal audit program.

8.1.3.6 Transmission Wood Pole Intrusive Inspections (WMP.1190)

GO 165 requires all wood poles over 15 years of age to be intrusively inspected within 10 years, and all poles which previously passed intrusive inspection to be inspected intrusively again on a 20-year cycle. SDG&E performs transmission wood pole intrusive inspections (WMP.1190) on an 8-year cycle.

An intrusive inspection typically involves an excavation around the pole base and/or a sound and bore of the pole at ground-line. Depending on the cavities found or the amount of rot observed, an estimate of the remaining pole strength is determined utilizing industry-wide standards. Depending on the severity of the deterioration, the pole either passes inspection, is reinforced with a steel truss, or is replaced. This replacement and reinforcement process is described in Section 8.1.7 Open Work Orders. The corrective work for replacement and reinforcement is described in Section 8.1.7 Open Work Orders. See Section 8.1.3.5 Distribution Wood Pole Intrusive Inspections (WMP.483) for details on the wood pole intrusive inspection process.

Transmission Wood Pole Intrusive inspections are currently completed on an 8-year cycle, which was reduced from a 10-year cycle in 2020. Non-routine intrusive inspections may occur when current pole strength (percent strength remaining) information is needed for pole loading calculations during design.

SDG&E has a mature transmission inspection and maintenance program and participates in internal and external desktop and field audits with positive results. Industry standards and emerging technologies are also reviewed to ensure best maintenance practices are utilized.

Access issues can present challenges in performing intrusive inspections and because intrusive inspections typically involve a minimal amount of ground disturbance around the base of the pole, authorizations to perform this work in environmentally sensitive areas can be a challenge and require added time and resources to perform. The frequency of non-routine inspections to support other WMP initiatives can also impact routine work (reference GO 95).

There are no plans to change the frequency of this program. However, beginning in 2025, inspections performed in the WUI will be incorporated into the WMP reporting. Additionally, some structures in the initial forecast are now steel structures that do not require an intrusive inspection, some were removed from service, and some were intrusively inspected in 2022 or 2023 and do not require an intrusive inspection in 2025.

8.1.3.7 Drone Assessments (WMP.552)

The DIAR Program (WMP.552) involves flight planning, drone flight and image capture, field observations, image assessment, determination of issues, and repair. Imagery collected by drones improves traditional ground inspections by providing inspectors with a “birds eye view” of overhead facilities, as well as high resolution imagery of overhead equipment and components. The use of drones to collect imagery enhances an inspector’s ability to identify potential fire hazards related to certain types of issues or where conditions such as terrain and vegetation density make full detailed inspections difficult. Issues that are more readily observed by the DIAR Program include damaged arresters,

damaged insulators, issues with pole top work, issues with armor rods, crossarm or pole top damage, exposed connections, loose hardware, improper splices, and damaged conductors.

Images and inspection findings are also used to build damage detection models that allow IIP technology to process imagery data and improve the quality of the DIAR Program assessments. See Section 8.1.5.4.3 for more information on IIP (WMP.1342). The process for corrective work resulting from DIAR inspections is described in Section 8.1.7 Open Work Orders. Figure 8-13 outlines the process for DIAR Program assessments.

Figure 8-13: Distribution Drone Inspections Process Flow

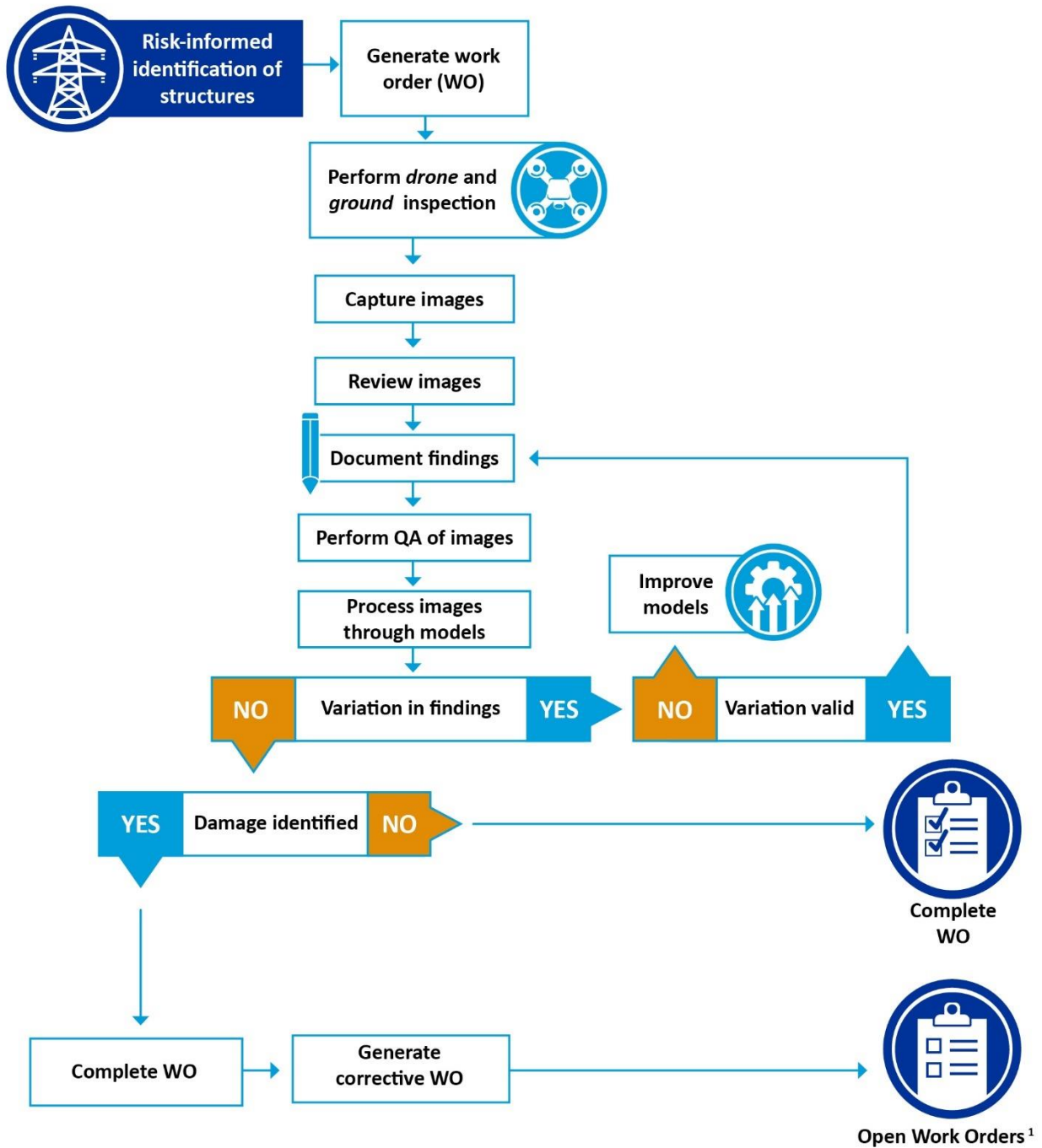

1 See Open Work Order Process Flow

The scope of the DIAR Program considers the riskiest 15 percent of overhead distribution structures within the HFTD and WUI. The structures selected for inspection are identified by using a semi-

automated Inspection Prioritization Model that combines PoF and consequence of failure (CoF) to determine structure risk and account for navigation efficiency (see Figure 8-14). The model aligns with existing methods considering MAVF to identify and quantify risk and is easily modified to account for new attributes or changes in scope. This creates a repeatable and traceable process to determine the 15 percent of structures that will be assessed in a given year. Enhancements have also been made to SAP to reduce redundancy in the DIAR Program while maintaining compliance with GO 165 timelines. Accordingly, distribution structures that undergo a drone inspection will not require an overhead detailed inspection or patrol if that structure is due for a detailed inspection or patrol in the same interval.

Drone assessments of transmission infrastructure from 2020 to 2022 yielded 1 to 2 percent rates of findings. This indicates that the existing aerial inspection efforts performed on transmission infrastructure are sufficient in identifying potential issues. To optimize the use of resources and the impact to ratepayers, ad-hoc drone inspections of transmission structures for operational and reliability need will be performed. In addition, inspections of transmission components of a structure will be performed where distribution is present (i.e., where there is distribution underbuild on a transmission structure) or as part of a special inspection. For example, ad-hoc drone inspections of transmission structures may occur in the following situations:

- If a fault or failure occurs or if there is data indicating a fault or failure may occur
- Prior to or after a severe weather or safety event
- If a comprehensive ground inspection is not possible or difficult because of terrain or other access issues
- To support or supplant a climbing inspection

Figure 8-14: DIAR Inspection Prioritization Model

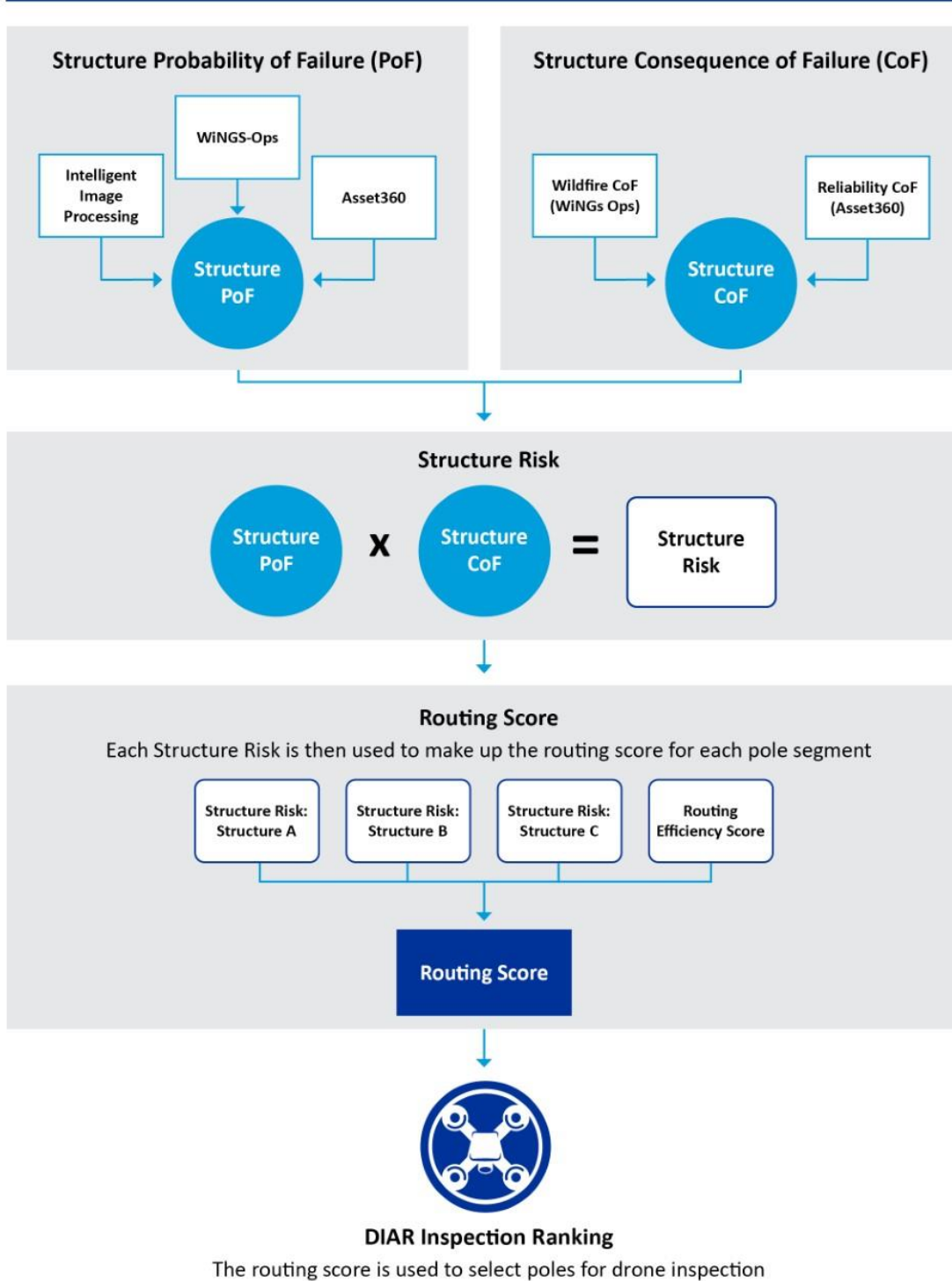

For existing programs, a 5-year historical average of hit rates (number of issues found at a given priority level divided by total inspections) was calculated and utilized to forecast future years based on the number of inspections in the HFTD for these programs. Failure rate calculations (i.e., how many risk events would occur within a year if inspections and repairs were not performed within the prescribed timeframes) were utilized to convert issues found into risk events. Finally, the average distribution ignition rates broken down by HFTD Tier were utilized to calculate ignitions avoided due to the program. The ignitions avoided is calculated on an annual basis, and can change depending on the inspection cycle.

For 2023, an estimated 0.3575 ignitions would occur if inspections and repairs were not completed in the prescribed timeframes as part of the DIAR Program (WMP.552). Calculations are shown in SDG&E Table 8-16.

SDG&E Table 8-16: Risk Reduction Methodology for the DIAR Program

Calculation Component	Component Value
Fail Rate Emergency	48%
Fail Rate Priority	4.8%
Fail Rate Non-Critical	0.40%
2023 Projected Inspection Findings Tier 3	$8 + 120 + 671 = 799$
2023 Projected Inspection Findings Tier 2	$30 + 451 + 2,026 = 2,507$
Risk events Avoided Tier 3	$(8 \times 48\%) + (120 \times 4.8\%) + (671 \times 0.4\%) = 12.284$
Risk events Avoided Tier 2	$(30 \times 48\%) + (451 \times 4.8\%) + (2,026 \times 0.4\%) = 44.152$
Distribution Ignition rate Tier 3	2.91%
Distribution Ignition rate Tier 2	2.56%
Ignitions Avoided Tier 3	$12.284 \times 2.91\% = 0.3575$
Ignitions Avoided Tier 2	$44.152 \times 2.56\% = 1.130291$
Total ignitions avoided HFTD	$0.3575 + 1.130291 = 1.487791$

From 2019 to 2022, drone inspections of all distribution poles in Tier 2 and Tier 3 of the HFTD and coastal canyon areas within the WUI were completed. Authorizations were also successfully negotiated from California State Parks to complete drone inspections for distribution poles within State Parks jurisdiction. Targets for 2023 and performance metrics for 2022 are provided in Section 8.1.1.2 Targets and Section 8.1.1.3 Performance Metrics, respectively.

The DIAR Program has collected over 2.3 million images for over 85,000 distribution structures. Those images have enabled the development of over 96 machine learning models, including 48 asset detection models and 24 damage detection models. The accuracy of these models continues to evolve with a current average accuracy of 86 percent on the 20 damage detection models running daily. In addition, an IIP Platform (WMP.1342) was developed to not only run the machine learning models on images collected, but to store those images geospatially and support use cases for imagery from other internal departments.

The semi-automated Inspection Prioritization Model was also developed to identify the scope of the DIAR Program in 2023 and beyond. This model supports the incorporation of the DIAR Program into traditional inspection efforts.

With the successful acquisition of authorizations to fly drones on Department of Defense and California State Parks lands, many roadblocks to the DIAR Program have been eliminated. However, there are several compliance requirements within these authorizations that require significant labor resources to maintain. This impacts the cost of implementing the program. Negative customer interactions (hostile customers) and access issues on private and Tribal land remain the primary roadblocks for inspections and resolving inspection findings.

The scope of the DIAR Program has evolved since HFTD inspections were completed in 2022. For the 2023-2025 WMP cycle, the Inspection Prioritization Model will be used to determine structures to inspect in the given year. Assessment results will be utilized as a baseline to improve the Inspection Prioritization Model, which will allow inspection efforts to be better focused, and more efficient.

In addition to improving what is inspected and when, IIP models enhance the ability to process large amounts of data quickly with less dependency on human resources. More inspections of specific equipment and pole components can be performed without overburdening inspection resources. For example, images collected from mobile devices or by a fleet vehicle could identify a potential issue on an asset not scheduled for inspection in that cycle or could help detect less severe issues that would not require a repair at the time of inspection but would influence the Inspection Prioritization Model and help indicate a follow-up inspection should be conducted in a reduced timeframe.

8.1.3.8 Distribution Overhead Patrol Inspections (WMP.488)

GO 165 requires utilities to patrol their systems annually in HFTD Tier 2 and Tier 3 and in urban areas. Patrol inspections in rural areas outside of the HFTD are required once every 2 years. However, as a long-standing practice SDG&E performs patrol inspections in all areas on an annual basis. Identified issues and corrective work are tracked, demonstrating their effectiveness. The corrective work resulting from patrol inspections is described in Section 8.1.7 Open Work Orders. Figure 8-15 outlines the distribution patrol inspection process.

Figure 8-15: Distribution Patrol Inspections Process Flow

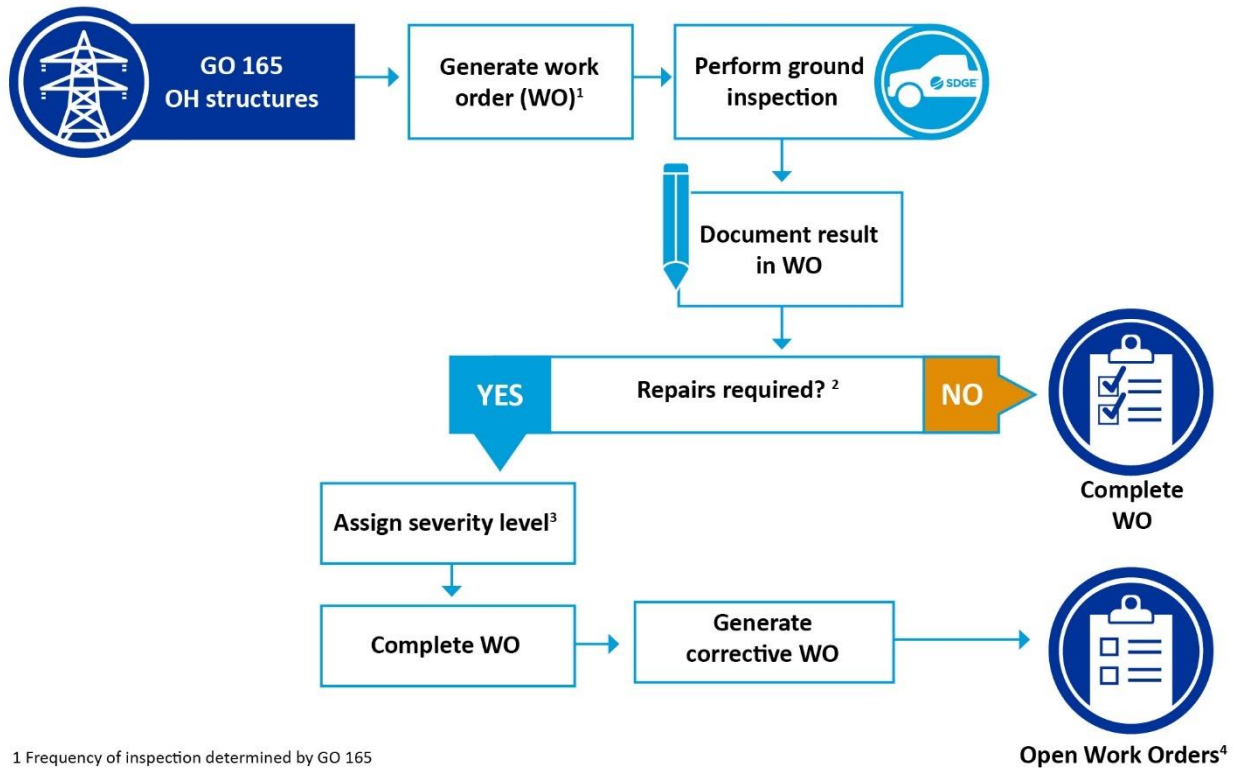

1 Frequency of inspection determined by GO 165

2 Repairs are required if work is needed to bring asset into compliance with GO

3 Severity Levels 1-3 per GO 95 Rule 18

4 See Open Work Order Process Flow

Distribution patrol inspections are currently completed on an annual basis on all structures, including those in the HFTD. Non-routine patrol inspections may occur for safety, reliability, or operational needs. For example, patrol inspections are performed on all distribution structures potentially affected by or affected by a PSPS event prior to and after the PSPS event.

Additionally, patrols are prioritized in the HFTD prior to wildfire season (defined in Appendix A).

For existing programs, a 5-year historical average of hit rates (number of issues found at a given priority level/total inspections) was calculated and utilized to forecast future years based on the number of inspections in the HFTD for these programs. SDG&E’s failure rate calculations (i.e., how many risk events would occur within a year should SDG&E not have inspected and repaired issues within the prescribed timeframes) were utilized to convert issues found into risk events. Finally, the average distribution ignition rates broken down by HFTD tier were utilized to calculate ignitions avoided due to the program. The ignitions avoided is calculated on an annual basis. For 2023, an estimated 0.528 ignitions would occur should SDG&E stop completing inspections and repairs in the prescribed timeframes as part of annual distribution overhead patrol inspections (WMP.488). A summary of the calculation is provided in SDG&E Table 8-17.

SDG&E Table 8-17: Risk Reduction Estimation Methodology for Distribution Overhead Patrol Inspections

Calculation Component	Component Value
5-year average hit rate Emergency (0-3 days)	0.001
5-year average hit rate Priority (4-30 days)	0.001
5-year average hit rate Non-Critical	0.055
Fail Rate Emergency	48%
Fail Rate Priority	4.8%
Fail Rate Non-Critical	0.40%
2023 Projected Inspection Findings Tier 3	$16 + 16 + 167 = 199$
2023 Projected Inspection Findings Tier 2	$18 + 18 + 193 = 229$
Risk events Avoided Tier 3	$(16 \times 48\%) + (16 \times 4.8\%) + (167 \times 0.4\%) = 9.116$
Risk events Avoided Tier 2	$(18 \times 48\%) + (18 \times 4.8\%) + (193 \times 0.4\%) = 10.276$
Distribution Ignition rate Tier 3	2.91%
Distribution Ignition rate Tier 2	2.56%
Ignitions Avoided Tier 3	$9.116 \times 2.91\% = 0.265$
Ignitions Avoided Tier 2	$10.276 \times 2.56\% = 0.263$
Total ignitions avoided HFTD	$0.265 + 0.263 = 0.528$

This program was successfully completed in 2022. Targets for 2023 and performance metrics for 2022 are provided in Section 8.1.1.2 Targets and Section 8.1.1.3 Performance Metrics, respectively.

Access issues remain the primary constraint related to the performance of patrols.

The DIAR Program (WMP.552) will continue to be administered in compliance with GO 165. In addition, patrol inspections will be enhanced by running imagery collected by drones, fleet, or mobile devices through the damage detection machine learning models to further reduce the risk of an ignition, fault, or failure event with minimal impact to inspection resources. In 2023, drone pilots will begin capturing imagery of approximately 1,000 distribution structures located within the HFTD and not scheduled for a patrol or detailed overhead visual inspection in the calendar year. Structures will be selected using the Inspection Prioritization Model. Images will run through machine learning models and images identified with a potential issue will be reviewed by a qualified inspector. If the inspector validates that the issue identified by the machine learning model is accurate and needs repair, a corrective work order will be generated (see Section 8.1.7 Open Work Orders for corrective work order process).

If this effort is successful, drone patrols using IIP (WMP.1342) will continue throughout this WMP cycle and additional imagery collected by mobile devices or fleet may be added to the scope of enhanced patrol inspections.

8.1.3.9 Transmission Overhead Patrol Inspections (WMP.489)

Transmission visual patrols are conducted annually by helicopter on all overhead tielines, including those in the HFTD. The visual patrols provide an overhead view of structures and components to identify

issues such as cracked pole tops or rust/corrosion and larger issues that can pose a fire risk or risk to public safety. The corrective work resulting from patrol inspections is described in Section 8.1.7 Open Work Orders. Figure 8-16 outlines the transmission patrol inspection process (WMP.489).

Figure 8-16: Transmission Patrol Overhead Inspections Process Flow

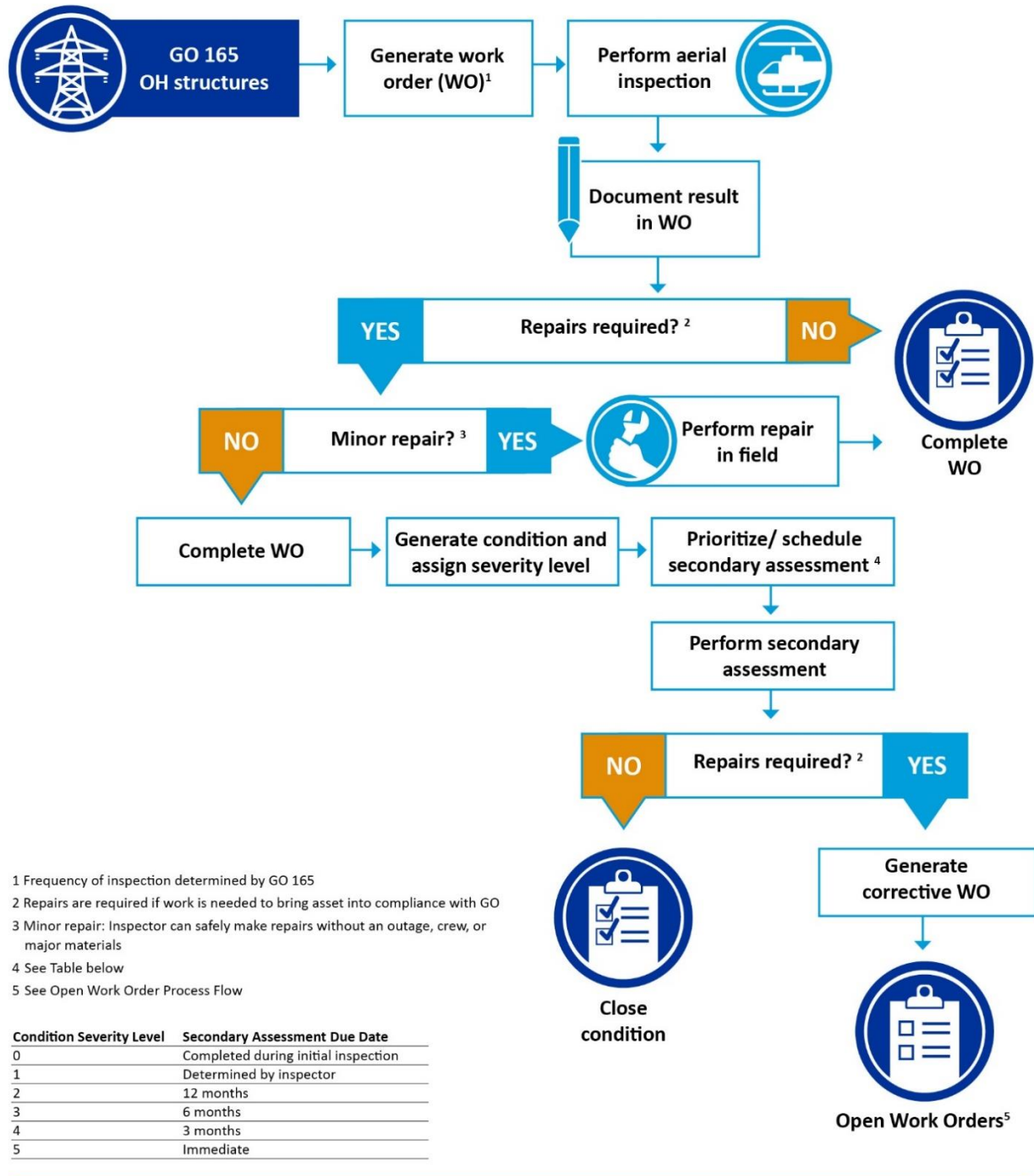

Patrols are performed annually on all tielines, including those in the HFTD. Inspections are prioritized based on the last inspection date to ensure that each tieline receives a patrol inspection within a 12-

month period. In addition, a Tier 3 patrol inspection on all 69 kV tielines is completed prior to September 1 of any given year, the beginning of wildfire season. See Section 8.1.3.10 Transmission 69 kV Tier 3 Visual Inspections (WMP.555) for more information on additional Tier 3 patrol inspections.

For existing programs, a 5-year historical average of hit rates (number of issues found at a given priority level/total inspections) was calculated and utilized to forecast future years based on the number of inspections in the HFTD for these programs. SDG&E’s failure rate calculations (i.e., how many risk events would occur within a year should SDG&E not have inspected and repaired issues within the prescribed timeframes) were utilized to convert issues found into risk events. Finally, the average ignition rate for transmission risk events and ignitions in the HFTD was utilized to convert from risk events avoided to ignitions avoided. The ignitions avoided is calculated on an annual basis. For 2023, an estimated 0.003 ignitions are avoided as a result of transmission overhead patrol inspections (WMP.489). A summary of the calculation is provided in SDG&E Table 8-18.

SDG&E Table 8-18: Risk Reduction Methodology for Transmission Overhead Patrol Inspections

Calculation Component	Component Value
Fail Rate Emergency	48%
Fail Rate Priority	4.80%
Fail Rate Non-Critical	0.40%
2023 Projected Inspection Findings Tier 3	0 + 0 + 0 = 0
2023 Projected Inspection Findings Tier 2	0 + 1 + 0 = 1
Risk events Avoided Tier 3	$(0 \times 48\%) + (0 \times 4.8\%) + (0 \times 0.4\%) = 0$
Risk events Avoided Tier 2	$(0 \times 48\%) + (1 \times 4.8\%) + (0 \times 0.4\%) = 0.048$
Transmission Ignition rate HFTD	5.58%
Ignitions Avoided Tier 3	$0 \times 5.58\% = 0$
Ignitions Avoided Tier 2	$0.048 \times 5.58\% = 0.003$
Total ignitions avoided HFTD	$0 + 0.003 = 0.003$

SDG&E has a mature transmission inspection and maintenance program and participates in internal and external desktop and field audits with positive results. Industry standards, emerging technologies are also reviewed to ensure best maintenance practices are utilized. Detailed inspections were successfully completed in 2022.

Targets for 2023 and performance metrics for 2022 are provided in Section 8.1.1.2 Targets and Section 8.1.1.3 Performance Metrics, respectively.

There were no roadblocks encountered during 2022 and there are no plans to change the scope or frequency of this program. However, beginning in 2025, inspections performed in the WUI will be incorporated into the WMP reporting.

8.1.3.10 Transmission 69 kV Tier 3 Visual Inspections (WMP.555)

In addition to the annual visual patrol and infrared inspections (WMP.489 and WMP.482), a patrol of all 69 kV structures located in Tier 3 of the HFTD is performed prior to September 1 each year. Similar to

the yearly inspection, these inspections are designed to identify obvious structure problems and hazards prior to fire season. The corrective work resulting from these visual inspections is described in Section 8.1.7 Open Work Orders. Figure 8-17 outlines the process for these additional patrols.

Figure 8-17: Transmission Tier 3 69 kV Inspections Process Flow

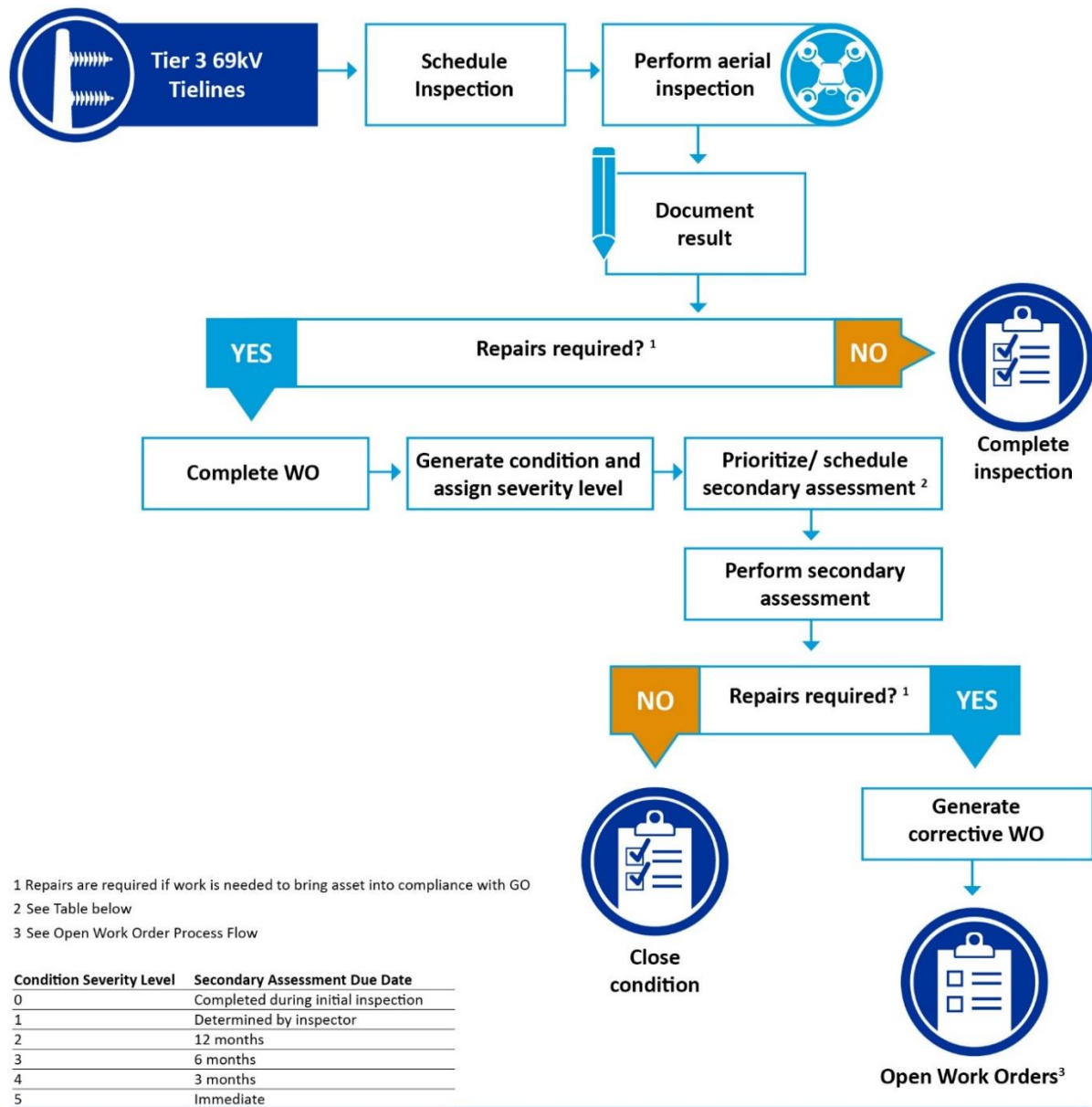

69 kV Tier 3 inspections are currently performed on an annual basis and completed prior to September 1 of each year.

For existing programs, a 5-year historical average of “hit rates” (number of issues found at a given priority level divided by total inspections) was calculated and utilized to forecast future years based on the number of inspections in the HFTD for these programs. Failure rate calculations (i.e., how many risk events would occur within a year if inspections and repairs were not performed within the prescribed timeframes) were utilized to convert issues found into risk events. Finally, the average ignition rate for transmission risk events and ignitions in the HFTD was utilized to convert from risk events avoided to ignitions avoided. The ignitions avoided is calculated on an annual basis. For 2023, an estimated 0.00 ignitions would occur if inspections and repairs are not performed in the prescribed timeframes as part of transmission 69 kV Tier 3 visual inspections (WMP.555). Calculations are shown in SDG&E Table 8-19.

SDG&E Table 8-19: Risk Reduction Estimation for Transmission 69 kV Tier 3 Visual Inspections

Calculation Component	Component Value
Fail Rate Emergency	48%
Fail Rate Priority	4.80%
Fail Rate Non-Critical	0.40%
2023 Projected Inspection Findings Tier 3	0 + 1 + 0 = 1
2023 Projected Inspection Findings Tier 2	0 + 0 + 0 = 0
Risk events Avoided Tier 3	$(0 \times 48\%) + (1 \times 4.8\%) + (0 \times 0.4\%) = 0.048$
Risk events Avoided Tier 2	$(0 \times 48\%) + (0 \times 4.8\%) + (0 \times 0.4\%) = 0$
Transmission Ignition rate HFTD	5.58%
Ignitions Avoided Tier 3	$0.048 \times 5.58\% = 0.002678$
Ignitions Avoided Tier 2	$0 \times 5.58\% = 0$
Total ignitions avoided HFTD	$0.002678 + 0 = 0.002678$

SDG&E has a mature transmission inspection and maintenance program and participates in internal and external desktop and field audits with positive results. Industry standards and emerging technologies are also reviewed to ensure best maintenance practices are utilized. Detailed inspections were successfully completed in 2022.

Targets for 2023 and performance metrics for 2022 are provided in Section 8.1.1.2 Targets and Section 8.1.1.3 Performance Metrics, respectively.

There were no roadblocks encountered during 2022 and there are no plans to change the scope or frequency of this program.

8.1.3.11 Substation Patrol Inspections (WMP.492)

The Substation Inspection and Maintenance Program (WMP.492) identifies substation equipment deterioration to make repairs or replacements before a failure occurs, as mandated by GO 174. The program is conducted primarily for reliability; however, it also provides incidental wildfire mitigation benefits within the HFTD and the WUI. The Substation Inspection and Maintenance Program schedules routine inspections at recurring cycles. These inspections consist of a monthly or bimonthly patrol inspection where equipment is inspected and problems, such as oil leaks, are identified. When issues are

identified during an inspection, corrective work orders are opened with a severity level of either immediate (within 7 days) or within the next 12 months. While patrol inspections primarily focus on substation assets, switchyard vegetation hazards are also identified and corrective maintenance is addressed. The corrective work for substation patrol inspections is described in Section 8.1.7 Open Work Orders. Figure 8-18 outlines the substation patrol inspection process.

Figure 8-18: Substation Patrol Inspection Workflow

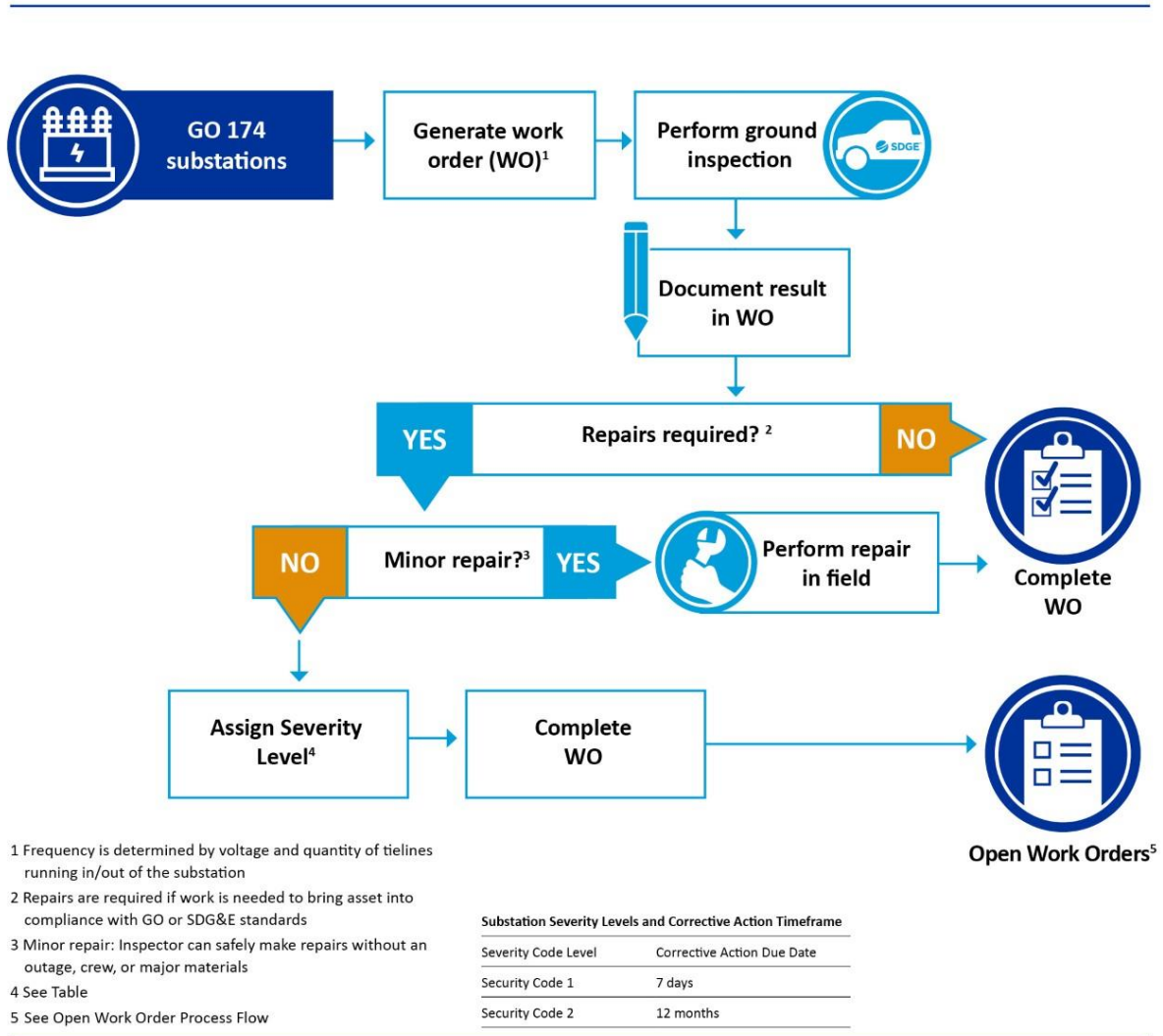

Substation Patrol Inspections are currently performed on a monthly or bi-monthly basis depending on certain criteria. Priority 1 substations have an operating voltage above 200 kV or have four or more transmission lines at or above 69 kV. These substations are patrolled monthly. All other substations are categorized as Priority 2 and are patrolled once every 2 months.

This program was successfully completed in 2022. Targets for 2023 and performance metrics for 2022 are provided in Section 8.1.1.2 Targets and Section 8.1.1.3 Performance Metrics, respectively.

A system enhancement is currently being implemented to autogenerate corrective maintenance orders for frequently identified findings during patrol inspections. SDG&E Table 8-20 shows findings that will result in an autogenerated corrective maintenance order.

SDG&E Table 8-20: Findings that Trigger Autogenerated Corrective Maintenance Order

Finding	Description of finding
Vegetation Overgrowth	Heavy or hazardous overgrowth
Fence Repair	Fence height less than 7 feet minimum, or fence grounds are cut or vandalized
Breather Desiccant	Desiccant indicates expiration in LTC transformers
Petro Pipes	Switchyard and LTC Transformer containment pits

Autogenerating corrective maintenance orders has resulted in a high volume of Breather Desiccant alerts. This appears to be due to the recent implementation of a new desiccant color. The unusually high volume is being investigated and additional training will be provided to the inspectors for desiccant review. This issue does not impact SDG&E’s ability to complete timely inspections.

In 2022, an internal periodic review of substation patrol inspections was implemented. Results of this internal review will inform future updates to the program and revisions to inspector training and procedures as needed. See Section 8.1.6.5 QA/QC of Substation Inspections (WMP.1194) for more information on periodic reviews.

8.1.3.12 Discontinued Asset Inspection Programs

8.1.3.12.1 LiDAR Inspections of Distribution Electric Lines and Equipment

In 2022, all circuits within the HFTD had LiDAR data captured and processed. LiDAR data was used to perform vegetation risk analysis on selected circuits within the HFTD. Because the entire HFTD was captured, a large-scale LiDAR collection initiative will not be implemented again for several years. However, LiDAR will continue to be captured to support pole loading calculations needed for system hardening projects such as covered conductor and traditional overhead hardening and corrective work orders involving pole or crossarm replacements. LiDAR is needed to complete PLS-CADD during pre-construction and post-construction to verify compliance with GO 95 and SDG&E standards and specifications. See Section 8.1.2.1 and Section 8.1.2.5 for more information on covered conductor and traditional overhead hardening, respectively (WMP.455, WMP.543).

Performance metrics for 2022 are provided in Section 8.1.1.3.

8.1.3.12.2 HFTD Tier 3 Distribution Pole Inspections

Additional HFTD Tier 3 distribution pole inspections were conducted from 2010 through 2016 as a result of a settlement agreement adopted in D.10-04-047. In 2017, SDG&E decided to proactively continue the HFTD Tier 3 Quality Assessment/Quality Control (QA/QC, WMP.193) inspections as part of its regular inspection program. However, in an effort to implement risk-informed inspections, SDG&E is discontinuing the HFTD Tier 3 QA/QC inspections in its current form and replacing it with risk-informed drone inspections described in Section 8.1.3.7 Drone Assessments (WMP.552). There are no plans to change the frequency of this program. However, beginning in 2025, inspections performed in the WUI

will be incorporated in the WMP reporting. This change focuses on risk reduction by increasing the potential scope of inspections to the entire HFTD and coastal canyons within the WUI rather than only HFTD Tier 3.

This program was successfully completed in 2022, and performance metrics for 2022 are provided in 8.1.1.3.

8.1.4 Equipment Maintenance and Repair (WMP.1130)

8.1.4.1 Maintenance, Repair, and Replacement Strategies

SDG&E operates within a Safety Management System (SMS) founded on a proactive, risk-informed, data-driven approach to effectively manage risk and safety. SMS is a systematic, enterprise-wide cohesive framework to collectively manage and reduce risk and exposure and promote continuous improvement in safety performance through deliberate, routine, and intentional processes. SMS processes include the identification, prevention, control, and mitigation of potential safety incidents (e.g., fire, asset failure, injury). Having the necessary asset maintenance and testing procedures help mitigate the risk of an asset failure or safety incident.

Asset maintenance and replacement strategies vary by equipment type and are determined based on asset criticality. Figure 8-19 summarizes the strategies that are utilized for each equipment type based on asset criticality. These replacement strategies promote public safety and meet or exceed regulatory mandates and industry best practices. At a minimum, all equipment is maintained with a time-based inspection cycle (see Section 8.1.3 Asset Inspections).

Maintenance and replacement of assets beyond what is required by regulation is determined based on asset condition and risk when such information is available. The Asset 360 platform (WMP.1341) was created to enable development of asset health indices, equipment failure analysis, and predictive risk modeling. Such analysis can result in the need for a proactive maintenance or replacement strategy. Some examples include grid hardening initiatives (see Section 8.1.2 Grid Design and System Hardening), replacing fiber-wrapped poles where the fiber wrap is end of life, transmission lattice tower hardening, and polymer insulator replacements. See Section 8.1.5.4.2 for details on Asset 360.

Figure 8-19: Asset Criticality and Maintenance/Replacement Strategies

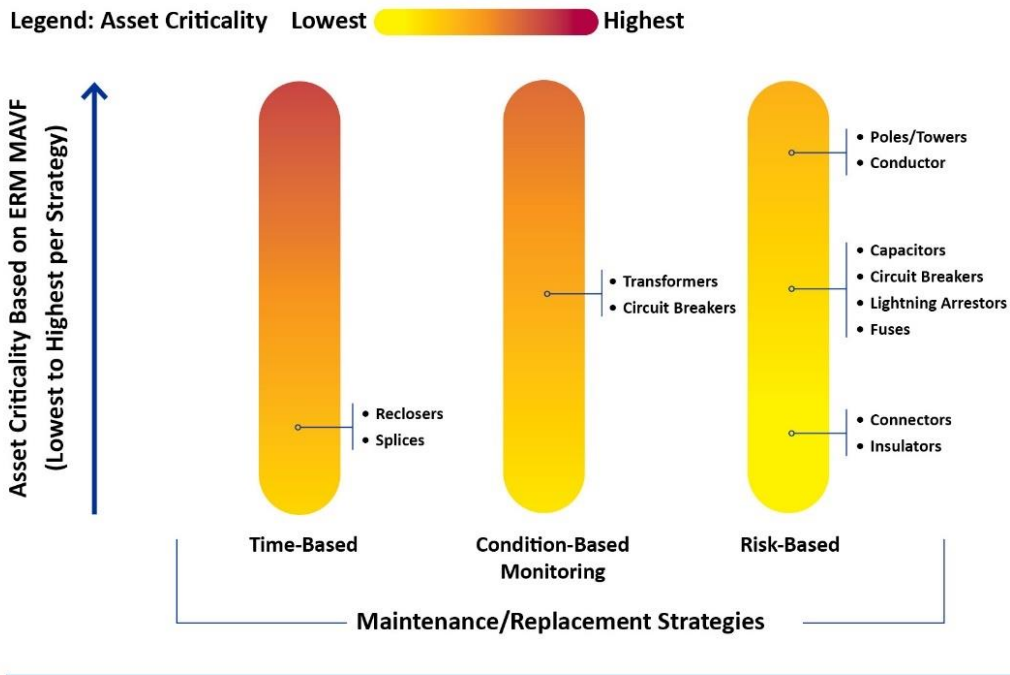

SDG&E Table 8-21 defines current maintenance and replacement strategies by equipment type and identifies specific programs and initiatives.

SDG&E Table 8-21: Maintenance and Replacement Strategies

Maintenance/Replacement Strategy	Definition	Equipment Type	WMP Initiative (or other)
Reactive	This strategy is utilized to maintain/replace an asset or equipment when an asset or equipment is operated until it stops functioning per its specifications. This is a reactionary strategy since the asset is only replaced when it fails. It is used for lower risk assets that do not impact public safety.	All equipment, when needed	Asset Inspections WMP.478; WMP.479; WMP.481; WMP.482; WMP.483; WMP.1190; WMP.488; WMP.489; WMP.555; WMP.492
Time-based (Interval-based)	This strategy is utilized to maintain/replace an asset or equipment that does not meet acceptance criteria found during a routine, cyclical inspection. The inspection cycle may be determined by regulatory mandates, equipment manufacturer recommendation, or industry best practice.	All equipment as required	Asset Inspections WMP.478; WMP.479; WMP.481; WMP.482; WMP.483; WMP.1190; WMP.488; WMP.489; WMP.555; WMP.492
Condition-based Monitoring	This strategy is utilized to maintain/replace an asset or equipment when certain attributes of the asset or equipment exceed the defined thresholds as alerted by a continuous monitoring system. This strategy requires continuous monitoring and analysis	Substation transformers and circuit breakers	Other Substation CBM program WMP.492

Maintenance/Replacement Strategy	Definition	Equipment Type	WMP Initiative (or other)
	of key health data of an asset such as age, location, gassing, number of operations, electrical loading, and temperature.		
Risk-based	This strategy is utilized to maintain/replace an asset or equipment based on the probability and consequence of failure. While the automated condition-based strategy considers the health of the asset, which is often a proxy for the likelihood of failure, the risk-based strategy considers the consequence of failure of the assets in addition to the health of the asset.	Poles/Towers Conductor Capacitors Lightning Arresters Fuses Connectors Insulators	Grid Hardening Initiatives WMP.453; WMP.459; WMP.464; WMP.550 Risk-based inspections WMP.481; WMP.552

8.1.4.2 Impact of Inspection Programs

A study was performed to measure the effectiveness of repair timeframes at preventing equipment failures. Results of the study also provided baseline data for the estimation of the effectiveness of inspection programs at preventing risk events and ignitions.

The methodology for the study was as follows:

1. Five years of reliability data and corrective maintenance data were queried.
2. The reliability data set was filtered into risk events.
3. The data set was further filtered to look at equipment failures only which are the primary target of the CMP.
4. CMP data was queried to identify all infractions associated with structures and when those infractions were repaired.
5. To and from fields of the risk data set were used to identify structures that had risk events associated with structures that had pending corrective maintenance infractions.

The results of the study show that the CMP and repair timeframes are effective at preventing equipment failures (see SDG&E Table 8-22). For the purpose of estimating the effectiveness of inspections, the 0.40 percent rate of infractions that led to failures is used to forecast priority and emergency fail rate. This failure rate will be scaled up with severity of inspection findings.

SDG&E Table 8-22: Risk Event Rate with Pending Infractions

	5-Year Total	Annual Average
Risk events with pending infractions	8	2
Total equipment risk events	2,009	402
Risk event rate with pending infractions	0.40%	0.40%

8.1.4.3 SCADA Capacitors Maintenance and Replacement Program (WMP.453)

8.1.4.3.1 Utility Initiative Tracking ID

WMP.453

8.1.4.3.2 Overview of the Activity

Current capacitors are designed to provide continuous voltage and power factor correction for the distribution system. During a failure of a capacitor from either mechanical, electrical, or environmental overstress, an internal fault is created resulting in internal pressure and the potential to rupture the casing. This rupture of molten metal has the potential to be an ignition source. Capacitor faults are currently protected through fusing, which is not always effective at preventing this high-risk failure from becoming an ignition source.

The SCADA Capacitors Maintenance and Replacement Program (WMP.453) was developed to replace existing non-SCADA capacitors with a more modern SCADA-switchable capacitor or to remove non-SCADA capacitors if not required for voltage or reactive support. These modernized capacitors have a monitoring system to check for imbalances and isolate internal faults before they become catastrophic. SCADA capacitors also have the capacity for remote isolation and monitoring of the system which provides additional situational awareness during extreme weather conditions. The SCADA Capacitors Maintenance and Replacement Program prioritizes replacing or removing fixed capacitors from service and then addresses capacitors with switches. Both types of capacitors will be modernized to a SCADA switchable capacitor. While this program will not reduce capacitor faults, the advanced protection equipment is designed to detect and isolate issues before a capacitor rupture occurs, reducing the failure mode most likely to lead to an ignition.

8.1.4.3.3 Impact of the Activity on Wildfire Risk

The SCADA Capacitors Maintenance and Replacement Program (WMP.453) will detect and isolate issues before a capacitor rupture occurs, reducing the failure mode most likely to lead to an ignition. It is estimated that the SCADA Capacitors Maintenance and Replacement Program will reduce Capacitor Caused HFTD ignitions by 0.0006 by 2025. Calculations are shown in SDG&E Table 8-23.

SDG&E Table 8-23: Risk Reduction Estimation for SCADA Capacitors

Calculation Component	Component Value
Risk Events Tier 3 (average 2017-2021)	0.2
Risk Events Tier2 (average 2017-2021)	1
Risk Events Non-HFTD (average 2017-2021)	9.2
Average Ignition Rate Tier 3	0.0291
Average Ignition Rate Tier 2	0.0256
Average Ignition Rate Non-HFTD	0.0113
Effectiveness Estimate	0.8
Ignition Reduction Estimate Tier 3	$0.2 \times 2.91\% \times 80\% = 0.004656$
Ignition Reduction Estimate Tier 2	$1 \times 2.55\% \times 80\% = 0.0204$
Ignition Reduction Estimate Non-HFTD	$9.2 \times 1.13\% \times 80\% = 0.083168$

Calculation Component	Component Value
Capacitors in Tier 3	37
Capacitors in Tier 2	69
Capacitors in the Non-HFTD	597
Capacitors in the Tier 3 HFTD (2023-2025)	0
Capacitors in the Tier 2 HFTD (2023-2025)	2
Capacitors in the Non-HFTD (2023-2025)	13
Ignitions reduced Tier 3 HFTD	$0.004656 \times (0 \div 37) = 0$
Ignitions reduced Tier 2 HFTD	$0.0204 \times (2 \div 69) = 0.0006$
Ignitions reduced non-HFTD	$0.083168 \times (13 \div 597) = 0.0018$
Ignitions reduced	$0 + 0.0006 + 0.0018 = 0.0024$

8.1.4.3.4 Impact of the Activity on PSPS Risk

The purpose of the SCADA Capacitors Maintenance and Replacement Program (WMP.453) is to reduce the risk of wildfire. This program does not affect the PSPS risk.

8.1.4.3.5 Updates to the Activity

In 2022, the SCADA Capacitors Maintenance and Replacement Program (WMP.453) expanded to the WUI. These are areas within a 2-mile buffer outside the HFTD whose surrounding areas make them prone to fire ignition.

8.1.4.4 Expulsion Fuse Replacement Program (WMP.459)

8.1.4.4.1 Utility Initiative Tracking ID

WMP.459

8.1.4.4.2 Overview of the Activity

When the distribution system experiences a fault or overcurrent, there are fuses connected to the system to protect its integrity and isolate the fault. These expulsion fuses are designed to operate by creating a significant expulsion within the fuse, resulting in the fuse opening and isolating the fault, and in turn limiting further damage to other equipment. Because of this internal expulsion, the fuses are equipped with a venting system that sends a discharge of energy out of the fuse and into the atmosphere. This external discharge has the potential to ignite flammable vegetation.

The Expulsion Fuse Replacement Program (WMP.459) replaces existing expulsion fuses with new, more fire safe expulsion fuses that are approved by CAL FIRE. These new expulsion fuses reduce the discharge expelled into the atmosphere, reducing the chance of a fuse operation leading to an ignition.

Targets for 2023 and performance metrics for 2022 are provided in Section 8.1.1.2 Targets and Section 8.1.1.3 Performance Metrics respectively.

8.1.4.4.3 Impact of the Activity on Wildfire Risk

Over the 2023 to 2025 WMP cycle, mitigation done by the Expulsion Fuse Replacement Program (WMP.459) is expected to reduce ignitions by 0.6735 annually. Based on preliminary study results, work done by the program to install CAL FIRE-approved fuses is 100 percent effective at reducing ignition risk. Because SDG&E plans to complete this mitigation, replacing all expulsion fuses within the HFTD by 2025, it is estimated that the risk of ignitions from this cause will be mitigated. Calculations are shown in SDG&E Table 8-24.

SDG&E Table 8-24: Risk Reduction Estimation for the Expulsion Fuse Replacement Program

Calculation Component	Component Value
Expulsion Fuse Operation Tier 3 (5-year average)	83.6
Expulsion Fuse Operation Tier 2 (5-year average)	85.8
Average ignition rate Tier 3	2.91%
Average ignition rate Tier 2	2.56%
Pre mitigation ignitions Tier 3	$83.6 \times 2.91\% = 2.433$
Pre mitigation ignitions Tier 2	$85.8 \times 2.56\% = 2.1965$
Number of fuses installed Tier 3 (2023-2025)	1,573
Number of fuses installed Tier 2 (2023-2025)	6,483
Fuses to be replaced Tier 3	350
Fuses to be replaced Tier 2	390
Ignition Reduced Tier 3	$(350 \div 1,573) \times 2.433 = 0.5414$
Ignition Reduced Tier 2	$(390 \div 6,483) \times 2.1965 = 0.1321$
Ignition Reduction HFTD	$0.5415 + 0.1321 = 0.6735$

8.1.4.4.4 Impact of the Activity on PSPS Risk

The purpose of the Expulsion Fuse Replacement Program (WMP.459) is to reduce the risk of wildfire. This program does not affect the PSPS risk.

8.1.4.4.5 Updates to the Activity

The Expulsion Fuse Replacement Program (WMP.459) is expected to be completed in December of 2025.

An efficacy study was done to test the ignition rate of new CAL FIRE-approved fuses with traditional expulsion fuses: CAL FIRE-Approved Expulsion Fuses vs Other Expulsion Fuses.

The following methodology was followed:

1. The GIS database was utilized to identify the locations and installation dates of new CAL FIRE-approved fuses.
2. Risk event data from 2015 through 2021 was reviewed to identify all risk events isolated by overhead fuses, including counting separate events when multiple fuses operated (more than single phase) and if, during testing, the fuse operated.

3. The risk event isolating device structure and the risk event date was compared to the GIS database to determine if the risk event was isolated by a non-CAL FIRE-approved expulsion fuse or a CAL FIRE-approved expulsion fuse.
4. Fuse operation data was compared to the ignition database data to determine which fuse operations had led to an ignition.

When CAL FIRE-approved fuses were used, there was a reduction in ignition rate percentage from 0.12 percent to 0 percent (see SDG&E Table 8-25). SDG&E Table 8-26 shows fuse operation and ignition rate reduction by HFTD Tier. Currently, there are not enough samples for the data to show a statistically significant reduction, however, the early results are promising.

SDG&E Table 8-25: CAL FIRE and Expulsion Fuse Operation 2015-2021

Fuse Type	Fuse Operation	Number of Ignitions	Ignition Rate
CAL FIRE-Approved Fuse	760	0	0%
Expulsion Fuse	2,477	3	0.12%

SDG&E Table 8-26: CAL FIRE and Expulsion Fuse Operation 2015-2021 by HFTD Tier

Fuse Type	Area	Fuse Operation	Number of Ignitions	Ignition Rate
CAL FIRE	Non-HFTD	334	0	0%
CAL FIRE	Tier 2	199	0	0%
CAL FIRE	Tier 3	228	0	0%
Expulsion	Non-HFTD	1,455	2	0.14%
Expulsion	Tier 2	484	0	0%
Expulsion	Tier 3	474	1	0.21%

8.1.4.5 Hotline Clamp Replacement Program (WMP.464)

8.1.4.5.1 Utility Initiative Tracking ID

WMP.464

8.1.4.5.2 Overview of the Activity

Connectors that have been connected directly to overhead primary conductors, known as hotline clamps (HLCs), are associated with creating a weak connection which could result in a wire down event. This in turn could lead to an energized wire either coming into contact with the ground or a foreign object where it could become a source of ignition.

The HLC Replacement Program (WMP.464) replaces HLC connections that are connected directly to overhead primary conductors with compression, wedge, or other approved connections to eliminate the risk of wire-down failure and the associated ignition risk. HLC connections will be installed concurrently with other asset replacement initiatives across the HFTD such as avian protection (WMP.972), fuse replacements, and lightning arrester replacements (WMP.550).

Targets for 2023 and performance metrics for 2022 are provided in Section 8.1.1.2 Targets and Section 8.1.1.3 Performance Metrics respectively.

8.1.4.5.3 Impact of the Activity on Wildfire Risk

The replacement of HLCs reduces the risk of connection failures that could lead to an energized wire-down event. Data was gathered from historical wire downs associated with connection failures, ignition percentages within the HFTD, and the number of replacements expected by the end of 2025. Ignitions are expected to be reduced by 0.0265 ignitions per year over the 2023-2025 WMP cycle. Calculations are shown in SDG&E Table 8-27.

SDG&E Table 8-27: Risk Reduction Estimation for the HLC Program

Calculation Component	Component Value
Tier 2 wire downs (2017-2021 average for connector failures)	3
Tier 3 wire downs (2017-2021 average for connector failures)	2.75
Non HFTD wire downs 2017-2021 average for connector failures)	4
Ignition rate Tier 2 (2017-2021 average)	2.56%
Ignition rate Tier 3 (2017-2021 average)	2.91%
Ignition rate Non HFTD (2017-2021 average)	1.13%
Mitigation Effectiveness	90.00%
Estimated Ignition Reduction Tier 2	$90\% \times 3 \times 2.56\% = 0.06887$
Estimated Ignition Reduction Tier 3	$90\% \times 2.75 \times 2.91\% = 0.07197$
Estimated Ignition Reduction Non HFTD	$90\% \times 4 \times 1.13\% = 0.04083$
Total Hotline Clamps in the network Tier 2	5,426
Total Hotline Clamps in the network Tier 3	3,094
Total Hotline Clamps in the network Non HFTD	7,264
Hotline clamps replaced (2023-2025) Tier 2	553
Hotline clamps replaced (2023-2025) Tier 3	672
Hotline clamps replaced (2023-2025) Non HFTD	225
Ignition Reduced Tier 2	$(553 \div 5,426) \times 0.06887 = 0.0078$
Ignition Reduced Tier 3	$(672 \div 3,094) \times 0.07197 = 0.0174$
Ignition Reduced Non HFTD	$(225 \div 7,264) \times 0.04083 = 0.0013$
Total Ignition Reduced	$0.0078 + 0.0174 + 0.0013 = 0.0265$

8.1.4.5.4 Impact of the Activity on PSPS Risk

The purpose of the HLC Replacement Program (WMP.464) is to reduce the risk of wildfire. This program does not affect the PSPS risk.

8.1.4.5.5 Updates to the Activity

The HLC Replacement Program (WMP.464) is expected to continue in 2025.

Changes in the 2025 HLC replacement target resulted from fielding assessments performed in tandem with Lightning Arrestor Removal and Replacement (WMP.550), Avian Protection (WMP.972), and Expulsion Fuse Replacement (WMP.459) fielding. Fielding assessments performed in 2023 resulted in a significant number of structures in the HFTD and WUI that require HLC replacement.

8.1.4.6 Lightning Arrestor Removal and Replacement (WMP.550)

8.1.4.6.1 Utility Initiative Tracking ID

WMP.550

8.1.4.6.2 Overview of the Activity

Lightning arresters are pieces of electrical equipment designed to mitigate the impact of transient overvoltage on the electric system. If the overvoltage duration is too long or too high, the arrester can become thermally overloaded, causing these units to fail in a way where they can become an ignition source.

The Lightning Arresters Replacement Program (WMP.550) installs CAL FIRE-approved lightning arresters to mitigate the impact of transient overvoltage on the electric system. CAL FIRE-approved lightning arresters are equipped with an external device that operates prior to the arrester overloading, dramatically reducing the potential of becoming an ignition source.

Targets for 2023 and performance metrics for 2022 are provided in Section 8.1.1.2 Targets and Section 8.1.1.3 Performance Metrics respectively.

8.1.4.6.3 Impact of the Activity on Wildfire Risk

The ignitions reduced by 2025 was calculated using the 5-year average risk events caused by lightning arresters, the 5-year average ignitions caused by lightning arresters, the assumed effectiveness of 80 percent, and the number of planned lightning arrester installations for the 3-year WMP cycle. The mitigation will have an estimated 80 percent reduction in ignitions based on the technology and what the product is designed to accomplish. Based on this data, an ignition reduction of 0.134 and 0.029 in Tier 3 and Tier 2, respectively, are expected between 2023 and 2025. Calculations are shown in SDG&E Table 8-28.

SDG&E Table 8-28: Risk Reduction Estimation for Lightning Arrester Program

Calculation Component	Component Value
Pre-mitigation ignitions Tier 3 (5-year average)	0.8
Pre-mitigation ignitions Tier 2 (5-year average)	0.4
Pre-mitigation ignitions Non HFTD (5-year average)	0
Effectiveness	80%
Ignitions reduced Tier 3	$0.8 \times 80\% = 0.640$
Ignitions reduced Tier 2	$0.4 \times 80\% = 0.320$
Ignitions reduced Non HFTD	$0 \times 80\% = 0$
Total Arresters Tier 3	17,766
Total Arresters Tier 2	16,440

Calculation Component	Component Value
Total Arresters Non HFTD	33,237
Arresters Tier 3 (2023-2025)	3,708
Arresters Tier 2 (2023-2025)	1,500
Arresters Non HFTD (2023-2025)	336
Ignitions reduced Tier 3	$0.64 \times (3,708 \div 17,766) = 0.134$
Ignitions reduced Tier 2	$0.32 \times (1,500 \div 16,440) = 0.029$
Ignitions reduced Non HFTD	$0 \times (336 \div 33237) = 0$
Total ignition reduction	$0.134 + 0.029 + 0 = 0.163$

8.1.4.6.4 Impact of the Activity on PSPS Risk

The purpose of the Lightning Arresters Replacement Program (WMP.550) is to reduce the risk of wildfire. This program does not affect the PSPS risk.

8.1.4.6.5 Updates to the Activity

There were no updates to the Lightning Arresters Replacement Program (WMP.550) in 2022.

8.1.5 Asset Management and Inspection Enterprise System(s)

8.1.5.1 Distribution Systems (WMP.1332)

Systems Applications and Processes Plant Maintenance (SAP PM) stores distribution master asset records, including the inspection and maintenance records for the CMP.

SAP PM is a collection of standard and custom tables. Standard SAP tables are documented by the vendor. Custom tables are documented in the technical design documents for a particular project, which includes the data dictionary and taxonomy for the project scope. SAP PM technical documentation is grouped by project and stored on a SharePoint site for each project.

SAP PM data is stored on SDG&E servers on an SAP Hana database. Any attachments to SAP records are stored on SAP content server.

SAP PM is integrated with a GIS mapping system used to capture, edit, analyze, manage, and display spatial or geographic data. The scope of the asset information documented in GIS includes distribution, transmission, substation, telecommunication, and land assets. The system tracks equipment location, unique equipment attributes, and circuit information. Click Mobile on Mobile Data Terminals (MDTs) is used to collect detailed CMP inspection data. Epoch Mobile on MDTs is used to collect inspection data from the Wood Pole Intrusive inspections (WMP.1190 and WMP.483).

SAP PM is also integrated with Asset 360 (WMP.1341). See Section 8.1.5.4.2 for more detailed information.

The distribution inspection data in SAP PM is used to create the audit sample and track results and any related corrective actions. See Section 8.1.6 for more detailed information on the QA/QC program (WMP.491).

SAP PM changes are managed in the Change Request Management (CHARM) system. System updates are moved between environments (from Development to QA to Production). System Investigation Report (SIR) methodology is used to manage the changes.

Drone inspection (WMP.552) notifications/work orders will be captured in SAP PM. The planned completion date for this action is the end of 2023. Drone inspection findings will also be captured in SAP PM with a planned completion date of 2024.

The use of Click Mobile will be transitioning to GeoCall for Field Service Management starting in 2023 with CMP inspections. CMP inspection data will be collected using GeoCall using iOS devices and MDTs.

8.1.5.2 Transmission Systems

Transmission Construction and Maintenance (TCM) Data is used to track inspection findings and record maintenance work completed as a result of inspections.

Integration between TCM Data, PowerWorkz, CityWorks, and Epoch Mobile are documented in high-level data flow diagrams. CityWorks standard tables are documented by the vendor.

TCM Data is stored in a Structured Query Language (SQL) database on SDG&E servers. CityWorks and PowerWorkz are stored in an Oracle database on an SDG&E server.

TCM is updated with GIS mapping system information which is used to capture, edit, analyze, manage, and display spatial or geographic data. The scope of the asset information documented in GIS includes distribution, transmission, substation, telecommunication, and land assets. The system tracks equipment location, unique equipment attributes, and circuit information.

CityWorks is an application used to schedule work orders for transmission asset inspections. Epoch Mobile application on MDTs is used to collect field inspection data. PowerWorkz is the mobile synchronization database used to make data updates between Epoch Mobile and CityWorks. Extracts from PowerWorkz are manually imported into TCM Data to update new conditions from inspections completed.

TCM Data is integrated also with Asset 360 (WMP.1341). See Section 8.1.5.4.2 for more detailed information.

TCM Data is used to track inspection findings and record maintenance work completed as a result of inspections. A secondary assessment, or internal audit, is performed on 100 percent of findings identified and results are captured in TCM Data. See Section 8.1.6 for more detailed information on QA/QC (WMP.1191).

If TCM database format changes are made, the TCM data analysts are updated via direct email communication or meetings.

For CityWorks and PowerWorkz changes, change requests are managed through the standard IT Change management methodology using an SIR. Issues are managed through a ServiceNow ticketing system. A Change Advisory Board (CAB) reviews proposed changes each week.

There are plans to replace the legacy TCM Data system with an enterprise asset management system. Implementation for this project is yet to be determined, however it is included in the 10-year objectives for asset inspections (see Section 8.1.3.2 Transmission Overhead Detailed Inspections (WMP.479)).

There were no significant changes to TCM Data policies, processes, or controls since the last WMP submission.

8.1.5.3 Substation Systems

The Substation Maintenance Management System, known as Cascade, is the system of record for substation asset master records and is used for work management of assets inside the substation including asset attributes, maintenance triggers, history of maintenance completed, and equipment failures. Cascade is an off-the-shelf system supported by a vendor, DNV.

Documentation of the Cascade system includes system architecture diagrams, database diagrams, and a user guide.

Cascade is a SQL database stored on SDG&E servers. Data collection field units run on a SYBASE database.

SORT is used to dispatch substation alarm investigations and various types of substation inspections. SORT dispatches are reported in Cascade as a work order. Substation Condition Based Maintenance (CBM) is used for real-time monitoring of equipment (such as infrared inspections), management of notifications, and damage risk assessments. See Section 8.1.4 Equipment Maintenance and Repair for more information on CBM.

The substation inspection data in Cascade is used to create the audit sample and track results and any related corrective actions. See Section 8.1.6 for more detailed information on the QA/QC program (WMP.1194).

Changes made to the Cascade system follow the IT project lifecycle methodology. Minor changes (e.g., new fields, workflow, configurations) are made by Business Analysts. Major changes are made by DNV. Change (enhancement) requests, including functional requirements and project signoffs, are stored on a SharePoint site. Business users are responsible for updating Standard Operating Procedures (SOPs) and related training.

In the next year, there are no planned changes to policies, processes, or controls.

In 2022, Cascade was upgraded from version 3.5 to version 3.8. This upgrade allowed for performance improvements, higher security, and enhanced usability. This upgrade also included a database migration from Sybase to a SeQuel database.

8.1.5.4 Integrated Asset Management Systems (WMP.1332)

8.1.5.4.1 WMP Data Platform (WMP.519)

The WMP data platform provides a centralized data lake that enables consistent, reliable and automated reporting of the spatial and non-spatial Quarterly Data Report (QDR) mandated by the OEIS.

Data is ingested into the data foundation from multiple data sources including asset systems, asset inspection systems, outage systems, vegetation management systems, and other internal and external

systems enabling one source of truth for data consumption. Data consumption includes regulatory reporting, internal reporting, efficacy studies, and advanced analytics. The data platform is governed by management oversight, policies and procedures, education, and tool standards. An overview of the WMP Data Platform is in Figure 8-20.

Figure 8-20: WMP Data Platform

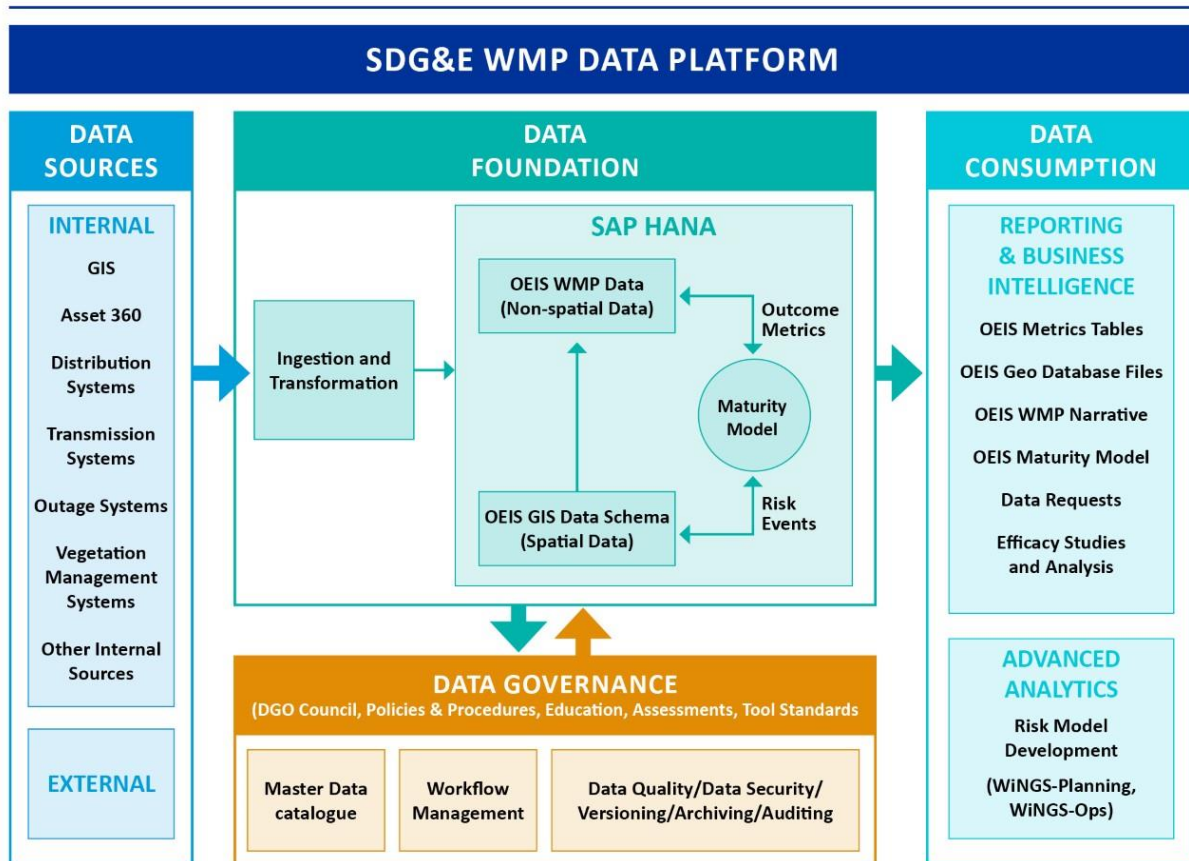

8.1.5.4.2 Asset 360 (WMP.1341)

Asset Management utilizes data as the fulcrum to enable improved risk-informed decision making. It is critical to unify disparate data from across the enterprise into a consumable and curated fashion. Curated asset data is now embedded into risk models and business processes throughout the Company to improve decision making. For example, in the past, age was typically used as a proxy for asset health. Although age plays a factor in asset health, a risk-based approach that considers robust asset data from inspections, failures, outages, and the surrounding environment needs to be considered. Through the Asset 360 program, a per-asset health score is created for critical assets to better assess an asset’s performance, health, and the impact when assets fail.

The Asset 360 program ingests data from imagery, other risk models, and external data sources to improve model accuracy and performance. Integrating results of image-based analytics including IIP (WMP.1342) will help improve asset predictive models in the future. Data quality has begun to be

measured and improvement efforts to remediate data in the source systems has also begun. Partnerships have been established between Asset Management, Enterprise Risk Management, Wildfire Mitigation Program, and the source system teams to continuously improve data quality. Starting this year, tools to further automate the data quality issue identification and remediation process will be evaluated and eventually adopted. The integration of asset data and the development of asset health predictive models will formulate an assessment of asset risk, which can be utilized by operating and engineering teams to develop and analyze their projects, programs, and/or initiatives, improving risk-based decision making.

To date, Asset 360 has created asset conditions for the following:

- Distribution Primary overhead Conductor
- Distribution Wood Poles
- Distribution overhead Switches (Hook Stick, Gang Operated, Reclosers)
- Distribution underground Switches (Oil-filled switches, fault interrupters)
- Distribution underground Tees
- Distribution underground Cable
- Distribution overhead capacitors

Asset 360 has also created risk indices for the following assets:

- Distribution Primary overhead Conductor
- Distribution Wood Poles
- Distribution overhead Switches (Oil-filled switches, fault interrupters)
- Distribution underground Tees
- Distribution underground Cable

In 2023, Asset 360 will continue to improve existing models for asset condition and risk as well as incorporate new assets into the platform including potheads, secondary, and transformers.

Asset 360 data is automatically integrated with distribution and transmission source systems. See Figure 8-21 for a roadmap of planned changes and improvements to Asset 360.

Figure 8-21: Asset 360 3-Year Roadmap

PRODUCT TRACKS	2023	2024	2025
DATA FOUNDATION & AUGMENTATION	Cloud Migration		
	Automate & Implement Data Quality Rules	Incorporate Fuses & Regulators	
	Incorporate Drone Image Metadata	Enable Geospatial Analysis & Network Topology	
	Implement Optical Character Recognition (OCR)		
EQUIPMENT HEALTH PREDICTIONS & OPTIMIZATION MODELS	Switches	Transformers	Overhead Structure and Conductors
		Fuses	
	DIAR Prioritization		Regulating Devices
CAPABILITIES	Project Scoping: Equipment List for a Structure		
	Augment HFTD data for As-Builts and Pole Loading		
	Enable Risk Informed Investment & Maintenance Decision Application		

8.1.5.4.3 Intelligent Image Processing (WMP.1342)

IIP (WMP.1342) is an image capture, enterprise image repository, and Artificial Intelligence (AI) and ML processing engine. In 2021, IIP harnessed digital capabilities to accelerate AI and ML, cutting-edge data acquisition technologies, and human/machine workflows to support wildfire mitigation and compliance activities. IIP collects, retains, and analyzes images from various acquisitions to enable damage detection and risk analysis for distribution. Acquisitions include, but are not limited to, drone, mobile, LiDAR, and Fleet captures in the HFTD and WUI areas. In 2022, IIP operationalized these digital capabilities utilizing the 4 million images in image repository and AI and ML to:

- To date analyzed over 850,000 images (39,000 poles) in HFTD for fire risks utilizing AI damage detection models in support of the DIAR Program (WMP.552)
- Analyzed over 2 million images (75,000 poles) in HFTD for fire risks utilizing AI asset detection models in support of WMP asset replacement programs

- Analyzed over 2 million images in HFTD for Communication Infrastructure Provider (CIP) presence, third party Attacher, utilizing AI third-party Attacher equipment detection models in support of Pole Attachment Compliance program
- Ingested and stored in enterprise image repository LiDAR files and data for 205 circuits utilized as part of the 2022 HFTD LiDAR data capture.

Over this WMP cycle, IIP technology will continue to improve the quality of inspections through enhancement to its damage detection models and expanded utilization within drone inspection efforts (see Section 8.1.3.7 Drone Assessments (WMP.552)). There are no plans to change the frequency of this program. However, beginning in 2025, inspections performed in the WUI will be incorporated into the WMP reporting. As discussed in Section 8.1.5.4.2, IIP will continue enhancement of asset identification models to support improvements to the Asset inventory that helps improved risk-informed decision making. LiDAR imagery ingested and stored in IIP will be used to inventory overhead secondary wire and services in the HFTD Tier 3 region. IIP data is automatically integrated with overhead distribution and transmission source systems. See Figure 8-22 for a roadmap of planned changes and improvements to IIP.

Figure 8-22: IIP 3-Year Roadmap

PRODUCT TRACKS	2023	2024	2025
DRONE BASED IMAGERY	Run Drone Inspection <i>Human Led + AI (Machine) QA</i>	Operationalize Drone Inspection <i>Human Led + AI (Machine) QA</i>	
	Test Supplemental Drone Inspection <i>AI (Machine) QA</i>	Run Supplemental Drone Inspection <i>AI (Machine) QA</i>	Operationalize Supplemental Drone Inspection <i>AI (Machine) QA</i>
FLEET BASED IMAGERY		Run Fleet Asset Detection <i>AI (Machine) QA</i>	Operationalize Fleet Asset Detection <i>AI (Machine) QA</i>
		Test Supplemental Fleet Inspection <i>AI (Machine) QA</i>	Run Supplemental Fleet Inspection <i>AI (Machine) QA</i>

8.1.6 Quality Assurance and Quality Control

OEIS Table 8-7: Grid Design and Maintenance QA/QC Program

Inspection Program being audited	Audit Program Name	Procedure/ Program Documenting QA/QC Activities	Auditor Qualifications**	Sample Size	Type of Audit	2022 Audit Results	Yearly Target Pass Rate (2023-2025)
All Transmission Inspection Programs	QA/QC of Transmission Inspections (WMP.1191)	Internal Transmission Line Maintenance Practice*	Construction Supervisor	100% of conditions identified during inspection	Field and Desktop	n/a	See 10-year Objectives

Inspection Program being audited	Audit Program Name	Procedure/ Program Documenting QA/QC Activities	Auditor Qualifications**	Sample Size	Type of Audit	2022 Audit Results	Yearly Target Pass Rate (2023-2025)
Distribution Overhead Detailed Inspections (WMP.478)	QA/QC of Distribution Detailed Inspections (WMP.491)	ESP 612	Construction Supervisor	50% of conditions identified during inspection	Field	100%	100%
Distribution Drone Assessments (WMP.552)	QA/QC of Distribution Drone Assessments (WMP.1192)	DIAR SOP, Data Capture and Assessment Manual	Construction Supervisor	100%	Desktop	100%	100%
Distribution & Transmission Wood Pole Intrusive Inspections (WMP.483 and WMP.1190)	QA/QC of Wood Pole Intrusive Inspections (WMP.1193)	Wood Pole Inspection Audit Procedures	Third party contractor - auditor	10%	Field	88%	88%
Substation Patrol Inspections (WMP.492)	QA/QC of Substation Inspections (WMP.1194)	SOP 510.040	Construction Supervisor	~18 annually	Field	100%	90%

*Contains confidential and sensitive information

**Personnel qualified to conduct audits in these program areas have the title listed in the table. Additional information on the qualifications for each title can be found in Section 8.1.9.

8.1.6.1 QA/QC of Transmission Inspections (WMP.1191)

QA/QC of transmission inspections is also referred to as secondary assessments for conditions identified during inspection. The process for these secondary assessments is outlined in SDG&E’s internal transmission line maintenance practices for the purpose validating inspection results. A construction supervisor performs a field assessment for 100 percent of conditions identified during an inspection. Secondary assessments are prioritized based on severity level of the condition and on HFTD region. The construction supervisor will validate whether the condition identified during inspection is valid or if no further maintenance is required. See Section 8.1.3 Asset Inspections for detailed processes for transmission secondary assessments and Section 8.1.9 Workforce Planning for qualifications of the construction supervisor.

Discrepancies and lessons learned as a result of secondary assessments are addressed and resolved in real time during staff meetings.

There are no plans to change the scope or frequency of this program.

8.1.6.2 QA/QC of Distribution Detailed Inspections (WMP.491)

QA/QC of distribution detailed inspections (WMP.478) is managed by Operations and Engineering managers. Beginning in 2025, the program will be enhanced by having supervisors assess 50% of findings identified during inspection within 1 month of the inspection and documenting the results of those assessments. In addition, 5% of inspections will be audited by quality control personnel via field visits and desktop review of images collected within 1 month of the completed inspection. These enhancements will track pass/fail audit results, which will be communicated back to inspectors. Trends will be monitored and appropriate training will be delivered either individually or through annual refresher trainings administered to all qualified inspectors.

8.1.6.3 QA/QC of Distribution Drone Assessments (WMP.1192)

QA/QC of distribution drone assessments (WMP.552) is performed by Construction Supervisors reviewing 100 percent of assessments and images processed through the machine learning models in production. If any discrepancies are identified, the Construction Supervisor will provide feedback to the Inspector during regular team meetings and the inspection findings will be updated prior to finalization. Similarly, if there are any variations between the results of the machine learning model findings and the Inspector's findings, that information will be reviewed and validated by the Construction Supervisor. Information will be sent back to the Construction Supervisor and the missed issues will be included in the inspection findings prior to finalization. Lessons learned, as well as updates to inspection requirements are also incorporated into initial and refresher training materials. There have been no changes to the QA/QC process since the last WMP submission. See Section 8.1.9 Workforce Planning for qualifications of workers.

8.1.6.4 QA/QC of Transmission & Distribution Wood Pole Intrusive Inspections (WMP.1193)

The audit program for wood pole intrusive inspections (WMP.483 and WMP.1190) is outlined in an internal wood pole inspection audit procedure. This program targets 10 percent of completed inspections to audit monthly and utilizes a randomizer to select the structures. This sample size is determined based on feasibility of performing the audits on a monthly basis. A third party is contracted to perform a field audit of the 10 percent of completed inspections for both distribution and transmission structures. Third party auditors are required to successfully pass two weeks of auditor training that is conducted by the third party. The audit field verifies the initial inspection results monthly. Audit findings are recorded in the wood pole inspection management system and shared with program administrators. Results are reviewed and shared at routine monthly meetings with the intrusive inspectors and their leadership. Work is reissued to intrusive inspectors when discrepancies are identified, and corrections are performed within 2 weeks of the finding. Trending discrepancies are identified and addressed with root cause and field visits.

In 2022, enhancements were developed to move from a manual process of selecting the audit sample population to a more efficient, automated randomizer selection tool within the wood pole inspection management system.

8.1.6.5 QA/QC of Substation Inspections (WMP.1194)

QA/QC of substation inspections (WMP.492) is performed as outlined in SDG&E's *510.040 Substation Inspector Maintenance Order Reporting and Tracking*. Completed substation patrol inspections are

periodically reviewed by a Construction Supervisor for quality control of regulatory requirements, relevancy, and internal considerations. The sample size for periodic review is determined by the number of substation inspectors performing patrol inspections. Per 510.040, the periodic review consists of 10 inspections, at different substations, for each inspector per 6-month period. Currently, three inspectors are utilized to perform substation patrol inspections, which results in 60 reviews annually (approximately 5 percent of completed patrol inspections), of which approximately 30 percent are performed in the HFTD. The Construction Supervisor documents the completion of the review and any noted deficiencies in a maintenance order for the relevant substation. The documentation includes the route, date, substation name, inspector name, and a checklist of items reviewed. The deficiencies are noted on a form that resides in the maintenance order. Should any discrepancies be found, the Construction Supervisor will conduct a near real-time training with all inspectors including an example of the deficiency followed by a display of the correct course of action. See Section 8.1.9 Workforce Planning for qualifications of the substation construction supervisor.

This periodic review is a new program implemented in 2022. Enhancements to the system of record for substation patrol inspections have been implemented to support this program. A yearly target pass rate of 90 percent has been established; however, results of the periodic review has yet to inform any changes or enhancements to the inspection program or training procedures.

8.1.7 Open Work Orders (WMP.1065)

8.1.7.1 Procedures/Programs Documenting the Work Order Process

The CMP programs for transmission and distribution assets define the requirements for corrective maintenance. Corrective maintenance is managed through initiation, prioritization, and completion of corrective work orders. SDG&E adheres to all GO regulations for addressing corrective maintenance within required timeframes and, when applicable, will exceed requirements based on severity level and region prioritization. See Section 8.1.3 Asset Inspections for more details on asset inspection programs and procedures describing corrective work order processes associated with each inspection program.

Figure 8-23 outlines the process for addressing corrective work orders resulting from inspections.

Figure 8-23: Open Work Orders: Corrective Maintenance

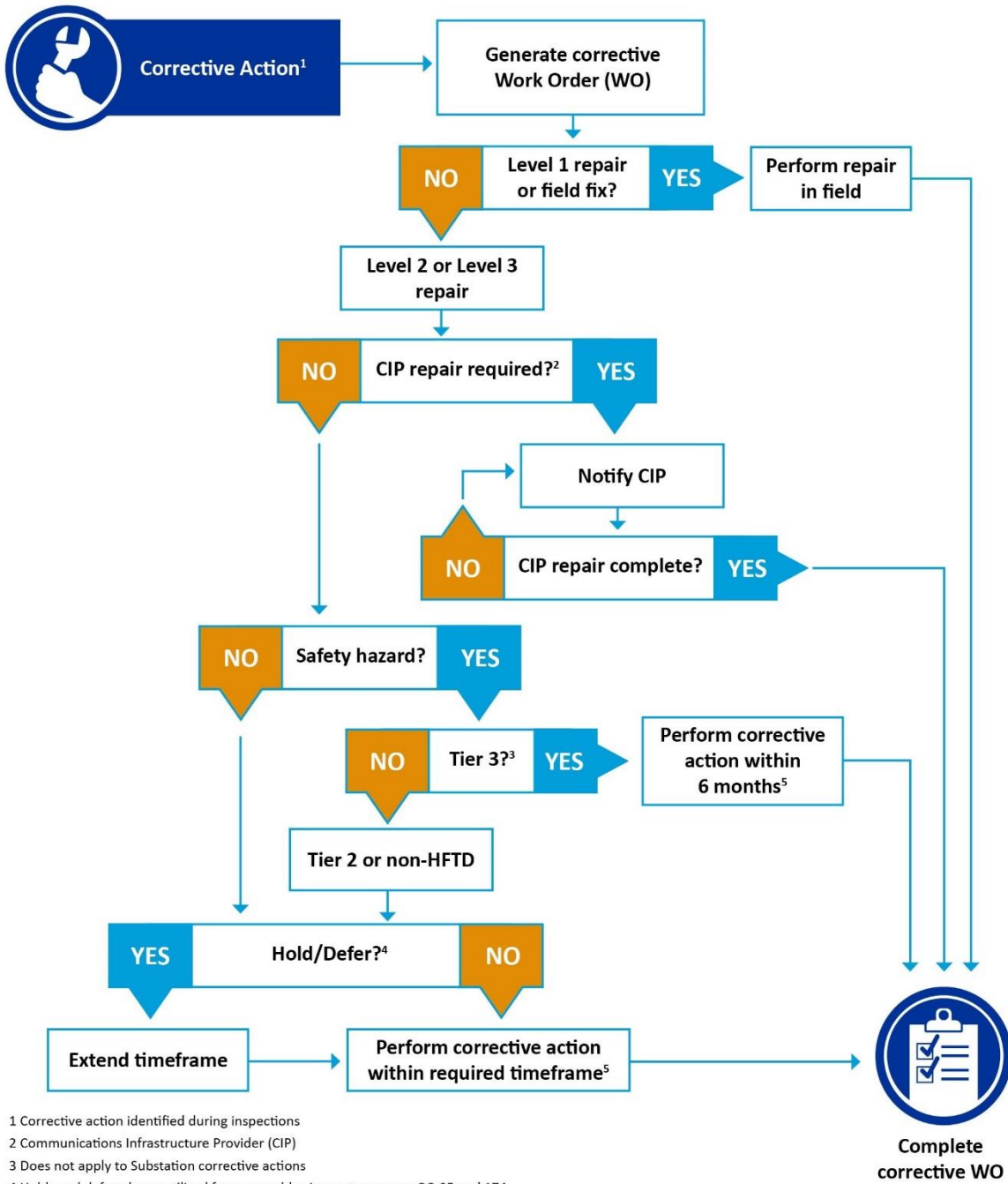

1 Corrective action identified during inspections
 2 Communications Infrastructure Provider (CIP)
 3 Does not apply to Substation corrective actions
 4 Holds and deferrals are utilized for reasonable circumstances per GO 95 and 174
 5. See Table below

GO 95 Rule 18 Corrective Action Timeframe			
	Level 1	Level 2	Level 3
Non-HFTD	≤ 30 days	12 months	12 months
Tier 2	≤ 30 days	12 months	12 months
Tier 3	≤ 30 days	6 months	12 months

8.1.7.2 Prioritization of Work Orders

Corrective work orders are assigned a severity level, which determines the timeframe for making the repair or replacing the asset per GO 95. Region prioritization such as HFTD is also a factor in determining timeframe for work order completion. Level 1 findings are addressed immediately in the field when the situation is made safe to do so. Minor repairs that do not require engineering design, a crew, an outage, or additional materials can also be addressed on site immediately. Level 2 and 3 repairs are evaluated based on safety and addressed accordingly. See Figure 8-23 for specific severity levels and timeframes for repair.

8.1.7.3 Plan for Eliminating a Backlog of Work Orders, if Applicable

Deferred work in the HFTD is primarily related to permitting delays and access issues. SDG&E has been working internally and externally to prioritize corrective work in the HFTD to minimize deferrals. For example, SDG&E has been working cooperatively with the Caltrans on a process that would allow SDG&E to complete work prior to going through the permitting process and obtain an “after-the-fact” encroachment permit. This would allow SDG&E to make the facility “safe” quickly and satisfy Caltrans administrative requirements. Unfortunately, customer access issues continue to present challenges in the timely closure of corrective work orders. SDG&E is continuing outreach and education efforts, as well as clarification of land rights, to either avoid or support resolution of access issues.

8.1.7.4 Trends with Respect to Open Work Orders

In general, average timelines to resolve open work orders in the HFTD have been maintained over the past 3 years with an average of 5 months or less in Tier 3, less than 7 months in Tier 2, and less than 45 days for Level 2 severity items across the entire HFTD.

See Section 8.1.1.3 Performance Metrics for grid inspection findings and open work orders.

Further analysis is performed when recurring infractions and conditions are identified through inspections and proactive replacement/repair projects can be initiated. See Section 8.1.4 Equipment Maintenance and Repair for details on proactive maintenance and replacement strategies.

8.1.7.5 Open work orders over time

Figure 8-24 shows the number of open distribution work orders, including past due orders, by year. On average, there are 267 open orders as of year-end, of which approximately 2.5 percent are past due. The number of open orders has trended up since 2019 due to additional drone inspections performed in the HFTD. The DIAR Program (WMP.552) is transitioning its methodology to inspect the top 15 percent HFTD structures by risk each year moving forward, which will level out the number of open work orders moving forward.

Figure 8-24: Distribution Open Work Orders

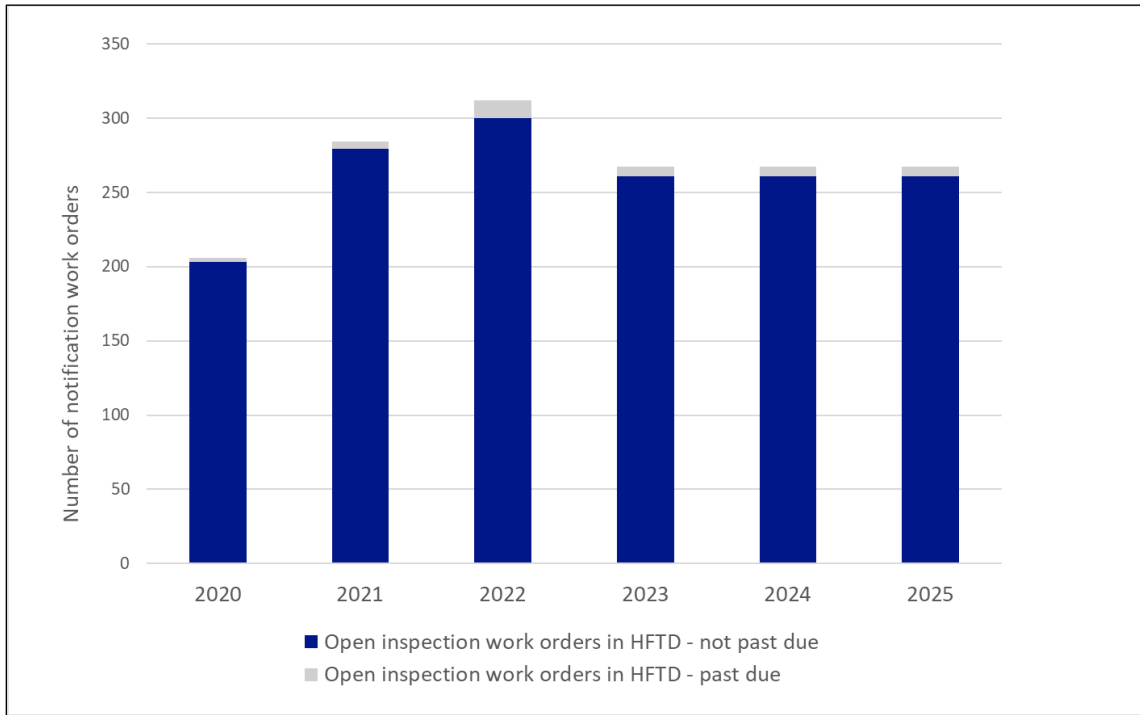
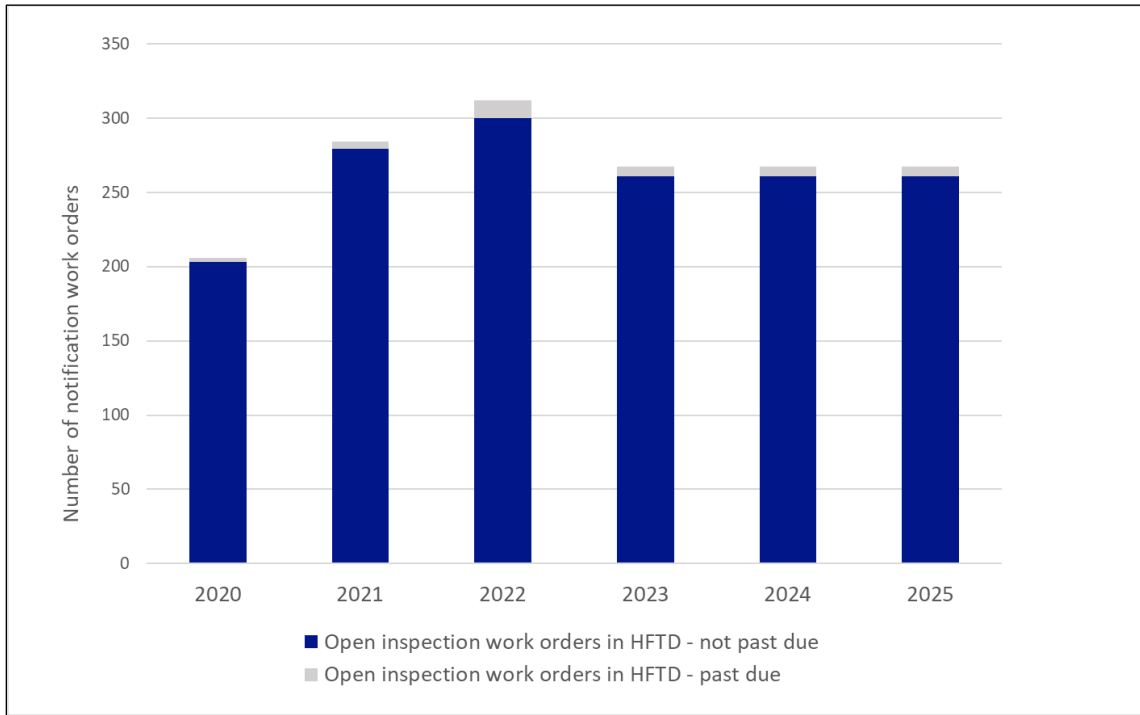

Figure 8-25 shows the number of open transmission work orders by year. On average, there are 206 open work orders as of year-end. A downward trend is observed, and this trend is forecasted to be in line with the average for the last 2 years. Transmission inspection had zero past due open work orders in the last 3 years. This performance is forecasted to continue in the next 3 years.

Figure 8-25: Transmission Open Work Orders – Not Past Due



8.1.7.6 Aging report for work orders past due

All past due work orders are non-emergency or deferred work under reasonable circumstances per GO 95. SDG&E implements processes where deferred work is reviewed, prioritized, and solutions are determined to remediate issues on a monthly basis. SDG&E prioritizes work in Tier 3 of the HFTD, and therefore there are currently no past due work orders within Tier 3. The obstacles and mitigation strategies associated with past due work orders are described in Section 8.1.7.3. OEIS Table 8-8 shows an aging report for current past due work orders.

OEIS Table 8-8: Number of Past Due Work Orders Categorized by Age

HFTD Area	0-30 Days	31-90 Days	91-180 Days	181+ Days
Transmission HFTD Tier 2	0	0	0	0
Transmission HFTD Tier 3	0	0	0	0
Distribution HFTD Tier 2	0	0	0	0
Distribution HFTD Tier 3	0	0	0	0

8.1.8 Grid Operations and Procedures

8.1.8.1 Equipment Settings to Reduce Wildfire Risk

8.1.8.1.1 Protective Equipment and Device Settings (WMP.991)

Advanced SGF relay settings are employed to ensure proper detection of high impedance ground faults on the electric distribution system in order to prevent potential wildfire ignitions. Additionally, during periods of extreme fire potential risk, SRP settings are enabled to limit fault energy should a fault develop on the electric distribution system. SDG&E has operating procedures that dictate the use of SRP settings, recloser settings, and general service restoration requirements in the HFTD depending on wildfire risk levels. SGF settings are employed year-round on the overhead electric distribution system. In addition, SRP settings are enabled either when the FPI (WMP.450) has a rating of Extreme or when general conditions may warrant a PSPS event.

A study was completed to determine the impact of sensitive relay settings at reducing ignitions from risk events. During days with an FPI rating of Extreme or during RFWs (WMP.082), sensitive relay settings are enabled on reclosers within the HFTD and coastal circuits with fire risk. The sensitive relay settings should improve the sensitivity of fault detection, the speed at which faults are cleared, and reduces the energy of the fault as much as possible, which reduces the heat generated by a fault, which should lead to fewer ignitions.

The study demonstrated a reduction in ignition percentage from 3.02 percent to 0 percent (see SDG&E Table 8-29). From 2015 to 2021, there were zero ignitions by primary faults downstream of devices with sensitive relay settings enabled. While there are not enough samples for the data to show a statistically significant reduction, the early results are promising.

SDG&E Table 8-29: Ignition Rate with SRP Enabled

Description	Calculation
Total System Risk Events	3,010
Total System Ignitions	91
Percent System Ignitions	3.02%
Total Risk Events with SRP	90
Tier 2 Events with SRP	49
Tier 3 Events with SRP	41
Total Ignitions with SRP	0
Percent Ignition with SRP	0%
Percent Decrease in Ignition with SRP Enabled	100%

8.1.8.1.2 Automatic recloser settings (WMP.1018)

Reclosing settings have been turned off since 2017 in the HFTD. Manual reclosing is performed without patrol only when the FPI rating is Normal. SDG&E does not enable automatic recloser settings in the HFTD, and 100 percent of overhead lines have reclosing capabilities. Reclosing settings are not changed in response to off-normal events.

A study was conducted to understand the effectiveness of recloser protocols. Prior to 2017, reclosing in the HFTD was disabled on days with an FPI rating of Elevated or Extreme. After 2017, reclosing was disabled in the HFTD all year regardless of the FPI rating to further reduce the risk of ignitions. This study reviewed historical risk events that were isolated by reclosers to measure the effectiveness of disabling reclosing at reducing faults and ignitions over the last 5 years. By measuring faults on the system by HFTD Tier and weather condition, the number of additional faults avoided by turning reclosing off under certain conditions was estimated. The faults avoided were then multiplied by the relevant HFTD ignition rate to estimate the number of ignitions avoided per year.

The results show that disabling reclosing reduces ignitions by an average of 4.2 per year in Tier 2 of the HFTD and 4.7 per year in Tier 3 of the HFTD (see SDG&E Table 8-30).

Figure 8-26: Results of Reclosure Protocols in Fault Avoidance

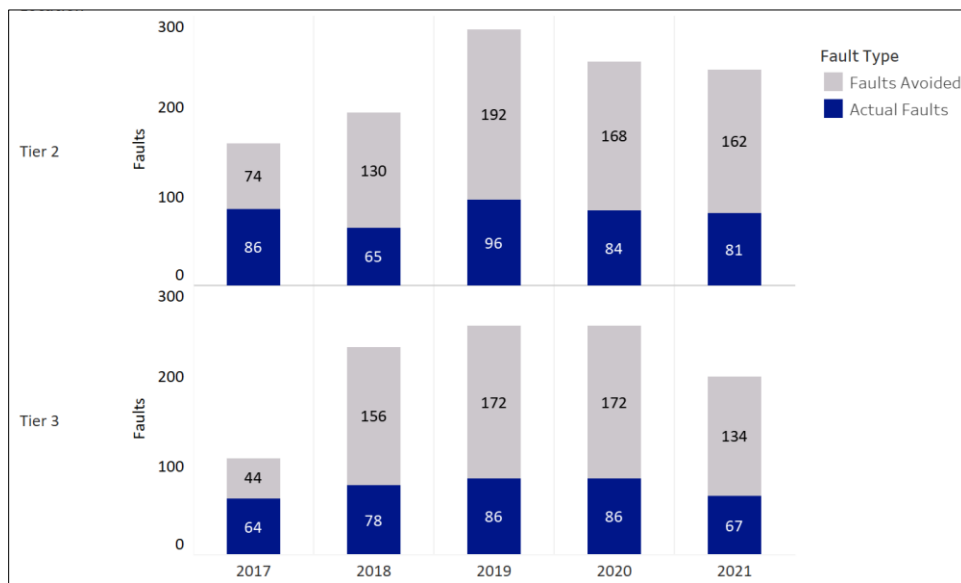

SDG&E Table 8-30: Results of Reclosure Protocols in Ignition Avoidance

Year	Estimated Ignition Avoided: Tier 2	Estimated Ignition Avoided: Tier 3	Estimated Ignition Avoided: Total
2017	3.4	2.4	5.8
2018	4.3	5.0	9.3
2019	4.8	5.6	10.4
2020	4.2	6.4	10.7
2021	4.3	3.9	8.3
5 Year Avg.	4.2	4.7	8.9

8.1.8.1.3 Settings of other Emerging Technologies

SDG&E does not employ Rapid Earth Fault Current Limiters.

8.1.8.2 Grid Response Procedures and Notifications

Multiple technologies are deployed to narrow the location of detected issues on the system including the use of SCADA (WMP.453) and Wireless Fault indication (WMP.499). Additionally, predictive fault analytics technology is being developed that can identify potential locations of emerging faults on the system. Lastly, if an issue is intermittent and not found during patrol and subsequent service restoration, an after-event fault analysis is performed to simulate and investigate potential fault locations in order to resolve the issue.

Priorities are based on customer impacts unless a fire ignition or other safety issue is present, in which case those incidents would take priority. If no safety issue is present, critical public infrastructure is given the highest priority, after which resources are deployed to the incidents with the largest customer impacts.

SDG&E has multiple channels for detecting wildfire ignitions. Fire Coordination notifies all personnel of any fire ignitions in close proximity to SDG&E infrastructure, and Electric Troubleshooters are dispatched to any outage on the system detected through customer calls or advanced metering alarms.

During PSPS events and high-fire risk weather events, any new outages on the electric system are closely monitored and fire alert cameras (WMP.1343) are rotated to the de-energized area to look for potential ignitions. If an ignition is detected, Fire Coordination will immediately notify the proper fire authority to initiate fire suppression. Similarly, at the conclusion of a PSPS event, CFR are staged in close proximity to each area being restored in an effort to prevent ignitions and mitigate any ignition that occurs. All fire activities are coordinated with first responders and training is performed throughout the year to ensure efficient coordination during real world incidents.

SDG&E expands resources to minimize response times based on wildfire risk levels. During days with an FPI rating of Extreme or conditions that generally warrant a PSPS, staffing of emergency responders is increased around the clock and staff is placed in the areas of highest risk in order to minimize response times.

8.1.8.3 Personnel Work Procedures and Training in Conditions of Elevated Fire Risk (WMP.515)

Work activities and associated fire mitigations throughout the service territory are designated for specific Operating Conditions (e.g., Normal condition, Elevated condition, Extreme or RFW) as outlined in the Electric Standard Practice (ESP) document: *SDG&E Operations and Maintenance Wildland Fire Prevention Plan* (ESP 113.1). As the fire potential increases in severity, activities that present an increased risk of ignition have additional mitigation requirements. Where risk cannot be mitigated, work activity might cease. All field personnel are required to be trained on SDG&E's fire prevention procedures annually. Fire prevention and safety is also discussed at pre-job briefings, commonly referred to as tailgates/tailboards, and built into standard work practice. These standard practices are not exclusive to the HFTD and are implemented in all areas of the service territory where at-risk activities are performed adjacent to wildland fuels.

8.1.8.3.1 Procedures for Determining Operating Conditions

Procedures and routine practices for working in wildland areas of the service territory are detailed in (ESP 113.1). Risk levels are determined by the FPI rating for that zone of the service territory.

The following summarizes the work activity guidelines for each Operating Condition:

- Normal Condition: Normal operating procedures are followed with baseline tools present at work sites, appropriate buffers between heat sources and flammable fuels, and equipment meeting appropriate standards.
- Elevated Condition: Certain at-risk work activities may require additional mitigation measures in order to proceed with work. Additional mitigations may include but are not limited to a Dedicated Fire Patrol, additional water on site, and/or barriers between work and vegetation.
- Extreme or RFW Condition: Most overhead work activities will cease except where not performing the work would create a greater risk than doing so. In those cases where at-risk work needs to be performed, a Fire Coordinator is consulted and additional mitigation steps are implemented. Status of work, ceased or continued, is documented.

All field personnel are trained annually in ESP 113.1, the document that governs work practices during different wildfire risk levels. Field personnel and operating teams receive emails when operating conditions change or daily, whichever is more frequent. Additionally, the current FPI is made available via a weather application and website.

A study was performed to determine the effectiveness of special work procedures that cancel all work in the HFTD Tier 3 and Tier 2 on days with an FPI rating of Extreme. Based on historical crew-caused risk events, special work procedures mitigate 0.0317 ignitions annually in Tier 2 and 0.0361 ignitions annually in Tier 3 of the HFTD (see SDG&E Table 8-31).

SDG&E Table 8-31: Effect of Special Work Procedures on Ignitions

Description	Tier 2	Tier 3
Risk Events	0.2	0.3
Ignition Rate	12.90%	10.53%
Ignition Avoided	0.0317	0.0361

8.1.8.3.2 Crew Accompanying Ignition Prevention and Suppression Resources and Services (WMP.514)

SDG&E worksites are required to have increasing levels of wildfire prevention mitigation based on the activity being performed and the FPI rating as stated in ESP 113.1. This could be as simple as carrying wildfire suppression tools to having a dedicated Fire Resource observing work.

When work activities reach a level of fire risk where a dedicated resource is required, SDG&E and contract personnel utilize a qualified fire resource with specific training and experience (listed in ESP 113.1). While these resources can be ordered throughout the year to meet California’s year-round fire season, SDG&E takes the proactive step of supplying field crews with 12 to 17 daily resources once the fire environment and FPI begin to indicate elevated risk. This daily staffing changes from year to year but typically runs from roughly June[†] through the end of November. SDG&E also works to align with the staffing of the seasonal resources of the local, state, and federal agencies in the service territory.

These qualified resources, referred to as CFRs, are staffed by two personnel that have the appropriate amount of training, water, and tools to meet the needs of the work activity. The use of CFRs is not limited to the HFTD as ESP 113.1 requires a dedicated fire patrol for specific activities when they are performed adjacent to wildland fuels and there is elevated risk. The primary missions of CFRs are fire prevention and compliance. Secondly, because of the required training tools, the resource can take action to mitigate an ignition should it occur and communicate to the fire agencies to ensure transparent reporting. At-risk activities for which a dedicated fire patrol is utilized include but are not limited to hot work, vegetation clearing, and energized switching.

During periods of Extreme Fire Potential, SDG&E cancels regular work with at risk activities. CFRs are deployed with SDG&E personnel for emergency work and play an important role in fire prevention during the PSPS de-energization and restoration process.

A study was performed to determine the effectiveness of special work procedures that require CFRs on days that with an FPI rating of Elevated or higher.

CFRs perform preconstruction mitigation measures such as watering down the work area. Should a risk event occur that leads to an ignition, the teams work to suppress the ignition before it can grow in an attempt to limit the impacts. This research concluded that the use of CFRs mitigates 0.0785 ignitions in Tier 2 per year and 0.1896 ignitions in Tier 3 annually.

SDG&E Table 8-32: Effect of CFRs on Ignitions

Description	Tier 2	Tier 3
Risk Events	2.2	3.8
Ignition Rate	3.57%	4.99%
Ignition Avoided	0.0785	0.1896

8.1.8.3.3 Aviation Firefighting Program (WMP.557)

The Aviation Firefighting Program (WMP.557) focuses on reducing the consequences of wildfires through suppression of fire spread. These resources are available not only for fires associated with SDG&E equipment but to the entire community regardless of the cause of ignition. Under certain conditions, a wildfire that is not suppressed may grow rapidly and uncontrollably and endanger public safety. Fire agencies could divert local aerial resources to fight wildfires outside of the service territory, leaving the service territory with limited or no aerial firefighting resources. To mitigate this risk, the aviation firefighting program serves as a wildfire suppression resource, ensuring aerial firefighting resources remain available in the region.

Two firefighting helicopters, an Erickson S-64 helitanker and a Sikorsky UH-60 Blackhawk helitanker are available. Both firefighting assets are Type 1 firefighting helicopters, defined as carrying over 700 gallons of water to fight fires. The Air Crane has the capability of dropping up to 2,650 gallons of water and the Blackhawk has the capability of dropping up to 850 gallons of water. Additionally, the Blackhawk hardware is configured for night vision device flight and is capable of night firefighting with the appropriate crew, training, and CAL FIRE support. The decision for these two resources was based on their exceptional fire suppression capability and ability to perform as a construction tool in areas with

access issues. In 2022 a Sikorsky S-70M was purchased which is being outfitted for firefighting with a 1,000-gallon tank. Due to certification requirements of the Federal Aviation Administration (FAA), it is estimated that this helicopter will not be in service until the end of 2024 or early 2025.

SDG&E has agreements with the County of San Diego, CAL FIRE, and the Orange County Fire Authority for aerial firefighting within the service territory. Dispatch of aviation firefighting assets is performed through CAL FIRE and these assets support the initial attack strategy to contain wildfires to less than 10 acres. SDG&E employs flight operations staff to assist in dispatching aerial assets 365 days per year, throughout the service territory. This allows the assets to be launched rapidly once dispatched by CAL FIRE.

Generally, helicopters that drop water need to be relatively close to their target, and the stronger the wind the more dangerous it becomes to fly close to the ground. In addition, strong winds can help dissipate the water from the aircraft and lead to ineffective water drops.

SDG&E will continue to analyze the most effective way to run its Aviation Firefighting Program, and to determine the effectiveness of that program using internal and external data to assist in the analysis.

The effectiveness of the Aviation Firefighting Program will continue to be analyzed using internal and external data. The current subject matter expert consensus is that the program reduces overall wildfire consequence, and therefore wildfire risk, by approximately 4 percent; based solely on the knowledge of the equipment and operations, coupled with anecdotal evidence of recent history. Importantly, this 4 percent is only the measure of utility associated wildfires, and the overall benefit of the program is much larger than what that 4 percent represents.

8.1.9 Workforce Planning

OEIS Table 8-9: Workforce Planning, Asset Inspections

Worker title	Minimum Qualifications for Target Role	Special Certification Requirements	Electrical Corporation % FTE Min Qualls	Electrical Corporation % Special Certifications	Contractor % FTE Min Qualls	Contractor % Special Certifications	Reference to Electrical Corporation Training/Qualification Programs
Distribution							
Line Inspector	<ul style="list-style-type: none"> • Successful completion of 6-month Overhead Detailed Inspection training program • IBEW status in good standing • Valid California driver's license 	Overhead and underground Inspection Training	0%	n/a	0%	n/a	Overhead CMP Detailed Inspection Training (STU EL310)
Distribution Lineman	<ul style="list-style-type: none"> • Journeyman Lineman having completed an accredited apprenticeship program • International Brotherhood of Electrical Workers (IBEW) Journeyman Lineman status in good standing • Class A California Driver's License 	*Qualified electrical worker (QEW), Overhead and/or Underground Inspection Training	54%	100%	0%	n/a	Line Assistant and Apprenticeship Program
Fault Finding Specialist	<ul style="list-style-type: none"> • Journeyman Lineman having completed an accredited apprenticeship program • IBEW Journeyman Lineman status in good standing • 4-week Relief Fault Finder (RFF) class completed and associated written and practical exams passed 	*QEW, Overhead and/or Underground Inspection Training	2%	100%	0%	n/a	Line Assistant and Apprenticeship Program RFF Course

Worker title	Minimum Qualifications for Target Role	Special Certification Requirements	Electrical Corporation % FTE Min Quals	Electrical Corporation % Special Certifications	Contractor % FTE Min Quals	Contractor % Special Certifications	Reference to Electrical Corporation Training/Qualification Programs
Electric Troubleshooter	<ul style="list-style-type: none"> Journeyman Lineman having completed an accredited apprenticeship program IBEW Journeyman Lineman status in good standing Complete 7-week Relief Trouble Shooter (RETS) class and pass written and practical exams 	*QEW, Overhead and/or Underground Inspection Training	14%	100%	0%	n/a	Line Assistant and Apprenticeship Program
Working Foreman	<ul style="list-style-type: none"> Journeyman Lineman having completed an accredited apprenticeship program IBEW Journeyman Lineman status in good standing 6 months' experience in both overhead and underground electric during the past three years Construction Standards and Practices tests passed 	*QEW, Overhead and/or Underground Inspection Training	12%	100%	0%	n/a	Line Assistant and Apprenticeship Program
Distribution Construction Supervisor	<ul style="list-style-type: none"> 6+ years construction and maintenance experience 	*QEW, Overhead and/or Underground Inspection Training	18%	100%	0%	n/a	Line Assistant and Apprenticeship Program Essentials of Supervision
Inspection and Treatment Foreman	<ul style="list-style-type: none"> Pesticide handler training Valid class C driver's license 1st aid/CPR qualified 	n/a	0%	n/a	86%	n/a	n/a
Auditor	<ul style="list-style-type: none"> 2 weeks auditor training 	n/a	0%		14%	n/a	n/a
Distribution Total			100%		100%		

Worker title	Minimum Qualifications for Target Role	Special Certification Requirements	Electrical Corporation % FTE Min Quals	Electrical Corporation % Special Certifications	Contractor % FTE Min Quals	Contractor % Special Certifications	Reference to Electrical Corporation Training/Qualification Programs
Transmission							
Transmission Lineman	<ul style="list-style-type: none"> Journeyman Lineman having completed an accredited apprenticeship program IBEW Journeyman Lineman status in good standing Class A California Driver's License	*QEW, Overhead and/or Underground Inspection Training	34%	100%	0%	n/a	Line Assistant and Apprenticeship Program
Transmission Patroller	<ul style="list-style-type: none"> Journeyman Lineman having completed an accredited apprenticeship program IBEW Journeyman Lineman status in good standing Class A California Driver's License 18 months experience in overhead and underground transmission construction and maintenance within the past 3 years	*QEW, Overhead and/or Underground Inspection Training	7%	100%	0%	n/a	Line Assistant and Apprenticeship Program
Working Foreman-Electric Transmission	<ul style="list-style-type: none"> Journeyman Lineman having completed an accredited apprenticeship program IBEW Journeyman Lineman status in good standing Valid California Class A driver's license Class A Medical Certificate 18 months' experience in transmission construction and Energized High Voltage hotline	*QEW, Overhead and/or Underground Inspection Training	7%	100%	0%	n/a	Line Assistant and Apprenticeship Program

Worker title	Minimum Qualifications for Target Role	Special Certification Requirements	Electrical Corporation % FTE Min Quals	Electrical Corporation % Special Certifications	Contractor % FTE Min Quals	Contractor % Special Certifications	Reference to Electrical Corporation Training/Qualification Programs
	maintenance within the past 5 years						
Thermographer	<ul style="list-style-type: none"> Part 107 drone license or must obtain within first year Level I Infrared Certification or must obtain within first year 	Thermography certificate *QEW or Electrician	9%	100%	0%	n/a	
Senior Thermographer	<ul style="list-style-type: none"> Part 107 drone license or must obtain within first year Level III IR Certification or must obtain within first year 	Thermography certificate *QEW or Electrician	3%	100%	0%	n/a	
Transmission Construction Supervisor	6+ years— Construction and maintenance experience	*QEW, Overhead and/or Underground Inspection Training	40%	100%	0%	n/a	Line Assistant and Apprenticeship Program Essentials of Supervision
Inspection and Treatment Foreman	<ul style="list-style-type: none"> Pesticide handler training Valid class C driver's license 1st aid / CPR qualified 		0%	n/a	100%	n/a	
Transmission Total			100%		100%		
Substation							
Substation Inspector	<ul style="list-style-type: none"> Substation Electrician Journeyman having completed electrician apprenticeship program Valid California Class A driver's license 	*QEW	75%	100%	0%	n/a	Electrician Apprenticeship Program
Substation Construction Supervisor	Journeyman with 5+ year' experience	*QEW	25%	100%	0%	n/a	Electrician Apprenticeship Program

Worker title	Minimum Qualifications for Target Role	Special Certification Requirements	Electrical Corporation % FTE Min Quals	Electrical Corporation % Special Certifications	Contractor % FTE Min Quals	Contractor % Special Certifications	Reference to Electrical Corporation Training/Qualification Programs
							Essentials of Supervision
Total			100%				

OEIS Table 8-10: Workforce Planning, Grid Hardening

Worker Titles	Minimum Qualifications	Special Certification Requirements	Electrical Corporation % FTE Min Quals	Electrical Corporation % Special Certifications	Contractor % FTE Min Quals	Contractor % Special Certifications	Reference to Electrical Corporation Training/Qualification Programs
Distribution							
Apprentice Lineman	<ul style="list-style-type: none"> 9 months' experience as Line Assistant Valid California driver's license Must have held previous position for at least 9 months 	No special certification required	19%	n/a	15%	n/a	Line Assistant and Apprenticeship Program
Cable Splicer	<ul style="list-style-type: none"> Journeyman Lineman 	No special certification required	0%	n/a	9%	100%	Line Assistant and Apprenticeship Program
Construction Manager-Electric	<ul style="list-style-type: none"> Bachelor's Degree or equivalent experience 8 years' experience 	No special certification required	2%	n/a	0%	n/a	Essentials of Supervision
Construction Supervisor-Electric	<ul style="list-style-type: none"> High School Diploma or GED 6 years' experience 	No special certification required	13%	n/a	0%	n/a	Line Assistant and Apprenticeship Program Essentials of Supervision

Worker Titles	Minimum Qualifications	Special Certification Requirements	Electrical Corporation % FTE Min Quals	Electrical Corporation % Special Certifications	Contractor % FTE Min Quals	Contractor % Special Certifications	Reference to Electrical Corporation Training/ Qualification Programs
	<ul style="list-style-type: none"> Complete 2-day program at Skills Training Center or complete outside program 						
District Manager	<ul style="list-style-type: none"> High School Diploma or GED 10 years' experience 	No special certification required	2%	100%	0%	n/a	Essentials of Supervision
Electric Troubleshooter	<ul style="list-style-type: none"> Complete 7-week RETS class and pass written and practical exams 	Journeyman Lineman	10%	100%	0%	n/a	Line Assistant and Apprenticeship Program RETS Training
Fault Finder	<ul style="list-style-type: none"> Complete 4-week RFF class and pass written and practical exams 	Journeyman Lineman	1%	100%	0%	n/a	Line Assistant and Apprenticeship Program RFF Training
Field Construction Advisor (FCA)	<ul style="list-style-type: none"> Journeyman Lineman 	QEW	0%	n/a	7%	100%	Line Assistant and Apprenticeship Program
Foreman	<ul style="list-style-type: none"> Journeyman Lineman 	QEW	0%	n/a	17%	100%	Line Assistant and Apprenticeship Program
Foreman (Splicing)	<ul style="list-style-type: none"> Journeyman Lineman 	QEW	0%	n/a	2%	100%	Line Assistant and Apprenticeship Program
Groundman	n/a	No special certification required	0%	n/a	2%	n/a	n/a
Journeyman Lineman	<ul style="list-style-type: none"> Journeyman Lineman 	QEW	0%	n/a	48%	100%	Line Assistant and Apprenticeship Program
Line Assistant (non QEW)	<ul style="list-style-type: none"> Successfully pass Company administered aptitude and skills tests 	No special certification required	6%	n/a	0%	n/a	Line Assistant and Apprenticeship Program

Worker Titles	Minimum Qualifications	Special Certification Requirements	Electrical Corporation % FTE Min Quals	Electrical Corporation % Special Certifications	Contractor % FTE Min Quals	Contractor % Special Certifications	Reference to Electrical Corporation Training/Qualification Programs
	<ul style="list-style-type: none"> Valid California Class A driver's license Pass a Department of Motor Vehicles (DMV) physical examination and Department of Transportation (DOT) drug screen Must have held previous position for at least 9 months 						
Distribution Lineman	<ul style="list-style-type: none"> Complete the minimum 3-year 6000-hour Lineman Apprentice program at the Skills Training Center and assigned Districts Complete a 3-year, 480-hour college-level program to be qualified to take the Journeyman Lineman's test Pass the Journeyman Lineman test 	QEW	39%	100%	0%	n/a	Line Assistant and Apprenticeship Program
Working Foreman-Electric Distribution	<ul style="list-style-type: none"> 6 months' experience in both overhead and underground electric during the past 3 years Valid California Class A driver's license Class A Medical Certificate Must have held previous position for at least 9 months 	QEW	8%	100%	0%	n/a	Line Assistant and Apprenticeship Program
Total			100%		100%		

Worker Titles	Minimum Qualifications	Special Certification Requirements	Electrical Corporation % FTE Min Quals	Electrical Corporation % Special Certifications	Contractor % FTE Min Quals	Contractor % Special Certifications	Reference to Electrical Corporation Training/ Qualification Programs
Transmission							
Construction Manager-Electric	<ul style="list-style-type: none"> Bachelor's Degree or equivalent experience 8 years' experience 	QEW	4%	100%	0%	n/a	Essentials of Supervision
Construction Supervisor-Electric	<ul style="list-style-type: none"> High School Diploma or GED 6 years' experience 	No special certification required	27%	n/a	0%	n/a	Line Assistant and Apprenticeship Program Essentials of Supervision
Line Assistant (non QEW)	<ul style="list-style-type: none"> Successfully pass Company administered aptitude and skills tests Valid California Class A driver's license Pass a DMV physical examination and DOT drug screen Must have held previous position for at least 9 months 	No special certification required	6%	n/a	0%	n/a	Line Assistant and Apprenticeship Program
Team Lead	<ul style="list-style-type: none"> Bachelor's Degree or equivalent experience 5 years' experience Professional Engineer License 	No special certification required	8%	n/a	0%	n/a	n/a
Transmission Lineman	<ul style="list-style-type: none"> Complete the minimum 3-year 6000-hour Lineman Apprentice program at the Skills Training Center and assigned Districts 	QEW	24%	100%	0%	n/a	Line Assistant and Apprenticeship Program

Worker Titles	Minimum Qualifications	Special Certification Requirements	Electrical Corporation % FTE Min Quals	Electrical Corporation % Special Certifications	Contractor % FTE Min Quals	Contractor % Special Certifications	Reference to Electrical Corporation Training/Qualification Programs
	<ul style="list-style-type: none"> Complete a 3-year, 480-hour college-level program to be qualified to take the Journeyman Lineman's test Pass the Journeyman Lineman test 						
Transmission Patroller	<ul style="list-style-type: none"> Valid California Class A driver's license Class A Medical Certificate 18 months experience in overhead and underground transmission construction and maintenance within the past 3 years Must reside within the service territory 	QEW	4%	100%	0%	n/a	Line Assistant and Apprenticeship Program
Working Foreman-Electric Transmission	<ul style="list-style-type: none"> Valid California Class A driver's license Class A Medical Certificate 18 months' experience in transmission construction and EHV hotline maintenance within the past 5 years Must have held previous position for at least 9 months 	QEW	27%	100%	14%	100%	Line Assistant and Apprenticeship Program Essentials of Supervision
Field Construction Advisor (FCA)	<ul style="list-style-type: none"> Journeyman Lineman 	QEW	0%	n/a	24%	100%	Line Assistant and Apprenticeship Program

Worker Titles	Minimum Qualifications	Special Certification Requirements	Electrical Corporation % FTE Min Quals	Electrical Corporation % Special Certifications	Contractor % FTE Min Quals	Contractor % Special Certifications	Reference to Electrical Corporation Training/Qualification Programs
Apprentice Lineman	n/a	No special certification required	0%	n/a	4%	n/a	n/a
Journeyman Lineman	<ul style="list-style-type: none"> Journeyman Lineman 	QEW	0%	n/a	45%	100%	Line Assistant and Apprenticeship Program
Groundman	n/a	No special certification required	0%	n/a	2%	n/a	n/a
Operator	<ul style="list-style-type: none"> Crane license, if operating a crane 	No special certification required	0%	n/a	11%	n/a	n/a
Total			100%		100%		

OEIS Table 8-11: Workforce Planning, Risk Event Inspection

Worker title	Minimum Qualifications for Target Role	Special Certification Requirements	Electrical Corporation % FTE Min Quals	Electrical Corporation % Special Certifications	Contractor % FTE Min Quals	Contractor % Special Certifications	Reference to Electrical Corporation Training/Qualification Programs
Electric Troubleshooter	<ul style="list-style-type: none"> Journeyman Lineman who completed an accredited apprenticeship program IBEW Journeyman Lineman status in good standing Complete 7-week RETS class and pass the associated written and practical exams 	QEW	100%	100%	0%	n/a	RETS Training Line Assistant and Apprenticeship Program
Total			100%		0%		

8.1.9.1 Asset Inspection Workforce Planning Improvement Plans (WMP.1334)

8.1.9.1.1 Extended Reality

SDG&E is exploring and implementing extended reality for PSPS Pre-Patrol inspections for new qualified electrical workers (QEWs), apprentices, and support personnel to better understand the PSPS pre-patrol procedures and distinguish between fire hazard and non-fire hazard conditions. Over 350 employees have completed an extended reality PSPS training since its development in 2022. QEW employees were surveyed after training and 80 percent responded that they believed the extended reality training was helpful in learning the role and procedure for PSPS Patrols.

8.1.9.1.2 Line Checker Program

Line Checker is a new classification in development for 2023. Line Checkers will be required to complete a 7-month training program to conduct detailed inspections as per GO 95, 128, 165 and SDG&E Construction Standards. Line Checkers will perform patrols, detailed visual inspections, and ground level onsite corrective maintenance. They will be limited to what can be performed safely without a QEW present. In addition to extensive classroom training and ride-alongs, Line Checkers will be expected to complete a 4-month probationary period to develop their proficiency in the field. This probationary period will include individual QA reviews on completed inspections.

8.1.9.1.3 Safety Observations

SDG&E tracks safety observations performed across all districts and organizations, including both supervisor/leadership observations as well as peer-to-peer observations. Operational leadership is encouraged to conduct safety observations of the workforce in the field and the office. These safety observations build trust and promote psychological safety across all levels of the workforce.

Peer-to-peer observations take place within SDG&E's Behavior Based Safety (BBS) program. SDG&E's BBS program is a proactive approach to safety management, focusing on principles that recognize at-risk behaviors as a frequent cause of both minor and serious injuries. The purpose of this program is to reduce the occurrence of at-risk behaviors by modifying an individual's actions and/or behaviors through observation, feedback, and positive interventions aimed at developing safe work habits. Identified risks and hazards are documented and best practices and lessons learned are shared real-time with personnel being observed.

Employee safety observations are documented and reported to SDG&E's Safety business unit for enterprise transparency and accountability. Annual goals are set and tracked as a safety culture leading indicator. SDG&E also performs safety observations and jobsite safety inspections of this third-party contractor workforce. While SDG&E tracks its contractor safety observations and inspections, those figures are not included in this metric. SDG&E Table 8-33 includes SDG&E's historical performance metrics for employee-conducted Safety Observations. These metrics are included in Table 3 of the QDR.

SDG&E Table 8-33: Employee-Conducted Safety Observations

Year	Safety Observations
2018	9,157
2019	11,843

Year	Safety Observations
2020	15,801
2021	17,178
2022	20,355

8.1.9.1.4 Near Misses Reported

"Near Misses" are circumstances where "no property was damaged and no personal injury was sustained, but where, given a slight shift in time or position, damage [and/or] injury easily could have occurred," consistent with the use of those terms by Occupational Safety and Health Administration (OSHA) in its Near-Miss Incident Report Form template.²⁹ Near Miss Reporting provides employees and contractors the means to communicate safety concerns (anonymously, if desired), and provides SDG&E with an opportunity to identify potential risks/hazards, raise awareness, share lessons learned, perform data analytics, and implement proactive safety improvements, when applicable, to prevent future incident or injury.

A Near Miss submittal is recognized as a leading indicator safety statistic. Lagging indicators, like OSHA injury statistics, can provide information on a failure in an area of a safety and health program or the existence of a hazard. Leading indicators allow preventive action to be taken that addresses that failure or hazard before it turns into an incident. Near Misses provide SDG&E with an opportunity to increase awareness of a potential risk or hazard and take proactive action to implement safety improvements, where applicable, to prevent future injury or incident.

Near Misses can be submitted via an online portal or smart phone mobile application. All personnel are encouraged to share near miss events as they occur and report to SDG&E's Safety business unit. Near miss events are then shared broadly and tracked with appropriate follow-up and feedback. SDG&E collects and separately tracks Contractor-submitted Near Miss reports. SDG&E Table 8-34 includes SDG&E's historical performance metrics for employee-submitted Near Misses. These metrics are included in Table 3 of the QDR.

SDG&E Table 8-34: Employee-Submitted Near Misses

Year	Near Misses
2018	65
2019	83
2020	111
2021	251
2022	371

²⁹ <https://www.osha.gov/sites/default/files/2021-07/Template%20for%20Near%20Miss%20Report%20Form.pdf>

8.1.9.2 Grid Hardening Workforce Planning Improvement Plans (WMP.1331)

SDG&E maintains ESP 113.1 for Wildland Fire Operations and Maintenance specific to Wildland Fire Prevention. The intent of ESP 113.1 is to formalize procedures and routine practices to assist employees, contractors, and consultants in their understanding of wildfire prevention and to improve their ability to prevent the start of any fire. Updates to ESP 113.1 are done on an annual basis and communicated to employees, contractors, and consultants.

In addition, Grid Hardening enhances the training and qualifications of their workers by providing a constant feedback loop on the job. This is done through post construction inspections and true-ups of as-builts using LiDAR technology.

The QA/QC teams complete post construction inspections, which compares the project build to the design guide. Any errors, omissions, or craftsmanship improvements are provided to the workers to enhance their knowledge and skills for future projects.

The true-up of as-builts using LiDAR technology compares the project build to the PLS-CADD design, which models the as-built condition. Any discrepancies between the as-built model and the as-built are reviewed with workers to identify lessons learned to update the design guide when appropriate.

8.1.9.3 Risk Event Inspection Workforce Planning Improvement Plans (WMP.1206)

Risk event inspection improvement plans include modernizing training utilizing virtual reality for overhead CMP and PSPS patrols and observer roles.

8.2 Vegetation Management and Inspection

8.2.1 Overview

SDG&E continues to address the risk of vegetation-infrastructure contact outages and ignitions through its comprehensive Vegetation Management Program. In 2022, the Vegetation Management Program continued its successes in tracking and maintaining its inventory tree database (WMP.511), completing routine and enhanced tree patrols (WMP.494 and WMP.501 respectively), pruning and removing hazardous trees (WMP.508), replacing unsafe trees with species that are more compatible with powerlines (WMP.1325), and pole brushing (WMP.512). This resulted in inspections of over 500,000 trees across the service territory, over 35,000 poles brushed, and nearly 10,500 trees trimmed beyond regulatory clearances. SDG&E's WMP vegetation management initiatives span several activities including inspections, trimming and removals, fuels treatment, pole brushing, and audit.

Inspections consist of an annual, detailed, and documented inspection activity of each inventory tree record within the service territory. Inventory trees are systematically assigned a unique alpha-numeric identification. Data collected on each inventory tree includes property location, customer information, span location, GPS coordinates, species, line clearance, growth rate, diameter at breast height (DBH), prune status, and tree health.

Fuels Management (WMP.497) is a vegetation thinning activity that entails enhanced clearing around inventoried subject poles located within the HFTD that carry hardware that are subject to pole brushing requirements in PRC § 4292. This fuels treatment program is not regulatory-required and is a

discretionary activity SDG&E performs as an additional risk mitigation. Data collected includes property location, customer information, span location, GPS coordinates, work status, and history.

PowerWorkz, the Vegetation Management Program's system of record, consists of CityWorks, a centralized server for the creation of electronic work orders associated with Vegetation Management activities, and a database of all tree inventory records. It also includes Epoch, the mobile field application where all Vegetation Management assets (tree and pole brush records) are updated by contractors associated with the activities of pre-inspection, tree trimming, pole brushing, and auditing. The fuels management activity is currently not included in this application at this time.

SDG&E activities are reviewed for environmental and cultural impact and released to perform work by identifying any applicable constraints or restrictions to ensure species and habitat protection in accordance with environmental rules and regulations.

Vegetation Management performs a QA/QC audit (WMP.505) on a percentage of all activities. In general, a 15 percent sample is selected to be performed after activities are completed. Vegetation Management performs an audit on 100 percent of all hazard tree and tree removal activities completed which result from the off-cycle, HFTD inspection activity.

All scheduled trimming activities are recorded in the tree asset record within the electronic inventory database. Upon work completion, the tree trim records are updated with a work status (condition code) and timestamp. Tree work is issued and tracked via electronic parent SWO within each Vegetation Management Area (VMA). Contractors in turn create multiple child DWO within each SWO to distribute to the field crews. Upon completion of the field work, contractors complete the DWOs and the assigned SWOs in the database. Condition codes and dates completed are used to track and prioritize work completion at the individual tree level, and within the associated work orders. Work orders can be ascribed high priority to be completed in a more urgent timeframe

Vegetation Management works with its contractors to determine the level of staffing required to complete all activities following the annual Master Schedule. Contractors are required to provide the necessary training to their workforce on the technical capabilities to perform the work. SDG&E collaborates externally with the San Diego Community College District, Utility Arborist Association, local International Brotherhood of Electrical Workers (IBEW) union, and other IOUs in the development and execution of a Line Clearance Arborist Training program. Should additional resources be required to address emergency work, SDG&E relies on its contractor to attain subcontracted resources and/or mutual-aid support from the neighboring utilities.

8.2.1.1 Objectives

OEIS Table 8-12: Vegetation Management Initiative Objectives (3-year plan)

Objective Number	Objectives for Three Years (2023–2025)	Applicable Initiative(s), Tracking ID(s)	Applicable Regulations, Codes, Standards, and Best Practices (See Note)	Method of Verification (i.e., program)	Completion Date	Reference (section & page #)
8.2.01	Create new attribute fields within tree inventory database to document site-specific and tree-specific risk conditions.	Vegetation Management Enterprise System WMP.511	n/a	n/a	12/31/2025	8.2.4, p. 287
8.2.02	Vegetation Management Enterprise System	Vegetation Management Enterprise System WMP.511	n/a	n/a	12/31/2025	8.2.4, p. 287
8.2.03	Create system on server-side application to auto-close Dispatch Work Orders upon closure of Scheduling Work Orders	Vegetation Management Enterprise System WMP.511	n/a	n/a	12/31/2025	8.2.4, p. 287
8.2.04	Integrate risk-analysis into annual, off-cycle HFTD and at-risk patrols	Off-Cycle Patrols; WMP.508	n/a	n/a	12/31/2025	8.2.3.5, p. 284
8.2.05	Continue pole clearing (brushing) including multiple, annual activities of mechanical, chemical, and re-clear activities to prevent ignitions. Continue pole brushing in areas not required by law as an added fire-prevention activity. Continue integrated TGR application during the pre-inspection process.	Pole Clearing, “Brushing”; WMP.512	*PRC § 4292	Completed work orders/ GIS Data Submission(s)	12/31/2025	8.2.3.1, p. 278
8.2.06	Continue to thin flammable vegetation around select poles subject to PRC § 4292 using risk and environmental impact criteria. Pilot alternate methods of thinning such as the cultural use of goats for sustainability goals.	Fuels Management Program; WMP.497	*PRC § 4292	Completed work orders/ GIS Data Submission(s)	12/31/2025	8.2.3.1, p. 278
8.2.07	Continue performing multiple inspection activities in the HFTD including "Level-2" hazard tree patrols within the entire "utility strike zone" to identify risk trees that could impact the overhead conductor	Off-Cycle Patrols; WMP.508	<ul style="list-style-type: none"> • PRC § 4293 • GO 95, Rule 35 	Completed work orders/ GIS Data Submission(s)	12/31/2025	8.2.3.3, p. 282

Objective Number	Objectives for Three Years (2023–2025)	Applicable Initiative(s), Tracking ID(s)	Applicable Regulations, Codes, Standards, and Best Practices (See Note)	Method of Verification (i.e., program)	Completion Date	Reference (section & page #)
8.2.08	Continue pursuing expanded trim clearances greater than 12 feet in the HFTD for targeted species, exceeding regulatory requirements. Update methodology for modeling and forecasting application of enhanced clearances	Clearance, “Enhanced”; WMP.501	<ul style="list-style-type: none"> • *PRC § 4293 • GO 95, Rule 35 	Completed work orders/ GIS Data Submission(s)	12/31/2025	8.2.3.2, p. 281
8.2.09	Continue annual, required, internal contractor training for Hazard Tree, Environmental, Fire Preparedness, and Environmental Regulation. Develop and document internal training material for new Vegetation Management personnel	Workforce Planning WMP.506	n/a	Workforce Planning	12/31/2025	8.2.7, p. 292
8.2.10	Continue engagement and collaboration with California Community College of Education, UAA, local unions, and Joint IOUs on Line Clearance Tree Trimming training. Expand curriculum to include training for Certified Arborists	Workforce Planning WMP.506	n/a	Workforce Planning	12/31/2025	8.2.7, p. 292

**indicates that the electrical corporation exceeds a particular code, regulation, standard, or best practice. See Appendix E for further justification.*

OEIS Table 8-13: Vegetation Management Initiative Objectives (10-year plan)

Objective Number	Objectives for Ten Years (2026–2032)	Applicable Initiative(s), Tracking ID(s)	Applicable Regulations, Codes, Standards, and Best Practices (See Note)	Method of Verification (i.e., program)	Completion Date	Reference (section & page #)
8.2.11	Develop next generation electronic work management system to replace Epoch to enhance data management performance.	Vegetation Management Enterprise System WMP.511	n/a	n/a	12/31/2032	8.2.4, p. 287

Objective Number	Objectives for Ten Years (2026–2032)	Applicable Initiative(s), Tracking ID(s)	Applicable Regulations, Codes, Standards, and Best Practices (See Note)	Method of Verification (i.e., program)	Completion Date	Reference (section & page #)
8.2.12	Create system on server-side application to auto-close Dispatch Work Orders upon closure of Scheduling Work Orders	Vegetation Management Enterprise System WMP.511	n/a	n/a	12/31/2032	8.2.4, p. 287
8.2.13	Develop process for documentation and verification of inspection activities for non-inventory trees within the work management system.	Vegetation Management Enterprise System WMP.511	n/a	n/a	12/31/2032	8.2.4, p. 287
8.2.14	Continue pole clearing (brushing) including multiple, annual activities of mechanical, chemical, and re-clear activities to prevent ignitions. Continue pole brushing in areas not required by law as an added fire-prevention activity. Continue to replace subject equipment such as hot-line clamps and fuses to reduce ignition potential. Automate change-out notification for pole attachments subject to PRC § 4292. Continue integrated TGR application during the pre-inspection process	Pole Clearing, “Brushing”; WMP.512	*PRC § 4292	Completed work orders/ GIS Data Submission(s)	12/31/2032	8.2.3.5, p. 284
8.2.15	Continue to thin flammable vegetation around select poles using risk and environmental impact criteria. Pilot alternate methods of thinning such as the cultural use of goats for sustainability goals.	Fuels Management Program; WMP.497	*PRC § 4292	Completed work orders/ GIS Data Submission(s)	12/31/2032	8.2.3.1, p. 278
8.2.16	Continue off-cycle HFTD and at-risk species (i.e., Targeted Species; Century plant; bamboo) patrols using risk analysis, to prioritize and schedule using work history, outage frequency, and environmental (meteorology, soil moisture) factors	Off-Cycle Patrols; WMP.508	<ul style="list-style-type: none"> • PRC § 4293 • GO 95, Rule 35 	Completed work orders/ GIS Data Submission(s)	12/31/2032	8.2.4, p. 287

Objective Number	Objectives for Ten Years (2026–2032)	Applicable Initiative(s), Tracking ID(s)	Applicable Regulations, Codes, Standards, and Best Practices (See Note)	Method of Verification (i.e., program)	Completion Date	Reference (section & page #)
8.2.17	Continue pursuing expanded trim clearances greater than 12 feet in HFTD for targeted species, exceeding regulatory requirements. Establish benchmarking for optimal tree removal activities based on species, growth rate, tree density, risk.	Clearance, “Enhanced”; WMP.501	<ul style="list-style-type: none"> *PRC § 4293 GO 95, Rule 35 	Completed work orders/ GIS Data Submission(s)	12/31/2032	8.2.3.2, p. 281
8.2.18	Continue annual, required, internal contractor training for Hazard Tree, Environmental, Fire Preparedness, and Environmental Regulation. Develop and document internal training material for new Vegetation Management personnel. Review and implement modifications to annual VMA activity schedule and geographic boundaries to maximize operational efficiency and risk priority.	Workforce Planning WMP.506	n/a	Workforce Planning	12/31/2032	8.2.7, p. 292
8.2.19	Continue engagement and collaboration with California Community College of Education, UAA, local unions, and joint IOU on Line Clearance Tree Trimming training. Expand curriculum to include training for Certified Arborists	Workforce Planning WMP.506	n/a	Workforce Planning	12/31/2032	8.2.7, p. 292

**indicates that the electrical corporation exceeds a particular code, regulation, standard, or best practice. See Appendix E for further justification.*

8.2.1.2 Targets

OEIS Table 8-14: Vegetation Management Initiative Targets by Year

Initiative Activity	Tracking ID	2023 Target & Unit	% Risk Impact 2023	2024 Target & Unit	% Risk Impact 2024	2025 Target & Unit	% Risk Impact 2025	Method of Verification
Fuels Management	WMP.497	500 poles	0.6259%	500 poles	0.6259%	500 poles	0.6259%	GIS Data Submission(s)

Initiative Activity	Tracking ID	2023 Target & Unit	% Risk Impact 2023	2024 Target & Unit	% Risk Impact 2024	2025 Target & Unit	% Risk Impact 2025	Method of Verification
	(8.2.3)							
Pole Clearing	WMP.512 (8.2.3.1)	33,010 poles	2.8435%	33,010 poles	2.8435%	33,010 poles	2.8435%	GIS Data Submission(s)
Clearance	WMP.501 (8.2.3.3)	11,200 trees	0.1034%	11,200 trees	0.1034%	11,200 trees	0.1034%	GIS Data Submission(s)

OEIS Table 8-15: Vegetation Inspections Targets by Year

Initiative Activity	Tracking ID	Target End of Q2 2023 & Unit	Target End of Q3 2023 & Unit	End of Year Target 2023 & Unit	% Risk Impact 2023	Target End of Q2 2024 & Unit	Target End of Q3 2024 & Unit	End of Year Target 2024 & Unit	% Risk Impact 2024	Target End of Q2 2025 & Unit	Target End of Q3 2025 & Unit	Target 2025 & Unit	% Risk Impact 2025	Method of Verification
Detailed Inspection	WMP.494(8.2.2.1)	241,800 inspections	374,200 inspections	485,400 inspections	24.85 %	241,800 inspections	374,200 inspections	485,400 inspections	24.85 %	241,800 inspections	374,200 inspections	485,400 inspections	24.85 %	GIS Data Submission(s)
Off-Cycle Patrol	WMP.508 (8.2.2.1.1)	9 VMAs	106 VMAs	106 VMAs	n/a	9 VMAs	106 VMAs	106 VMAs	n/a	9 VMAs	106 VMAs	106 VMAs	n/a	GIS Data Submission(s)

8.2.1.3 Performance Metrics Identified by the Electrical Corporation

OEIS Table 8-16: Vegetation Management and Inspection Performance Metrics Results by Year

Performance Metrics	2020	2021	2022	2023 Projected	2024 Projected	2025 Projected	Method of Verification
Vegetation outages in the service territory per 1000 OCM	4.73	6.35	4.9	5.02	5.02	5.02	QDR
Vegetation outages in HFTD per 1000 OCM	1.73	2.61	4.35	2.74	2.74	2.74	QDR
Vegetation ignitions in the HFTD per 1000 OCM -Distribution	0	0	0.29	0.06	0.06	0.06	QDR
Trees with pending work per OCM - HFTD	3.37	2.44	4.15	3.55	3.55	3.55	QDR
Enhanced trim/removal (target species) per OCM -HFTD	5.03	3.64	3.04	3.19	3.19	3.19	QDR

8.2.1.3.1 Vegetation Inspections and Clearance in the HFTD

The number of inventory trees (trees that can impact the electric system) within the service territory can vary from year to year but averages around 485,000 trees each year and roughly 255,000 in the HFTD. As shown in Figure 8-27, this averages approximately 74 trees per circuit mile within the HFTD and has stayed consistent over the past 8 years. Each year, an average of 30 percent of inventory trees within the HFTD are trimmed or removed and approximately 5 percent receive enhanced trimming or removal beyond the minimum 12-foot clearance. The Enhanced Vegetation Management program (WMP.501) was formally introduced in 2019 to target additional clearances on tree species that posed an additional threat to powerlines. As SDG&E has inspected each of these targeted species for enhanced clearances each year, the number of trees that require enhanced trimming has decreased slightly in 2021 and 2022. SDG&E will continue to investigate this trend as the number of trees that require enhanced clearances can be impacted by many factors. Overall, vegetation management activities are part of a mature program and are expected to remain relatively constant over the next WMP period.

Figure 8-27: Vegetation Inspections and Clearance in the HFTD

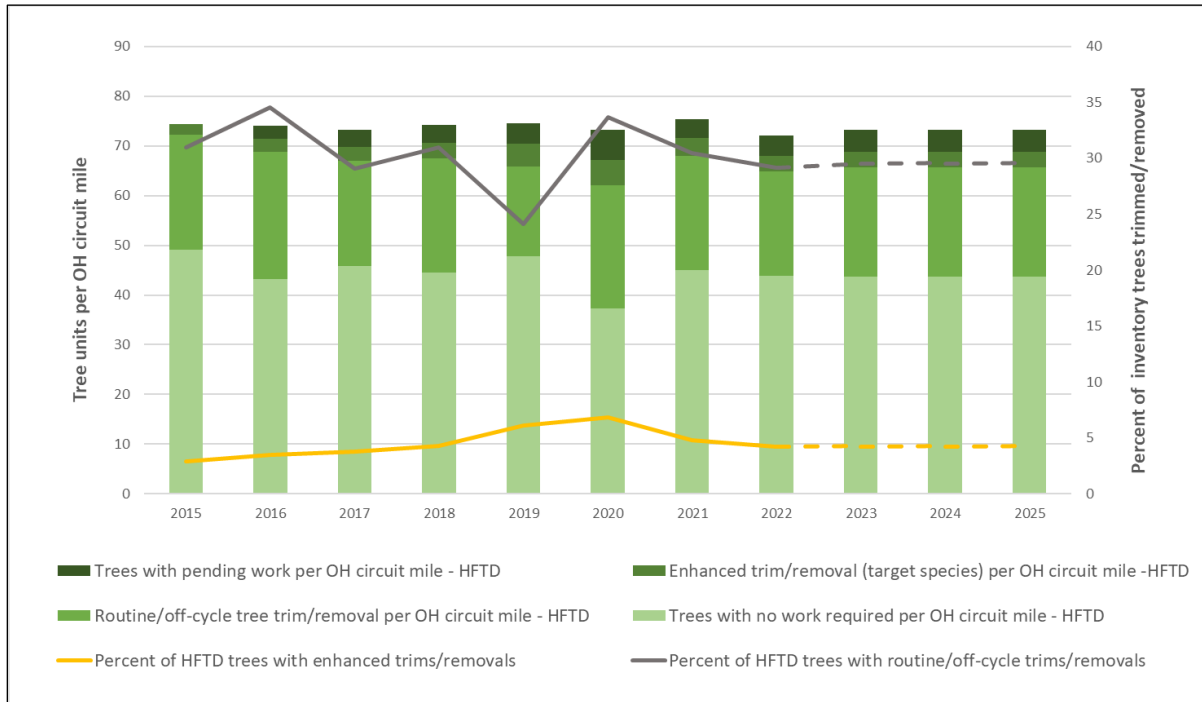

8.2.1.3.2 Vegetation Outages and Ignitions in the HFTD

Vegetation-related risk events and ignitions remain a relatively low percentage of overall events. As shown in Figure 8-28, vegetation-related outages represent less than 3 percent of all overhead primary distribution outages. Additional work on vegetation management within the HFTD has produced positive results as the system saw an average of 4.6 vegetation-related outages within the HFTD between 2015 and 2017 and 2.6 between 2018 and 2022. Similarly, ignitions associated with vegetation-related events have decreased with only one ignition on the primary distribution system between 2018 and 2022 for an average of 0.2 ignitions per year as compared to 2015 to 2017 which saw an average of three ignitions per year. SDG&E’s projections for these events moving forward are aligned with the 5-year average and are expected to remain relatively stable.

Figure 8-28: Vegetation Outages and Ignitions in the HFTD

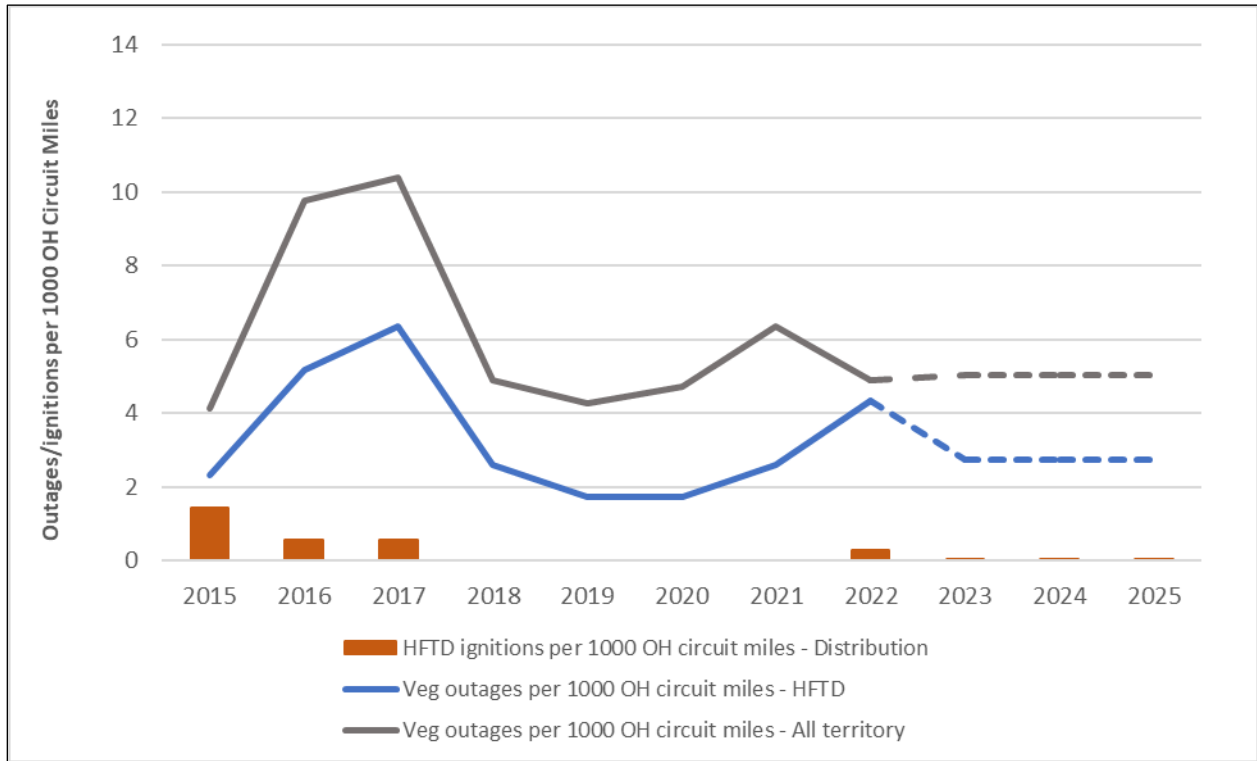

8.2.2 Vegetation Inspections

OEIS Table 8-17: Vegetation Management Inspection Frequency, Method, and Criteria

Type	Inspection Program	Frequency or Trigger	Method of Inspection	Governing Standards & Operating Procedures
Transmission and Distribution	Detailed Vegetation Inspections (WMP.494)	Annual; in HFTD twice-annual	Ground inspection; helicopter inspection	GO 95, Rule 35; PRC § 4293; NERC FAC-003-4
Transmission and Distribution	Off-Cycle HFTD Patrols (WMP.508)	Annual; in HFTD twice-annual	Ground inspection	GO 95, Rule 35; PRC § 4293; NERC FAC-003-4
Transmission	Substation (see Section 8.1.3.11)	Monthly/bi-monthly	Ground inspections	GO 174

8.2.2.1 Detailed Vegetation Inspections (WMP.494)

Vegetation management operations are driven by regulatory requirements and follow an annual, master schedule that includes pre-inspection, tree trimming, auditing, and pole brushing (WMP.512). During the annually scheduled routine inspection activity, all inventory trees are inspected to determine whether they require pruning for the annual cycle. Information for each inventory tree is recorded within the electronic inventory tree database, PowerWorkz.

Inspection³⁰ activities are performed conjointly for distribution and transmission facilities. Vegetation Management does not perform vegetation inspection or maintenance activities within substation facilities. Vegetation Management responsibilities for maintenance begin in the portion of the first span located outside the fenced perimeter of substation facilities. Vegetation inspection and maintenance within the perimeter of a substation must be performed by QEWS. This activity is performed by Kearny Maintenance and Operations. Vegetation maintenance within the physical perimeter of substation fencing and immediately adjacent to the outside the perimeter of substation fencing is performed by SDG&E's Real Estate, Facilities, & Land Services Department.

There are two levels of vegetation management inspections:

- Level 1 inspection is a cursory assessment of trees within the right-of-way to determine which require pruning for the annual cycle based on tree growth and/or to abate a hazardous condition.
- Level 2 inspection is a 360-degree visual assessment of a tree where the crown, trunk, canopy, and above-ground roots are evaluated for specific hazards to the electric infrastructure. This may also involve simple tools such as a mallet to sound the tree trunk.

Detailed vegetation inspections (WMP.494) follow an annual, static Master Schedule of activities. Activities are scheduled and performed using a system of geographic VMA. The service territory is comprised of 133 VMAs. Each VMA may consist of several distribution circuits and transmission lines, and each may include several thousand inventory trees and hundreds of brushed poles.

Ten to twelve VMAs are pre-inspected each month within the Master Schedule such that all 133 VMAs are completed each year. During the detailed inspection activity, all trees within and adjacent to the distribution and transmission right-of-way are assessed to determine whether tree trimming or removal is required for the annual cycle. Within the HFTD, all trees in the utility strike zone are assessed for tree growth and hazard potential, including a 360-degree, Level-2 inspection of the trees from the ground to the canopy. A Level-2 inspection includes an overall visual inspection of the tree's health including the root zone, trunk, and branches, and may entail sounding of the tree for structural integrity.

8.2.2.1.1 Process

During the detailed vegetation inspection activity (WMP.494), the pre-inspector determines which trees in the landscape meet SDG&E's criteria for an inventory tree: a tree that may encroach within the minimum clearance requirements by growth or that may otherwise pose a threat to the overhead facilities due to trunk or branch failure within 3 years of inspection. Inventory trees are managed and tracked within PowerWorkz. Each inventory is assigned a unique, alpha-numeric identification and is represented in the system as an electronic tree record. The tree record includes a rich data set of information including tree species, height, DBH, GPS location, clearance, general tree health, tree work status, activity history, and customer information. Each inventory tree record within a VMA is updated during the detailed inspection activity.

During routine pre-inspection within the HFTD, all trees within the strike zone of transmission and distribution lines receive a Level 2 hazard evaluation. Trees tall enough to strike overhead electric lines

³⁰ These may also be referred to as "pre-inspection" activities. Pre-inspection is a commonly used term to denote inspection activities that occur prior to tree trimming.

are assessed for trimming or removal and include identification of dead, dying, and diseased trees, live trees with a structural defect, and conditions such as wind sway and line sag. The visual inspection includes a 360-degree hazard assessment of trees from ground level to canopy height to determine tree health, structural integrity, and environmental conditions. Where appropriate, sounding techniques or root examination may also be conducted. Where required, trees are trimmed or removed to prevent line-strike from either whole tree failure or limb break out. Figure 8-29 shows the inspection process.

Figure 8-29: Detailed Vegetation Inspections Process Flow

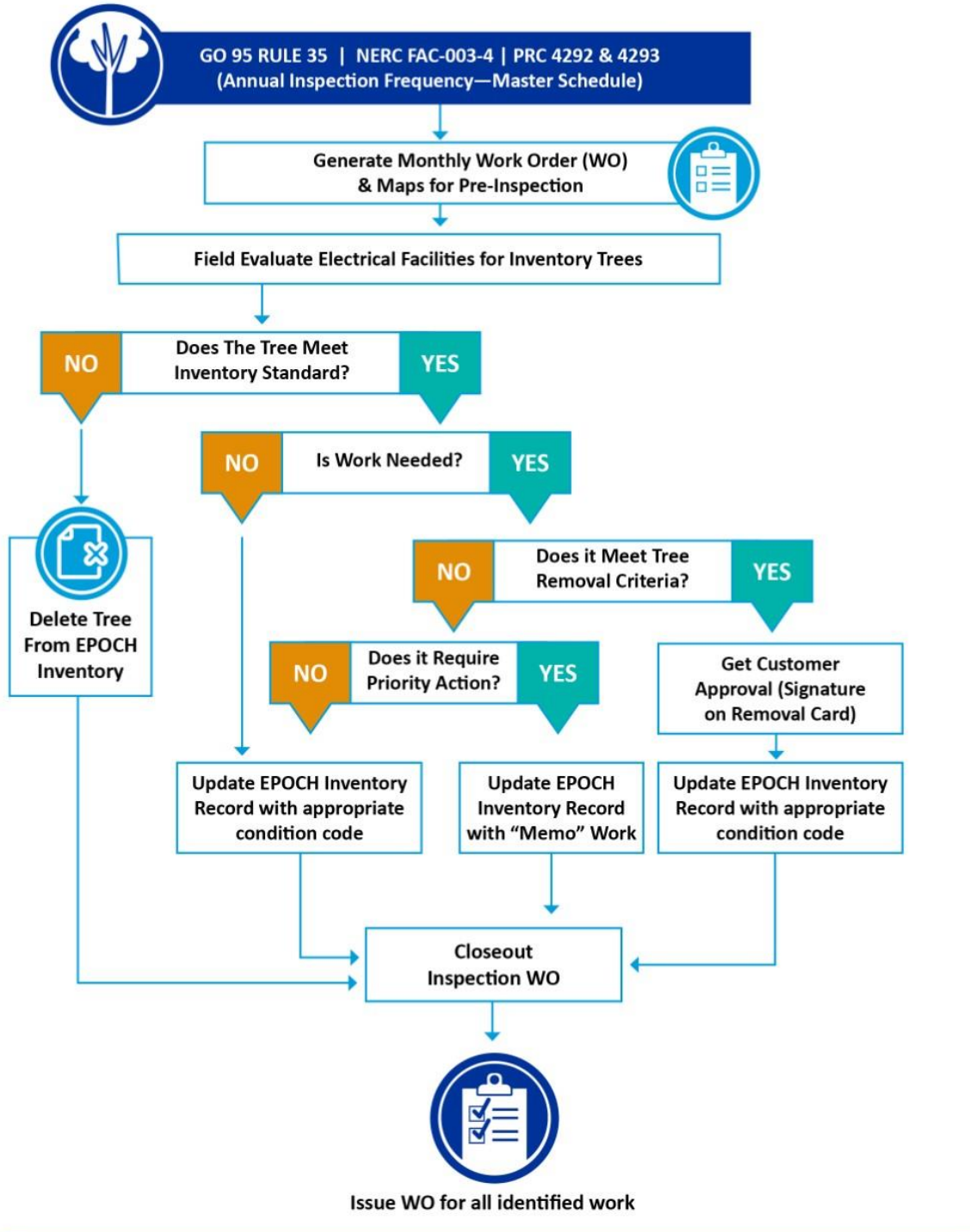

8.2.2.1.2 Frequency or Triggers

Detailed vegetation inspections (WMP.494) are performed annually throughout the service territory following the static Master Schedule. Detailed vegetation inspection frequency is driven primarily by the regulatory requirements of GO 95, Rule 35; PRC § 4293; and NERC FAC-003-4. Within the HFTD, tree inspections are performed twice annually. The second, incremental HFTD inspection activity is described in Section 8.2.2.2 Off-Cycle Patrol Inspections. Species-specific risk-based vegetation inspections are performed annually including Century Plant and Bamboo. These inspection activities are performed throughout the service territory. Century Plant and Bamboo inspection activities are described in Section 8.2.2.2.2. During the post-trim QA/QC audit activity (WMP.505), an audit contractor performs a cursory vegetation inspection of all overhead lines within each VMA. This activity occurs 6 to 8 months following the routine scheduled detailed inspection activity and serves as a “mid-cycle” patrol to ensure vegetation does not pose a compliance or safety risk to the lines prior to the next inspection activity.

Risk prioritization is incorporated in scheduling detailed vegetation inspection activities. Following the annual Master Schedule, routine tree trimming activities occur 2 to 4 months after the inspection activity for a given VMA. For example, VMAs whose routine inspection occurs in January are subsequently trimmed during the months of March and April. During the routine inspection activity, if a tree is found to be near the power lines or exhibits an elevated hazardous threat, the tree will be treated as a “Memo” and issued to the tree trim contractor to work on a priority basis. A Memo tree can be prioritized as a same-day trim or up to two weeks to complete depending on the conditions.

8.2.2.1.3 Accomplishments, Roadblocks, and Updates

Enhancements and progress made since the last WMP submission include:

- Implemented multiple update releases to Epoch. Enhancements included software updates, addition of tree Genus/species attribute field, and new electronic mapping imagery to enhance field navigation and data accuracy.
- Integrated Vegetation Risk Index (VRI) GIS mapping layer into Epoch mobile application for user situational awareness during inspections.
- Engaged with a third party to study the correlation between enhanced tree trim clearances and reduction of vegetation-caused outages.
- SDG&E, PG&E, and SCE began collaboration on a vegetation clearance study to determine the effectiveness of expanded trim clearances on risk-event frequency (see response to Areas for Continued Improvement 22-21 in Appendix D).
- Continued engagement with the Electric Power Research Institute, Inc (EPRI) to study the relationship between expanded clearances and reduction in tree-related outages. For more information see response to Areas for Continued Improvement SDGE 22-09 in Appendix D.
- Hired four internal Forester Patroller positions to perform off-cycle tree inspections within the HFTD.

Roadblocks the electric corporation has encountered:

- Concurrence from land agencies such as California State Parks and U.S. Forest Service on SDG&E’s implementation of enhanced vegetation management clearances including the mitigation of perceived hazards outside utility rights-of-ways remained a challenge. SDG&E met with California State Parks and Forest Service to discuss enhanced Vegetation Management

activities and reached consensus on work scope that achieves SDG&E's risk mitigation strategies while ensuring environmental and resource protection requirements.

Changes/updates to the inspection including known plans the electric corporation may implement in the next 5 years:

- Further integrate and operationalize land-based (vehicle and personnel) LiDAR, satellite imagery technology, and risk analyses into detailed inspection activities and decision-making
- Continue to collaborate with joint IOUs on multi-year vegetation management enhanced clearance study, and hazard tree inspection best management practices
- Further integrate VRI into inspection activities for the HFTD
- Further engage third-party study on risk modeling at the tree asset and span level
- Continue eradication program of Century plants within transmission corridors through biological means (herbicide use).
- Began a strategic sourcing effort in 2022 to go out to bid for all Vegetation Management contracts in 2023 with the option to extend service agreements up to 7 years which will provide better long-term planning, stability, and resource management with vendors.

8.2.2.2 Off-Cycle Patrol Inspections (WMP.508)

Vegetation Management performs a second annual tree inspection activity within the HFTD referred to as the "off-cycle" patrol (WMP.508). Of the 133 VMAs in the service territory, 106 are either partially or wholly within the HFTD. Approximately 240,000 of the 485,000 inventory trees are located within the HFTD.

In addition to the off-cycle HFTD patrol, additional annual inspections are performed for Century Plant and Bamboo due to their fast and unpredictable growth. Century Plants (Agave) have a flowering stage at the end of their lifecycle that includes the growth of an elongated, vertical flower stalk. Upon emerging, the stalk can grow to the height of power lines in weeks and may pose an ignition threat. Bamboo are fast-growing species that are difficult to manage for line clearance within a single annual trim cycle. Additional inspections of Century Plant and Bamboo have proven effective in intercepting the growth of these species and preventing contact and potential ignition.

8.2.2.2.1 Process

The scope of the off-cycle HFTD patrol (WMP.508) is similar to the routine, detailed vegetation inspection activity in the HFTD. During the off-cycle HFTD patrol all trees within the strike zone of the secondary, distribution, and transmission lines receive a Level 2 hazard evaluation. Trees tall enough to strike overhead electric lines are assessed for trimming or removal and include identification of dead, dying, and diseased trees, live trees with a structural defect, and conditions such as wind sway and line sag. The visual inspection includes a 360-degree hazard assessment of trees from ground level to canopy height to determine tree health, structural integrity, and environmental conditions. Where appropriate, sounding techniques or root examination may also be conducted. The off-cycle patrol is performed by internal Patrollers and by contractors who are International Society of Arboriculture (ISA)-Certified Arborists. Certified Arborists specialize in hazard tree assessment, and all who perform off-cycle patrols receive annual hazard tree refresher training. The off-cycle patrol process is the same as detailed vegetation inspections, see Section 8.2.2.1 Detailed Vegetation Inspections for details.

8.2.2.2.2 Frequency or Triggers

The off-cycle patrol (WMP.508) represents the second annual inspection activity within the HFTD. Frequency is driven primarily by the regulatory requirements of GO 95, Rule 35; PRC § 4293; and NERC FAC-003-4. The off-cycle activity is based on the Vegetation Management Master Schedule. Any priority tree work identified during the off-cycle HFTD patrol is expedited as needed via the “Memo” process to mitigate the risk. Memos are completed the day a condition is observed or up to two weeks following depending on the situation's priority.

In 2022, the schedule and timing of the annual off-cycle HFTD patrol was modified. Prior to 2022, the annual off-cycle HFTD patrol was performed as an approximate mid-cycle inspection for each HFTD VMA. The activity occurs approximately six months following the routine inspection schedule of each HFTD VMA. In 2022, the schedule was modified to perform the off-cycle patrol in all 106 HFTD VMAs within the three-month quarter immediately preceding September, which is the onset of the Santa Ana Wind season in Southern California. The goal was to condense all off cycle HFTD inspections closer to the end of September.

In early 2022, a third-party vendor was engaged to conduct an efficacy study of the off-cycle HFTD patrol schedule to determine the optimum schedule based on historical tree risk within each HFTD VMA. Historical tree risk was measured by looking at the frequency of trees that have required a priority “Memo” trim, and/or were identified as a hazard tree. The study also considered increasing the 3-month off-cycle HFTD schedule to an 8-month schedule (January to August) and prioritizing the patrol activity for the riskiest VMAs closer to the month of September. This risk-based approach generates a machine learning model that scores trees based on descriptive features, historical growth patterns, and historical priority “Memo” trims. The model uses this data as features and produces a predicted score for the next cycle year. This predicted score is then used to help understand the tree’s likelihood of needing a priority “Memo” trim. To understand the growth risk at a higher level for operational purposes, scores are aggregated to each VMA. VMAs can then be ranked, which helps determine which ones may need the most attention. The VMA ranking provides input for generating the off-cycle HFTD schedule, which evenly distributes labor across the first 8 months of the year, provides time between the detailed and off-cycle inspections, and places the riskiest areas to be inspected closest to fire season.

For targeted species patrols, a second, annual inspection is performed for every inventory Century plant within the service territory. An additional annual inspection is performed for this species due to their fast and unpredictable growth. Century Plants (Agave) have a flowering stage at the end of their lifecycle that includes the growth of an elongated, vertical flower stalk. The stalk can grow to the height of power lines in weeks and may pose an ignition threat. The Century Plant patrol is scheduled in the spring each year when Century Plants typically bloom. Any plant with an emerging flower stalk is topped to prevent further encroachment into the power lines, and to prevent contact with the lines when the plant dies and the stalk falls.

The targeted species patrols for Bamboo are scheduled in the summer and fall each year. During these activities, every Bamboo in the Vegetation Management tree inventory database is inspected for growth. These patrols are in addition to the routine detailed inspection that occurs within each VMA’s scheduled month. Therefore, in essence, each inventory bamboo is inspected three times each year.

The additional inspection activities for Century Plant and Bamboo have proven effective in intercepting the growth of these species and preventing contact and potential ignition.

8.2.2.2.3 Accomplishments, Roadblocks, and Updates

Enhancements and progress made since the last WMP submission include:

- Engaged third-party study of off-cycle HFTD schedule (WMP.508) to determine optimum timeframe and prioritization of inspection activities based on risk metrics within each VMA Level.
- Modified the schedule of the off-cycle HFTD patrols in the VMAs to occur in Q3.
- Completed all scheduled, off-cycle HFTD patrols prior to September.
- Completed all targeted, additional Century Plant and Bamboo species patrol in 2022.
- Implemented multiple update releases to Epoch. Enhancements included software updates, addition of tree Genus/species attribute field, and new electronic mapping imagery to enhance field navigation and data accuracy.
- Created new electronic off-cycle, HFTD SWO in PowerWorkz to differentiate from routine inspection activity SWOs. Added ability to electronically map and record progression of inspection activities at the span level.
- Continued study with SDSC to develop risk modeling related to outage frequency and enhanced tree clearances.
- Completed redrawing of the VRI into new polygons based on the addition of several new pole-mounted weather stations, thus updating the associated risk to the circuit line segments.
- Continued additional inspection activities throughout 2022 as they have proven to be effective in mitigating the risk of outage, ignition, and wildfire.
- Engaged Patrollers to assist in the resolution of customer refusals while performing off-cycle patrols in the HFTD VMAs
- Proactively managed Century plants within transmission and distribution corridors through biological means (herbicide use). Approximately 610 Century plants were treated in 2022.

Roadblocks the electric corporation has encountered:

- Managing multiple Vegetation Management activity schedules within each VMA to avoid overlapping or redundant activities while ensuring data integrity. To do this, the off-cycle HFTD patrols were scheduled in some VMAs where the routine activity was concurrently scheduled to occur in the same month.
- Not having unique and specific HFTD SWO in the PowerWorkz work management system to differentiate from other Vegetation Management patrol activities. This issue was remediated in 2022 with the creation of new HFTD patrol SWOs which also allowed electronic mapping documentation of the patrols.
- Resource challenges with the number of SDG&E Patrollers to complete the off-cycle HFTD patrols. To overcome this, Pre-inspection and Auditing contractors were engaged to perform some of the off-cycle HFTD patrols.

Changes/updates to the inspection including known future plans the electric corporation may implement in the next 5 years:

- Continue to research and modify off-cycle HFTD schedule were necessary to optimize risk reduction.
- Identify proper resource need and allocation to perform the off-cycle HFTD inspection timely and efficiently.
- Identify additional and proactive HFTD inspection activity opportunities such as pre-PSPS and adverse weather condition and event patrols.
- Further integrate and operationalize risk and condition-based data such as meteorology and environmental conditions into ground-level decision-making.

8.2.3 Vegetation and Fuels Management (WMP.497)

Vegetation Management Fuels Activity Treatment

The fuels activity treatment includes the thinning of ground vegetation surrounding structures located in the HFTD where the risk of ignition and propagation is present. Specifically, vegetation is thinned in a 50-foot radius from the outside circumference of the structures down to an approximate 30 percent vegetation cover where achievable. Non-native vegetation is prioritized for thinning. The activity is also intended to protect infrastructure in the event of a wildfire. Structures that are subject to the pole clearing (brushing) (WMP.512) requirements of PRC § 4292 are targeted for fuels activity treatment. These structures are prioritized because the risk of ignition is relatively higher due to the presence of hardware that makes them subject to pole clearing. See Section 8.2.3.1 Pole Clearing (WMP.512) for details regarding this activity.

Vegetation Management performs a risk analysis review to determine which poles will be treated under this program. The analysis includes the identification of structures where the fuels component may be conducive to ignition. Risk Assessment and Mapping (WMP.442) and WRRM are tools used to identify higher risk areas in the HFTD to prioritize and perform fuels modification activities (see Figure 8-30). Aerial imagery can also be a valuable tool to further refine targeted work locations. Work locations are also pre-screened for environmental impact to avoid negative impact to species.

The fuels activity treatment is a discretionary activity SDG&E believes is a prudent, additional fire prevention measure.

Figure 8-30: Fuels Modification Sites Using Risk Assessment and Mapping and WRRM

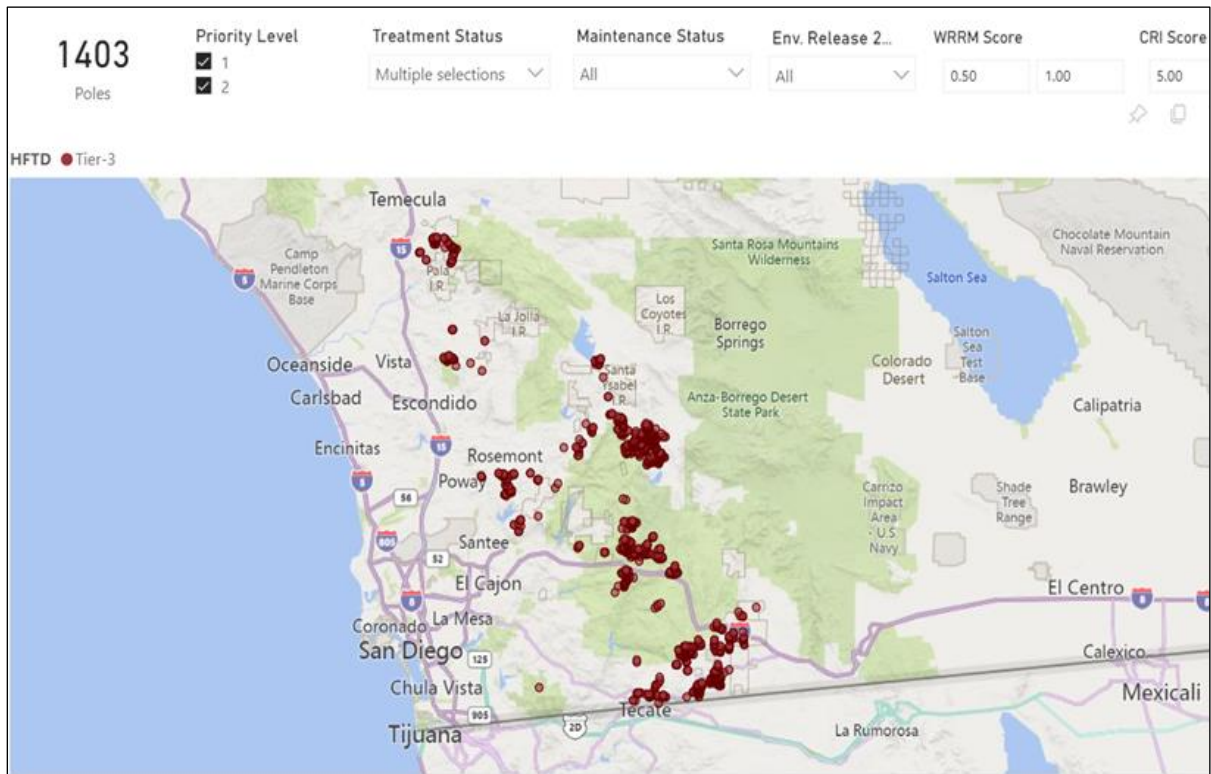

SDG&E sponsored a third-party study of its Fuels Treatment activities in 2022 to review the efficacy of the program and potential risk reduction. The relatively low frequency of utility ignitions provides limited data with which to provide definitive analysis of the effect of this program. SDG&E will continue to consider alternatives to its current Fuels Treatment (WMP.497) Program, however, SDG&E believes this is a prudent mitigation activity to further reduce the risk of ignitions. Additionally, analysis and feedback are received from the primary vendor who manages the initiative for feedback on process improvement, safety, work scope, planning/scheduling, customer engagement, environmental impact, and customer engagement. For details on the consideration of alternatives to fuels treatment activity, see response to Areas for Continued Improvement SDGE-22-21 in Appendix D.

Enhancements in 2023 will include:

- Fuels Treatment activity
 - Continue to assess cost/benefit and research alternatives such as fire retardants.
 - Engage third party to study the methodology and effectiveness of the fuels treatment activity.
 - Provide customer engagement and awareness earlier in the year to streamline authorization to perform.

8.2.3.1 Pole Clearing (WMP.512)

8.2.3.1.1 Utility Initiative Tracking ID

WMP.512

8.2.3.1.2 Overview of the Initiative

Pole clearing (WMP.512) is a fire prevention measure involving the removal of vegetation at the base of poles that carry specific types of electrical hardware that could cause sparking or molten material to fall to the ground. The clearance requirements in PRC § 4292 require the removal of all vegetation down to bare mineral soil within a 10-foot radius from the outer circumference of subject poles located within the boundary of the State Responsibility Area (SRA). The requirement also includes the removal of live vegetation up to 8 vertical feet and the removal of dead vegetation up to conductor level within the clearance cylinder. Figure 8-31 shows the process flow for pole clearing.

Figure 8-31: Pole Clearing (Brushing) Process Flow

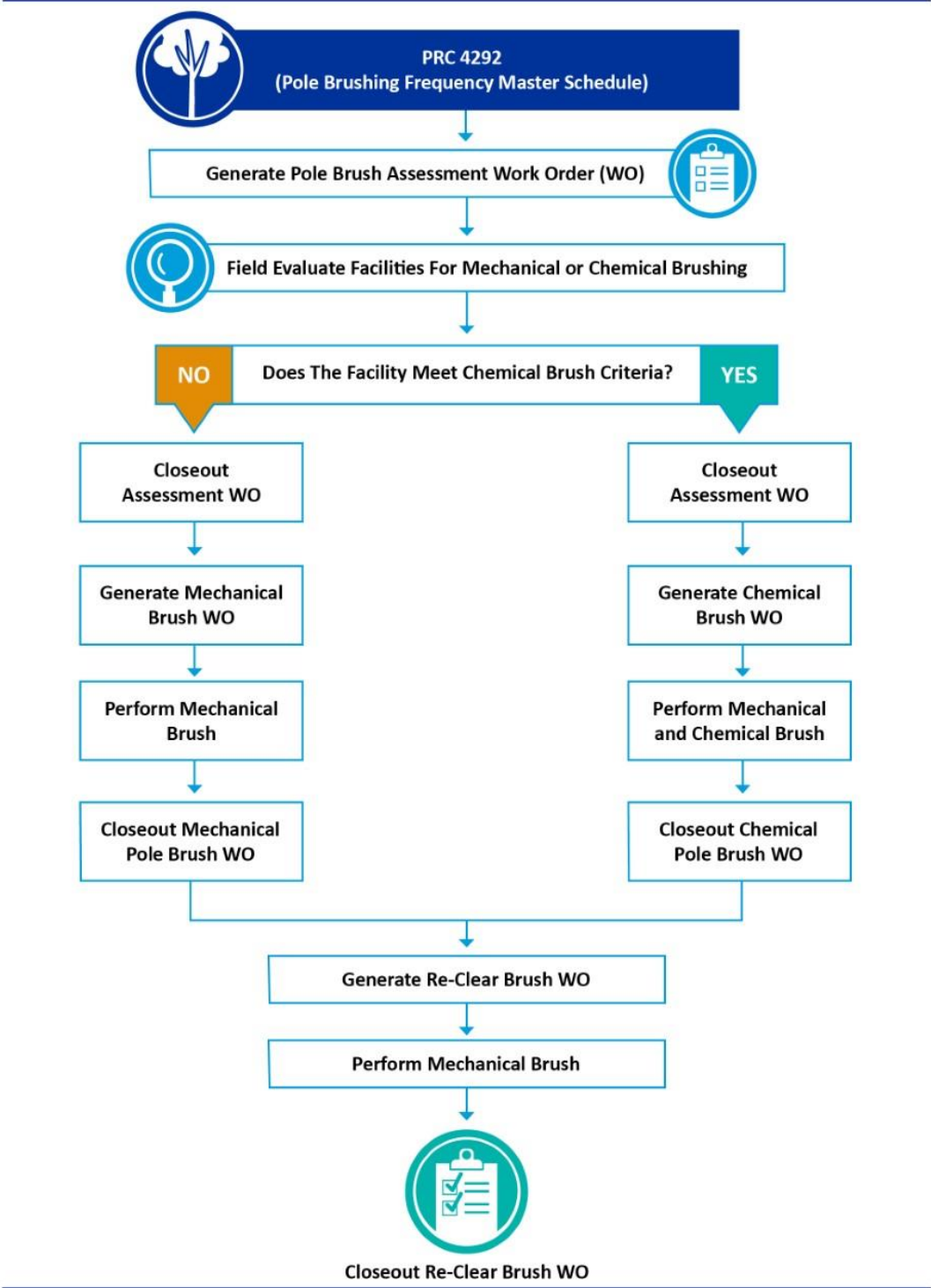

8.2.3.1.3 Governing Standards and Electrical Corporation Standard Operating Procedures

Pole clearing (brushing) (WMP.512) is performed on approximately 34,000 poles located in the SRA of the service territory subject to PRC § 4292. PowerWorkz is utilized to manage and track the inventory of all subject poles that require clearing. Inspectors determine which poles require work and update the records in the database. Three separately scheduled pole brush activities are performed annually, including mechanical brushing, chemical application, and re-clearing. Pole brush inspection occurs in conjunction with tree inspection activity.

Mechanical pole brushing is the clearing all vegetation around the base of a pole down to bare mineral soil for a radius of 10 feet from the outer circumference of the pole; removing all live vegetation within the cylinder up to a height of 8 feet above ground; and removing all dead vegetation up to the height of the conductors. Mechanical brushing is typically performed in the spring months.

On poles where environmentally safe and with customer consent, contractors will apply an Environmental Protection Agency (EPA)-approved herbicide to suppress seed generation, limit vegetation re-growth, and reduce overall maintenance costs. The chemical application is typically done just before the rainy season (fall and winter), so the chemical is activated and effective.

Re-clearing is a second mechanical activity performed on poles that are not cleared by a chemical application. The need to revisit and clear a subject pole multiple times for compliance is not uncommon due to leaf litter cast, vegetation regrowth, or material that has blown into the clearance area which cannot be controlled by mechanical or herbicide treatments.

Pole clearing follows a specific annual, multi-activity schedule to remain compliant year-round. The number of subject poles fluctuates minimally year-to-year so scheduling, spend, and resource allocation remain constant. An environmental review is performed in advance of any new subject pole requiring brushing to assess impacts to protected species and habitat. Like all other vegetation management activities, a third-party QA/QC audit (WMP.505) is performed on a random, representative sample of all completed pole-brush work. See Section 8.2.5 for additional information on QA/QC.

8.2.3.1.4 Updates to the Initiative

The scope of the pole clearing initiative (WMP.512) has changed little since the last WMP submission. Vegetation Management continues to visually inspect every distribution and transmission pole located within the SRA in tandem with the annual, routine schedule pre-inspection activity to identify any new poles subject to PRC § 4292.

In 2022, Vegetation Management began an initiative with the Electric GIS business unit and the Asset Management business unit to proactively identify and communicate new construction activities where new subject hardware is installed on poles. This communication helps streamline the process of identifying new subject poles, reduces the timeframe for mitigation, helps to ensure compliance, and reduces the likelihood of an ignition. Vegetation Management also works closely with the ESH Program (WMP.453, WMP.459, WMP.464, WMP.550) in the use of drones to identify new subject hardware or non-compliant conditions in the HFTD. In the next 2 to 3 years Vegetation Management will work with these business units and initiatives to create automated notifications whenever a new subject pole is created within the SRA.

In addition to the approximately 34,000 poles SDG&E clears every year for compliance and fire prevention, approximately 2,475 poles are cleared in the Local Responsibility Area (LRA). This includes poles located in areas of dense and/or highly flammable vegetation and/or located near steep topography. This work exceeds the regulatory requirement of PRC § 4292. This work is performed as a prudent measure to further reduce the risk of ignition and propagation from one of its poles resulting from molten ejecta.

8.2.3.2 Wood and Slash Management (WMP.497)

8.2.3.2.1 Utility Initiative Tracking ID

WMP.497

8.2.3.2.2 Overview of the Initiative

Wood and slash management (WMP.497) are a component of tree trimming and removal operations. Most of the wood and slash debris resulting from routine trimming and removal activities are chipped on site and removed from the property the same day the work is performed. Large wood debris (generally greater than 6 inches diameter) is cut into manageable lengths and left on site. Where requested, all wood debris and wood chips may be left on a landowner's property for customer utilization. Figure 8-31 shows the process flow for pole brushing (WMP.512), which includes wood and slash management.

Vegetation debris (i.e., slash) generated from fuels management and vegetation management activities are typically removed from the project site unless it is determined that a portion of the debris can be used on site for soil cover or other purposes. This determination is made upon review by Environmental Services. Property owners may also request that debris be left on sight as chipped material for ground cover or landscaping.

8.2.3.2.3 Governing Standards and Electrical Corporation Standard Operating Procedures

All debris associated with tree operations is removed from the channel and banks of watercourses (rivers, streams, lakes, wetlands, etc.) in accordance with environmental regulations such as California Department of Fish and Wildlife section 1600 (Fish and Game Code); California Department of Fish and Wildlife Lake and Streambed Alteration Program; and California Forest Best Practice Rules.

Unlike other areas of California that have experienced mortality in millions of trees because of continued drought and large-scale fires in the last several years, SDG&E has not experienced a high-volume tree mortality rate or a high-volume of wood and slash requiring movement and processing.

8.2.3.2.4 Updates to the Initiative

Wood and slash associated with tree operations is taken to one of several landfills located in San Diego County or to a wood recycling facility. As part of its larger sustainability initiative, SDG&E continues to increase the amount of its wood and slash material that is diverted to a recycling facility. Currently, approximately 55 percent of total wood debris is diverted to a recycling facility to be rendered into composting or other environmentally sustainable materials.

8.2.3.3 Clearance (WMP.501)

Trees are trimmed to clearances that meet or exceed the regulatory minimum clearances required in GO 95. The Enhanced Vegetation Management Program (WMP.501) continues to focus on applying expanded post-trim clearances on targeted species identified as higher risk due to growth potential, failure characteristics, and relative outage frequency. The criteria for determining post-trim clearances includes multiple factors such as species, height, growth rate, health, location of defect, site conditions, pruning schedule, and proper pruning cuts. The compliance goal is to trim to an appropriate clearance to prevent a tree from encroaching within the minimum clearance or contacting the power lines either by wind sway, branch breakout, or tree/root failure. The American National Standards Institute and International Society of Arboriculture standards are applied using the concept of directional pruning. If a tree cannot be mitigated by pruning, complete removal may be required. Emergency pruning may also occur when a tree requires immediate attention to clear an infraction or if it poses an imminent threat to the electric facilities.

Species are designated as “targeted” to facilitate the scope of the inspection activity. The genus or species is not a single determinant of whether an enhanced clearance and/or removal is warranted. Trim clearances are determined following a holistic assessment of tree-specific and site-specific conditions. Simply because a tree has been identified as requiring pruning or that the species is considered “target” does not mean it will require enhanced trim clearance.

8.2.3.3.1 Utility Initiative Tracking ID

WMP.501

8.2.3.3.2 Overview of the Initiative

Vegetation Management defines enhanced clearances as greater than or equal to 12 feet at time of trim, which is the CPUC-recommended post-trim clearance for distribution voltages in the HFTD. Trees are trimmed to clearances that exceed the recommended time-of-trim clearances in GO 95. Certain species such as Eucalyptus, Sycamore, Palm, Oak, and Pine are considered higher risk and targeted for enhanced clearances due to a propensity to be difficult to manage because of their relative fast-growth, historical outage frequency, and/or propensity for branch failure. These tree species are generally associated with the significant majority of all vegetation-caused outages, particularly when measured against their overall percentage of SDG&E’s entire tree inventory.

Clearances of 20 to 25 feet or greater may be achieved where deemed necessary for safety, compliance, and reliability. The tree contractor determines the proper clearance for each tree at the time of trim. If a tree cannot be mitigated by pruning, complete removal may be necessary. Emergency pruning may also occur when a tree requires immediate attention to clear an infraction or if it poses an imminent threat to the electric facilities. SDG&E will continue pursuing expanded trim clearances greater than 12 feet in HFTD for targeted species, exceeding regulatory requirements and plans to establish benchmarking for optimal tree removal activities based on species, growth rate, tree density, risk. Figure 8-32 shows the process flow for enhanced clearance.

Figure 8-32: Enhanced Clearance Process Flow

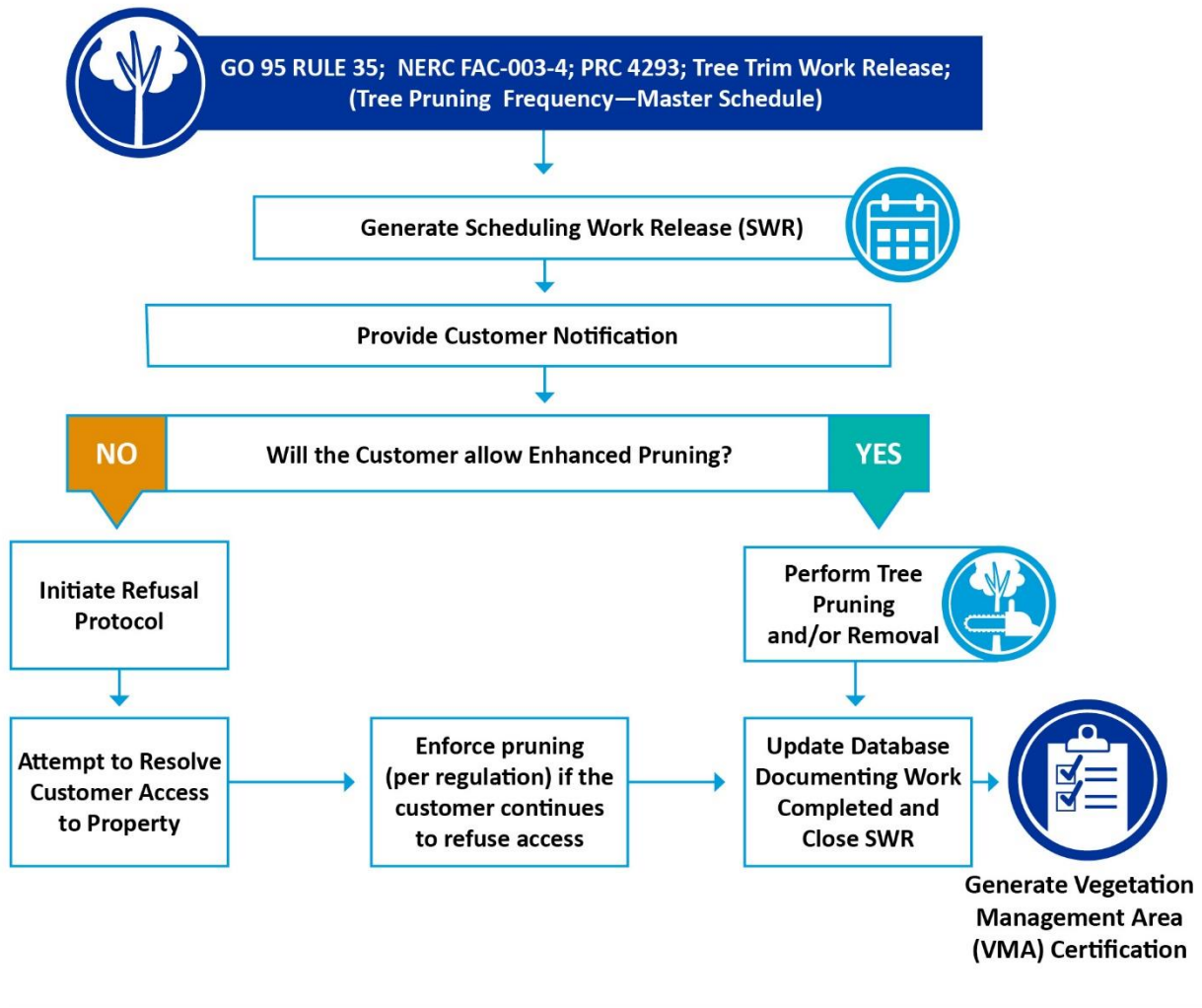

SDG&E has collaborated with Energy Safety and other large California IOUs to continue studying the effectiveness of enhanced clearances. See response to Area of Improvement SDGE-22-20 in Appendix D.

Energy Safety expressed the need and is planning to hold initial and on-going meetings with the joint-IOUs and industry experts to identify vegetation best management practices for wildfire risk reduction. SDG&E will participate in future Energy-led scoping meetings and has recommended and provided contact names of industry experts who may assist in this initiative. For details on best management practices scoping meeting, see response to Areas for Continued Improvement SDGE-22-22 in Appendix D.

8.2.3.3.3 Governing Standards and Electrical Corporation Standard Operating Procedures

The governing standards for clearance include GO 95, Rule 35; PRC § 4293, and NERC FAC-003-4.

8.2.3.3.4 Updates to the Initiative

There is a high degree of variability in forecasting the number of trees that may require enhanced trimming, including but not limited to: species, precipitation, tree growth, location of defect, pruning frequency, and regional tree mortality. The methodology to derive the target for this initiative was modified in 2022 using tree inventory trim frequency data and historical averages. However, since the enhanced trim/removal initiative is relatively new (beginning in 2019), the data is still somewhat limited for forecasting using a trend analysis with a high degree of confidence. Using current trends, it is likely a more accurate forecast number of trees that will require enhanced clearance annually is 10,000 to 11,000. As more data becomes available, the methodology will be reviewed in order to derive an appropriate, annual target for this initiative.

8.2.3.4 Fall-in Mitigation (WMP.494)

8.2.3.4.1 Utility Initiative Tracking ID

WMP.494

8.2.3.4.2 Overview of the Initiative

The Fall-in Mitigation initiative (WMP.494) is integrated within the detailed vegetation and off-cycle patrol inspection (WMP.508) initiatives that target problematic species such as Eucalyptus, Palms, Century plant, Bamboo, certain species of Pine, Oak, and Sycamore, before they become a danger. ISA Certified Arborists trained in hazard tree evaluation perform these inspections, which include a critical look at any tree that could strike the power lines. The utility tree strike zone is defined as the area where a tree is tall enough to hit the power lines if it were to fail at ground level. During the off-cycle patrol, trees are visually inspected from the ground to the upper canopy in a 360-degree circumference. Fall-in mitigation is part of detailed vegetation inspections, see Section 8.2.2.1 Detailed Vegetation Inspections for details.

8.2.3.4.3 Governing Standards and Electrical Corporation Standard Operating Procedures

See Section 8.2.2.1 Detailed Vegetation Inspections.

8.2.3.4.4 Updates to the Initiative

See Section 8.2.2.1.3 Accomplishments, Roadblocks, and Updates and Section 8.2.2.2.3 Accomplishments, Roadblocks, and Updates.

8.2.3.5 Substation Defensible Space

See Section 8.1.3.11 Substation Patrol Inspections (WMP.492) for information on actions taken to reduce the ignition probability and wildfire consequence due to contact with substation equipment.

8.2.3.6 High-Risk Species

Refer to Section 8.2.3.3 Clearance for information on reducing the ignition probability and wildfire consequence attributable to high-risk vegetation species.

Right Tree, Right Place (WMP.1325)

As part of its tree removal program and its “Right Tree, Right Place” initiative, and for safety and reliability, SDG&E continues to offer customers the incentive to remove incompatible trees growing near

power lines and continues to provide replacement trees compatible to plant near power lines. As part of its overall sustainability initiative, SDG&E has a target goal to distribute 10,000 trees annually to customers, communities, and agencies to promote environmental health and mitigate the impacts of climate change.

Community Tree Rebate Program (WMP.1326)

The Community Tree Rebate Program will target underserved communities to promote the planting of trees where climate equity is compromised. The program will offer each applicant a rebate on the purchase of up to 5 trees, ranging from 1 to 15 gallons. This initiative will help promote environmental awareness, teach sustainable tree planting, improve climate, and encourage community involvement. The program will launch in Q1 2023 and will align with San Diego's traditional planting season. An interactive customer portal will help educate customers about the program and guide their application process.

8.2.3.7 Fire-Resilient Right-of-Ways

Actions are taken to promote vegetation communities that are sustainable, fire-resilient, and compatible with the use of the land as an electrical corporation right-of-way.

Land Services Vegetation Abatement (WMP.1327)

Vegetation Abatement activity was implemented to maintain SDG&E-owned parcels in a fire-safe manner as required by various municipal compliance ordinances, Fire Marshal directives, and community safety expectations. This activity is intended to reduce the fuel loading from overgrown vegetation that may propagate a fire if an ignition were to occur and consists primarily of the removal of ground level, non-native flashy fuels and the thinning of tree branches (to 6 to 8 feet) above ground on SDG&E-owned properties and right-of-way corridors. Typically, the same properties are abated annually or on a frequency based on vegetation growth. Depending on conditions such as plant species and rainfall frequency, inspection activities may occur monthly or weekly and may change depending on the season. Brush abatement activities are planned and scheduled in late February/early March each year near the end of the normal rain season and before the flush spring growth occurs. Methods to sustainably address vegetation abatement are continually explored and implemented, including goat grazing along transmission corridors.

Fire Coordination Fuels Reduction MOU & Grant (WMP.1328)

SDG&E sponsors funding for memoranda of understandings (MOUs) and grants to external partners for the purpose of reducing fuels near electrical infrastructure and to enhance community wildfire prevention and safety. The Fuels Reduction MOU & Grant activity targets electric right of ways, evacuation routes, and community defensible space areas to reduce the risk of a fire of consequence and to strengthen community resiliency. Fuel reduction treatments can slow fire spread, assist in firefighting efforts, and reduce the impact of fires on a community. The Fuels Reduction MOU & Grant activity is a partnership with community organizations to help reduce the risk of catastrophic fire in their respective communities associated with electric infrastructure. The fuel reduction treatments follow industry best practice and target utility right of ways in high fire danger areas.

Enhancements in 2023 will include:

- Vegetation Abatement activity
 - Expand the acreage to be abated by goat grazing in sections of the Transmission corridors within Chula Vista, Oceanside, Escondido, and Harmony Grove.
- Fuels Reduction Grant activity
 - Treatment of wildland fuels in proximity to electric facilities will be completed.

8.2.3.8 Emergency Response Vegetation Management (WMP.496)

8.2.3.8.1 Utility Initiative Tracking ID

WMP.496

8.2.3.8.2 Overview of the Initiative

Vegetation Management’s static, annual Master Schedule provides a consistent method for planning and managing activities. The system also enables the flexibility for emergency response to unplanned or unscheduled work before, during, and after events such as PSPS, RFW, adverse weather, or a wildfire.

Vegetation Management actively participates in multi-disciplinary emergency operations preparation activities and training sessions for emergency event response. SDG&E contractors receive daily notifications of current wildfire conditions as a measure of ongoing preparedness including a weather forecast, current FPI rating, and related information. In advance of a forecasted RFW or Santa Ana event, SDG&E will determine if additional vegetation management patrols are needed to assess tree conditions and/or where known imminent issues may exist. Vegetation Management also participated in SDG&E Emergency Operations training for improved situational awareness and resource coordination.

As a forecasted event approaches, tree crew resources are staged and coordinated for standby operations within SDG&E’s Construction & Operation Centers (Districts) and are utilized for storm response and restoration activities. Vegetation Management contractors are kept informed during forecasted elevated or extreme weather events, allowing them time to relocate crews to safe locations or to cease work operations if required. Where emergency tree trimming is required during elevated wildfire conditions, additional firefighting resources may be engaged to provide support.

Vegetation Management inspection and tree trimming activities are integral during post-fire event response. After any fire event of significant size Vegetation Management conducts a hazard tree assessment within the fire perimeter to identify dead, burned, and structurally defective trees that may pose a future threat to the overhead conductors or that may be required to facilitate restoration activities. The scope of such patrols includes a visual inspection of all trees within the strike zone in the fire perimeter. Abatement activities include topping dead/defective trees that could strike the lines or felling a tree if deemed required for worker safety, facility, or environmental protection. Vegetation Management activities are generally halted during active fire suppression in the interest of safety. Fire behavior is unpredictable, and conditions change rapidly that could render initial vegetation management activities ineffective. SDG&E will, where deemed completely safe, engage in some pole brushing during active fire suppression activities if determined that it could serve to protect infrastructure such as poles.

See Detailed Vegetation Inspection process flow-8.2.2.1.

8.2.3.8.3 Governing Standards and Electrical Corporation Standard Operating Procedures

Vegetation Management follows the company wildfire plan in ESP 113.1. Regulatory requirements for minimum clearances between vegetation and electrical infrastructure include GO 95, Rule 35; PRC § 4293; and NERC FAC-003-4.

8.2.3.8.4 Updates to the Initiative

Vegetation Management was activated only a few instances in 2022 for storm or wildfire related events. SDG&E experienced one RFW day and zero PSPS events in 2022. Because of light event activity, there were no significant changes to this initiative. Vegetation Management did respond to the Border 32 Fire Incident which occurred on 8/31/22 in San Diego's backcountry. This fire burned approximately 4,500 acres. A post-fire tree hazard tree inspection activity was performed after this event for facility restoration and future protection.

8.2.4 Vegetation Management Enterprise System (WMP.511)

8.2.4.1 Vegetation Inventory and Condition Database(s)

Vegetation Management utilizes the software system PowerWorkz to inventory vegetation and manage inspections. This work management system uses the CityWorks software platform and is the server side where SWOs and DWOs are created and submitted. The mobile application called Epoch is the mapping interface contractors use for data entry to record completed work. Epoch includes GIS layers, electric infrastructure, land ownership, and parcel information, and houses the electronic records for all tree and pole brushing assets.

8.2.4.2 Internal Documentation of the Database(s)

CityWorks and PowerWorkz data is stored in an Oracle database on an SDG&E server.

Vegetation Management and Pole Brushing (WMP.512) share the same PowerWorkz database, however there are separate tables within PowerWorkz between Vegetation Management (Tree Activity) and Pole Brushing (Pole Activity).

CityWorks is an off-the-shelf application by Trimble (formerly Azteca).

8.2.4.3 Integration with Systems in Other Lines of Business

Vegetation Management inventory, work activity, and asset history is stored within PowerWorkz. Other systems integrated with PowerWorkz include GIS, Epoch Mobile, and CityWorks.

GIS provides a comprehensive inventory of the electric transmission and distribution network assets maintained in an Oracle database. Epoch Mobile is utilized to collect data from the field and uploaded to PowerWorkz. CityWorks is used to schedule work orders for vegetation inspections, audits, and tree work.

8.2.4.4 Integration with the Auditing System(s)

The vegetation inspection data in PowerWorkz is used to create the audit sample, track results, and any related corrective actions. See Section 8.2.5 for more detailed information on the QA/QC program (WMP.505).

8.2.4.5 Internal Processes for Updating the System and Planned Updates

Change requests for CityWorks and PowerWorkz are managed through the standard IT change management methodology using a SIR. Issues are managed through ServiceNow ticketing system. A CAB reviews proposed changes each week. SDG&E plans to integrate additional situational awareness attributes within tree records in the CityWorks database and create new work order capabilities in PowerWorkz for specialized patrols.

System changes are developed in QA (Development Environment) for all updated processes. Once User Acceptance Testing is completed successfully, the updated system is deployed to the production environment.

SDG&E plans to move towards completing design and development of Epoch to enhance data management performance and move all existing tree inventory data to the Cloud.

8.2.4.6 Changes Since the Last WMP Submission

- The addition of new Genus and species attribute fields which enable improved identification granularity within the tree records
- Additional new map layers and updated photo imagery within Epoch for improved situational awareness and field planning
- New SWOs specific to the off-cycle HFTD patrol (WMP.508) activity for better planning, documentation, and reporting
- New mapping capabilities to electronically track and document inspection progression
- New data fields to electronically record customer refusals and other deferred work which negates the need for hard copy forms
- Creation of a refusal/deferred work dashboard to track and manage time-sensitive tree work

8.2.5 Quality Assurance / Quality Control (QA/QC)

8.2.5.1 QA/QC Procedure/Program (WMP.505)

SDG&E uses statistical sampling methodology in its audits of all Vegetation Management-related activities including pre-inspection, clearance (tree trimming), and pole clearing. Audit results are tracked, documented, and reported as a core component of contractor performance.

The QA/QC Program (WMP.505) includes additional scoping during some activities. In conjunction with the routine post-trim audit activity within a VMA, an additional tree inspection of all lines is performed to identify any trees that will not hold compliance until the next routine pre-inspection activity. Figure 8-33 shows the process flow for Auditing Pre-Inspection, Tree Trim, and Pole Clearing.

Figure 8-33: Auditing Pre-Inspection, Tree Trim, and Pole Clearing Process Flow

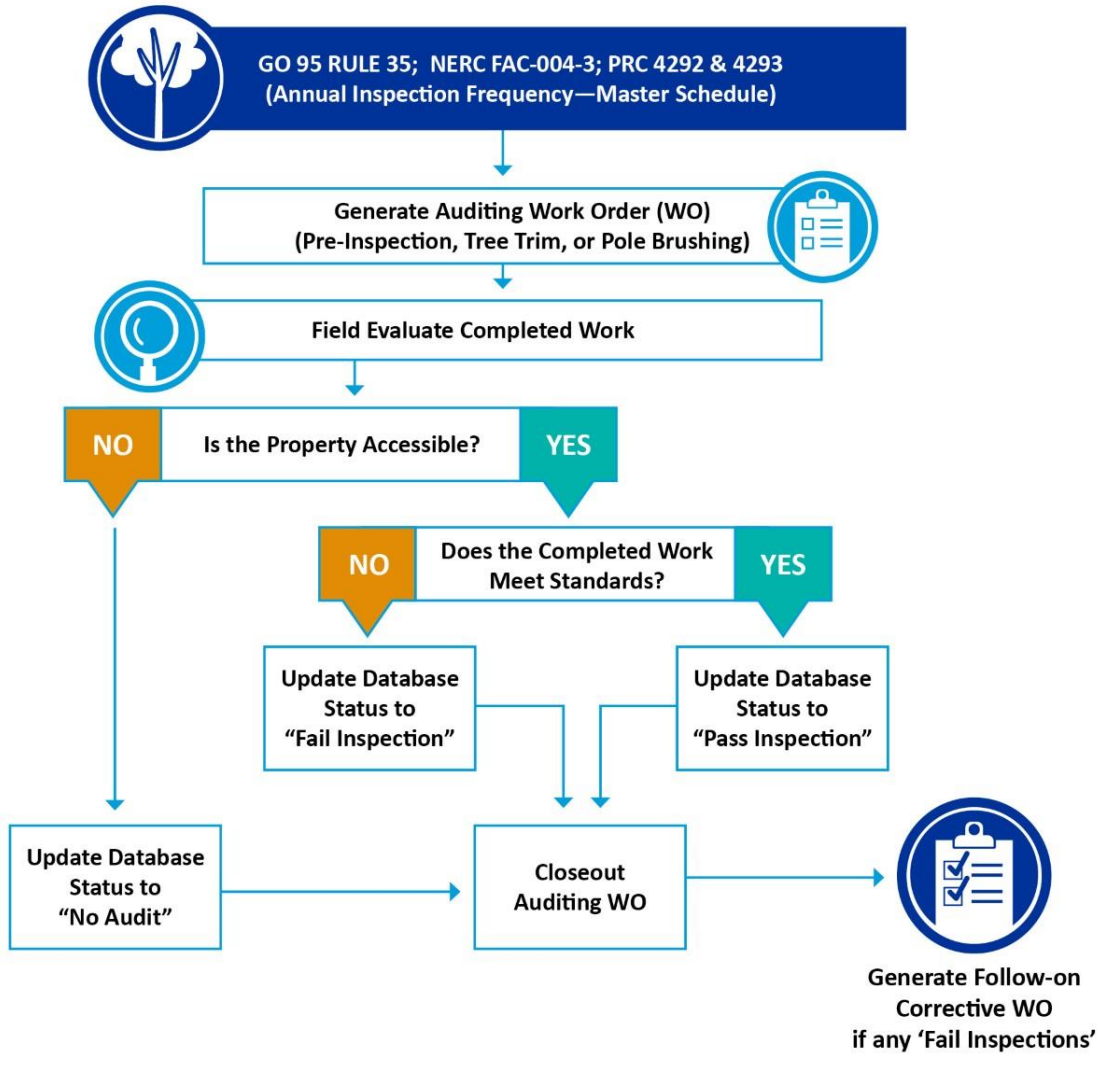

8.2.5.2 Sample Size

SDG&E uses a randomized, representative sample of all completed vegetation management work for the purposes of auditing. A sampling of 12 to 15 percent is used for all activities. Randomization of post-trim audit samples include representation of multiple tree crews. A higher sampling percentage is used for some enhanced vegetation management activities in the HFTD, including a 100 percent post-trim audit of all completed trim and removal work generated from the off-cycle patrol (WMP.508) activities. This target may not be achieved in some instances due to inaccessibility of work locations and/or customer refusals. Additionally, audits are performed on 100 percent of all work completed on tree trim “Memo” work orders.

8.2.5.3 Who Performs QA/QC

SDG&E contracts with a third-party to perform quality assurance audits of its vegetation management activities. Auditing is the sole activity function of this team.

8.2.5.4 Auditor Qualifications

Auditors include individuals who have a degree and/or experience in a field related to vegetation management, natural resources, environmental science, or biology. The auditors are mostly comprised of ISA Certified Arborists or those in the process of becoming certified. Most auditors have prior experience and position as a pre-inspector or tree trimmer and are trained and versed in utility vegetation management regulations, procedures, and field auditing.

8.2.5.5 QA/QC Findings and Incorporation of Lessons Learned

Audit findings are tracked within PowerWorkz. All audit activities are generated and submitted as work orders. Audit findings are documented within the individual electronic asset records and are available for reporting. Findings and observations are shared with contractors who are audited and reviewed for status, trends, and follow-up action. Audit fails for tree trimming and pole brush (WMP.512) activities are issued back to the contractor for corrective action.

OEIS Table 8-18: Vegetation Management QA/QC Program

Inspection Program	Sample Size	Type of Audit	Audit Results 2022	Yearly Target Pass Rate for 2023-2025
Pre-Inspection	12-15%	Field	94%	95%
Tree Trimming	12-15%	Field	99%	95%
Pole Clearing	12-15%	Field	97%	95%

8.2.5.6 Process Changes Since the Last WMP Submission

A 100-percent audit of all completed tree trimming and removal work generated during the off-cycle, HFTD patrol activity was performed where feasible. SDG&E is considering the development of compliance-based audits as a measure of system status and reliability. Such audits may be performed across multiple VMAs and create benchmarking for the performance of vegetation management operations. The anticipated timeline to implement compliance-based audits is 2 to 3 years.

8.2.6 Open Work Orders (WMP.1329)

8.2.6.1 Work Order Procedures

Vegetation Management activities are performed within electronic work orders assigned to contractors to track and document completed field work. Within PowerWorkz, a unique SWO is created annually for each activity (Inspection WMP.494, Tree Trimming WMP.501, Pole Brushing WMP.512, and Auditing WMP.505) in each VMA. Multiple DWOs are created by the contractors under the assigned parent SWO and distributed to the workers in the field. Upon completion of the field activity, asset records within the DWO are electronically coded as complete. Once all the assets within a DWO are complete, the

DWO status is completed. When all DWOs within the parent SWO are completed, the SWO status is completed.

8.2.6.2 Work Order Prioritization

Priority work may be processed using a “Memo” work order. A memo is an asset (tree or pole brush) that is either in a non-compliant condition or that otherwise requires priority action to mitigate the condition. “Memo” work orders are ad-hoc and external to the electronic tracking of a SWO and DWO. “Memo” work orders can be created and assigned to the respective contractor to complete the same day the condition is observed or within 30 days as deemed necessary by the inspector.

8.2.6.3 Work Order Backlogs

PowerWorkz allows tracking and reporting of the status for all open, pending, and completed SWO, DWO, and memo work orders. Additionally, it can track and report the condition code activity status at the asset level for all tree and pole brush records. SDG&E is also in the process of creating dashboards that can report work order status and backlog.

8.2.6.4 Work Order Trends

Vegetation Management tracks work orders as a function of activity completion and schedule. Some types of work orders such as SWOs must be completed in the work management system before the contractor can perform invoicing for that VMA activity. Contractors monitor and complete DWOs and SWOs as a weekly and monthly administrative function. As an ad-hoc creation, memo work orders do not have the system requirement to complete before the contractor can invoice. However, the contractors must code an individual asset record complete before the work can be invoiced.

Figure 8-34 shows the average open work orders (pending tree trim or tree removal) per OH circuit mile in the HFTD. Approximately 6 percent of HFTD trees remain as open work orders at year-end each year. This is driven by the timing of the work with the inspections taking place towards the end of the year and the associated trimming to be completed within the first quarter of the following year. SDG&E has also remained up-to-date with its vegetation work, averaging approximately 0.54 trees per overhead circuit mile (0.4 percent of HFTD trees) with past due orders pending at the end of the calendar year. SDG&E’s forecasts for future open work orders are expected to remain aligned with the most recent 5-year average.

Figure 8-34: Open Work Orders in the HFTD

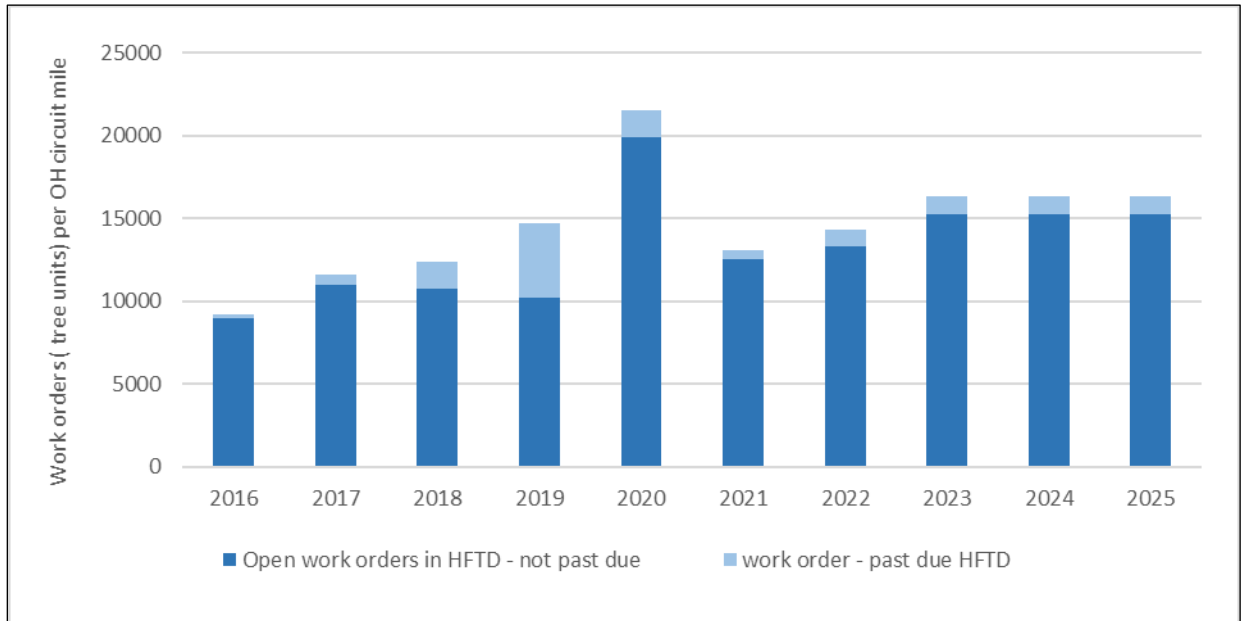

OEIS Table 8-19 shows the total number of tree units within the HFTD that were past due at the end of 2022. Work order scheduling is dependent on the condition code of the tree. Routine work is generally scheduled to be completed within 120 days of inspection, whereas priority work is generally scheduled to be completed within 30 days of inspection.

OEIS Table 8-19: Number of Past Due Vegetation Management Work Orders (Tree Units) Categorized by Age

HFTD Area	0-30 days	31-90 days	91-180 days	181+ days
HFTD Tier 2	79	533	4	2
HFTD Tier 3	357	20	5	1

8.2.7 Workforce Planning (WMP.506)

Much of the Vegetation Management workforce is comprised of contractor personnel and includes over 300 individuals combined for pre-inspection, tree trimming, pole brushing, and audit activities. The internal Vegetation Management workforce includes approximately 20 personnel including Managers, Area Foresters, Contract Administrators, Patrollers, Business Advisor, Data Specialist, and Administrative.

Contractors are responsible for recruiting and training their employees including utility regulations, fire awareness, electrical safety, hardware identification, and activity-specific work processes and procedures. SDG&E provides contractor training for its work management system including hardware and software applications. Contractors are additionally required to perform in-house annual refresher

training that includes the following modules: fire preparedness, environmental protection, hazard tree assessment, and customer service.

Vegetation Management provides initial training for all its internal personnel including the subjects referenced above as well as annual refresher training for environmental, safety, compliance, fire preparedness, and vehicle driver safety. Additionally, SDG&E employees receive online refresher training annually on Affiliate Compliance Rules, Business Conduct and Ethics, North American Electric Reliability Corporation (NERC) Compliance, Customer Information, and Diversity & Inclusion.

SDG&E sponsors and participates in Utility Line Clearance Arborist training sessions in collaboration with the San Diego Community College District, Utility Arborist Association, California Conservation Corps (CCC), and the Urban Corps of San Diego County. The purpose of these training sessions is to train participants to become professional, qualified line-clearance arborists. For more information see response to Areas for Continued Improvement SDGE 22-03 in Appendix D.

SDG&E received the Tree Line USA® recognition for the twentieth consecutive year in 2022. Tree Line USA is awarded by the National Arbor Day Foundation to utilities that demonstrate best practices in utility arboriculture, and how trees and utilities can effectively co-exist for the benefit of communities. The five core standards utilities must meet to be recognized include annual worker training, quality tree care, tree planting and public education, tree-based energy conservation program, and annual Arbor Day events in collaboration with community groups.

OEIS Table 8-20: Vegetation Management Qualifications and Training

Worker title	Minimum Qualifications for Target Role	Special Certification Requirements	Electrical Corporation % FTE Min Quals	Electrical Corporation % Special Certifications	Contractor % FTE Min Quals	Contractor % Special Certifications	Reference to Electrical Corporation Training/Qualification Programs
Vegetation Management Compliance Manager	Bachelor's Degree in Forestry, Biology, or Horticulture and/or equivalent training/experience 7 years' experience in Utility Vegetation Management, including 3 years in contractor management	International Society of Arboriculture (ISA) Certified Arborist ISA Utility Specialist	5%	5%	n/a	n/a	International Society of Arboriculture Certified Arborist Program
Vegetation Management WMP Manager	Bachelor's Degree in Forestry, Biology, or Horticulture and/or equivalent training/experience 7 years' experience in Utility Vegetation Management, including 3 years in contractor management	International Society of Arboriculture (ISA) Certified Arborist ISA Utility Specialist	5%	5%	n/a	n/a	International Society of Arboriculture Certified Arborist Program
Vegetation Management Operational Manager	Bachelor's Degree in Forestry, Biology, or Horticulture and/or equivalent training/experience 7 years' experience in Utility Vegetation Management, including 3 years in contractor management	International Society of Arboriculture (ISA) Certified Arborist ISA Utility Specialist	5%	5%	n/a	n/a	International Society of Arboriculture Certified Arborist Program
Vegetation Management Business Advisor	Bachelor's degree in Finance, Accounting, Data Analytics, Business Administration, or related	No special certification required	5%	n/a	n/a	n/a	n/a
Vegetation Management Senior Data Analyst	Bachelor's degree in Engineering, Economics, Finance, Data Analytic, or related	No special certification required	5%	n/a	n/a	n/a	n/a
Area Forester/Contract Administrator	3 years' Utility Vegetation Management experience Bachelor's degree in Forestry, Biology, Horticulture, or related field (preferred)	International Society of Arboriculture (ISA) Certified Arborist	30%	30%	n/a	n/a	International Society of Arboriculture Certified Arborist Program

Worker title	Minimum Qualifications for Target Role	Special Certification Requirements	Electrical Corporation % FTE Min Quals	Electrical Corporation % Special Certifications	Contractor % FTE Min Quals	Contractor % Special Certifications	Reference to Electrical Corporation Training/Qualification Programs
Vegetation Management Lead Forester	Bachelor's degree in Forestry, Biology, Horticulture, or related field (preferred) 3-5 years' experience administering vegetation management programs Supervisory experience working with external contractors	International Society of Arboriculture (ISA) Certified Arborist	10%	10%	n/a	n/a	International Society of Arboriculture Certified Arborist Program
Forester Patrol Person	3 years' utility vegetation management experience Bachelor's degree in Forestry, Biology, Environmental Science, Horticulture, or related field (preferred)	International Society of Arboriculture (ISA) Certified Arborist	20%	20%	n/a	n/a	International Society of Arboriculture Certified Arborist Program
Resource Coordinator (Customer Help Desk)	High school diploma; college courses (preferred) 3 years' customer service experience Microsoft Office proficiency; Strong technical writing skills (preferred) Working knowledge of Mainframe, GIS, SAP and Distribution Planning Scheduling applications (preferred)	No special certification required	15%	n/a	n/a	n/a	n/a
Auditor	Bachelor's degree in Forestry, Biology, Environmental Science, Horticulture, or related field (preferred) Current Class C Driver's License with clean driver safety record	International Society of Arboriculture (ISA) Certified Arborist	n/a	n/a	4%	54%	International Society of Arboriculture Certified Arborist Program
Pre-Inspector	Bachelor's degree in Forestry, Biology, Environmental Science, Horticulture, or related field (preferred)	International Society of Arboriculture (ISA) Certified Arborist	n/a	n/a	19%	80%	International Society of Arboriculture Certified Arborist Program

Worker title	Minimum Qualifications for Target Role	Special Certification Requirements	Electrical Corporation % FTE Min Quals	Electrical Corporation % Special Certifications	Contractor % FTE Min Quals	Contractor % Special Certifications	Reference to Electrical Corporation Training/Qualification Programs
	Current Class C Driver's License with clean driver safety record						
Tree Trim General Foreperson/ Supervisor	5 years' line clearance tree pruning experience as a Foreman Current California Driver License Class B endorsement General computer knowledge Strong leadership qualities	International Society of Arboriculture (ISA) Certified Arborist	n/a	n/a	5%	62%	International Society of Arboriculture Certified Arborist Program
Tree Trimmer	Current California Driver License (Class B endorsement) General computer skills Strong work ethic	Line-clearance qualified arborist certification (or trainee)	n/a	n/a	63%	87%	United States Department of Labor Standard OSHA 1910.269; ANSI Z133 Safety Standards
Pole Brush General Foreman / Supervisor	5 years' line clearance tree pruning experience as a Foreman Current California Driver License Class B endorsement General computer knowledge Strong leadership qualities	Qualified Applicator Certification	n/a	n/a	1%	40%	California Department of Pesticide Regulation Licensing Program
Pole Brusher	Current California Driver License (Class B endorsement) General computer skills Strong work ethic	No special certification required	n/a	n/a	8%	n/a	n/a
Total			100%		100%		

8.3 Situational Awareness and Forecasting

8.3.1 Overview

The FSCA business unit was established in 2018, and is comprised of meteorologists, community resiliency experts, fire coordinators, and project management personnel. Its purpose is responding to and strategizing for wildfire preparedness activities and climate resilience-related programs. The creation of a WCRC in 2023 will bring together leading thinkers and problem solvers in academia, government, and the community to create forward-looking solutions to help prevent ignitions, mitigate the impacts of fires, and ultimately help build a more resilient region.

The Weather Station Network increases situational awareness and obtains foundational data for operational and mission critical activities. In addition, the Air Quality Management Program (WMP.970) utilizes sensors throughout the service territory to monitor hazardous levels of particulate matter, often found in wildfire smoke. To ensure ignitions do not go unnoticed, satellite-based ignition detections are coupled with a mountain top camera network.

SDG&E partnered with the Space Science and Engineering Center (SSEC) at the University of Wisconsin-Madison to increase situational awareness of wildfire ignitions in the service territory. Geostationary Operational Environmental Satellites (GOES)-16/-17 along with the Advanced Baseline Imager (ABI), are utilized to operationalize fire detection and characterization.

Situational awareness tools such as weather stations (WMP.447), cameras (WMP.1343), the FPI (WMP.450), and the SAWTI (WMP.540) are utilized to forecast weather across the service territory. The Weather Station Network provides information on the location and severity of weather events that may impact the system. High-performance computing clusters generate high-quality weather data that is incorporated directly into operations.

The FPI model was developed to calculate the wildfire potential on any given day, assisting in safe and reliable operations. It establishes daily operating conditions (i.e., Normal, Elevated, Extreme), which inform operational decisions such as recloser settings, restrictions on the type of work being performed in high-risk locations, and the use of CFRs. It is also used as an input for PSPS decision making.

8.3.1.1 Objectives

OEIS Table 8-21: Situational Awareness Initiative Objectives (3-year plan)

Objective Number	Objectives for Three Years (2023–2025)	Applicable Initiative(s), Tracking ID(s)	Applicable Regulations, Codes, Standards, and Best Practices (See Note)	Method of Verification (i.e., program)	Completion Date	Reference (section & page #)
8.3.01	Continue to improve the quality of AQI data and notifications	Air Quality Management Program; WMP.970	<ul style="list-style-type: none"> Title 8 CCR 5141.1 SDG&E G8373 	n/a	12/31/2025	8.3.2.3, p. 308
8.3.02	Continue to benchmark with other IOUs on monitoring solutions	Air Quality Management Program; WMP.970	n/a	n/a	12/31/2099 (Ongoing)	8.3.2.3, p. 308
8.3.03	Explore sensor technologies for portable monitoring in field/trucks	Air Quality Management Program; WMP.970	n/a	n/a	12/31/2025	8.3.2.3, p. 308
8.3.04	Track and adapt to regulatory changes	Air Quality Management Program; WMP.970	<ul style="list-style-type: none"> Title 8 CCR 5141.1 SDG&E G8373 	Internal standards will be updated to reflect regulatory changes	12/31/2099 (Ongoing)	8.3.2.3, p. 308
8.3.05	Incorporate and publish AQI data via existing FSCA app	Air Quality Management Program; WMP.970	<ul style="list-style-type: none"> Title 8 CCR 5141.1 SDG&E G8373 	Data can be viewed on the FSCA app and compared to dashboard data	12/31/2024	8.3.2.3, p. 308
8.3.06	Explore smoke plume modeling technology	Air Quality Management Program; WMP.970	n/a	n/a	12/31/2099 (Ongoing)	8.3.2.3, p. 308
8.3.07	Develop full automation in fire detection capabilities	Satellite Based Remote Sensing (WMP.971)	n/a	n/a	12/31/2025	8.3.4.1.1, p. 319
8.3.08	Archive ignition detection information from ground sources and perform analysis to help improve algorithms.	Satellite Based Remote Sensing (WMP.971)	n/a	n/a	12/31/2025	8.3.4.1.1, p. 319
8.3.09	Archive camera verification of satellite heat detections	Satellite Based Remote Sensing (WMP.971)	n/a	Actual fires on the landscape that were detected versus fires that were not detected.	12/31/2025	8.3.4.1.1, p. 319

Objective Number	Objectives for Three Years (2023–2025)	Applicable Initiative(s), Tracking ID(s)	Applicable Regulations, Codes, Standards, and Best Practices (See Note)	Method of Verification (i.e., program)	Completion Date	Reference (section & page #)
				Vendor Alchera is archiving AI Smoke detections.		
8.3.10	Continuously provide feedback on validation to vendor concerning hot spot detection.	Satellite Based Remote Sensing (WMP.971)	n/a	Verification is performed immediately at the time of satellite heat detection by automatically triangulating all cameras within line of sight of the ignition	12/31/2025	8.3.4.1.1, p. 319
8.3.11	Filter out areas of known recurring false positives such as industrial solar farms	Satellite Based Remote Sensing (WMP.971)	n/a	Reduction in false positives	12/31/2025	8.3.4.1.1, p. 319
8.3.12	2023: Harden backbone communication network for mountaintop cameras via replacement of legacy equipment and work to explore AI technology for image processing.	Cameras (WMP.1343)	n/a	HPWREN User Group Member Planning	12/31/2023	8.3.4.1.2, p. 320
8.3.13	2024: Continue hardening backbone network and expand to new sites when/where broader fire community benefit can be realized. Automate smoke detection notifications leveraging AI software, if determined to add value.	Cameras (WMP.1343)	n/a	HPWREN User Group Member Planning	12/31/2024	8.3.4.1.2, p. 320
8.3.14	2025: Continue to harden infrastructure to support communications via mountaintop camera network	Cameras (WMP.1343)	n/a	HPWREN User Group Member Planning	12/31/2025	8.3.4.1.2, p. 320
8.3.15	Continue to replace and/or update existing weather stations to improve weather data and ultimately provide more accurate forecasting.	Weather Stations and Normalized Difference Vegetation Index (NDVI) Cameras (WMP.447)	n/a	n/a	12/31/2025	8.3.2.1.1, p. 305

Objective Number	Objectives for Three Years (2023–2025)	Applicable Initiative(s), Tracking ID(s)	Applicable Regulations, Codes, Standards, and Best Practices (See Note)	Method of Verification (i.e., program)	Completion Date	Reference (section & page #)
8.3.16	Perform upgrades to the weather station network including scaling fuels monitoring with the addition of DFM sensors, NDVI cameras communication equipment (modems), and batteries throughout the service territory	Weather Stations and Normalized Difference Vegetation Index (NDVI) Cameras (WMP.447)	n/a	n/a	12/31/2025	8.3.2.3, p. 308
8.3.17	Retrieve updated observation data to generate 95 th , 99 th , and max wind weather station statistics and update the historical observation statistics for all weather stations.	Weather Stations and Normalized Difference Vegetation Index (NDVI) Cameras (WMP.447)	n/a	Verified annually	12/31/2099 (Ongoing)	8.3.2.3, p. 308
8.3.18	Utilize high-performance computing clusters to generate higher resolution operational products.	Weather Forecasting (WMP.541)	n/a	n/a	12/31/2025	8.3.5.1, p. 326
8.3.19	Implement the new operational 1.5 km WRF configuration upgraded from the current 2 km resolution and update all downstream indices from the higher resolution WRF output	Weather Forecasting SAWTI, WMP.540 FPI, WMP.450	n/a	n/a	12/31/2025	8.3.5.3, p. 328
8.3.20	Build a new Machine Learning (ML) wind speed and gust model that will be trained with the new consistent operational and historical 30-year dataset. Use the ultra-high-resolution terrain to place corrections on the WRF domain.	Weather Forecasting (WMP.452)	n/a	Forecasted PSPS impacts are verified against observed PSPS impacts	12/31/2025	8.3.5.3, p. 328
8.3.21	Upgrade Weather Visualization Portal Plots to enable 4.5 km and 1.5 km resolution for standard pressure levels and numerous meteorological and fuels variables of operational interest	Weather Forecasting (WMP.452)	n/a	n/a	12/31/2025	8.3.5, p. 326

Objective Number	Objectives for Three Years (2023–2025)	Applicable Initiative(s), Tracking ID(s)	Applicable Regulations, Codes, Standards, and Best Practices (See Note)	Method of Verification (i.e., program)	Completion Date	Reference (section & page #)
8.3.22	Continue to work with academia and fire agencies to further develop fire science for integration into SAWTI. Re-code software that processes weather and fuels data when the resolution of the modeling used to generate the SAWTI is increased.	Weather Forecasting SAWTI, WMP.540	n/a	Improved SAWTI representation of actual observations	12/31/2025	8.3.5.3, p. 328 8.3.5.5.4, p. 334
8.3.23	Improve LFM ML model which is an input in both FPI and SAWTI models	Weather Forecasting SAWTI, WMP.540 FPI, WMP.450	n/a	Improved characterization of fire potential	12/31/2025	8.3.5.3, p. 328
8.3.24	Continue partnerships with academia to work to advance fire science and weather science.	Fire Potential Index, WMP.450	n/a	n/a	12/31/2025	8.3.6.3, p. 340
8.3.25	Improve the inputs and outputs of the FPI, which may impact operational decision making.	Fire Potential Index, WMP.450	n/a	n/a	12/31/2025	8.3.6.3, p. 340
8.3.26	Continue to install DFM sensors on existing weather stations where fuel moisture data is sparse.	Fire Potential Index, WMP.450	n/a	Improved characterization of fire potential	12/31/2025	8.3.6.3, p. 340
8.3.27	Implement the new operational 1.5 km WRF configuration upgraded from the current 2 km resolution and update all downstream indices (FPI, SAWTI) with the higher resolution WRF output.	Fire Potential Index, WMP.450	n/a	Improved characterization of fire potential	12/31/2025	8.3.6.3, p. 340
8.3.28	Re-create the 30-year downscaled NOAA's Climate Forecasting System Reanalysis (CFSR) data using higher resolution 1.5 km WRF and integrate into FPI and SAWTI.	Weather Forecasting SAWTI, WMP.540 FPI, WMP.450	n/a	Improved characterization of fire potential	12/31/2025	8.3.5.3, p. 328

Objective Number	Objectives for Three Years (2023–2025)	Applicable Initiative(s), Tracking ID(s)	Applicable Regulations, Codes, Standards, and Best Practices (See Note)	Method of Verification (i.e., program)	Completion Date	Reference (section & page #)
8.3.29	Update the Normalized Difference Vegetation Index (NDVI) Machine Learning (ML) models by identifying grassland sites across the domain and gathering up-to-date MODIS NDVI observations for grassland sites.	Fire Potential Index, WMP.450	n/a	Improved characterization of fire potential	12/31/2025	8.3.6.3, p. 340
8.3.30	Continue improving existing models (FPI, SAWTI) by noting and evaluating discrepancies between predictions and observed reality.	Weather Forecasting SAWTI, WMP.540 FPI, WMP.450	n/a	n/a	12/31/2099 (Ongoing)	8.3.5.3, p. 328
8.3.31	Partner with academia to explore and evaluate large computational resource to include a module for impact of large eddy scale weather	Weather Forecasting, WMP.452	n/a	n/a	12/31/2099 (Ongoing)	8.3.5.1, p. 326

OEIS Table 8-22: Situational Awareness Initiative Objectives (10-year plan)

Objective Number	Objectives for Ten Years (2026–2032)	Applicable Initiative(s), Tracking ID(s)	Applicable Regulations, Codes, Standards, and Best Practices (See Note)	Method of Verification (i.e., program)	Completion Date	Reference (section & page #)
8.3.32	Consider upgrading equipment due to advancing technology	Air Quality Management Program, WMP.970	n/a	Verification TBD	12/31/2099 (Ongoing)	8.3.2.3, p. 308
8.3.33	Consider data integration with displays/overlays	Air Quality Management Program, WMP.970	n/a	Verification TBD	12/31/2027	8.3.2.3, p. 308
8.3.34	Explore partnering with local air pollution/ quality districts to make data publicly available	Air Quality Management Program, WMP.970	Title 8 CCR 5141.1; SDG&E G8373	Verification TBD	12/31/2027	8.3.2.3, p. 308
8.3.35	Explore and evaluate operationalization of smoke plume modeling technology	Air Quality Management Program, WMP.970	n/a	Verification TBD	12/31/2032	8.3.2.3, p. 308

Objective Number	Objectives for Ten Years (2026–2032)	Applicable Initiative(s), Tracking ID(s)	Applicable Regulations, Codes, Standards, and Best Practices (See Note)	Method of Verification (i.e., program)	Completion Date	Reference (section & page #)
8.3.36	Analyze 3 years of satellite ignition data, AI smoke detection, and ground source ignition verification feedback to vendor on algorithm performance	Satellite Based Remote Sensing, WMP.971	n/a	Verification TBD	12/31/2032	8.3.4.1.1, p. 319
8.3.37	Partner and collaborate to enhance Fire Detection and Characterization (FDC) within the Wildfire Automated Biomass Burning Algorithm (WFABBA) by providing validation of the six fire categories based on confidence in the Fire Radiative Power (FRP), size, and temperature estimates.	Satellite Based Remote Sensing, WMP.971	n/a	Verification TBD	12/31/2032	8.3.4.1.1, p. 319
8.3.38	Seek to integrate AI Smoke Detection from mountain top cameras into a common operating picture	Cameras, WMP.1343	n/a	Verification TBD	12/31/2032	8.3.4.1.2, p. 320
8.3.39	Enhance Data intensive initiatives through additional information integration, automation, and strategic partnerships	Weather Forecasting, WMP.452	n/a	Verification TBD	12/31/2099 (Ongoing)	8.3.5.3, p. 328
8.3.40	Continue the production and sharing of forecast products as well as the prioritization of data analytics and modeling. Working with the SDSC, data science advancements will be monitored to ensure that this technology can provide the advanced analytics required to maximize operations.	Weather Forecasting, WMP.452	n/a	Verification TBD	12/31/2099 (Ongoing)	8.3.3.5, p. 316
8.3.41	Continue to collaborate with SAWTI stakeholders.	Weather Forecasting SAWTI, WMP.540	n/a	Verification TBD	12/31/2099 (Ongoing)	8.3.5.3, p. 328
8.3.42	Continue to enhance predictors that contribute to the FPI, including LFM and green-up, to modernize data inputs and better leverage the high-performance computing environment to generate the product.	Fire Potential Index, WMP.450	n/a	Verification TBD	12/31/2099 (Ongoing)	8.3.6, p. 335

8.3.1.2 Targets

OEIS Table 8-23: Situational Awareness Initiative Targets by Year

Initiative Activity	Tracking ID	2023 Target & Unit	% Risk Impact 2023	2024 Target & Unit	% Risk Impact 2024	2025 Target & Unit	% Risk Impact 2025	Method of Verification
AQI Sensor – Installation	WMP.970	6 sensors	n/a	6 sensors	n/a	0 sensors	n/a	Completed work orders, AQI Dashboard populated
Air Quality Station Maintenance	WMP.1431	n/a	n/a	n/a	n/a	192 inspections	n/a	Completed work orders, AQI Dashboard populated
Weather Station Maintenance & Calibration	WMP.1430	n/a	n/a	n/a	n/a	216 inspections*	n/a	Completed work orders, Dashboard populated

*The weather station network consists of 222 weather stations throughout the service territory. Six of these stations are owned by SDG&E but are maintained by Forest Technology Systems (FTS). SDG&E is responsible for maintenance and calibration of the other 216 weather stations.

8.3.1.3 Performance Metrics

OEIS Table 8-24: Situational Awareness and Forecasting Performance Metrics Results by Year

Performance Metrics	2020	2021	2022	2023 Projected	2024 Projected	2025 Projected	Method of Verification
Communication Success Rate of Weather Stations	n/a	n/a	97.66%	97.51%	97.51%	97.51%	Third-party vendor
Post Processing Success Rate - WRF Simulations	n/a	n/a	96.50%	97.45%	97.45%	97.45%	Third-party vendor
Post Processing Success Rate - ML Gust Model	n/a	n/a	95.10%	96.15%	96.15%	96.15%	Internal validation/testing
Post Processing Success Rate - SAWTI	n/a	n/a	71.90%	93.00%	93.00%	93.00%	Internal validation/testing
Post Processing Success Rate - FPI	n/a	n/a	94.10%	95.05%	95.05%	95.05%	Internal validation/testing
Post Processing Success Rate - OPI	n/a	n/a	94.80%	94.30%	94.30%	94.30%	Internal validation/testing

8.3.2 Environmental Monitoring Systems

8.3.2.1 Existing Systems, Technologies, and Processes

OEIS Table 8-25: Environmental Monitoring Systems

System	Measurement/ Observation	Frequency	Purpose and Integration
Weather Station (WMP.447)	Wind speed, wind direction, wind gusts, temperature, and humidity	Every 10 minutes	Increases situational awareness and obtains foundational data for operational and mission critical activities
Fuel Moisture & NDVI Cameras (WMP.1334 and WMP.447)	Fuel Moisture values	Daily values of 10-hour fuels and grass health respectively	In-situ fuel moisture sensors accurately reflect the state of the fuels critical to fire potential understanding
Air Quality Management Program - PM _{2.5} sensors (WMP.970)	Concentration of particulate matter 2.5 microns or smaller in diameter	6 measurements/hour	Convert concentrations to an index (AQI) and quickly notify employees when air quality is unhealthy.

8.3.2.1.1 Weather Stations and Normalized Difference Vegetation Index (NDVI) Cameras (WMP.447)

The Weather Station Network, comprised of 222 weather stations, increases situational awareness and obtains foundational data for operational and mission critical activities. Existing weather stations continue to be replaced and/or updated to improve weather data and ultimately provide more accurate forecasting. When developing the Weather Station Network, the alternative of using pre-existing weather stations was considered, however, the existing data generated did not have the resolution needed to support emergency operations during PSPS events. Weather stations in the network record wind speed, wind direction, wind gusts, temperature and humidity every 10 minutes and transmit the data to our publicly available website.

SDG&E owns and operates a dense network of 222 weather stations in a 4,000-square-mile service territory. Each station reports wind speed/gust/direction, temperature, and humidity every 10 minutes via cellular and spread spectrum communications, totaling over 30,000 observations per day. In addition, 95 percent of the weather stations can report every 30 seconds if needed during dangerous fire weather conditions. This additional data demonstrated that in many cases high wind gusts were brief and isolated in nature such that de-energizations were not necessary, decreasing the total customers impacted by PSPS events during weather events. The collection of 30,000 daily observations over the last 10 years has enabled statistical analysis for targeted electrical shut offs, as necessary. Historical observations are also used to update the relevant wind impact guidance, such as two standard deviations from the mean (95th percentile) and three standard deviations from the mean (99th Percentile), on an annual basis.

In 2022, SDG&E expanded upon the lessons learned in 2021 and integrated its AI forecasting system across 216 weather stations, providing the latest available forecasting technology to help serve communities in the highest risk fire areas. The ability to implement this technology stems from recording weather observations every 10 minutes for over 10 years, collecting one billion observations

that are available to be used in training AI. Additionally, as more data is collected each year, more can be integrated back into the forecasting system to improve the model. These new predictive technology models help increase the accuracy of weather forecasts, which are shared with the public and fire agencies.

The Weather Station Network and NDVI Cameras (WMP.447) is being discontinued and is evolving into a new program: Weather Station Maintenance and Calibration (WMP.1430).

Weather Station Network and NDVI Cameras (WMP.447)

In 2025, the new program will target maintenance and calibration of the 216 weather stations.

Calibration and maintenance of weather stations is crucial for obtaining accurate, reliable, and high-quality data. Weather station instruments are calibrated annually in alignment with National Weather Service (NWS) procedures and internal procedures. Maintenance also includes routine replacement of aging sensors.

8.3.2.1.2 Fuel Moisture (WMP.1334)

Meteorology manages a robust network of dead fuel sensors in the HFTD. Five 10-hour-dead-fuel moisture sensors have been installed along with nine Normalized Difference Vegetation Index (NDVI) cameras in strategic locations providing daily values of 10-hour fuels and grass health, respectively. Additionally, Meteorology receives weekly NDVI values from low earth orbiting satellites that scan 20 areas of interest within the service territory that are representative of grasslands. Finally, LFM values are received from the U.S. Forest service for two areas in the service territory on a monthly basis and then every 2 weeks when fuel moisture values become critical. The fuels sampling program provides critical inputs to the FPI (WMP.450) which informs company operations of the fire potential for the coming week. The FPI indicates whether the environment supports fire growth which in turn enables an operational response proportional to the threat.

8.3.2.1.3 Air Quality Management Program (WMP.970)

Particulates contained in wildfire smoke are hazardous to employees and the public. In addition, the Division of Occupational Safety and Health Protection from Wildfire Smoke Program (Title 8 CCR Section 5141.1) requires employers to notify employees and implement control measures when the Air Quality Index (AQI) for Particulate Matter 2.5 microns or smaller in diameter (PM_{2.5}) exceeds 150 or exceeds 500 during wildfires.

In 2022, the Air Quality Management Program (WMP.970) installed particulate sensors at nine locations and a partially automatic notification system. Through this system, the AQI for PM_{2.5} is measured and reported for each location. The AQI is a tool developed by the EPA used to communicate air quality. While the EPA monitors and reports on multiple air pollutants, the Air Quality Management Program focuses on PM_{2.5} which is fine particulate matter measured at 2.5 microns or less. Causes of high levels of PM_{2.5} include vehicle exhaust, sources such as power plants, and the burning of fuels such as wood, coal, or heating oil. The concentration of PM_{2.5} can increase significantly during a wildfire. Particulate sensors measure the levels of PM_{2.5} and when thresholds are exceeded, Safety is automatically notified. Once the particulate source has been confirmed to be a wildfire, notifications with AQI information are sent to supervisors via text and email.

The Air Quality Management Program installed 15 particulate sensors between 2022 and 2023. The last remaining particulate sensor was installed by the end of 2023. Eighteen total sensors have been procured, one of which is used as a master unit for calibration and as an additional spare. Once installed, the 16 sensors will completely cover the HFTD and further installations would not provide additional benefit. Therefore, this program was discontinued at the end of 2023.

Air Quality Station Maintenance (WMP.1431)

A new initiative, Air Quality Station Maintenance (WMP.1431) has been created to maintain and upgrade sensors as necessary. In 2025, the new program will target maintenance and calibration of the particulate sensors. Maintenance of the particulate sensors will include a scheduled monthly, quarterly, and annual inspection. Each visit will include a rigorous preventative maintenance to ensure accurate functioning of the sensors.

8.3.2.2 Evaluation and Selection of New Systems

Safety staff attend conferences where exhibitors demonstrate emerging technologies to assist with hazard recognition and controls. Meteorology staff collaborate with academia and also have relationships with leading innovative companies to benchmark state-of-the-art technologies.

Industry leaders are successful with value propositions and innovation because of their ability to use highly trained customer success teams to assist in understanding the requirements and their ability to present solutions rapidly. For example, Meteorology has known that the Moderate Resolution Imaging Spectroradiometer (MODIS) satellites were past end of life and these space-based assets were critical to understanding the grass health within the fire potential problem. Planet, a company that provides daily satellite data, was able to quickly ascertain the problem and present a solution that organized and delivered higher-resolution data, covering more areas.

Additionally, the SSEC at the University of Wisconsin-Madison is a world-class archive of satellite data, receiving, archiving, and redistributing most geostationary weather satellite data produced globally. SSEC and SDG&E partnered to increase situational awareness of wildfire ignitions in the service territory. SSEC was able to prove the value of space-based ignition alerts by providing historical fire detection and characterization at 2 km spatial resolution with wildfire alerts of less than 5 minutes.

Finally, and most recently, the Center for Western Weather and Water Extremes (CW3E) of UC San Diego performs a daily 200-member ensemble forecast simulation of 9-km horizontal grid spacing using the latest version of the WRF model (WMP.532). This partnership with CW3E presented the opportunity to investigate potential improvements to medium- and extended-range fire weather forecasting by accounting for model uncertainty via a large ensemble. Working in close coordination with Meteorology, the joint venture concept became an operational product in less than 6 months, vastly improving the ability to probabilistically forecast key meteorological variables associated with downsloping Santa Ana winds that could lead to dangerous wildfire conditions. Given its large number of members, this WRF ensemble can better quantify the distribution of physically plausible weather forecast outcomes, capturing the probability of extreme events.

8.3.2.3 Planned Improvements

8.3.2.3.1 Weather Station Network and NDVI Cameras (WMP.447)

New weather stations were installed in 2022, achieving saturation of known wind prone areas and gaps in HFTD coverage. Additionally, high resolution fuels sampling sensors were installed to better characterize the fire potential in the backcountry. These additional sensors included NDVI cameras and 10-hour-dead-fuel moisture sensors in strategic locations. The WMP target for 2022 was nearly achieved and is pending work crew installations. Nine of ten NDVI cameras and five of ten DFM sensors were installed in 2022.

For 2023, there are several upgrades planned for the Weather Station Network:

- 20 Lithium batteries with 65-watt solar panel upgrades
- 30 CH200 charging regulators
- 3 AQI stations
- 1 NDVI camera
- 1 FT7 Acoustic Wind and Temperature Sensor
- 1 Wind Monitor Alpine & Marine versions
- Enhanced Web Development of weather sensor dashboards

The Weather Station Network has been built out to a mature state and though SDG&E may augment weather stations with additional sensors to further evolve scientific understanding, significant expansion of the Weather Station Network during the 2023 to 2025 WMP cycle is not anticipated.

8.3.2.3.2 Fuel Moisture (WMP.1334)

For 2023, there are several upgrades planned for Fuel Moisture to include:

- 5 DFM Sensors
- Meteorology is exploring the concept of soil moisture and/or LFM sensors to augment the current fuel moisture program with the U.S. Forest Service. These sensors will have the ability to measure temperature, relative humidity, Wind Speed, Rain, Solar Radiation, and Soil Moisture.

There are no plans for the establishment of new environmental monitoring systems for the 2023 to 2025 WMP cycle.

8.3.2.3.3 Air Quality Management Program (WMP.970)

Enhancements and progress made in 2022 include:

- Procured 12 additional sensors
- Established calibration factors (K-factors) for 18 sensors
- Provided training and procured contract for sensor calibration and maintenance
- Installed nine particulate sensors at nine company locations (Northeast C&O, Metro C&O, Kearny, Ramona, Orange County C&O, Eastern C&O, Moreno Compressor Station, Northcoast C&O, and Miramar)
- Developed and implemented a notification system

Future enhancements for the 2023-2025 WMP cycle to initiative include:

- Install remaining particulate sensors
- Improve notification system process to increase alert speed once the particulate source has been confirmed to be a wildfire
- Expand notifications to all employees
- Include AQI values for townships in San Diego and Orange Counties on the FSCA application

Future improvements to initiative beyond the current WMP 2023-2025 cycle include:

- Explore the expansion of the Air Quality Management Program (WMP.970) in collaboration with local air districts to improve public safety
- Develop an EOC overlay interface to assist with employee/public safety and wildfire restoration staging area selection
- Consider upgrading equipment due to advancing technology
- Consider data integration with displays/overlays
- Explore partnering with local air pollution/quality districts to make data publicly available
- Explore and operationalize smoke plume modeling technology

There are no plans for the establishment of new environmental monitoring systems for the 2023 to 2025 WMP cycle.

OEIS Table 8-26: Planned Improvements to Environmental Monitoring Systems

System	Description	Impact	x% Risk Impact	Implementation Schedule
Air Quality Management Program (WMP.970)	Install remaining particulate sensors	increase situational awareness during wildfire events to minimize hazardous particulate exposure to employees	n/a*	Q1 2023
Air Quality Management Program (WMP.970)	Improve notification system process	Increase alert speed once the particulate source has been confirmed.	n/a*	Q1 2023
Air Quality Management Program (WMP.970)	Expand notifications to all employees	Increase protection employees from PM _{2.5} exposure by quickly notifying employees when PM _{2.5} AQI thresholds are exceeded	n/a*	Q4 2023
Air Quality Management Program (WMP.970)	Include AQI values for townships in San Diego and Orange Counties on the FSCA app and explore partnerships with the townships in San Diego including local air pollution/quality districts	Increase situational awareness during wildfire events	n/a*	2024/2025
Air Quality Management	Continue to benchmark with other IOUs on monitoring solutions	Air quality and the impacts of wildfire smoke for future consideration and evaluation in relation to risk modeling.	n/a*	Ongoing

System	Description	Impact	x% Risk Impact	Implementation Schedule
Program (WMP.970)				
Air Quality Management Program (WMP.970)	Track and adapt to regulatory changes	Compliance with federal and state regulations.	n/a*	Ongoing
Air Quality Management Program (WMP.970)	Explore smoke plume modeling technology	Protect employees from particulate exposure by assisting with selecting restoration staging areas based on smoke plume modeling	n/a*	Ongoing
Weather Station Network (WMP.447)	Upgrades to the weather station network including scaling fuels monitoring with the addition of DFM sensors, NDVI cameras communication equipment (modems), and batteries throughout the service territory	Increases situational awareness and obtains foundational data for operational and mission critical activities	n/a*	2023-2025
Weather Station Network (WMP.447)	Retrieve updated observation data to generate 95 th , 99 th , and max wind weather station statistics and update the historical observation statistics for all weather stations.	Updated data can be integrated back into the forecasting system to improve the model prediction via post processing, such as machine learning-based bias correction	n/a*	2023-2025
Weather Station Network (WMP.1430)	Weather station maintenance and calibration	n/a*	n/a*	Ongoing

** This initiative does not have a direct risk impact because it is considered foundational to supporting wildfire mitigation efforts. Quantifying Performance Metrics would be difficult and not beneficial because it cannot be directly tied to reducing a risk driver and measuring the effectiveness of that reduction.*

8.3.2.4 Evaluating Mitigation Initiatives

8.3.2.4.1 Weather Stations and NDVI Cameras (WMP.447)

Weather station observations are updated every 10 minutes for wind speed, wind direction, wind gust, temperature, and humidity. Observation data is displayed on a public-facing weather awareness website. The status of each weather station concerning the accuracy of reporting is constantly updated on an internal dashboard. Erroneous data is flagged for further evaluation and crews are dispatched as rapidly as possible to correct any misreporting weather stations. Additionally, the entire Weather Station Network is on a rotating calibration schedule to ensure the highest possible accuracy year over year.

NDVI cameras are the latest sensor addition to an ever-expanding weather awareness sensor network. Ninety percent of NDVI cameras have been installed at strategic locations that best represent the health of the grasses in a specific region. NDVI data is also received from government MODIS satellites at 250-meter resolution and from industry leader Planet at 3.7-meter resolution. These values are consistently evaluated for accuracy and compared to in situ observations performed by Meteorology.

8.3.2.4.2 Fuel Moisture (WMP.1334)

Meteorology has begun implementing its own fuel moisture network of sensors to augment the existing Remote Automated Weather Station (RAWS) DFM sensors throughout the county. Utilizing Google Earth and resident knowledge of the service territory, Meteorology has co-located four DFM sensors within the service territory that accurately reflect the state of dead fuels critical to fire potential understanding. These strategically placed sensors are evaluated weekly and compared to existing sensors to ensure the accuracy of reporting.

8.3.2.4.3 Air Quality Management Program (WMP.970)

The goal of the Air Quality Management Program (WMP.970) is to protect employees from PM_{2.5} exposure by quickly notifying employees when PM_{2.5} AQI thresholds are exceeded. The adequacy of the program can be evaluated by employees taking protective measures.

Additional measures to evaluate the adequacy of the program include comparison of the output data to existing county data and validation through routine maintenance. Prior to installation, a calibration or K-factor is developed for each sensor using a BAM unit running alongside each sensor and the data is compared to nearby County sensors over 3 days. The data is also validated by Western Weather during monthly maintenance checks. Factory re-calibration of the sensors every 2 years ensures performance over time. After several events of wildfire smoke or other triggers, a more comprehensive statistical analysis will be possible. SDG&E will continue to review scientific, academic and governmental research regarding air quality and the impacts of wildfire smoke for future considered and evaluation in relation to risk modelling.

8.3.3 Grid Monitoring Systems

8.3.3.1 Existing Systems, Technologies, and Procedures

SCADA is used by Distribution System Operators to monitor and control field equipment. There are over 900 SCADA sites in substations and field devices located in the HFTD. The system triggers data collection via solicited polling to bring in status and analog changes. SCADA (WMP.453) front end processors provide quality codes that identify bad data. Remote terminal units have internal diagnostic points that indicate bad data. SCADA alarms record these diagnostic events. Calculated quantities vary by sensor type (e.g., analog min/max/average is calculated by the system, trending allows for customized min/max/average calculations).

Data Historian captures, stores, and provides access to real-time and historical data from SCADA sensors, devices, and systems and is located on SDG&E on-premise servers. Data Historian provides analytical calculations based on raw data received from SCADA.

Outage Management System (OMS) is the hub for distribution operations regarding outage and distribution planning management and is located on SDG&E on-premise servers. Data collection is

collected from customer notifications, meter data (loss of power), and SCADA. Distribution System Operators verify outage via troubleshooters. Calculations from OMS data provides SAIDI and SAIFI metrics.

OnRAMP is a fault detection distribution management system and is located on SDG&E on-premise servers. This data is collected based on solicited and unsolicited polling. It does not perform any data calculations.

Synchrophasors/PMU are installed at key points in the grid, such as substations and distribution line-side devices, to provide a comprehensive view of the grid's performance. In the HFTD, there are over 400 Transmission PMUs from Transmission Substations and over 200 Distribution PMUs from Distribution substations and field devices. Data is constantly streamed at 30 samples per second from each PMU sensor location. Measured quantities are verified by system operators and compared against SCADA/EMS data in parallel. Measured electrical quantities are analog values and breaker statuses are digital values.

Wireless Fault Indicator (WFI) devices (WMP.449) are used to monitor electricity distribution lines and locate faults more efficiently and accurately using Low Power Communication Network (LPCN) communication to alert distribution system operators where a fault on any line or circuit occurred. WFIs can detect faults without having a minimum continuous current on the line, allowing the installation of remote locations that have very little load. Distribution operators can then dispatch electric troubleshooters close to the exact fault location to identify and isolate the fault and begin service restoration quickly.

See OEIS Table 8-27 for further information on Grid Monitoring Systems.

OEIS Table 8-27: Grid Operation Monitoring Systems

System	Measurement/ Observation	Verify	Trigger	Calculation	Location	Frequency	Purpose and Integration
SCADA	Telemetered points in RTUs provide status and analog data based on sensor type. Field devices are on both 12 kV and 4 kV circuits.	SCADA front end processor (FEP) provides quality codes that identify bad data. RTUs have internal diagnostic points that indicate bad data. SCADA alarms record these diagnostic events.	Solicited polling to bring in status and analog changes.	Varies by sensor type. Analog min/max/average is calculated by system. Trending allows for customized min/max/average calculations.	900+ SCADA sites in the HFTD including substations and field devices.	Varies by sensor type	SCADA is used by DSOs to monitor and control field equipment. It monitors telemetered points and alarms and operates field RTUs giving DSOs real-time situational awareness.
Data Historian	Collects and tracks data such as electricity usage, energy consumption, and other data points (megawatts, mega volt amps reactive breaker status, etc.)	SCADA provides quality code data points that identify bad data.	SCADA system provides the status and analog changes to Data Historian.	Data Historian system allows the creation of total, Average, Min, and Max, etc. calculations based on raw data received from SCADA	SDG&E on-premise servers.	Real time (60 seconds or less), varies by sensor type	Captures, stores, and provides access to real-time and historical data from sensors, devices, and systems. Used to monitor and optimize energy consumption, identify problems and inefficiencies, and perform data analysis and reporting.
OMS	Locations and duration of outages (SCADA is source of data)	DSOs verify outage via trouble shooters	Customer notification, SCADA data, Meter data (loss of power)	SAIDI, SAIFI – Estimation outage restoration, identification of resources needed to restore power	SDG&E on-premise servers	24 x 7, 365 days	OMS is the hub for distribution operations regarding outage and distribution planning management. OMS is integrated with a variety of systems to identify and restore outages.
OnRAMP (WFIs)	System used by Wireless Fault Indicators (WFIs) to	Detecting Distribution fault identification	Solicited/unsolicited polling	n/a	SDG&E on-premise servers	1 measurement per hour;	OnRAMP Fault detection Distribution management

System	Measurement/ Observation	Verify	Trigger	Calculation	Location	Frequency	Purpose and Integration
	monitor electric current – load (amps)					Approximately 2,900 devices	
Synchrophasors /Phasor Measurement Units (PMU)	Used to display measured electrical quantities such as phase voltage magnitude, phase current magnitude, phase angle and frequency of electrical signals in the grid. (e.g., MW, MVAR, Phase Angle, Frequency, Phase Magnitude)	Measured quantities are verified by system operators and compared against SCADA / EMS data in parallel.	Data is constantly streamed at 30 samples per second from each PMU sensor location.	Measured electrical quantities are analogs values and breaker statuses are digital values.	400+ Transmission PMUs from Transmission Substations and 200+ Distribution PMUs from Distribution substations and field devices for the HFTD.	Real time; 30 samples per second per PMU sensor location	Type of device used to display and measure the electrical characteristics of the electric power system. Data is sent to a central monitoring system in real time. The data collected by PMUs is transmitted to a central monitoring system, where it can be used for data analysis, reporting, and control purposes

8.3.3.2 Evaluation and Selection of New Systems

New grid monitoring systems or updates to existing grid monitoring systems can be proposed by stakeholders throughout the Company. New ideas and initiatives are obtained through collaborating with regulators and other utilities, evaluating performance of existing systems, and reviewing emerging technology. Proposed modifications or additions are reviewed for feasibility and the associated potential costs and benefits before being approved and implemented. When a new technology is developed, the methodology for evaluating its efficacy is also determined with input from internal subject matter experts, industry experts, and academia.

8.3.3.3 Planned Improvements

OEIS Table 8-28: Planning Improvements to Grid Operation Monitoring Systems

System	Description	Impact	X% Risk Impact	Implementation Schedule
SCADA (WMP.453)	An expansion of the existing system will include six new servers and upgrade to current vendor software versions.	Provides improved reliability to integrate with OMS and data historian. Provides a new test environment for OMS integration and improves business continuity.	See note*	Installation of servers March 2023. Go-Live of software upgrade June 2023.
OMS	Hastened implementation of sensitive relay profiles based on the districts with an FPI rating of Extreme (WMP.1338). Includes auto-generated switch plans (switching performed manually). Added patrol safety prompts.	This will allow operators to more efficiently and safely implement sensitive relay profiles as a mitigation to prevent ignitions. It will also create patrol safety prompts that help ensure patrols are performed when the FPI rating is elevated or extreme prior to restoration.	See note*	Scheduled to be in service by 12/31/2024

**Note: This planned improvement to the grid monitoring system does not have risk impact percentages; it is considered foundational to supporting wildfire mitigation efforts. Quantifying risk impact percentages would be difficult and not beneficial because it cannot be directly tied to reducing a risk driver and measuring the effectiveness of that reduction.*

8.3.3.4 Evaluating Mitigation Initiatives

Grid monitoring systems are foundational to supporting wildfire mitigation efforts. Quantifying a Risk Reduction Estimation would be difficult and not beneficial because it cannot be directly tied to reducing

a risk driver and measuring the effectiveness of that reduction. WFIs are an exception to the above statement for the reasons stated below.

The WFI Mitigation Program, which, utilizes the OnRAMP monitoring system, reduces the risk of wildfires by providing awareness to where faults have occurred on distribution lines, essentially improving electric safety and reliability during regular as well as extreme weather conditions, so that remote cameras can be directed to that location to determine if an ignition occurred. The WFI Mitigation Program helps to reduce the consequence of a fire spreading and helps deploy troubleshooters to a location quicker, should a fire occur.

8.3.3.5 Enterprise System for Grid Monitoring

8.3.3.5.1 Database(s) Utilized for Storage

- SCADA is a highly configurable, off-the-shelf software and is stored in a proprietary file-based database on-premise in an isolated secure network.
- Data Historian is a highly customized, off-the-shelf software and stored in a proprietary timeseries database.
- OMS is a highly customized, off-the-shelf software application and data is stored in a relational database.
- OnRAMP is a proprietary database that contains data on circuit fault indicators.
- Synchrophasor/PMU is a highly customized, off-the-shelf software and is stored in a proprietary timeseries database.

8.3.3.5.2 Internal Documentation of Database(s)

Internal documentation of the grid monitoring systems are as follows:

- SCADA documentation includes user guides, configuration guides, and training aids proprietary to vendor.
- Data Historian documentation includes a user guide, system access guide and visualization tools.
- OMS documentation includes user guides.
- OnRAMP documentation is maintained by the vendor.
- Synchrophasor/PMU documentation includes a user guide, system access guide and visualization tools.

8.3.3.5.3 Integration with Systems in other Lines of Business

SCADA integrates with several systems in other lines of business including the following:

- NMS which provides real-time field status and analog values
- Corporate historian for status and analog timeseries data
- Internal historian that records alarms, status, and analog data
- SPLUNK in compliance with SDG&E Operational Technology standards
- Microgrid controller application for monitoring and controlling Distributed Energy Resources telemetered points.
- FCP devices
- SDG&E weather network

Data Historian integrates with distribution and transmission SCADA systems and a substation gateway (a non-SCADA system for substations) for data collection. Data Historian also integrates with other enterprise systems to provide a comprehensive view of data such as asset health systems, outage management systems, procurement systems, customer information systems and central database repositories.

OMS is interfaced with several systems in other lines of business, including:

- SCADA Head-End system for monitoring and controlling the distribution network
- GIS for data related to the as-built construction of the distribution network
- Meter Data Management System to obtain status of individual customer meters
- Meteorology data for weather-based circuit loading and forecasting
- Service Dispatch system for outage/distribution system process flow management
- Outage Analytics reporting for system level data analytics
- Customer information systems for association of customer accounts with meters

OnRAMP integrates with the Data Historian. Data Historian users can then create dashboards and alerts for any anomalies detected in fault indicator devices.

Synchrophasor /PMU: Transmission PMU data is shared with the reliability coordinator (RC West / CAISO) and neighboring utilities. SDG&E receives PMU data from other utilities such as SCE, Arizona Public Service (APS), Bonneville Power Administration (BPA) and PG&E.

8.3.3.5.4 QA/QC or Auditing of the System

Business analysts and an IT QA team are directly responsible for non-functional components, test validations and user audits of the system. Details of the QA/QC or audit processes are outlined below:

- The QA/QC of the SCADA system follows SDG&E OT Standards. All new field devices go through a point-to-point field test prior to device being released for SCADA operation. All active sites go through a maintenance test every 6 years or less. SCADA system audits were completed in March of 2022 by an internal audit team, and an Information Security assessment was completed in July of 2022 as per OT Standards. A third-party vendor conducted a security assessment in February of 2020.
- The QA/QC of the OMS system includes a regression testing by the QA test team with each patch/enhancement software release. Audits include cybersecurity, and outage information audits by the internal Electric Reliability team.
- A QA/QC of the circuit fault data in the OnRAMP system is conducted by the OMS system.
- The system administrator performs the PMU data measurement verification during PMU installation and commissioning.

8.3.3.5.5 Updating the Enterprise System Including Database(s)

Changes made to SCADA and the Synchrophasor/PMU systems follow the SDG&E OT standards. In addition, changes made to the Synchrophasor/PMU also follow NERC CIP standards. Additional details for updating enterprises systems are outlined below:

- The SCADA vendor provides approved patches for third-party applications and vendor patches per the service agreement. All patches are implemented in the quality assurance environment

prior to implementation in production environment. All changes are recorded within the SCADA system and application logs are stored in SPLUNK system. All database changes are completed and run through a system validation in a non-production development environment and are reviewed prior to promoting changes to the production environment.

- Changes made to the Data Historian system, such as software upgrade and patches, are first tested in a QA environment. Once approved, they are placed into a production environment.
- Enhancements/defect fixes for the OMS application and database are first tested by the vendor in a simulated OMS environment where configurations are verified. The OMS maintenance team then deploys software on a development environment and performs testing of selected portions of the application. The software is then deployed in a QA environment where extensive automated and manual regression testing is conducted. If any issues arise, defects are created, corrected, and redeployed on the respective system. Once all testing is successful, the software is deployed into the production environment.
- Changes made to SEL Synchrowave system, such software upgrades and patches, are first tested in a QA environment. Once approved, they are placed into a production environment.

8.3.3.5.6 Changes to the Initiative since the Last WMP Submission

Changes made to the grid monitoring system since the last WMP submission include:

SCADA communications for field devices were transitioned to internet protocols (IP) on the existing radio frequency 4RF network. This improved communication for good polls to field devices by 5 to 15 percent. Polling performance improved by 30 percent system wide. Communications will be migrated to pLTE in future projects.

8.3.4 Ignition Detection Systems

8.3.4.1 Existing Ignition Detection Sensors and Systems

OEIS Table 8-29: Ignition Detection Systems Currently Deployed

Detection System	Capabilities	Companion Technologies	Contribution to Fire Detection and Confirmation
Satellite Based Remote Sensing (WMP.971)	Ignition detection from geostationary satellite	Used with camera imagery to verify fire detection	Satellite detected ignitions allow for confirmation of wildfires and can help operators assess the scope of resource response needed.
Cameras (WMP.1343)	Smoke detection	Used with satellite ignition detection to verify fire	Wildfire smoke detections corroborate the initial hot spot detections from space
AI Smoke Detection Algorithm	Smoke detection using artificial intelligence	Used with satellite ignition detection to verify fire	Wildfire smoke detections corroborate the initial hot spot detections from space

The detection of ignitions coupled with the rapid filtering and analysis of available information is what makes fire responses successful. The overall responsibility for monitoring and effectively communicating information about emerging incidents is assigned to the Fire Science and Coordination team. This team

is comprised of former firefighters who bring experience in responding to emergencies and strengthening relationships with first responders. The team also staffs a 24/7/365 On Duty Fire Coordinator responsible for monitoring radio traffic and coordinating with local agencies to receive dispatch notifications utilizing the same system as the fire agencies. Upon receiving a notification of an incident, the On Duty Fire Coordinator coordinates with internal and external resources to ensure a safe and efficient response from SDG&E to support any requests from first responder agencies. Additionally, the On Duty Fire Coordinator may respond to the scene of an incident to serve as the single point of contact from the utility to the Incident Commander. This process has been in place for incident response in the service territory for over a decade and has remained dynamic with changing technologies. Ignition detection and the coordination of incident response is most successful when done in coordination with other agencies. Emerging technologies can enhance the situational awareness of responders but it is the relationships built through training, communication, and incident response that enable their implementation to be successful.

8.3.4.1.1 Satellite Based Remote Sensing (WMP.971)

The SSEC at the University of Wisconsin-Madison is a world-class archive of satellite data, receiving, archiving, and redistributing most geostationary weather satellite data produced globally. In collaboration with the SSEC, GOES 16/-17 and the ABI are utilized to operationalize fire detection and characterization at a spatial resolution of 2 km and temporal resolutions of 5 minutes, in some circumstances 1 minute or faster. Fire Detection and Characterization (FDC) is accomplished with the Wildfire Automated Biomass Burning Algorithm (WFABBA) adopted for ABI-class sensors. Hotspots are rated in six fire categories based on confidence in the Fire Radiative Power (FRP), size, and temperature estimates.

Space-based fire alerts are sent to SDSC in real time where they are archived and processed for relevance within established boundary conditions and filtered for false positives. The ignition data is then sent to SDG&E as an email with a link to a web-based map of the area with camera images auto triangulated on the fire.

The GOES system is in geo-stationary orbit and images the western United States continuously. It is expected to be operational until 2033. The sensor pathways are government controlled and thus the resiliency is unknown but assumed to be durable and redundant. Ignition detections that have been characterized as legitimate fires on the landscape are promulgated to appropriate users within the organization that consider the information actionable. False positive filtering is constantly ongoing and recurring indicators such as industrial solar farms are routinely filtered from the terrestrial scan. Typically, the time between detection and confirmation is less than 5 minutes and this has been corroborated with numerous fires and with the prerequisite indications and warnings. The information obtained from the GOES system is securely processed with the WFABBA algorithm and sent to the SDSC for post processing.

In 2022, SDG&E incorporated satellite-based ignition detection and camera footage of smoke into one common operating picture. Over the next WMP cycle, there will be a continued effort to explore and advance satellite-based remote sensing by developing automation in fire detection capabilities,

archiving ignition detection information from ground sources, archiving camera verification of satellite heat detections, and providing feedback on validation to vendor concerning hot spot detection.

Future improvements for the 2023 to 2025 WMP cycle to initiative include:

- Continuously provide feedback on validation to vendor concerning hot spot detection
- Develop full automation in fire detection capabilities
- Archive ignition detection information from ground sources and perform analysis to help improve algorithms.
- Archive camera verification of satellite heat detections
- Filter out areas of known recurring false positives like industrial solar farms

Future improvements to initiative beyond the current WMP 2023 to 2025 cycle include:

- Analyze 3 years of satellite ignition data, AI smoke detection, and ground source ignition verification to feedback to vendor on algorithm performance
- Partner and collaborate to enhance FDC within the WFABBA by providing validation of the six fire categories based on confidence in the FRP, size, and temperature estimates

8.3.4.1.2 Cameras (WMP.1343)

The robust camera network of over 130 mountain-top cameras enables near real-time reporting of fire ignitions in the service territory. This network of cameras is built on the backbone High Performance Wireless Research and Education Network (HPWREN), in partnership with the UC San Diego and local fire departments. Images from the mountain-top camera network are relayed via Federal Communications Commission (FCC)-licensed radio spectrum to a publicly available web-based platform. Forty-three of the 130 cameras are known as Pan-Tilt-Zoom (PTZ) cameras with remote access for limited SDG&E personnel and local fire agency personnel to aid in the triangulation of ignitions or areas of interest.

Cameras are strategically located on mountain-tops with optimal viewsheds to mountainous areas of dense brush and chaparral but due to their advanced capabilities, these locations also provide excellent vantage points into not only the HFTD but some WUI areas and other urban areas. The cameras are physically located throughout the entire service territory.

SDG&E provides funding to the HPWREN user group for camera maintenance and installation but does not own the assets. The maintenance funding ensures redundant feeds for all cameras such that if a feed is lost through the Alert California website, backup imagery is available through the HPWREN-dedicated website. In addition, backend communication pathways are comprised of a multi-point radio system thereby providing redundant pathways for relaying camera imagery. In 2022, portions of SDG&E's maintenance funding were dedicated to adding redundancy to ensure the resiliency of the mountain-top network.

Cameras provide visual confirmation of reported ignitions or areas of concern and are used as an additional data point in enhancing situational awareness. Camera feeds do not provide positive or negative imagery but rather constantly feed imagery. Cameras operate independently of detection and confirmation. See Section 8.3.4.1.4 for additional information on AI sensor data, AI Smoke Detection and related false positive filtering, and detection and confirmation timelines.

The security of the camera network is managed by the UC San Diego supercomputing center. SDG&E is not responsible for the safety of publicly available imagery; however, the camera network is independent of any SDG&E internal systems.

Future improvements to initiative include:

- Harden backbone communication network for mountain-top cameras via replacement of legacy equipment and work to explore AI technology for image processing.
- Continue hardening backbone network and expand to new sites when/where broader fire community benefit can be realized. Automate smoke detection notifications leveraging AI software, if determined to add value.
- Continue to harden infrastructure to support communications via mountain-top camera network.

Future improvements to initiative beyond the current WMP 2023 to 2025 cycle include:

- Seek to integrate AI Smoke Detection from mountain top cameras into a common operating picture

8.3.4.1.3 WFA - Fire Growth Potential Software

Technosylva's WFA-E product is used to conduct the modeling, deliver modeling outputs, and monitor and visualize results with software applications. It does not have a utility ID because it is a tool that support initiatives. The wildfire behavior modeling and risk analysis is applied to address two different, yet similar, scenarios.

First, the modeling is used with historical re-analysis WRF (WMP.532) weather data to support the mitigation planning process. The WFA-E WRRM is used to quantify risk metrics from millions of wildfire simulations using the numerous WRF weather scenarios defined. This wildfire consequence data is then combined with probability of failure and ignition analysis developed internally to define composite risk values to support prioritization decision making for asset hardening and related mitigation.

Second, the modeling is used with daily WRF-based weather forecast data to calculate consequence-based risk metrics for all assets as possible ignition sources to support operational requirements. Other key input datasets such as surface and canopy fuels, and LFM and DFM, is developed daily using ML models to calculate the wildfire behavior outputs as part of the risk analysis model. Wildfire risk forecasts are derived daily, or sometimes twice daily, with a multi-day outlook on an hourly basis. This information is used as input into key decision making related to operational requirements, such as PSPS, resource allocation and deployment, and field operations.

8.3.4.1.4 AI Smoke Detection Algorithm

The AI smoke detection algorithm, proprietary and owned by Alchera Inc., was implemented in 2021. It does not have a utility ID because it is a tool that support initiatives. Thirty mountain-top cameras with PTZ capability leverage Alchera's smoke detection algorithm to provide near real-time alerts of ignitions within the HFTD and surrounding areas. Through a dedicated web dashboard called FireScout, SDG&E can review all alerts and ignition detections from the machine vision algorithm. Alerts are provided only to select internal users through text message and/or email. This information is critical to identifying fires soon after ignition by operationalizing satellite fire detection coupled with mountain-top cameras.

Space-based fire alerts are sent to the SDSC in real time where they are processed for relevance within established boundary conditions and filtered for false positives. The ignition data is then sent to SDG&E within 5 minutes as an email that includes a link to a web-based map of the area and camera images auto triangulated on the fire.

Most of the 30 cameras enabled with smoke detection are located within the HFTD, though roughly 10 to 15 percent of the cameras are located service territory wide to ensure adequate coverage from different vantage points.

AI detection software runs independently from mountain-top cameras and therefore does not rely on sensors communication. The AI detection software runs in the cloud, processing imagery publicly available through the HPWREN network. Ultimately the resiliency of the AI software is dependent upon the resiliency of the camera network. That said, the AI system and agreement for service guarantees no service interruption greater than 10 hours other than circumstance outside the vendor's control. Space-based alerts run independently of mountain-top camera image processing, so this also provides an added layer of redundancy in detection ability.

Although the Alchera's FireScout AI vision algorithm is proprietary, what can be shared at a high level is that AI is leveraged to train the algorithm to better detect and filter out false positives. As both space-based alerts and AI smoke detection results are processed, the algorithm continues to grow in confidence.

AI smoke and ignition detection systems reduce response time and minimize potential consequences for ignitions. AI smoke detection software leverages a human-in-the-loop process in order to train the system initially. Over time, AI and machine learning result in less human intervention. FireScout specifically operates with a false positive rate of 0.0012. From detection to confirmation, or in this case alert, no more than 1 minute will pass. Space-based sensing however requires roughly 5 minutes for confirmation.

SDG&E requires all software-based contractors to adhere to strict information security requirements to ensure the safety and security of all intellectual property. This includes but is not limited to role-based access, authorization, and accountability controls. Two-factor authentication is required for any remote support and strict protocols on data encryption are followed. In addition, SDG&E and its contractor have an agreed upon vulnerability and defect tracking process. Annual certification of security assessment testing is also a strict requirement.

Figure 8-35: Smoke Detection Image Identified by AI Smoke Detection Algorithm



8.3.4.2 Evaluation and Selection of New Detection Systems

A formal process flow does not exist to evaluate the need for additional ignition technologies since each technology is unique relative to the service territory. Through partnerships with first responder agencies, staffing of 24/7 On Duty personnel with responsibility to monitor for ignitions, and various technologies, SDG&E is able to gather information, analyze needs, and respond to incidents as they emerge. In most cases response to incident responses begin seconds after a 911 call is received by first responders. Through collaboration with local, state, and federal fire agencies, detection systems aide in the overall situational awareness of the region with the benefits not being limited to the utility. An ignition detection within the San Diego and Southern Orange County relies on the collaboration between first responders, the utility, and the public. These relationships can be enhanced by emerging technologies and their effectiveness is measuring against existing processes. Exploring new technologies and evaluating their effectiveness is always done in a way that focuses on the value added to the larger situational awareness picture and potential impacts that the output may have on a response.

8.3.4.2.1 Impact of new Detection Technologies

When a new technology is developed, the methodology for evaluating its impact is also determined.

8.3.4.2.2 Efficacy of New Technologies

When a new technology is developed, the methodology for evaluating its efficacy is also determined with input from internal subject matter experts, industry experts, and academia. The FSCA team leverages relationships with industry experts in the public and private sector such as Western Weather and the University of Wisconsin to benchmark state-of-the-art technologies. In addition to determining the efficacy of new technologies, Safety staff attend conferences where exhibitors demonstrate emerging technologies to assist with hazard recognition and controls. SDG&E acknowledges the continuous evolution of technology as climate and other factors result in change and as a result, is always seeking improvements to enhance safety, reliability, and minimize risk.

8.3.4.2.3 Budgeting Process

When a new technology or program is identified, the appropriate business unit will evaluate the technology for applicability and develop a proposal for deployment including cost projections. The costs are reviewed by leadership within the business unit proposing the project. If the project will contribute to wildfire mitigation, the proposal is presented at the Wildfire Mitigation Plan Memorandum Account (WMPMA) Review Team meeting where it is evaluated for inclusion in the WMP and the WMPMA. The director of Wildfire Mitigation will approve or deny the proposal for inclusion in the WMPMA, and if approved, a separate work order or budget code will be created for the project to ensure costs are appropriately accounted for in the WMPMA and/or other internal budgets.

8.3.4.3 Planned Integration of New Detection Technologies

A formal process flow does not exist for the planned integration of new ignition detection technologies since each technology is unique. When a new technology is developed or implemented, the methodology for physical integration, system integration into existing data analysis, budget and staffing support, are determined for that technology.

OEIS Table 8-30: Planning Improvements to New Fire Detection and Alarm Systems

System	Description	Impact	x% Risk Impact	Implementation Schedule
n/a	n/a	n/a	n/a	n/a

Note: there are no plans to incorporate any new fire detection or alarm systems for 2023.

SDG&E plans to continue to improve ignition detection sensors and systems. See Section 8.3.1.1 Objectives for planned improvements related to Ignition Detection Sensors and Systems.

8.3.4.4 Evaluating Mitigation Initiatives

8.3.4.4.1 Satellite Based Remote Sensing (WMP.971)

See Section 8.3.4.1.1 Satellite Based Remote Sensing for details on the system process flow. The efficacy of the fire detection system from the GOES satellite is evaluated every time there is a fire detection from space. The ignition detection is immediately compared to mountain-top camera feeds at the same location and corroborated with radio indication from CAL FIRE received by the FSCA. A year of operational use and effective spatial and known false positive filtering has yielded a system that is reliable and has rarely shown to yield false positives.

8.3.4.4.2 Cameras (WMP.1343)

Cameras provide a visual product with immediate results and with cameras now reaching the point of service territory saturation, ongoing evaluation of efficacy has transitioned to evaluation of effectiveness. Effectiveness is measured by uptime and availability to both SDG&E and first responders. Except for extreme weather around some of the highest mountain-tops, such as severe icing conditions, the camera network rarely fails and is therefore highly effective.

8.3.4.4.3 Fire Growth Potential Software

SDG&E uses the WRRM model developed by Technosylva for fire spread simulations. Simulations are based on the 141 worst historical fire weather days and simulate ignitions at regular intervals along the

electric distribution system. The WRRM model is used to understand the relative wildfire consequence risk per circuit segment in the HFTD. The model runs a myriad of simulations and delivers a variety of statistics that help inform the wildfire consequence risk per segment.

Auditing the implementation of the WRRM model has been done manually for past WRRM updates. Starting in 2023, new scripts will gauge the validity of the WRRM data prior to replacing the existing data in the model. Validation of WiNGS-Ops model elements including WRRM is still in development, with formal validation scripts expected to roll out in 2023. The recent migration of the WiNGS-Ops model to Python and AWS will facilitate validation automation efforts.

Monitoring the effectiveness of the WRRM model is conducted by Technosylva. They work directly with CAL FIRE to validate the model performance and although there is not currently a formal data modification process, data is interpreted by subject matter experts.

8.3.4.4.4 AI Smoke Detection

AI smoke detection evaluation of efficacy procedure is summarized on a third-party-hosted platform³¹ and involves a test model, training the model, layering the model over real-time detections, confirming results, and storing results to inform the AI model framework. This process is repeated which trains the AI model with each new detection.

8.3.4.5 Enterprise System for Ignition Detection

8.3.4.5.1 Database(s) Utilized for Storage

Ignition detection systems such as Satellite-based remote sensing, Cameras, WFA, and AI Smoke Detection are externally hosted.

8.3.4.5.2 Internal Documentation of Database(s)

There is no internal documentation for Ignition detection systems such as Satellite-based remote sensing, Cameras, WFA, or AI Smoke Detection as they are externally hosted.

8.3.4.5.3 Integration with Systems in other Lines of Business

Notifications from external monitoring systems is integrated into the overall situational awareness and company response to emerging fire incidents. The detection systems help to support established processes, such as monitoring radio traffic and receiving incident dispatches from fire dispatch centers. Information is then quickly analyzed and a response is initiated.

8.3.4.5.4 QA/QC or Auditing of the System

Data and/or alerts received from the ignition detection systems are verified by comparing them to actual fire locations and dispatches for first responder agencies.

8.3.4.5.5 Internal Processes for Updating Enterprise System Including Database(s)

There are no internal processes for updating the enterprise system for ignition detection since these systems are externally hosted.

³¹ <https://firescout.ai/how-it-works/>.

8.3.4.5.6 Changes to the Initiative since the Last WMP Submission

There are no changes to the enterprise system for ignition detection since the last WMP submission.

8.3.5 Weather Forecasting (WMP.541)

8.3.5.1 Existing Modeling Approach

Meteorology owns and operates three supercomputers running five ensembles of the WRF Model at 2 km and 6 km horizontal resolution, generating 170 GB of data daily. These WRF (WMP.532) forecast simulations are displayed in visualization portals to help Meteorology analyze and prepare accurate weather forecasts. In addition to weather parameter modeling and visualization, post processed models and indices provide impactful situational awareness:

- The Machine Learning Wind Gust model for the HFTD (189 out of 220 weather stations) is vital for situational awareness 72 hours prior to a dangerous fire weather event. The circuit forecast is generated twice daily with the latest weather model forecasts and the output is a 3-day forecast for each circuit associated weather station, delineating max gust and time for each day.
- The FPI (WMP.450) is a 7-day forecast that classifies fire potential based on weather and fuels condition in eight districts. It is used daily by employees, supervisors use for crew deployment and resourcing decisions and shared with local fire agencies, emergency responders and the National Weather Services.
- The SAWTI (WMP.540) was developed to rate Santa Ana wind events and is issued daily by the U.S. Forest Service.

Collected weather data and forecast modeling is integrated into fire behavior and fire potential tools, contributing to ignition probability and estimated wildfire consequence. Fuel conditions are not projected outside of the 7-day forecast period of the FPI. Fuel moisture data available from the RAWS and fire agencies is closely monitored, including the Energy Release Components, LFM Percentages through the National Fuels Database, and the number of grams of water that are measured in the 1-, 10-, 100- and 1000-hour fuels across the region. LFM values are considered extreme when the reading falls below 60 percent.

The AI forecasting system has been integrated across 190 weather stations, providing the latest available forecasting technology to help serve communities in the highest risk fire areas. The ability to implement this technology stems from recording weather observations every 10 minutes for over 10 years, collecting one billion observations that are available to be used in training AI. As more data is collected each year, more data can be integrated back into the forecasting system to improve the model, increasing the accuracy of weather forecasts, which are shared with the public and fire agencies.

SDG&E acquired two new high-performance computing clusters in 2022 that generate high-quality weather data that is incorporated directly into operations. Collectively, nearly 2,000 compute core hours of high-performance computing are used per day to generate operational products, including the SAWTI, FPI, and WFA-E. The forecast data generated by these supercomputers is shared with researchers and various stakeholders and APIs enable public access to WMP-related datasets by authorized users for use in fire modeling.³²

³² <https://wifire-data.sdsc.edu/organization/sdge>

Future improvements to initiative include:

- Create higher resolution operational products using the new high-performance computing clusters.
- Partner with academia to explore and evaluate large computational resource to include a module for impact of large eddy scale weather.

The contribution of weather to ignition probability and estimated wildfire consequence is integrated into decision-making by integrating weather data and forecast modeling into fire behavior and fire potential tools. WFA-E, SDG&E's fire behavior modeling tool, was developed using 30 years of historical weather data. The FPI, another fire modeling tool, leverages weather data into the fire potential that is updated daily. These tools provide forecasters with information on the PoI and the potential for wildfire to grow rapidly. When specifically looking at the PoI, major contributing factors are atmospheric vapor pressures and the resulting DFM of finer fuels. These factors are incorporated into the FPI through fuel moisture and weather components and contribute to the daily index ranking which ranges from Normal to Extreme and carries increasing levels of work restrictions. Updated local known weather conditions are also incorporated into system hardening projects and construction standards to assist with forecasting of longer-term investments.

8.3.5.1.1 Weather Research and Forecasting (WRF) (WMP.532)

The WRF Model is a state-of-the-art mesoscale numerical weather prediction system designed for both atmospheric research and operational forecasting applications. It features two dynamical cores, a data assimilation system, and a software architecture supporting parallel computation and system extensibility. The model serves a wide range of meteorological applications across scales from tens of meters to thousands of kilometers. The effort to develop WRF began in the latter 1990s and was a collaborative partnership of the National Center for Atmospheric Research (NCAR), the National Oceanic and Atmospheric Administration (represented by the National Centers for Environmental Prediction and the Earth System Research Laboratory), the U.S. Air Force, the Naval Research Laboratory, the University of Oklahoma, and the FAA.

For researchers, WRF can produce simulations based on actual atmospheric conditions (i.e., from observations and analyses) or idealized conditions. WRF offers operational forecasting a flexible and computationally-efficient platform, while reflecting recent advances in physics, numerics, and data assimilation contributed by developers from the expansive research community. WRF is currently in operational use at NCEP and other national meteorological centers as well as in real-time forecasting configurations at laboratories, universities, and companies.

WRF has a large worldwide community of registered users (a cumulative total of over 57,800 in over 160 countries as of 2021), and NCAR provides regular workshops and tutorials on it.

8.3.5.1.2 SAWTI (WMP.540)

The SAWTI (WMP.540) calculates the potential for large wildfire activity based on the strength, extent, and duration of the wind, dryness of the air, dryness of the vegetation, and greenness of the grasses. Similar to the hurricane-rating system, the SAWTI compares current environmental data to climatological data and correlates it with historical wildfires to rate a Santa Ana wind event using four threat levels that range from "marginal" to "extreme."

For details on the SAWTI, refer to Appendix B and the *Santa Ana Wildfire Threat Index: Methodology and Operational Implementation*.³³

8.3.5.2 Known Limitations of Existing Approach

As with any computational weather model, there are temporal and spatial limitations to the parameters that are being modeled into the future. Specifically, the WRF (WMP.532) spatial resolution is on a 2 km grid which may not resolve micro scale weather phenomenon induced by diverse sub 2 km terrain. Additionally, running a numerical weather model at a resolution considered high by 2023 standards has a temporal limitation of less than 5 days.

All components of the SAWTI (WMP.540) are modeled and thus there are inherent limitations to each. In addition, several major assumptions are made when calculating the SAWTI. See *The Santa Ana Wildfire Threat Index: Methodology and Operational Implementation*³³ for details.

8.3.5.3 Planned Improvements

OEIS Table 8-31: Planned Improvements to Weather Forecasting Systems

System	Description	Impact	x% Risk Impact	Implementation Schedule
SAWTI (WMP.540)	Refine the SAWTI index based on new 1.5 km WRF inputs	Enhance the characterization and prediction of environmental conditions that are associated with large wildfire activity under dry, offshore winds	n/a	2023-2025
SAWTI/FPI (WMP.540 and WMP.450)	Continue improving existing models (FPI, SAWTI) by noting and evaluating discrepancies between predictions and observed reality.	Enhance the characterization and prediction of environmental conditions that are associated with large wildfire activity under dry, offshore winds	n/a	2023-2025
SAWTI (WMP.540)	Improve LFM Machine Learning model which is an input in both FPI and SAWTI	Enhance the characterization and prediction of environmental conditions that are associated with large wildfire activity under dry, offshore winds	n/a	2023-2025
SAWTI (WMP.540)	Continue working with academia and fire agencies to further develop fire science for integration into SAWTI. In 2023, the resolution of the WRF modeling used to generate the SAWTI will be increased, which will require re-coding of the software that processes the weather and fuels data.	Enhance the characterization and prediction of environmental conditions that are associated with large wildfire activity under dry, offshore winds	n/a	2023-2025

³³ American Meteorological Society, *The Santa Ana Wildfire Threat Index: Methodology and Operational Implementation* (December 1, 2016) available at https://journals.ametsoc.org/view/journals/wefo/31/6/waf-d-15-0141_1.xml.

System	Description	Impact	x% Risk Impact	Implementation Schedule
WRF/SAWTI/FPI (WMP.532, WMP.540, WMP.450)	Re-create the 30-year downscaled NOAA's Climate Forecasting System Reanalysis (CFSR) data using higher resolution 1.5 km WRF and integrate into FPI and SAWTI.	Enhance the characterization and prediction of environmental weather conditions that are associated with large wildfire activity under dry, offshore winds; improve the dataset that can be used to train relevant statistical/ML-based models that can help further improve the prediction of potentially hazardous weather conditions that could impact the operations	n/a	2023-2025
WRF/SAWTI (WMP.540)	Implement the new operational 1.5 km WRF configuration upgraded from the current 2 km resolution to update all downstream indices (FPI, SAWTI) from the higher resolution WRF output.	Enhance the characterization and prediction of environmental weather conditions that are associated with large wildfire activity under dry, offshore winds; improve the accuracy of predicting potentially hazardous weather conditions that could impact the operations	n/a	2023-2025
WRF (WMP.532)	Build a new Machine Learning (ML) wind speed and gust model that will be trained and validated with the new consistent operational and historical 30-year dataset. Use the ultra-high-resolution terrain to place corrections on the WRF domain.	Enhance the characterization and prediction of downsloping offshore winds that are associated with large wildfire activity	n/a	2023-2025

Meteorology currently runs five ensembles of the WRF weather model. Of the five ensembles, four are at 2 km resolution, providing high resolution forecasts of all requisite meteorological parameters necessary to characterize the environment on a timeline up to 4 days. The fifth ensemble is the long-range forecast at a 6 km resolution.

For 2023, Meteorology will work with an industry-leading weather modeling company to upgrade WRF to a 1.5 km resolution and to increase the ensemble portfolio to up to 10 members. This new WRF configuration will feed all post-processed indices by recreating a 30-year climatic data set that will be implemented throughout the product suite used to help forecast dangerous and impactful weather conditions. Specifically, the new 1.5 km WRF configuration will implement new enhanced DFM/National Fire Danger Rating System (NFDRS) framework, update the chamise new/old growth LFM ML models, update the NDVI machine learning models, and it will update the SAWTI and FPI criteria.

Future improvements to initiative beyond the current WMP 2023 to 2025 cycle include:

- Data-intensive initiatives will be enhanced through additional information integration, automation, and strategic partnerships.
- Production and sharing of forecast products will continue, as well as the prioritization of data analytics and modeling. Working with the SDSC, data science advancements will be monitored to ensure that this technology can provide the advanced analytics required to maximize operations.
- Collaboration with SAWTI stakeholders will continue.

8.3.5.4 Evaluating Mitigation Initiatives

Refer to *The Santa Ana Wildfire Threat Index: Methodology and Operational Implementation* Section 3d-Validation for details on efforts undertaken to verify and validate model performance.³³

Rationale and Validation of Weather Modeling

SDG&E utilizes three supercomputers to run five ensembles using the state-of-the-art WRF numerical weather prediction model (WMP.532). Model output is integral to the generation of the ML Gust Forecast used to determine customer notifications and post processed indices to include the Outage Prediction Index (OPI), SAWTI (WMP.540), and the FPI (WMP.450).

Numerical weather model output enables Meteorology to predict the wildfire risk by calculating the FPI, a planning and decision-supporting tool designed to reduce the wildfire risk by examining the susceptibility of the environment to fire. Using observations and reanalysis data from WRF modeling, the FPI was reproduced for the years 2002 through 2018 and compared with large fires that occurred throughout the service territory. Major wildfires occurred during periods of Extreme FPI, demonstrating the FPI as a reliable tool for assessing the fire environment (see Section 8.3.6.1.1 Efficacy Study: Determination of Average Distribution Ignition Percentages by Location and Operating Risk Condition for details).

Similarly, the SAWTI was calculated from 1984 through 2021 and compared to the occurrence of large fires in Southern California during Santa Ana winds. Figure 8-36 shows that the majority of large wildfires occurred during periods of High SAWTI or Extreme SAWTI, demonstrating the SAWTI as a reliable tool for assessing the fire environment.

Figure 8-36: SAWTI Across Time and Incidences of Major Wildfires

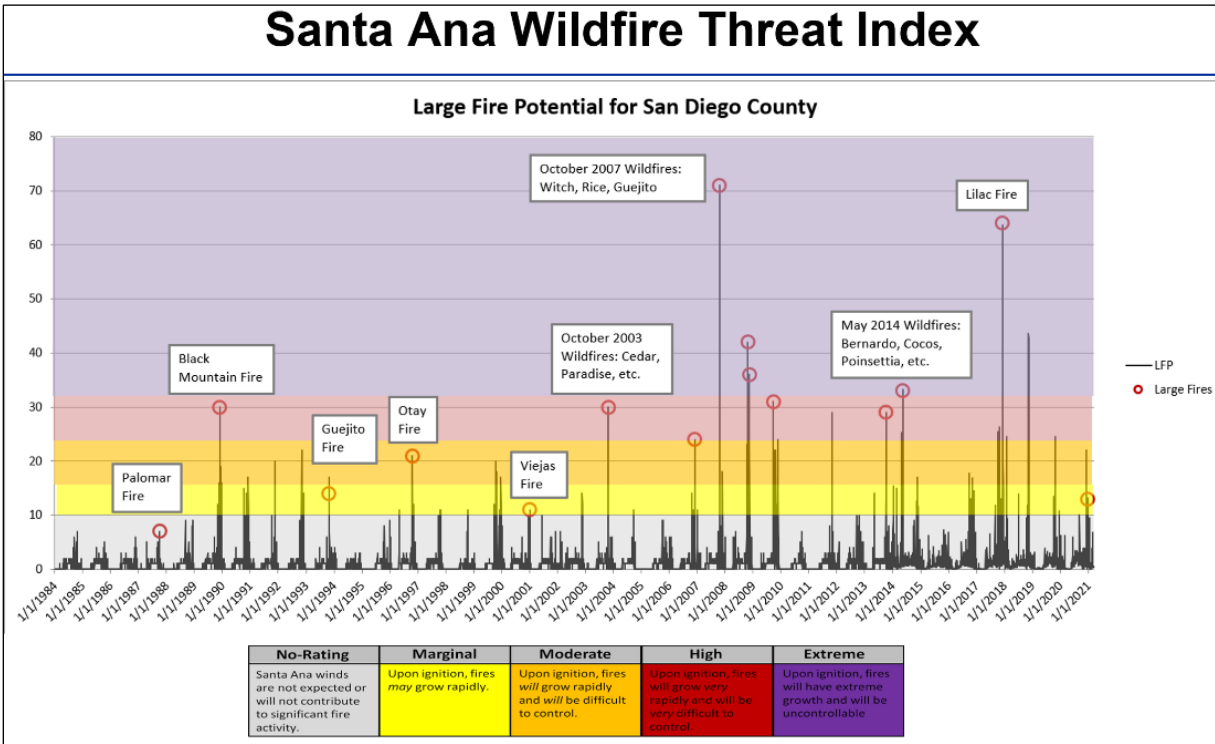

ML Wind Gust Forecast Model Reasoning

The ML wind gust forecast model was trained using the Random Forest algorithm with available observations collected from the surface weather network. This model also uses the popular XGBoost (eXtreme Gradient Boosting) algorithm to better capture the high wind days. Figure 8-37 demonstrates the validation of the ML gust forecast model.

The model validation proved successful at adding accuracy when applied to a sample of 15 weather stations for 22 RFW and/or Extreme FPI dates. An example of the validation (see in Figure 8-37) shows the observed observations (black), the WRF gust forecast (light blue) and the ML gust forecast model (red and green) for the West Alpine weather station. Each of the six boxes represents peak winds during a representative RFW and/or Extreme FPI date. The WRF model clearly over forecasts the wind gusts in all six scenarios and the ML gust.

Figure 8-37: Wind Gust Machine Learning Validation for West Alpine

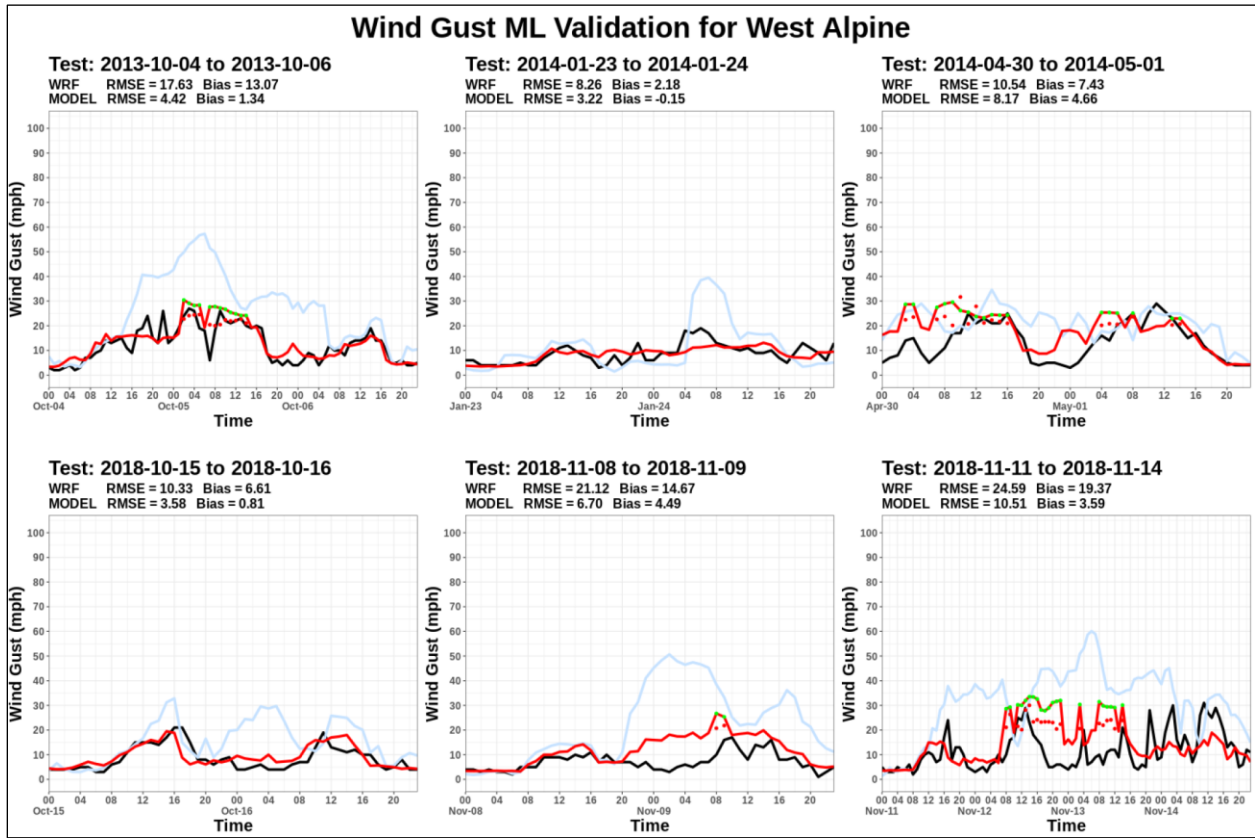

The ML Gust Forecast model has been an integral tool for understanding and forecasting small-scale, complex terrain-induced wind flow and for identifying areas where wind can reach critical and impactful magnitudes when numerous forcing scenarios are implemented. Figure 8-38 is a high-resolution ML gust forecast model output that highlights areas if critical wind flow based on specific forcing.

Figure 8-38: Example of ML Gust Forecast Model Output

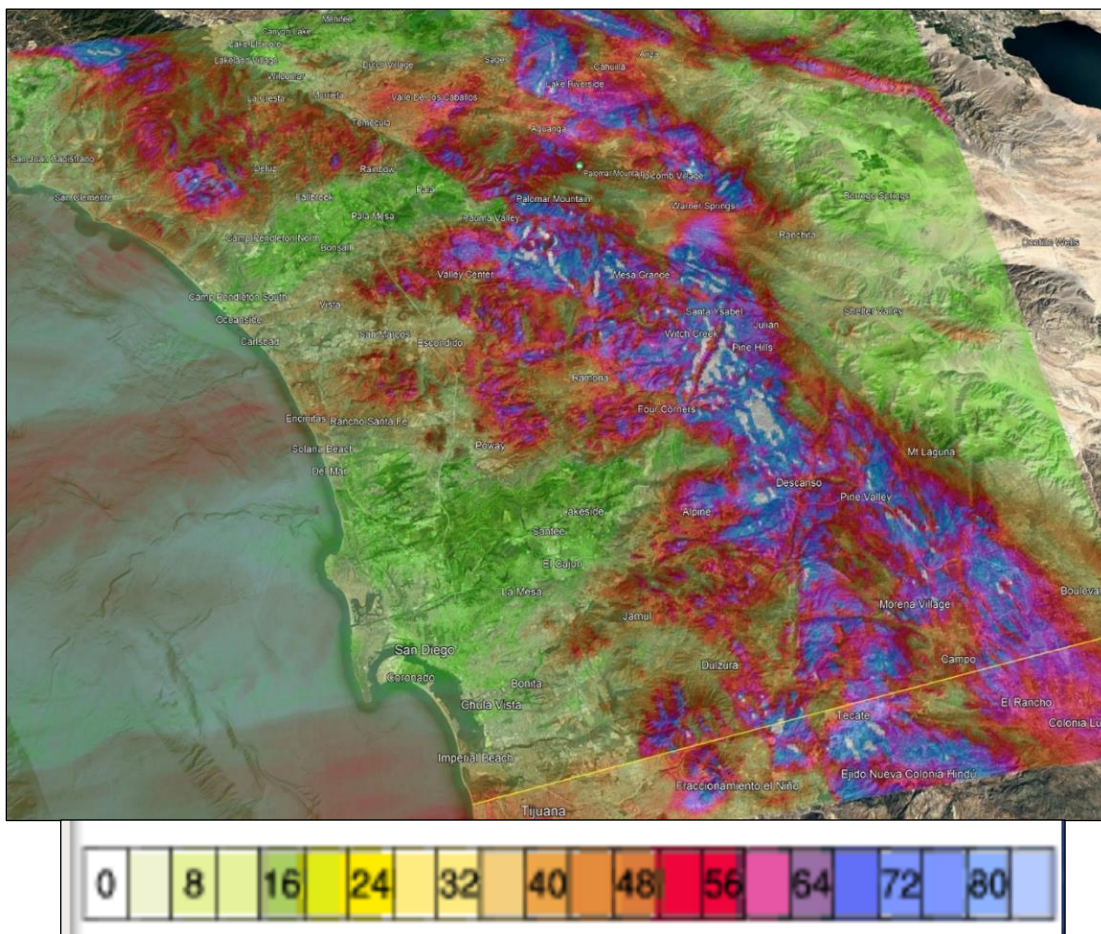

8.3.5.5 Enterprise System for Weather Forecasting

8.3.5.5.1 Database(s) Utilized for Storage

Meteorology owns and operates a mesonet, a mesoscale network of automated weather stations designed to observe mesoscale meteorological phenomena and climates. The mesonet is currently comprised of 216 pole mounted weather stations, as well as six RAWs. The weather data displayed includes wind speed, wind gust, wind direction, temperature, and relative humidity reported every 10 minutes with the capability to report every 30 seconds when needed. This allows real-time conditions to be monitored on every distribution circuit and transmission line across the fire-prone areas of the service territory. Weather Station Network data is stored on cloud sites with Western Weather Group Inc., MesoWest/SynopticLabs, and in the SCADA/PI system. The vendor has replication processes running supported by Microsoft.

Weather models are stored and run on high-performance computing clusters to generate high-quality weather data that is incorporated directly into operations. Collectively, nearly 2,000 compute core hours of high-performance computing are used per day to generate operational products, including the SAWTI (WMP.540), FPI (WMP.450), and WFA-E. The forecast data generated by these supercomputers is shared

with researchers and various stakeholders, including the U.S. Forest Service, which disseminates the data through their public website and the NWS. APIs enable public access to WMP-related datasets by authorized users for use in fire modeling.

8.3.5.5.2 Internal Documentation of Database(s)

Databases are documented internally, and externally (which is proprietary to the vendor).

8.3.5.5.3 Integration with Systems in other Lines of Business

The SAWTI (WMP.540) uses several meteorological and fuel moisture variables at a 2-km resolution as input to the WRF Model (WMP.532) to generate the index out to 6 days.

8.3.5.5.4 QA/QC or Auditing of the System

Weather Station Network

Meteorology oversees performing installations, relocations, calibrations, and data management on all weather stations. Measurements are validated manually by field calibration measurements. All weather stations are calibrated once per year. Meteorology also monitors the status of the network of weather stations and manually troubleshoots any weather station that reports “Caution” or “N/A”.

SAWTI (WMP.540)

SDG&E is responsible for providing all data inputs for the SAWTI. This includes the following:

- Sustained wind speed at 10 m
- Dew Point Depression at 2 m
- DFM for the 10-hour time-lag
- DFM for the 100-hour time-lag
- Energy Release Component
- LFM in new growth chamise
- NDVI
- State of Green-up of the annual grasses
- Fuel Moisture Component
- Large Fire Potential (weather component)
- Large Fire Potential (weather and fuels component)

Data is initially in a gridded format at hourly intervals at a 2 km horizontal resolution. It is then aggregated and averaged over each of the SAWTI zones before being transferred to the Predictive Services server. SDG&E is responsible for the integrity and the flow of this data to the server.

The US Forest Service, through Predictive Services, is responsible for the production and the dissemination of the SAWTI product. This includes ensuring that all data inputs are correct and making any adjustments when needed. The U.S. Forest Service is also responsible for periodically checking and adjusting, if necessary, SAWTI category thresholds for each zone.

SDG&E will continue to work with academia and the fire agencies to further develop fire science for integration into SAWTI. Data delivery process to the U.S. Forest Service was modernized. In 2023, the

resolution of the modeling used to generate the SAWTI will be increased, which will require re-coding of the software that processes the weather and fuels data.

8.3.5.5.5 Internal Processes for Updating Enterprise System Including Database(s)

Weather Station Network

Changes are created on vendor development systems, then demonstrated to relevant parties. When approved, updates are pushed to production by the respective IT teams for SDG&E or the vendor.

SAWTI (WMP.540)

The U.S. Forest Service is responsible for posting SAWTI information on Twitter.³⁴ The SAWTI application will automatically post to Twitter when any zone is forecast to be higher than a “No-Rating” during the 6-day period. These postings serve as a proxy for “push notifications” and are sent at the time the forecast is issued. There are currently over 1,600 followers on Twitter including several from the media.

The U.S. Forest Service is responsible for maintaining the server and all associated applications for the SAWTI through the Geospatial Technology and Applications Center (GTAC). This includes ensuring all cybersecurity standards are maintained and keeping the webpage functioning as well as updating any pertinent code as needed.

8.3.5.5.6 Changes to the Initiative since the Last WMP Submission

There were no changes since the 2022 WMP submission.

8.3.6 Fire Potential Index (WMP.450)

8.3.6.1 Existing Calculation Approach and Use

When an ignition occurs, the potential for it to develop into a wildfire depends on many variables. The FPI (WMP.450) was developed to communicate the wildfire potential on any given day to promote safe and reliable operations. This 7-day forecast product, produced daily, classifies the fire potential based on weather and fuels conditions and historical fire occurrences.

The FPI reflects key variables such as the state of native grasses across the service territory (“green-up”), fuels (ratio of DFM component to LFM component), and weather (sustained wind speed and dew point depression). Each of these variables is assigned a numeric value and those individual numeric values are summed to generate a Fire Potential value from 0 to 17, each of which expresses the degree of fire threat expected for each of the 7 days included in the forecast. The numeric values are classified as “Normal”, “Elevated”, and “Extreme”.

The FPI values and their usefulness were validated by recreating historical values for the past 10 years. The historical results bore a very strong correlation to actual fire events in terms of the severity of past fires and, in particular, provided accurate information as to when the risks of uncontrolled and large-scale wintertime fires were high.

This information is also modeled daily on SDG&E computers for integration into fire behavior and fire potential tools. When incorporating DFM into the FPI, 10-hour fuel moistures are integrated because

³⁴ X (formerly Twitter), SAWTI Forecast, available at @sawti_forecast

this number best represents the dead fuel component of the chaparral that drives the most extreme wildfires. The dead fuel component is considered extreme when the measurements fall below 6 grams. Dead fuels are wildland fuels whose moisture contents are controlled exclusively by changing weather conditions. Examples include dead herbaceous fuels, dead roundwood, fallen dead leaves and needles, and the litter of the forest floor. Dead fuels are divided into four “timelag” categories: 1-hour, 10-hour, 100-hour, and 1000-hour fuels. The shorter the timelag, the more responsive the fuel is to changing weather conditions. For example, 1-hour fuels only take on the order of one hour to respond to changing weather conditions, which explains why fire danger can be very high even right after a heavy rain if the subsequent weather conditions allow the 1-hour fuels to dry out. Samples are taken from standing dead trees, shrubs, or grasses. DFM can also be calculated from observed or forecast weather data. Model calculations of 1-hour, 10-hour, 100-hour, and 1000-hour fuel moisture are routinely made at SDG&E. The FPI uses 10-hour DFM inputs and the values can range from 1 percent to 60 percent. Ten-hour fuels are smaller diameter dead fuels in the 0.25 inch to 1 inch diameter range.

For details on the existing calculation approach and use see Appendix B.

OEIS Table 8-32: Fire Potential Features

Feature Group	Feature	Altitude	Description	Source	Update Cadence	Spatial Granularity	Temporal Granularity
Fuel Moisture	Dead Fuel	Ground	Ten-hour fuels are 0.25 inch to 1 inch in diameter	Remote Automatic Weather Stations (RAWS)	Hourly	2km grid	Hourly
Fuel Moisture	Live Fuel	Ground	Moisture content within living vegetation	US Forest Service	Bi-Monthly	National Forests	Bi-Monthly
Fuel Moisture	Grass	Space	Normalized Difference Vegetation Index (NDVI)	NASA MODIS Planet Labs	Weekly	250 m 3.7m	Daily

8.3.6.1.1 Efficacy Study: Determination of Average Distribution Ignition Percentages by Location and Operating Risk Condition

The purpose of this study was to determine the average distribution ignition percentages by location (e.g., non-HFTD, Tier 2 of HFTD, and Tier 3 of HFTD) and by operating risk condition (e.g., when the FPI rating is Normal, Elevated, or Extreme). The risk of ignition is greater in the HFTD and in elevated and extreme operating conditions. By comparing risk events to ignitions tranced by different locations and operating conditions, the difference in risk in terms of ignition probability can be quantified. This also has the additional benefit of providing ignition percentage values for the purposes of improved RSE calculations and improved risk modeling.

The results of this study validate certain assumptions about the PoI (see SDG&E Table 8-35). Over the last 5 years:

- A fault in the HFTD was more likely to cause to an ignition than a fault in the non HFTD.
- A fault in the HFTD during a day with an FPI of Extreme was more likely to cause an ignition than on a day with an FPI of Normal.

While ignition probability has historically been higher in Tier 2 than Tier 3, this does not take into account the risk of an ignition to develop into a fire of consequence. Even though the ignition probability is shown to be higher in Tier 2, the risk of wildfire is higher in Tier 3 due to the impact of the risk equation.

SDG&E Table 8-35: 5-Year Average Ignition Rate

Location	Normal FPI	Elevated FPI	Extreme FPI	All FPI
Non-HFTD	0.88%	2.15%	0.00%	1.13%
Tier 2	1.37%	3.57%	12.90%	2.55%
Tier 3	1.28%	4.99%	10.53%	2.91%
System	1.03%	3.35%	7.59%	1.79%
HFTD (Tier 2 and Tier 3)	1.32%	4.26%	12.00%	2.72%

To validate the FPI, it was calculated using historical weather and fuels data and then compared to historical fires in the service territory. As the FPI value increased, so did the occurrence and severity of large fires. Figure 8-39 shows the calculated FPI rating and major wildfires that occurred from 2002 to 2021. Large, destructive fires occurred at FPI values of 14 and above.

Figure 8-39: Historical Major Wildfire Correlation to FPI

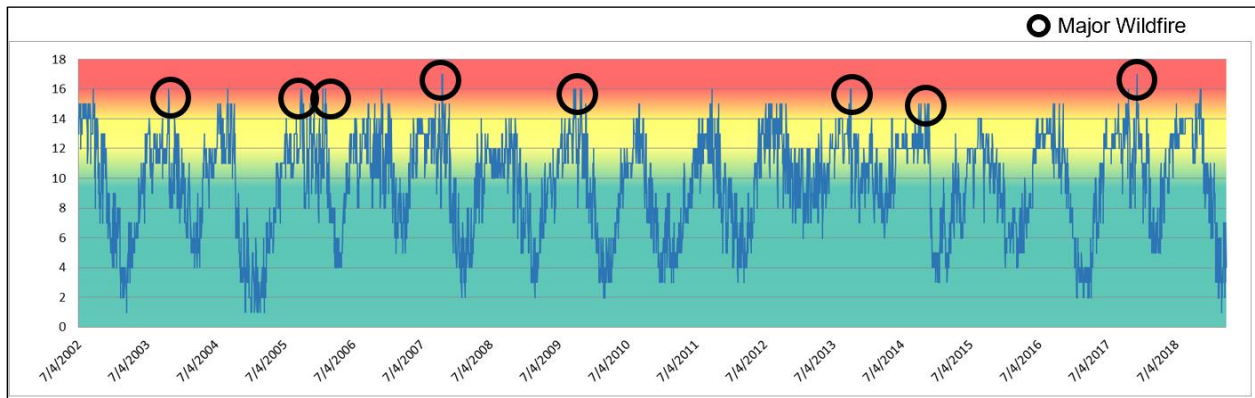

The FPI is issued and validated daily using representative weather stations for wind speed, dewpoint depression, and DFM observations. Satellite data of NDVI is used to validate the greenness of the grass, and local LFM measurements are used to validate LFM. The actual (validated) FPI is recorded daily and can be used to compare to the predicted FPI.

The FPI annualized success rate verified with in-situ observations was between 76 percent and 86 percent for all eight operational districts in 2022. The FPI is formulated to detect weather and fuel conditions in the forecast that resemble those associated with previous major wildfires events, and its daily calculation is shared broadly with the community.

8.3.6.2 Known Limitations of Existing Approach

There is a necessary assumption that the weather and fuels forecast will be accurate and also that the fuel types and terrain characteristics are homogeneous. The result is a blanket FPI applied over a spatially diverse district.

While the FPI has undergone verification and validation studies, there is some uncertainty regarding the specific weight of the FPI components within the formula. The projected FPI is based on a forecast model, which inherently produces uncertainty.

There are several limitations to this approach:

- The NDVI is measured from space by (MODIS, a key instrument aboard the Terra and Aqua satellites that views the entire Earth's surface every 1 to 2 days. Both satellites are at the end of their respective service life. Additionally, the 250-meter resolution is not high resolution by today's standards and could be improved.
- DFM is measured at a handful of RAWS that are representative of the DFM in the 8 operating districts.
- LFM information is sampled by the U.S. Forest Service and the data also covers large areas of the service territory.
- Modeling the fuels information into the future is at a 2 km grid spacing.

Reference Appendix B for additional information.

8.3.6.3 Planned Improvements

Operational decision making will continue to integrate the FPI in operations in order to mitigate wildfire potential. Additionally, the accuracy and efficacy of the model will continue to be improved with a specific goal of providing higher-resolution inputs for all four components of the FPI. For example, in late 2023, a new operational WRF model (WMP.532) will have a resolution of 1.5 km, improving the weather and dead fuels moisture components. In addition, an ongoing contract with Planet, the industry leader in remote sensing, will allow for 3.7 m resolution NDVI as an input to the FPI, which currently has a resolution of 250 meters. This will improve the measures of the grass health in the service territory. Finally, ongoing research and development with San Jose State University will help to improve LFM modeling through the integration of multiple new datasets.

Future improvements this initiative include over the 2023 to 2025 WMP cycle include:

- Continue partnerships with academia to work to advance fire science and weather science.
- Improve the inputs and outputs of the FPI, which may impact operational decision making.
- In 2023, continue to install DFM sensors on existing weather stations where fuel moisture data is sparse. A partnership with San Jose State University is currently in place to improve LFM models that provide input into the FPI calculation.
- Implement the new operational 1.5 km WRF configuration upgraded from the current 2 km resolution and update all downstream indices (FPI, SAWTI) from the lower resolution WRF output.
- Update the NDVI ML models by identifying the grassland sites across the domain and gathering up-to-date NDVI observations for the grassland sites.
- The NDVI is now being measured from space by Planet at a resolution of 3.7 meters. However, more data needs to be accumulated before making algorithm changes to the FPI.

Beyond the 2023 to 2025 WMP, SDG&E will continue to learn and improve. Predictors that contribute to the FPI will continue to be enhanced, including LFM and green-up, to modernize the data inputs and better leverage the high-performance computing environment to generate the product.

8.4 Emergency Preparedness

8.4.1 Overview

SDG&E engages in proactive planning and preparedness efforts to respond effectively to all hazards the Company may encounter. These efforts are informed by SDG&E's Risk Registry and take into account risks caused or increased by climate change. The Company Emergency and Disaster Preparedness Plan (CEADPP) was developed as a guide to govern emergency response efforts, including Wildfire and PSPS emergency preparedness. This plan supports and is part of the overall emergency response plan framework.

SDG&E engages in proactive planning and preparedness efforts to respond effectively to hazards the Company may encounter. The Public Safety Partner Portal (PSPP) was developed as a one stop shop for PSPS related information and resources. In 2022, a mobile app version was developed to further support timely collaboration and coordination with our public safety partners during PSPS events.

The Wildfire Safety/PSPS Community Awareness campaign educates customers and the general public about the risk of wildfires and PSPS events and provides encouragement to take preparedness measures such as updating their profile contact information and signing up for notifications. During PSPS events, notifications, media updates, in-community signage, and situational awareness postings are used across social media and social media kits are shared with community partners to reach a broad audience. Additionally, affected customers and the public are provided with the latest real-time updates and notifications during a PSPS event. Key communications are available in 22 prevalent languages.

Prior to the conclusion of a PSPS event, a patrol and restoration plan is created which identifies the expected times when various sections of the electric system are forecasted to be safe to perform a visual patrol to identify any damage and if no damage is present, restore power. The plan allows for timely resourcing to minimize time needed to safely restore customers and also optimizes any constrained resources to ensure they are deployed in a way that optimizes service restorations.

SDG&E provides assistance and resource access to those who are directly impacted by wildfires and/or PSPS events. Customers eligible for wildfire residential and non-residential customer protections are those identified as directly impacted by wildfires or who have self-reported as being impacted. Directly affected customers include those without electric service or those needing to re-locate (either temporarily or permanently) due to wildfire damage.

Emergency residential and non-residential customer protections are provided for wildfire victims, as ordered by the CPUC.³⁵ Examples of protections include billing adjustments, deposit waivers, extended payment plans, suspension of disconnection and nonpayment fees, and specific support for low-income and medical baseline customers.

³⁵ SDG&E filed Advice Letter 3177-E/2645-G on January 26, 2018 in compliance with Resolution M-4835 dated January 11, 2018, which was approved on February 21, 2018 and made effective December 7, 2018. See also CPUC Decisions D.19-05-039 and D.19-07-015.

8.4.1.1 Objectives

OEIS Table 8-33: Emergency Preparedness Initiative Objectives (3-year plan)

Objective Number	Objectives for Three Years (2023–2025)	Applicable Initiative(s), Tracking ID(s)	Applicable Regulations, Codes, Standards, and Best Practices (See Note) -	Method of Verification (i.e., program)	Completion Date	Reference (section & page #)
8.4.01	Modernize and enhance workforce training in the areas of storm response, process, and documentation (collab with DOC-E and ERO)	Emergency Response Wildfire/PSPS exercise and training, WMP.526	<ul style="list-style-type: none"> • Training of EOC responders; Electric Regional Operations/Electric Distribution Operations are primary owners 	Updated emergency response training curriculums; training records including completion rates	6/30/2024	8.4.2.1.3, p. 351
8.4.02	Expand Emergency Management Operations by increasing staff dedicated to enhancing various emergency programs.	Watch Command Desk, WMP.1335	<ul style="list-style-type: none"> • GO 166 • CPUC OIRs • Safety Management System (SMS) Continuous Improvement Plan • Emergency Management Accreditation Program (EMAP) standards 	PSPS Coordination: Regulatory Compliance Each month a report ID produced for computer tests and dashboards are tested daily through automated smoke tests	6/30/2025	8.4.2.2.1, p. 352
8.4.03	Establish or Commission a 24/7 Watch Command Desk	Watch Command Desk, WMP.1335	<ul style="list-style-type: none"> • Best practice among other utility emergency management programs 	Implementation of the watch desk	12/31/2025	8.4.2.1.1, p. 347
8.4.04	Enhance Human Factors Engineering (HFE) into the design of current and future PSPS decision making tools	Watch Command Desk, WMP.1335	<ul style="list-style-type: none"> • Best practice among agencies for decision making 	Updated dashboards	12/31/2099 (Ongoing)	8.4.3.1, p. 371
8.4.05	Continue participation and support of Mutual Assistance Programs	Preparedness and planning for service restoration, WMP.1009	<ul style="list-style-type: none"> • 4 agreements (CUEA, AGA, EEI, WRMAA) 	Continuation of agreements and collaborative engagements with other IOUs	12/31/2099 (Ongoing)	8.4.3.3, p. 377
8.4.06	Continue engaging Human Engineering to develop a dashboard and workflow for wildfire/PSPS notifications	Watch Command Desk, WMP.1335	<ul style="list-style-type: none"> • Best practice among agencies for decision making 	Updated dashboards	6/30/2024	8.4.3.1, p. 371

Objective Number	Objectives for Three Years (2023–2025)	Applicable Initiative(s), Tracking ID(s)	Applicable Regulations, Codes, Standards, and Best Practices (See Note) -	Method of Verification (i.e., program)	Completion Date	Reference (section & page #)
8.4.07	Continue collaboration with 211 in San Diego and Orange County to support AFN customers	Public outreach and education awareness program, WMP.527	<ul style="list-style-type: none"> D.21-06-034 Phase 3 Guidelines MBL and AFN Communities, Pg. A9 	Regional working groups Tabletop exercise participation PSPS Portal access and training	12/31/2099 (Ongoing)	8.4.3.4, p. 379
8.4.08	Enhance community outreach by incorporating effectiveness outreach survey feedback, expanding Tribal and AFN campaigns, enhancing partnerships with Indian Councils, Community Based Organizations (CBOs), and local school districts	Public outreach and education awareness program, WMP.527	<ul style="list-style-type: none"> PSPS OIRs 	Annual customer research is used to improve and simplify public-education messaging and outreach efforts with customers, AFN and tribal communities and CBOs.	12/31/2099 (Ongoing)	8.4.4.1, p. 381
8.4.09	Continue maintenance of emergency response plans using an ICS structure and process	Emergency preparedness plan, WMP.1008	<ul style="list-style-type: none"> GO 166 GO 112F PSPS OIRs 	Regulatory compliance	12/31/2099 (Ongoing)	8.4.2.1, p. 347
8.4.10	Add one new state-of-the-art Tactical Mobile Command Trailer to the emergency fleet	Watch Command Desk, WMP.1335	<ul style="list-style-type: none"> Best practice among first responder entities utilizing the Incident Command System (ICS) 	Mobile command resource available for deployment for field incident support	6/25/2025	8.4.2.1.1, p. 347
8.4.11	Put two new state-of-the-art Incident Support Vehicles in service to support existing fleet in field incidents	Watch Command Desk, WMP.1335	<ul style="list-style-type: none"> Best practice among first responder entities utilizing the ICS 	Mobile command resources available for deployment for field incident support	12/31/2025	8.4.2.1.1, p. 347
8.4.12	Create new repository (software solution) for AARs (platform to share with Safety Services). Accessible to others to interact.	Public outreach and education awareness program, WMP.527	<ul style="list-style-type: none"> Best practice Gas Safety Standard Safety Management System (SMS) Continuous Improvement Plan HSEEP 	Operational unit and EOC stakeholders have accessibility to exercise and real-world incident/event corrective actions	12/31/2024	8.4.2.1.5, p. 351

Objective Number	Objectives for Three Years (2023–2025)	Applicable Initiative(s), Tracking ID(s)	Applicable Regulations, Codes, Standards, and Best Practices (See Note) -	Method of Verification (i.e., program)	Completion Date	Reference (section & page #)
			<ul style="list-style-type: none"> Emergency Management Accreditation Program (EMAP) standards 			
8.4.13	Enhance collaboration and engagement with public safety partners and the community through the use of the new Wildfire & Climate Resiliency Center (WCRC)	Public outreach and education awareness program, WMP.527	<ul style="list-style-type: none"> Best practice 	WCRC is open and tours are being scheduled and conducted	9/30/2024	8.4.3.2, p. 373

OEIS Table 8-34: Emergency Preparedness Initiative Objectives (10-year plan)

Objective Number	Objectives for Ten Years (2026–2032)	Applicable Initiative(s), Tracking ID(s)	Applicable Regulations, Codes, Standards, and Best Practices (See Note)	Method of Verification (i.e., program)	Completion Date	Reference (section & page #)
8.4.14	Increase stakeholder engagement and use of simulations to stress-test all-hazards response plans	External collaboration and coordination, WMP.1201	<ul style="list-style-type: none"> Best Practice CPUC PSPS Exercise Requirements Company objectives satisfaction 	HSEEP-guided exercise planning practices, Integrated Preparedness Plan adherence, Hotwashes and AAR Participation	12/31/2099 (Ongoing)	8.4.3.2, p. 373
8.4.15	Develop Training Environments to better simulate all hazards and allow for more realistic exercises and training.	Emergency Response Wildfire/PSPS exercise and training, WMP.526	<ul style="list-style-type: none"> Best Practice: HSEEP 	HSEEP-guided exercise planning practices, Integrated Preparedness Plan adherence, Hotwashes and AAR Participation	12/31/2099 (Ongoing)	8.4.2.1.5, p. 351
8.4.16	Establish more formalized review of operating procedures, benchmarking, and stakeholder engagement	Public outreach and education awareness program, WMP.527	<ul style="list-style-type: none"> Best practice; Emergency Management Accreditation Program (EMAP) standards 	Formalized review process, benchmarking, and engagement	9/30/2026	8.4.3.2, p. 373
8.4.17	Augment the CEADPP to include specific plans/conops/annexes based on the appropriate identified risks	Emergency preparedness plan, WMP.1008	<ul style="list-style-type: none"> Best practice; EMAP standards 	Development of plans/conops/annexes based on needs	12/31/2099 (Ongoing)	8.4.2.1.1, p. 347

Objective Number	Objectives for Ten Years (2026–2032)	Applicable Initiative(s), Tracking ID(s)	Applicable Regulations, Codes, Standards, and Best Practices (See Note)	Method of Verification (i.e., program)	Completion Date	Reference (section & page #)
8.4.18	Enhance customer communication and ability to reach vulnerable populations during emergencies	Public outreach and education awareness program, WMP.527	<ul style="list-style-type: none"> • D.20-05-051, Appendix A, page 8: Medical Baseline and Access and Functional Needs Populations • D.20-06-003, Pg. 153, Ordering Paragraph 39 • AFN Statewide Advisory: Influenced the dashboard development, encouraged by D.20-05-051 	<p>AFN Self-Identification campaign</p> <p>AFN flags to identify vulnerable populations in the customer information database</p> <p>Customer outreach campaign for MFH building owners, Mobile Home Park Managers, tenants, IHSS</p> <p>AFN Dashboard</p>	12/31/2099 (Ongoing)	8.4.2.1.7, p. 351
8.4.19	Enhance post event documentation and application of lessons learned to update plans and exercises.	Protocols in place to learn from wildfire events, WMP.1010	<ul style="list-style-type: none"> • D.21-06-014, Page 300, Ordering Paragraph 54 • D.21-06-034 Phase 3 Guidelines MBL and AFN Communities, Pg. A14 • D.20-05-051 Phase 2: Appendix 8, Pg. 1, (a) Working Groups and Advisory Boards 	<p>Agendas:</p> <p>Bi-Weekly AFN Planning Meeting</p> <p>San Diego Regional PSPS Working Group</p> <p>Statewide AFN Advisory Council</p> <p>Reporting:</p> <p>PSPS Pre-Season Report</p> <p>Lessons Learned:</p> <p>Integration of findings/areas of improvement into PSPS exercises and EOC responder training.</p>	12/31/2099 (Ongoing)	8.4.3.1, p. 371

8.4.1.2 Targets

OEIS Table 8-35: Emergency Preparedness Initiative Targets by Year

Initiative Activity	Tracking ID	2023 Target & Unit	% Risk Impact 2023	2024 Target & Unit	% Risk Impact 2024	2025 Target & Unit	% Risk Impact 2025	Method of Verification
Emergency Response Wildfire/PSPS exercise and training	WMP.526	To ensure readiness, Wildfire/PSPS response teams will participate and recertify by 9/1 annually	n/a	To ensure readiness, Wildfire/PSPS response teams will participate and recertify by 9/1 annually	n/a	To ensure readiness, Wildfire/PSPS response teams will participate and recertify by 9/1 annually	n/a	Responder Training Roster
CEADPP updated per changes in procedures, conditions, law, or Commission policy	WMP.1008	Submit CEADPP updates as part of the annual report required by Standard 11 by 12/30	n/a	Submit CEADPP updates as part of the annual report required by Standard 11 by 12/30	n/a	Submit CEADPP updates as part of the annual report required by Standard 11 by 12/30	n/a	Filing of the Annual Report to the CPUC

8.4.1.3 Performance Metrics Identified by the Electrical Corporation

OEIS Table 8-36: Emergency Preparedness Performance Metrics Results by Year

Performance Metrics	2020	2021	2022	2023 Projected	2024 Projected	2025 Projected	Method of Verification (e.g., third-party evaluation, QDR)
Percentage of community partners participating in local wildfire mitigation planning (in territory)	n/a	n/a	n/a	90%	90%	90%	QDR
Percentage of Wildfire/PSPS events followed by an After-Action Review or feedback process	n/a	n/a	n/a	95%	95%	100%	QDR

8.4.2 Emergency Preparedness Plan

The CEADPP, dated 12/28/2021, was established to provide an all-hazards strategic framework that SDG&E personnel may rely on to respond effectively using the Incident Command System (ICS) and National Incident Management System (NIMS), (ICS-NIMS) required by federal and state mandates.

This plan has been developed, updated, and maintained in compliance with CPUC GO 166 as modified by D.98-07-097, D.00-05-022, D.12-01-032 and D.14-05-020. Reference Section 1.4 Privacy Statement on page 3.

- The CEADPP, Second Edition, dated 12/28/2021

8.4.2.1 Overview of Wildfire and PSPS Emergency Preparedness

8.4.2.1.1 Purpose and Scope of the Plan

The CEADPP addresses emergency preparedness, crisis management, and business resumption planning to provide for the safety of employees, contractors, customers, the public, and for protection of property in the event of an incident affecting employees, contractors, customers, or other stakeholders.

The CEADPP may be activated during business hours and/or after hours, both with or without warning. The foundation of this plan utilizes existing company work structure and responsibilities to minimize specialized training to the plan's preparedness and response procedures. It relies on the changes to normal organizational leadership structure during an emergency activation into an ICS-NIMS to maintain chain of command and span of control principles for crisis management required in the NIMS protocols.

Utilizing the 14 NIMS management characteristics, the CEADPP provides a framework for effective company-wide responses to any threats or hazards. Reliance on the guidance, processes, checklists, and other job aids found in the CEADPP helps minimize response times and provides for effective response and communications with the public and stakeholders during an incident.

The CEADPP supports an all-hazards approach to incident response. As described by the Department of Homeland Security (DHS), all-hazards emergency management considers the hazards and incidents that the entity may encounter. Emergency Management must be able to respond to natural and manmade hazards, homeland security-related incidents, and other emergencies that may threaten the safety and well-being of citizens and communities. An all-hazards approach to emergency preparedness encourages effective and consistent response to any condition, emergency, disaster, or catastrophe, regardless of the cause.

Unlike government agencies, a public utility company is not responsible for public safety threat hazard mitigation. The all-hazard plans developed through the Joint Powers Act of San Diego County and associated municipalities responsible for public safety are adopted and their risk and hazard threats plans are incorporated as applicable. SDG&E responsibilities for risk and hazards include developing the plans and response capabilities to protect the public from risks posed by the utility electric/gas commodities, protect the workforce and, as efficiently and effectively as possible, and maintain or restore services to the community provided by SDG&E. Soon Emergency Management will increase granularity and customization of response and response plans.

Future initiatives include a 24/7 Watch Command Desk, two Incident support vehicles, and one new state-of-the-art Tactical Mobile Command Trailer (WMP.1335). The 24-hour, 7 day-a-week Watch Command Desk will ensure consistent and timely information monitoring of all hazards and real-time assessing of risk impacts to assets, customers, and employees. The impetus of the program is to reduce potential redundancies with multiple people gathering information, missed issues or information, or an inconsistent notification process. To ensure more effective and efficient situational awareness across regional, national, and global information sources, SDG&E has included funding requests and resources in the upcoming General Rate Case to implement a 24/7 Watch Desk program. The Tactical Mobile Command Trailer and additional support vehicles will be available resources for deployment for field incident support.

8.4.2.1.2 Overview of Wildfire and PSPS Protocols, Policies, and Procedures

The company response may range from a simple executive notification of the incident, which usually can be accommodated within a few days by field crews, to an EOC activation Level 1 which may need external mutual assistance and months to restore. EOC activation levels are determined by the authority, skill-level, and company resources required to effectively manage incidents or events impacting the company. It is how the crisis management leadership group, and its staff, will expand to meet the response situation. EOC activation levels are summarized below and in Figure 8-40.

- Level 5 (Green): Executive Notification, EOC not activated
- Level 4 (Blue): Active Monitoring, EOC activated with minimal targeted responders
- Level 3 (Yellow): Serious, Partial or Full EOC activation
- Level 2 (Orange): Severe, Full EOC Activation including the Executive Management Team (EMT)
- Level 1 (Red): Catastrophic, Full EOC activation and Sempra executive Crisis Management Center Coordination

The EOC moves between various phases before, during, and after an event. The phases are Preparedness, Alert Monitoring, Response, Re-Energization, and Recovery. Figure 8-41 outlines the EOC activation levels for each phase and high-level actions taken.

EOC personnel are activated based on event needs and requirements. Personnel can be deactivated on the authority of the officer in charge (OIC) once the threat and activation criteria has subsided. This assessment is based on the level of threat of SDG&E's commodity assets which could affect public safety/property damage and sufficient repair of the assets to provide restoration of services to the public.

Figure 8-40: EOC Activation Levels

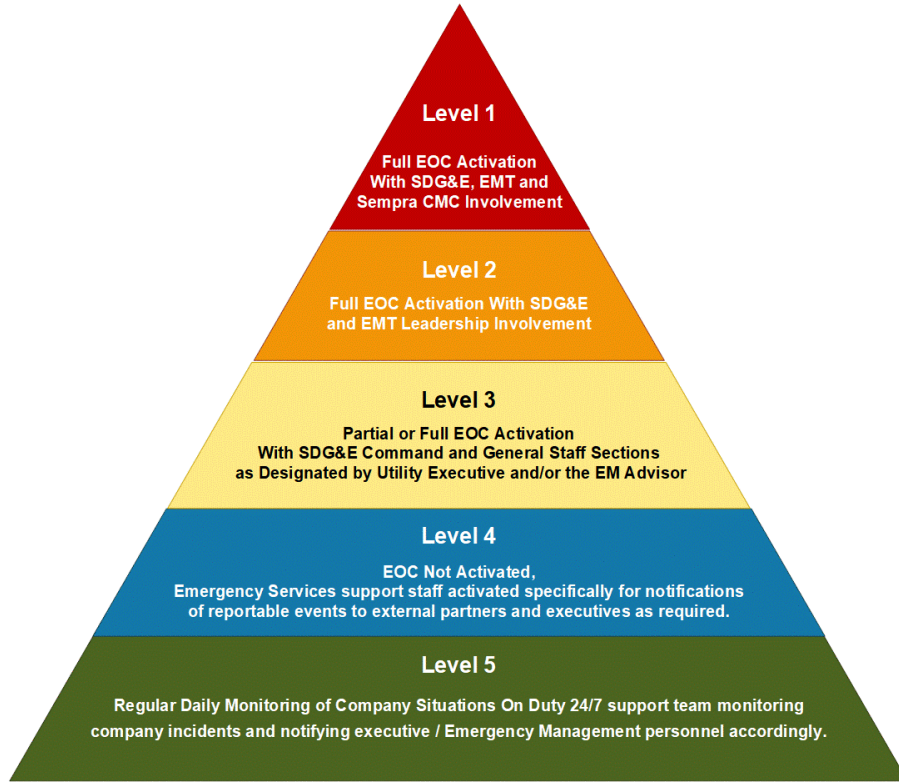
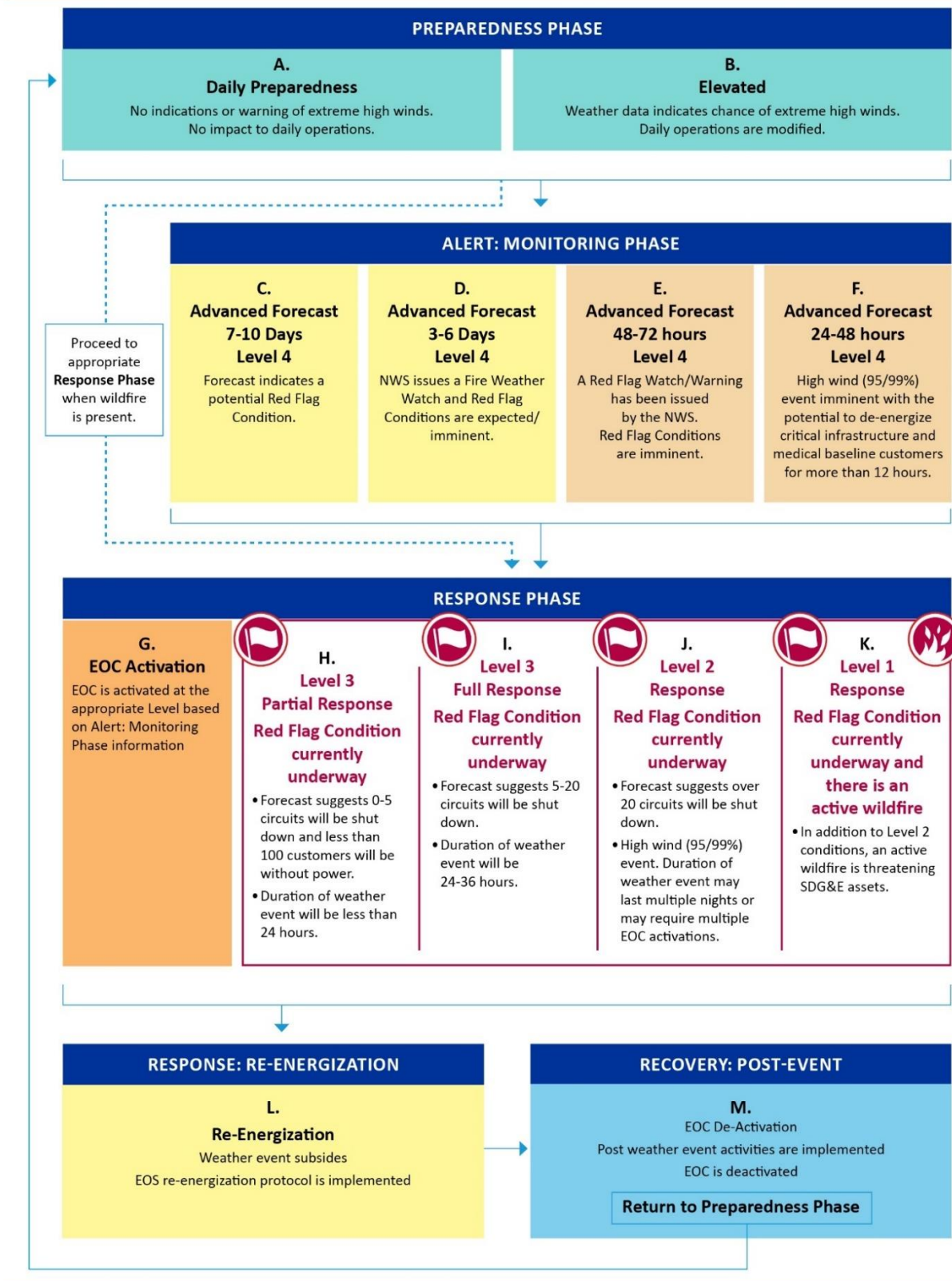

Figure 8-41: SDG&E Response Phases



8.4.2.1.3 Key Personnel, Qualifications, and Training

Employee and public safety are paramount to operations. For this reason, a comprehensive training program has been implemented to support outage restoration, patrols, inspections, and maintenance as part of SDG&E's CMP and QC program to reduce system impacts, promote public safety, and reduce the risk of wildfire.

Training and tabletop exercises are provided to operational leadership and field employees, including qualified Electric Troubleshooters, Fault Finders, and Line Crews. These individuals respond to events impacting the electric system and may work side-by-side with other first responders.

Electric Regional Operations integrates various levels of ICS training in support of storm response and PSPS event response into all aspects of Electric Operations, including Management and Supervisor ranks, line assistant curriculum, lineman apprentice program, Electric Troubleshooters, and Fault Finder training.

8.4.2.1.4 Resource Planning and Allocation

Emergency Management personnel are assigned EOC and Emergency On-Duty (EOD) Officer roles and responsibilities that expand according to the fixed activation level functions in the EOC (see Figure 8-40). These are pre-assigned and are activated according to the defined scope and magnitude of the incident. There are additional pre-assigned support functions that are manned by other departments as the magnitude of an event expands.

8.4.2.1.5 Drills, Simulations, and Tabletop Exercises

Within Emergency Management, the Training & Exercise Team designs and conducts exercises to validate plans and access response capabilities. Utilizing the Homeland Security Exercise and Evaluation Program (HSEEP) Doctrine, the team conducts multiple annual exercises at varying levels from field responders to EOC staff and executive leadership. Annually, PSPS exercises are conducted at both the EOC and District level as well as in San Diego County's annual Wildland Fire Exercise that includes first responders from multiple agencies. Exercises are evaluated and an AAR is developed by the Continuous Improvement Team so that lessons learned from exercises can be documented and improvements made prior to wildfire season. Futuristically, Emergency Management will create a new repository for AARs with Safety Services, making it accessible for others to interact.

8.4.2.1.6 Coordination and Collaboration with Public Safety Partners

Public safety partners are invited to participate in PSPS exercises and SDG&E regularly participates in exercises conducted by local jurisdictions and other public safety partners. In addition, the public safety partner portal allows for effective communication with Public Safety Partners (see Section 8.4.3.3 Mutual Aid Agreements).

8.4.2.1.7 Notification of and Communication during and after a Wildfire or PSPS Event

The Wildfire Safety Public Education and Outreach plan increases community resiliency to wildfires and mitigates the impact of PSPS events. The plan is divided into three phases: prior to, during, and following a wildfire or PSPS event.

Prior to an event, communication efforts focus on educating customers and the public. During an event, notifications, media updates, in-community signage, and situational awareness postings are used across social media and social media kits are shared with community partners to reach a broad audience. Additionally, affected customers and the public are provided with the latest real-time updates during a PSPS event. Key communications are available in 22 prevalent languages. After a wildfire or PSPS event, communications to customers and the general public are reviewed and evaluated. Feedback is then used to improve customer and public communications and outreach efforts for the following year. For details on the Wildfire Safety Public Education and Outreach plan see Section 8.5.2.1.

8.4.2.1.8 Improvements/Updates since the Last WMP Submission

Enhancements to CEADPP made in 2022:

- Updates to ensure compliance Emergency Management Accreditation Program (EMAP) standards
- Updated to ensure plan is all-hazards focused
 - Added threat/hazard specific annexes
- Updated to provide more detailed information on threat and hazard identification and assessment processes
- Updated and formalized the continuity of leadership for executives
- Updated the organization charts as we continue to implement companywide ICS

OEIS Table 8-37: Key Gaps and Limitations in Integrating Wildfire- and PSPS-Specific Strategies into Emergency Plan

Gap or Limitation Subject	Remedial Brief Description	Remedial Action Plan
Changing regulatory requirements	Constant changes in regulatory requirements make integrating wildfire- and PSPS-specific strategies into the CEADPP difficult. New regulations require additional planning and stakeholder engagement which takes time and effort.	Assign regulatory oversight to personnel in order to maintain continuous awareness of changing regulations and ensure incorporation into the CEADPP.

The CEADPP is an all hazards overarching plan that is inclusive of wildfire and PSPS. Additionally, for specific wildfire- and PSPS-related activities there is a separate wildfire and PSPS annex which is attached to the emergency plan.

8.4.2.2 Key Personnel, Qualifications, and Training

8.4.2.2.1 Personnel Qualifications (WMP.1335)

Incident response is a corporate and individual responsibility. Employees have an obligation to respond to incidents as directed by management. As a result, a significant number of employees are trained on and have been assigned response roles. Emergency Management is looking to expand personnel staff who will be dedicated to enhancing AAR programs, coordinating PSPS events, and developing technology solutions to support emergency operations. During emergencies and crises, these personnel may work extended hours to support 24-hour staffing. For purposes of this document, a response role is defined as a role or task that a person performs during an incident that is under Emergency Management supervision and/or of the EOC or utility OIC.

The incident management structure is designed to expand or contract to any given level as required by the emergency response and recovery. The event is evaluated to define how significant of a disruptive impact to the company's capability to safely provide its commodity services to our customers, proper workforce environment, infrastructure-facility- resources and meet our regulatory obligations. The larger the negative impact to these functions or disruption of services, the greater the resources required to repair or restore those services.

EOC personnel are selected for their role based on their qualifications and experience in the relevant business unit. Selected personnel for EOC positions complete an onboarding process that includes confirmation of completed training.

Emergency Management has the responsibility and authority to maintain ICS and California Specialized Training Institute (CSTI) training of the responders designated to support EOC activations. Currently there are approximately 400 responders, in addition to Company field responders, who support emergency response within the EOC.

EOC responders, prior to being active members of the EOC roster, must take the following courses: Federal Emergency Management Agency (FEMA) IS-100, FEMA IS-200, FEMA IS-700 and CSTI SEMS G606. The proof of training completion comes in the form of a certificate which is then stored in the responder record. In addition, all active EOC responders attend a Summer Readiness training which provides annual updates on projected weather and curtailment conditions as well as any changes to response procedures or systems. EOC leadership positions (Command and General Staff) also receive additional training towards achieving the California Specialized Training Institute's Utility Representative EOC position credential.

OEIS Table 8-38: Emergency Preparedness Staffing and Qualifications

Role	Incident Type	Responsibilities	Qualifications	# of Dedicated Staff Required	# of Dedicated Staff Provided	# of Contract Workers Required	# of Contract Workers Provided
Officer in Charge (Utility Incident Command)	All Hazards: EOC Activations Levels 3 and above	<ul style="list-style-type: none"> • Make corporate resource allocations and prioritization decisions between and among operational teams in coordination with Incident Commanders • Provide incident briefings to the Crisis Management Team (CMT) • Support coordination across activated response teams • Help ensure proper communication flow within the SDG&E response organization. • Monitor incident operations to identify current or potential organization problems • Identify the need to brief or convene the CMT. 	<ul style="list-style-type: none"> • Completion of responder courses: IS-100, IS-200, IS-700, and SEMS G-606 • Subject matter expertise in their daily role • Relevant professional experience as a Vice President or Officer in the Company 	4	4	n/a	n/a
Deputy Officer in Charge (Deputy Incident Command)	All Hazards: EOC Activations Levels 2 and above	<ul style="list-style-type: none"> • Coordinate with public and private utilities, including electric, gas, water, and waste to receive an assessment of the systems • Coordinate with utility companies to develop a restoration plan • Keep Operations Chief/Coord. and other appropriate EOC staff informed on status of involved utility field operations, including estimated restoration times provided by the impacted utility • Oversee Notification Group and community support services (AFN and CRCs) activities 	<ul style="list-style-type: none"> • Completion of responder courses: IS-100, IS-200, IS-700, and SEMS G-606 • Subject matter expertise in their daily role • Relevant professional experience as a Vice President or Officer in the Company 	4	7	n/a	n/a

Role	Incident Type	Responsibilities	Qualifications	# of Dedicated Staff Required	# of Dedicated Staff Provided	# of Contract Workers Required	# of Contract Workers Provided
		<ul style="list-style-type: none"> Review and approve EOC Action Plan Support the OIC, serve as stand in when needed, and manage operational elements when necessary 					
Safety Officer	All Hazards: EOC Activations Levels 3 and above	<ul style="list-style-type: none"> Arrange for subsequent shift relief Obtain information on employee injuries or deaths and other safety-related concerns or issues Update Safety Status Board Dispatch Safety personnel to injuries or deaths Help ensure state and federal safety requirements are observed in the field Coordinate safety-related regulatory reporting Coordinate distribution of Safety Bulletins 	<ul style="list-style-type: none"> Completion of responder courses: IS-100, IS-200, IS-700, and SEMS G-606 Subject matter expertise in their daily role Relevant professional experience within the safety department or safety roles at the company. 	4	6	n/a	n/a
Legal Officer	All Hazards: EOC Activations Levels 3 and above	<ul style="list-style-type: none"> Support OIC and IST members on legal issues that may arise during incident Lead certain incident investigations Participate in IST meetings and develop legal objectives Assess the legal ramifications of key issues/policies/plans as directed by the Officer in Charge Provide legal advice as requested 	<ul style="list-style-type: none"> Completion of responder courses: IS-100, IS-200, IS-700, and SEMS G-606 Subject matter expertise in their daily role Relevant professional experience within the legal department or within a legal role at the company. 	4	6	n/a	n/a
Regulatory Officer	All Hazards: EOC Activations Levels 3 and above	<ul style="list-style-type: none"> Notify CPUC of Activation/Deactivation 	<ul style="list-style-type: none"> Completion of responder courses: IS-100, IS-200, IS-700, and SEMS G-606 	6	12	n/a	n/a

Role	Incident Type	Responsibilities	Qualifications	# of Dedicated Staff Required	# of Dedicated Staff Provided	# of Contract Workers Required	# of Contract Workers Provided
		<ul style="list-style-type: none"> Provide update notifications per directions of the OIC and CPUC Policy 	<ul style="list-style-type: none"> Subject matter expertise in their daily role Relevant professional experience with a regulatory role at the company. 				
Emergency Management Advisor	All Hazards: EOC Activations Levels 3 and above	<ul style="list-style-type: none"> Initiate the Executive Briefing and support the OIC to help ensure processes and deliverables requested by OIC are complete Guide Executive Briefings, follow up with action items from the previous briefing period, and coordinate/support IST conference calls and meetings Help determine OIC priorities for each briefing period Summarize information presented by each functional group and present a recommendation and strategy for the OIC Document and manage actions taken outside of OIC priorities or action items Help ensure the Position Log and Group Report are being completed by the Strategic Leads Update OIC with status of actions items and maintains ongoing tracker documents Document discussions and action items 	<ul style="list-style-type: none"> Completion of responder courses: IS-100, IS-200, IS-700, and SEMS G-606 Subject matter expertise in their daily role Relevant professional experience as a leadership role within the Emergency Management Department. 	4	6	n/a	n/a

Role	Incident Type	Responsibilities	Qualifications	# of Dedicated Staff Required	# of Dedicated Staff Provided	# of Contract Workers Required	# of Contract Workers Provided
Liaison Officer	All Hazards: EOC Activations Levels 2 and above	<ul style="list-style-type: none"> Assume responsibility for safety, security, and staffing needs during an emergency incident Support the OIC to address emergency response activities and develop external outreach strategy Provide management and oversight of EOC External Affairs responders Utilize the internal communications staff to facilitate External Affairs activities Communicate activities to other Section Chiefs Identify significant events and post to Position Log Define priorities for Liaison Group Document assessment in the Situation Report Help ensure notifications are made (Municipalities, Tribes, Elected Officials, Regulatory, Claims, Emergency Services Reps) Update Situation Report based on current assessments and Group Report 	<ul style="list-style-type: none"> Completion of responder courses: IS-100, IS-200, IS-700, and SEMS G-606 Subject matter expertise in their daily role Relevant professional experience working with external partners at the Company. 	6	12	n/a	n/a
Public Information Officer (PIO)	All Hazards: EOC Activations Levels 3 and above	<ul style="list-style-type: none"> Assume responsibility for safety, security and staffing needs during an emergency incident Support the OIC to address Media Communications emergency response activities Provide management and oversight of EOC PIO Section responders 	<ul style="list-style-type: none"> Completion of responder courses: IS-100, IS-200, IS-700, and SEMS G-606 Subject matter expertise in their daily role Relevant professional knowledge of media relations, media, customer 	3	3	n/a	n/a

Role	Incident Type	Responsibilities	Qualifications	# of Dedicated Staff Required	# of Dedicated Staff Provided	# of Contract Workers Required	# of Contract Workers Provided
		<ul style="list-style-type: none"> • Gather assessment information on Communications issues • Communicate activities to other Section Chiefs and OIC • Obtain and validate assessment information included in the PIO section of Situation Update Report • Make sure information provided about the system and employees is validated and consistent across communication channels being used for the event • Help ensure OneVoice talking points are approved and disseminated to entire organization and external stakeholders as applicable • Manage press conference(s); serve as the liaison for external press conferences involving SDG&E • Follow up on and/or delegate out tasks in response to ad hoc social media, media, call center comment/requests that may be requested • Mitigate and respond to public concern, manage the situation and limit the negative reputational effects of the crisis. 	care, and internal communications within the Company.				
Electric Operations Commodity Liaison	All Hazards: EOC Activations Levels 3 and above	<ul style="list-style-type: none"> • Assume responsibility for Electric Operations Team safety, security, and staffing needs during an emergency incident 	<ul style="list-style-type: none"> • Completion of responder courses: IS-100, IS-200, IS-700, and SEMS G-606 • Subject matter expertise in their daily role 	8	11	n/a	n/a

Role	Incident Type	Responsibilities	Qualifications	# of Dedicated Staff Required	# of Dedicated Staff Provided	# of Contract Workers Required	# of Contract Workers Provided
		<ul style="list-style-type: none"> Serve as an Advisor to the OIC in the EOC and share information provided by the DOC-E/DOC-G as warranted. Provide management and oversight of EOC Electric Operations responders. Utilize the internal communications staff to facilitate Electric Operations support activities. Communicate activities pertaining to Electric Operations and brief other Section Chiefs on Points of Interest Update situation report. Track DOC-E Operational Plan Progress and discuss concerns with DOC-E 	<ul style="list-style-type: none"> Relevant professional experience with Electric Operations within the company. 				
Gas Operations Commodity Liaison	All Hazards: EOC Activations Levels 3 and above	<ul style="list-style-type: none"> Assume responsibility for Gas EOC overall operations and provide Priority Policy guidelines for Safety and Gas Emergency Develop an assessment report of damage to Gas Systems Transmission and Distribution Identify critical Gas Operations issues Resolve issues impacting Gas Operations Rep action plans Update Situation Report Keep the OIC informed of system conditions (distribution and transmission systems, gas supply, or gas curtailment) and restoration progress Provide management and oversight of EOC Gas Operations responders 	<ul style="list-style-type: none"> Completion of responder courses: IS-100, IS-200, IS-700, and SEMS G-606 Subject matter expertise in their daily role Relevant professional experience with Gas Operations within the company. 	8	15	n/a	n/a

Role	Incident Type	Responsibilities	Qualifications	# of Dedicated Staff Required	# of Dedicated Staff Provided	# of Contract Workers Required	# of Contract Workers Provided
		<ul style="list-style-type: none"> Utilize the internal communications staff to facilitate Gas Operations activities Communicate activities to appropriate Section Chiefs Help ensure support for the GEC is provided and help remove roadblocks Supply Gas Transmission Operations data required for reports to the Regulatory Representative 					
Customer Service Section Chief	All Hazards: EOC Activations Levels 3 and above	<ul style="list-style-type: none"> Assume responsibility for safety, security and staffing needs during an emergency incident Support the OIC to address emergency response activities Provide management and oversight of EOC Customer Service responders Ensure each representative arranges for required shift coverage and input them to roster Ensure that every position that has not been activated has an On Call person identified in roster Provide Customer Service Representatives with priorities Distribute talking points/press releases/ FAQs to the Customer Service EOC reps Utilize the internal communications staff to facilitate Customer Service activities Communicate activities to other Section Chiefs 	<ul style="list-style-type: none"> Completion of responder courses: IS-100, IS-200, IS-700, and SEMS G-606 Subject matter expertise in their daily role Relevant professional experience within Business Services or customer service roles within the company. 	10	18	n/a	n/a

Role	Incident Type	Responsibilities	Qualifications	# of Dedicated Staff Required	# of Dedicated Staff Provided	# of Contract Workers Required	# of Contract Workers Provided
		<ul style="list-style-type: none"> Identify critical Customer Service issues Update Situation Report Oversee customer notification process 					
Planning Section Chief	All Hazards: EOC Activations Levels 3 and above	<ul style="list-style-type: none"> Oversee the Planning Section and help ensure responders are fulfilling their duties Assist the Officer in Charge in maintaining situational awareness Assist in determining current incident objectives and strategy. Help ensure the development, continuous updating, execution and dissemination of EOC Action Plans (EAPs) Communicate/coordinate with other EOC Section Chiefs, DOCs, public safety partners, and regulatory agencies Help ensure that major items briefed in Policy room are shared with personnel in the main EOC. 	<ul style="list-style-type: none"> Completion of responder courses: IS-100, IS-200, IS-700, and SEMS G-606 Subject matter expertise in their daily role Relevant professional experience within the Emergency Management Department. 	6	6	n/a	n/a
Logistics Section Chief	All Hazards: EOC Activations Levels 3 and above	<ul style="list-style-type: none"> Help ensure a schedule is developed to manage field logistics Assessment of current status, impacts, needs and shortfalls Help ensure consistent reporting of progress and position Field logistics requirements (staging sites, food, lighting, restrooms, facilities manager, warehouse materials, etc.) 	<ul style="list-style-type: none"> Completion of responder courses: IS-100, IS-200, IS-700, and SEMS G-606 Subject matter expertise in their daily role Relevant professional experience with facilities, business support, or other logistics roles at the company. 	8	11	n/a	n/a

Role	Incident Type	Responsibilities	Qualifications	# of Dedicated Staff Required	# of Dedicated Staff Provided	# of Contract Workers Required	# of Contract Workers Provided
		<ul style="list-style-type: none"> Conduct assessments requested by the OIC Assessment of deployable assets (fuel supply, vehicles, human cargo, Wi-Fi, MCTs, portable generators, etc.) Environmental concerns and mitigating efforts Keep Logistics Section Unit Representatives briefed following EOC Executive Briefings 					
Finance and Admin Section Chief	All Hazards: EOC Activations Levels 3 and above	<ul style="list-style-type: none"> Help ensure incident coverage for each operational period Establish emergency prep Internal Orders (IO's) Provide Finance & Admin (F&A) section updates during pre-activation briefings Update the EOC Action Plan (EAP), as required If outbound Mutual Assistance is being considered, support the process to Obtain Emergency Cash Provide F&A section updates during each company briefings If requested by the Officer in Charge, work with expense analysis unit and other Chiefs to provide cost analysis forecasts for the incident Help ensure emergency responders stop charging the emergency IOs as soon as emergency work on activities is no longer necessary 	<ul style="list-style-type: none"> Completion of responder courses: IS-100, IS-200, IS-700, and SEMS G-606 Subject matter expertise in their daily role Relevant professional experience with the financial department or a financial role within the company. 	4	8	n/a	n/a

Role	Incident Type	Responsibilities	Qualifications	# of Dedicated Staff Required	# of Dedicated Staff Provided	# of Contract Workers Required	# of Contract Workers Provided
		<ul style="list-style-type: none"> Send initial incident forecasts to appropriate planning manager for their team to help ensure actual emergency costs are reviewed and finalized (normal operations) 					
Access and Functional Needs Liaison	All Hazards: EOC Activations Levels 2 and above	<ul style="list-style-type: none"> Respond to inquiries regarding AFN Customers. Advocate solutions and internal processes to provide safety and full access to customers with AFN Maintain close coordination with the Notification Group, Liaison, PIO, ENS and Customer Service Sections Support Utility Officer in Charge (OIC) to address emergency needs of Customers with AFN and carry out the AFN strategy Serve as the internal single point of contact for all AFN Support CBO partners and all AFN General CBO Partners Provide approved, accessible and timely notification and communication to all internal and external AFN stakeholders Resolve issues and facilitate the fulfillment of customers with AFN requests with the appropriate AFN Support CBO Partner or internal department Maintain communication and coordinate with Community Resource Center (CRC) liaison on all Customer AFN support requested If applicable, coordinate regional AFN partner staffing at the CRCs 	<ul style="list-style-type: none"> Completion of responder courses: IS-100, IS-200, IS-700, and SEMS G-606 Subject matter expertise in their daily role Relevant professional experience with the Access and Functional Needs department or an AFN role within the company. 	7	14	n/a	n/a

8.4.2.2.2 Personnel and External Contractor Training

OEIS Table 8-39: Electrical Corporation Personnel Training Program

Training Topic	Purpose and Scope	Training method	Training frequency	Position or Title of Personnel Required to Take Training	# Personnel Requiring Training	# Personnel Provided Training	Form of Verification or Reference
FEMA IS-100	Required courses for all PSPS Responders Covers ICS, EOC foundations, and critical state response topics	Independent study courses hosted by FEMA and CSTI on external sites. SDG&E directs onboarding responders to the sites to register and complete the courses independently. Once complete, students pass a test and earn a certificate.	As needed and with all onboards.	All new responders.	346	583	Certifications are stored with EOC Coordinator in protected files.
FEMA IS-200	Required courses for all PSPS Responders Covers ICS, EOC foundations, and critical state response topics	Independent study courses hosted by FEMA on external sites. SDG&E directs onboarding responders to the sites to register and complete the courses independently. Once complete, students pass a test and earn a certificate.	As needed and with all onboards.	All new responders.	346	346	Certifications are stored with EOC Coordinator in protected files.
FEMA IS-700	Required courses for all PSPS Responders Covers ICS, EOC foundations, and critical state response topics	Independent study course hosted by FEMA on external sites. SDG&E directs onboarding responders to the sites to register and complete the courses independently. Once complete, students pass a test and earn a certificate.	As needed and with all onboards.	All new responders.	346	503	Certifications are stored with EOC Coordinator in protected files.
SEMS G-606	Required courses for all PSPS Responders Covers ICS, EOC foundations, and critical state response topics	Independent study course hosted by CSTI on external sites. SDG&E directs onboarding responders to the sites to register and complete the courses independently.	As needed and with all onboards.	All new responders.	346	380	Certifications are stored with EOC Coordinator in protected files.

Training Topic	Purpose and Scope	Training method	Training frequency	Position or Title of Personnel Required to Take Training	# Personnel Requiring Training	# Personnel Provided Training	Form of Verification or Reference
		Once complete, students pass a test and earn a certificate.					
Summer Readiness and PSPS Training	Annual training overviewing wildfire season expectations and PSPS best practices. PSPS training is a requirement.	Four live, instructor-led sessions paired with recorded sessions for any absent participants.	Four sessions each summer and a recorded session is assigned to all responders who were unable to attend the live sessions.	All PSPS responders	346	453	Attendance files and make-up sessions are stored with Training and Exercise as within the company LMS (MyLearning).
New EOC Member Orientation	Provides an overview of SDG&E's EOC practices and expectations Gives more specified information about SDG&E's Emergency Responses beyond the introductory level FEMA EOC course content.	Instructor-led sessions.	Bi-monthly	All new EOC responders will be required to complete the course starting in January 2023.	New responders as of 2023	32	Full time employees' attendance is stored within MyLearning (LMS), and contractors' attendance is stored within Training and Exercise's course files.

OEIS Table 8-40: Contractor Training Program

Training Topic	Purpose and Scope	Training method	Training frequency	Position or Title of Personnel Required to Take Training	# Personnel Requiring Training	# Personnel Provided Training	Form of Verification or Reference
n/a	n/a	n/a	n/a	n/a	n/a	n/a	n/a

8.4.2.3 Drills, Simulations, and Tabletop Exercises

OEIS Table 8-41: Internal Drill, Simulation, and Tabletop Exercise Program

Category	Exercise Title and Type	Purpose	Exercise frequency	Position or Title of Personnel Required to Participate	# Personnel Participation Required	# Personnel Participation Provided*	Form of Verification or Reference
Discussion or Operations Based	Wildfire/PSPS Tabletop Exercise	<ul style="list-style-type: none"> • Provide utility a way to determine its readiness to respond to a physical or cyber security incident • Identify gaps or problems with existing policies and plans • Opportunity to practice response coordination with other utilities, CAISO, and other exercise players • Serve as a tool for modifying and improving existing response plans based on lessons learned during the exercise 	Bi-Annually	<ul style="list-style-type: none"> • Director of Emergency Management • Applicable EOC positions • EOC Supervisor • Directors or Managers of applicable Operations Departments 	20	37	Exercise attendance records and AAR

**Note: number of personnel participating in trainings sometimes exceeds requirements*

OEIS Table 8-42: External Drill, Simulation, and Tabletop Exercise Program

Category	Exercise Title and Type	Purpose	Exercise frequency	Position or Title of Personnel Required to Participate	# Personnel Participation Required	# Personnel Participation Provided*	Form of Verification or Reference
Discussion-based	PSPS Tabletop exercise	<ul style="list-style-type: none"> • Provide utility and public safety partners a way to determine their readiness to respond to and recover from a PSPS event • Clarify gaps or problems with policies and plans 	Annually	<ul style="list-style-type: none"> • A representative from each relevant EOC responder role, including OIC, Deputy-OIC, Command and General, and Section Chiefs. 	18	32	Exercise scoping materials and sign-in logs

Category	Exercise Title and Type	Purpose	Exercise frequency	Position or Title of Personnel Required to Participate	# Personnel Participation Required	# Personnel Participation Provided*	Form of Verification or Reference
		<ul style="list-style-type: none"> • Help utility and public safety partners understand their roles during a PSPS event • Serve as a training tool • Help identify needs for other resources • Serve as a tool for modifying and improving existing PSPS coordination and emergency response plans based on the lessons learned during the exercise 		<ul style="list-style-type: none"> • Program Director of Emergency Planning • Grid Operations Program Manager and supervisors • Emergency Operations Center Supervisor • Access and Functional Needs staff • CPUC Liaison • Fire liaison • Police, sheriff, and CHP chief(s) or liaisons • Local Healthcare liaison • Communication industry liaisons, • Relevant public safety partners 			
Operations-based	PSPS Functional Exercise	<ul style="list-style-type: none"> • Provide utility and public safety partners a way to determine their readiness to respond to and recover from a PSPS event • Clarify gaps or problems with policies, and plans • Help utility and public safety partners understand their roles during a PSPS event • Serve as a training tool • Help identify needs for other resources • Serve as a tool for modifying and improving existing PSPS coordination and emergency 	Annually	<ul style="list-style-type: none"> • A representative from each relevant EOC responder role, including: OIC, Deputy-OIC, Command and General, and Section Chiefs. • Program Director of Emergency Planning • Grid Operations Program Manager and supervisors • Emergency Operations Center Supervisor 	22	96	Exercise scoping materials and sign-in logs

Category	Exercise Title and Type	Purpose	Exercise frequency	Position or Title of Personnel Required to Participate	# Personnel Participation Required	# Personnel Participation Provided*	Form of Verification or Reference
		response plans based on the lessons learned during the exercise		<ul style="list-style-type: none"> • Access and Functional Needs staff • CPUC Liaison • Fire liaison • Police, sheriff, and CHP chief(s) or liaisons • Local Healthcare liaison • Communication industry liaisons, • Relevant public safety partners 			

**Note: number of personnel participating in trainings sometimes exceeds requirements*

8.4.2.4 Schedule for Updating and Revising Plan

The CEADPP is reviewed annually by Emergency Management and updated to meet changes in regulatory requirements and recommendations resulting from training, exercises, and AARs. It also incorporates the requirements of CPUC Decisions D.98-07-097, D.00-05-022, and D.12-01-032 as well as the latest CPUC reporting guidelines of November 1, 2012, CPSD Memorandum Every 3 years Emergency Management completes a full document review and invites stakeholders to provide input. Changes are tracked and recorded in the Record of Changes section of the plan. Following the 3-year review, the plan is submitted to SDG&E leadership for approval and once approved, is shared with each business unit for reference. Procedural manuals are updated as required to conform to this general plan.

Annual reviews are performed in Q1 of each year. The annual review is based on outcomes from exercises to testing multi-hazard events as well as actual emergency events. These exercises simulate the need to activate the EOC. The overall objectives are to improve coordination and communication during an event. Exercises will include drills, workshops, and discussion-based events such as a tabletop exercise. Based on the foundations built in less complex events, functional exercises are performed to test all processes and procedures used to respond to those events. Annually the scenarios will change dependent on the current hazard environment, regulatory requirements, and leadership intent.

The plan and its review meet California's Assembly Bill 1650.

OEIS Table 8-43: Wildfire-Specific Updates to the CEADPP

ID#	Year of Updated Plan	Revision Type	Lesson Learned	Revision Description	CEADPP Section Reference
1	2022	Clarification	External accreditation identified gap	Added information regarding cause of wildfires to be natural or manmade	Section 2.2 Scope, p.5
2	2022	Addition	Identification of responsibility/ownership of risk	Identified that Emergency Management responsibilities have a direct impact on risks over which Emergency Management does not have direct ownership, but that directly impact SDG&E. These risks include wildfire.	Section 2.4.2 Capability Assessment, p.10
3	2022	Addition	External accreditation identified gap	Identified wildfire as one of the threats and hazards that SDG&E deems most likely to occur and which are applicable to emergency preparedness activities and planning	Section 2.4.2 Capability Assessment, p.11

8.4.3 External Collaboration and Coordination

8.4.3.1 Emergency Planning

The EOC serves as the location from which centralized emergency management is coordinated for the entire service territory. To plan for in advance when possible, and to respond and recover from all hazards and threats, like wildfires, the EOC contains cross-functional teams representing every major business line within the Company and functions within a utility-compatible ICS. Activation of the EOC assembles internal subject matter experts to assess and provide situational awareness to internal and external stakeholders, overarching incident objectives, planning, anticipation, response, communications, and coordination.

Emergencies are managed in alignment with the state Standardized Emergency Management Systems (SEMS) and federal NIMS to coordinate across all levels of utility, government, and agency activity. A utility-compatible ICS structure is utilized as an all-hazards framework to manage emergency incidents and events.

External Emergency Management partners, such as the County Office of Emergency Services (OES) and CalOES, are provided with situational awareness 24 to 72 hours in advance or as soon as operationally feasible; additionally, those partners are embedded within the EOC during emergency conditions.

SDG&E conducts or participates in emergency exercises and training, all of which include a lessons-learned component. Additionally, SDG&E has partnered with PG&E and SCE to develop a joint training committee to develop standardized training for CalOES EOC Credentials.

A Human-Machine Interface and decision-support concepts, called HFE, has been developed for real-time risk management and decision-making, in partnership with the DOE and Pacific Science & Engineering (PS&E) Group (WMP.1335). By weaving HFE into the design of PSPS decision-making tools, the safety, consistency, and timeliness of de-energization and re-energization decisions are improved. Going forward, HFE projects will be expanded to Electric Distribution Operations, Electric Regional Operations, Mission Control Grid Operations, and companywide based on early successes. This will allow the enhancement of PSPS decision making tools, including a dashboard and workflow for notifications.

OEIS Table 8-44: State and Local Agency Collaboration(s)

Name of State or Local Agency	Point of Contact and Information	Emergency Preparedness Plan Collaboration – Last Version of Plan Agency Collaborated	Emergency Preparedness Plan Collaboration – Collaborative Role	Memorandum of Agreement (MOA)?	Brief Description of MOA
211 San Diego	Director of Emergency Services See Appendix F for contact information	Update of the CEADPP - virtual meeting– 6/2022	Wildfire/PSPS protocols feedback and review	No	n/a
Orange County United Way (formerly 211 Orange County)	Program Supervisor See Appendix F for contact information	Update of the CEADPP – virtual meeting – 6/2022	Wildfire/PSPS protocols feedback and review	No	n/a
Cal Fire	Unit Chief See Appendix F for contact information	Update of the CEADPP – virtual meeting – 6/2022	Wildfire/PSPS protocols feedback and review	No	n/a

**full table is in Appendix F, redacted*

OEIS Table 8-45: Key Gaps and Limitations in Collaboration Activities with State and Local Agencies

Gap or Limitation Subject	Remedial Brief Description	Remedial Action Plan
No gaps have been identified in collaboration activities.	n/a	n/a

8.4.3.2 Communication Strategy with Public Safety Partners

SDG&E's public safety partner portal allows for more effective communication with Public Safety Partners, including first responders, jurisdictions, tribal governments, water and telecommunications providers, CalOES, and County OES. This portal streamlines information sent to Public Safety Partners during a PSPS event so they can access the most up-to-date information. Outreach and education on the safety partner portal is conducted in Public Safety Partner training sessions. A tutorial video is also available on the PSPS portal.

As outlined in the CEADPP, a notification group comprised of the EOC's Public Information Officer, Government Liaison, Customer Care, and Planning Section Chief coordinates messaging, timing, and stages of notifications to customers, public safety partners, jurisdictions, elected officials, and critical infrastructure agencies. Notifications may be sent as phone calls, SMS texts, or emails to customers. Notifications to external stakeholder points of contact are typically via email.

The Crisis Communications Plan, which is part of the CEADPP, focuses on communications with external partners and the public. It is intended to coordinate internal resources and the Notification Group to ensure the "one voice" communication tone is consistent between all external stakeholders, customers, elected leaders, regulatory, and public safety partners. This plan is managed by the Marketing and Communication department.

The WCRC will serve as both the hub for operational communications during an event as well as a valuable training and outreach resource for SDG&E responders and public safety partners. During an incident, the WCRC will house the EOC. In addition to operational response, the EOC performs trainings and exercises for responders to ensure effective communication and coordination with public safety partners. As a venue for tours, meetings, and other collaboration opportunities, the WCRC supports SDG&E's ability to foster a strong relationship with stakeholders by allowing engagement, collaboration, training, and exercise with public safety partners on an ongoing basis.

OEIS Table 8-46: High-Level Communication Protocols, Procedures, and Systems with Public Safety Partners*

Public Safety Partner Group	Name of Entity	Point of Contact and Information	Key Protocols	Frequency of Prearranged Communication Review and Update	Communication Exercise(s): Date of Last Completed	Communication Exercise(s): Date of Planned Next
Law Enforcement	See Appendix F for list of partner entities	See Appendix F for list of partner contact info	<ul style="list-style-type: none"> • Communication capabilities (e.g., staffing, resources, technologies) • Methods for information exchange • Format for each data typology • Data management strategy • Backup systems • Common alerting protocols • Messaging 	Quarterly	Functional Exercise 8/12/2022 1:00 pm-5:00 pm PDT and 8/15/2022 8:00-4:00 pm PDT Wildfire Safety and Microgrid and Resiliency Workshop 6/21/2022 9 am PDT to 11:30 a.m. PD	Tabletop Exercise March 21, 2023
Public Safety	See Appendix F for list of partner entities	See Appendix F for list of partner contact info	See Law Enforcement row	Bi-Monthly	Functional Exercise 8/12/2022 1:00 pm-5:00 pm PDT and 8/15/2022 8:00-4:00 pm PDT Wildfire Safety and Microgrid and Resiliency Workshop 6/21/2022 9 am PDT to 11:30 a.m. PD	Tabletop Exercise March 21, 2023
Emergency Response	See Appendix F for list of partner entities	See Appendix F for list of partner contact info	See Law Enforcement row	Bi-Monthly	Functional Exercise 8/12/2022 1:00 pm-5:00 pm PDT and 8/15/2022 8:00-4:00 pm PDT Wildfire Safety and Microgrid and Resiliency Workshop 6/21/2022 9 am PDT to 11:30 a.m. PD	Tabletop Exercise March 21, 2023
Water Service Providers	See Appendix F for list of partner entities	See Appendix F for list of partner contact info	See Law Enforcement row	Annually	Functional Exercise 8/12/2022 1:00 pm-5:00 pm PDT	Tabletop Exercise March 21, 2023

Public Safety Partner Group	Name of Entity	Point of Contact and Information	Key Protocols	Frequency of Prearranged Communication Review and Update	Communication Exercise(s): Date of Last Completed	Communication Exercise(s): Date of Planned Next
					Wildfire Safety and Microgrid and Resiliency Workshop 6/21/2022 9 am PDT to 11:30 a.m. PD	
Waste Water Service Providers	See Appendix F for list of partner entities	See Appendix F for list of partner contact info	See Law Enforcement row	Annually	Functional Exercise 8/12/2022 1:00 pm-5:00 pm PDT and 8/15/2022 8:00-4:00 pm PDT Wildfire Safety and Microgrid and Resiliency Workshop 6/21/2022 9 am PDT to 11:30 a.m. PD	Tabletop Exercise March 21, 2023
Communication Service Providers	See Appendix F for list of partner entities	See Appendix F for list of partner contact info	See Law Enforcement row	Annually	Functional Exercise 8/12/2022 1:00 pm-5:00 pm PDT and 8/15/2022 8:00-4:00 pm PDT Wildfire Safety and Microgrid and Resiliency Workshop 6/21/2022 9 am PDT to 11:30 a.m. PD	Tabletop Exercise March 21, 2023
Community Choice Aggregators	See Appendix F for list of partner entities	See Appendix F for list of partner contact info	See Law Enforcement row	Annually	Invited to Functional Exercise (8/12 and 8/15) and Tabletop Exercise 6/27 but unable to attend	Tabletop Exercise March 21, 2023
Affected Publicly Owned Utilities	See Appendix F for list of partner entities	See Appendix F for list of partner contact info	See Law Enforcement row	As Needed	Tabletop Exercise 10/14/2022	Tabletop Exercise March 21, 2023
The Commission	See Appendix F for list of partner entities	See Appendix F for list of partner contact info	See Law Enforcement row	Bi-Monthly	Functional Exercise 8/12/2022 1:00 pm-5:00 pm PDT and 8/15/2022 8:00-4:00 pm PDT Wildfire Safety and Microgrid and Resiliency Workshop 6/21/2022 9 am PDT to 11:30 a.m. PD	Tabletop Exercise March 21, 2023

Public Safety Partner Group	Name of Entity	Point of Contact and Information	Key Protocols	Frequency of Prearranged Communication Review and Update	Communication Exercise(s): Date of Last Completed	Communication Exercise(s): Date of Planned Next
CalOES	See Appendix F for list of partner entities	See Appendix F for list of partner contact info	See Law Enforcement row	Bi-Monthly	Functional Exercise 8/12/2022 1:00 pm-5:00 pm PDT and 8/15/2022 8:00-4:00 pm PDT Wildfire Safety and Microgrid and Resiliency Workshop 6/21/2022 9 am PDT to 11:30 a.m. PD	Tabletop Exercise March 21, 2023
CAL FIRE	See Appendix F for list of partner entities	See Appendix F for list of partner contact info	See Law Enforcement row	Monthly	Functional Exercise 8/12/2022 1:00 pm-5:00 pm PDT and 8/15/2022 8:00-4:00 pm PDT Wildfire Safety and Microgrid and Resiliency Workshop 6/21/2022 9 am PDT to 11:30 a.m. PDT	Tabletop Exercise March 21 st 2023

**full table is in Appendix F, redacted*

OEIS Table 8-47: Key Gaps and Limitations in Communication Coordination with Public Safety Partners

Gap or Limitation Subject	Remedial Brief Description	Remedial Action Plan
Engagement overload	Partners not providing as much engagement/feedback due to increased requests for engagement/feedback.	Leverage the partner focus group to determine strategies to increase engagement and feedback

8.4.3.3 Mutual Aid Agreements

A speedy restoration requires significant logistical expertise, skilled line workers and assessors, and specialized equipment on a large scale. Mutual assistance is an essential part of the energy industry's contingency planning and restoration process. Utility companies impacted by a major outage event are able, under mutual assistance, to increase the size of their workforce by borrowing restoration workers from other companies. When called up, a company will send skilled restoration workers along with specialized equipment, oversight management, and support personnel to assist the restoration efforts of a fellow electric/gas service company. Crew members who deploy for mutual assistance are provided just-in-time training at the pre-deployment briefing, including review of all COVID-19 protocols.

The primary goal of the mutual assistance program is to restore service in a safe, effective, and efficient manner. The program also serves additional objectives that benefit the entire energy industry. These include:

- Promote the safety of employees and customers
- Strengthen relationships among utility companies
- Provide a means for utility companies to receive competent, trained employees and contractors from other experienced companies
- Provide a predefined mechanism to share industry resources expeditiously
- Mitigate the risks and costs of member companies related to major incidents
- Proactively improve resource-sharing during emergency conditions
- Share best practices and technologies that help the utility industry improve its ability to prepare for, and respond to, emergencies
- Promote and strengthen communication among Regional Mutual Assistance Groups (RMAGs)
- Enable a consistent, unified response to emergency events

Mutual assistance is both incoming and outgoing. There are situations where SDG&E's resources are taxed and require the assistance of other subject matter expertise from visiting utilities. There are other situations where the service territory is not affected but other utilities require outside assistance. Planning efforts cover both scenarios. SDG&E is a member of multiple emergency associations to facilitate mutual assistance and maintains active mutual assistance agreements with the following organizations:

- California Utilities Emergency Association (CUEA)
- Western Regional Mutual Assistance Group
- Edison Electric Institute
- American Gas Association

OEIS Table 8-48: High-Level Mutual Aid Agreement for Resources During a Wildfire or De-Energization Incident

Mutual Aid Partner	Scope of Mutual Aid Agreement	Available Resources from Mutual Aid Partner
California Utilities Emergency Association (CUEA)	Requests/responses for assistance, personnel/ equipment, costs and expenses, support functions (lodging, meals, materials, etc.)	Personnel and equipment; the Assisting Party shall use its reasonable efforts to schedule the Assistance in accordance with the Requesting Party's request
Western Regional Mutual Assistance Group	Requests/responses for assistance, Personnel/ equipment, costs and expenses, support functions (lodging, meals, materials, etc.)	Personnel and equipment, dependent on the extent and limitations of the assistance
Edison Electric Institute	Requests/responses for assistance, Personnel/ equipment, costs and expenses, support functions (lodging, meals, materials, etc.)	Personnel and equipment, dependent on responding party availability
American Gas Association	Requests/responses for assistance, Personnel/ equipment costs and expenses, support functions (lodging, meals, materials, etc.)	Personnel and equipment, dependent on: <ul style="list-style-type: none"> a. Impact – degree of system loss and estimated time customers have been without service b. Which participating company will be first impacted c. Travel time d. Availability of other non-participating company-controlled resources

8.4.3.4 Wildfire and Climate Resilience Center (WCRC)

The WCRC, completed in early 2024, serves as a physical space committed to understanding evolving wildfire and climate impacts and to build climate-informed grid resilience. From wildfire mitigation to community preparedness resilience, having a physical space to advance science, respond to emergencies, engage with partners, and educate the community will be paramount for developing collective wildfire and climate-related resilience for the company and the region.

The WCRC will act as a centralized workspace for all employees working in the Wildfire and Climate Science Division, which consists of Wildfire Mitigation, Emergency Management, and Fire Science and Climate Adaptation. This space will include the Fire Science and Innovation (FSI) Lab and Wildfire Mitigation Lab. Through partnerships with academia, increased employee collaboration and fostering continued innovation, SDG&E will continue to advance and share wildfire and climate science as it relates to the safe and reliable operation of the electric system. WCRC will also include a new Wildfire and Climate Experience Center, which will serve as a primary location for subject matter experts to continuously engage, educate, and collaborate with community members.

The WCRC will also house the primary EOC. The existing EOC and support spaces, originally built in 1999, do not currently function optimally for the requirements of the evolving emergencies faced today. The new EOC will support the challenges of today while enabling future potential growth.

The WCRC will also serve as a venue to train current and future SDG&E employees on the importance of wildfire safety, emergency preparedness, fire science and climate resilience, helping to reinforce the strong culture of wildfire and climate awareness.

Figure 8-42: WCRC Floor Plan

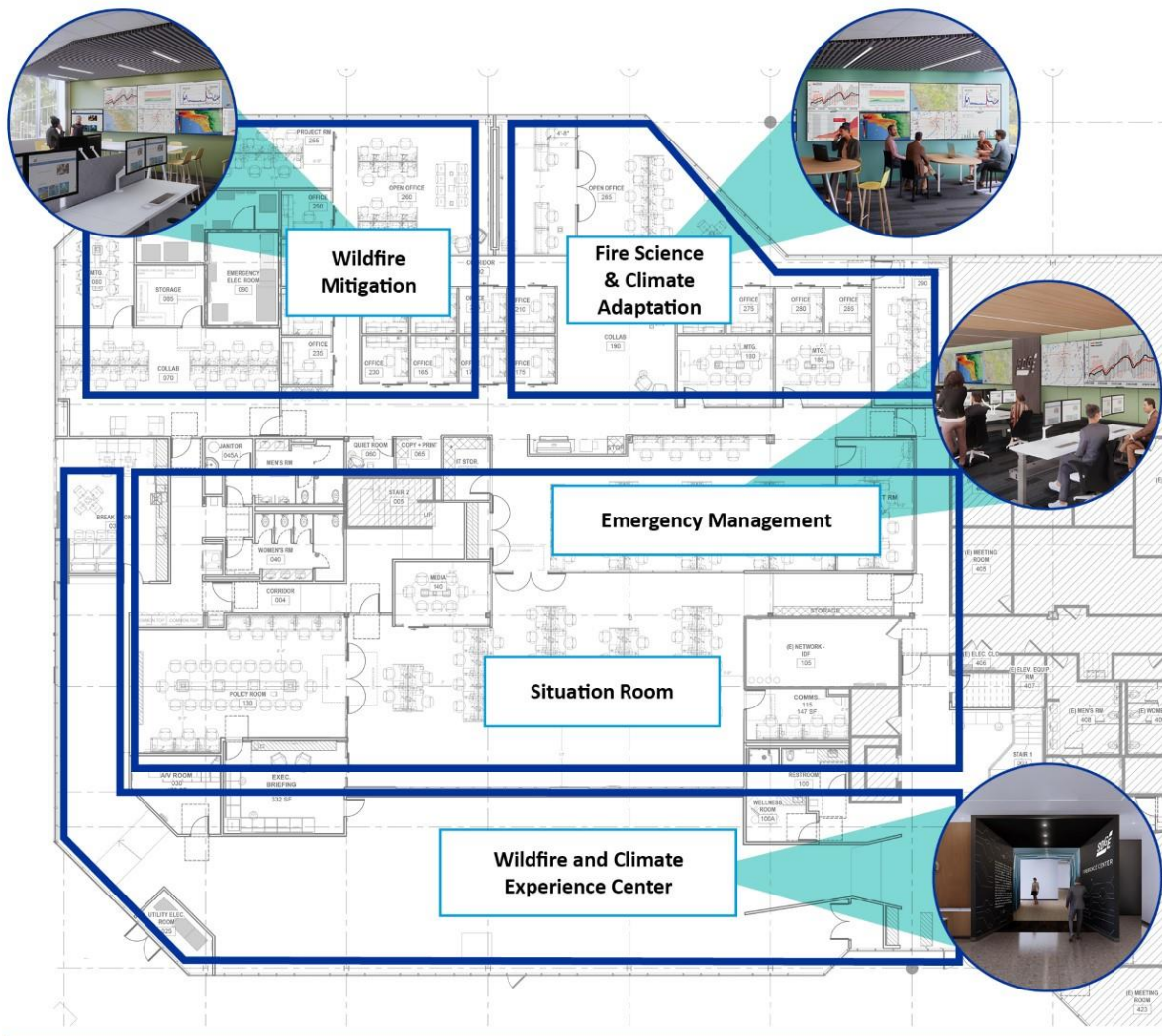

8.4.4 Public Emergency Communication Strategy (WMP.563)

During outages due to wildfires and PSPS events, notifications, media updates, in-community signage, and situational awareness postings are used across social media. Social media kits are also shared with community partners to reach a broad audience. Additionally, communications are activated to provide affected customers and the public with the latest real-time updates during an outage due to wildfire or PSPS. Key communications are available in 22 prevalent languages.

In addition to mass media, SDG&E utilizes communications channels geared towards individuals who may not be account holders (e.g., visitors, mobile home park residents, caretakers, etc.). These channels include SDG&E's PSPS Mobile Application (Alerts by SDG&E), roadside electronic message signs placed in

strategic, highly traveled locations, tribal casino marquees, and flyers posted around impacted communities.

PSPS notifications are sent to all impacted individuals as soon as possible through the Enterprise Notification System (ENS) (recorded voice message, email and text message). All notifications for outages due to wildfire and PSPS have also been converted into American Sign Language video, audio read-out, and written transcript. Address-level alerts are also enabled for customers and the general public through the Alerts by SDG&E Application.

8.4.4.1 Protocols for Emergency Communications

In addition to notifications, PSPS Application and website, and partnerships with local media, 24/7 real-time situation updates are provided through the SDG&E NewsCenter and personnel are available 24/7 for media interviews when requested during an event. The SDG&E NewsCenter and sdge.com provide event-specific information about impacted areas. Social media is also utilized to broadcast updates and safety information across the region.

Communications with local water districts, telecommunications infrastructure providers, the San Diego County Office of Education, the San Diego County Office of Emergency Services, and the American Red Cross are also established. Communication protocols are ongoing through the duration of an event and through customer restoration. In-Community communications are also leveraged through community flyers posted throughout affected communities, school and casino marquees and extensive use of portable roadside signage strategically placed at major thoroughfares and principal egress and regress points in affected communities.

SDG&E has formal partnerships with over 200 Energy Solutions Partners who help to prepare AFN customers for a PSPS event and amplify notifications and solutions. Through this network, there are more than 700 partners that serve customers with AFN who help to provide frequent updates and situational awareness as well as direction to support services. See Section 8.5.3 for more information on engagement with AFN customers.

To promote PSPS awareness and preparedness in tribal communities, SDG&E partnered with the La Jolla Band of Luiseno Indians to host a Wildfire Resiliency Fair to help prepare the surrounding communities in advance of wildfire season. Several tribes have also been engaged to potentially install Tribal Resource Centers—resources that would be deployed during a PSPS event. Tribal Resource Centers would be similar to a CRC but run by a tribal government, and would include energy backup, training, and resources provided by SDG&E.

In addition to individual meetings with tribal governments throughout the year, the Southern California Tribal Chairmen’s Association is briefed on enhancements to support tribal communities during PSPS events. All tribes are provided information and offered training on the new Safety Partner portal to provide MBL information to tribal governments. A Tribal Relations Manager was added to the Tribal Relations team. This role is focused on supporting tribes year-round with wildfire resiliency and PSPS.

Customer and public notifications related to wildfire follow similar protocols and timing as PSPS alerts.

OEIS Table 8-49: Protocols for Emergency Communication to Stakeholder Groups

Stakeholder Group	Event Type	Method(s) for Communicating	Means to Verify Message Receipt
General public	Wildfire	ENS system (text, voice message and email), Website updates, PSPS app, SDG&E NewsCenter	ENS message confirmation tracking, web traffic tracking, and app downloads/performance.
General public	Wildfire-related outage	ENS system (text, voice message and email), Website updates, PSPS app, SDG&E NewsCenter	ENS message confirmation tracking, web traffic tracking, and app downloads/performance.
General public	PSPS-related outage	ENS system (text, voice message and email), Website updates, PSPS app, SDG&E NewsCenter	ENS message confirmation tracking, web traffic tracking, and app downloads/performance.
General public	Restoration of service	ENS system (text, voice message and email), Website updates, PSPS app, SDG&E NewsCenter	ENS message confirmation tracking, web traffic tracking, and app downloads/performance.
Priority essential services	Wildfire	Emails, plus access to Website updates, PSPS app, PSP app, and SDG&E NewsCenter	Email delivery confirmations, updating for any that come back unsent.
Priority essential services	Wildfire-related outage	Emails, plus access to Website updates, PSPS app, PSP App, and SDG&E NewsCenter	Email delivery confirmations, updating for any that come back unsent.
Priority essential services	PSPS-related outage	Emails, plus Access to the Website updates, PSPS app, PSP App, and SDG&E NewsCenter	Email delivery confirmations, updating for any that come back unsent.
Priority essential services	Restoration of service	Emails, plus Access to Website updates, PSPS app, PSP App, and SDG&E NewsCenter	Email delivery confirmations, updating for any that come back unsent.
AFN populations	Wildfire, Wildfire-related outage, PSPS-related outage, Restoration of service	ENS system (text, voice message and email), Website updates, PSPS app, and SDG&E NewsCenter	ENS message confirmation tracking, web traffic tracking, and app downloads/performance. If no reply is given, house visits could be done.
Non-English speakers	Wildfire, Wildfire-related outage, PSPS-related outage, Restoration of service	ENS system (text, voice message and email), Website updates, PSPS app, and SDG&E NewsCenter	ENS message confirmation tracking, web traffic tracking, and app downloads/performance.
Tribes	Wildfire, Wildfire-related outage, PSPS-related outage, Restoration of service	ENS system (text, voice message and email), Website updates, PSPS app, and SDG&E NewsCenter	ENS message confirmation tracking, web traffic tracking, and app downloads/performance.

8.4.4.2 Messaging

SDG&E prioritizes accessibility for its websites and mobile apps, taking a proactive approach to meet Americans with Disabilities Act (ADA) and Web Content Accessibility Guidelines (WCAG) global web standards for accessibility. See Section 8.5.3 for more information on engagement with AFN customers.

During a wildfire, if SDG&E infrastructure is impacted, communications are immediately distributed to customers tied to the impacted infrastructure by utilizing the ENS customer notification system. During outages due to wildfires and PSPS, the ENS provides affected customers and the public with the latest real-time updates. Key communications are available in 22 prevalent languages. Customer and public notifications are sent in the following intervals:

- 48 hours before power is turned off
- 24 hours before power is turned off
- 12 hours before power is turned off
- 1 to 4 hours before power is turned off
- When the PSPS starts
- If any CRCs are opened
- When filed inspections begin
- When electric power is restored

PSPS-related and wildfire-safety-related communications are accessible in the following prevalent languages identified for the service territory:

- | | | |
|---------------|--------------|----------------|
| 1. English | 9. Arabic | 17. Mixtec |
| 2. Spanish | 10. French | 18. Zapotec |
| 3. Mandarin | 11. German | 19. Armenian |
| 4. Cantonese | 12. Farsi | 20. Hindi |
| 5. Vietnamese | 13. Japanese | 21. Portuguese |
| 6. Korean | 14. Punjabi | 22. Thai |
| 7. Tagalog | 15. Khmer | |
| 8. Russian | 16. Somali | |

Messaging, tone and language are examined and tested on an annual basis. Communications are developed so they are easy to understand (sixth grade reading level), clear, consistent, and informative. All messaging is aligned across communication channels, this includes notifications, NewsCenter stories, social media and website updates and content. This messaging is also shared with external partners.

Messaging content contains real-time awareness information about the event and where to get updates for the duration. Local media and community partners are also provided with similar messaging for amplifications. Alerts are also sent at specific intervals during a PSPS or wildfire-related outage (see Section 8.4.4.2 Messaging for more information). These communications include information about the high-fire risk weather conditions as well as when and where outages are expected. Customers and the public are directed to [sdge.com/ready](https://www.sdge.com/ready) for further updates.

8.4.4.3 Current Gaps and Limitations

OEIS Table 8-50: Key Gaps and Limitations in Public Emergency Communication Strategy

Gap or Limitation Subject	Remedial Brief Description	Remedial Action Plan
Customer/Public Wildfire/PSPS Notifications/Communications Comprehension	Annually SDG&E surveys affected customers for retention and comprehension of communications and messaging during a PSPS or related event.	As there were no affected customers from 2022 PSPS events, SDG&E has not been able to test notifications and messaging that were updated for the 2022 season. This messaging will be reviewed for any improvements in 2023, and SDG&E will solicit feedback on these communications from any affected customers during the 2023 season.

8.4.5 Preparedness and Planning for Service Restoration

8.4.5.1 Overview of Service Restoration Plan

The purpose of the patrol and restoration plan is to identify priority locations and timeframes in which patrols are forecasted to be safe to be perform. The plan is used to inform resource needs (such as patrollers and vehicles) and align any limited resources with restoration priorities if resource constraints exist. Ultimately this allows for efficient customer restorations to occur at the conclusion of each PSPS event. The plan includes a list of circuit segments with forecasted dates and times when these segments will see a reduction in wind speed such that wildfire risks no longer necessitate a power shut off in those areas. Prior to any service restorations, visual patrols are performed in order to clear the infrastructure in those zones of potential damage that may have occurred while de-energized.

Prior to the conclusion of a PSPS event, a patrol and restoration plan is created which identifies the expected times when various sections of the electric system are forecasted to be safe to perform a visual patrol to identify any damage and if no damage is present, restore power. The plan allows for timely resourcing to minimize time needed to safely restore power to customers and optimizes any constrained resources to ensure they are deployed in a way that optimizes service restorations. Procedures dictate patrol requirements prior to restoration under different wildfire risk levels. These levels are dictated by both the FPI (WMP.450) and general conditions that may lead to a PSPS event. See Figure 8-43 for details on service restoration procedures.

Resource Coordination is stood up 72 hours prior to a potential RFW and possible PSPS event. Resource Coordination works directly with Electric Distribution Operations and Meteorology to better understand the duration of the event and potential de-energizations. Resource establishes 12-hour shifts to cover the event and works directly with the operating districts to establish the number of patrollers (QEWs) needed to conduct pre and post patrols as well as observations prior to potential de-energization. Resource Coordination and the operating districts also establish the number of Electric Troubleshooter, Vegetation, and Contract Fire Resource crews needed to support the event. Additionally, Aviation Services is engaged to support pre and post patrols when possible.

Each year, the Skills Training and Safety Center conducts PSPS training for the Operating Districts including lineman, electric troubleshooters, and contract line crews. Additionally, PSPS Readiness

exercises take place at the district level as well as an exercise with Electric Distribution Operations along with the resource coordination and prioritization team where tools and processes are refined.

Figure 8-43: Key Components of Service Restoration Procedures

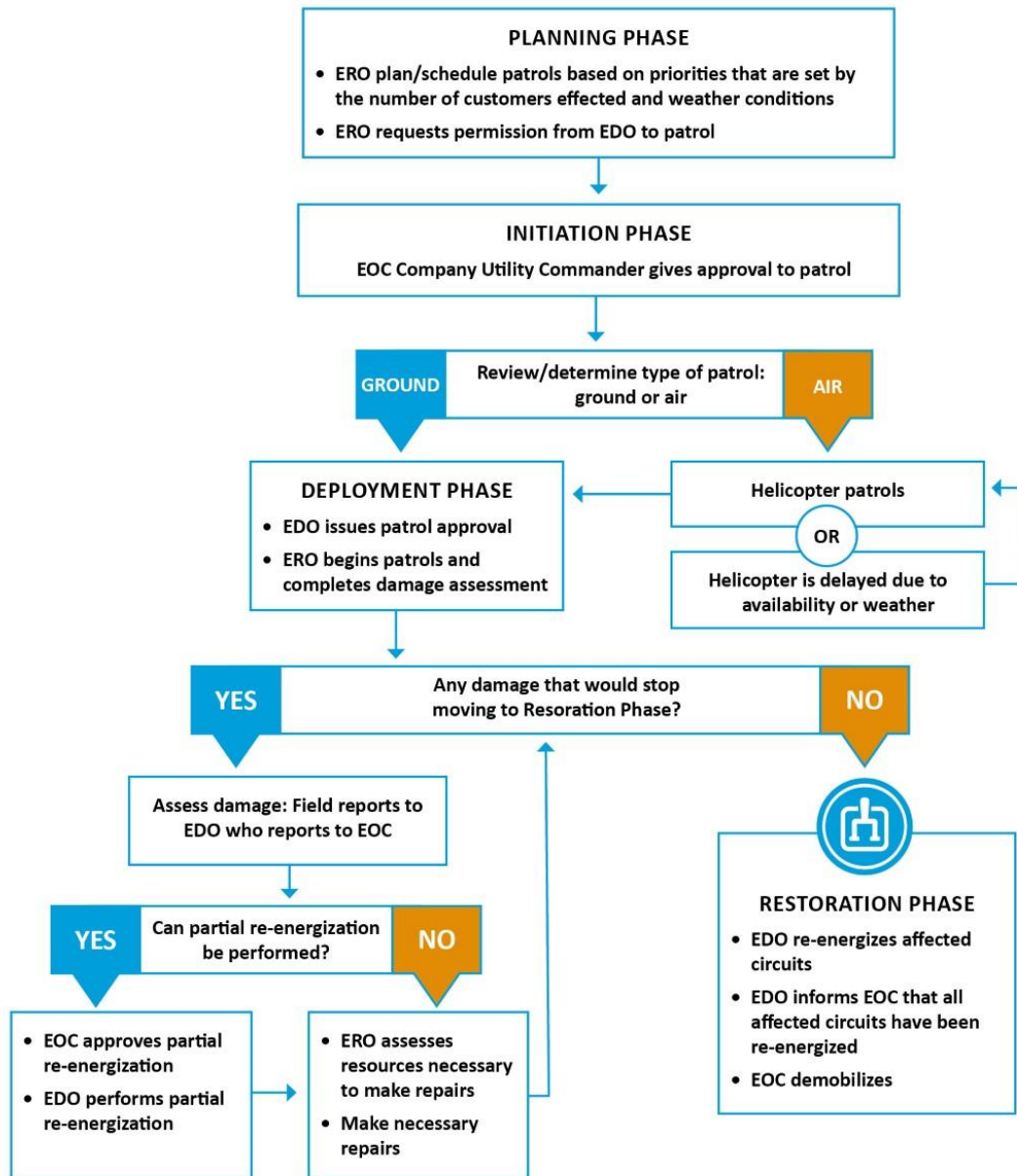

8.4.5.2 Planning and Allocation of Resources

Prior to the start of a potential PSPS event, a company meteorologist will study areas that are forecasted to see weather that may trigger a PSPS outage. All identified sites are aggregated into a list which is shared with operational leadership and field QEW are assigned to observe locations within each of the impacted zones. The role of the observer is to look for unsafe conditions that may trigger the need to de-energize lines for safety. Some of these conditions may include wind conditions causing debris or vegetation to potentially fly into lines, and/or extreme conductor movement that may lead to wires contacting each other. If multiple electrical circuits are located within proximity to each other in a zone, a single observer may be assigned to observe those multiple circuits, but be initially stationed in the windiest location within that zone.

Each circuit segment that may be impacted by a PSPS event has a pre-defined recommended resource allocation needed to perform patrols on that overhead line section. These resource requirements are documented in a field patrol guide. The guide also identifies if the line could be patrolled on the ground or if aviation support is required. Based on the total resources needed to patrol all line segments impacted by a PSPS event, two scenarios may emerge. If there are enough resources to patrol all line segments, then patrol resources are largely allocated by the expected timeframes that safe patrols will be allowed. If there is a shortage of patrol resources, then restorations are prioritized by critical infrastructure affected and the number of customers impacted to restore power to as many customers as possible.

Restoration Priorities and Resource plans are approved by the Utility Commander prior to enacting them. Additionally, each individual authorization to patrol and authorization to re-energize is issued by the Utility Commander after consulting with a company meteorologist about the weather conditions for that specific site.

Once a circuit is released for ground patrol, all resources allocated to perform those patrols are assigned to a circuit patrol coordinator. That coordinator accepts any authorizations to patrol, reports the status of patrols, and ensures all section patrols have been completed prior to asking for permission to re-energize that portion of a circuit. CFRs are also assigned to each location during restorations in order to coordinate quick fire suppression response should an ignition occur during restoration.

8.4.5.3 Drills, Simulations, and Tabletop Exercises

OEIS Table 8-51: Internal Drill, Simulation, and Tabletop Exercise Program for Service Restoration

Category	Exercise Title and Type	Purpose	Exercise Frequency	Position of Title of Personnel Required to Participate	Personnel Required	Personnel Completed	Form of Verification or Reference
Discussion-based	Hazard specific Table top Exercise (Hazards change annually)	<ul style="list-style-type: none"> • Provide utility a way to determine its readiness to respond to a disaster event • Identify gaps or problems with existing policies and plans • Serve as a training tool • Serve as a tool for modifying and improving existing response plans based on lessons learned during the exercise 	Annually	<ul style="list-style-type: none"> • Director of Emergency Management • Applicable EOC positions • Emergency Operations Center Supervisor • Directors or Managers of applicable Operations Departments 	20	51	Exercise attendance records and AAR
Discussion or Operations Based	Grid Ex (Tabletop exercise or Functional)	<ul style="list-style-type: none"> • Provide utility a way to determine its readiness to respond to a physical or cyber security incident • Identify gaps or problems with existing policies and plans • Opportunity to practice response coordination with other utilities, CAISO, and other exercise players • Serve as a tool for modifying and improving existing response plans based on lessons learned during the exercise 	Bi-Annually (every other year)	<ul style="list-style-type: none"> • Director of Emergency Management • Applicable EOC positions • Emergency Operations Center Supervisor • Directors or Managers of applicable Operations Departments 	20	37	Exercise attendance records and AAR

OEIS Table 8-52: External Drill, Simulation, and Tabletop Exercise Program for Service Restoration

Category	Exercise Title and Type	Purpose	Exercise Frequency	Position of Title of Personnel Required to Participate	Personnel Required	Personnel Completed	Form of Verification or Reference
Discussion-based	PSPS Tabletop exercise	<ul style="list-style-type: none"> • Provide utility and public safety partners a way to determine their readiness to respond to and recover from a PSPS event • Clarify gaps or problems with policies, and plans • Help utility and public safety partners understand their roles during a PSPS event • Serve as a training tool • Help identify needs for other resources • Serve as a tool for modifying and improving existing PSPS coordination and emergency response plans based on the lessons learned during the exercise 	Annually	<ul style="list-style-type: none"> • A representative from each relevant EOC responder role, including: OIC, Deputy-OIC, Command and General, Section Chiefs. • Program Director of Emergency Planning • Grid Operations Program Manager and supervisors • Emergency Operations Center Supervisor • Access and Functional Needs staff • CPUC Liaison • Fire liaison • Police, sheriff, and CHP chief(s) or liaisons • Local Healthcare liaison • Communication industry liaisons, • Relevant public safety partners 	18	32	Exercise scoping materials and sign-in logs
Operations-based	PSPS Functional Exercise	<ul style="list-style-type: none"> • Provide utility and public safety partners a way to determine their readiness to respond to and recover from a PSPS event • Clarify gaps or problems with policies, and plans 	Annually	<ul style="list-style-type: none"> • A representative from each relevant EOC responder role, including: OIC, Deputy-OIC, Command and General, Section Chiefs. • Program Director of Emergency Planning 	22	96	Exercise scoping materials and sign-in logs

Category	Exercise Title and Type	Purpose	Exercise Frequency	Position of Title of Personnel Required to Participate	Personnel Required	Personnel Completed	Form of Verification or Reference
		<ul style="list-style-type: none"> • Help utility and public safety partners understand their roles during a PSPS event • Serve as a training tool • Help identify needs for other resources • Serve as a tool for modifying and improving existing PSPS coordination and emergency response plans based on the lessons learned during the exercise 		<ul style="list-style-type: none"> • Grid Operations Program Manager and supervisors • Emergency Operations Center Supervisor • Access and Functional Needs staff • CPUC Liaison • Fire liaison • Police, sheriff, and CHP chief(s) or liaisons • Local Healthcare liaison • Communication industry liaisons, • Relevant public safety partners 			

8.4.6 Customer Support in Wildfire and PSPS Emergencies

8.4.6.1 Outage Reporting

Text It is important that customers are informed throughout the lifecycle of an adverse weather event. Broadcast media (radio and TV), the SDG&E NewsCenter, dedicated PSPS landing page (sdge.com/ready), the outage map (on sdge.com and the SDG&E application), and social media are utilized for real-time situational awareness. The ENS also provides notifications and updates directly to affected customers and community members who have signed up to receive PSPS alerts.

8.4.6.2 Support for Low-Income Customers

The following actions are taken for all low-income customers in the wildfire-impacted areas within the service territory to align with the CARE and Energy Savings Assistance (ESA) programs as follows:

- Freeze all standard and high-usage reviews for CARE program eligibility standards and high-usage post enrollment verification requests for all customers in the impacted areas within the service territory
- Partner with the United Way, the administrator of its Neighbor-to-Neighbor program that provides emergency bill assistance, to increase the bill assistance cap amount for impacted customers from \$200 to \$400
- Modify the ESA program by allowing impacted customers to self-certify if: 1) the customer states they lost documentation necessary for income verification of a wildfire, or 2) if the customer states that individuals displaced by the wildfires reside in the household

Immediately following a wildfire, outreach representatives are deployed to the field to support American Red Cross and County of San Diego assistance centers. These outreach representatives help customers download the mobile outage map to stay up to date on estimated restoration times, promote and enroll them in programs like CARE and ESA, and connect them to the vast array of services provided by San Diego emergency services.

Local CBOs are also utilized to help connect customers with emergency-related information, outage information, and program information. These CBOs also help to refer customers in need to San Diego emergency services for further information and assistance.

8.4.6.3 Billing Adjustments

When a wildfire has destroyed a customer's residential structure, closing bills are waived, including charges from the previous regular read date up until the dates the wildfire occurred and charges from the prior month of billing. For non-residential customers whose structures have been destroyed, closing bill amounts from the previous regular read date up to the dates on which the wildfire occurred are waived. Non-residential customers are still held responsible for charges billed for any months prior to the wildfire. Estimated energy usage for billing purposes is stopped when a home/unit is unoccupied due to a wildfire.

8.4.6.4 Deposit Waivers

Deposit requirements are waived for impacted customers seeking to re-establish service at either the same location or a new location.

8.4.6.5 Extended Payment Plans

For impacted customers, including customers whose employment was impacted by wildfires, payment arrangements are extended with a 0-percent down payment and a repayment period of 12 months.

8.4.6.6 Suspension of Disconnection and Nonpayment Fees

For customers impacted by wildfires, including customers whose employment was affected by wildfires, disconnection for non-payment and associated fees is suspended, deposit and late fee requirements are waived for affected customers who pay their utility bills late, and late payments by customers who are eligible for these protections are not reported to credit reporting agencies or to other such services.

The premises of customers impacted by wildfires that are not capable of receiving utility services are identified and billing is discontinued for these premises. Currently there is no disconnect charge. Additionally, there is no reconnection charge for customers impacted by wildfires.

8.4.6.7 Repair Processing and Timing

Move-ins and move-outs are expedited to support customers impacted by wildfires returning to their homes. If a customer communicates that they are relocating to another location as a result of damage to their home due to a wildfire, every attempt is made to have service available to the customer on the requested day. Additionally, the time from when the service is requested to the time it is completed is tracked.

8.4.6.8 Medical Baseline Support Services

SDG&E Table 8-36 shows the locations and services of the CRCs

SDG&E Table 8-36: CRC Locations and Services

Community Resource Center	Area Served	Facility Name	Location	Site Description
Descanso CRC	Descanso	Descanso County Library	9545 River Drive Descanso, 91916	Building + Trailer
Lake Morena CRC	Lake Morena	Lake Morena Community Church	29765 Oak Drive Campo, 91906	Building + Trailer
Pine Valley CRC	Pine Valley	Pine Valley Improvement Club	28890 Old Hwy 80 Pine Valley, 91962	Building + Trailer
Julian CRC	Julian	Whispering Winds Catholic Camp	17606 Harrison Park Road Julian, 92036	Building + Trailer
Jacumba CRC	Jacumba	Jacumba Highlands Community Center	44645 Old Highway 80 Jacumba, 91934	Building + Trailer
Dulzura CRC	Dulzura	Dulzura Community Development Center	1136 Community Building Road	Building + Trailer

Community Resource Center	Area Served	Facility Name	Location	Site Description
			Dulzura, 91917	
Warner Springs CRC	Warner Springs	Warner Springs Community Resource Center	30950 Highway 79 Warner Springs, 92086	Building + Trailer
Potrero CRC	Potrero	Potrero Community Center	24550 Highway 94 Potrero, 91963	Building + Trailer
Valley Center CRC	Valley Center	Valley Center Branch Library	29200 Cole Grade Rd Valley Center, CA 92082	Building + Trailer
Ramona CRC	Ramona	Ramona Branch Library	1275 Main Street Ramona, CA 92065	Building + Trailer
Fallbrook CRC	Fallbrook	Fallbrook Branch Library	124 S Mission Rd, Fallbrook, CA 92028	Building + Trailer

8.4.6.9 Access to Electrical Corporation Representatives

To support the Medical Baseline Allowance Program participants, SDG&E offers support before an outage and during an outage. To be prepared for an outage, customers are encouraged to sign up for and receive customized resiliency recommendations, sign up for outage notifications, sign up for back-up battery programs, and to make an emergency kit and plan. During a PSPS event, there are a number of resources available to support the customer. This includes hotel stays, accessible transportation, food support, emergency kit items, wellness checks, back-up power, and access to CRCs.

Customers and stakeholders have a variety of representatives available to communicate information and communicate concerns. These include representatives in SDG&E’s Call Centers, Regional Public Affairs, Business Services, and Fire Coordination.

- Call Centers: Any customer or concerned person can contact the call center to obtain information before, during, or after a wildfire or PSPS event. The call center adjusts resource levels accordingly to support events.
- Regional Public Affairs: SDG&E representatives are assigned to develop and maintain relationships with local elected officials. As a wildfire event approaches, the representative will establish and maintain contact with their key stakeholder. The representative provides answers to questions and addresses concerns.
- Business Services: Key and critical accounts are identified and assigned an SDG&E representative to establish and maintain contact during a wildfire or PSPS event. The representative reaches out to the customer as the event develops and maintains contact until the event is over.
- Fire Coordination: The Fire Coordinators are experienced in fire behavior, fire prevention, and firefighting techniques. They serve as the direct link to emergency-response agencies. They also serve as the single point of contact for the fire agency ICS, provide periodic updates to fire emergency personnel and SDG&E personnel, establish radio and communication assignments,

assist in the coordination of activities related to de-energizing and reenergizing power lines, and update on-scene personnel, control centers, service dispatch, and the SDG&E regional operations centers as to the status of each incident.

8.5 Community Outreach and Engagement

8.5.1 Overview

Public education and communication efforts related to wildfire safety and PSPS target customers throughout the service territory due to the regional threat of potential wildfire. Outreach efforts focus on areas that are most at risk of wildfire, such as the HFTD. Customers are also educated on wildfire preparedness through online webinars and Wildfire Safety Fairs, and outreach advisors who work with CBOs that help amplify messaging.

SDG&E's Energy Solutions Partner network, which is comprised of more than 200 CBOs, is utilized by outreach advisors to promote wildfire preparedness information, PSPS notifications, and available support services during a PSPS event. This network is comprised of nearly 200 CBOs who serve a critical role in connecting SDG&E with their constituencies.

In addition to strong tribal CBO partnerships, SDG&E has a dedicated Tribal Relations team that has implemented culturally appropriate communications and outreach based on feedback from tribes via listening sessions, online survey and focus groups.

SDG&E regularly engages with local governments at various levels with several teams that are dedicated to this audience. Regional Public Affairs team engages senior and elected officials while Emergency Management team works with first response and other emergency management agencies.

Key to SDG&E's stakeholder engagement is its relationships with emergency response agencies, locally and at the state level. SDG&E is widely recognized as a world-class innovator with its Fire Science and Climate Adaptation business unit. This team routinely provides best practices to other national utilities, as well as internationally. This cooperation, in addition to communication practices, lays the foundation for success in stakeholder cooperation and community engagement.

SDG&E collaborates with other California IOUs by participating in a series of weekly and monthly meetings to strategize and align where possible on wildfire and PSPS mitigations. Additionally, the Company has a membership with Chartwell, Inc., a national membership group for gas and electric utilities that collaborates on problem-solving opportunities and events to help utilities improve customer experience and operational efficiency. The EOC also regularly hosts tours for other utilities; trade groups; emergency response agencies/personnel; local, state, and federal agencies and representatives to share information, best practices, and resources.

8.5.1.1 Objectives

OEIS Table 8-53: Community Outreach and Engagement Initiative Objectives (3-year plan)

Objective Number	Objectives for Three Years (2023–2025)	Applicable Initiative(s), Tracking ID(s)	Applicable Regulations, Codes, Standards, and Best Practices (See Note)	Method of Verification (i.e., program)	Completion Date	Reference (section & page #)
8.5.01	Continue community outreach and public awareness efforts with year-round wildfire safety education and communication campaign	Weather Research and Forecast, WMP.532	PSPS OIR	Public Education campaign performance reporting and annual customer research	12/31/2099 (Ongoing)	8.5.2.1, p. 398
8.5.02	Solicit large-scale customer/ stakeholder feedback (campaign/notifications) for public education campaign	Weather Research and Forecast, WMP.532	PSPS OIR	Annual customer research/feedback	12/31/2099 (Ongoing)	8.5.2.4, p. 403
8.5.03	Refine and augment campaign and notifications for Annual Public education; expand reach based on customer/stakeholder feedback. Expand public education to AFN, LEP populations and Tribal communities.	Weather Research and Forecast, WMP.532	PSPS OIR	Annual customer research/ feedback used to refine and improve public-education campaign and notification messaging.	12/31/2099 (Ongoing)	8.5.2.4, p. 403
8.5.04	Promote and amplify PSPS, wildfire, and readiness messaging through CBO partnership activities	Public Emergency Communication Strategy, WMP.563	PSPS OIR	Tracking of activities through specific hashtags assigned to CBOs. Preparedness and PSPS support services information presented to and distributed by CBOs to constituents.	12/31/2099 (Ongoing)	8.5.4, p. 409
8.5.05	Assess and resolve any customer support and communications gaps identified through AFN stakeholders	Engagement with Access and Functional Needs Populations, WMP.1336	PSPS OIR	Annual customer surveys, Regional Working Group, and Statewide AFN Advisory Council	12/31/2099 (Ongoing)	8.5.3, p. 407
8.5.06	Establish broader engagement and deeper planning with emergency and non-emergency planning agencies	Other – Community Engagement, WMP.1337	GO 166 PSPS OIR	Emergency Plans stakeholder list and contact list	12/31/2099 (Ongoing)	8.5.4, p. 409
8.5.07	Enhance multiple mobile apps and communication platforms including school communication platforms	Weather Research and Forecast, WMP.532	PSPS OIR	Mobile app performance and school outreach reporting	12/31/2099 (Ongoing)	8.5.2.4, p. 403

OEIS Table 8-54: Community Outreach and Engagement Initiative Objectives (10-year plan)

Objective Number	Objectives for Ten Years (2026–2032)	Applicable Initiative(s), Tracking ID(s)	Applicable Regulations, Codes, Standards, and Best Practices (See Note)	Method of Verification (i.e., program)	Completion Date	Reference (section & page #)-
8.5.08	Establish more formalized processes of learning from peers in and outside the state	Other – Community Engagement, WMP.1337	PSPS OIR	In State: Monthly Joint IOU Working Group Outside: Chartwell – national utility industry research and consortium resource	12/31/2099 (Ongoing)	8.5.5, p. 411
8.5.09	Utilize enhanced partnerships with AFN and Limited English Proficiency (LEP) populations to reduce impacts of PSPS and wildfire mitigation measures to those populations	Access and Functional Needs Engagement, WMP.1336	PSPS OIR	Public Education materials are offered in the prevalent languages spoken in the region. Engaging/leveraging CBOs	12/31/2099 (Ongoing)	8.5.3.1, p. 407
8.5.10	Enhance communication channels and utilize technology to create more accessibility	Public Emergency Communication Strategy, WMP.563	PSPS OIR	Public Education efforts utilize a variety of technological platforms and tactics to reach customers and the public. Enhancements are made annually.	12/31/2099 (Ongoing)	8.5.3.1, p. 407
8.5.11	Refine and augment campaign and notifications for Annual Public education campaign and expand reach based on customer/stakeholder feedback	Other – Community Engagement, WMP.1337	PSPS OIR	Annual customer research/feedback used to refine and improve public-education campaign and notification messaging.	12/31/2099 (Ongoing)	8.5.3.5, p. 408
8.5.12	Expand exercise program via exercises of increasing complexity to include external stakeholders	Other – Community Engagement, WMP.1337	Best Practice	Annual customer research/feedback used to refine and improve public-education campaign and notification messaging.	12/31/2099 (Ongoing)	8.5.2.4, p. 403

8.5.1.2 Targets

OEIS Table 8-55: Community Outreach and Engagement Initiative Targets by Year

Initiative Activity	Tracking ID	2023 Target & Unit	% Risk Impact 2023	2024 Target & Unit	% Risk Impact 2024	2025 Target & Unit	% Risk Impact 2025	Method of Verification
Customer Feedback Outreach Surveys	WMP.532	Solicit large-scale customer/ stakeholder feedback at least twice annually to incorporate into future plans	n/a	Continue soliciting large-scale customer/ stakeholder feedback at least twice annually to incorporate into future plans	n/a	Continue soliciting large-scale customer/ stakeholder feedback at least twice annually to incorporate into future plans	n/a	Updates to plans (CEADPP, and AFN Plan) List of surveys

OEIS Table 8-56: PSPS Outreach and Engagement Initiative Targets by Year

Initiative Activity	Tracking ID	Target End of Q2 2023 & Unit	Target End of Q3 2023 & Unit	End of Year Target 2023 & Unit	% Risk Impact 2023	Target End of Q2 2024 & Unit	Target End of Q3 2024 & Unit	End of Year Target 2024 & Unit	% Risk Impact 2024	Target 2025 & Unit	% Risk Impact 2025	Method of Verification
PSPS Stakeholder Education and Awareness	WMP.1337	1	1	Host at least one functional PSPS exercise annually including relevant stakeholders	n/a	1	1	Host at least one functional PSPS exercise annually including relevant stakeholders	n/a	Host at least one functional PSPS exercise annually including relevant stakeholders	n/a	Detailed tracking of exercises, dates and attendees

8.5.1.3 Performance Metrics Identified by the Electrical Corporation

OEIS Table 8-57: Community Outreach and Engagement Performance Metrics Results by Year

Performance Metrics	2020	2021	2022	2023 Projected	2024 Projected	2025 Projected	Method of Verification (e.g., third-party evaluation, QDR)
Percentage of customers notified prior to a PSPS event impacting them	96%	99%	n/a	100%	100%	100%	QDR
Percentage of individuals with AFN who were aware of what support and resources were available to them during a PSPS event.	n/a	n/a	n/a	80%	80%	80%	Survey response tracker
Percentage of individuals with AFN who were able to use necessary medical equipment to maintain necessary life functions for the duration of any PSPS event that affected them	n/a	n/a	n/a	80%	80%	80%	Survey response tracker
Percentage of individuals who utilized mitigation services and reported they were satisfied with the level of support	n/a	n/a	n/a	80%	80%	80%	Survey response tracker

8.5.2 Public Outreach and Education Awareness Program

8.5.2.1 Description of the program(s).

The wildfire safety public outreach and education program was developed with the intent of increasing community resiliency to wildfire preparedness and mitigating the impact of PSPS events. The plan is divided into three phases: prior to, during, and following conditions that increase the risk of wildfire or a PSPS event.

8.5.2.1.1 Wildfire and PSPS Safety Communications Prior to Events

Prior to an event, communication efforts focus on educating customers and the general public. The Wildfire Safety Community Awareness campaign helps the community prepare for the risk of wildfires and PSPS events and encourages customers and the public to take preparedness measures such as updating their profile contact information and signing up for notifications. Local public safety and community partnerships such as 211 San Diego, 211 Orange County, Facilitating Access to Coordinated Transportation (FACT), the San Diego County AFN Working Group, and the American Red Cross help disseminate important information to potentially impacted and vulnerable communities.

A dedicated AFN public-education campaign is activated every year leading up to and during wildfire season. The campaign informs customers and the public about available services through collaboration with local CBOs including 211 San Diego, 211 Orange County, FACT, and others. Key materials are produced in prevalent languages spoken in the region.

Communications include:

- Promotion of community engagement events, emergency preparedness workshops, safety fairs, and public participation meetings
- General Market TV
- Streaming TV
- General Market Radio
- Streaming Radio
- Radio Sponsorships (Traffic, News, Weather)
- Out-Of-Home (Bulletins/Posters/Transit)
- Digital (Banner Ads, Mobile Phone Ads, Online Video, Paid Search, Paid Social)
- Print Advertising
- Community newspapers in the HFTD and the service territory (Back Country, Spanish, Asian, African American, General Market)
- Educational information disseminated through a bill newsletter or special insert included in customer bills
- A series of wildfire safety and preparedness videos and new vignettes to help customers and the public prepare for wildfire and PSPS
- Distribution of an annual Wildfire Safety newsletter that is mailed to customers in the HFTD
- Promotion of weather information and system-outage status on SDGE.com
- Paid and organic social media messaging that includes platforms like Twitter, Facebook, and Nextdoor

- Partnership with a network of over 400 non-profit and community-based organizations who share fire safety and emergency communications with their networks
- Print and broadcast media outreach
- Direct communications to customers about resources and services available to them before and during a PSPS

8.5.2.1.2 Wildfire Safety Communications During PSPS Events

Notifications, media updates, in-community signage, and situational awareness postings are used across social media and social media kits are shared with community partners to reach a broad audience during all hazard events. Additionally, affected customers and the public are provided with the latest real-time updates during a PSPS event. Key communications are available in 22 prevalent languages.

A dedicated AFN liaison is responsible for conveying real-time updates to AFN community partners. Communication platforms, including social media channels, broadcast and print media, and the SDG&E NewsCenter and website, are also used to share enhanced support services available for individuals with AFN. A digital document is also produced and distributed that lists communities affected by a PSPS event and is shared with local municipalities and agencies.

In addition to mass media, communications channels geared towards individuals who may not be account holders (e.g., visitors, mobile home park residents, caretakers, etc.) are utilized. These channels include SDG&E's PSPS Mobile Application (Alerts by SDG&E), roadside electronic message signs placed in strategic, highly traveled locations, tribal casino marquees, and flyers posted around impacted communities.

8.5.2.1.3 PSPS Notifications

PSPS notifications are sent to all impacted individuals as soon as possible through the ENS (recorded voice message, email, and text message). Notifications are available in American Sign Language video, audio read-out, and written transcript. These alerts are also provided in the 22 prevalent languages in the service territory. Address-level alerts are also enabled for customers and the general public through the Alerts by SDG&E application.

The content library of PPS email, text, and voice notifications for customers and non-account holders is evaluated annually. Feedback solicited from and provided by customers who have been notified and affected by PPS events is used to simplify notification messaging and make content more representative of the conditions being experienced.

For MBL and Live Support Customers, results of each ENS campaign are reviewed to determine if a positive confirmation was received through a voice contact (landline or cell phone, based on the customer's preferred contact number). For any MBL customers that are not reached by voice contact, a list is provided to the Customer Contact Center, who proactively calls customers that have not been contacted. If they are unsuccessful in contacting the customer, a Customer Service Field representative is sent to the service address. Customer Service Field representatives are trained on the County of San Diego's First Responder AFN Training Series to promote an empathetic and supportive approach for customers with AFN.

8.5.2.1.4 Wildfire Safety Communications After an Event

After a high wildfire/PSPS season, communications to customers and the general public are reviewed and evaluated. Feedback is solicited from affected customers on communications related to the event. This feedback is then used to improve customer and public communications and outreach efforts for the following year.

8.5.2.2 Target Community Groups across the Service Territory.

The AFN-specific strategy for outreach and education leverages a multipronged approach. The list of target groups in OEIS Table 8-58 is assembled through direct feedback from the AFN Collaborative Council, AFN Core Planning Team, Regional PSPS Working Group, market research, surveys, and the AFN self-identification campaign. As a result of feedback and research from CBOs, local governments, and tribes who support AFN populations, SDG&E is committed to continuously reviewing the needs of individuals with AFN before, during, and after PSPS to enhance support for those individuals who rely on electricity to maintain life functions, including durable medical equipment and assistive technology. Although 2022 did not provide an opportunity to gather feedback, our base-level support strategies are established based on lesson learned in prior years.

OEIS Table 8-58: List of Target Communities

Target Community Group	Interests or Concerns Before, During, and After Wildfire and PSPS
Non-English speakers	Limited access to understand electrical corporation wildfire hazards and risks, specific actions that can be taken to reduce risk, and awareness of emergency services, resources, etc.
People in remote or isolated areas	Limited access to resources such as transportation and/or the ability to receive emergency notifications, specific actions that can be taken to reduce risk and awareness of emergency services.
Elderly (Seniors 62+)	Impaired physical mobility, diminished sensory awareness, chronic health conditions, and/or social and economic limitations that interfere with their ability to prepare for, react and recover from a wildfire or a PSPS event.
People with limited technology	Limited and/or no access to emergency notifications, limited understanding of electrical corporation wildfire hazards and risks, specific actions that can be taken to reduce risk, and awareness of emergency services, resources, etc.
Customers enrolled in utility program: CARE, FERA, MBL, including Life Support (Critical Care)	Maintaining current self-certification status renewal to ensure accurate and timely emergency notifications are received.
Customer with disabilities	Ensuring awareness of individuals who have mobility, hearing, learning, or seeing disabilities and providing education on resources available to further support these customers during an emergency.
Customers who receive their bill in an alternate format (e.g., Braille, large print)	Limited ability to digest educational material, collateral, and emergency notifications if not presented in an alternate format.
Customers who self-identify as AFN or an individual with AFN in the household	Limited ability to understand the requirements and limited knowledge of the self-identification process.
Tribal members	Difficult to reach due to diversity – some live on reservations, some off, some are a part of federally recognized tribes and others are not. Increased risk due to their location in remote and/or HFTD areas with limited access to broadband, limited technology, health disparities, and impacted by socioeconomic factors.

8.5.2.3 Community Partners

OEIS Table 8-59: List of Community Partners

Community Partners	County	City
Access to Independence	San Diego	San Diego
American Red Cross San Diego/Imperial Counties	San Diego	San Diego
American Red Cross-Orange County Chapter	Orange	Irvine
Animal Fire Rescue Training	San Diego	San Diego
ARC of San Diego	San Diego	San Diego
Burn Institute- San Diego	San Diego	San Diego
Burn Institute- San Diego	San Diego	San Diego
California Emergency Services Association	San Diego	San Diego
California State Wildlife Foundation	San Diego	San Diego
Chula Vista Fire Department CERT	San Diego	Chula Vista
Chula Vista Fire Department CERT	San Diego	Chula Vista
Chula Vista Fire Department Teen CERT	San Diego	Chula Vista
City of Carlsbad CERT	San Diego	Carlsbad
City of Dana Point	San Diego	Dana Point
City of Del Mar CERT Program	San Diego	Del Mar
City of Encinitas CERT	San Diego	Encinitas
City of La Mesa - East County CERT	San Diego	La Mesa
City of National City	San Diego	National City
City of San Juan Capistrano	San Diego	San Juan Capistrano
City of Solana Beach CERT Program	San Diego	Solana Beach
County of San Diego - San Diego County Fire Protection District	San Diego	San Diego
Deaf Community Services of San Diego, Inc.	San Diego	San Diego
ElderHelp of San Diego	San Diego	San Diego
Elfin Forest/Harmony Grove CERT	San Diego	San Diego
Escondido Fire	San Diego	Escondido
Fire Safe Council Of San Diego County	San Diego	San Diego
Firefighteraid	San Diego	San Diego
Girl Scouts, San Diego-Imperial Council, Inc.	San Diego	San Diego

Community Partners	County	City
Home of Guiding Hands - Main Office	San Diego	San Diego
Info Line of San Diego County/2-1-1 San Diego	San Diego	San Diego
Info Line of San Diego County/2-1-1 San Diego	San Diego	San Diego
InfraGard San Diego	San Diego	San Diego
Inter Tribal Long Term Recovery Foundation	San Diego	San Diego
Isle of Dogs	San Diego	San Diego
Lumbercycle	San Diego	San Diego
Mama's Kitchen	San Diego	San Diego
Meals On Wheels Greater San Diego, Inc.	San Diego	San Diego
Miramar College Foundation Inc	San Diego	San Diego
Neighborhood House Association (Administrative Offices)	San Diego	San Diego
North County Fire Protection District	San Diego	San Diego
OceansideCERT	San Diego	
Options for All	San Diego	San Diego
Orange County Fire Authority Foundation	Orange	Irvine
Orange County Sheriffs Advisory Council	Orange	Irvine
Padres Foundation	San Diego	San Diego
People for Irvine Community Health dba 2-1-1 Orange County	Orange	Irvine
Philippine Nurses Association Of San Diego County Inc	San Diego	San Diego
Poway CERT	San Diego	Poway
Prevent Drowning Foundation Of San Diego	San Diego	San Diego
Rancho Santa Fe Fire Prevention District CERT Program	San Diego	San Diego
Salvation Army - California South Divisional Headquarters	San Diego	San Diego
San Diego Blood Bank	San Diego	San Diego
San Diego County Fire Chiefs Assoc Training Officers Section	San Diego	San Diego
San Diego Fire-Rescue Foundation	San Diego	San Diego
San Diego Police Foundation	San Diego	San Diego

Community Partners	County	City
San Diego Regional Fire & Emergency Services Foundation	San Diego	San Diego
San Diego Seniors Community Foundation	San Diego	San Diego
San Miguel Fire District	San Diego	San Miguel
Second Harvest Food Bank of Orange County	Orange	n/a
Southern Indian Health Council, Inc.	San Diego	San Diego
Southwestern College Foundation	San Diego	San Diego
Spanish CERT	San Diego	San Diego
Valley Center Amateur Radio Club Inc	San Diego	Valley Center
Valley Center Community Emergency Response Team	San Diego	Valley Center
Valley Center Fire Department Foundation	San Diego	Valley Center

8.5.2.4 Outreach and Awareness Programs (WMP.1337)

Implementation of the outreach and awareness programs is done through approximately 50 CBOs from the Energy Solutions Partner Network that are either located in or serving customers in the HFTD. They are leveraged to provide notification support before, during, and after an event. SDG&E also partners with several CBOs to jointly host a series of educational events, known as Wildfire Safety Fairs and mini-wildfire safety fairs, which target both HFTD communities and hard-to-reach customers in the HFTD. These events aim at partnering with local organizations and internal departments to share key information about how to prepare for a wildfire or other potential emergencies, including a PSPS event. Feedback is also solicited from event attendees and responses are used to improve future outreach efforts. In addition, the WCRC, planned for completion by the end of 2023, will be an ongoing, valuable tool for community outreach and engagement. See Section 8.4.3.4 for more information.

Annually, SDG&E works with external communications specialists to identify the best industry practices and methods to reach customers and the general public across various tactics and platforms. Additionally, every year communication tactics and messaging are tested and customer and stakeholder feedback is solicited. This feedback is used to refine and improve communications for the following year.

Annual customer research is conducted to measure retention and comprehension of the public education communications and messaging. Corresponding results are used to improve communications for the following year. In addition, communication with tribal fire departments is utilized to increase resources to community members living on reservations. During a PSPS event, tribal first responders are responsible for making wellness checks. SDG&E continues to strengthen partnerships with CBOs and to increase tribal enrollment for MBL, AFN, and other support programs.

OEIS Table 8-60: Community Outreach and Education Programs

Core Activity	Event Type	Period of Application (Before, During, After Incident)	Name of Outreach or Education Program	Description of Program	Target Audience	Reference/ Link
Website information	Wildfire	Before, during and after	General Wildfire Safety	The website serves as a repository for wildfire safety resources for customers. It also provides information on PSPS events, wildfire safety projects, emergency preparedness, Community Resource Centers (CRCs) and more.	General public	https://www.sdge.com/our-commitment-wildfire-safety
PSPS Mobile App	PSPS	Before, during and after	Alerts by SDG&E Mobile Application	Now available in both English and Spanish, the Alerts by SDG&E mobile app allows customers to receive real-time updates on a PSPS event for up to five addresses. Information includes customized notifications, CRC information with GPS directions, and other real-time updates and safety information related to PSPS activities.	General Public	https://www.sdge.com/notifications
Public Safety Partner Mobile App	PSPS	Before, during and after	Public Safety Partner Mobile App	The Public Safety Partner mobile app, launched in September 2022, allows regional public safety partners to access information from the Public Safety Portal from the field on their mobile devices. Features include real-time map information linked to a secure GIS portal, the ability for partners to follow the PSPS status of one or more jurisdictions of their choice, customized push notifications, sectionalizing devices listed by community and a resource page that includes a social media tool kit, point of contact information, and community flyers.	Public Safety Partners	n/a

Core Activity	Event Type	Period of Application (Before, During, After Incident)	Name of Outreach or Education Program	Description of Program	Target Audience	Reference/ Link
SDG&E Alexa Skill	PSPS/Wildfire	Before, during and after	SDG&E Alexa Skill	This Alexa skill provides real-time updates and information on weather forecasts, Red Flag Warnings (RFWs), the FPI, air quality, the potential for a PSPS event, and where to find resources in the event of a PSPS event, as well as flex alerts.	General public	https://www.sdgenews.com/article/sdge-shares-latest-wildfire-safety-advancements-public-safety-power-shutoff-tips
Media Engagement	PSPS/Wildfire	Before, during and after	Media Outreach	Partnerships with local broadcast and print media continue to inform customers of proactive safety and preparedness outreach prior to, during, and after a PSPS event or wildfire. Local broadcast and print media, including designated emergency broadcast radio, amplify messaging during a wildfire or PSPS event. Press updates are also posted to SDGNews.com and on social media channels.	General public	https://www.sdgenews.com/wildfire-weather
PSPS Paid Campaign	PSPS	Before	PSPS Communications Campaign	The PSPS paid campaign started in June and will be in the market for the remainder of the year. Messaging informs customers of the latest technology advancements to further refine the decision-making required when activating a PSPS. Additionally, it provides tips and resources available during a PSPS event and explains the customer journey, including decision-making process, what to expect during a PSPS event, the resources available, and where to go to receive support services. Additional communication tools include, but are not limited to: social media, including local community social media pages; print, digital and	General Public	n/a

Core Activity	Event Type	Period of Application (Before, During, After Incident)	Name of Outreach or Education Program	Description of Program	Target Audience	Reference/ Link
				<p>outdoor advertising; wildfire Safety Fairs; in-Community events; in-Community newsletters, newspapers; community bulletins/posters, community stores, supermarkets, laundromats, barber shops; airport, train and bus depot video monitor messaging; athletic event/stadium ads; increased local broadcast media and journalist education; message amplification by CBOs; and power outage and preparedness videos.</p>		

8.5.3 Engagement with Access and Functional Needs Populations (WMP.1336)

8.5.3.1 Overview

A dedicated AFN campaign is activated annually. This campaign promotes available solutions to customers via partnerships with entities such as 211, FACT, and the Salvation Army. Additionally, the campaign promotes collaboration with local CBOs across the service territory, helping connect customers with services and resources available during a PSPS.

Partnerships with 211 San Diego and 211 Orange County continue to serve as resource hubs for AFN customers. FACT is engaged to provide accessible transportation, while Salvation Army is engaged to provide hotel stays. Additionally, warm food is dispatched to severely impacted areas. Following the 2020 season, this support model was adopted statewide. 211 staff help direct constituents to resources such as food delivery, transportation, hotel stays, and an extensive list of other services.

In addition, SDG&E leverages partnerships with CBOs within its Energy Solutions Partner network to provide general education and awareness on available resources for individuals with an AFN before, during and after a PSPS event. The majority of these CBOs are small, grassroots agencies serving AFN customers, including those that are multicultural, multilingual, low income, seniors, and LEP audiences in communities of concern, and they serve as a critical channel to help amplify messaging and emergency notifications to customers located in the HFTD.

A public education campaign deploys mass-communications similar to the wildfire and PSPS campaigns and includes the same expansive set of tactics, all targeted towards vulnerable and hard-to-reach populations. A dedicated AFN landing page has links to available solutions and the AFN campaign provides additional awareness of this page.

Campaign tactics include, but are not limited to, digital banners, social media, TV and radio advertising, outdoor advertising, and print advertising. Print advertising, particularly in-language local community newspapers and magazine publications, help reach affected communities more readily as well as AFN and hard-to-reach audiences. Event-specific community flyers are also posted in community centers and high traffic areas in affected communities. These flyers are intended to reach audiences that may not have readily available internet or cable access.

Along with the public education campaign, PSPS messaging and creative assets are provided for the 211 websites and social media platforms. Digital versions of collateral, such as the HFTD Newsletter and the PSPS Resource Fact Sheet, are provided to 211 San Diego and 211 Orange County for inclusion on their websites.

8.5.3.2 Summary of Key AFN Demographics

There are approximately 423,000 customer accounts associated with AFN, of which approximately 44,000 are located within the HFTD (further breakdown of AFN population can be found in Appendix G) While the primary methodology for identifying AFN populations is through SDG&E's databases, customers can also self-identify through the Customer Contact Center and various marketing campaigns. Additionally, AFN Customers may be reached through local community partners who represent or provide services to these constituencies (e.g., 211 San Diego). Customers in the following categories are considered to AFN:

- Customers enrolled in CARE, Federal Emergency Relief Administration (FERA), MBL, Temperature Sensitive programs
- Customers who receive their utility bill in an alternate format: Braille, Large Font Bill
- Customers who preferred language is a language other than English
- Seniors (over age 62)
- Customers who self-identify to receive an in-person visit prior to disconnection for non-payment or self-identify as having a person with a disability in the household: disable deaf/hearing impaired, disabled blind/vision impaired, disability – not defined
- Customers who have self-identified as having an AFN

8.5.3.3 Evaluation of Challenges and Needs during a Wildfire or PSPS Event

SDG&E has established a partnership and works closely with an AFN Collaborative Council, AFN Core Planning team, Regional PSPS Working Group, local governments, and tribal communities to address the challenges and needs and how to support individuals with AFN during a PSPS event that are outlined in the AFN Plan (Appendix G). Where possible, SDG&E uses the best available information in order to evaluate AFN challenges and needs during a wildfire or PSPS event. Some sources include, but are not limited to, surveys, social media, commentary, customer inquiries, community forums, townhalls, wildfire safety fairs, etc.

8.5.3.4 Plans to Address Needs of the AFN Customer Base

SDG&E works closely with other IOUs and collaboratively with a statewide AFN Core Planning team to develop a Joint IOU Statewide strategy to meet the diverse needs of individuals with AFN before, during and after a PSPS event. The comprehensive annual plan reflects the geographical differences as well as the various needs of communities with AFN (see Appendix G).

8.5.3.5 Ongoing Feedback Practices (WMP.1337)

After a wildfire or PSPS event, SDG&E reviews and evaluates communications to customers and the public. Part of this process includes reaching out to affected customers to solicit feedback on communications related to PSPS events using a Resiliency Audit. This feedback is then used to improve customer and public communications and outreach efforts for the following year. Customer feedback informs the Compliance Report on Effectiveness of 2022 Outreach to refine and improve public education messaging and tactics.

The Resiliency Audit is an online survey that engages with all customers in the HFTD to help them increase overall resiliency and prepare for PSPS events. The offering launches annually in Q3 and is promoted through direct customer invitations, wildfire safety fairs, and SDG&E's annual wildfire newsletter. Customers are encouraged to answer a brief series of questions to assess and enhance their knowledge about how to stay up to date on preparedness essentials. Upon answering the questions, customers receive personalized resources that are customized to their survey responses. Resources include emergency and vehicle supply lists, information on backup power solutions, guidance on how to sign up for access and functional needs communications, and helpful community resources from the Red Cross, 211 San Diego, and the County Office of Emergency Services. Additionally, the survey provides information to support customers with various access and functional needs including references to specific resources and information on how to subscribe for additional programs and emergency

notifications. At the end of the survey, customers are encouraged to provide feedback on both their satisfaction with the survey as well as their needs for potential future offerings.

Feedback from the 2022 survey includes the following comments:

Thanks a million for the SDG&E generator! It's working well. Last year I attended a drive-through SDG&E seminar and got great info.

Thank you for the proactive attitude!

Thanks for being proactive, I'm new to the area and don't have experience with fire preparation

So great SDG&E is doing so much outreach on this topic! Thank you!!

8.5.4 Collaboration on Local Wildfire Mitigation Planning (WMP.1337)

By ensuring good communication and regularly strengthening relationships before, during, and after incidents the likelihood of achieving positive outcomes during emergencies is increased. A main goal of cooperating with first responders and suppression agencies is to prevent situations where a breakdown in communication could cause bodily injury. This is done with consistent exercises and gathering feedback.

Relationships with suppression agencies have been successfully built and in-person trainings at a Chief and engine level are provided throughout the year. Sponsorship of and participation in the County Wildland Exercise also brings together a variety of suppression and law enforcement agencies.

In addition to the cultural resources team, SDG&E has a Tribal Liaison Manager in the Public Affairs business unit that supports ongoing relationships with San Diego's diverse Tribal groups within the service territory. This position works with Tribal Governments to provide applicable notification of operation and maintenance activities on tribal lands as well as to partner with Tribes on community level charity and stewardship initiatives.

Additionally, Emergency Management collaborates with County and local jurisdictions in planning and plan writing efforts. In compliance of GO 166 regulations, Company Emergency and Disaster Preparedness Plans are reviewed annually with our public safety partners.

OEIS Table 8-61: Collaboration in Local Wildfire Mitigation Planning*

Name of County, City, or Tribal Agency or Civil Society Group (e.g., nongovernment organization, fire safe council)	Program, Plan, or Document	Last Version of Collaboration	Level of Collaboration
211 San Diego	Wildfire Preparedness	2022 version 06/2022	Wildfire Preparedness and Resiliency Workshop
Cal OES Office of Tribal Coordination	Wildfire Preparedness	2022 version 06/2022	Wildfire Preparedness and Resiliency Workshop
CAL FIRE	Wildfire Preparedness	2022 version 06/2022	Wildfire Preparedness and Resiliency Workshop

Name of County, City, or Tribal Agency or Civil Society Group (e.g., nongovernment organization, fire safe council)	Program, Plan, or Document	Last Version of Collaboration	Level of Collaboration
California Governor's Office of Emergency Services	Wildfire Preparedness	2022 version 06/2022	Wildfire Preparedness and Resiliency Workshop
California Public Utilities Commission	Wildfire Preparedness	2022 version 06/2022	Wildfire Preparedness and Resiliency Workshop
City of San Diego	Wildfire Preparedness	2022 version 06/2022	Wildfire Preparedness and Resiliency Workshop
County of San Diego OES	Wildfire Preparedness	2022 version 06/2022	Wildfire Preparedness and Resiliency Workshop
County of San Diego	Wildfire Preparedness	2022 version 06/2022	Wildfire Preparedness and Resiliency Workshop
CPUC	Wildfire Preparedness	2022 version 06/2022	Wildfire Preparedness and Resiliency Workshop
Metropolitan Water District of Southern California	Wildfire Preparedness	2022 version 06/2022	Wildfire Preparedness and Resiliency Workshop
Port of San Diego Harbor Police	Wildfire Preparedness	2022 version 06/2022	Wildfire Preparedness and Resiliency Workshop
Rainbow Municipal Water District	Wildfire Preparedness	2022 version 06/2022	Wildfire Preparedness and Resiliency Workshop
San Diego Community Power	Wildfire Preparedness	2022 version 06/2022	Wildfire Preparedness and Resiliency Workshop
San Diego County Fire Prot. District	Wildfire Preparedness	2022 version 06/2022	Wildfire Preparedness and Resiliency Workshop
San Diego County OES	Wildfire Preparedness	2022 version 06/2022	Wildfire Preparedness and Resiliency Workshop
San Diego Sheriff's Department	Wildfire Preparedness	2022 version 06/2022	Wildfire Preparedness and Resiliency Workshop
San Diego City Council, District 1	Wildfire Preparedness and Resiliency	04/2022	Wildfire Mitigation Program Emergency Operations Center Tour

**full table is in Appendix F*

OEIS Table 8-62: Key Gaps and Limitations in Collaborating on Local Wildfire Mitigation Planning

Subject of Gap or Limitation	Brief Description of Gap or Limitation	Strategy for Improvement
High Level of trust with stakeholders	Less than 5% of local government and civil society stakeholder groups seek collaboration activities.	Strategy – Create web content notifying the public, local government, and civil society organizations of the electrical corporation's resources to provide support on local wildfire mitigation planning efforts. Assign a local wildfire

Subject of Gap or Limitation	Brief Description of Gap or Limitation	Strategy for Improvement
		planning liaison to be available, as needed, for local planning efforts. Target timeline – Develop and post web content by May 2023 and hire two local wildfire planning liaisons by March 2023

8.5.5 Best Practice Sharing with Other Electrical Corporations (WMP.1340)

SDG&E continues to collaborate with other California IOUs in the form of ongoing meetings and public communications and resource sharing, as well as alignment on the type of communications feedback that is solicited by customers and the public. The IOUs meet on a regular (weekly and monthly) basis to discuss and share best practices and methods of communicating and reaching customers, particularly hard to reach populations.

One of the outcomes of this collaboration is the use of the statewide website: prepareforpowerdown.com. Currently the site promotes PSPS and wildfire resiliency information that supports AFN communities. This site will continue to be the focus of IOU collaboration in 2023 as well as additional promotional support for public awareness.

The IOUs will also continue to strategize and share best practices for outreach efforts such as Wildfire Open Houses and Safety Fair events. Collaboration will also continue for customer notifications during a PSPS or wildfire. This year the IOUs will continue to refine the notification process for shared customers (customers served by one utility's infrastructure but are customer-of-record with other utility).

OEIS Table 8-63: Table does not exist per OEIS guidelines

OEIS Table 8-64: Best Practice Sharing with Other Electrical Corporations

Best Practice Subject	Dates of Collaboration (YYYY-YYYY)	Technical or Programmatic	Electrical Corporation Partner(s)	Description of Best Practice Sharing or Collaborating	Outcome
Risk Modeling Working Group	2022-Ongoing	Technical	SCE, PG&E, Bear Valley, PacifiCorp, and Liberty	Working group meetings included information gathering and comparing risk modeling methodologies of the subject utilities.	Future working group meetings moving to understanding best practices and towards consistency on utility approaches to risk modeling.
Vegetation Line Clearances Working Group	2022	Technical and Programmatic	SCE and PG&E	Increase alignment among California electrical corporations related to line clearing data collection practices and record keeping of tree-caused risk events.	PG&E, SDG&E, and SCE chose a third-party consultant to establish the data collection standards, create the cross-utility database, and study the relationship between enhanced vegetation clearances and tree-caused risk events.
Customer Communications PrepareForPowerDown.com	2020-Current	Programmatic	PGE, SCE, SDG&E	Weekly and monthly IOU meetings to share best practices and resources. AFN collaboration on PrepareForPowerDown.com PSPS/Wildfire Customer Notification best practices Customer Feedback to improve communications	Ongoing <ul style="list-style-type: none"> • Communications/messaging strategy • Outreach/Communication Tactics best practices • AFN Resources • Customer Research/Feedback Solicitation alignment

9 Public Safety Power Shutoff

9.1 Overview

Once a risk mitigation plan is developed and documented, SDG&E uses a comprehensive approach to identify a portfolio of risk mitigation initiatives. This includes identification of detailed design, implementation, operations, and long-term maintenance of mitigations. The fifth step of the Enterprise Risk Management Framework is Risk-Informed Investment Decisions & Risk Mitigation Implementation (see Figure 9-1). See Section 4.4 Risk Informed Framework for details on the Enterprise Risk Management Framework.

Figure 9-1: Risk-Informed Investment Decision & Risk Mitigation Implementation Step of the Enterprise Risk Management Framework



9.1.1 Key PSPS Statistics

OEIS Table 9-1: PSPS Event Statistics

Year	#No. of Events	Total Circuits De-energized*	Total Customers Impacted	Total Customer Minutes of Interruption
2017	5	37	17,619	39,503,820
2018	4	46	30,069	62,665,380

Year	#No. of Events	Total Circuits De-energized*	Total Customers Impacted	Total Customer Minutes of Interruption
2019	4	58	49,880	78,283,380
2020	5	98	100,537	157,907,040
2021	1	14	5,858	8,866,020
2022	0	0	0	0

**Unique, nominal circuits; includes 4 kV circuits that were de-energized as a result of the upstream 12 kV circuit experiencing a PSPS.*

9.1.2 Identification of Frequently De-energized Circuits

Fifteen circuits experienced three or more PSPS events in a calendar year since 2018. PSPS mitigation efforts are focused on the specific areas of circuits that have the highest risk of PSPS events. The three mitigation programs that are the most efficient at reducing PSPS risk and consequence for customers are the Strategic Undergrounding Program (WMP.473) (see Section 8.1.2.2), PSPS Sectionalizing Program (WMP.461) (see Section 8.1.2.11.1), and SDG&E's three customer backup resiliency programs: Standby Power Program (WMP.468) (see Section 8.1.2.11.2), GGP (WMP.466) (see Section 8.1.2.11.3), and GAP (WMP.467) (see Section 8.1.2.11.4). The efficacy of these programs to reduce PSPS risk and consequence is heavily dependent on weather, environmental, and system conditions.

The backup resiliency programs do not provide PSPS risk reduction but reduce the consequence of PSPS to vulnerable customers when the decision to de-energize is inevitable. Through 2022, 1,540 customers have and will continue to benefit from backup resiliency programs, with customers on these circuits in scope to be targeted in 2023.

The PSPS Sectionalizing Program provides the ability to de-energize only the portion of a circuit that is at highest risk. There are 71 SCADA sectionalizing devices across these 15 circuits, giving SDG&E the ability to strategically de-energize only where risk thresholds are met.

With the cost of undergrounding electric lines decreasing significantly over the last few years and the evolution of risk modeling to incorporate PSPS impacts, mitigation recommendations have put increased emphasis on the strategic undergrounding of electric lines. To date, SDG&E has completed 68.16 miles of undergrounding and plans to underground 178.02 miles by 2025 and 393.1 miles by 2032. Two of the fifteen frequently de-energized circuits will be completely undergrounded within 10 years.

See OEIS Table 9-2 for the list of circuits and a breakdown of mitigation efforts. It is worth noting that customers may benefit from multiple mitigation efforts, therefore customer counts provided per effort may overlap.

See response to Areas for Continued Improvement SDGE-22-29 in Appendix D.

OEIS Table 9-2: Frequently De-energized Circuits*

Entry #	Circuit ID	Name of Circuit	Dates of Outages	Number of Customers Served by Circuit	Number of Customers Affected	Measure taken, or planned to be taken, to reduce the need for and impact of future PSPS of circuit	Number of Customers Mitigated (through 2022)	Future Customer Mitigations
1	1030	n/a	Jan 28-29, 2018 Nov 12-15, 2018 Oct 10-11, 2019 Oct 24-25, 2019 Oct 30-31, 2019 Sept 9, 2020 Dec 2-4, 2020 Dec 7-9, 2020 Dec 23-24, 2020	1303	1,258 649 30 185 1,341 30 1,182 1,363 30	Strategic Undergrounding: 43.52 miles completed to date; 13.7 miles in scope to be completed by 2025; 29.3 miles in scope to be completed by 2032 PSPS Sectionalizing: 7 SCADA reclosers available for sectionalizing Backup Resiliency Programs: 185 customers have participated to date; customers will be invited to participate in 2023	Strategic Undergrounding: 513 Sectionalizing: 405-1003 BRP: 185	Strategic Undergrounding: 159
2	1166	n/a	Nov 12-13, 2018 Oct 24-25, 2019 Oct 30, 2019 Dec 2-4, 2020 Dec 7-8, 2020 Dec 23-24, 2020 Nov 25-26, 2021	172	268 267 327 322 60 322 113	Strategic Undergrounding: Circuit will be considered for undergrounding in 2026 PSPS Sectionalizing: 3 SCADA reclosers available for sectionalizing Backup Resiliency Programs: 40 customers have participated to date; customers will be invited to participate in 2023	Sectionalizing: 60-78 BRP: 40	n/a
3	1215	n/a	Jan 28-29, 2018 Nov 11-14, 2018 Oct 24-26, 2019 Oct 30-31, 2019 Oct 27, 2020 Dec 2-4, 2020 Dec 7-8, 2020	144	146 135 136 136 133 144 133	Strategic Undergrounding: 20.8 miles in scope to be completed by 2025; 7.5 miles to be completed by 2032 PSPS Sectionalizing: 4 SCADA reclosers available for sectionalizing Backup Resiliency Programs: 36 customers have participated to date; customers will be invited to participate in 2023	Sectionalizing: 11-63 BRP: 36	Strategic Undergrounding: 143
4	157	n/a	Nov 12-15, 2018 Oct 24-26, 2019 Oct 30-31, 2019 Dec 2-4, 2020	1023	1,015 653 652 1,028	Strategic Undergrounding: 10.8 miles in scope to be completed by 2031 PSPS Sectionalizing: 7 SCADA reclosers available for sectionalizing	Sectionalizing: 312-796 BRP: 118	Strategic Undergrounding: 94

Entry #	Circuit ID	Name of Circuit	Dates of Outages	Number of Customers Served by Circuit	Number of Customers Affected	Measure taken, or planned to be taken, to reduce the need for and impact of future PSPS of circuit	Number of Customers Mitigated (through 2022)	Future Customer Mitigations
			Dec 7-9, 2020 Dec 23-24, 2020 Nov 25-26, 2021		614 660 708	Backup Resiliency Programs: 118 customers have participated to date; customers will be invited to participate in 2023		
5	214	n/a	Jan 28-29, 2018 Oct 15, 2018 Nov 12-14, 2018 Oct 24-26, 2019* Oct 30-31, 2019 Dec 2-4, 2020* Dec 7-9, 2020* Dec 24, 2020* Nov 25, 2021	882	359 360 360 755 365 883 882 883 371	Strategic Undergrounding: 57.4 miles in scope to be completed by 2025 PSPS Sectionalizing: 7 SCADA reclosers available for sectionalizing Backup Resiliency Programs: 59 customers have participated to date; customers will be invited to participate in 2023	Sectionalizing: 487-846 BRP: 59	Strategic Undergrounding: 706
6	215	n/a	Oct 25-26, 2019 Oct 30-31, 2019 Dec 3-4, 2020 Dec 7-8, 2020 Dec 24, 2020	519	495 495 510 385 385	Strategic Undergrounding: 25.2 miles in scope to be completed by 2032 PSPS Sectionalizing: 4 SCADA reclosers available for sectionalizing Backup Resiliency Programs: 83 customers have participated to date; customers will be invited to participate in 2023	Sectionalizing: 110-418 BRP: 83	Strategic Undergrounding: 477

*full table is in Appendix F

Note: Utility Initiative tracking ID numbers for Strategic Undergrounding Program is WMP.473, PSPS Sectionalizing Program is WMP.461, and Backup Resiliency Programs is WMP.468, WMP.466, and WMP.467.

Figure 9-2: Frequently De-Energized Circuits

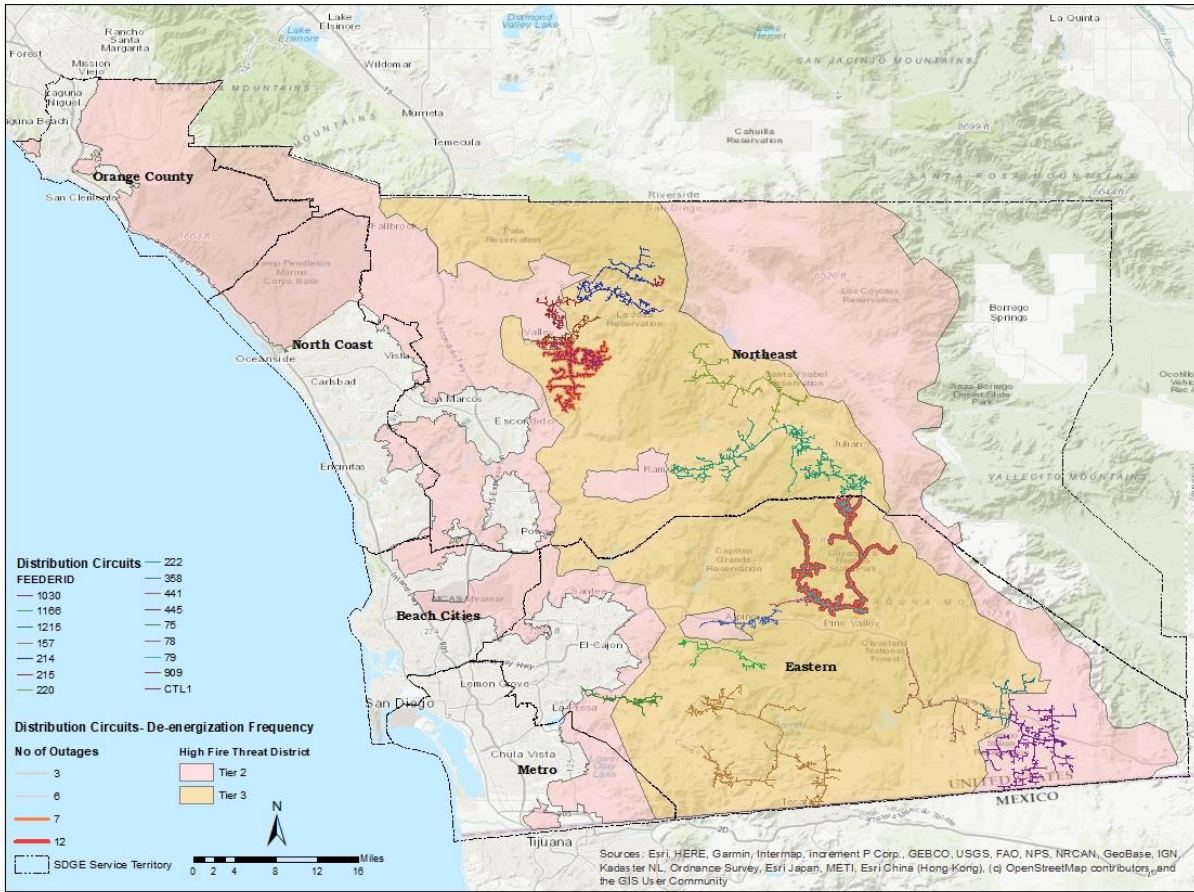

9.1.3 Objectives

OEIS Table 9-3: PSPS Objectives (3-year plan)

Objective Number	Objectives for Three Years (2023–2025)	Applicable Initiative(s), Tracking ID(s)	Applicable Regulations, Codes, Standards, and Best Practices (See Note)	Method of Verification (i.e., program)	Completion Date	Reference (section & page #)
9.1.01	Continue grid hardening and customer backup resiliency initiatives to mitigate PSPS impacts for approximately 30,000 customers by 2025	Undergrounding of electric lines and/or equipment; WMP.473 PSPS Sectionalizing Enhancements; WMP.461 GGP; WMP.466 Standby Power Programs; WMP.468 GAP; WMP.467 Microgrids; WMP.462	See Section 8.1.1.1, Table 8.3 for applicable regulations, codes, standards, and best practices for each of the listed programs	See Section 8.1.1.1, Table 8.3 for method of verification for each of the listed programs	12/31/2025	8.1.2.2, p. 158 8.1.2.11.1, p. 181 8.1.2.11.2, p. 181 8.1.2.11.3, p. 184 8.1.2.11.4, p. 185 8.1.2.7, p. 167
9.1.02	Continue improving service territory situational awareness during periods of high risk by improving existing FPI and SAWTI models and noting and evaluating discrepancies between predictions and observed reality.	Fire Potential Index; WMP.450 Santa Ana Wildfire Threat Index; WMP.540	n/a	FPI Model documentation SAWTI Model documentation	12/31/2099 (Ongoing)	8.3.5, p. 326 8.3.6, p. 335
9.1.03	Continue developing WiNGS-Ops models to assess wildfire and PSPS risk. Continue evaluating customer impacts during PSPS events.	Risk Assessment and Mapping; WMP.442	n/a	WiNGS-Ops model documentation Probability of Failure and Ignitions model documentation	12/31/2099 (Ongoing)	6.7, p. 96
9.1.04	Integrate FPI into OMS for future protective equipment threshold setting improvements	FPI; WMP.450	n/a	NMS enhancement documentation	12/31/2024	8.3.3.3, p. 315

Objective Number	Objectives for Three Years (2023–2025)	Applicable Initiative(s), Tracking ID(s)	Applicable Regulations, Codes, Standards, and Best Practices (See Note)	Method of Verification (i.e., program)	Completion Date	Reference (section & page #)
9.1.05	Continue improving customer notifications by enhancing the Enterprise Notification System (ENS)	PSPS Communication Practices; WMP.563	D.19-05-042 D.21-06-034	PSPS Post-Event Reports PSPS Post-Season Reports	12/31/2099 (Ongoing)	8.4.4 p.380
9.1.06	Prioritize CMP findings on high PSPS risk circuits	Distribution Overhead Detailed Inspections; WMP.478	n/a	QDR Table 13	12/31/2099 (Ongoing)	8.1.3, p. 187 8.1.7, p. 236 10.1, p. 432
9.1.07	Supplant VRI with a predictive model for the likelihood of vegetation related failures.	Risk Assessment Improvement Plan WMP.1339	n/a	New model documentation	12/31/2025	6.7, p. 96
9.1.08	Continue benchmarking with IOUs on best practices	Best Practice Sharing with Other Electrical Corporations; WMP.1340	D.21-06-014	Joint IOU Working Group Reports	12/31/2099 (Ongoing)	8.5.5, p. 411

OEIS Table 9-4: PSPS Objectives (10-year plan)

Objective Number	Objectives for Ten Years (2026–2032)	Applicable Initiative(s), Tracking ID(s)	Applicable Regulations, Codes, Standards, and Best Practices (See Note)	Method of Verification (i.e., program)	Completion Date	Reference (section & page #)
9.1.09	Continue to explore areas of high risk for additional grid hardening and customer backup resiliency initiatives to mitigate PSPS impacts to customers.	Undergrounding of electric lines and/or equipment; WMP.473 PSPS Sectionalizing Enhancements; WMP.461 GGP; WMP.466 Standby Power Programs; WMP.468 GAP; WMP.467	See Section 8.1.1.1, Table 8.3 for applicable regulations, codes, standards, and best practices for each of the listed programs	See Section 8.1.1.1, Table 8.3 for method of verification for each of the listed programs	12/31/2032	8.1.2.2, p. 158 8.1.2.11.1, p. 181 8.1.2.11.2, p. 181

Objective Number	Objectives for Ten Years (2026–2032)	Applicable Initiative(s), Tracking ID(s)	Applicable Regulations, Codes, Standards, and Best Practices (See Note)	Method of Verification (i.e., program)	Completion Date	Reference (section & page #)
		Microgrids; WMP.462				8.1.2.11.3, p. 184 8.1.2.11.4, p. 185 8.1.2.7, p. 167
9.1.10	Continue benchmarking with IOUs on best practices	Best Practice Sharing with Other Electrical Corporations; WMP.1340	D.21-06-014	Joint IOU Working Group Reports	12/31/2099 (Ongoing)	8.5.5, p. 411

9.1.4 Targets

OEIS Table 9-5: PSPS Targets

Initiative Activity	Tracking ID	2023 Target & Unit	% Risk Impact 2023	2024 Target & Unit	% Risk Impact 2024	2025 Target & Unit	% Risk Impact 2025	Method of Verification
Standby Power Programs	WMP.468 (8.1.2.11.2)	300 Generators	33.33%	300 generators	33.33%	89 generators	19.9105%	Third-party data submission
Strategic Undergrounding	WMP.473 (8.1.2.2)	84 miles	4.7972%	125 miles	7.1387%	125 miles	7.6234%	Completed work order/GIS Data Submission(s)
PSPS Sectionalizing	WMP.461 (8.1.2.11.1)	10 switches	16.6667%	10 switches	16.6667%	10 switches	16.6667%	Completed work order/GIS Data Submission(s)
Microgrids	WMP.462 (8.1.2.7)	0 microgrids	0%	4 microgrids	98.8932%	0 microgrids	0%	Completed work order/GIS Data Submission(s)
Number of customers impacted	WMP.1352	47,857 customers	n/a	44,986 customers	n/a	42,287 customers	n/a	QDR

Initiative Activity	Tracking ID	2023 Target & Unit	% Risk Impact 2023	2024 Target & Unit	% Risk Impact 2024	2025 Target & Unit	% Risk Impact 2025	Method of Verification
Number of circuits de-energized	WMP.1353	59.03 circuits	n/a	55.49 circuits	n/a	52.16 circuits	n/a	QDR
Number of PSPS events	WMP.1354	3.76 events	n/a	3.53 events	n/a	3.32 events	n/a	QDR

After the active fire season of 2020, SDG&E performed a study to understand the weather factors impacting the need for an increased frequency of PSPS events that year. To begin, a dataset containing daily maximum wind gusts for all weather stations within the HFTD was created for days from 2017 through 2021 in which (1) the National Weather Service had issued an RFW for the service territory and (2) the FPI was rated either Elevated or Extreme. The data was then pared down to RFW events that coincided with an activation of the EOC for PSPS.

Knowing that all weather events are different, Meteorology developed a normalization algorithm to create a uniform PSPS score based on wind and fire weather conditions for all events dating back to 2017. The equation developed is:

$$PSPS\ Score = Top\ 20\ Gust\ Avg \times \% \text{ Weather Stations Above } 95^{th} \times \frac{FPI^2}{C}$$

where “Top 20 Gust Avg” is the average of the strongest 20 event maximum wind gusts recorded by weather stations within the HFTD, “% Weather Stations Above 95th” is the percentage of weather stations within the HFTD that recorded wind gusts at or in excess of their 95th percentile for Santa Ana wind events, and the FPI component takes the square of the numerical FPI value (0 to 17) and divides by a constant value of 289, which is the square of the highest FPI rating of 17. In this equation, the top gust component reflects the strength of the event, while the percentage of weather stations with measurements above their 95th percentile wind gust indicates how widespread the event was. For the FPI component, using the square of the maximum FPI rating of 17 in the denominator allows for an exponential variable where an Extreme FPI rating, which accounts for the potential for significant fire activity in the event of an ignition, has a heavier weight.

Creating scores for every PSPS event based on the wind conditions and fire weather environment then facilitates a means to compare historical PSPS events. Additional factors, including the number of affected customers, can also be included to track improvements in PSPS impact to customers for similarly scored events. See Figure 9-3 for cumulative historical PSPS Scores per year.

Figure 9-3: Cumulative Historical PSPS Score

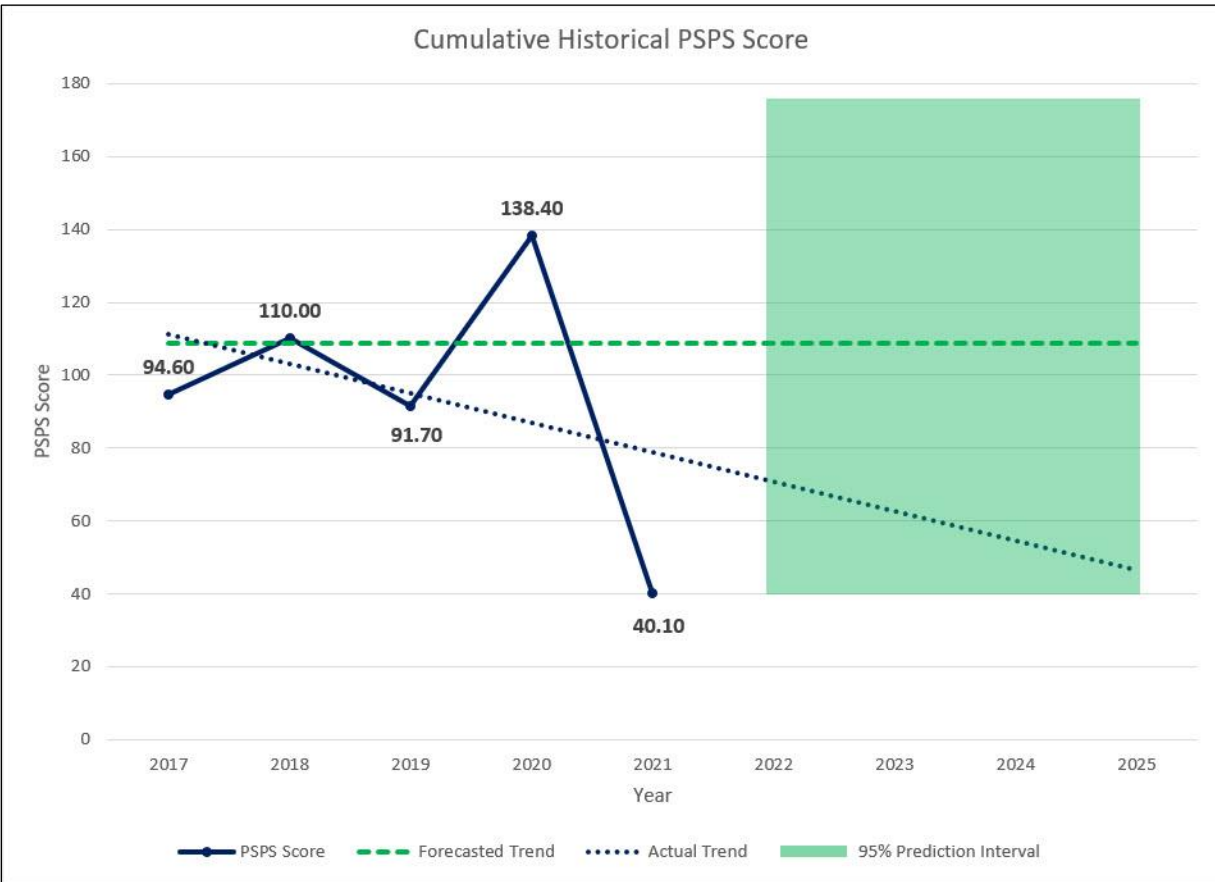

To forecast WMP PSPS targets to meet Energy Safety requirements, SDG&E employed a two-stage forecasting technique that integrates statistical models such as time series modeling and regression analysis. This approach enables SDG&E to generate forecasts of PSPS impact by utilizing historical data on PSPS scores over the past 5 years.

Given the number of weather and condition variables outside of SDG&E’s control, to accurately weigh the data the concept of exponential smoothing was employed to the historical data. Exponential smoothing is a mathematical technique that smooths out past observations by assigning exponentially decreasing weights to older observations. This technique was used to identify a trend for future PSPS scores for the years 2023 to 2025 (Figure 9-3). In addition to the trend analysis, linear regression analysis was utilized to determine the likelihood of future PSPS impact based on projected PSPS scores.

Once the projections were determined, a six percent year-over-year improvement was applied. This improvement percentage was developed using the expected impacts that PSPS mitigations (PSPS Sectionalizing WMP.461, Strategic Undergrounding WMP.473, Microgrids WMP.462, and Standby Power Program WMP.468) will achieve in reducing customer counts from the total unique meters that were impacted by PSPS from 2017 to 2021. These forecasted targets assume the weather pattern over the next 3 years is in line with the forecast methodology, and deviations from the forecast, either up or down, will drive the actuals above or below the forecast.

9.1.5 Performance Metrics

OEIS Table 9-6: PSPS Performance Metrics Results by Year

Performance Metrics	2020	2021	2022	2023 Projected	2024 Projected	2025 Projected	Method of Verification
Percent of customers being de-energized on PSPS circuits (WMP.1347)	63.4	39.5	n/a	39.70	37.32	35.08	QDR
Number of customers impacted by PSPS per 1000 RFW-OCM (WMP.1351)	1969	583	n/a	830.91	781.06	734.20	QDR
Number of circuits de-energized per event (WMP.1353)	26	13	n/a	14.73	13.85	13.02	QDR

SDG&E continues to perform mitigations that will reduce the scale, scope, and frequency of PSPS events. The Strategic Undergrounding Program (WMP.473), in particular, will continue to reduce the wildfire risk and PSPS impacts to customers. In the short term, however, the scale and frequency of PSPS events is largely weather driven. 2019 and 2020 saw large scale wind events across the service territory which drove above-average PSPS customer and circuit counts. SDG&E saw a large reduction in 2021 with just one event impacting approximately 5,800 customers and no PSPS events in 2022.

SDG&E improved its notification processes and tools between 2020 and 2021 and increased the percent of impacted customers notified prior to PSPS events from 95 percent to 99 percent. Moving forward, that number is expected to again increase and hold at 99.5 percent, as shown in Figure 9-4 and Figure 9-5.

In the future, PSPS events are expected to return to average levels with a reduction each year in the number of customers (as shown in Figure 9-4) and circuits (as shown in Figure 9-5) impacted by approximately 6 percent each year based on the work being done to underground the system. These results are likely to vary depending on the severity and location of high wind events. Furthermore, additional risk reduction is likely, though difficult to quantify, as full segments are converted to covered conductor. Installation of covered conductor is likely to raise wind speed thresholds (pending final testing and collaboration) to approximately 55 to 60 miles per hour.

SDG&E will continue to evaluate and refine forecasting for wildfire weather conditions that will impact PSPS metrics and decision-making in the future.

Figure 9-4: PSPS Customers Impact by RFW

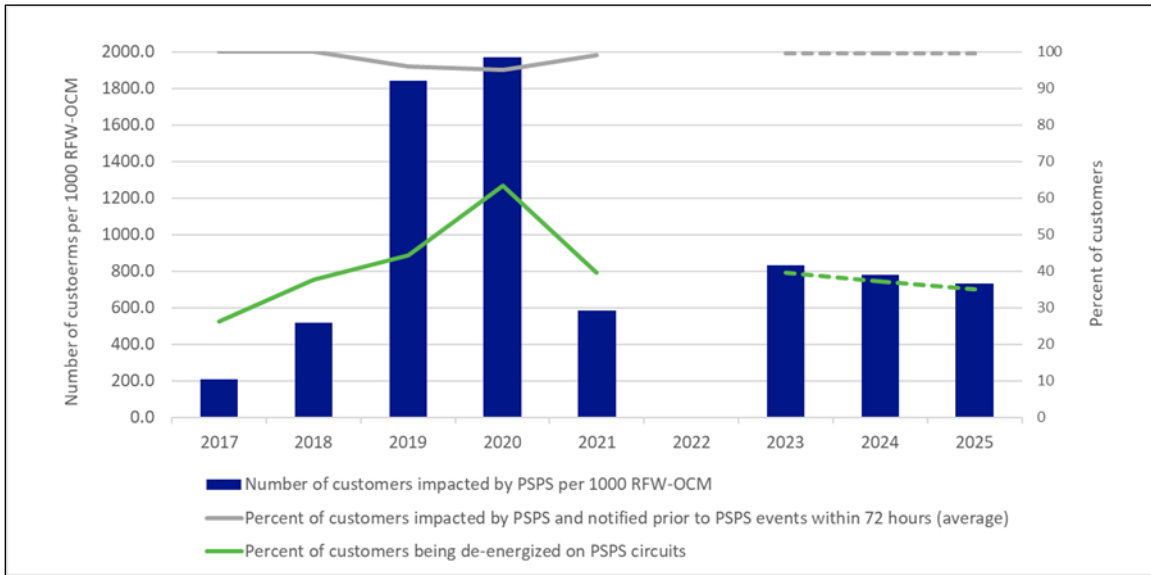
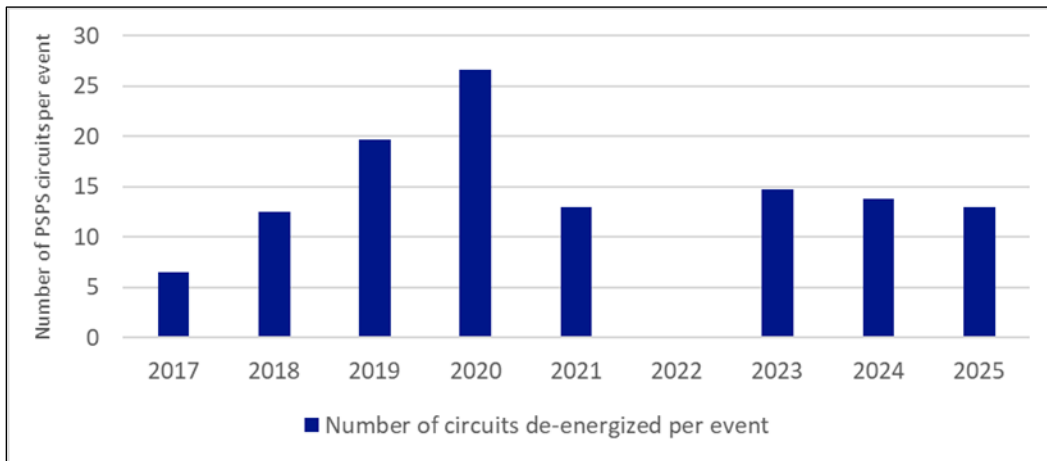

Figure 9-5: PSPS System Impact by RFW



9.2 Protocols on PSPS

9.2.1 Protocols that Determine the Need for PSPS

Multiple factors are considered when deciding to de-energize. The primary factors considered are as follows:

FPI (WMP. 450): The FPI has proven to be historically accurate in predicting the potential for large fires. It is a forecasted value based on measured data looking 7 days in the future. Certain components such as green-up and LFM do not materially change significantly over a 7-day period, while other components

such as specific wind speeds, atmospheric dryness, and DFM are more volatile and can change significantly. See Section 8.3.6 for more information on the FPI.

Red Flag Warnings: RFWs, issued by the National Weather Service, use similar weather data as used to determine the FPI, including conditions such as low humidity and high winds. A RFW is issued for weather events which may result in extreme fire behavior that will occur within 24 hours.

SAWTI (WMP.540): The SAWTI calculates the potential for large wildfire activity based on the strength, extent, and duration of the wind, dryness of the air, dryness of the vegetation, and greenness of the grasses. Similar to the hurricane-rating system, the SAWTI compares current environmental data to climatological data and correlates it with historical wildfires to rate a Santa Ana wind event using four threat levels that range from “marginal” to “extreme.” See Section 8.3.5.1.2 for more information on the SAWTI.

72-Hour Weather Circuit Forecast: Prior to an EOC activation, Meteorology issues a weather circuit forecast, which is a matrix of circuit-associated weather stations and numerous forecasted wind parameters. The 72-hour weather circuit forecast is a high-level forecast which includes Tiers or districts that could be impacted. The 48-hour and 24-hour weather circuit forecasts include a 48-hour peak gust value and time of achieving that gust, a 24-hour peak gust value and time of achieving that gust, earliest date/time to reach the 95th percentile, and the forecasted max gusts for all weather stations. The weather circuit forecast becomes a reference point to assess which areas demand greater focus as the event unfolds.

Vegetation Conditions and VRI: The VRI was developed internally using information from the Vegetation Management database and the Reliability database. The VRI is broken down into high, medium, and low risk. A circuit with a high VRI may require a more conservative wind speed shutoff decision in an extremely high-risk event. For example, on a day with an FPI rating of Extreme, where a RFW is declared and real-time wind speeds are exceeding their 95th percentile for a given circuit segment on the associated weather station, subject matter experts are consulted to confirm that winds are increasing and forecast to persist at high levels, and the VRI is considered high. This information, along with additional factors, will inform the decision to de-energize. If the VRI is low, the decision to de-energize may not be made until the 99th percentile wind is exceeded.

For details on VRI improvements, see Section 6.7 Risk Assessment Improvement Plan and response to Areas for Continued Improvement SDGE-22-09 and SDGE-22-25 in Appendix D.

Probability of Ignition/Probability of Failure: See Section 6.3 Risk Scenarios for more information on Pol/PoF.

Field Observations and Flying/Falling Debris: When an FPI rating of Extreme is forecast and a RFW is declared, QEWs are sent to various locations across the service territory based on where weather is forecasted to be the most extreme. These QEWs serve as field observers that report real-time observations. Field observers look for tree branches and unsecured customer items (tarps, umbrellas) or whether conductors are still, swaying, or galloping in the wind. Depending on the situation, a field observer may report on an hourly basis or may be asked to report on a more frequent basis. They also have the ability to radio in and declare if a situation is unsafe based on their observations. These field observer reports may inform decisions about the use of PSPS. These reports are not measurements, but

they provide strong qualitative situational awareness that is combined with other quantitative information sources for improved overall decision making.

Information from First Responders: During days with an FPI rating of Extreme and in preparation for potential PSPS events, many first responder agencies, including police and fire, are in active communication with SDG&E. These agencies provide information such as wind speeds that are too high to utilize helicopters to combat fires. An understanding that if a fire were to occur, some of the more impactful fire suppression resources would be unavailable, thus increasing the chance that a fire could become catastrophic, helps to inform decisions regarding PSPS. If a fire should occur, agencies such as CAL FIRE may request to de-energize a line for safety while suppressing a fire. These requests for de-energization are not considered PSPS events.

Meteorology including 10-year History, 95th and 99th Percentile Winds: Weather data plays a major role in PSPS decision making. There are currently 222 unique weather stations in various parts of the service territory that are tied to certain circuits or circuit segments.

The 95th and 99th percentile wind gusts are calculated values based on a statistical analysis of a 10-year history of 10-minute wind reads for each of the weather stations. The 99th percentile wind is the cutoff between the top 1 percent and the bottom 99 percent of wind speeds. The 95th percentile wind is the cutoff between the top 5 percent and the bottom 95 percent of wind speeds. Even if a given weather station has a low 99th percentile wind speed that is within the design criteria of most electric lines, several factors will still be considered to determine whether a PSPS is necessary, including if the area rarely sees that wind speed, the chances of foreign object or vegetation contact, and the likelihood of other environmental factors contacting lines.

Wind forecasts are also evaluated along with the FPI rating. If winds are forecasted to exceed the 99th percentile but the FPI rating is Normal, indicating a lower potential for large and damaging fires, PSPS protocols are less likely to be initiated. If the FPI rating indicates that large and damaging wildfires are possible and winds are forecasted to exceed 95th and/or 99th percentile winds, PSPS protocols are more likely to be initiated.

Expected Duration of Conditions: The length of forecasted high-risk conditions, based on meteorological measurements and models, also has a role in the decision to de-energize. If an event is forecasted to be short in duration, there are no active fires, and wind speeds are not grounding CAL FIRE helicopters, a decision may be made to simply continue to monitor. However, if the event is expected to last multiple days and the risk exposure is prolonged, a more conservative PSPS decision that is in alignment with the 99th percentile wind forecast is more likely.

Location of Existing Fires: Locations of existing fires are communicated and tracked through relationships with CAL FIRE and other first responder agencies. Active fires can influence PSPS decisions in multiple ways. For instance, an existing fire may indicate potential resource constraints if additional ignitions occur, causing a more conservative approach to de-energization.

Wildfire Activity Across the State: Wildfire activity across the state is communicated through emergency response partners. Fires in other parts of the state could impact response resources in San Diego if they are being diverted elsewhere. If resources are limited in San Diego due to other response efforts, SDG&E may be more conservative with PSPS decisions.

Information on Temporary Construction: When hardening areas are at the highest risk of wildfire, existing lines are replaced with new construction. This requires temporary configurations to keep customers energized while new lines are built and old lines are removed. Temporary construction can include lines being left in rollers in preparation for pulling new conductor or temporary “shoe flies” that use temporary structures to reroute power around the construction area. These areas of temporary construction are documented and their wind speed thresholds are lowered. Sometimes this de-rated wind speed threshold is higher than the 99th percentile wind. Although this temporary wind speed threshold would not be a deciding factor in where or not to de-energize, when the wind speed threshold drops below the 99th percentile that information is considered.

Other, non-weather-related factors will also be considered. Some pertain to information in the field based on unresolved damage found during inspections, active temporary construction/configuration of the electrical system which may de-rate mechanical ratings, and/or a CRI that seeks to identify locations in the system with a potential of having higher failure rates. In the days leading up to a potential PSPS event, these factors are compiled and populated for each sectionalizing device to assist with developing alert wind speed thresholds and increased awareness of risk levels attributed to assets on the electrical system. Because of these protocols, there is not a standard risk threshold across all devices or risk events. The thresholds are determined prior to a potential PSPS event.

Once PSPS protocols are initiated, granular weather forecasts are developed to identify communities that may experience strong winds. Customers and community partners are then notified of the PSPS potential, and additional inspections of the circuit segments forecasted to be impacted are initiated to assess their condition before the event begins. Once the wind event develops, real-time, 10-minute, and in some cases 30-second weather observations are recorded for the duration. Ultimately, forecasts facilitate preparation for a possible PSPS event, however, decisions to de-energize are based off real time conditions described in this section.

9.2.2 Method that Evaluates Relative Consequences of PSPS and Wildfires

WiNGS-Ops is a real-time risk assessment model built to evaluate and compare Wildfire and PSPS risks at the asset level (pole/span) and the sub-circuit/segment level at hourly intervals. The primary purpose of the model is to help inform decision makers in real-time about the Wildfire and PSPS risks, which will guide risk-based de-energization decisions during risk events. The model outputs used to help guide decision makers are understood to represent a range of potential risk of Wildfire versus PSPS comparisons.

In advance of an approaching Santa Ana Wind event, the WiNGS-Ops model is utilized as an additional data point to determine if there are areas in the service territory where the wildfire risk could outweigh the risk of PSPS.

See Section 6.2.1 Risk and Risk Component Identification for more information on WiNGS-Ops.

9.2.3 Decision-Making Process for Initiating a PSPS

As noted, multiple factors inform the decision to de-energize. These factors are quantified into infrastructure and environmental risk factors. Infrastructure risk includes information in the field based on unresolved damage found during inspections, active temporary construction/configuration of the

electrical system that may cause equipment to have de-rated mechanical strength, and a CRI that identifies locations in the electrical system with a potential of having higher failure rates. Field environment issues may also include real-time observations from QEWs, local fire authority response and fire suppression ability at the time of an event, and wind conditions. These factors are compiled and summarized by circuit section to assist with decisions to de-energize parts of the electrical system (see Figure 9-6).

Figure 9-6: PSPS Decision-Making Framework

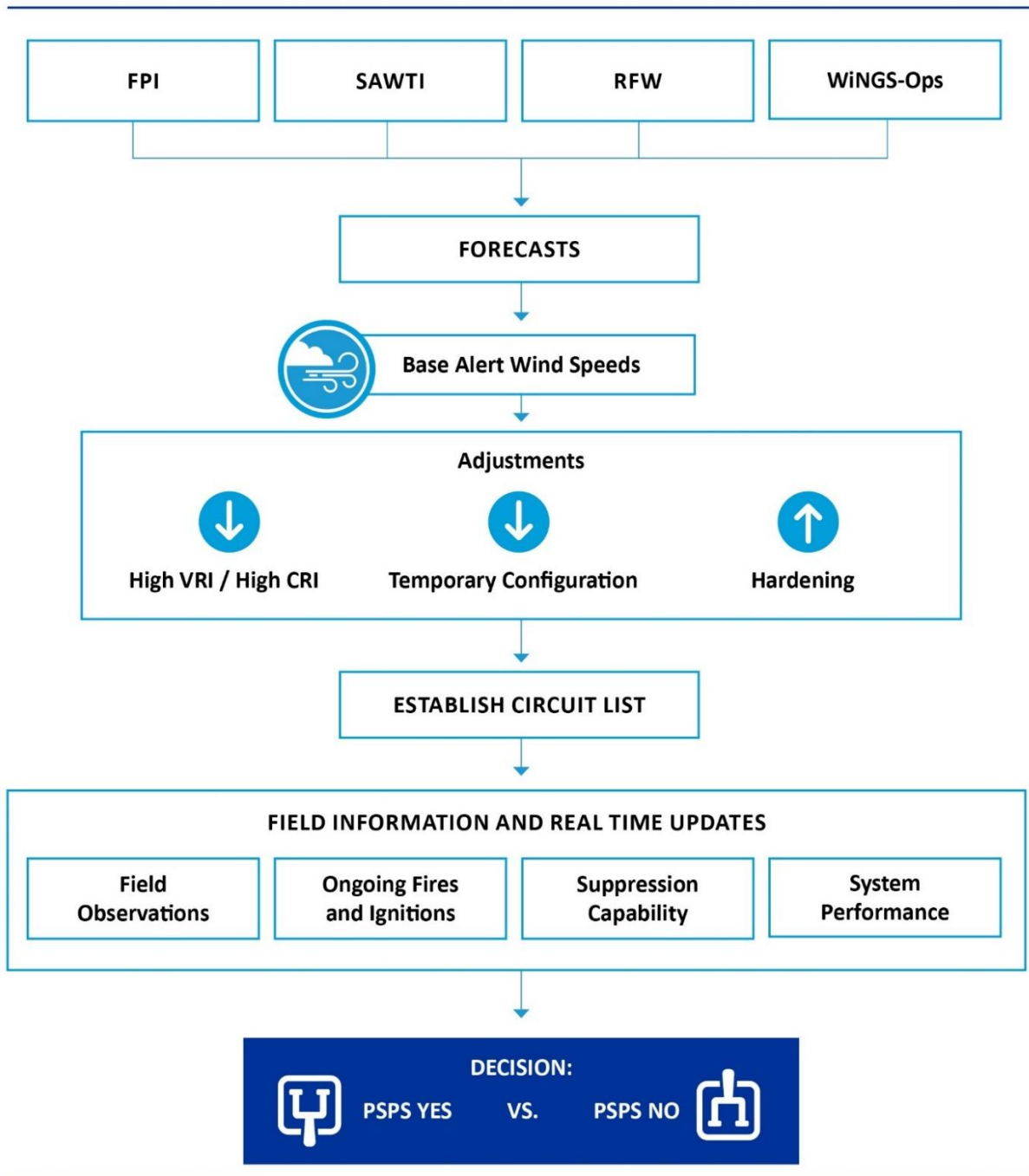

Baseline alert wind speeds are used to quantify infrastructure risk into actionable criteria. They are determined separately for each device tied to a weather station and are based on a variety of factors such as wind speeds, the VRI, and the CRI. Alert wind speed thresholds are lowered if the VRI or the CRI rating is high (see Figure 9-6). Other factors such as maintenance issues, existing construction, other real time observations, ongoing fires and/or ignitions, suppression capabilities, and/or system protection could lower the thresholds for specific events.

9.2.4 Protocols for Mitigating Public Safety Impacts of PSPS

SDG&E has well-established relationships with many of the partners that operate critical facilities such as first responders, health care, operators of telecommunication infrastructure, and water utilities/agencies. Throughout the year, communication is maintained with these critical customers through Wildfire Preparedness meetings, with a focus on continuous improvement and discussion of enhancements. One example of a mitigation targeted to aid critical facilities is the microgrid at the Ramona Air Attack Station and the microgrid at Cameron Corners serving the community of Campo and an AT&T communication hub.

Preplanning and education efforts through webinars, Wildfire Safety Fairs, meetings, EOC tours, and AARs communicate a better understanding of PSPS protocols to communication partners. These meetings also provide an opportunity for our customers and partners to express concerns, which ultimately promote shared understandings.

Outreach to critical facilities is iterative and ongoing. PSPS contact lists are regularly updated to ensure proper notifications for critical facilities and ensure the correct customer locations are flagged. Many critical facilities are assigned customers with a dedicated account executive. Account executives work with assigned critical facility customers to update their contact information for all accounts.

Additionally, account executives survey customers' resiliency efforts. Backup generation is encouraged as a solution to promote continuous power operations during a PSPS event, and tools and information are continually provided to help critical facilities prepare for PSPS events. All unassigned critical facilities are contacted by U.S. mail and email if on file with SDG&E, providing a link³⁶ to update contact information and request information regarding backup power generation.

The Critical Facilities landing page,³⁷ launched in 2021, provides the definition of customers that qualify as a critical facility, a link to request status as a critical facility, a web form where customers can request validation of data that SDG&E has on record for emergency preparedness, and a web form for these customers to request a back-up power assessment. The landing page also has an Emergency Preparedness Checklist, created as a mechanism for customers to self-assess their emergency preparedness, and a Wildfire and PSPS Safety Tips and Recommendations flyer.

There are several mitigations and strategies designed to reduce public safety risk during a PSPS event. The GGP (WMP.466) provides portable renewable generators to MBL customers in the HFTD to ensure access to electricity during a PSPS event. In partnership with Indian Health Councils, generators are also reserved for and distributed to tribal communities. See Section 8.1.2.11.3 Generator Grant Program (WMP.466) for more information. The GAP (WMP.467) offers rebates of up to \$450 to general

³⁶ SDGE, 2022 Critical Facilities Survey, available at <https://www.sdge.com/tellus>.

³⁷ SDGE, Critical Facilities and Infrastructure Customers, available at <https://www.sdge.com/pssp-critical-facilities>.

customers who reside in the HFTD for the purchase of portable generators and power stations. See Section 8.1.2.11.4 Generator Assistance Program (WMP.467) for more information. The Standby Power Program (WMP.468) provides standby generators to residential and commercial customers that do not directly benefit from other grid hardening programs. See Section 8.1.2.11.2 Standby Power Program (Fixed Backup Power: Residential/Commercial) (WMP.468) for more information.

The Emergency Backup Battery Program was also expanded and will be available during all PSPS events. For medically vulnerable customers who have identified needs beyond hotel, transportation, and/or other available no-cost services, a fully charged backup battery can be dispatched within 1 to 4 hours during PSPS events. See Section 8.1.2.11.3 Generator Grant Program (WMP.466) for more information on the Emergency Backup Battery Program.

SDG&E has also established a network of CRCs to help communities in real time during PSPS events. Volunteers are employed to staff the CRCs and provide situational awareness, including updates and real-time information, directly to the impacted community. Each CRC also provides bottled water, light snacks, Wi-Fi access, medical device charging, ice, outage updates, water for animals, portable restrooms, cold weather blankets, and hand warmers. See Section 8.4.6.8 Medical Baseline Support Services for a list of CRCs and locations.

9.3 Communication Strategy for PSPS

See Section 8.4.4 Public Emergency Communication Strategy

9.4 Key Personnel, Qualifications, and Training for PSPS

See Section 8.4.2.2 Key Personnel, Qualifications, and Training

9.5 Planning and Allocation of Resources for Service Restoration due to PSPS

See Section 8.4.5.2 Planning and Allocation of Resources

10 Lessons Learned

10.1 Summary

The last step of the Enterprise Risk Management Framework is Monitoring & Review (see Figure 10-1). This includes tracking risk mitigation implementation and progress (see QDR), the incorporation of lessons learned, corrective actions (see Section 11), and review and correction of any Notifications of Violation and Defect (see Section 12). See Section 4.4 Risk Informed Framework for details on the Enterprise Risk Management Framework.

SDG&E's wildfire mitigation efforts have continued to evolve since the submission of the 2022 WMP Update. Areas of focus include the continuous enhancement of data analytics and modeling capabilities, continued evaluation of technologies and efficacy studies to assess various strategies for mitigating wildfire and PSPS risk, and enhancement of preparedness for PSPS events.

Figure 10-1: Monitoring & Review Step of the Enterprise Risk Management Framework

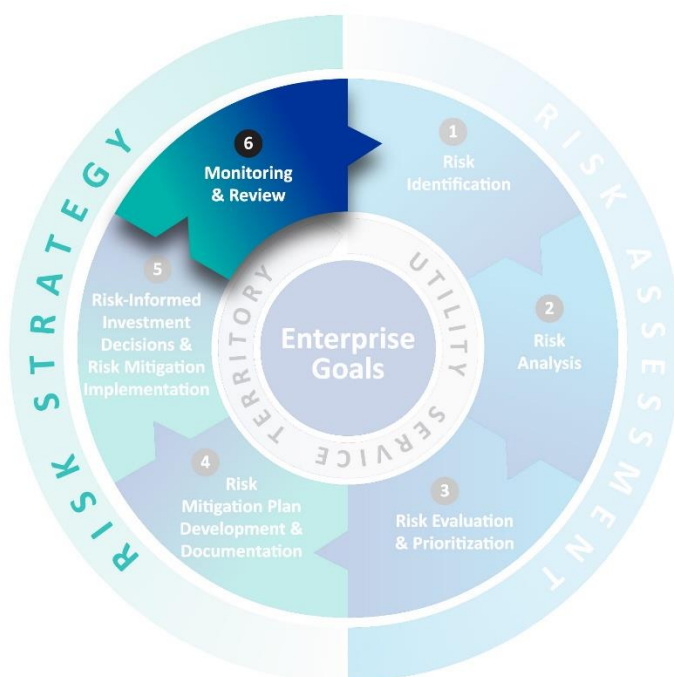

10.2 Identification of Lessons Learned

10.2.1 Internal Monitoring and Evaluation

SDG&E embraces and promotes a culture of continuous safety enhancements and the Company challenges personnel at all levels to contribute ideas for improvements and lessons learned. Building upon the results of SDG&E's 2021 Wildfire Safety Culture assessment, in 2022, SDG&E solicited the input

and feedback of workforce personnel to enhance wildfire safety culture as part of its annual “doubling down” initiative to enhance existing practices and identify new areas for improvement. Frontline employees across transmission and distribution operating units were asked for input on additional ideas to enhance wildfire safety, preparedness for risk and weather events, and general communications related to wildfire mitigation. The feedback resulted in 13 additional wildfire mitigation efforts referred to as “double down” initiatives. SDG&E Table 10-1 describes the purpose and status of the double down initiatives stemming directly from frontline employees.

SDG&E Table 10-1: Double Down Initiatives

Double Down No.	Description	Result	Status
1	Evaluate the removal of grounding banks in the HFTD to reduce wildfire risk	Initial risk analysis on 4 circuits including 11 banks completed. Ongoing project/program evaluation.	Complete
2	Reinforce training to check all phases when CMU/SMU phases are found open.	Included in Electric Distribution Engineering’s October 2022 newsletter.	Complete
3	Ensure material availability for Strategic Undergrounding Program (WMP.473), reducing delays	Working group suggested long-term improvement plans for procurement of long lead time materials. Procurement approach modified to utilize forecasts rather than historical averages.	Complete
4	Identify and maintain access roads required for high PSPS risk circuits.	Distribution access roads have been identified and will be included in road maintenance program.	Complete
5	Perform double inspection of all trees in HFTD by September 1 each year.	Implemented vegetation Off-cycle patrol (WMP.508)	Complete
6	Synch pole brush (WMP.512) locations with actual structure location in systems of record.	Implemented system integration between vegetation management and asset inventory systems.	Complete
7	Evaluate the need to inventory and digitize services in GIS	Scoped project to digitize services in GIS utilizing LiDAR data.	Complete
8	During PSPS events, enable system functionality that prevents operators’ ability to close service restorers and PSPS isolation devices without approval.	System enhancement completed and all operators trained on new functionality.	Complete
9	Prioritize CMP findings on high PSPS risk circuits.	All Tier 3 findings are resolved in required timeframes and accelerated if needed. Corrective work on critical risk circuits is discussed and prioritized weekly	Complete
10	Assess and secure availability of fleet vehicles prior to wildfire and PSPS season.	Patrols teams identified and fleet vehicles are assigned by unit.	Complete
11	Perform drone inspections on 34 coastal canyon circuit segments.	Completed drone inspections on 34 coastal canyon circuit segments.	Complete
12	Investigate use of an additional staging area in DeLuz (Northeast District), including improvements in communications, to utilize during PSPS events.	Staging area in DeLuz has been established and is pending final testing prior to implementation. This site includes a mobile command repeater to enhance mobile communications in the area.	Complete

Double Down No.	Description	Result	Status
13	Continue to resolve customer issues resulting from drone inspections.	Ongoing effort to resolve customer issues in Tier 2 and Tier 3. SDG&E is contracting with third party to assist customers in need.	Ongoing

10.2.2 Feedback from Energy Safety or Other Authoritative Bodies

Energy Safety’s approval of SDG&E’s 2022 WMP Update included 30 areas for continuous improvement. Descriptions of each area is listed in SDG&E Table 10-2 and further discussion is included in Appendix D.

SDG&E Table 10-2: Areas for Continued Improvement

ACI No.	Description
SDGE-22-01	Prioritized List of Wildfire Risks and Drivers
SDGE-22-02	Collaboration and Research in Best Practices in Relation to Climate Change Impacts and Wildfire Risk and Consequence Modeling.
SDGE-22-03	Utility Arborist Training Initiatives
SDGE-22-04	Inclusion of Community Vulnerability in Consequence Modeling.
SDGE-22-05	Fire Suppression Considerations.
SDGE-22-06	Eight-Hour Fire Spread Simulations.
SDGE-22-07	Risk Prioritization for Mitigation Measures.
SDGE-22-08	Evaluation of Wildfire Risk Outside of the HFTD.
SDGE-22-09	Evaluation of Wind Gust Effects on Vegetation-Related Failures.
SDGE-22-10	Wildfire Consequence Modeling Improvements.
SDGE-22-11	Applying Joint Lessons Learned Concerning Covered Conductor (WMP.455)
SDGE-22-12	Covered Conductor Inspection and Maintenance. (WMP.456)
SDGE-22-13	New Technologies Evaluation and Implementation.
SDGE-22-14	Grid Hardening Decision-Making Process Transparency.
SDGE-22-15	Undergrounding Risk-Spend Efficiency Demonstration. (WMP.473)
SDGE-22-16	Enabling Circuits with Advanced Protection. (WMP.463)
SDGE-22-17	Further Development of Integrating Risk-Informed Decision Making for Inspection Scheduling and Planning.
SDGE-22-18	Evaluation and Interpretation of “Other” Equipment Failures.
SDGE-22-19	Plan to Address Missing Asset Data.
SDGE-22-20	Progression of Effectiveness of Enhanced Clearances Joint Study. (WMP.501)
SDGE-22-21	Consideration of Alternatives to Fuels Treatment Activity. (WMP.497)
SDGE-22-22	Participation in Vegetation Management Best Management Practices Scoping Meeting.
SDGE-22-23	PSPS Wind Threshold Change Evaluations.
SDGE-22-24	Replacing Protective Devices for Sensitivity Setting Capabilities.

ACI No.	Description
SDGE-22-25	Validation of Vegetation Risk Index (VRI).
SDGE-22-26	Validation of Wildfire Risk Reduction Model (WRRM).
SDGE-22-27	Improvements to Capital Allocation Methodology.
SDGE-22-28	Improvements to the RSE Verification Process.
SDGE-22-29	Mitigation Plan for Frequently De-Energized Circuits.
SDGE-22-30	Improvements to the WiNGS-Ops and WiNGS-Planning Models.

10.2.3 Collaborations with Other Electrical Corporations

SDG&E collaborates with utilities within California and across the United States to understand best practices for wildfire mitigation and PSPS response. This is accomplished through several working groups and academic partnerships including:

- SDG&E participates in the Energy Safety led risk modeling working group to discuss and review risk modeling topics including how each utility identifies the likelihood of risk events and ignitions, the consequence of a fire (meteorology, environmental, and fuel data), PSPS likelihood and consequence modeling, and utilizing tools such as machine learning to improve weather and fire behavior modeling.
- SDG&E leads the Energy Safety required enhanced vegetation management working group. The joint IOU team has met throughout the year to share data and independent studies that estimate the effectiveness of enhanced clearances on preventing vegetation-related outages. The utilities continue to consider the development and creation of a joint IOU database of vegetation-related risk events and on understanding the role clearances play in reducing these risk events.
- SDG&E participated in the ongoing covered conductor and grid hardening alternatives working groups which have collaborated on the evaluation and testing of covered conductor to better estimate its effectiveness at reducing risk events and ignitions. The IOUs have also collaborated on alternatives and emerging technologies that are employed to understand their applications and how they are deployed across the state.
- SDG&E continues to participate in the CPUC directed joint IOU PSPS Working Group. This working group continues the open collaboration and communication between California’s IOUs to learn and discuss best practices for implementing PSPS and providing necessary information to public safety partners and the general public.

SDG&E utilizes governmental agencies such as Energy Safety’s review of its WMP, Energy Safety’s inspections performed by the Compliance Assurance Division, and audits from the CPUC and other regulators to identify lessons learned, which are then used to improve wildfire mitigation initiatives and the WMP itself.

10.2.4 Lessons Learned from Catastrophic Wildfires

In the service territory, the most significant fire of 2022 was the Border Fire, burning 4,456 acres, impacting distribution and transmission lines, and leading to the destruction of 10 structures. While the

ignition of the Border Fire was not linked to utility equipment, the consequence of any wildfire reinforces the continued importance of increased efforts to mitigate the risk of climate-change-driven catastrophic wildfires in California, including potential utility-caused wildfires.

SDG&E's wildfire mitigation efforts build upon its initial foundation of initiatives developed after the 2007 wildfires—namely, the Witch Creek and Rice fires—and in response to the evolving wildfire risk presented by climate change. In 2009, SDG&E developed a meteorology team to enable the Company to undertake advanced preparations for severe weather events, building the first of its kind network of dense, utility-owned weather stations. This weather station network provides detailed weather data across the service territory, and data is utilized to inform day-to-day operational decisions. In 2018, Meteorology expanded into the FSCA team comprised of meteorologists, fire science experts, fire coordinators, and project management personnel. Additionally—and as a last resort when conditions warrant—SDG&E pioneered the use of de-energization to protect the public from major utility-related wildfires. SDG&E openly shared its experience, lessons learned, and technological advancements in weather and wildfire mitigation with other IOUs, state agencies, and stakeholders in the fire community, with the objective of enhancing wildfire prevention and mitigation across California and the West.

SDG&E further learned that an effective wildfire mitigation program includes a safe and hardened electrical grid that is rigorously inspected and maintained. Informed by meteorological data, SDG&E developed design standards for grid hardening by considering the localized wind conditions. While SDG&E already utilized PLS-CADD tools for its transmission line designs, it began applying this tool to grid hardening work on the distribution system, which improved modeling and designs.

In the years after the catastrophic fires in its service territory, SDG&E also developed the WRRM to enable risk assessment and prioritize its distribution grid hardening strategy. This work was shared with other utilities, leading to a similar statewide approach. The WRRM-Ops tool advanced the use of the WRRM model to understand fire propagation and is used during live fire incidents. And improving upon these tools, SDG&E developed the WiNGS-Planning model to help provide an understanding of the fire risk at a more granular level across the service territory and inform mitigation investments in a targeted grid hardening strategy. In the last 2 years, and to reduce PSPS impacts to SDG&E's customers, grid hardening efforts have incorporated strategic undergrounding of the distribution system in the HFTD and instituted generator programs for some customers experiencing PSPS events.

Wildfire mitigation and fire safety are community endeavors, and SDG&E partners with stakeholders in public safety, academia, and the private sector to collaborate on safety efforts and promote community outreach. SDG&E has continued its culture of engagement with the communities who live in the HFTD through wildfire safety fairs and community meetings. Among the many stakeholder collaboration activities, SDG&E established a Wildfire Safety Community Advisory Council (WSCAC) comprised of leaders from public safety partners, communications and water service providers, local and tribal government officials, business groups and non-profits, AFN and vulnerable communities, and academic organizations. These meetings are held quarterly and are highly regarded as an effective means to discuss wildfire issues and receive input from WSCAC members on relevant emerging community issues on wildfire safety and preparedness.

Wildfire safety is woven into the way SDG&E performs risk assessment, continues to evaluate different methods to improve situational awareness, collaborates with community safety partners, and seeks input from various stakeholders and employees. SDG&E's 2021 Safety Culture Assessment highlighted

this culture as shown by the positive results. SDG&E continues to implement the recommendations of the Safety Culture Assessment. The Company is committed to continuous improvement in wildfire safety culture to better develop methods by which to gather input and implement ideas, especially from employees directly working on wildfire mitigation work.

SDG&E has repeatedly been recognized for its leadership in wildfire mitigation by peer utilities, regulatory agencies, and credit ratings agencies.³⁸ In the CPUC Public Meeting on Utility Safety Practices held On August 25, 2021 (R.18-10-007), Commissioner Shiroma commended the “tremendous efforts” SDG&E has made as well as SDG&E’s “deserved reputation for spearheading many of the safety efforts, particularly with wildfire mitigation, even some years before other utilities.” SDG&E will continue to innovate and improve wildfire mitigation initiatives to promote community safety through situational awareness, prevention, communication, and collaboration.

³⁸ See “Wildfires and Climate Change: California’s Energy Future” Governor Newsom’s Strike Force Report (“Strike Force Report”) (April 12, 2019) at 11 (“SDG&E engaged in a robust fire mitigation and safety program after experiencing devastating fires in its service territory in 2007 and has become a recognized leader in wildfire safety.”) See also “Final Report of the Commission on Catastrophic Wildfire Cost and Recovery” (June 17, 2019) at 7 “[SDG&E] is widely recognized as a global leader on utility wildfire practices.”); S&P Global Ratings, “How are California’s Wildfire Risks Affecting Utilities’ Credit Quality” (Jun. 3, 2021) at 10 (referring to SDG&E as a “global leader” in wildfire mitigation).

10.3 Lessons Learned

OEIS Table 10-1: Lessons Learned

ID#	Year of Lesson Learned ³⁹	Subject	Type or Source of Lesson Learned	Description of Lesson Learned	Proposed WMP Improvement ⁴⁰	Timeline for Implementation	Reference
1	2008-2018	Need for risk framework	Witch Creek Fire Rice Fire	There is a need for enterprise-wide risk identification, analysis, and evaluation.	Development and utilization of Enterprise Risk Management team and the Enterprise Risk Framework	2009 - Ongoing	Section 4
2	2008-2018	Need for dedicated resources to address the risk of utility-caused wildfire	Witch Creek Fire Rice Fire	There is a need for dedicated, internal resources and expertise in meteorology, climate change, and wildfire mitigation.	Development of Wildfire and Climate Science team	Completed 2009 – 2018	Section 5
3	2008-2018	Need for dedicated fire resources	Witch Creek Fire Rice Fire	There is a need for dedicated, internal resources and expertise in fire science and fire response and mitigation.	Development of the Fire Science and Coordination team	Completed 2009 - 2018	Section 8.3
4	2008-2018	Need for fire prevention plan and risk-informed mitigation initiatives	Witch Creek Fire Rice Fire	There is a need to develop and implement risk-informed wildfire mitigation initiatives to reduce the risk of wildfire posed by utility equipment.	Development and implementation of initial grid hardening initiatives targeting high-risk assets	Completed 2010 - 2020	Section 8 Section 9
6	2022	Double Down Initiatives	Internal	Feedback from frontline personnel on wildfire safety is valuable as they possess	Solicit and evaluate ideas from frontline personnel on wildfire safety and PSPS	December 2022	Section 10.2.1

³⁹ Further discussion of SDG&E’s lessons learned prior to the 2022 WMP are included in previous WMP submissions and updates. For more information see [SDG&E 2019 WMP](#); [SDG&E 2020 WMP](#); [SDG&E 2021 WMP Update](#); [SDG&E 2022 WMP Update](#).

⁴⁰ SDG&E is including a discussion of lessons learned in Table 10-1 as directed by the WMP Guidelines. As SDG&E’s wildfire mitigation efforts predate the implementation of the WMP’s and the passage of Senate Bill 901 and Assembly Bill 1054, some of these initiatives do not include a proposed WMP improvement.

ID#	Year of Lesson Learned ³⁹	Subject	Type or Source of Lesson Learned	Description of Lesson Learned	Proposed WMP Improvement ⁴⁰	Timeline for Implementation	Reference
				field expertise in high fire risk areas of the service territory.	procedures. Implement where appropriate.		
7	2022	Risk methodology and assessment	Feedback from OEIS (ACI)	Transitioning models to the cloud and upgrading high-performance computing infrastructure can optimize the running of granular models on an hourly basis. Risk modeling automation is needed to enable more real-time updates and facilitate “what-if” scenario planning.	Planned improvements to risk modeling	2023 - 2025	Section 6.7 ACIs: SDGE-22-01, 02, 04, 05, 06, 08, 09, 18, 19, 25, 26, 28
8	2022	Wildfire mitigation strategy	Feedback from OEIS (ACI)	Ongoing coordination with the Electric System Hardening (ESH) team is needed for the most up-to-date information on costs, feasibility, and other factors to be included for scoping wildfire mitigation initiatives.	Optimize scope for Covered Conductor and Strategic Undergrounding programs (WMP.455 and WMP.473 respectively).	Ongoing	Section 7 ACIs: SDGE-22-07, 10, 14, 15, 27
9	2022	Grid design, operations, and maintenance	Feedback from OEIS (ACI)	Continued to improve processes that streamline the pre-construction process for permitting, design, and material purchasing. Risk based inspection can be leveraged to continue the success of DIAR Program (WMP.552) in identifying additional risks.	Reduce permitting constraints to construction Enhanced risk modeling to inform inspections	2023 - 2025	Section 5.4.5 Section 8.1 SDGE-22-11, 12, 13, 16, 17, 24

ID#	Year of Lesson Learned ³⁹	Subject	Type or Source of Lesson Learned	Description of Lesson Learned	Proposed WMP Improvement ⁴⁰	Timeline for Implementation	Reference
10	2022	Vegetation management and inspections	Feedback from OEIS (ACI)	Continued analysis of SDG&E's enhanced clearance (WMP.501) will inform updated forecasts and program scope.	Refine scope of enhanced clearances	2023 - 2025	Section 8.2 ACIs: SDGE-22-03, 20, 21, 22
11	2022	Situational awareness and forecasting	Internal	<p>The AI infrared camera smoke detection algorithm assists in identifying fires soon after ignition by operationalizing satellite fire detection coupled with mountaintop cameras.</p> <p>The Machine Learning Wind Gust model for all HFTD stations (215 out of 222 weather stations) is vital for situational awareness 72 hours prior to a PSPS or Red Flag Warning (RFW) event.</p> <p>There is a need for a technology strategy to support scalable complex modeling that performs dynamically in supporting operational decisions.</p>	Planned improvements to environmental and grid monitoring systems and weather forecasting	2023 - 2025	Section 8.3
12	2022	Emergency preparedness	Internal Collaboration with other IOUs	<p>Implementation of process flow tools is necessary to improve the efficiency of notifications with public safety and other state partners.</p> <p>Through coordination with other Investor-Owned Utilities (IOUs), preregistering public safety</p>	<p>Continued review and improvement of Company Emergency and Disaster Preparedness Plan (CEADPP)</p> <p>Review Customer/Public Wildfire/PSPS Notifications/Communications and solicit customer feedback</p>	Ongoing	Section 8.4

ID#	Year of Lesson Learned ³⁹	Subject	Type or Source of Lesson Learned	Description of Lesson Learned	Proposed WMP Improvement ⁴⁰	Timeline for Implementation	Reference
				<p>partner information on a secure website is important to improve completeness of data.</p> <p>Safety stand-downs at all operating centers aid in enhancing preparedness.</p>			
13	2022	Community outreach and engagement	Collaboration with other IOUs	<p>Surveying customers, particularly affected customers, to assess campaign effectiveness and communication preferences is key to informing the development of future campaigns.</p> <p>Optimizing partnerships with 40 HFTD-focused Community Based Organizations (CBOs) and enhancing CBO partnerships in key areas (e.g., healthcare) can assist in achieving promotion and amplification of PSPS-related preparedness information to vulnerable populations.</p>	Continue to share best practices and strategize on effective methods to reach customers	Ongoing	Section 8.5
14	2022	PSPS	Feedback from OEIS (ACI)	WiNGS-Ops model enhanced by retraining existing models with new historical observations, incorporating AFN customer impact scaling factors, and improving consequence calculations.	<p>Continue to target and campaign to customers most impacted by PSPS for PSPS resiliency programs.</p> <p>Evaluate PSPS risk reduction impacts on frequently deenergized circuits.</p> <p>Evaluate wind threshold changes on PSPS utilization.</p>	2023 - 2025	Section 8.1 Section 9 ACIs: SDGE-22-23, 29, 30

ID#	Year of Lesson Learned ³⁹	Subject	Type or Source of Lesson Learned	Description of Lesson Learned	Proposed WMP Improvement ⁴⁰	Timeline for Implementation	Reference
				<p>Customer participation in PSPS resiliency programs is largely driven by the occurrence of PSPS events. SDG&E created a dedicated reserve of backup battery units to provide support to those qualified customers who have not yet participated in resiliency programs, as well as prior participants who have received a unit and need additional capacity.</p>			

11 Corrective Action Program

The last step of the Enterprise Risk Management Framework is Monitoring & Review (see Figure 11-1). This includes tracking risk mitigation implementation and progress (see QDRs⁴¹), the incorporation of lessons learned (see Section 10), corrective actions, and review and correction of any Notifications of Violation and Defect (see Section 12). See Section 4.4 Risk Informed Framework for details on the Enterprise Risk Management Framework.

Figure 11-1: Monitoring & Review Step of the Enterprise Risk Management Framework

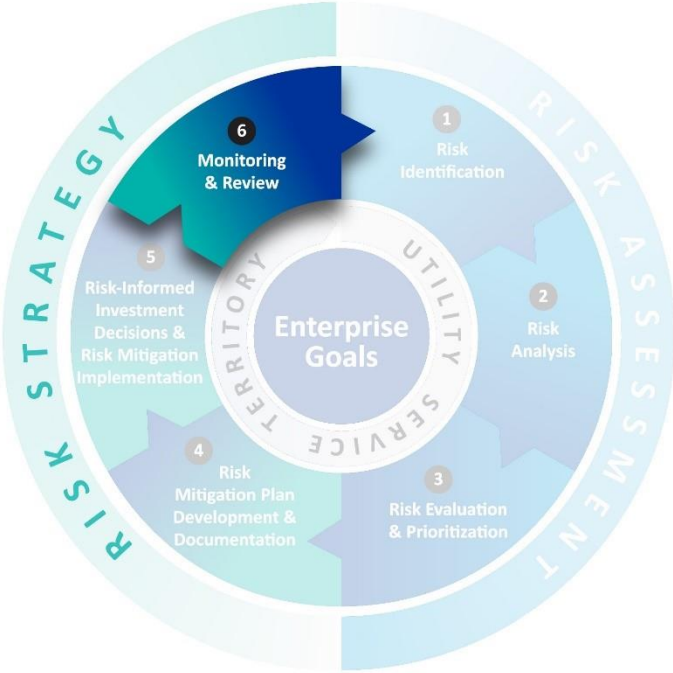

SDG&E has activities designed to prevent the recurrence of risk events, address findings from wildfire investigations, address findings from Energy Safety’s Compliance Assurance Division, and address areas for continued improvement by Energy Safety as part of the WMP evaluation. These activities are described below.

11.1 Prevent Recurrence of Risk Events

SDG&E tracks, reports, and monitors risk events to understand multi-year trends. This data is reported quarterly to Energy Safety and is kept on internal dashboards that are updated weekly. Historical risk events are utilized to inform future mitigations and understand the effectiveness of mitigations. For example, SDG&E’s fuse replacement program in the HFTD was developed to address a specific risk event driver, and its performance is tracked to understand its effectiveness. Other programs, such as the

⁴¹ <https://www.sdge.com/2023-wildfire-mitigation-plan>

Covered Conductor and Strategic Undergrounding Programs (WMP.455 and WMP.473 respectively), address multiple risk event drivers, and their effectiveness continues to be measured over time as more data becomes available. Vegetation management activities reduce the risk events associated with equipment-vegetation contact; these risk events have shown a downward trend as vegetation management has improved through additional inspections and enhanced clearances (WMP.501).

Asset inspection programs for both electric infrastructure and vegetation are designed to prevent the recurrence of risk events by finding and correcting hazardous conditions before failure. These programs are discussed in more detail in Section 8.1.2 Grid Design and System Hardening and Section 8.2 Vegetation Management and Inspection.

The reduction of risk events is directly tied to SDG&E's risk modeling efforts which review historical risk event data and utilize consequence modeling to understand where grid hardening work will provide the most benefit. The models help understand the impact these programs can have on preventing future risk events by implementing initiatives across the service territory. SDG&E's risk modeling and strategy development are discussed in more detail in Section 6 Risk Methodology and Assessment and Section 7 Wildfire Mitigation Strategy Development.

11.2 Address Findings from Internal and External Wildfire Investigations

SDG&E's IMP tracks ignition and near ignition data and performs root cause analysis in an effort to determine the exact cause of the failure as well as detect patterns or correlations. When the cause of ignitions or near ignitions are identified through the IMP process, an Electric Engineering failure analysis team conducts a systematic analysis to determine the exact cause of the failure. When the cause of the failure is determined, it is reported to the appropriate mitigation owner for remedy. Mitigation owners from applicable business will review and propose modifications to existing initiatives or propose new initiatives to reduce future events of a similar nature. SDG&E has improved this program by solidifying a formal process for gathering electric incident information, automating data processing, and integrating data storage through company stakeholders.

When a fire occurs in the service territory, SDG&E responds to support the incident objectives of the first responder agencies. This includes supporting the cause determination, cooperating with investigators, and supplying subject matter expertise when appropriate.

SDG&E meets with Energy Safety's Compliance Assurance Division on a biweekly basis to review the status of field audits and outstanding notices of defect (NOD) and notices of violation (NOV). When a finding is made by Energy Safety and received by SDG&E, that finding is entered into a tracking document and reviewed by members of the Wildfire Mitigation business unit. The appropriate information is entered including the date of receipt, the severity of the defect, the location of the defect, and the required remediation time based on these factors. Based on the location and type of defect found, the appropriate business unit made aware of the defect and required remediation time. SDG&E's internal compliance management department creates a notification for the defect within the compliance management system. From there, the defect will show up in all outstanding work reports for the affected district and will continue to be monitored by Wildfire Mitigation personnel to ensure completion as soon as possible.

SDG&E has corrected all items identified by Energy Safety in 2020 and 2021. SDG&E did not receive any notices of defect or violation in 2022 and as of January 1, 2023 has no open findings from Energy Safety.

11.3 Address Areas for Continued Improvement Identified by Energy Safety as Part of the WMP Evaluation

SDG&E received 30 Areas for Continued Improvement identified by Energy Safety as part of the 2022 WMP evaluation. Each Area for Continued Improvement has been reviewed and an internal subject matter expert has been assigned to lead the initiative and ensure the appropriate progress is made by the required reporting date. These items are then reviewed via working groups, collaboration, or internal meetings throughout the year to ensure progress is being made.

Detailed responses including efforts to address each Area for Continued Improvement can be found in Appendix D.

11.4 Process for Reviewing Improvement Area

SDG&E consistently reviews its WMP and initiatives contained within to promote continual updates of best practices. SDG&E benchmarks with other utilities and participates in various joint utility working groups to ensure the appropriate mitigations are in place to address the risk of wildfire.

11.4.1 Identify Insufficient Occurrence and Response

SDG&E does not consider any specific occurrence, response, or feature insufficient. SDG&E continues to identify corrective actions to reduce the number of risk events and ignitions that occur within the service territory. Risk event data is gathered throughout the year with dashboards that keep updated information on potential areas of concern.

SDG&E reviews all WMP initiatives that are behind schedule or have failed to meet stated targets in a given year. Information on the progress of WMP initiatives is collected weekly, dashboards are updated to highlight off-track targets, and potential remedies are identified. At the end of the reporting period, SDG&E provides additional information regarding off-track initiatives in quarterly reports as well as its Annual Report on Compliance to address any causes for the failure to meet the initially established target or reasons why the target may have been modified.

11.4.2 Identify Actions to Reduce Recurrence

SDG&E continues to review mitigations and assess other areas of improvement to reduce the likelihood of risk events. In response to SDG&E's 2021 Wildfire Safety Culture Assessment, feedback from frontline employees on ideas to enhance wildfire safety was solicited (see Section 10 Lessons Learned for details). Several short-term initiatives were tracked and completed as a result of this effort, including:

1. Drone inspections on high-risk coastal canyon circuit segments – In response to the 2022 Coastal Fire outside of the service territory, additional risk modeling was performed to understand the wildfire risk across non-HFTD coastal canyon areas. After identifying areas of highest risk within these coastal canyon areas, additional drone inspections were performed on over 3,000

distribution structures located in these areas to identify and correct any potential source of ignition outside the HFTD.

2. Study the removal of grounding banks in the HFTD to reduce fire risk – SDG&E performed an initial risk analysis on four circuits that contain 11 grounding banks to evaluate the possibility of removing these devices from service, eliminating the risk of failure and ignition from these devices.
3. Identify and maintain access roads required for high PSPS risk circuit patrols – SDG&E’s wildfire mitigation, electric regional operations, and land management teams coordinated to review and identify access roads that are required to patrol high-PSPS-risk circuits. This effort will continue to identify and prioritize access roads where maintenance is required and develop actions to ensure safety of these roads prior to future PSPS events.

SDG&E continues to review trends in risk events and ignitions and take actions on feedback from outside entities to reduce the likelihood and recurrence of risk events or insufficient response.

11.4.3 Track Implementation

SDG&E tracks the implementation of its improvements and action items in several ways.

Risk events and ignitions are tracked and reported to identify opportunities to reduce the occurrence of these events throughout the year when potential trends are observed. SDG&E’s IMP performs a root cause analysis on all ignitions and works with the appropriate business unit to identify remedies to prevent recurrence of similar events.

NOVs and NODs issued by Energy Safety’s Compliance Assurance Division are reviewed, communicated to the appropriate division for repair, and reviewed in collaboration with Energy Safety through standing biweekly meetings with the Compliance Assurance Division. Using this process, SDG&E has corrected all defects identified by Energy Safety, and has no open NOVs or NODs as of January 1, 2023.

11.4.4 Improve External Communication

SDG&E considers its external agency and stakeholder communication channels to be strong after several years of engagement and feedback. As part of its preparedness efforts, SDG&E engages public safety partners to collaborate and coordinate on emergency management response. To aid the communication of data to external agencies, the PSPP was developed as a focused point to access PSPS-related information and resources. In 2022, a mobile application version was developed to further support timely collaboration and coordination with public safety partners during PSPS events.

SDG&E’s Energy Solutions Partner network, comprised of more than 200 CBOs, is utilized by outreach advisors to promote wildfire preparedness information, PSPS notifications, and available support services during PSPS events. This network is comprised of nearly 200 CBOs who serve a critical role in connecting SDG&E with their constituencies. In addition to strong tribal CBO partnerships, SDG&E has a dedicated Tribal Relations team that has implemented culturally appropriate communications and outreach based on feedback from tribes via listening sessions, online surveys, and focus groups.

SDG&E has several teams dedicated to regularly engaging with local governments at various levels. For example, the Regional Public Affairs team engages senior and elected officials while the Emergency Management team works with first response and other emergency management agencies.

SDG&E's Wildfire Safety/PSPS Community Awareness campaign educates customers and the general public about the risk of wildfires and PSPS events and encourages preparedness measures such as updating profile contact information and signing up for notifications. During PSPS events, notifications, media updates, in-community signage, and situational awareness postings are used across social media and social media kits are shared with community partners to reach a broad audience. Additionally, affected customers and the public are provided with the latest real-time updates and notifications during a PSPS event. Key communications are available in 21 prevalent languages.

11.4.5 Integrate Lessons Learned Across Industry

Section 10 Lessons Learned details lessons learned that SDG&E has implemented or plans to implement to improve the effectiveness of wildfire mitigation initiatives.

Internally, frontline workers were engaged to obtain feedback on areas of wildfire mitigation or PSPS response. This generated 13 new ideas which were reviewed and completed in 2022.

SDG&E also collaborates with utilities throughout California, the United States, and the world to understand best practices for wildfire mitigation and PSPS response. This is accomplished through several working groups including:

- Risk modeling working group has met to discuss and review risk modeling topics including how each utility identifies the likelihood of risk events and ignitions, the consequence of a fire (meteorology, environmental, and fuel data), PSPS likelihood and consequence modeling, and utilizing tools such as machine learning to improve weather and fire behavior modeling.
- Enhanced vegetation management working group has met throughout the year to continue to share data and independent studies that estimate the effectiveness of enhanced clearances on preventing vegetation-related outages. Progress has been made on the creation of a joint IOU database of vegetation-related risk events, and the understanding of the role clearances play in reducing these risk events.
- Covered conductor and grid hardening alternatives working group has collaborated on the evaluation and testing of covered conductor to better estimate its effectiveness at reducing risk events and ignitions. The IOUs have also collaborated on alternatives and emerging technologies that are employed to understand their applications and how they are deployed across the state.

SDG&E utilizes governmental agencies such as Energy Safety's review of its WMP, Energy Safety's inspections performed by the Compliance Assurance Division, and audits from the CPUC and other regulators to identify lessons learned and utilize these in improving wildfire mitigation initiatives and the WMP itself.

11.4.6 Share Lessons Learned with Others

SDG&E utilizes the various working groups discussed in Section 11.4.5 Integrate Lessons Learned Across Industry to not only improve itself through lessons learned, but to share lessons learned with other electrical corporations to improve wildfire safety across the state. SDG&E's lessons learned are also opportunities for other electrical corporations and regulatory authorities to review and utilize the information in achieving their objectives.

12 Notices of Violation and Defect

The last step of the Enterprise Risk Management Framework is Monitoring & Review (see Figure 12-1). This includes tracking risk mitigation implementation and progress (see QDR), the incorporation of lessons learned (see Section 10), corrective actions (see Section 11), and review and correction of any Notifications of Violation and Defect. See Section 4.4 Risk Informed Framework for details on the Enterprise Risk Management Framework.

Figure 12-1: Monitoring & Review Step of the Enterprise Risk Management Framework



As of January 1, 2023 SDG&E has no open Notices of Violation or Defect.

OEIS Table 12-1: List of Open Compliance Violations and Defects

ID	Type	Severity	Date of Notice	Date of Response	Summary Description of Violation/Defect	Estimated Completion Date	Summary Description of Correction
n/a	n/a	n/a	n/a	n/a	n/a	n/a	n/a

Appendix A: Definitions



APPENDIX A: DEFINITIONS

2023-2025 Wildfire Mitigation Plan



Table of Contents

1	APPENDIX A: DEFINITIONS	1
1.1	Terms Defined in Other Codes.....	1
1.2	Terms Not Defined.....	1
1.3	Definition of Terms.....	1
1.4	Definitions of Initiatives by Category.....	13

1 Appendix A: Definitions

Unless otherwise expressly stated, the following words and terms, for the purposes of these Guidelines, have the meanings shown in this chapter.

1.1 Terms Defined in Other Codes

Where terms are not defined in these Guidelines and are defined in the Government Code, Public Utilities Code, or California Public Resources Code, such terms have the meanings ascribed to them in those codes.

1.2 Terms Not Defined

Where terms are not defined through the methods authorized by this section, such terms have ordinarily accepted meanings such as the context implies.

1.3 Definition of Terms

Term	Source	Definition
Access and functional needs population (AFN)	OEIS 2023-2025 WMP Technical Guidelines	Individuals, including, but not limited to, those who have developmental or intellectual disabilities, physical disabilities, chronic conditions, or injuries; who have limited English proficiency or are non-English speaking; who are older adults, children, or people living in institutionalized settings; or who are low income, homeless, or transportation disadvantaged, including, but not limited to, those who are dependent on public transit or are pregnant. (California Government Code 8593.3(f)(1) and
Asset (utility)	OEIS 2023-2025 WMP Technical Guidelines	Electric lines, equipment, or supporting hardware.
At-risk species	OEIS 2023-2025 WMP Technical Guidelines	See “high-risk species.”
Benchmarking	OEIS 2023-2025 WMP Technical Guidelines	A comparison between one electrical corporation’s protocols, technologies used, or mitigations implemented, and other electrical corporations’ similar endeavors.
Calibration	OEIS 2023-2025 WMP Technical Guidelines	Adjustment of a set of code input parameters to maximize the resulting agreement of the code calculations with observations in a specific scenario. ¹
Catastrophic wildfire	OEIS 2023-2025 WMP Technical Guidelines	A fire that caused at least one death, damaged over 500 structures, or burned over 5,000 acres.
Circuit miles	OEIS 2023-2025 WMP Technical Guidelines	The total length in miles of separate transmission and/or distribution circuits, regardless of the number of conductors used per circuit (i.e., different phases).
Consequence	OEIS 2023-2025 WMP Technical Guidelines	The adverse effects from an event, considering the hazard intensity, community exposure, and local vulnerability.

¹ Adapted from T. G. Trucano, L. P. Swiler, T. Igusa, W. L. Oberkampf, and M. Pilch, 2006, “Calibration, validation, and sensitivity analysis: What’s what,” Reliability Engineering and System Safety, vol. 91, no. 10–11, pp. 1331–1357.

Term	Source	Definition
Contact by object ignition likelihood	OEIS 2023-2025 WMP Technical Guidelines	The likelihood that a non-vegetative object (such as a balloon or vehicle) will contact utility-owned equipment and result in an ignition.
Contact by vegetation ignition likelihood	OEIS 2023-2025 WMP Technical Guidelines	The likelihood that vegetation will contact utility-owned equipment and result in an ignition.
Contractor	OEIS 2023-2025 WMP Technical Guidelines	Any individual in the temporary and/or indirect employ of the electrical corporation whose limited hours and/or time-bound term of employment are not considered “full-time” for tax and/or any other purposes.
Critical facilities and infrastructure	OEIS 2023-2025 WMP Technical Guidelines	<p>Facilities and infrastructure that are essential to public safety and that require additional assistance and advance planning to ensure resiliency during PSPS events. These include the following:</p> <p>Emergency services sector:</p> <ul style="list-style-type: none"> • Police stations • Fire stations • Emergency operations centers • Public safety answering points (e.g., 9-1-1 emergency services) <p>Government facilities sector:</p> <ul style="list-style-type: none"> • Schools • Jails and prisons <p>Health care and public health sector:</p> <ul style="list-style-type: none"> • Public health departments • Medical facilities, including hospitals, skilled nursing facilities, nursing homes, blood banks, health care facilities, dialysis centers, and hospice facilities (excluding doctors' offices and other non-essential medical facilities) <p>Energy sector:</p> <ul style="list-style-type: none"> • Public and private utility facilities vital to maintaining or restoring normal service, including, but not limited to, interconnected publicly owned electrical corporations and electric cooperatives <p>Water and wastewater systems sector:</p> <ul style="list-style-type: none"> • Facilities associated with provision of drinking water or processing of wastewater, including facilities that pump, divert, transport, store, treat, and deliver water or wastewater <p>Communications sector:</p> <ul style="list-style-type: none"> • Communication carrier infrastructure, including selective routers, central offices, head ends, cellular switches, remote terminals, and cellular sites <p>Chemical sector:</p> <ul style="list-style-type: none"> • Facilities associated with manufacturing, maintaining, or distributing hazardous materials and chemicals (including Category N-Customers as defined in D.01-06-085) <p>Transportation sector:</p> <ul style="list-style-type: none"> • Facilities associated with transportation for civilian and military purposes: automotive, rail, aviation, maritime, or major public transportation <p>(D.19-05-042 and D.20-05-051)</p>

Term	Source	Definition
Customer hours	OEIS 2023-2025 WMP Technical Guidelines	Total number of customers, multiplied by average number of hours (e.g., of power outage).
Danger tree	OEIS 2023-2025 WMP Technical Guidelines	Any tree located on or adjacent to a utility right-of-way or facility that could damage utility facilities should it fall where (1) the tree leans toward the right-of-way, or (2) the tree is defective because of any cause, such as: heart or root rot, shallow roots, excavation, bad crotch, dead or with dead top, deformity, cracks or splits, or any other reason that could result in the tree or main lateral of the tree falling. (California Code of Regulation Title 14 § 895.1)
Data cleaning	OEIS 2023-2025 WMP Technical Guidelines	Calibration of raw data to remove errors (including typographical and numerical mistakes).
Dead fuel moisture content	OEIS 2023-2025 WMP Technical Guidelines	Moisture content of dead vegetation, which responds solely to current environmental conditions and is critical in determining fire potential.
Detailed inspection	OEIS 2023-2025 WMP Technical Guidelines	In accordance with General Order (GO) 165, an inspection where individual pieces of equipment and structures are carefully examined, visually and through routine diagnostic testing, as appropriate, and (if practical and if useful information can be so gathered) opened, and the condition of each is rated and recorded.
Disaster	OEIS 2023-2025 WMP Technical Guidelines	A serious disruption of the functioning of a community or a society at any scale due to hazardous events interacting with conditions of exposure, vulnerability, and capacity, leading to one or more of the following: human, material, economic, and environmental losses and impacts. The effect of the disaster can be immediate and localized but is often widespread and could last a long time. The effect may test or exceed the capacity of a community or society to cope using its own resources. Therefore, it may require assistance from external sources, which could include neighboring jurisdictions or those at the national or international levels. (United Nations Office for Disaster Risk Reduction [UNDRR].)
Discussion-based exercise	OEIS 2023-2025 WMP Technical Guidelines	Exercise used to familiarize participants with current plans, policies, agreements, and procedures or to develop new plans, policies, agreements, and procedures. Often includes seminars, workshops, tabletop exercises, and games
Electrical corporation	OEIS 2023-2025 WMP Technical Guidelines	Every corporation or person owning, controlling, operating, or managing any electric plant for compensation within California, except where the producer generates electricity on or distributes it through private property solely for its own use or the use of its tenants and not for sale or transmission to others.
Emergency	OEIS 2023-2025 WMP Technical Guidelines	Any incident, whether natural, technological, or human caused, that requires responsive action to protect life or property but does not result in serious disruption of the functioning of a community or society. (FEMA/UNDRR.)
Enhanced inspection	OEIS 2023-2025 WMP Technical Guidelines	Inspection whose frequency and thoroughness exceed the requirements of a detailed inspection, particularly if driven by risk calculations.
Enterprise Risk Registry (ERR)	CPUC	[a]n inventory of enterprise risks at a snapshot in time that summarizes (for a utility's management and/or stakeholders such as the CPUC) risks that a utility may face. The ERR must be refreshed on a regular basis and can reflect the changing nature of a risk; for example, risks that were consolidated together may be separated, new risks may be added, and the level of risks may change over time

Term	Source	Definition
Equipment ignition likelihood	OEIS 2023-2025 WMP Technical Guidelines	The likelihood that utility-owned equipment will cause an ignition through either normal operation (such as arcing) or failure.
Exercise	OEIS 2023-2025 WMP Technical Guidelines	An instrument to train for, assess, practice, and improve performance in prevention, protection, response, and recovery capabilities in a risk-free environment. (FEMA.)
Exposure	OEIS 2023-2025 WMP Technical Guidelines	The presence of people, infrastructure, livelihoods, environmental services and resources, and other high-value assets in places that could be adversely affected by a hazard.
Fire ecology	OEIS 2023-2025 WMP Technical Guidelines	A scientific discipline concerned with natural processes involving <u>fire</u> in an <u>ecosystem</u> and its <u>ecological</u> effects, the interactions between fire and the abiotic and biotic components of an ecosystem, and the role of fire as an ecosystem process.
Fire Potential Index (FPI)	OEIS 2023-2025 WMP Technical Guidelines	Landscape scale index used as a proxy for assessing real-time risk of a wildfire under current and forecasted weather conditions.
FPI – Normal	SDG&E	An FPI value of 11 or less represents a normal fire potential based upon combined green-up, fuels, and weather measurements.
FPI – Elevated	SDG&E	An FPI value of 12 to 14 represents an elevated risk of fire potential based upon combined green-up, fuels, and weather measurements.
FPI – Extreme	SGG&E	An FPI value of 15 or greater represents an extreme risk of fire potential based upon combined green-up, fuels, and weather measurements.
Fire season	OEIS 2023-2025 WMP Technical Guidelines	The time of year when wildfires are most likely for a given geographic region due to historical weather conditions, vegetative characteristics, and impacts of climate change. Each electrical corporation defines the fire season(s) across its service territory based on a recognized fire agency definition for the specific region(s) in California.
Frequency	OEIS 2023-2025 WMP Technical Guidelines	The anticipated number of occurrences of an event or hazard over time.
Frequent PSPS events	OEIS 2023-2025 WMP Technical Guidelines	Three or more PSPS events per calendar year per line circuit.
Fuel density	OEIS 2023-2025 WMP Technical Guidelines	Mass of fuel (vegetation) per area that could combust in a wildfire.
Fuel management	OEIS 2023-2025 WMP Technical Guidelines	Removal or thinning of vegetation to reduce the potential rate of propagation or intensity of wildfires.
Fuel moisture content	OEIS 2023-2025 WMP Technical Guidelines	Amount of moisture in a given mass of fuel (vegetation), measured as a percentage of its dry weight.
Full-time employee (FTE)	OEIS 2023-2025 WMP Technical Guidelines	Any individual in the ongoing and/or direct employ of the electrical corporation whose hours and/or term of employment are considered “full-time” for tax and/or any other purposes.
Game	OEIS 2023-2025 WMP Technical Guidelines	A simulation of operations that often involves two or more teams, usually in a competitive environment, using rules, data, and procedures designed to depict an actual or assumed real life situation.
Goals	OEIS 2023-2025 WMP Technical Guidelines	The electrical corporation’s general intentions and ambitions.
GO 95 nonconformance	OEIS 2023-2025 WMP Technical Guidelines	Condition of a utility asset that does not meet standards established by GO 95.

Term	Source	Definition
GO 95 Priority Level 1	CPUC	Immediate safety and/or reliability risk with high probability for significant impact.
GO 95 Priority Level 2	CPUC	Variable (non-immediate high to low) safety and/or reliability risk.
GO 95 Priority Level 3	CPUC	Acceptable safety and/or reliability risk.
Grid hardening	OEIS 2023-2025 WMP Technical Guidelines	Actions (such as equipment upgrades, maintenance, and planning for more resilient infrastructure) taken in response to the risk of undesirable events (such as outages) or undesirable conditions of the electrical system to reduce or mitigate those events and conditions, informed by an assessment of the relevant risk drivers or factors.
Grid topology	OEIS 2023-2025 WMP Technical Guidelines	General design of an electric grid, whether looped or radial, with consequences for reliability and ability to support PSPS (e.g., ability to deliver electricity from an additional source).
Ground Inspection	SDG&E	Foot patrol assessment of all trees adjacent to overhead electrical facilities
Hazard	OEIS 2023-2025 WMP Technical Guidelines	A condition, situation, or behavior that presents the potential for harm or damage to people, property, the environment, or other valued resources.
Hazard tree	OEIS 2023-2025 WMP Technical Guidelines	See danger tree.
Helicopter Inspection	SDG&E	Aerial inspection of vegetation adjacent to overhead electrical facilities.
High Fire Threat District (HFTD)	OEIS 2023-2025 WMP Technical Guidelines	Areas of the state designated by the CPUC as having elevated wildfire risk, where each utility must take additional action (per GO 95, GO 165, and GO 166) to mitigate wildfire risk. (D.17-01-009.)
HFTD Tier 2	CPUC	Tier 2 fire-threat areas depict areas where there is an elevated risk (including likelihood and potential impacts on people and property) from utility associated wildfires.
HFTD Tier 3	CPUC	Tier 3 fire-threat areas depict areas where there is an extreme risk (including likelihood and potential impacts on people and property) from utility associated wildfires.
High Fire Risk Area (HFRA)	OEIS 2023-2025 WMP Technical Guidelines	Areas that the electrical corporation has deemed at high risk from wildfire, independent of HFTD designation.
High FPI day	SDG&E	Days with an FPI rating of elevated or extreme
Highly rural region	OEIS 2023-2025 WMP Technical Guidelines	In accordance with 38 CFR 17.701, area with a population of less than seven persons per square mile, as determined by the United States Bureau of the Census. For purposes of the WMP, “area” must be defined as a census tract.
High-risk species	OEIS 2023-2025 WMP Technical Guidelines	Species of vegetation that (1) have a higher risk of either coming into contact with powerlines or causing an outage or ignition, or (2) are easily ignitable and within close proximity to potential arcing, sparks, and/or other utility equipment thermal failures. The status of species as “high-risk” must be a function of species-specific characteristics, including growth rate; failure rates of limbs, trunk, and/or roots (as compared to other species); height at maturity; flammability; and vulnerability to disease or insects.

Term	Source	Definition
High Wind Warning (HWW)	OEIS 2023-2025 WMP Technical Guidelines	Level of wind risk from weather conditions, as declared by the National Weather Service (NWS). For historical NWS data, refer to the Iowa State University archive of NWS watches/warnings. ²
HWW overhead (OH) circuit mile day	OEIS 2023-2025 WMP Technical Guidelines	Sum of OH circuit miles of utility grid subject to a HWW each day within a given time period, calculated as the number of OH circuit miles under a HWW multiplied by the number of days those miles are under said HWW. For example, if 100 OH circuit miles are under a HWW for one day, and 10 of those miles are under the HWW for an additional day, then the total HWW OH circuit mile days would be 110
Ignition	CPUC	CPUC reportable ignitions (as defined by D.14-02-015)
Ignition consequence	OEIS 2023-2025 WMP Technical Guidelines	The total anticipated adverse effects from an ignition at each location in the electrical corporation service territory. This considers the likelihood that an ignition will transition into a wildfire (wildfire spread likelihood) and the consequences that the wildfire will have on each community it reaches (wildfire consequence).
Ignition likelihood	OEIS 2023-2025 WMP Technical Guidelines	The total anticipated annualized number of ignitions resulting from utility-owned assets at each location in the electrical corporation service territory. This considers probabilistic weather conditions, type and age of equipment, and potential contact of vegetation and other objects with utility assets.
Ignition probability	OEIS 2023-2025 WMP Technical Guidelines	The relative possibility that an ignition will occur, quantified as a number between 0 percent (impossibility) and 100 percent (certainty). The higher the probability of an event, the more certainty there is that the event will occur. (Often informally referred to as likelihood or chance.)
Ignition risk	OEIS 2023-2025 WMP Technical Guidelines	The total anticipated annualized impacts from ignitions at a specific location. This considers the likelihood that an ignition will occur, the likelihood the ignition will transition into a wildfire, and the potential consequences – considering hazard intensity, exposure potential, and vulnerability – the wildfire will have on each community it reaches
Impact/consequence of ignition	OEIS 2023-2025 WMP Technical Guidelines	The effect or outcome of a wildfire ignition upon objectives that may be expressed by terms including, although not limited to, maintaining health and safety, ensuring reliability, and minimizing economic and/or environmental damage
Incident command system (ICS)	OEIS 2023-2025 WMP Technical Guidelines	A standardized on-scene emergency management construct. It is specifically designed to provide an integrated organizational structure that reflects the complexity and demands of single or multiple incidents, without being hindered by jurisdictional boundaries. The ICS is the combination of facilities, equipment, personnel, procedures, and communications operating within a common organizational structure, designed to aid in the management of resources during incidents
Initiative	OEIS 2023-2025 WMP Technical Guidelines	Measure or activity, either proposed or in process, designed to reduce the consequences and/or probability of wildfire or PSPS.
Integrated public alert warning system (IPAWS)	OEIS 2023-2025 WMP Technical Guidelines	System allowing the President to send a message to the American people quickly and simultaneously through multiple communications pathways in a national emergency. IPAWS also is available to United States federal, state, local, territorial, and tribal government officials to alert the public via the Emergency Alert System (EAS), Wireless Emergency Alerts (WEA), National Oceanic and Atmospheric Administration (NOAA) Weather

² <https://mesonet.agron.iastate.edu/request/gis/watchwarn.phtml>

Term	Source	Definition
		Radio, and other NWS dissemination channels; the internet; existing unique warning systems; and emerging distribution technologies.
Invasive species	OEIS 2023-2025 WMP Technical Guidelines	A species (1) that is non-native (or alien) to the ecosystem under consideration and (2) whose introduction causes or is likely to cause economic or environmental harm or harm to human health.
Inventory Tree	SDG&E	Any tree identified as having the potential to impact the lines from encroachment by growth or branch or trunk failure within three (3) years of inspection
Level 1 finding	OEIS 2023-2025 WMP Technical Guidelines	In accordance with GO 95, an immediate safety and/or reliability risk with high probability for significant impact.
Level 1 Inspection	SDG&E	A cursory assessment of trees within the right-of-way to determine which require pruning for the annual cycle based on tree growth and/or to abate a hazardous condition.
Level 2 finding	OEIS 2023-2025 WMP Technical Guidelines	In accordance with GO 95, a variable safety and/or reliability risk (non-immediate and with high to low probability for significant impact).
Level 2 Inspection	SDG&E	A 360-degree visual assessment of a tree where the crown, trunk, canopy, and above-ground roots are evaluated for specific hazards to the electric infrastructure. This may also involve simple tools such as a mallet to sound the tree trunk
Level 3 finding	OEIS 2023-2025 WMP Technical Guidelines	In accordance with GO 95, an acceptable safety and/or reliability risk.
Limited English proficiency (LEP) population	OEIS 2023-2025 WMP Technical Guidelines	Limited English proficiency (LEP) population
Line miles	OEIS 2023-2025 WMP Technical Guidelines	The number of miles of transmission and/or distribution conductors, including the length of each phase and parallel conductor segment.
Live fuel moisture content	OEIS 2023-2025 WMP Technical Guidelines	Moisture content within living vegetation, which can retain water longer than dead fuel.
Locally relevant	OEIS 2023-2025 WMP Technical Guidelines	In disaster risk management, generally understood as the scale at which disaster risk strategies and initiatives are considered the most effective at achieving desired outcomes. This tends to be the level closest to impacting residents and communities, reducing existing risks, and building capacity, knowledge, and normative support. Locally relevant scales, conditions, and perspectives depend on the context of application.
Match-drop simulation	OEIS 2023-2025 WMP Technical Guidelines	Wildfire simulation method forecasting propagation and consequence/impact based on an arbitrary ignition.
Memo Tree	SDG&E	A tree identified to be pruned on a priority basis based on its proximity to the power lines and/or if the tree exhibits a hazardous condition that requires a priority response
Memorandum of Agreement (MOA)	OEIS 2023-2025 WMP Technical Guidelines	A document of agreement between two or more agencies establishing reciprocal assistance to be provided upon request (and if available from the supplying agency) and laying out the guidelines under which this assistance will operate. It can also be a cooperative document in which parties agree to work together on an agreed-upon project or meet an agreed objective.

Term	Source	Definition
Mitigation	OEIS 2023-2025 WMP Technical Guidelines	Activities to reduce the loss of life and property from natural and/or human-caused disasters by avoiding or lessening the impact of a disaster and providing value to the public by creating safer communities.
Model uncertainty	OEIS 2023-2025 WMP Technical Guidelines	The amount by which a calculated value might differ from the true value when the input parameters are known (i.e., limitation of the model itself based on assumptions). ³
Multi-attribute value function (MAVF)	OEIS 2023-2025 WMP Technical Guidelines	Risk calculation methodology introduced during CPUC's Safety Model Assessment Proceedings (S-MAP) and Risk Assessment and Mitigation Phase (RAMP) proceedings. This methodology is established in D.18-12-014 but may be subject to change pursuant to R.20-07-013.
Mutual aid	OEIS 2023-2025 WMP Technical Guidelines	Voluntary aid and assistance by the provision of services and facilities, including but not limited to electrical corporations, communication, and transportation. Mutual aid is intended to provide adequate resources, facilities, and other support to electrical corporations whenever their own resources prove inadequate to cope with a given situation.
National Incident Management System (NIMS)	OEIS 2023-2025 WMP Technical Guidelines	A systematic, proactive approach to guide all levels of government, nongovernment organizations, and the private sector to work together to prevent, protect against, mitigate, respond to, and recover from the effects of incidents. NIMS provides stakeholders across the whole community with the shared vocabulary, systems, and processes to successfully deliver the capabilities described in the National Preparedness System. NIMS provides a consistent foundation for dealing with all incidents, ranging from daily occurrences to incidents requiring a coordinated federal response.
Near miss	OEIS 2023-2025 WMP Technical Guidelines	Term previously used for an event with probability of ignition (now "Risk event").
Objectives	OEIS 2023-2025 WMP Technical Guidelines	Specific, measurable, achievable, realistic, and timely outcomes for the overall WMP strategy, or mitigation initiatives and activities that a utility can implement to satisfy the primary goals and subgoals of the WMP program.
Operations-based exercise	OEIS 2023-2025 WMP Technical Guidelines	Type of exercise that validates plans, policies, agreements, and procedures; clarifies roles and responsibilities; and identifies resource gaps in an operational environment. Often includes drills, functional exercises (FEs), and full-scale exercises (FSEs).
Overall utility risk	OEIS 2023-2025 WMP Technical Guidelines	The comprehensive risk due to both wildfire and PSPS incidents across a utility's territory; the aggregate potential of adverse impacts to people, property, critical infrastructure, or other valued assets in society.
Overall utility risk, ignition risk	OEIS 2023-2025 WMP Technical Guidelines	See Ignition risk.
Overall utility risk, PSPS risk	OEIS 2023-2025 WMP Technical Guidelines	See PSPS risk.
Parameter uncertainty	OEIS 2023-2025 WMP Technical Guidelines	The amount by which a calculated value might differ from the true value based on unknown input parameters. (Adapted from Society of Fire Protection Engineers [SFPE] guidance.)
Patrol inspection	OEIS 2023-2025 WMP Technical Guidelines	In accordance with GO 165, a simple visual inspection of applicable utility equipment and structures designed to identify obvious structural

³ Adapted from SFPE, 2010, "Substantiating a Fire Model for a Given Application," Society of Fire Protection Engineers Engineering Guides.

Term	Source	Definition
		problems and hazards. Patrol inspections may be carried out in the course of other company business.
Peak Wildfire Season	SDG&E	
Performance metric	OEIS 2023-2025 WMP Technical Guidelines	A quantifiable measurement that is used by an electrical corporation to indicate the extent to which its WMP is driving performance outcomes.
Population density	OEIS 2023-2025 WMP Technical Guidelines	Population density is calculated using the American Community Survey (ACS) one-year estimate for the corresponding year or, for years with no such ACS estimate available, the estimate for the immediately preceding year.
Preparedness	OEIS 2023-2025 WMP Technical Guidelines	A continuous cycle of planning, organizing, training, equipping, exercising, evaluating, and taking corrective action in an effort to ensure effective coordination during incident response. Within the NIMS, preparedness focuses on planning, procedures and protocols, training and exercises, personnel qualification and certification, and equipment certification.
Priority essential services	OEIS 2023-2025 WMP Technical Guidelines	Critical first responders, public safety partners, critical facilities and infrastructure, operators of telecommunications infrastructure, and water electrical corporations/agencies.
Property	OEIS 2023-2025 WMP Technical Guidelines	Private and public property, buildings and structures, infrastructure, and other items of value that may be destroyed by wildfire, including both third-party property and utility assets.
Protective equipment and device settings	OEIS 2023-2025 WMP Technical Guidelines	The electrical corporation’s procedures for adjusting the sensitivity of grid elements to reduce wildfire risk, other than automatic reclosers (such as circuit breakers, switches, etc.). For example, PG&E’s “Enhanced Powerline Safety Settings” (EPSS).
PSPS consequence	OEIS 2023-2025 WMP Technical Guidelines	The total anticipated adverse effects of a PSPS for a community. This considers the PSPS exposure potential and inherent PSPS vulnerabilities of communities at risk.
PSPS event	OEIS 2023-2025 WMP Technical Guidelines	The period from notification of the first public safety partner of a planned public safety PSPS to re-energization of the final customer.
PSPS exposure potential	OEIS 2023-2025 WMP Technical Guidelines	The potential physical, social, or economic impact of a PSPS event on people, property, critical infrastructure, livelihoods, health, local economies, and other high-value assets.
PSPS likelihood	OEIS 2023-2025 WMP Technical Guidelines	The likelihood of a PSPS being required by a utility given a probabilistic set of environmental conditions.
PSPS risk	OEIS 2023-2025 WMP Technical Guidelines	The total anticipated annualized impacts from a PSPS event at a specific location. This considers the likelihood a PSPS event will be required due to environmental conditions exceeding design conditions and the potential consequences – considering exposure potential and vulnerability – of the PSPS event for each affected community.
Public safety partners	OEIS 2023-2025 WMP Technical Guidelines	First/emergency responders at the local, state, and federal levels; water, wastewater, and communication service providers; community choice aggregators (CCAs); affected publicly owned electrical corporations/electrical cooperatives; tribal governments; Energy Safety; the Commission; the California Office of Emergency Services; and CAL FIRE.

Term	Source	Definition
Red Flag Warning (RFW)	OEIS 2023-2025 WMP Technical Guidelines	Level of wildfire risk from weather conditions, as declared by the NWS. For historical NWS data, refer to the Iowa State University archive of NWS watches/warnings. ⁴
RFW OH circuit mile day	OEIS 2023-2025 WMP Technical Guidelines	Sum of OH circuit miles of utility grid subject to RFW each day within a given time period, calculated as the number of OH circuit miles under RFW multiplied by the number of days those miles are under said RFW. For example, if 100 OH circuit miles are under RFW for one day, and 10 of those miles are under RFW for an additional day, then the total RFW OH circuit mile days would be 110.
Risk	OEIS 2023-2025 WMP Technical Guidelines	A measure of the anticipated adverse effects from a hazard considering the consequences and frequency of the hazard occurring. ⁵
Risk Bow Tie	CPUC	[a] tool that consists of a Risk Event in the center, a listing of drivers on the left side that potentially lead to the Risk Event occurring, and a listing of Consequences on the right side that show the potential outcomes if the Risk Event occurs.” ⁶
Risk component	OEIS 2023-2025 WMP Technical Guidelines	A part of an electric corporation’s risk analysis framework used to determine overall utility risk.
Risk evaluation	OEIS 2023-2025 WMP Technical Guidelines	The process of comparing the results of a risk analysis with risk criteria to determine whether the risk and/or its magnitude is acceptable or tolerable. (ISO 31000:2009.)
Risk event	OEIS 2023-2025 WMP Technical Guidelines	All overhead system faults, meaning any overhead electrical fault caused by foreign object in line, equipment failure, other or of undetermined cause that impacts the primary electric distribution system (12kV and 4kV systems). An electrical fault includes an electrical system short that results in energy created in the form of heat. The following all qualify as risk events: <ul style="list-style-type: none"> • Ignitions • Outages not caused by vegetation • Outages caused by vegetation • Wire-down events • Faults • Other events with potential to cause ignition
Risk management	OEIS 2023-2025 WMP Technical Guidelines	Systematic application of management policies, procedures, and practices to the tasks of communication, consultation, establishment of context, and identification, analysis, evaluation, treatment, monitoring, and review of risk. (ISO 31000.)
Rule	OEIS 2023-2025 WMP Technical Guidelines	Section of Public Utilities Code requiring a particular activity or establishing a particular threshold.
Rural region	OEIS 2023-2025 WMP Technical Guidelines	In accordance with GO 165, area with a population of less than 1,000 persons per square mile, as determined by the U.S. Bureau of the

⁴ <https://mesonet.agron.iastate.edu/request/gis/watchwarn.phtml>

⁵ Adapted from D. Coppola, 2020, “Risk and Vulnerability,” Introduction to International Disaster Management, 4th ed.

⁶ D.18-12-014 at 16.

Term	Source	Definition
Vegetation management (VM)	OEIS 2023-2025 WMP Technical Guidelines	Trimming and removal of trees and other vegetation at risk of contact with electric equipment.
Verification	OEIS 2023-2025 WMP Technical Guidelines	Process to ensure that a model is working as designed, that is, that the equations are being properly solved. Verification is essentially a check of the mathematics. (SFPE guidance.)
Vulnerability	OEIS 2023-2025 WMP Technical Guidelines	The propensity or predisposition of a community to be adversely affected by a hazard, including the characteristics of a person, group, or service and their situation that influences their capacity to anticipate, cope with, resist, and recover from the adverse effects of a hazard.
Wildfire consequence	OEIS 2023-2025 WMP Technical Guidelines	The total anticipated adverse effects from a wildfire on a community that is reached. This considers the wildfire hazard intensity, the wildfire exposure potential, and the inherent wildfire vulnerabilities of communities at risk.
Wildfire exposure potential	OEIS 2023-2025 WMP Technical Guidelines	The potential physical, social, or economic impact of wildfire on people, property, critical infrastructure, livelihoods, health, environmental services, local economies, cultural/historical resources, and other high-value assets. This may include direct or indirect impacts, as well as short- and long-term impacts.
Wildfire intensity	OEIS 2023-2025 WMP Technical Guidelines	The potential intensity of a wildfire at a specific location within the service territory given a probabilistic set of weather profiles, vegetation, and topography.
Wildfire mitigation strategy	OEIS 2023-2025 WMP Technical Guidelines	Overview of the key mitigation initiatives at enterprise level and component level across the electrical corporation’s service territory, including interim strategies where long-term mitigation initiatives have long implementation timelines. This includes a description of the enterprise-level monitoring and evaluation strategy for assessing overall effectiveness of the WMP.
Wildfire risk	OEIS 2023-2025 WMP Technical Guidelines	See Ignition risk.
Wildfire spread likelihood	OEIS 2023-2025 WMP Technical Guidelines	The likelihood that a fire with a nearby but unknown ignition point will transition into a wildfire and will spread to a location in the service territory based on a probabilistic set of weather profiles, vegetation, and topography.
Wildland-urban interface (WUI)	OEIS 2023-2025 WMP Technical Guidelines	The line, area, or zone where structures and other human development meet or intermingle with undeveloped wildland or vegetation fuels (National Wildfire Coordinating Group). Enforcement agencies also designate the WUI as the area at significant risk from wildfires, established pursuant to Title 24, Part 2, Chapter 7A.
Wind Load Condition 3 – Extreme	SDG&E	Historical max wind gusts at each weather station during Santa Ana Conditions
Wire down	OEIS 2023-2025 WMP Technical Guidelines	Instance where an electric transmission or distribution conductor is broken and falls from its intended position to rest on the ground or a foreign object.
Work order	OEIS 2023-2025 WMP Technical Guidelines	A prescription for asset or vegetation management activities resulting from asset or vegetation management inspection findings.
Workshop	OEIS 2023-2025 WMP Technical Guidelines	Discussion that resembles a seminar but is employed to build specific products, such as a draft plan or policy (e.g., a multiyear training and exercise plan).

1.4 Definitions of Initiatives by Category

Category	Section #	Initiative	Definition
Overview of the Service Territory	5.4.5	Environmental compliance and permitting	Development and implementation of process and procedures to ensure compliance with applicable environmental laws, regulations, and permitting related to the implementation of the WMP.
Risk Methodology and Assessment	6	Risk Methodology and Assessment	Development and use of tools and processes to assess the risk of wildfire and PSPS across an electrical corporation's service territory.
Wildfire Mitigation Strategy Development	7	Wildfire Mitigation Strategy Development	Development and use of processes for deciding on a portfolio of mitigation initiatives to achieve maximum feasible risk reduction and that meet the goals of the WMP.
Grid Design, Operations, and Maintenance	8.1.2.1	Covered conductor installation	Installation of covered or insulated conductors to replace standard bare or unprotected conductors (defined in accordance with GO 95 as supply conductors, including but not limited to lead wires, not enclosed in a grounded metal pole or not covered by: a "suitable protective covering" (in accordance with Rule 22.8), grounded metal conduit, or grounded metal sheath or shield). In accordance with GO 95, conductor is defined as a material suitable for: (1) carrying electric current, usually in the form of a wire, cable or bus bar, or (2) transmitting light in the case of fiber optics; insulated conductors as those which are surrounded by an insulating material (in accordance with Rule 21.6), the dielectric strength of which is sufficient to withstand the maximum difference of potential at normal operating voltages of the circuit without breakdown or puncture; and suitable protective covering as a covering of wood or other non-conductive material having the electrical insulating efficiency (12kV/in. dry) and impact strength (20ft.-lbs) of 1.5 inches of redwood or other material meeting the requirements of Rule 22.8-A, 22.8-B, 22.8-C or 22.8-D
Grid Design, Operations, and Maintenance	8.1.2.2	Undergrounding of electric lines and/or equipment	Actions taken to convert overhead electric lines and/or equipment to underground electric lines and/or equipment (i.e., located underground and in accordance with GO 128).
Grid Design, Operations, and Maintenance	8.1.2.3	Distribution pole replacements and reinforcements	Remediation, adjustments, or installations of new equipment to improve or replace existing distribution poles (i.e., those supporting lines under 65kV), including with equipment such as composite poles manufactured with materials reduce ignition probability by increasing pole lifespan and resilience against failure from object contact and other events

Category	Section #	Initiative	Definition
Grid Design, Operations, and Maintenance	8.1.2.4	Transmission pole/tower replacements and reinforcements	Remediation, adjustments, or installations of new equipment to improve or replace existing transmission towers (e.g., structures such as lattice steel towers or tubular steel poles that support lines at or above 65kV).
Grid Design, Operations, and Maintenance	8.1.2.5	Traditional overhead hardening	Maintenance, repair, and replacement of capacitors, circuit breakers, cross-arms, transformers, fuses, and connectors (e.g., hot line clamps) with the intention of minimizing the risk of ignition.
Grid Design, Operations, and Maintenance	8.1.2.6	Emerging grid hardening technology installations and pilots	Development, deployment, and piloting of novel grid hardening technology.
Grid Design, Operations, and Maintenance	8.1.2.7	Microgrids	Development and deployment of microgrids that may reduce the risk of ignition, risk from PSPS, and wildfire consequence. "Microgrid" is defined by Public Utilities Code section 8370(d).
Grid Design, Operations, and Maintenance	8.1.2.8	Installation of system automation equipment	Installation of electric equipment that increases the ability of the electrical corporation to automate system operation and monitoring, including equipment that can be adjusted remotely such as automatic reclosers (switching devices designed to detect and interrupt momentary faults that can reclose automatically and detect if a fault remains, remaining open if so).
Grid Design, Operations, and Maintenance	8.1.2.9	Line removals (in HFTD)	Removal of overhead lines to minimize the risk of ignition due to the design, location, or configuration of electric equipment in HFTDs.
Grid Design, Operations, and Maintenance	8.1.2.10	Other grid topology improvements to minimize risk of ignitions	Actions taken to minimize the risk of ignition due to the design, location, or configuration of electric equipment in HFTDs not covered by another initiative.
Grid Design, Operations, and Maintenance	8.1.2.11	Other grid topology improvements to mitigate or reduce PSPS events	Actions taken to mitigate or reduce PSPS events in terms of geographic scope and number of customers affected not covered by another initiative.
Grid Design, Operations, and Maintenance	8.1.2.12	Other technologies and systems not listed above	Other grid design and system hardening actions which the electrical corporation takes to reduce its ignition and PSPS risk not otherwise covered by other initiatives in this section.
Grid Design, Operations, and Maintenance	8.1.3.1	Asset inspections	Inspections of overhead electric transmission lines, equipment, and right-of-way.
Grid Design, Operations, and Maintenance	8.1.4	Equipment maintenance and repair	Remediation, adjustments, or installations of new equipment to improve or replace existing connector equipment, such as hotline clamps.
Grid Design, Operations, and Maintenance	8.1.5	Asset management and inspection enterprise system(s)	Operation of and support for centralized asset management and inspection enterprise system(s) updated based upon inspection results and

Category	Section #	Initiative	Definition
			activities such as hardening, maintenance, and remedial work.
Grid Design, Operations, and Maintenance	8.1.6	Quality assurance / quality control	Establishment and function of audit process to manage and confirm work completed by employees or contractors, including packaging QA/QC information for input to decision-making and related integrated workforce management processes
Grid Design, Operations, and Maintenance	8.1.7	Open work orders	Actions taken to manage the electrical corporation's open work orders resulting from inspections that prescribe asset management activities.
Grid Design, Operations, and Maintenance	8.1.8.1	Equipment Settings to Reduce Wildfire Risk	The electrical corporation's procedures for adjusting the sensitivity of grid elements to reduce wildfire risk.
Grid Design, Operations, and Maintenance	8.1.8.2	Grid Response Procedures and Notifications	The electrical corporation's procedures it uses to respond to faults, ignitions, or other issues detected on its grid that may result in a wildfire.
Grid Design, Operations, and Maintenance	8.1.8.3	Personnel Work Procedures and Training in Conditions of Elevated Fire Risk	Work activity guidelines that designate what type of work can be performed during operating conditions of different levels of wildfire risk. Training for personnel on these guidelines and the procedures they prescribe, from normal operating procedures to increased mitigation measures to constraints on work performed.
Grid Design, Operations, and Maintenance	8.1.9	Workforce Planning	Programs to ensure that the electrical corporation has qualified asset personnel and to ensure that both employees and contractors tasked with asset management responsibilities are adequately trained to perform relevant work.
Vegetation Management and Inspection	8.2.2.1	Vegetation inspections	Inspections of vegetation around and adjacent to electrical facilities and equipment that may be hazardous by growing, blowing, or falling into electrical facilities or equipment.
Vegetation Management and Inspection	8.2.3.1	Pole clearing	Plan and execution of vegetation removal around poles per Public Resources Code section 4292 and outside the requirements of Public Resources Code section 4292 (e.g., pole clearing performed outside of the State Responsibility Area).
Vegetation Management and Inspection	8.2.3.2	Wood and slash management	Actions taken to manage all downed wood and "slash" generated from vegetation management activities.
Vegetation Management and Inspection	8.2.3.3	Clearance	Actions taken after inspection to ensure that vegetation does not encroach upon electrical equipment and facilities, such as tree trimming.
Vegetation Management and Inspection	8.2.3.4	Fall-in mitigation	Actions taken to identify and remove or otherwise remediate trees that pose a high risk of failure or fracture that could potentially strike electrical equipment.

Category	Section #	Initiative	Definition
Vegetation Management and Inspection	8.2.3.5	Substation defensible space	Actions taken to reduce ignition probability and wildfire consequence due to contact with substation equipment.
Vegetation Management and Inspection	8.2.3.6	High-risk species	Actions taken to reduce the ignition probability and wildfire consequence attributable to high-risk species of vegetation.
Vegetation Management and Inspection	8.2.3.7	Fire-resilient rights-of-way	Actions taken to promote vegetation communities that are sustainable, fire-resilient, and compatible with the use of the land as an electrical corporation right-of-way.
Vegetation Management and Inspection	8.2.3.8	Emergency response vegetation management	Planning and execution of vegetation activities in response to emergency situations including weather conditions that indicate an elevated fire threat and post-wildfire service restoration
Vegetation Management and Inspection	8.2.4	Vegetation management enterprise system	Operation of and support for centralized vegetation management and inspection enterprise system(s) updated based upon inspection results and activities such as hardening, maintenance, and remedial work.
Vegetation Management and Inspection	8.2.5	Quality assurance / quality control	Establishment and function of audit process to manage and confirm work completed by employees or contractors, including packaging QA/QC information for input to decision-making and related integrated workforce management processes.
Vegetation Management and Inspection	8.2.6	Open work orders	Actions taken to manage the electrical corporation's open work orders resulting from inspections that prescribe vegetation management activities.
Vegetation Management and Inspection	8.2.7	Workforce planning	Programs to ensure that the electrical corporation has qualified vegetation management personnel and to ensure that both employees and contractors tasked with vegetation management responsibilities are adequately trained to perform relevant work.
Situational Awareness and Forecasting	8.3.2	Environmental monitoring systems	Development and deployment of systems which measure environmental characteristics, such as fuel moisture, air temperature, and velocity.
Situational Awareness and Forecasting	8.3.3	Grid monitoring systems	Development and deployment of systems that checks the operational conditions of electrical facilities and equipment and detects such things as faults, failures, and recloser operations.
Situational Awareness and Forecasting	8.3.4	Ignition detection systems	Development and deployment of systems which discover or identify the presence or existence of an ignition, such as cameras.
Situational Awareness and Forecasting	8.3.5	Weather forecasting	Development methodology for forecast of weather conditions relevant to electrical corporation operations, forecasting weather conditions and conducting analysis to incorporate into utility decision-making, learning and updates

Category	Section #	Initiative	Definition
			to reduce false positives and false negatives of forecast PSPS conditions.
Situational Awareness and Forecasting	8.3.6	Fire potential index	Calculation and application of a landscape scale index used as a proxy for assessing real-time risk of a wildfire under current and forecasted weather conditions.
Emergency Preparedness	8.4.2	Emergency preparedness plan	Development and integration of wildfire- and PSPS-specific emergency strategies, practices, policies, and procedures into the electrical corporation's overall emergency plan based on the minimum standards described in GO 166.
Emergency Preparedness	8.4.3	External collaboration and coordination	Actions taken to coordinate wildfire and PSPS emergency preparedness with relevant public safety partners including the state, cities, counties, and tribes.
Emergency Preparedness	8.4.4	Public emergency communication strategy	Development and integration of a comprehensive communication strategy to inform essential customers and other stakeholder groups of wildfires, outages due to wildfires, and PSPS and service restoration, as required by Public Utilities Code section 768.6.
Emergency Preparedness	8.4.5	Preparedness and planning for service restoration	Development and integration of the electrical corporation's plan to restore service after an outage due to a wildfire or PSPS event.
Emergency Preparedness	8.4.6	Customer support in wildfire and PSPS emergencies	Development and deployment of programs, systems, and protocols to support residential and nonresidential customers in wildfire emergencies and PSPS events.
Community Outreach and Engagement	8.5.2	Public outreach and education awareness program	Development and deployment of public outreach and education awareness program(s) for wildfires; outages due to wildfires, PSPS events, and protective equipment and device settings; service restoration before, during, and after the incidents and vegetation management.
Community Outreach and Engagement	8.5.3	Engagement with access and functional needs populations	Actions taken understand, evaluate, design, and implement wildfire and PSPS risk mitigation strategies, policies, and procedures specific to access and functional needs customers.
Community Outreach and Engagement	8.5.4	Collaboration on local wildfire Mitigation planning	Development and integration of plans, programs, and/or policies for collaborating with communities on local wildfire mitigation planning, such as wildfire safety elements in general plans, community wildfire protection plans, and local multi-hazard mitigation plans.
Community Outreach and Engagement	8.5.5	Best practice sharing with other utilities	Development and integration of an electrical corporation's policy for sharing best practices and collaborating with other electrical corporations on technical and programmatic aspects of its WMP program.

Appendix B: Supporting Documentation for Risk Methodology and Assessment



APPENDIX B: SUPPORTING DOCUMENTATION FOR RISK METHODOLOGY AND ASSESMENT

2023-2025 Wildfire Mitigation Plan



Table of Contents

- 1 SUMMARY DOCUMENTATION 1**
- 1.1 Wings-Planning 1
 - 1.1.1 Purpose 1
 - 1.1.2 Assumptions and Limitations 2
 - 1.1.3 Calculation Procedure 2
 - 1.1.4 Characterization and Presentation of Outputs 4
 - 1.1.5 Planned Changes 4
- 1.2 Wings-Ops 4
 - 1.2.1 Purpose 4
 - 1.2.2 Assumptions and Limitations 5
 - 1.2.3 Calculation Procedure 6
 - 1.2.4 Characterization and Presentation of Outputs 8
 - 1.2.5 Planned Changes 8
- 2 DETAILED MODEL DOCUMENTATION 8**

List of Figures

- Figure 1: WiNGS-Planning 1
- Figure 2: WiNGS-Planning Calculation Schematic 3
- Figure 3: WiNGS Visualization Platform 4
- Figure 4: WiNGS-Ops 5
- Figure 5: WiNGS-Ops Calculation Schematic 7

List of Abbreviations

Abbreviation	Name
CoRE	Consequence of risk event
EOC	Emergency Operations Center
HFTD	High Fire Threat District
LoRE	Likelihood of risk event
MAVF	Multi Value Attribute Function
OEIS	Office of Energy Infrastructure Safety
PSPS	Public Safety Power Shutoff
RAMP	Risk Assessment Mitigation Phase

Abbreviation	Name
RSE	Risk Spend Efficiency
SDG&E	San Diego Gas & Electric
WiNGS	Wildfire Next Generation System for Investment
WMP	Wildfire Mitigation Plan
WRRM	Wildfire Risk Reduction Model

1 Summary Documentation

1.1 Wings-Planning

1.1.1 Purpose

The Wildfire Next Generation System for Investment (WiNGS) Planning model was developed to aid with the allocation of grid hardening initiatives across the High Fire Threat District (HFTD) based on an assessment of both wildfire risk and PSPS impacts. WiNGS-Planning is built upon the Multi Value Attribute Function (MAVF) framework in Risk Assessment Mitigation Phase (RAMP) and evaluates both wildfire and Public Safety Power Shutoff (PSPS) impacts at the sub-circuit/segment level. The segment level of data granularity is required to establish the segment parameters. Information is used to inform investment decisions by determining and prioritizing mitigation based on Risk Spend Efficiencies (RSEs), improving wildfire safety, and limiting the impact of PSPS on customers.

Consistent with the Draft Guidelines originally prepared by Office of Energy Infrastructure Safety (OEIS), San Diego Gas & Electric (SDG&E) prepared detailed documentation for the WiNGS-Planning model. SDG&E will make this documentation available to Energy Safety and stakeholders upon request.

Figure 1: WiNGS-Planning

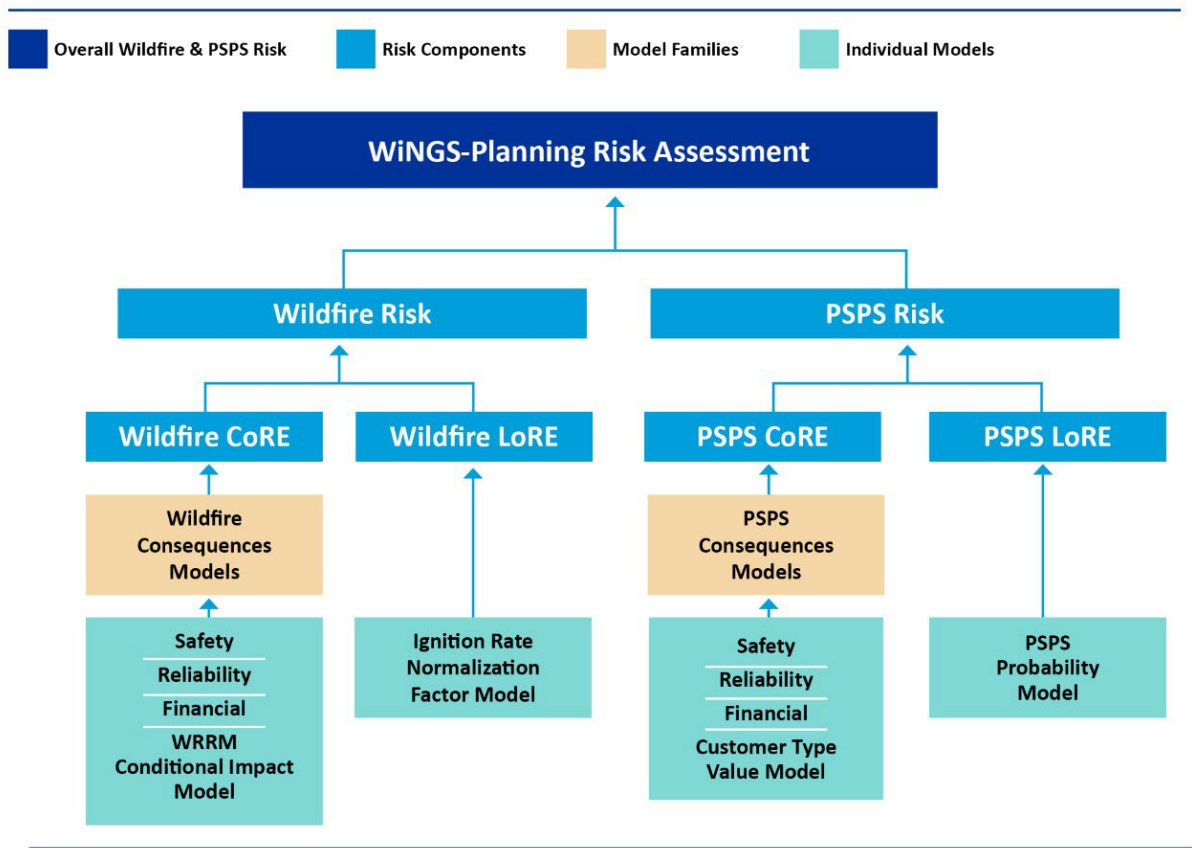

1.1.2 Assumptions and Limitations

The WiNGS Planning model is one element in a vast decision process that aids in the application of wildfire mitigations for investment planning decisions. While the model presents an unbiased mitigation decision, it is vital that the proposed mitigations undergo subject matter expertise review. This is accomplished via the desktop feasibility analysis that accompanies the scoping process. This feasibility analysis includes geography, loading, specific standards, environmental, and other projects. SDG&E continues to improve and expand the analysis and inputs of the model; however, the model alone does not dictate investment planning.

Another limitation surrounds the circuit segment units used in the model. When grouping many assets together, the model must make decisions based on group rather than individual asset conditions. While the individual asset conditions make up the circuit segment statistics, information is generalized as part of the aggregation process. For instance, the model uses the average conductor age to adjust the ignition rate, however, the average conductor age simplifies the characteristics of the individual spans that comprise the circuit segment. Due to the nature of the circuit segment configuration, it is possible that a very new span will skew the average towards a newer average age rather than the majority age for the segment. Improvements to model statistics are expected to mature during the current Wildfire Mitigation Plan (WMP) cycle. Considering the limitations of the segment-level aggregation process, the circuit segment continues to remain the most viable unit of measure for the application of mitigation decisions. Span level mitigation applications are impractical because network connectivity is obfuscated at this granular level when individual spans are mitigated without the consideration of the electric network. Also, PSPS mitigation is difficult to accomplish when mitigating individual spans without mitigating the segment and upstream segments where they reside. On the other hand, whole circuit mitigations may take years to accomplish and could leave high risk spans outside of the circuits being mitigated without a timely mitigation plan. Taking into account the drawbacks of span level and whole circuit solutions, the circuit segment is the most practical unit for the application of mitigation decisions.

For additional assumptions and limitations, refer to Section 6.2.3 in the 2023-2025 WMP.

1.1.3 Calculation Procedure

The main components of the WiNGS-Planning model are Wildfire likelihood of risk event (LoRE) and consequence of risk event (CoRE) and PSPS LoRE and CoRE. Each of these components could be viewed as individual models within the parabola of the WiNGS-Planning model. These components are connected and play a pivotal role in risk quantification as well as mitigation selection.

The Wildfire Risk and PSPS risk scores are combined to form an overall segment risk score. Wildfire Risk, PSPS Risk, and Overall Wildfire and PSPS Risk are all analyzed to help identify high- and low-risk segments across the service territory according to the risk score.

A general model process flow diagram depicting the various model elements and process steps and their interactions is detailed in Figure 2.

Figure 2: WiNGS-Planning Calculation Schematic

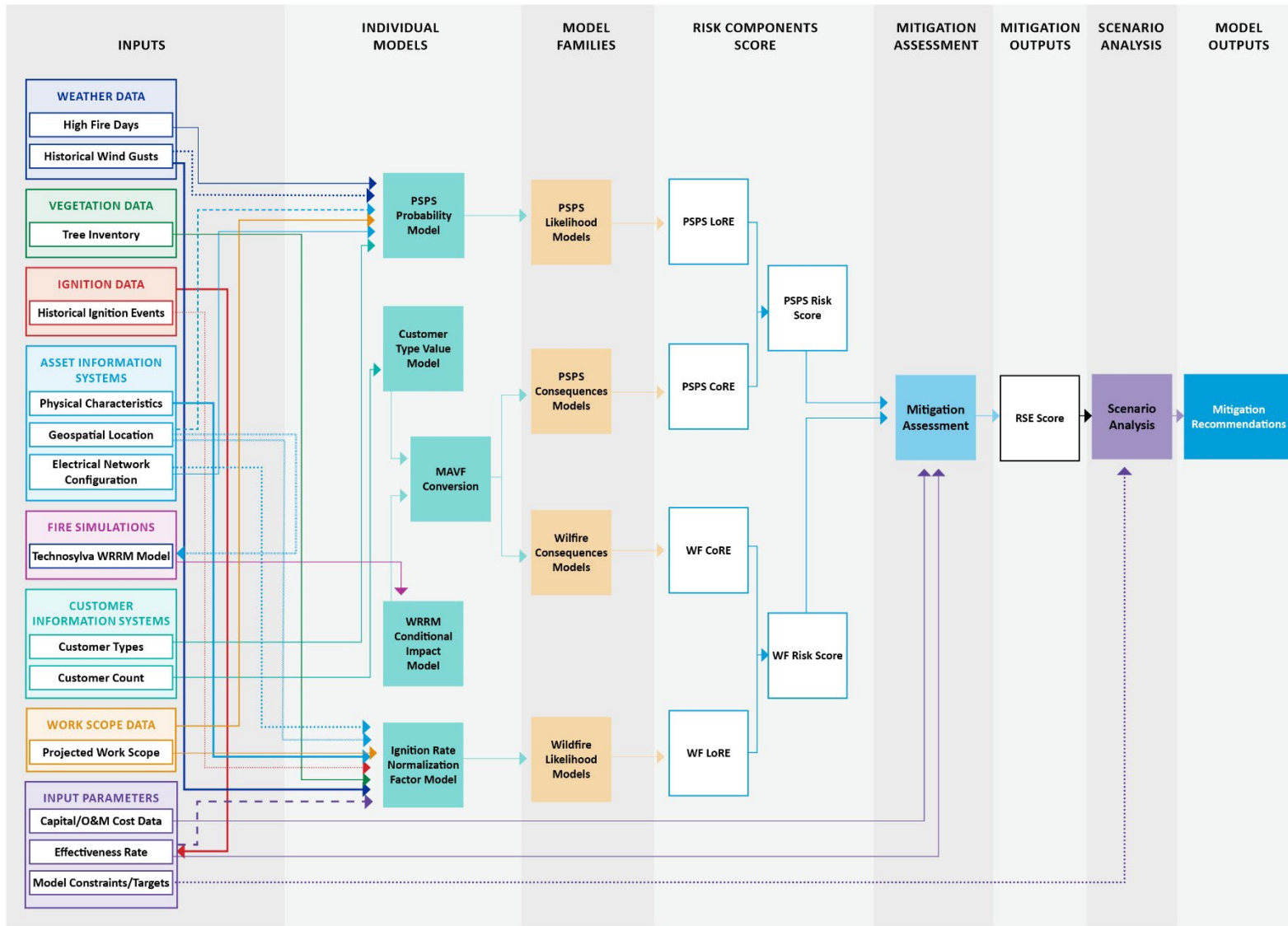

1.1.4 Characterization and Presentation of Outputs

A platform for the visualization of analytics results is currently in development. The WiNGS Visualization platform will be used to visually display and to disseminate the output of the WiNGS models to various user groups from top level executives to scoping analysts to Emergency Operations Center (EOC) decision makers, and other stakeholders. The application consists of dashboards WiNGS-Planning with dynamic web maps linked to informative widgets designed for investment planning. Within the Visualization platform applications, users will be able to view circuit and segment-level risk in the context of wildfire and PSPS events. Users will be able to run the WiNGS-Planning model with a virtually limitless number of design-level scenarios to help guide investment decisions. The application is expected to go live in 2023.

Figure 3: WiNGS Visualization Platform

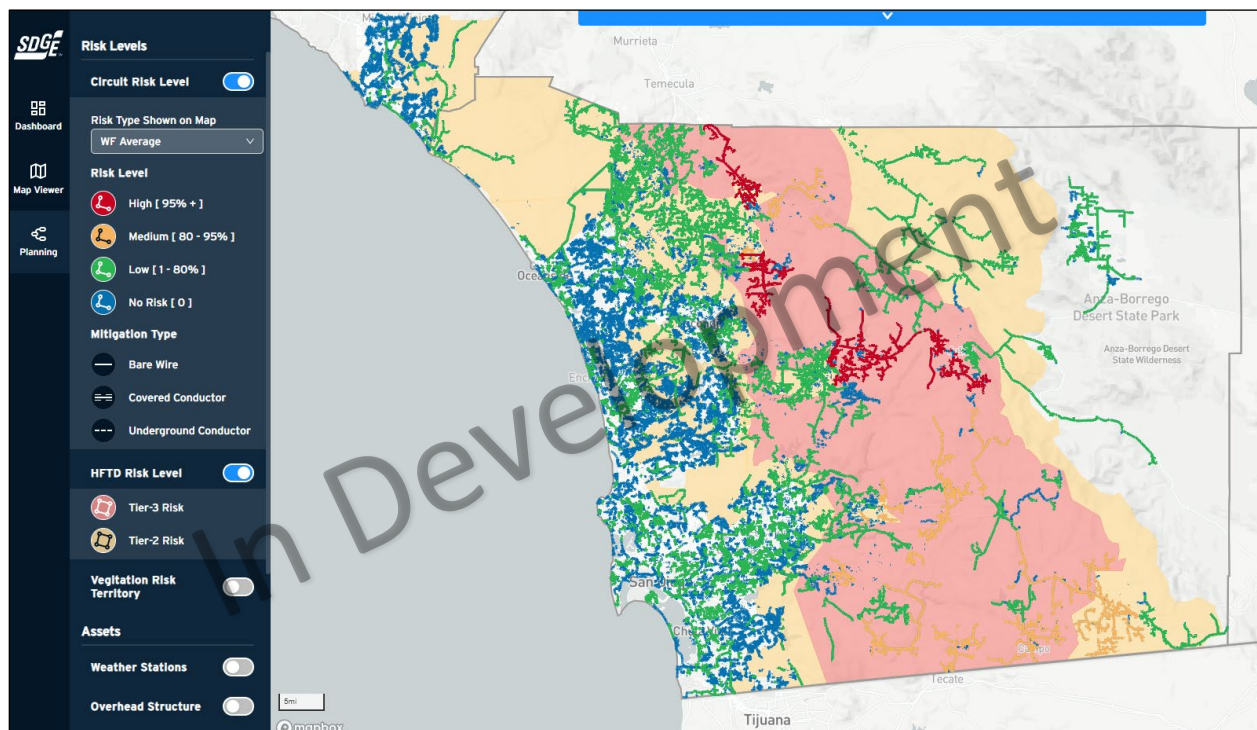

Source: Image extracted from WiNGS-Planning Visualization Application (in development)

1.1.5 Planned Changes

For planned changes, see Section 6.7 of the 2023-2025 WMP.

1.2 Wings-Ops

1.2.1 Purpose

WiNGS Operations (WiNGS-Ops) is a real-time risk assessment model built to evaluate and compare Wildfire and PSPS risks at the asset level (pole/span) and the sub-circuit/segment level at hourly intervals. The primary purpose of the model is to help inform decision makers in real-time about the

Wildfire and PSPS risks, which will guide risk-based de-energization decisions during risk events. The model outputs used to help guide decision makers are understood to represent a range of potential risk of Wildfire versus PSPS comparisons.

Figure 4: WINGS-Ops

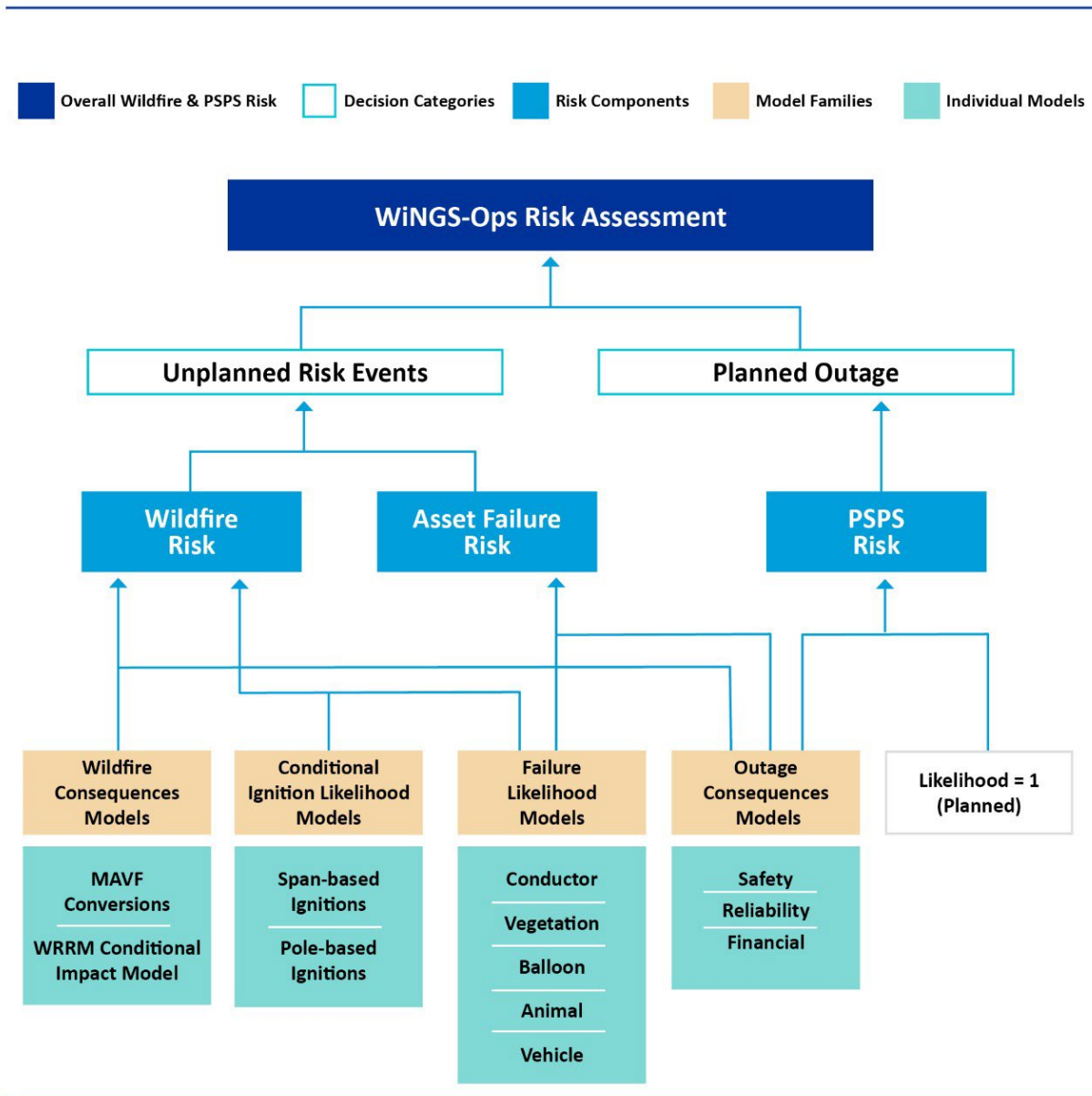

1.2.2 Assumptions and Limitations

Machine learning models are limited by the characteristics of the training data, such as the number of risk event observations and the temporal-spatial granularity and range of the data collected. For example, if data is collected from only the past few years, then the model results will be biased towards patterns observed during those years. Additional data that is used to generate machine learning

features should ideally match the temporal-spatial range and granularity of the training data, although this is not a strict limitation if appropriately managed. This limitation commonly occurs when integrating external data. For example, public land use maps used for training some models cover only San Diego County. Therefore, the values used for assets located outside of San Diego County must be imputed or approximated for some algorithms, typically by using a mean value.

Another general limitation for machine learning is the computational limitations during both model training and inference. While the algorithms described in this document are conceptually simple, they often have heavy computational requirements that limit model complexity. For this reason, considerable effort has been given to migrate WiNGS-Ops to a cloud-based data science platform, such that distributed cloud resources can be leveraged. However, this process also comes with added challenges in software and runtime environments, data access and security, and human capital required to navigate cloud tools.

Key assumptions for machine learning models:

- Outages (SAIDIDAT) assumed to be failures
- Reportable ignitions as totality of outages that have caused ignitions
- Representativeness of assets and time and sampling of training set
- Relatively coarse mapping of asset to anemometers is sufficient
- The mapping of outage or ignition to a specific asset in some cases when this was not recorded or could not be determined by field workers.

For wildfire consequence, the Wildfire Risk Reduction Model (WRRM) model estimates tangible impacts (e.g., structures destroyed, acres burned) from which the MAVF core attributes are derived. Therefore, an additional layer of modeling determines the MAVF attribute values from the WRRM model outputs. This step requires several discretionary assumptions that are assessed prior to PSPS events and are typically reported in post-PSPS reports.

For additional assumptions and limitations, see Section 6.2.3 of the 2023-2025 WMP.

1.2.3 Calculation Procedure

The WiNGS-Ops model takes input data from a variety of internal and external data sources. For machine learning models, the inputs are determined by the feature selection methodology. Figure 5 details the inputs, outputs, and interdependencies of the data flowing through the model. The subsections elaborate on the specific implementations and calculations of this flow diagram.

Figure 5: WiNGS-Ops Calculation Schematic

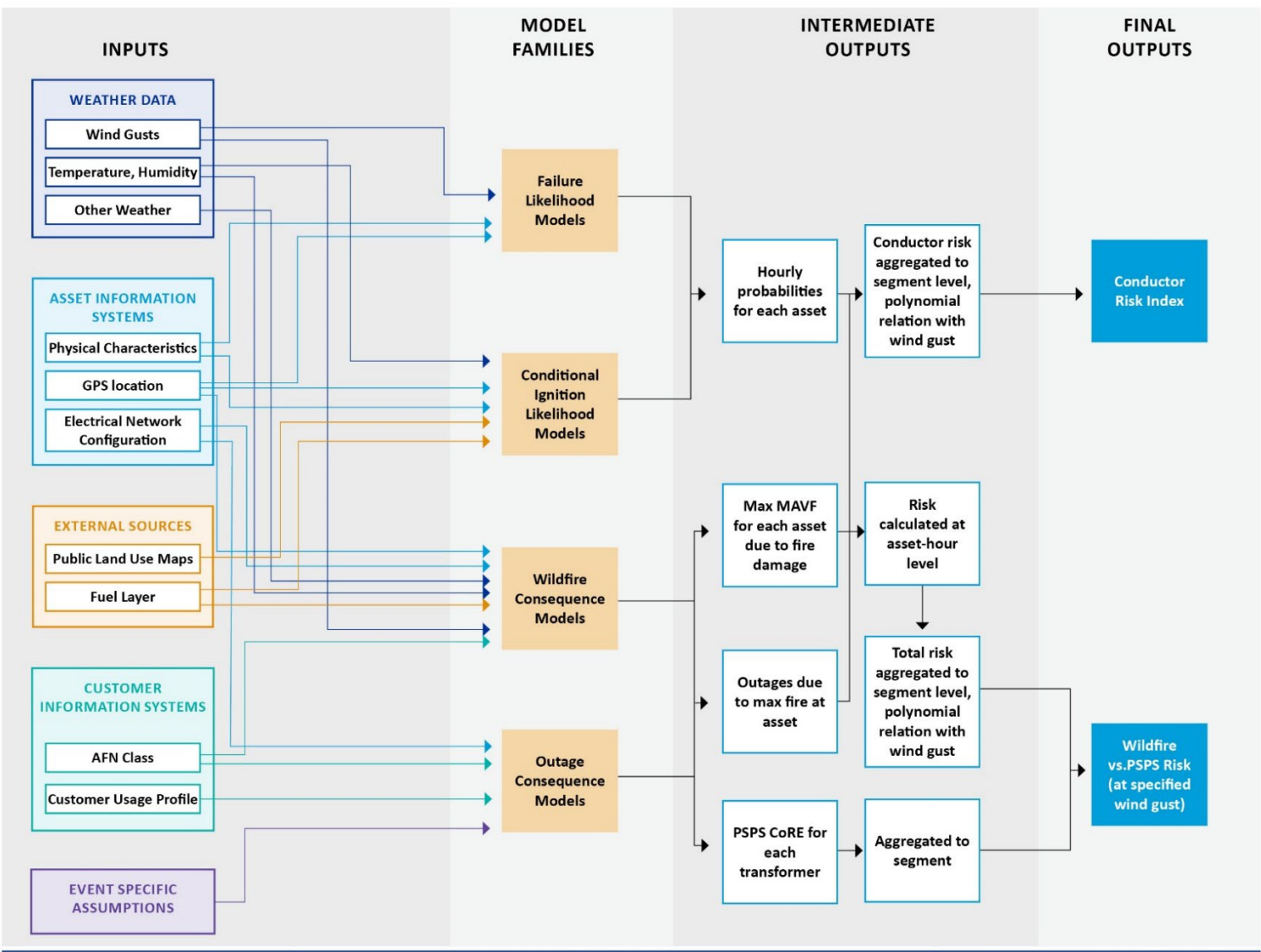

1.2.4 Characterization and Presentation of Outputs

A platform for the visualization of analytics results is currently in development. The WiNGS Visualization platform will be used to visually display and to disseminate the output of the WiNGS models to various user groups from top level executives to scoping analysts to EOC decision makers, and other stakeholders. The application consists of dashboards for WiNGS-Ops with dynamic web maps linked to informative widgets designed PSPS decision making. Within the Visualization applications, users will be able to view circuit and segment-level risk in the context of wildfire and PSPS events. The WiNGS-Ops application will be a real-time, interactive application that utilizes comprehensive and dynamic risk modeling at the segment level based on forecasted fire conditions. The primary function of WiNGS-Ops is to provide the ability to weigh the quantified risks of a binary choice of actions: de-energization or not (PSPS). This machine plus human experience strengthens the PSPS decision-making confidence by enabling a more targeted approach to asset-level reporting and real time weather updates.

1.2.5 Planned Changes

For planned changes, see Section 6.7 of the 2023-2025 WMP.

2 Detailed Model Documentation

Model documentation available to Energy Safety and stakeholders upon request.

Appendix C: Additional Maps



APPENDIX C: ADDITIONAL MAPS

2023 Wildfire Mitigation Plan



All maps required in the 2023-2025 WMP were of sufficient detail; SDG&E does not provide any additional maps in this Appendix.

Appendix D: Areas for Continued Improvement

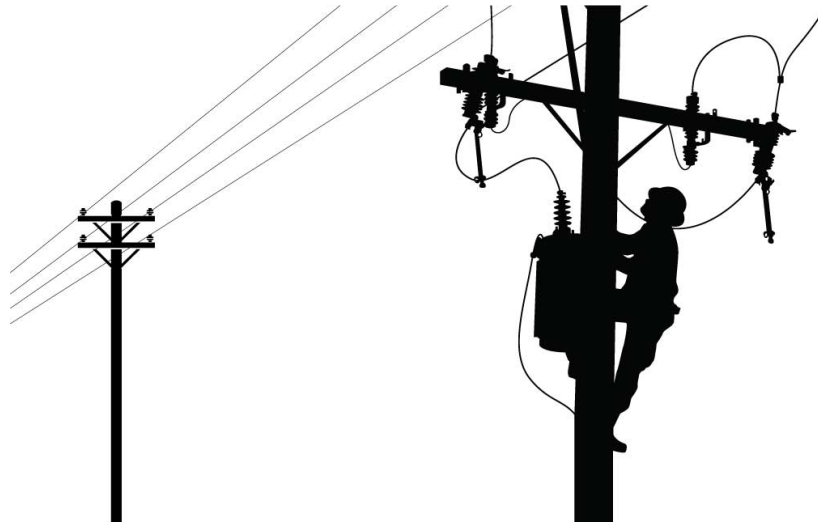

APPENDIX D: AREAS FOR CONTINUED IMPROVEMENT

2023 Wildfire Mitigation Plan



Table of Contents

1	SDGE-22-01 Prioritized List of Wildfire Risks and Drivers	1
2	SDGE-22-02 Collaboration and Research in Best Practices in Relation to Climate Change Impacts and Wildfire Risk and Consequence Modeling	3
3	SDGE-22-03 Utility Arborist Training Initiatives	4
4	SDGE-22-04 Inclusion of Community Vulnerability in Consequence Modeling.....	6
5	SDGE-22-05 Fire Suppression Considerations.....	7
6	SDGE-22-06 Eight-Hour Fire Spread Simulations	8
7	SDGE-22-07 Risk Prioritization for Mitigation Measures	9
8	SDGE-22-08 Evaluation of Wildfire Risk Outside of the HFTD	10
9	SDGE-22-09 Evaluation of Wind Gust Effects on Vegetation-Related Failures.....	11
10	SDGE-22-10 Wildfire Consequence Modeling Improvements	13
11	SDGE-22-11 Applying Joint Lessons Learned Concerning Covered Conductor.....	14
12	SDGE-22-12 Covered Conductor Inspection and Maintenance	15
13	SDGE-22-13 New Technologies Evaluation and Implementation	16
14	SDGE-22-14 Grid Hardening Decision-Making Process Transparency	17
15	SDGE-22-15 Undergrounding Risk-Spend Efficiency Demonstration	20
16	SDGE-22-16 Enabling Circuits with Advanced Protection	22
17	SDGE-22-17 Further Development of Integrating Risk-Informed Decision Making for Inspection Scheduling and Planning	23
18	SDGE-22-18 Evaluation and Interpretation of “Other” Equipment Failures.....	24
19	SDGE-22-19 Plan to Address Missing Asset Data	25
20	SDGE-22-20 Progression of Effectiveness of Enhanced Clearances Joint Study.....	26
21	SDGE-22-21 Consideration of Alternatives to Fuels Treatment Activity.....	27
22	SDGE-22-22 Participation in Vegetation Management Best Management Practices Scoping Meeting.....	28
23	SDGE-22-23 PSPS Wind Threshold Change Evaluations.....	29
24	SDGE-22-24 Replacing Protective Devices for Sensitivity Setting Capabilities	30
25	SDGE-22-25 Validation of Vegetation Risk Index (VRI)	31

26	SDGE-22-26 Validation of Wildfire Risk Reduction Model (WRRM)	32
27	SDGE-22-27 Improvements to Capital Allocation Methodology.....	33
28	SDGE-22-28 Improvements to the RSE Verification Process	34
29	SDGE-22-29 Mitigation Plan for Frequently De-Energized Circuits	35
30	SDGE-22-30 Improvements to the WiNGS-Ops and WiNGS-Planning Models.....	36

List of Tables

Table 1: Prioritized Wildfire Risks and Drivers.....	1
Table 2: Hiring Status for Utility Line Clearance Arborist Training Participants	4
Table 3: Impacts of Strategic Undergrounding and Covered Conductor.....	20

List of Attachments

- Attachment A: Analysis of Wind Effects on Vegetation-Related Outages
- Attachment B: Joint IOU Covered Conductor Working Group Report
- Attachment C: Enhanced Clearance Joint Response
- Attachment D: WMS Work Summary
- Attachment E: WiNGS-Ops Progress Report

List of Abbreviations

Abbreviation	Name
AAP	Advanced Protection Program
AFN	Access and Functional Needs
CAL FIRE	California Department of Forestry and Fire Protection
Caltrans	California Department of Transportation
CC	California Conservation Corps
CNF	Cleveland National Forest
CPUC	California Public Utilities Commission
D	Decision
DIAR	Drone Investigation, Assessment and Repair
ESH	Electrical System Hardening
FCP	Falling Conductor Protection
FPI	Fire Potential Index
FSCA	Fire Science and Climate Adaptation
FWI	Fire Weather Index

Abbreviation	Name
GO	General Order
HFTD	High Fire Threat District
IOU	Investor-Owned Utility
PG&E	Pacific Gas & Electric
PoF	Probability of failure
Pol	Probability of Ignition
PSPS	Public Safety Power Shutoff
RAMP	Risk Assessment Mitigation Phase
RDF	Risk-Based Decision-Making Framework
RFW	Red Flag Warning
RSE	Risk Spend Efficiency
S-MAP	Safety Model and Assessment Proceeding
SCADA	supervisory control and data acquisition
SCE	Southern California Edison
SDSC	San Diego Supercomputer Center
SGF	sensitive ground fault
SRP	sensitive relay profile
UC	Urban Corps
UCSD	University of California San Diego
SDG&E	San Diego Gas & Electric
VRI	Vegetation Risk Index
WiNGS	Wildfire Next Generation System
WMP	Wildfire Mitigation Plan
WRRM	Wildfire Risk Reduction Model
WUI	Wildland Urban Interface

1 SDGE-22-01 Prioritized List of Wildfire Risks and Drivers

Description

SDG&E’s prioritized list of wildfire risks and drivers (2022 WMP Update Table 4-6) weighs the risk drivers by average outage multiplied by ignition rate; it does not account for the likelihood of the ignition to cause a catastrophic wildfire.

Required Progress

SDG&E must further refine its prioritized list of wildfire risks and drivers. It must do so by weighting each risk driver by likelihood of causing a catastrophic wildfire (e.g., does this ignition tend to happen in high wildfire risk areas identified by SDG&E’s risk models, including the HFTD).

SDG&E Response

San Diego Gas & Electric (SDG&E) has coupled ignition data within its existing reporting with subject matter expertise from Fire Coordinators to consider the likelihood of ignitions becoming catastrophic wildfires. SDG&E reviewed the ignition data coupled with real-world observation, experience in responding to incidents related to these drivers, and other fire incidents occurring in areas of the High Fire Threat District (HFTD) with the potential to support a catastrophic fire. This input was then used to update the Wildfire Risk Driver ranking. Through this process, subject matter experts were consulted and data was analyzed to understand factors that can contribute to a catastrophic fire. For example, while a model run of a particular ignition may indicate rapid spread with a low likelihood of containment, the real-world conditions may indicate that the ignition occurred down the street from a fire station or in an area that typically has more success controlling fires. SDG&E also worked to identify the types of utility ignition sources that may be located in areas that have difficult access for first responders and thus have a greater potential for an ignition to become a catastrophic fire. Coupling data and expertise added value to the process and refined the ignition drivers that have a greater probability of igniting a fire that becomes catastrophic. Table 1 contains the prioritized list of wildfire risks and drivers.

For further discussion regarding additional wildfire risk factors, see the 2023-2025 WMP 6.7.

Table 1: Prioritized Wildfire Risks and Drivers

New Ranking	Cause Category	Cause Sub Category
1	Equipment Failure	Connection device damage or failure
2	Equipment Failure	Lightning arrestor damage or failure
3	Equipment Failure	Transformer damage or failure
4	Equipment Failure	Switch damage or failure
5	Equipment Failure	Fuse damage or failure
6	Equipment Failure	Capacitor bank damage or failure
7	Equipment Failure	Conductor damage or failure

New Ranking	Cause Category	Cause Sub Category
8	Equipment Failure	Anchor / guy damage or failure
9	Equipment Failure	Crossarm damage or failure
10	Equipment Failure	Pole damage or failure
11	Equipment Failure	Insulator and brushing damage or failure
12	Equipment Failure	Equipment Failure Other
13	Equipment Failure	Recloser damage or failure
14	Equipment Failure	Sectionalizer damage or failure
15	Equipment Failure	Voltage regulator / booster damage or failure
16	Contact from object	Veg Contact
17	Contact from object	Balloon Contact
18	Contact from object	Vehicle
19	Contact from object	Animal Contact
20	Contact from object	Other contact from object
21	Other	All Other
22	Unknown	Unknown
23	Wire-to-wire contact / contamination	Wire-to-wire contact / contamination
24	Vandalism / Theft	Vandalism / Theft
25	Contamination	Contamination
26	Utility work / Operation	Utility work / Operation

2 SDGE-22-02 Collaboration and Research in Best Practices in Relation to Climate Change Impacts and Wildfire Risk and Consequence Modeling

Description

SDG&E and the other large IOUs are currently pursuing their own efforts at integrating the potential impacts of climate change in their risk and consequence modeling. They are not actively collaborating with each other on these efforts nor taking advantage of the existing climate change modeling expertise of state agencies and academic institutions.

Required Progress

SDG&E must participate in an Energy Safety-led scoping meeting to discuss how utilities can best learn from each other, external agencies, and outside experts.

SDG&E Response

The Energy Safety-led scoping meeting has not yet discussed how to best account for, quantify, and model climate change impacts and wildfire risk and consequence modeling. Once guidance has been determined, SDG&E will evaluate and incorporate the guidance in wildfire risk modeling.

SDG&E continues to collaborate with industry experts, academia, government agencies, and other stakeholders to better understand climate change impacts and wildfire risk and consequence modeling.

SDG&E is conducting a system-wide climate change vulnerability assessment looking at mid- and end-of-century climate change projections. As a part of this assessment, projected 95th percentile Fire Weather Index (FWI) values and the number of future days above the current baseline 95th percentile FWI are modeled. As new research becomes available with future California Climate Change Assessments, SDG&E plans to align with the best available science and collaborate with researchers and industry experts to ensure SDG&E stays on the leading edge of thinking in this space.

When assessing wildfire risk, the regions prioritized are primarily the HFTD, though analysis is conducted across the entire service territory to better understand the potential impacts across coastal canyons and the Wildland Urban Interface (WUI).

SDG&E's climate adaptation team analyzed the latest available climate science to determine the most applicable analysis to inform the internal wildfire risk modeling. Based on this analysis, *Climate change is increasing the likelihood of extreme autumn wildfire conditions across California* (Goss et al 2020)¹ was determined to be most applicable research due to the focus on increased occurrence of fire weather conditions during the fall months, which represent the period of time with the highest risk events across San Diego County and Orange County.

For further discussion regarding climate change and its impacts, see the 2023-2025 WMP Section 5.3.4.2.

¹ <https://iopscience.iop.org/article/10.1088/1748-9326/ab83a7>

3 SDGE-22-03 Utility Arborist Training Initiatives

Description

SDG&E does not provide details on the scope of Utility Arborist training initiatives it is developing or supporting.

Required Progress

SDG&E must provide more details on utility vegetation management workforce training initiatives it is developing and/or supporting. Details to include are as follows:

1. The number of people entering classes using the Utility Arborist Trainee curriculum at California community colleges and/or other training programs developed and/or supported by SDG&E.
2. The number completing the classes or other training programs.
3. The number of those completing the classes or other training programs subsequently joining the utility vegetation management workforce.
4. Any additional details on how SDG&E is addressing utility vegetation management labor constraints.

SDG&E Response

Since mid-2021, SDG&E has sponsored and participated in three Utility Line Clearance Arborist training sessions in collaboration with the San Diego Community College District, Utility Arborist Association, California Conservation Corps (CCC), and the Urban Corps of San Diego County (UC). The 5-week program includes classroom and field and provides participants with the training to become professional, qualified line-clearance arborists. The first two cohorts were relatively small due to COVID-19 restrictions in 2021 and early 2022. The third cohort, which took place in late 2022, had higher participation. A total of 44 students participated in these cohorts. Table 2 provides the breakdown of hiring status for participants. This data is current as of December 2022. Many of the graduated students are in-process to be scheduled for an interview and/or are finishing their contractual commitment with the CCC or UC before they can seek employment.

SDG&E plans to continue this utility training program in 2023 and plans to include a new curriculum for Certified Arborist training. The enactment of Senate Bill 247 in 2020 resulted in substantial wage increases for utility line clearance workers. Partly for this reason and due to a relatively consistent work volume, SDG&E's tree contractors have not experienced a deficiency in obtaining a sufficient workforce for its operations. SDG&E will be entering a strategic sourcing initiative in early 2023 for all its vegetation management service agreements which will include extending contract terms for at least 5 years. This will help bring stability and consistency to SDG&E's Vegetation Management labor agreements and facilitate positive resource planning and work scheduling.

Table 2: Hiring Status for Utility Line Clearance Arborist Training Participants

Utility Arborist Trainee #	Cohort 1	Cohort 2	Cohort 3
Students	10	14	20
Hired	5	7	2
In-process	1	2	7

Utility Arborist Trainee #	Cohort 1	Cohort 2	Cohort 3
Finishing contract with CCC or UC	3	3	10

For further discussion regarding of Utility Arborist training initiatives, see the 2023-2025 WMP Section 8.2.7.

4 SDGE-22-04 Inclusion of Community Vulnerability in Consequence Modeling

Description

SDG&E does not currently include the impacts of wildfire on communities, such as community vulnerability, within consequence modeling.

Required Progress

SDG&E must participate in an Energy Safety-led scoping meeting to discuss how to best learn from each other, external agencies and outside experts

SDG&E Response

In April 2022, SDG&E participated in an Energy Safety-led scoping meeting to discuss how Investor-Owned Utilities (IOUs) can best learn from each other, external agencies, and outside experts related to the topic of inclusion of community vulnerability in consequence modeling. SDG&E will continue to participate in upcoming workshops in 2023.

As the safety impact of a Public Safety Power Shutoff (PSPS) event is not the same for all customer types, a Customer Type Value Consequence is estimated to represent different levels of safety impacts. Based on subject matter expertise assumptions, different weightings (or scaling factors) are applied to each customer meter to increase the number of SIFs downstream of each supervisory control and data acquisition (SCADA) Sectionalizing device. Customer Type Value Consequence includes:

- Critical Facilities and Infrastructure: Urgent customers whose mission supports regional emergency response (e.g., police, fire department, hospitals) as well as customers who are essential to public health, safety, and security as defined by the California Public Utilities Commission (CPUC) (e.g., public utilities, communications providers, water service providers, transportation)
- Community Vulnerability: Access and Functional Needs (AFN) customers based on CPUC's definition of AFN customers
- Other: All other customers that do not fall in either the critical or AFN categories

For further discussion regarding the inclusion of customer impacts in consequence modeling, see the 2023-2025 WMP Section 6.2.2.2. See 2023-2025 WMP Section 6.7 for planned improvements including impacts of wildfire on communities, such as community vulnerability, within consequence modeling.

5 SDGE-22-05 Fire Suppression Considerations

Description

SDG&E's fire spread modeling does not currently factor in fire suppression effects (e.g., fire department efforts).

Required Progress

SDG&E must work with other utilities to evaluate how to best account for, quantify, and model suppression effects on wildfire spread. Further guidance will be determined and covered during the risk model working group meetings established by Energy Safety's 2021 WMP Action Statements.

SDG&E Response

The risk model working group has not yet discussed how to best account for, quantify, and model suppression effects on wildfire spread. Once guidance has been determined, SDG&E will incorporate guidance in its fire spread modeling. SDG&E plans to partner with industry experts, academia, government agencies, and other stakeholders to better understand and quantify the impact of suppression activity.

6 SDGE-22-06 Eight-Hour Fire Spread Simulations

Description

SDG&E's eight-hour fire spread simulations may be impacting the accuracy of its wildfire spread consequence modeling.

Required Progress

1. SDG&E must benchmark against other utilities to account for catastrophic fire risk that occurs more than eight hours post-ignition and provide a summary of lessons learned in its 2023 WMP. Further guidance may be determined and covered within the risk model working group established by the 2021 WMP Action Statements.
2. SDG&E must include a description of resulting changes to its wildfire spread consequence modeling or anticipated changes and a timeline for implementation.

SDG&E Response

In collaboration with Pacific Gas & Electric (PG&E) and Southern California Edison (SCE), SDG&E works with Technosylva to annually enhance their Wildfire Risk Reduction Model (WRRM) consequence model that currently estimates 8-hour fire spread simulations. Technosylva's WRRM model outputs are considered in the Wildfire Next Generation System (WiNGS)-Ops model to quantify the wildfire versus PSPS risks. The design basis for Wildfire Consequence modeling is currently being evaluated to expand beyond the 8-hour fire simulation duration. The Technosylva WRRM model currently uses an 8-hour simulation that is based upon a typical first burning period. Technosylva is evaluating different fire durations based on suggestions in the Wildfire Mitigation Plan (WMP) Guidelines.

SDG&E has begun collaborating with RMS, a Moody's Analytics Company, to model and quantify the impact of long-term-duration fires. SDG&E will review RMS's outputs and will evaluate the inclusion of these outputs in the WiNGS-Planning and WiNGS-Ops models in the 2023 to 2025 WMP cycle.

For further discussion regarding planned improvements in wildfire consequence modeling, see the 2023-2025 WMP Section 6.7.

7 SDGE-22-07 Risk Prioritization for Mitigation Measures

Description

SDG&E only calculated the cumulative top risk coverage estimates based on risk model output for covered conductor and undergrounding.

Required Progress

SDG&E must provide an update on its progress using risk model output to inform its initiative plans based on highest risk areas, including determination of top risk percentages, for all initiatives, including covered conductor and undergrounding.

SDG&E Response

The WiNGS-Planning model is utilized to obtain segment risk ranking, segment cost-benefit analysis, and portfolio variations. The WiNGS-Planning model evaluates both wildfire and PSPS impacts to inform investment decisions by determining which initiatives provide the greatest benefit per dollar spent in reducing both wildfire risk and PSPS impacts. WiNGS-Planning analysis is conducted at the circuit-segment level. The segment level of data granularity is required to establish segment parameters. The WiNGS-Planning model has been used to analyze segments in Tier 2 and Tier 3 of the HFTD, segments with historical PSPS event occurrences, and higher-risk urban areas such as coastal canyons or wildland open spaces. The higher-risk urban areas were specifically identified with input from the Fire Science and Climate Adaptation (FSCA), overlaying the WUI from the California Department of Forestry and Fire Protection California Department of Forestry and Fire Protection (CAL FIRE) and review of historical wildfire. The use of WiNGS-Planning to inform priorities in the WMP is limited to the Covered Conductor and Strategic Undergrounding Programs. This segment approach to executing mitigations and scoping the whole circuit segment not only addresses wildfire risk but reduces the impact of PSPS events.

An approach used by SDG&E to retroactively look at mitigation selection was to create bins by riskiest overhead circuit-segment in the HFTD. This approach shows the distribution of wildfire risk across the HFTD and shows the deployment of mitigation in the highest wildfire risk areas. This circuit analysis evaluates PSPS risk score and PSPS dependencies when selecting a mitigation. This grid hardening method helps to limit mobilization, effectively survey, support long-term plan considerations, and optimize community impact.

For further discussion regarding evaluating model updates to inform additional initiatives, see the 2023-2025 WMP Section 6.7. For further discussion regarding model output and risk ranking, see the 2023-2025 WMP Section 7.1.3.

8 SDGE-22-08 Evaluation of Wildfire Risk Outside of the HFTD

Description

SDG&E has yet to evaluate the potential need for adjustment of the HFTD.

Required Progress

- SDG&E must analyze its service territory to determine if there are additional higher wildfire risk areas outside of the HFTD boundaries and include in its 2023 WMP its findings and a description of the analysis performed, including factors considered, and include any territory newly classified by SDG&E as high risk within the treatment area for its mitigation initiatives.
- If it identifies any new areas of higher wildfire risk, SDG&E must provide a process outlining the formal steps necessary to have those areas considered for recognition in the CPUC-defined HFTD

SDG&E Response

SDG&E assesses the HFTD annually to consider potential changes. The variables used to create the HFTD are weighed and suggested modifications and new information is evaluated.

Recent modeling initiatives evaluated the wildfire risk of coastal canyons and the WUI for mitigation. Both efforts resulted in the exclusion of each proposed addition. Polygons in the WUI layer focused on the developed areas near vegetated areas and did not include the vegetated areas themselves. In addition, these areas did not necessarily have overhead electric lines. While this layer may serve to prioritize the adjacent developed areas for fire infrastructure and suppression planning, it does not yield a usable layer for identifying areas where an energized wire down could spark a wildfire, or areas at heightened risk for ignition due to interference from vegetation.

The coastal canyon analysis evaluated risk areas identified by subject matter experts, CAL FIRE data, and historical fire history. The analysis found that wildfire risk associated with coastal canyons was far below risk associated with HFTD segments, making scoping of coastal canyon segments a lower priority. Based on these two analyses, SDG&E does not propose any additions or removals from the HFTD. SDG&E will continue to monitor risk in the service territory to analyze the need for adjustment of risk. The fire history and fire environment are still consistent with the conditions that were present when the original HFTD shape was created, and any new information has not warranted a change.

If SDG&E identifies any new areas of higher wildfire risk, SDG&E will follow the CPUC guidelines for changes, justify the proposed changes, and work in collaboration with the CPUC and CAL FIRE.²

For further discussion regarding SDG&E's evaluation of wildfire risk outside the HFTD, see the 2023-2025 WMP Section 5.3.3 and Section 6.4.1.2.

² <https://docs.cpuc.ca.gov/PublishedDocs/Published/G000/M172/K762/172762082.PDF>

9 SDGE-22-09 Evaluation of Wind Gust Effects on Vegetation-Related Failures

Description

SDG&E does not currently account for wind gust effects within its vegetation probability of failure (PoF) model.

Required Progress

SDG&E must:

1. Provide a description of any analysis it has completed to evaluate the effects of wind gust effects on vegetation failures (including factors considered, weighing of various factors, and wind studies used) and provide a description of any additional analysis needed to evaluate wind gust effects on vegetation-related failures.
2. Provide an update on any changes made to its PoF model as a result of its analysis of wind gust effects on vegetation failures.
3. Provide a timeline for any future analyses on wind gust effects, as applicable, including reasoning for the need of future analysis, and cadence for performance of future analysis.
4. Provide a timeline for any future changes to its model related to wind gust effects.

SDG&E Response

SDG&E is partnering with the San Diego Supercomputer Center (SDSC) at the University of California San Diego (UCSD) to analyze factors affecting vegetation-related power outages. These factors can be related to tree features such as tree species and tree height, and weather variables such as wind speed and soil moisture. The study focuses on the effects of wind on vegetation-related outages (see Attachment A for full study). The goal of this analysis is to uncover any patterns in the observed nature of wind with relation to risk of power outages caused by vegetation. Since the difference between wind patterns leading to outages and those associated with non-outage conditions is important, SDSC also presented a comparative analysis between outages and non-outages with respect to statistics of wind speeds and wind gusts. An analysis on wind speed/wind gust delta was performed. The main takeaways are as follows:

- Higher deltas between wind speed and wind gust are observed for outages.
- For non-outages, the deltas are uniformly distributed. Additionally, the non-outage distribution has slightly higher peaks for lower delta values, indicating small changes in winds for non-outages.
- A higher delta between wind speed and wind gust therefore indicates a sudden change in wind speed, which can lead to branch or tree failure.
 - Analysis will be performed for HFTD vs. non-HFTD regions
 - Extend analysis to include additional metrics:
 - Span between high winds and outage occurrence
 - Frequency of high winds leading to outage occurrence

SDG&E has begun updating its risk quantification model to include consideration of wind gust for the next WMP cycle. This update will draw from conclusions presented in the joint SDSC/SDG&E analysis, which demonstrated a statistical relationship between wind speed/gust deltas and outages (see Attachment A).

In 2023, SDG&E intends to undergo model development which would use a machine learning algorithm for quantifying the incremental effects of wind gust on vegetation failure likelihood. Prior to the operational deployment of any model considering wind gust effects, results to the SDSC analysis will be benchmarked, as well as other third-party analyses that investigate wind gust effects.

In 2023 SDG&E will complete an iteration of the vegetation probability of failure (PoF) model that considers wind gust effects and will subsequently assess the requirements for operational model deployment.

For further discussion regarding evaluating additional factors in the assessment of wildfire and PSPS risk, such as the effect of wind gusts on the probability of having a vegetation-related failure, see the 2023-2025 WMP Section 6.7.

10 SDGE-22-10 Wildfire Consequence Modeling Improvements

Description

SDG&E does not use its wildfire consequence modeling as a tool to model potential ignitions in near real-time as faults/outages occur in the HFTD.

Required Progress

SDG&E must discuss how it explored the use of its wildfire consequence modeling and/or developed processes to locate, prioritize, and respond to the locations of faults/outages in the HFTD as they happen.

SDG&E Response

Energy Safety requires SDG&E to describe how it explored locations of faults and outages in the HFTD using real-time wildfire consequence modeling. This modeling is not necessary and would likely serve to distract real-time emergency response and resiliency efforts. While SDG&E is continuing to advance and enhance its risk modeling efforts for both likelihood and consequence, there is little benefit to implementing wildfire consequence modeling on the location of faults as they happen in real time. In real time, all outages/faults that occur on the system have a first responder immediately dispatched to investigate. SDG&E has operational processes where Electric Troubleshooters are strategically placed in each district of the service territory to respond to outages. Also, service level agreements are in place for response time if additional resources need to be called out. This real time response, coupled with SDG&E's existing situational awareness tools such as cameras, smoke detection, Fire Potential Index (FPI), and weather stations—in addition to SDG&E's relationships with emergency response teams—allow for rapid and efficient real-time response to risk events. Fault and outage information provide relevant data points to inform modeling efforts and improve situational awareness. All outages and faults are incorporated into the development of Probability of Ignition (PoI) models. The integration of outage and fault data in risk modeling will help better understand the drivers of faults and resulting ignitions, ultimately gaining a deeper understanding of risk events that could lead to ignitions.

See Section 8.1.8.2 in the 2023-2025 WMP for information on grid response procedures and notifications.

11 SDGE-22-11 Applying Joint Lessons Learned Concerning Covered Conductor

Description

SDG&E has not yet provided goals and timelines for implementing lessons learned from the covered conductor effectiveness joint study.

Required Progress

SDG&E must:

Provide a concrete list of goals with planned dates of implementation for any lessons learned in the covered conductor effectiveness joint study. Provide a table indicating which WMP sections include changes (compared to its 2021 and 2022 Updates) as a result of the covered conductor effectiveness joint study. This should include, but not be limited to:

- a. Changes made to covered conductor effectiveness calculations.
- b. Changes made to initiative selection based on effectiveness and benchmarking across alternatives.
- c. Inclusion of rapid earth fault current limiter (REFCL), open phase detection (OPD), early fault detection (EFD), and distribution fault anticipation (DFA) as alternatives, including for PSPS considerations.
- d. Changes made to cost impacts and drivers.
- e. An update on data sharing across utilities on measured effectiveness of covered conductor in-field and pilot results, including collective evaluation.

SDG&E Response

In 2022, SDG&E participated in multiple joint IOU covered conductor effectiveness working groups. Planned dates of implementation for lessons learned in the covered conductor effectiveness joint study are:

- Complete SDG&E destructive testing on covered conductor effectiveness in February 2023
- Receive and review final report from SDG&E's covered conductor testing with Exponent in April 2023
- Analyze all results from SDG&E-led studies and joint IOU studies on covered conductor effectiveness to make adjustments to each risk driver and update the overall effectiveness of covered conductor installation in July 2023
- Analyze all results from SDG&E-led studies and joint IOU studies on covered conductor effectiveness to recommend new PSPS wind speed thresholds for fully covered circuit segments before fully covered segments are constructed (expected Q4 2023)

Full details are provided in the Joint IOU Covered Conductor Working Group Report (Attachment B).

12 SDGE-22-12 Covered Conductor Inspection and Maintenance

Description

SDG&E lacks specific directives for inspection procedures regarding covered conductor inspection and maintenance.

Required Progress

All electrical corporations (not including independent transmission operators) must work to share and determine best practices for inspecting and maintaining covered conductor, including either augmenting existing practices or developing new programs. This should be considered as a continuation of the covered conductor study established by Energy Safety's 2021 WMP Action Statements. The study will continue to be utility-led, with the expectation for Energy Safety to be included as a participant. A report on progress on this continuation of the covered conductor effectiveness joint study will be expected in the 2023 WMPs.

SDG&E Response

Inspections, maintenance, and corrective work for covered conductor is included in all asset inspection programs. SDG&E collaborated with additional electric utilities to understand covered conductor maintenance and inspection best practices. For additional details regarding inspection and maintenance specific to covered conductor, see the Joint IOU Covered Conductor Working Group Report (Attachment B).

13 SDGE-22-13 New Technologies Evaluation and Implementation

Description

SDG&E is not moving forward with its REFCL pilot and does not provide a plan for exploring new technologies that could increase effectiveness against ignition or wildfire risk.

Required Progress

All electrical corporations (not including independent transmission operators) must collaborate to evaluate the effectiveness of new technologies that support grid hardening and situational awareness such as REFCL and DFA/EFD, particularly in combination with other initiatives. Utilities must also share practices and evaluate implementation strategies for these new technologies. This should be considered as a continuation of the covered conductor effectiveness joint study established by Energy Safety's 2021 WMP Action Statements. The scope of this study should now be expanded to cover grid hardening overall. The study will continue to be utility-led, with the expectation for Energy Safety to be included as a participant. A report on progress on this expansion of the covered conductor effectiveness joint study will be expected in the 2023 WMPs.

SDG&E Response

SDG&E continues to explore emerging technologies that can increase effectiveness against ignition and wildfire risks as they become available. SDG&E actively participates in joint IOU meetings to discuss the evaluation of the effectiveness of new technologies when in combination with each other. Full details are provided in the Joint IOU Covered Conductor Working Group Report (Attachment B).

14 SDGE-22-14 Grid Hardening Decision-Making Process Transparency

Description

SDG&E's description of how it selects mitigation initiatives based on risk factors lacks detail, such as how its listed considerations affect initiative selection.

Required Progress

SDG&E must provide:

1. A description of its analysis of how it selects mitigation initiatives based on risk factors evident in certain locations. This should include how SDG&E selects mitigation initiatives to optimize risk reduction for specific ignition risks.
2. Details on how each consideration listed in Figure 7-4 row 3 "Desktop Feasibility" in SDG&E's 2022 Update is weighted, and how each consideration affects SDG&E's initiative selection for grid hardening.

SDG&E Response

The WiNGS-Planning Model makes one of three recommendations to mitigate risk for each circuit-segment with overhead exposure in the HFTD: 1) strategic underground, 2) covered conductor, 3) no mitigation. The primary drivers for selecting a circuit-segment mitigation project are the wildfire risk rank (a direct output from WiNGS-Planning) and the PSPS history and risk of the circuit. The PSPS review considers both upstream and downstream topography, wind speeds, and recommended mitigations to optimize the overall mitigation plan for the circuit.

Additionally, efficiencies that can reduce the resource burden are considered. Limiting projects to geographically proximate locations can optimize survey time (reducing travel times for teams responsible for fielding the fire hardening scope) while limiting mobilization/demobilization for construction crews and optimizing use of existing laydown yards. Lastly, long-term planning is considered to ensure that year-over-year mileage targets are met.

After the circuit-segment mitigation projects have been selected and prioritized, a desktop scoping and feasibility study is performed which includes the following considerations:

Geography

A desktop analysis is performed that includes geospatially accurate information in order to assess optimal routing and terrain considerations for feasibility. For example, strategic underground routing is best achieved along existing roads and often requires a reroute if the existing overhead goes up a mountain or cross country. Additionally, awareness of rivers and streams helps avoid water crossings and provides the ability to identify areas to avoid, such as preserves. Beyond the scoping stage, geotechnical investigation is usually conducted at each job location to identify soil conditions in the area. For example, rocky subsurface, which is common in the back country, is a difficult subsurface for strategic underground construction. A rocky subsurface should be identified early in the design process to minimize design changes.

Prior Hardening

Since 2013, SDG&E has been proactively hardening the system and as a result much of the highest fire risk areas have been targeted for projects. For example, the Electrical System Hardening (ESH), and Cleveland National Forest (CNF) programs replaced wood poles with steel and small copper conductor with higher tensile strength conductor. In order to avoid premature rehardening, unhardening infrastructure is scoped first and rehardening, when necessary, is scoped in later scope batches.

Loading

Distribution Planners are engaged in early scoping stages to incorporate appropriate conductor and cable sizing for anticipated load growth as well as to provide input on cutovers and necessary rerouting.

Standards

SDG&E Construction Standards indicate appropriate situations for each mitigation type. For example, in extra heavy loading districts above 5,000 feet, covered conductor cannot be installed and therefore a strategic underground solution would need to be selected. Standards also dictate available cable and conductor sizes to scope.

Land/Environmental

Land/environmental overlap is assessed early in each project. By knowing the jurisdiction up front, projects can be broken into sections with similar timelines. Sections are reviewed by Environmental Management who assigns each a score based on any environmental constraints that could negatively impact the project schedule. These issues include avoiding cultural resources, water resources, and biological resources by rerouting or going trenchless. At the 60 percent design submittal stage, every project team performs a constructability walk, where experienced strategic underground construction experts walk the entire route with the design and environmental teams and other necessary stakeholders to identify and resolve any potential construction and environmental issues before final design to reduce instances of field change orders.

Operational Improvements

Strategic Undergrounding projects are conducted in the areas of highest wildfire risk, typically in rural areas of the service territory. There are numerous narrow and remote roads and paths on these projects. The design team considers egress and ingress as they progress through the design phase and selects the most appropriate design for the specific location. For example, if egress and ingress is an issue at a construction site, the designer may consider using native backfill instead of slurry fill, working space, traffic coordination, and the type of equipment used to minimize potential traffic issues.

Easement Constraints

Permitting requirements are identified as early as possible to accurately scope and schedule each project. Agencies such as CNF, (Caltrans), and the Bureau of Indian Affairs typically have longer permitting lead times compared to San Diego County permits and those timelines need to be accurately reflected in the project schedule. When working with these agencies, project managers get involved early to define a clear permitting approach and strategy.

Reliability Improvement

Hardening projects provide an opportunity where appropriate to make engineering enhancements, driven by wildfire risk reduction, that also contribute to improved reliability. This may include additional circuit ties or additional sectionalizing.

Construction cost savings

The scoping team seeks to optimize routes, especially in the case of ungrounding, to provide service to customers in the most efficient manner possible. Optimization includes following existing rights of way and avoiding known environmental or permitting challenges.

After the desk top feasibility study, the scope is typically divided into smaller projects based on land jurisdiction and permitting. A finalized scope is then developed for each project and sent out to contractors to bid. The finalized scope is also used to develop schedules for each project.

For further discussion regarding the grid hardening decision-making process, see 2023-2025 WMP Section 7.1.4.2.4.

15 SDGE-22-15 Undergrounding Risk-Spend Efficiency Demonstration

Description

SDG&E plans on ramping up future undergrounding efforts without adequately demonstrating cost-effectiveness based on specific ignition risks.

Required Progress

SDG&E must provide a description of its decision-making process demonstrating risk/cost benefit analysis as it pertains to future undergrounding installations.

SDG&E Response

Strategic undergrounding provides dual benefits of nearly eliminating wildfire risk and the need for PSPS events in the HFTD. However, the cost of undergrounding is approximately \$2.3 million per mile while the cost of converting to covered conductor is \$1.4 million per mile.

Reduction in cost of strategic undergrounding is obtained by gaining efficiencies due to reduced trench depth without compromising safety, reduced conduit size when applicable, implementing new construction technology when needed, strategically bidding, bundling projects, avoiding and coordinating resurfacing conflicts, and streamlining processes, procedures, and policies. SDG&E has also been able to identify areas of cost-efficiencies and overall lifecycle cost reductions. The WiNGS-Planning model selects the more efficient use of funding and resource allocation to focus mitigation deployment on wildfire risk reduction. As described in the Risk Assessment Mitigation Phase (RAMP), Risk Spend Efficiencies (RSEs) are numerical values that attempt to portray changes in risk scores per dollar spent. For more information on RSEs see SDGE RAMP-C Risk Quantification Framework and Risk Spend Efficiency, page C-26, dated May 17,2021.

Table 3 shows the risk event types that strategic undergrounding of electrical lines and installation of covered conductors can impact. Effectiveness of the mitigation can vary based on the risk driver.

Table 3: Impacts of Strategic Undergrounding and Covered Conductor

Impact Area	Undergrounding	Covered Conductor
Animal contact	Yes	Yes
Balloon contact	Yes	Yes
Land vehicle contact	Yes	No
Aircraft vehicle contact	Yes	No
Vegetation contact	Yes	Yes
Anchor/guy	Yes	Yes
Capacitor bank	Yes	Yes
Conductor	Yes	Yes
Connection device	Yes	Yes

Impact Area	Undergrounding	Covered Conductor
Crossarm	Yes	Yes
Fuse	Yes	Yes
Cutout	Yes	Yes
Insulator and bushing	Yes	Yes
Lightning arrester	Yes	Yes
Pole	Yes	Yes
Recloser	Yes	Yes
Switch	Yes	Yes
Transformer	Yes	Yes
Voltage Regulator	Yes	Yes
Wire-to-wire contact	Yes	Yes
Contamination	Yes	Yes
Vandalism/theft	Yes	No
Lightning	Yes	No
Unknown	Yes	Yes
All other	Yes	No

For further discussion regarding the grid hardening decision-making process, see 2023-2025 WMP Section 7.1.4.2.4.

16 SDGE-22-16 Enabling Circuits with Advanced Protection

Description

SDG&E has not been meeting its targets for enabling circuits with advanced protection.

Required Progress

SDG&E must explain how it will meet its current and future targets for enabling circuits with advanced protection and provide a detailed description of that plan in its 2023 WMP.

SDG&E Response

The Advanced Protection Program (APP) encountered significant challenges achieving construction targets in 2022, primarily due to permitting delays related to tribal land easements that prevented construction from commencing as planned. Additionally, pandemic related supply chain, contract, and internal labor challenges slowed the ability to engineer, procure, and construct circuits targeted for this timeframe. As internal coordination has improved, some targeted circuits planned for Falling Conductor Protection (FCP) were descope and included in the Strategic Undergrounding Program.

Circuits delayed in 2022 due to permitting are forecasted to begin construction in 2023 and have been included in 2023 targets. In addition, the number of circuits initiated for design has been increased to provide an adequate backlog of projects which can be substituted if individual project delays are encountered.

For further discussion regarding the APP, see 2023-2025 WMP Section 8.1.2.8.1.

17 SDGE-22-17 Further Development of Integrating Risk-Informed Decision Making for Inspection Scheduling and Planning

Description

While SDG&E has some risk-informed prioritization for cyclical schedules (e.g., every three years) based on Tier 2 and Tier 3 designations, SDG&E has not yet implemented risk modeling-informed prioritization for its inspections.

Required Progress

SDG&E must provide a concrete timeline detailing when SDG&E plans to implement risk modeling-informed prioritization for each of its inspection types.

SDG&E Response

Traditional asset inspection programs adhere to General Order (GO) 165 compliance timeframes and cycles for completing inspections. However, the scheduling of such inspections may consider regional areas such as the HFTD. In some cases, detailed and patrol inspections may be performed earlier in the calendar year in advance of wildfire season. For further discussion regarding asset inspection programs, see the 2023-2025 WMP Section 8.1.3.

In addition to time-based inspections, SDG&E has implemented the risk-informed Drone Investigation, Assessment and Repair (DIAR) Program. In 2022, SDG&E completed drone inspections of all transmission and distribution structures in the HFTD Tier 2 and Tier 3. The DIAR Program has since evolved to scope the 15 percent highest-risk distribution structures in the HFTD and WUI regions. For further discussion regarding the DIAR Program and the risk prioritization model it utilizes, see the 2023-2025 WMP Section 8.1.3.7.

SDG&E is also evaluating the use of risk models to inform distribution intrusive inspections for both wood and steel structures. Although the evaluation is ongoing, it is yet to be determined whether intrusive inspections will be modified based on risk modeling. For further discussion regarding distribution intrusive inspections, see 2023-2025 WMP Section 8.1.3.5.

18 SDGE-22-18 Evaluation and Interpretation of “Other” Equipment Failures

Description

Within Tables 7.1 and 7.2 (2022 Update), many of SDG&E’s equipment failures are grouped in a category defined as “other,” with some causes seemingly falling under other existing categories, or represented as “null.”

Required Progress

SDG&E must provide a plan to reduce “null” causes, which includes:

1. A review of the categories that fall under “other” in order to ensure the categories accurately reflect the causes of equipment failures.
2. A clear justification for why causes are categorized as “other,” including an explanation for why “weather related” causes are listed as such.
3. A breakout of the events that fall under “other.”

SDG&E Response

Previously, SDG&E has explained its methodology for listing risk events as “Other” in response to OEIS-SDGE-2022-004. During 2022, SDG&E worked to review these outages and find where they would best be represented within the risk event metrics within Table 5 of the QDR.³

Additional drivers are provided in Table 5 of the QDR within the distribution wire-down category. This has resolved the issue of many outages being displayed under “Equipment Failure – Other.” One exception is in the scenario where an event initiates as an underground equipment failure and the fault leads to an overhead equipment failure resulting in an overhead wire-down event. Similarly, in the distribution outage category, only when underground outages cause overhead equipment failures or when the damaged device that initiated the event is a circuit breaker or other miscellaneous unlisted equipment are risk events categorized as “Equipment Failure – Other”.

These improvements have resulted in a decrease in the percentage of risk events being reported as “Equipment Failure – Other” for wire-down from 39.6 percent in 2022 to 0.5 percent in 2023 and for distribution unplanned outages from 2.1 percent in 2022 to 0.1 percent in 2023.

³ <https://www.sdge.com/2023-wildfire-mitigation-plan>

19 SDGE-22-19 Plan to Address Missing Asset Data

Description

Less than one percent of SDG&E's data on installation dates for older assets is missing, but SDG&E lacks a proactive plan to address the missing data.

Required Progress

SDG&E must:

1. Provide a plan, including a timeline, to obtain and address the missing installation dates within asset data. This includes developing a plan to determine missing installation dates and fill estimated installation dates into asset databases where possible.
 - a. Include an explanation for instances where installation dates cannot be estimated.
2. Evaluate whether using installation dates would increase predictability within the PoI and evaluate any additional causes for limitations on data quality.

SDG&E Response

SDG&E's Asset 360 platform is a tool that enables development of asset health indices, equipment failure analysis, and predictive risk modeling. Asset 360 is utilized to perform common data science techniques and machine learning technology to address minor data gaps, such as missing asset installation dates for distribution poles and wires. SDG&E has made progress in addressing known data gaps and is confident that installation dates for only 0.14 percent of poles and 0 percent of wires remain unknown. Data gaps are continually identified and prioritized, and remediation benefits are continually evaluated. Efforts to close gaps where critical data is used in modeling will be prioritized. For further discussion regarding Asset 360, see the 2023-2025 WMP Section 8.1.5.4.

SDG&E creates statistical and machine learning in its PoI modeling effort. At the time of modeling, multiple variables are evaluated, and new features are created to increase model predictability and understanding. It is at the modeler's discretion if any independent variable should be included. For example, if an installation date is found to be statistically significant and the interpretability of the coefficient is in alignment with business interpretation, then the installation date is included in the model. Models are reviewed on an annual basis, as new observations are collected throughout the year. For further discussion regarding PoI, see the 2023-2025 WMP Section 6.2.2.1.

20 SDGE-22-20 Progression of Effectiveness of Enhanced Clearances Joint Study

Description

The 2021 Action Statements required the large IOUs to conduct a study assessing the effectiveness of enhanced clearances. Progress has been made in the study; however, the study must continue to progress.

Required Progress

SDG&E, along with PG&E and SCE, must (1) standardize the data collection process for the cross-utility database of tree-caused risk events, (2) determine where and in what form the database will exist, (3) examine, to the best of their ability, whether the correlation between enhanced clearances and the lower number of tree-caused outage events may be attributable to other factors beyond clearances, such as the management of hazard trees and the installation of covered conductor.

SDG&E Response

SDG&E has collaborated with Energy Safety and the other large California IOUs to continue to progress in the study assessing the effectiveness of enhanced clearances. Full details of the progress made are included in the Enhanced Clearance Joint Response in Attachment C.

21 SDGE-22-21 Consideration of Alternatives to Fuels Treatment Activity

Description

SDG&E's practice of removing dead or dying fine fuels within a 50-foot radius of selected poles is not a long-term solution to this particular wildfire mitigation challenge.

Required Progress

1. SDG&E must present an analysis of alternatives to its fuels treatment activity including consideration of, but not limited to, undergrounding, REFCL, and pole replacement (e.g., with steel). SDG&E must provide a discussion of its progress in quantifying the additional risk reduction in its 2023 WMP.
2. SDG&E must quantify the additional risk reduction achieved by removing dead or dying fine fuels within a 50-foot radius as compared to the Public Resources Code Section 4292 standard.

SDG&E Response

SDG&E sponsored a third-party study of its Fuels Treatment activities in 2022 to review the efficacy of the program and potential risk reduction (see the WMS Work Summary in Attachment D). The low frequency of utility ignitions in the service territory provides relative limited data with which to provide definitive analysis of the effect of this program. However, some of the key findings of the study included:

- Distance study: Clearance radius of 50 feet will capture majority of ignitions.
- Outage Study: Ignitions associated with outage statistically likely to be closer to the pole than ignitions w/o outage
- Voltage Study: 12 kilovolt sample focus for accurate distance metrics. Determined influence voltage has on ignition profiles.
- Post 2020 Study: utilized greater fire size precision to identify statistically significant relationships in the data.
- Quantified statistical significance in the finding that HFTD fires are more likely to be larger compared to non-HFTD fires.
- Developed geospatial model to be used with linear regression analysis techniques to identify whether pole clearance activities are influencing fire size and rates of ignition/heat events in HFTD areas.

SDG&E will continue to consider alternatives to its current fuels treatment program, however, SDG&E believes this is a prudent mitigation activity to further reduce the risk of ignitions. Additionally, analysis and feedback is received from the primary vendor who project manages the initiative for feedback on process improvement, safety, work scope, planning/scheduling, customer engagement, environmental impact, and customer engagement.

22 SDGE-22-22 Participation in Vegetation Management Best Management Practices Scoping Meeting

Description

Vegetation management processes and protocols for the reduction of wildfire risk are not uniform across electrical corporations.

Required Progress

SDG&E and all other electrical corporations (not including independent transmission operators) must participate in an Energy Safety-led scoping meeting to discuss how utilities can best learn from each other and future topics to explore regarding vegetation management best management practices for wildfire risk reduction. They must also participate in any follow-on activities to this meeting. This vegetation management best management practices scoping meeting may result in additional meetings or workshops or the formation of a working group. Energy Safety will provide additional details on the specifics of this scoping meeting in due course.

SDG&E Response:

Energy Safety expressed the need and is planning to hold initial and ongoing meetings with joint IOUs and industry experts to identify vegetation best management practices for wildfire risk reduction. SDG&E will participate in future Energy-led scoping meetings, currently scheduled for February 10, and has recommended and provided contact names of industry experts who may assist in this initiative.

23 SDGE-22-23 PSPS Wind Threshold Change Evaluations

Description

SDG&E has not yet evaluated PSPS threshold changes as a result of installing covered conductor.

Required Progress

SDG&E must:

1. Coordinate with other utilities to understand the impacts of installing covered conductor and associated changes that could be made to PSPS thresholds as a result.
2. Provide a summary of key findings, including any changes implemented to SDG&E's PSPS procedures or practices.
3. Provide any studies completed by third-parties on wind speed thresholds for covered conductor, or, if not yet completed, a timeline for completion.
4. Provide a description and associated justification of any modifications to PSPS wind speed thresholds since the 2022 Update.

SDG&E Response

SDG&E is working with other IOUs to understand the impacts of installing covered conductor and any changes to the risk of PSPS events. When complete, this analysis will include a summary of key findings. Initial analysis shows that covered conductor has the ability to raise wind speed thresholds for fully covered segments. Based on these initial results and collaboration with other utilities, SDG&E expects this wind speed threshold will be approximately 55 to 60 miles per hour. SDG&E is awaiting the final Exponent report to be completed in April 2023 prior to re-evaluating the effectiveness of its Covered Conductor Program. New effectiveness calculations will be coordinated with the review of new PSPS thresholds which are expected to be finalized by Q4 2023.

Full details are provided in the Joint IOU Covered Conductor Working Group Report (Attachment B).

24 SDGE-22-24 Replacing Protective Devices for Sensitivity Setting Capabilities

Description

SDG&E does not have a plan to proactively replace old field devices to include protective device sensitivity setting capabilities.

Required Progress

SDG&E must evaluate whether it should replace field devices with sensitivity setting capabilities. SDG&E must include in this evaluation a survey of existing coverage and determination of which areas could benefit from replacements. The evaluation should assess the extent to which replacements for increased sensitivity settings would reduce ignition risk. If SDG&E determines that field device replacement would decrease ignition risk, SDG&E must create and implement a plan to do so. If SDG&E determines that replacement of field devices would not effectively decrease ignition risk, SDG&E must explain why it would not.

SDG&E Response

SDG&E evaluated whether it should replace old field devices with sensitivity setting capabilities and has determined that there is enough coverage with existing devices to implement sensitive setting capabilities. There are currently has 450 devices capable of sensitive relay profiles (SRP) across 225 unique circuits. There are 157 circuits with at least 1 mile of overhead distribution within the HFTD, where the risk of ignition leading to wildfire is greatest. These 157 circuits are protected with devices capable of SRP.

SDG&E has implemented its SRP and sensitive ground fault (SGF) protection settings for over a decade. SRP and SGF are implemented for all device deployments where sensitive settings are a standard. This also includes previously-implemented lifecycle replacements of older technologies which did not previously have sensitive settings capabilities. SDG&E will continue to review its system for the application of new technology and the need to update existing technology, but at this time feels that the deployment of protective devices with SRP capability is adequate in reducing the risk of wildfire. See section 8.1.2.8 for more information on SRP and SGF initiatives.

25 SDGE-22-25 Validation of Vegetation Risk Index (VRI)

Description

SDG&E states that it does not conduct any standard verification or validation on the Vegetation Risk Index (VRI) because “this is not a predictive model but rather a qualitative index.” Regardless of the nature of the index, if it is being used to drive decisions about PSPS as claimed, there should be evidence that there is in fact some relationship between the output and results (in this case, that the ratings of low/medium/high are correlated with increasing rates of vegetation-related outages).

Required Progress

SDG&E must:

1. Evaluate the VRI output and report on the results of that effort.
2. Evaluate post-PSPS event data and compare to the VRI model to check for validity of output.
3. Adjust the model as needed based on lessons learned or provide a timeline and plan for associated adjustments.

SDG&E Response

The Vegetation Risk Index (VRI) is a situational awareness tool that categorizes circuits and transmission lines based on tree species, tree height, tree count, and historical vegetation-related outages. This tool is reviewed annually and updated, if necessary, as weather stations are added. The VRI does not have any predictive outputs, therefore there are no “results” to be measured or validated.

The VRI was constructed in order to find potential predictors that may be used to anticipate a period of vegetation-related outages. A third-party analysis of tree inventory data and vegetation-related outage data found that the highest number of outages occurred with heavy rainfall, saturated soils, and wind speeds/gusts at about the 95th percentile for an area. Due to a lack of data, the analysis did not specifically look at vegetation-related outages during Santa Ana wind events, which is when PSPS events occur. For that reason, a comparison of the VRI and a PSPS event could not yield meaningful outcomes.

In 2023 SDG&E is seeking to supplant the VRI with a predictive component of the WiNGS-Ops model to assess the likelihood of vegetation-related failures. The process will align in scope and timeline with the efforts detailed in SDGE-22-09 (Required Progress 3 and 4).

For further discussion regarding evaluating additional factors in the assessment of wildfire and PSPS risk, such as the effect of wind gusts on the probability of having a vegetation-related failure, see the 2023-2025 WMP Section 6.7.

26 SDGE-22-26 Validation of Wildfire Risk Reduction Model (WRRM)

Description

SDG&E describes the validation of its WRRM as consisting only of visual verification by comparison using GIS software to determine that the results of the model “coincide with known conditions around the service territory.” As described in its 2022 Update Section 4.5.1.3, the WRRM incorporates 10 separate data elements, many of which could be validated in a more robust fashion to determine sources and magnitude of uncertainty in the model.

Required Progress

SDG&E must determine which inputs to its WRRM can be more rigorously validated, conduct such validation, or provide a plan including a timeline to conduct such validation, and report on the results of that effort.

SDG&E Response

The WRRM model is delivered annually prior to fire season and undergoes a comparison with the previous year’s submission. This involves the examination of column header changes, measurement changes, quantile changes, and general format changes. Error detection is currently automated within the WiNGS-Planning 3.0 development version model, which will be released in 2023. This error detection tracks changes to output columns including every quantile for acres, buildings, population, fire behavior index, flame length, rate of spread, and buildings destroyed upon every model run. Thus, if an unwanted change in one of the columns in the WRRM output were to occur, it would be caught via this detection method and further examined by staff data scientists.

For further discussion on the WRRM model please see the 2023-2025 WMP Section 6.2.

27 SDGE-22-27 Improvements to Capital Allocation Methodology

Description

SDG&E's progress on the Maturity Survey for capability 41 under the Resource Allocation Methodology Section H.V "Portfolio-wide initiative allocation methodology" is limited by question H.V. that asks "to what extent does the utility allocate capital to initiatives based on [RSE]?" Based on SDG&E's response to this question, the utility anticipates no progress on this question in 2022.

Required Progress

SDG&E must provide a timeline with attainable benchmarks for using accurate RSE estimates to determine capital allocation at a portfolio level.

SDG&E Response

SDG&E does not use RSE as the sole decision making for capital decision making, but rather a contributing factor or input, and to ensure activities are performed that are reducing wildfire risk. The WiNGS-Planning model is used to allocate the largest capital funds between Strategic Undergrounding and Covered Conductor Programs. Allocation of capital across portfolios based on RSEs is not currently being pursued for implementation, but the work on Copperleaf is intended to support a broader capital portfolio review. In addition, the RSE methodology outlined in the 2018 Safety Model and Assessment Proceeding (S-MAP) Settlement Agreement CPUC Decision (D.) 18-12-014, will be required to transition to a new Risk-Based Decision-Making Framework (RDF) for the 2025 RAMP submission.

For further discussion on capital allocation methodology see Section 7.1.4.

28 SDGE-22-28 Improvements to the RSE Verification Process

Description

SDG&E does not currently, nor does it plan to, verify its RSE estimates with independent experts or other utilities in California.

Required Progress

SDG&E must provide a timeline with attainable benchmarks to verify its RSE estimates with independent experts or other utilities in California.

SDG&E Response

A third party has been hired to perform an independent review of the RSE methodology, data governance, and completeness. This independent review includes a comparison analysis of the 2022 and 2023 RSEs.

As a result of this independent review, SDG&E has developed an internal system to capture changes in RSE methodology and data input validation and has simplified some calculation steps to ease validation processes. In addition, the documentation of data sources has been improved.

The third party was provided with six iterations of WMP workpapers as the improvements were implemented in late December 2022 through early February 2023.

The third party evaluated the four attributes of a Data Quality Check (completeness, traceability, accuracy, and consistency) for 36 WMP programs and found a few outstanding issues related to units and costs, which were resolved. The traceability attribute, which is dependent on source and responsible party, was updated across all WMP programs.

The Methodology Check considered three attributes (process design, process qualification, and continuous process verification) for the 36 WMP programs. In the six iterations, inputs from 2023 were compared with the methodology from the 2022 WMP to understand the process changes. Over 58 issues have been identified that were resolved in an iterative process, with one outstanding issue that is still under review.

29 SDGE-22-29 Mitigation Plan for Frequently De-Energized Circuits

Description

SDG&E does not go far enough in its plans to reduce the future risk of PSPS on its most frequently de-energized circuits, identified in Table 8.6-1 (2022 Update).

Required Progress

SDG&E must demonstrate that it is planning to achieve a greater level of PSPS risk reduction on the frequently de-energized circuits identified in Table 8.6-1. This must include a greater percentage of risk reduction, a higher percentage of customers who will no longer be de-energized, and a greater percentage of circuit miles mitigated.

SDG&E Response

SDG&E's primary grid hardening initiatives, including the Strategic Undergrounding Program, PSPS Sectionalizing, and the backup resiliency programs (Standby Power Program, Generator Grant Program, and Generator Assistance Program), intend to reduce the future risk of PSPS on the most frequently de-energized circuits.

With the cost of undergrounding electric lines decreasing significantly over the last few years and the evolution of risk modeling to incorporate PSPS impacts, mitigation recommendations have put increased emphasis on the strategic undergrounding of electric lines. This shift was intentional in SDG&E's efforts to reduce the impacts of PSPS, especially to those customers who have been frequently impacted.

For further discussion regarding the PSPS risk reduction to customers on the most frequently de-energized circuits, see 2023-2025 WMP Section 9.1.2.

30 SDGE-22-30 Improvements to the WiNGS-Ops and WiNGS-Planning Models

Description

SDG&E indicates it is planning enhancements to its WiNGS-Ops model in 2022. Additionally, SDG&E indicates that the WiNGS-Planning model does not include customers impacted by sectionalizing and resiliency programs.

Required Progress

SDG&E must provide a progress report on the performance of WiNGS-Ops as used in its 2022 PSPS decision-making process, including successes, issues encountered, and lessons learned.

1. In particular, SDG&E must include in its report the progress it made prior to September 1, 2022, in incorporating WiNGS-Ops in the PSPS decision-making process.
2. SDG&E must also report any progress it made on incorporating PSPS risk reduction quantification to include customers impacted by sectionalizing and resiliency programs through the WiNGS-Planning model.

SDG&E Response

Progress was made prior to September 1, 2022 towards incorporating the WiNGS-Ops model in the PSPS decision-making process. Progress included:

- Enhanced PSPS risk model at transformer level to better estimate the impact of PSPS events on customers
- Expanded PSPS Risk model to include vulnerable customers
- Performed an internal study to validate subject matter expert conservative assumption of the number of fatalities during PSPS events
- Retrained existing statistical and machine learning models with new observations (observations collected during 2021)
- Presented model assumptions to subject matter experts and SDG&E Leadership to collect feedback and achieve model acceptance.
- Migrated models to AWS cloud environment to improve version control, data traceability, and reproducibility
- Developed an internal visualization tool for WiNGS-Ops to allow easy navigation between electric assets and risk models.

Recent improvements to PSPS quantification include the following:

- PSPS risk reduction is currently in development and tracks PSPS risk mitigated via covered conductor and undergrounding projects per year or multiple years
- PSPS Probability within PSPS Risk Score quantification is now dynamically updated per hardening state assessment
- PSPS risk reduction quantification has been automated in Python

- PSPS probability criteria has been updated to expand the wind climatology and more accurately reflect the wind potential present during PSPS events. This involves limiting the scope to the highest fire season, from Sept. 1 through Dec. 30, with the additional inclusion of any Red Flag Warning (RFW) days that occur in spring.
- PSPS customers including Medical baseline, Urgent, Essential, Sensitive, Life support are quantified in in the WiNGS Planning model includes Medical baseline, Urgent, Essential, Sensitive, and Life support customers in its PSPS Consequence module. AFN customers are expected to be incorporated within the current WMP cycle.

For more information on PSPS Likelihood see the 2023-2025 WMP Section 6.2.2 and details of the progress of improvements on WiNGS-Ops and WiNGS-Planning models in Attachment E.

Attachment A: Analysis of Wind Effects on Vegetation-Related Outages

Analysis of Wind Effects on Vegetation-Related Outages

Rahul Patil, Tolga Caglar, Mai H. Nguyen

2023-01-13



Wind analysis

- Wind data:
 - Historical WRF data (historical-ens_gfs_003)
 - Hourly wind values
 - 2km x 2km spatial grids
- WRF hourly weather values are aggregated into 24-hour buckets
 - Values from 24 hours *leading to* outage timestamp are used
- Wind statistics are collected for outage and non-outage samples, and compared to identify patterns leading to outages

Outage & Non-Outage

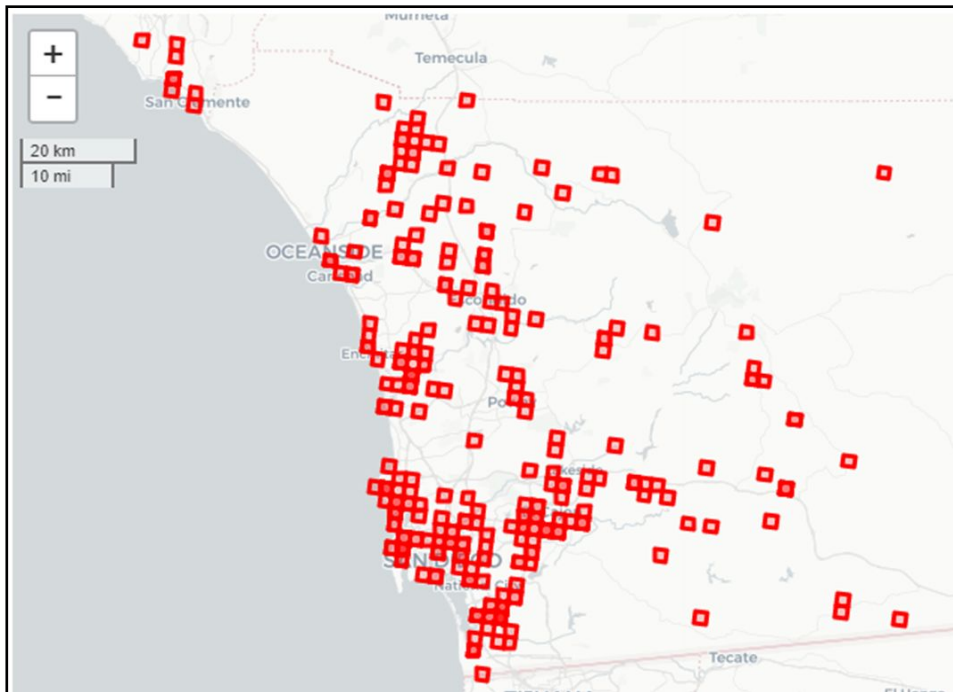

Fig 1: 2x2 km grids where outages were recorded from Jan 2011 to June 2020

- Using 2km x 2km WRF grids, red grids show locations of vegetation-related outages recorded Jan 2011 to June 2020
- Vegetation-related outages: 322, 324, 326, 420, 426, 428, 430 (318 excluded)
- Non-outages:
 - same grid as outage
 - same time/day/month
 - different year
- Statistics
 - number of grids = 198
 - outage count = 298
 - non-outage count = 2,578

Overall Analysis

Wind Speed Distribution for Outage vs Non-Outage

Wind speed max %ile in 24h bucket before (non)outage compared to all other 24h buckets

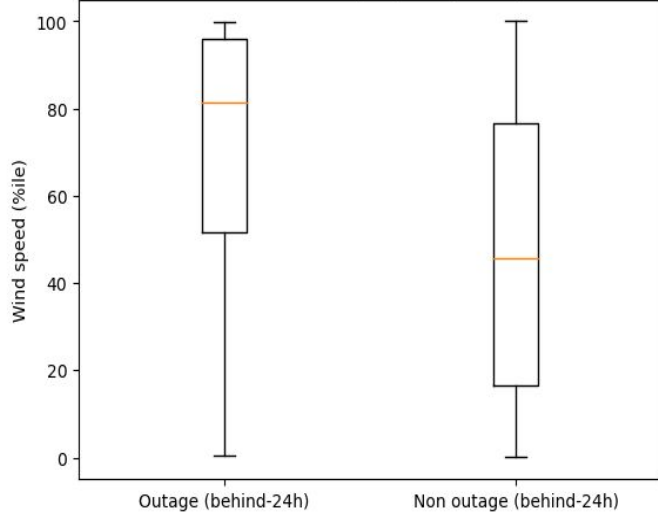

Wind speed mean %ile in 24h bucket before (non)outage compared to all other 24h buckets

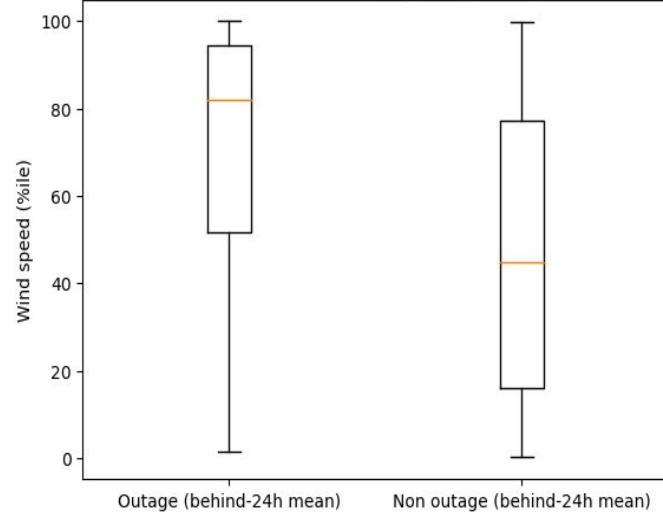

Outage v/s Non-Outage wind speed max %ile - 24h buckets all time

Outage v/s non-outage wind speed max %ile - 24h buckets all time

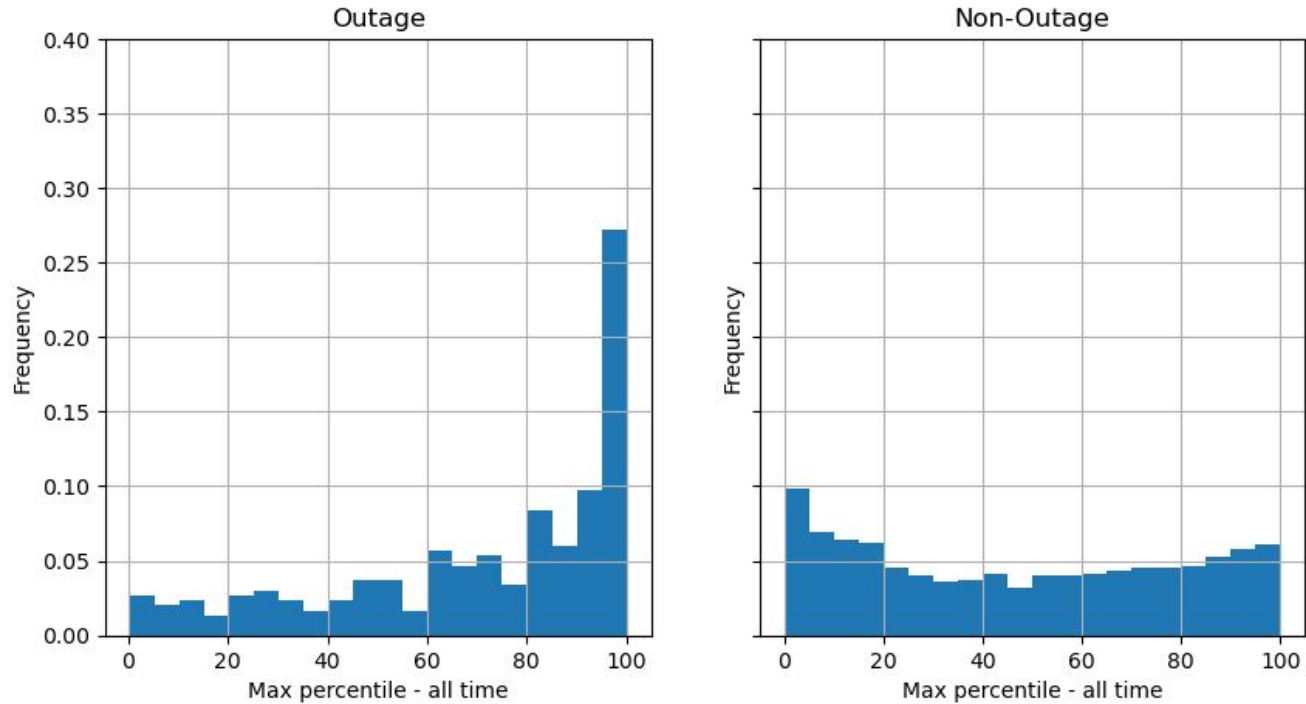

Outage v/s Non-Outage wind speed mean %ile - 24h buckets all time

Outage v/s non-outage wind speed mean %ile - 24h buckets all time

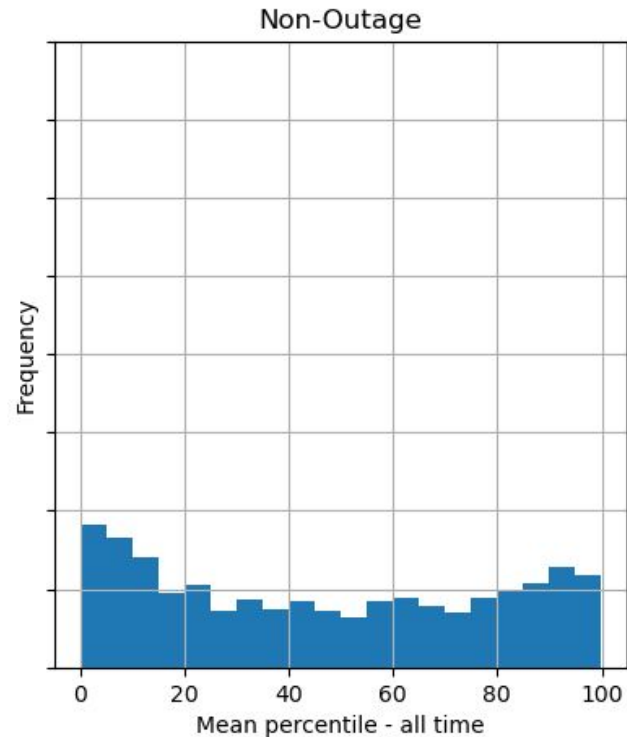
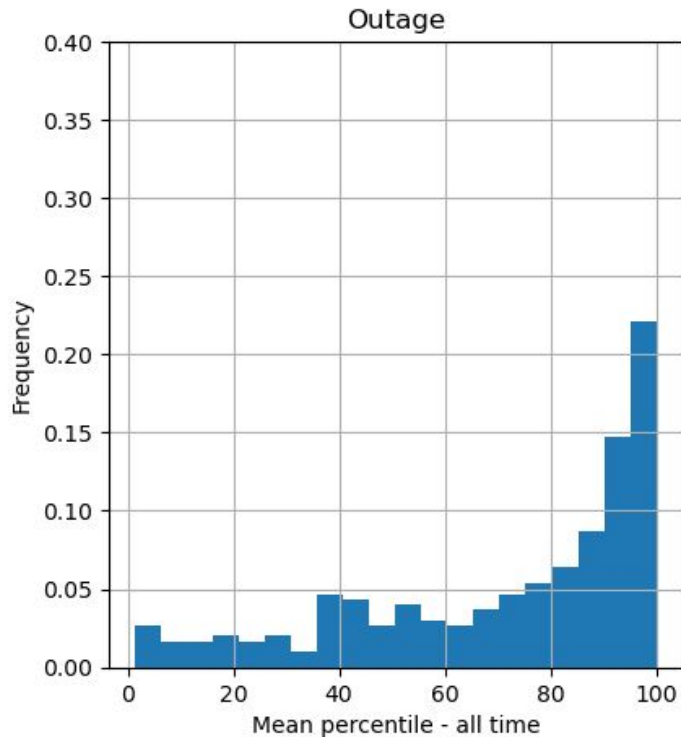

Outage v/s Non-Outage wind gust max %ile - 24h buckets all time

Outage v/s non-outage wind gust max %ile - 24h buckets all time

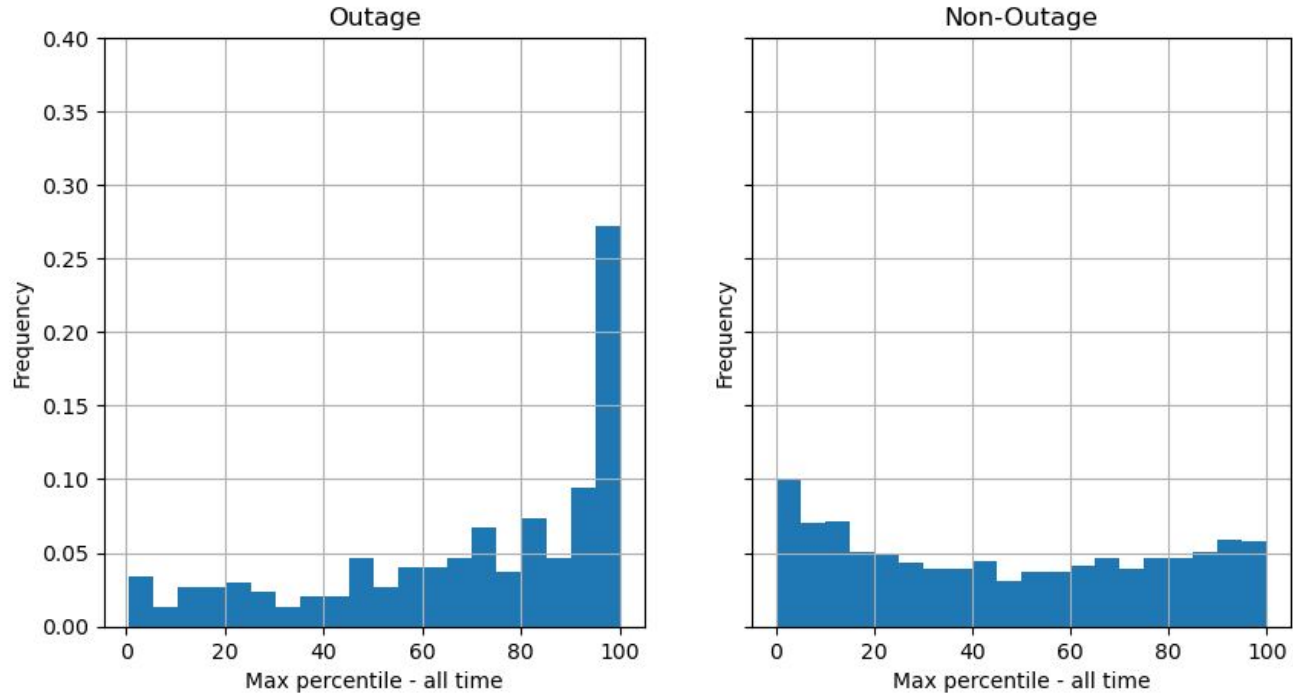

Outage v/s Non-Outage wind gust mean %ile - 24h buckets all time

Outage v/s non-outage wind gust mean %ile - 24h buckets all time

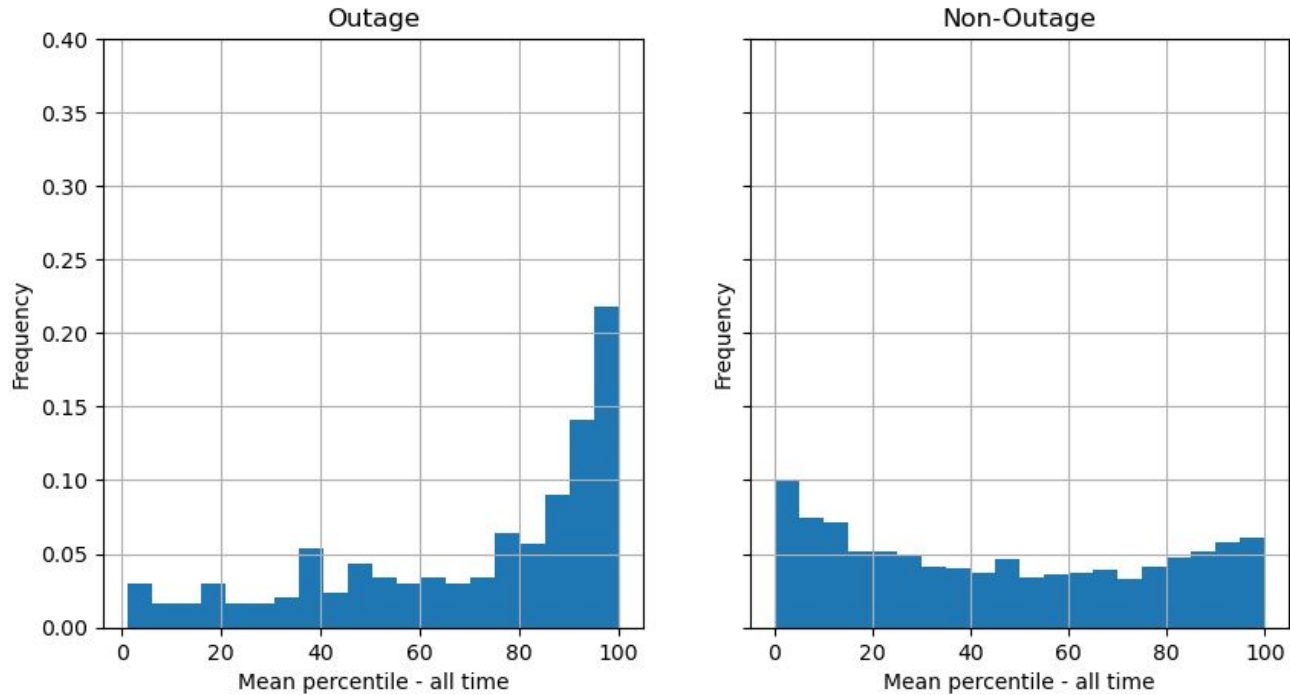

Seasonal Analysis

Number of outages and seasons

- **Summer** (June, July, Aug) - outages: 40, non_outages: 331
- **Winter** (Dec, Jan, Feb) - outages: 144, non_outages: 1268
- **Spring** (Mar, Apr, May) - outages: 68, non_outages: 611
- **Autumn** (Sept, Oct, Nov) - outages: 46, non_outages: 368

Outage v/s Non-Outage wind speed max %ile - (ALL SEASONS)

Outage v/s non-outage wind speed max %ile - (ALL SEASONS)

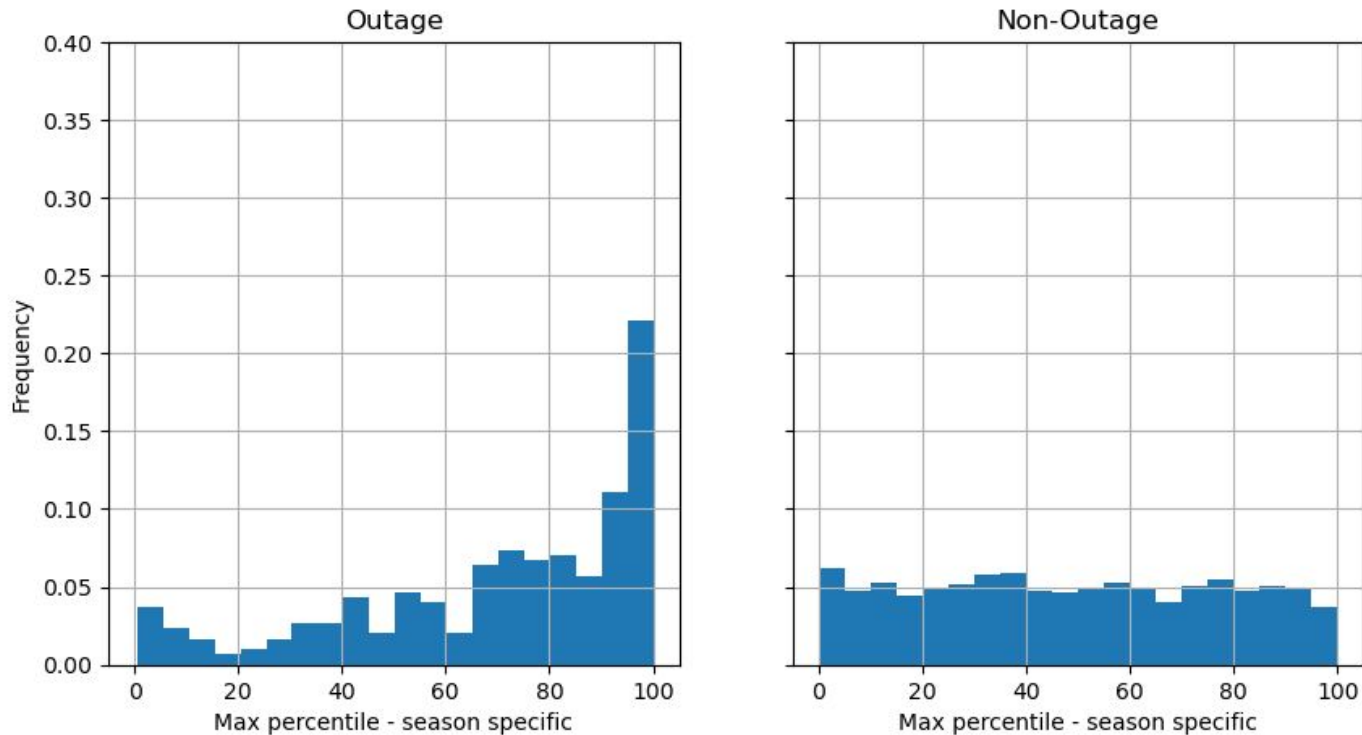

Outage v/s non-outage wind speed max %ile - summer

Outage

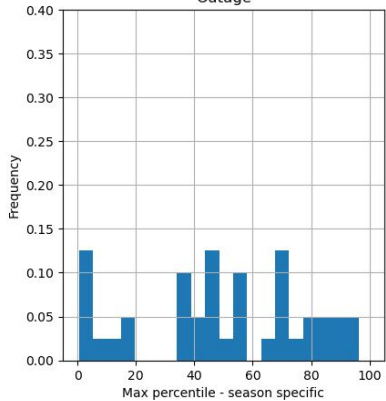

Non-Outage

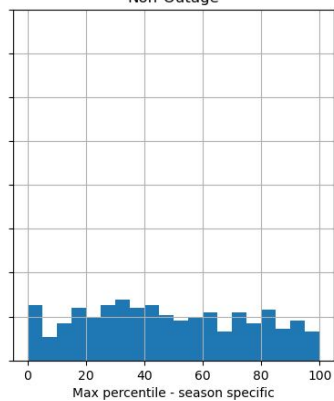

Outage v/s non-outage wind speed max %ile - winter

Outage

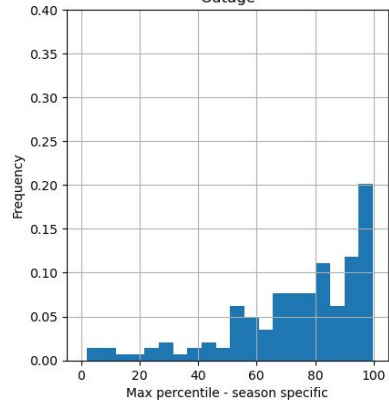

Non-Outage

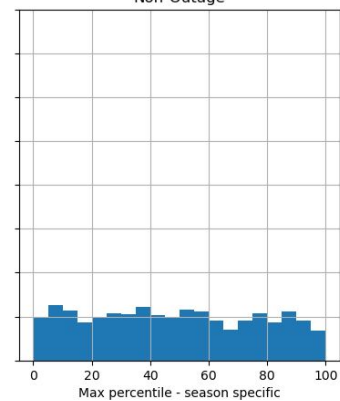

Outage v/s non-outage wind speed max %ile - spring

Outage

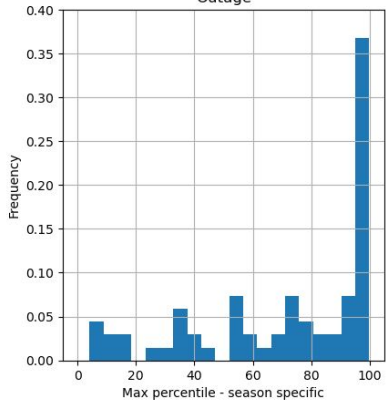

Non-Outage

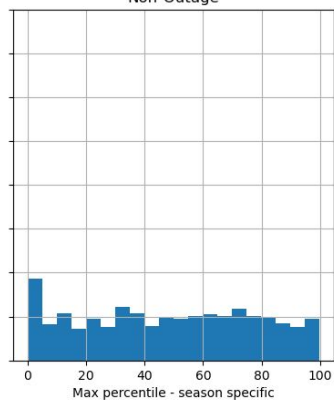

Outage v/s non-outage wind speed max %ile - autumn

Outage

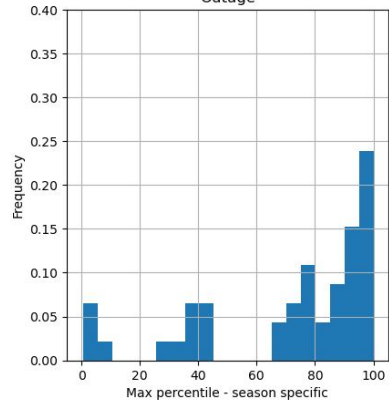

Non-Outage

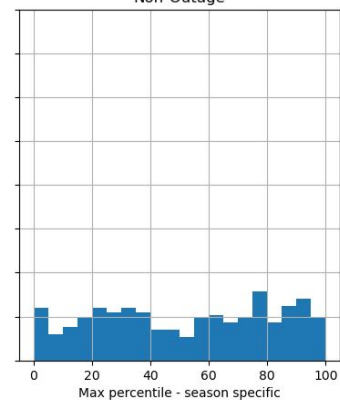

Outage wind gust max %ile - (ALL SEASONS)

Outage v/s non-outage wind gust max %ile - (ALL SEASONS)

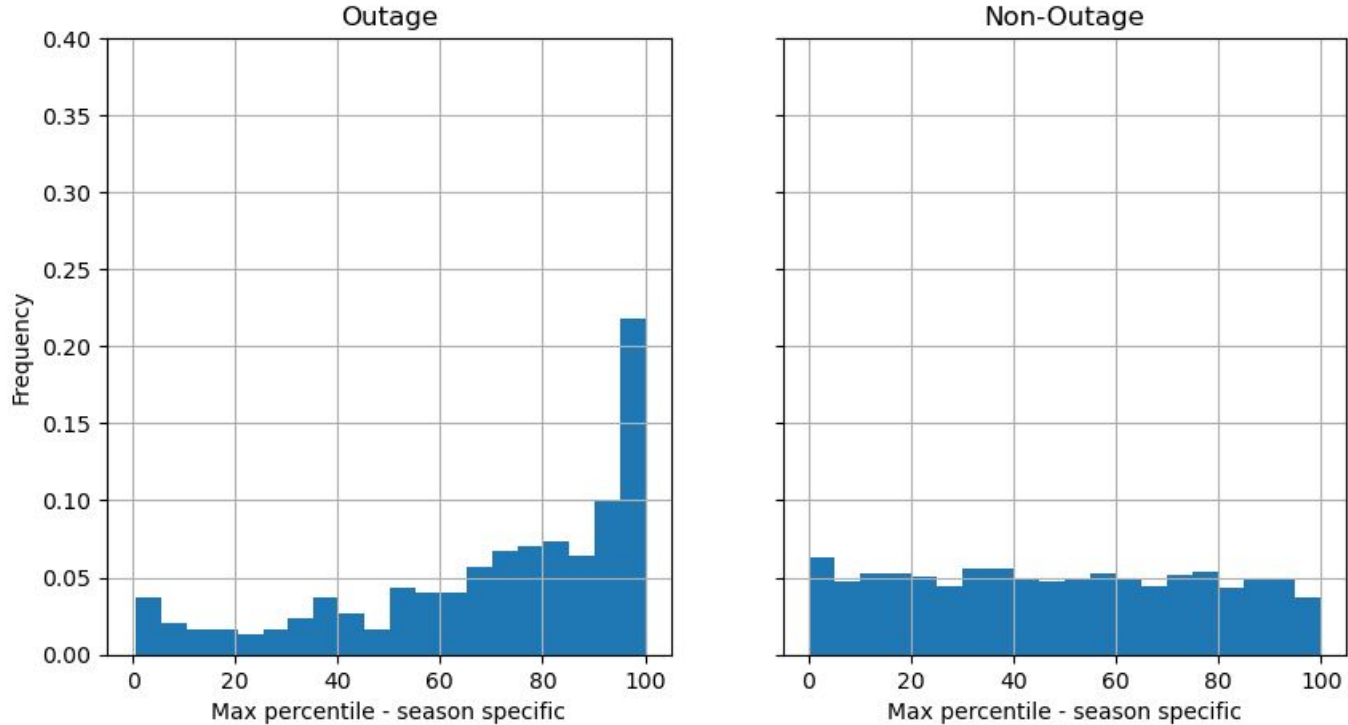

Outage v/s non-outage wind gust max %ile - summer

Outage

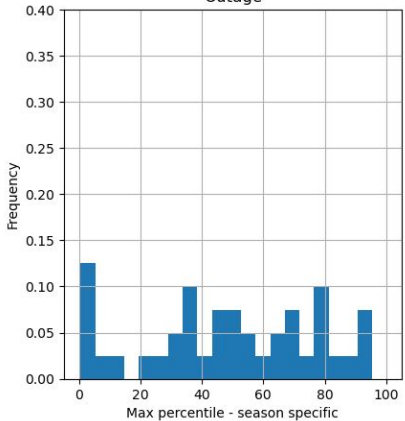

Non-Outage

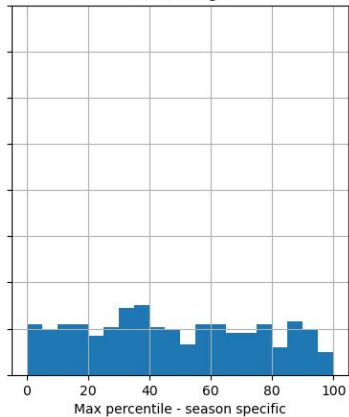

Outage v/s non-outage wind gust max %ile - winter

Outage

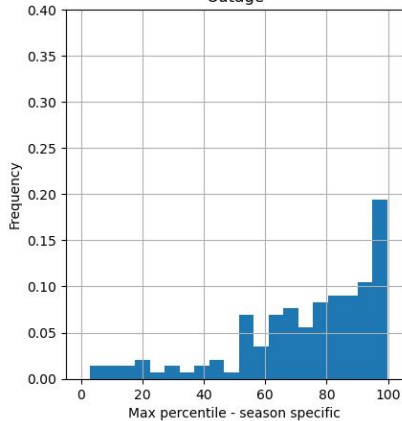

Non-Outage

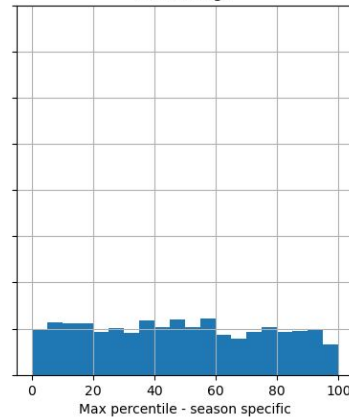

Outage v/s non-outage wind gust max %ile - spring

Outage

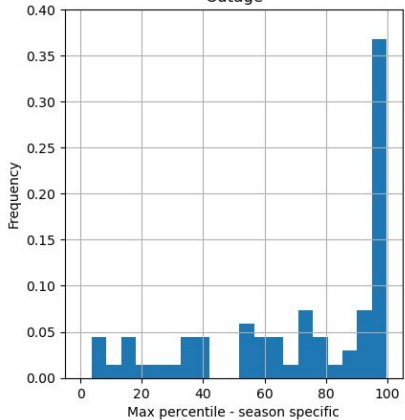

Non-Outage

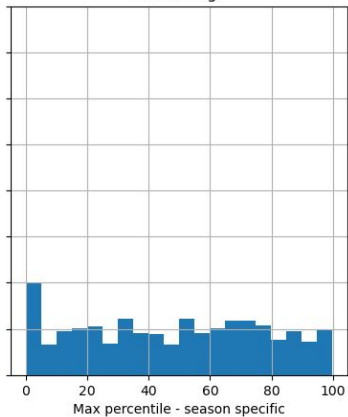

Outage v/s non-outage wind gust max %ile - autumn

Outage

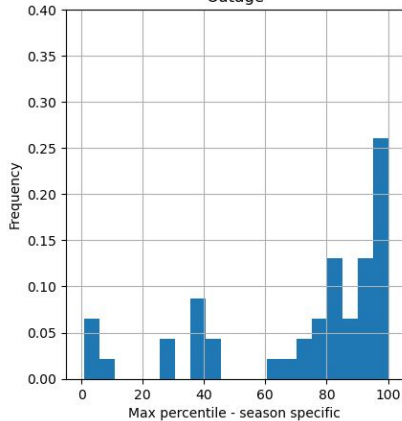

Non-Outage

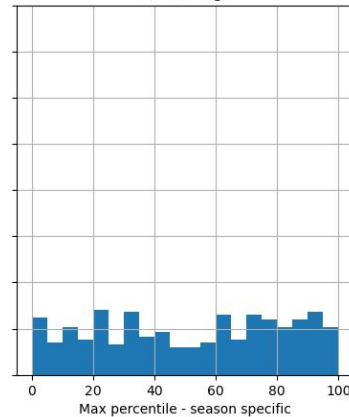

Outage v/s Non-Outage wind speed mean %ile - (ALL SEASONS)

Outage v/s non-outage wind speed mean %ile - (ALL SEASONS)

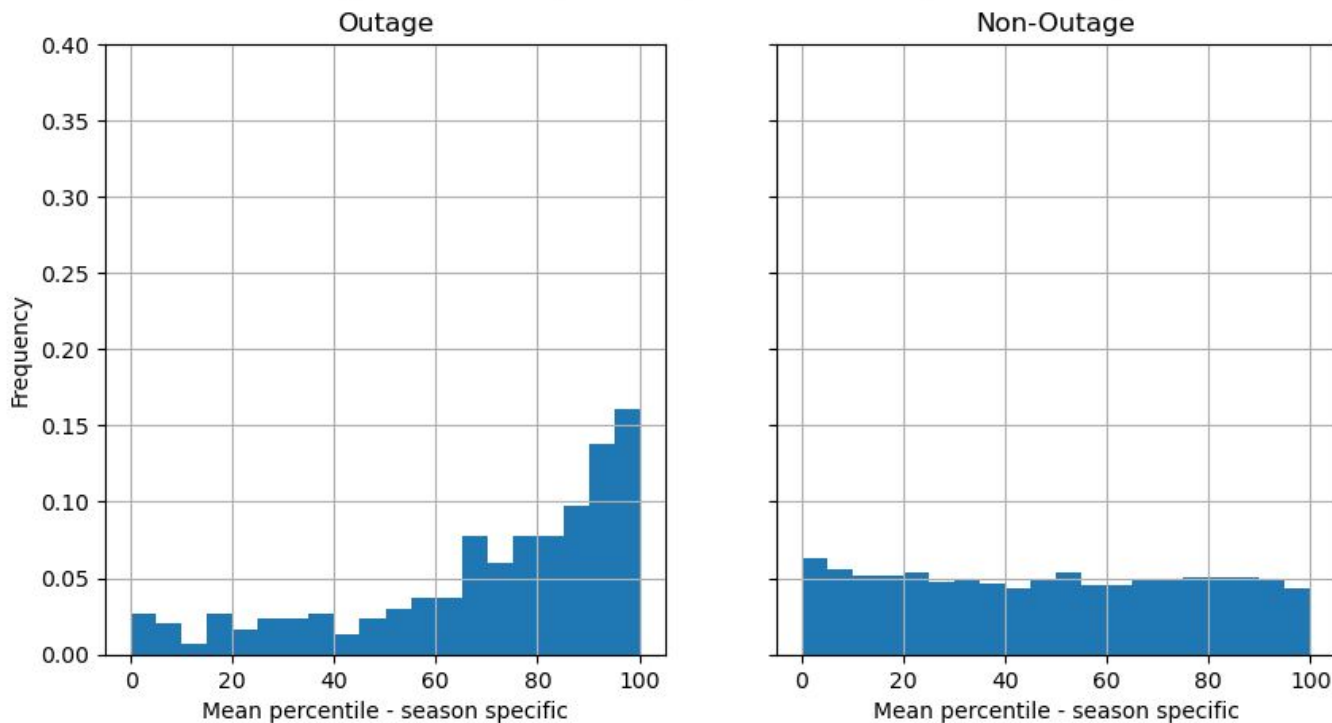

Outage v/s non-outage wind speed mean %ile - summer

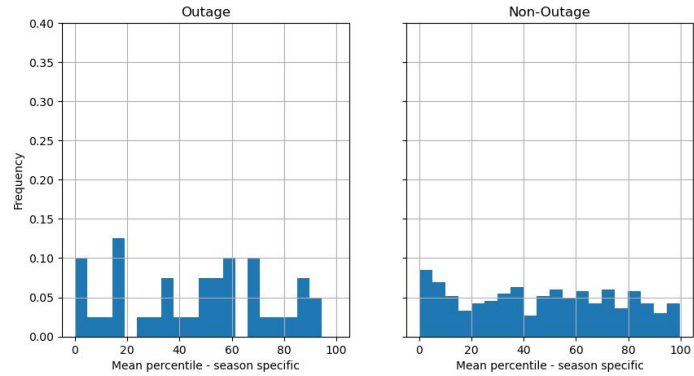

Outage v/s non-outage wind speed mean %ile - winter

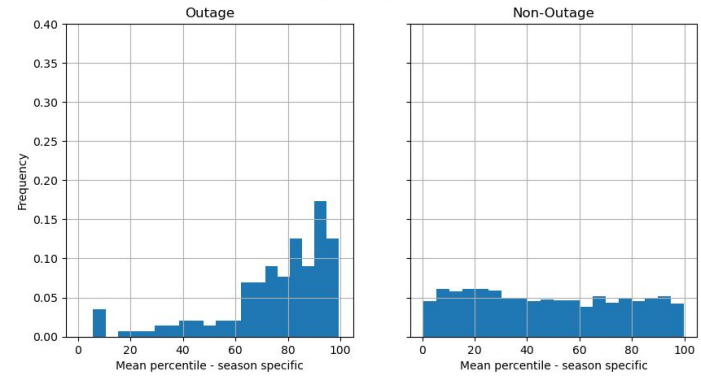

Outage v/s non-outage wind speed mean %ile - spring

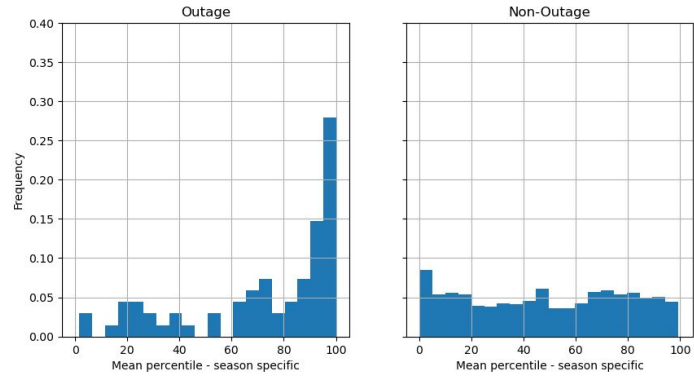

Outage v/s non-outage wind speed mean %ile - autumn

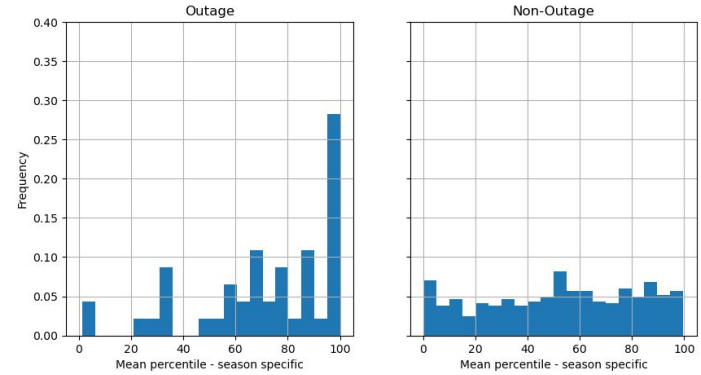

Outage v/s Non-Outage wind gust mean %ile - (ALL SEASONS)

Outage v/s non-outage wind speed mean %ile - (ALL SEASONS)

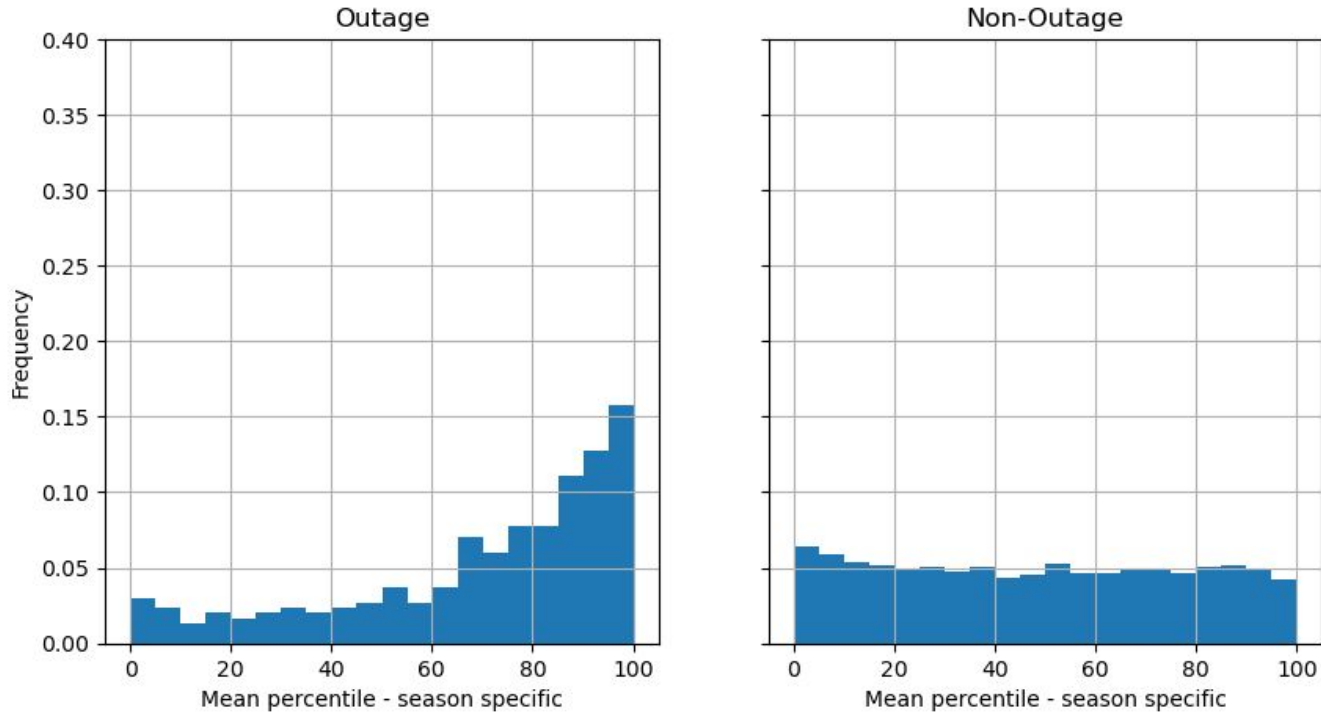

Outage v/s non-outage wind gust mean %ile - summer

Outage

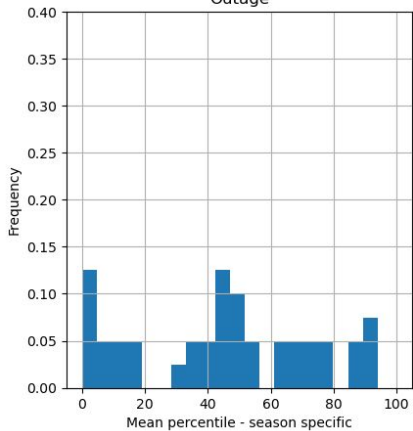

Non-Outage

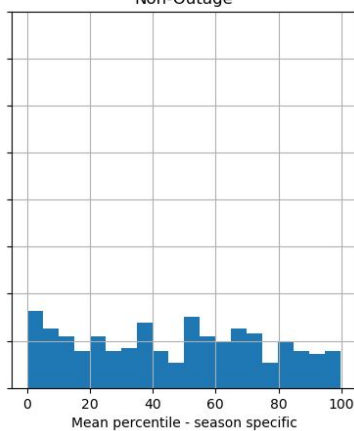

Outage v/s non-outage wind gust mean %ile - winter

Outage

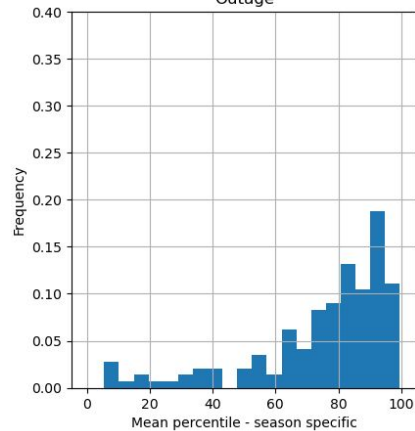

Non-Outage

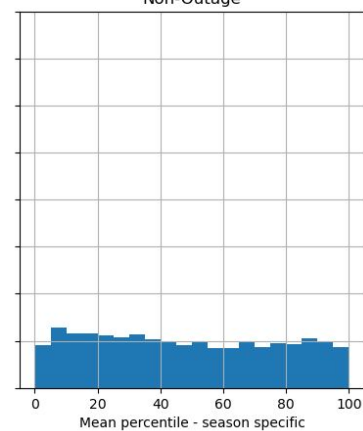

Outage v/s non-outage wind gust mean %ile - spring

Outage

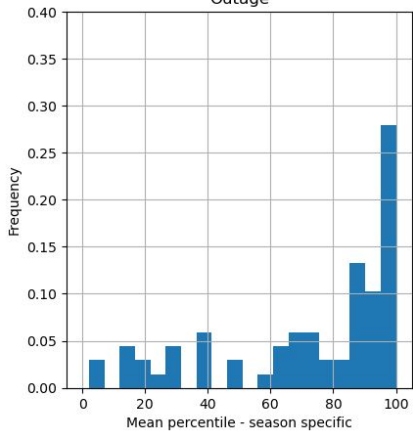

Non-Outage

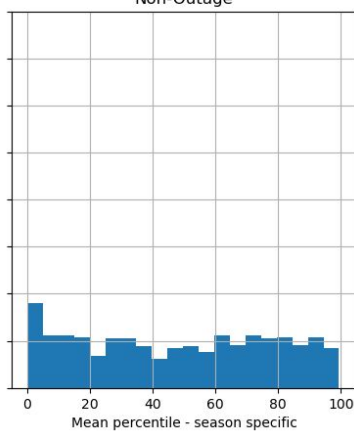

Outage v/s non-outage wind gust mean %ile - autumn

Outage

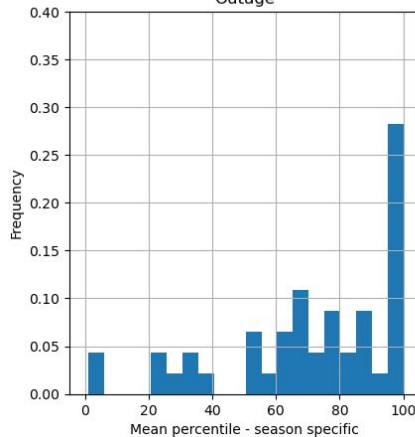

Non-Outage

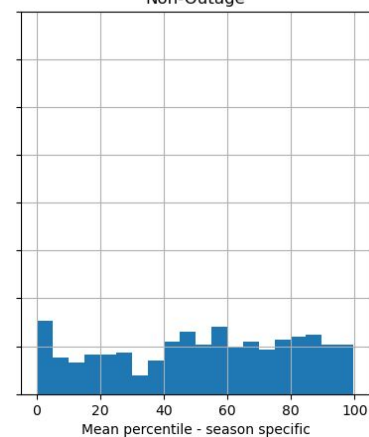

Monthly Analysis

Number of outages per month

- **January** - outages: 76, non_outages: 684
- **February** - outages: 43, non_outages: 384
- **March** - outages: 27, non_outages: 243
- **April** - outages: 31, non_outages: 279
- **May** - outages: 10, non_outages: 89
- **June** - outages: 11, non_outages: 99
- **July** - outages: 12, non_outages: 96
- **August** - outages: 17, non_outages: 136
- **September** - outages: 19, non_outages: 152
- **October** - outages: 2, non_outages: 16
- **November** - outages: 25, non_outages: 200
- **December** - outages: 25, non_outages: 200

Outage v/s non-outage wind speed max %ile - january

Outage

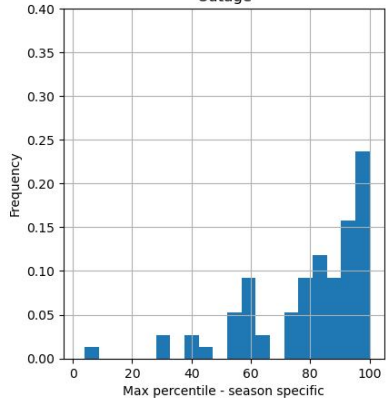

Non-Outage

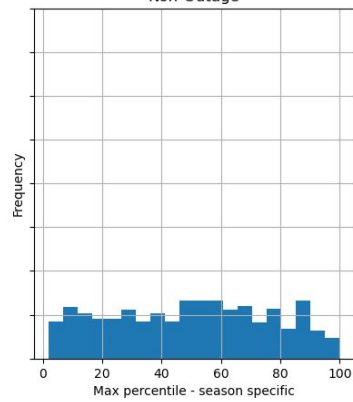

Outage v/s non-outage wind speed max %ile - april

Outage

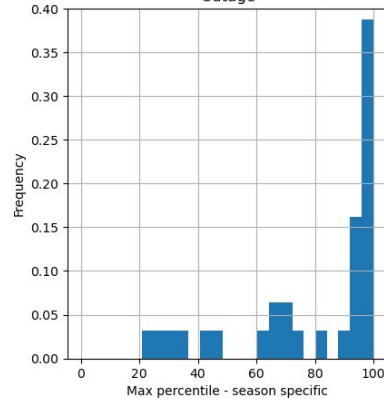

Non-Outage

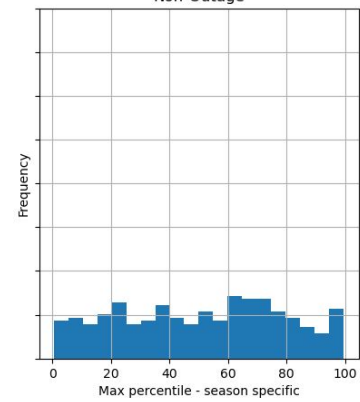

Outage v/s non-outage wind speed max %ile - june

Outage

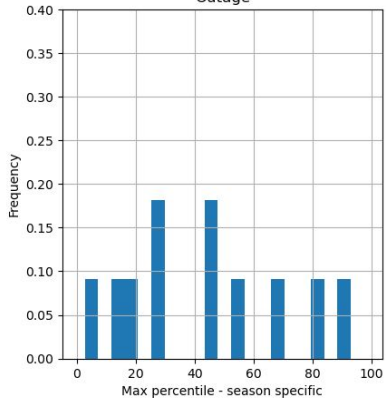

Non-Outage

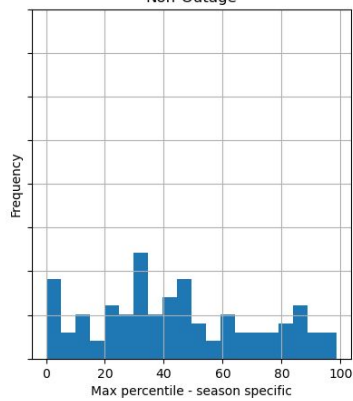

Outage v/s non-outage wind speed max %ile - september

Outage

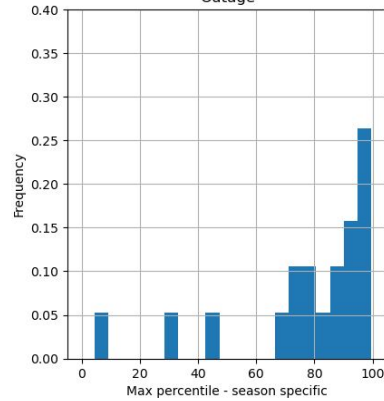

Non-Outage

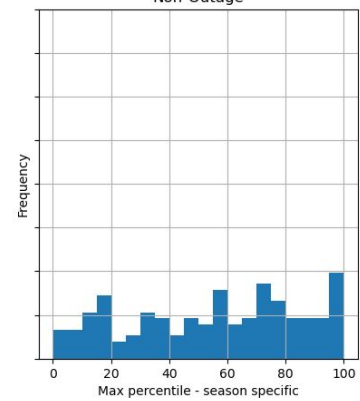

Outage v/s non-outage wind speed mean %ile - january

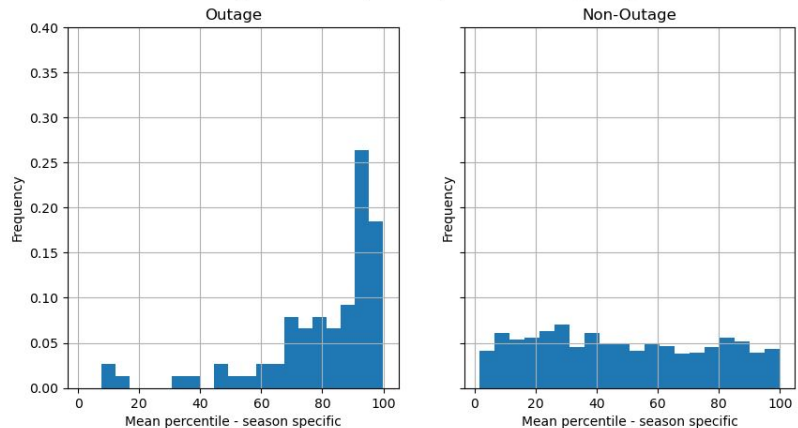

Outage v/s non-outage wind speed mean %ile - april

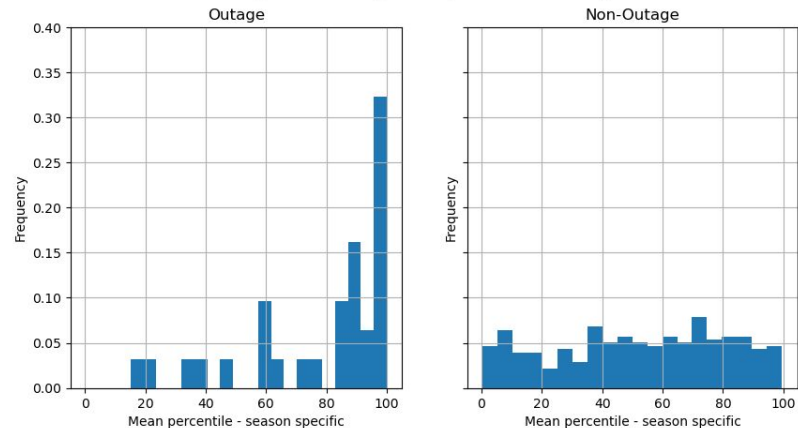

Outage v/s non-outage wind speed mean %ile - june

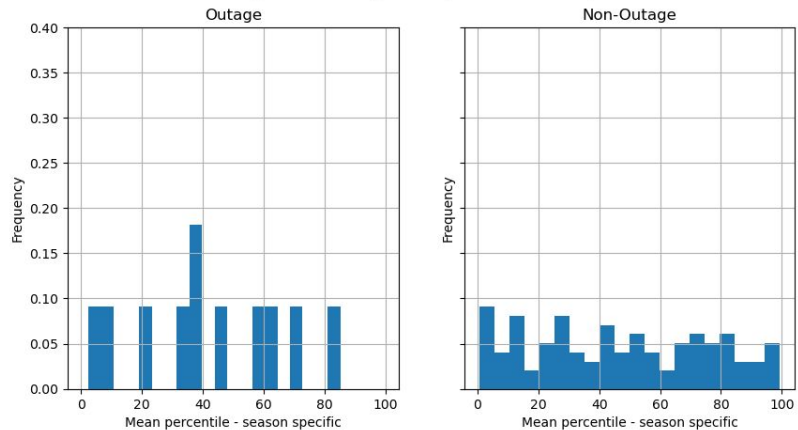

Outage v/s non-outage wind speed mean %ile - september

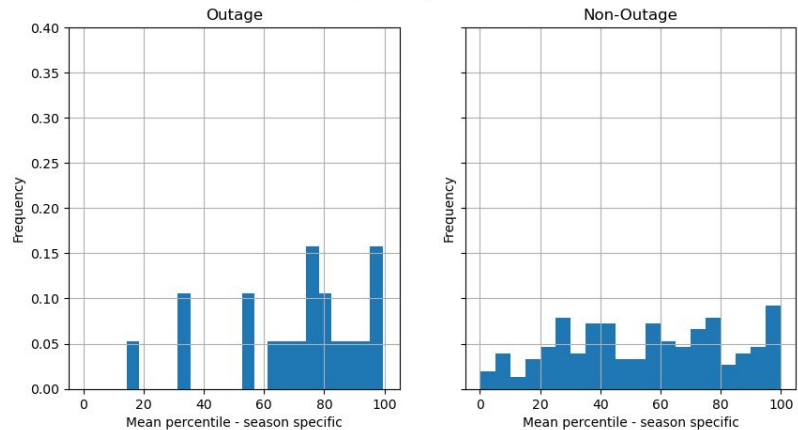

Outage v/s non-outage wind gust max %ile - january

Outage

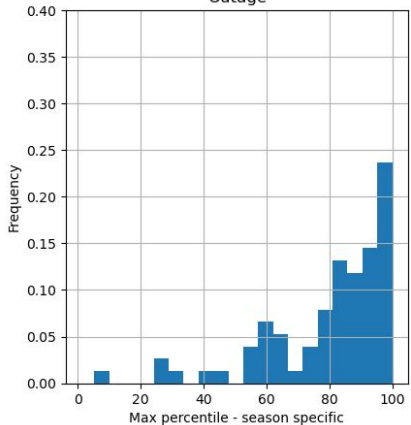

Non-Outage

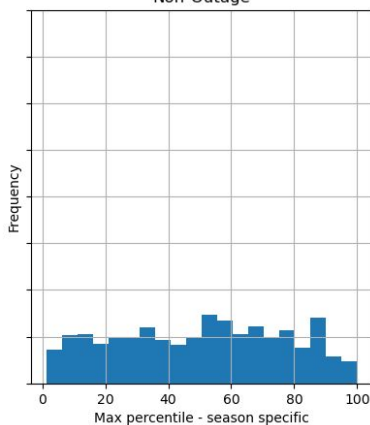

Outage v/s non-outage wind gust max %ile - april

Outage

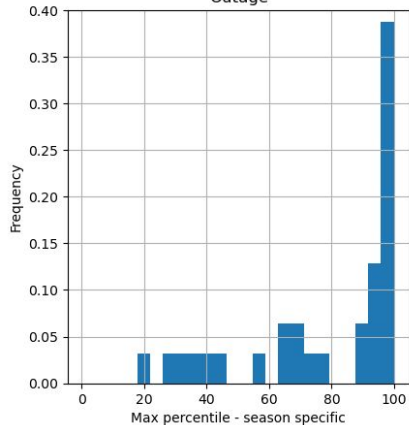

Non-Outage

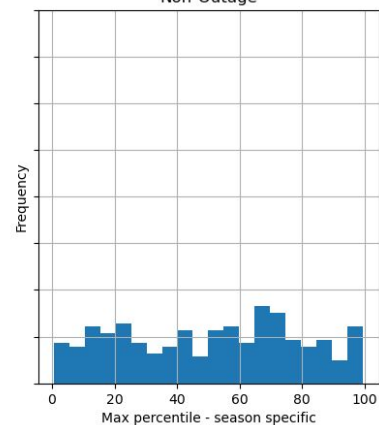

Outage v/s non-outage wind gust max %ile - june

Outage

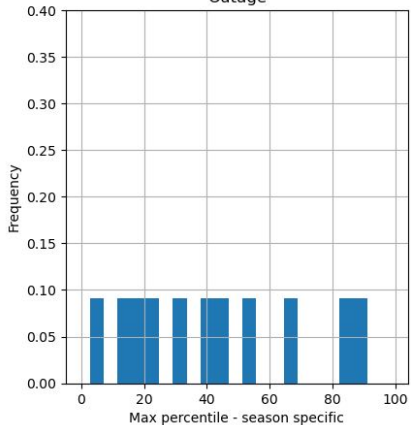

Non-Outage

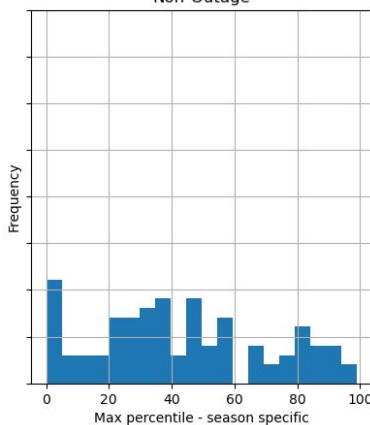

Outage v/s non-outage wind gust max %ile - september

Outage

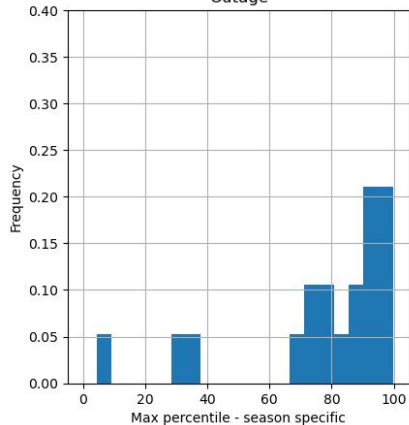

Non-Outage

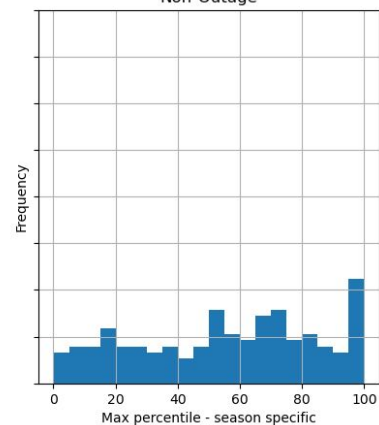

Outage v/s non-outage wind gust mean %ile - january

Outage

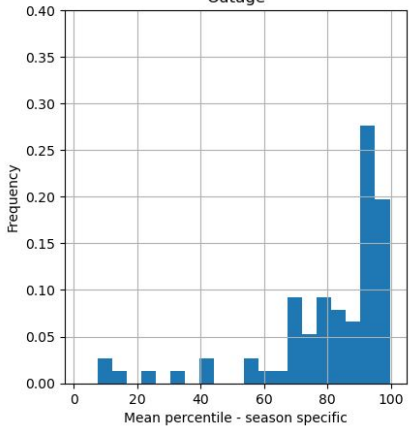

Non-Outage

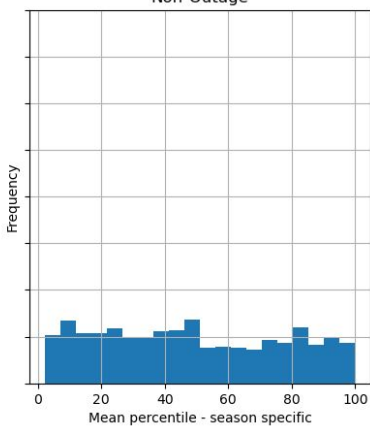

Outage v/s non-outage wind gust mean %ile - april

Outage

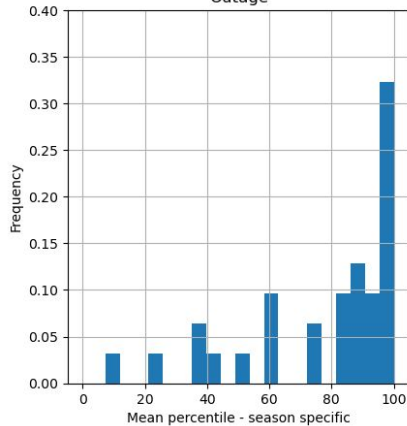

Non-Outage

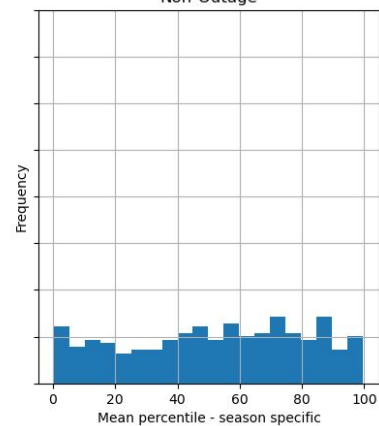

Outage v/s non-outage wind gust mean %ile - june

Outage

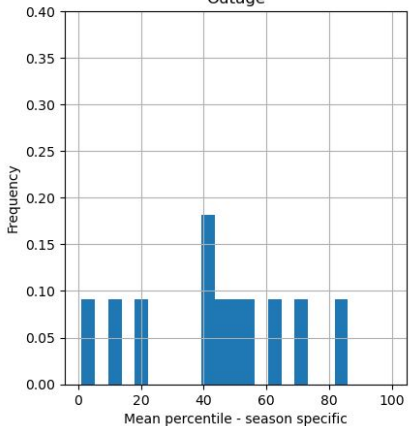

Non-Outage

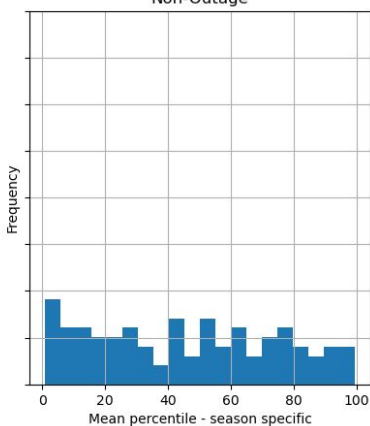

Outage v/s non-outage wind gust mean %ile - september

Outage

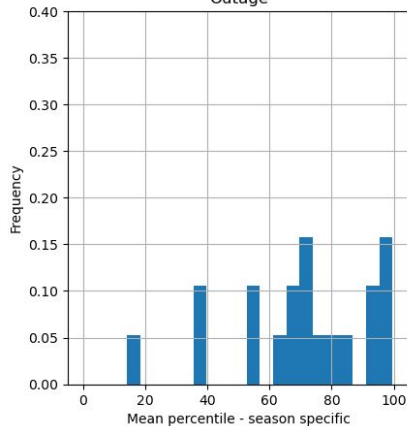

Non-Outage

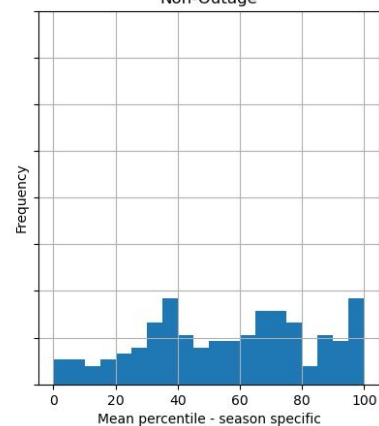

Delta(speed, gust) analysis

Outage v/s non-outage wind speed gust delta max %ile - 24h buckets all time

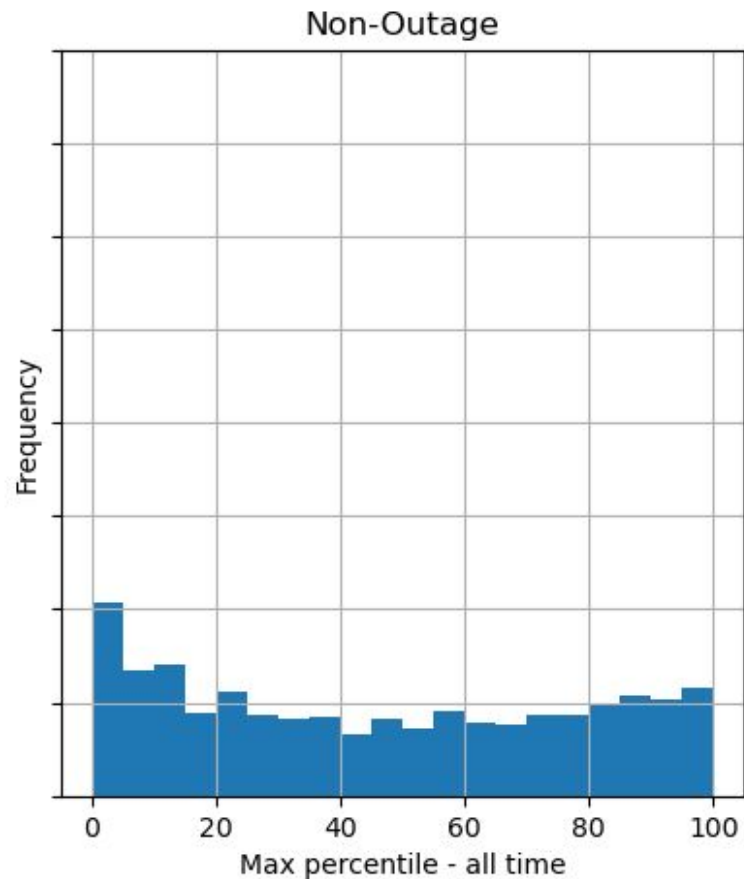
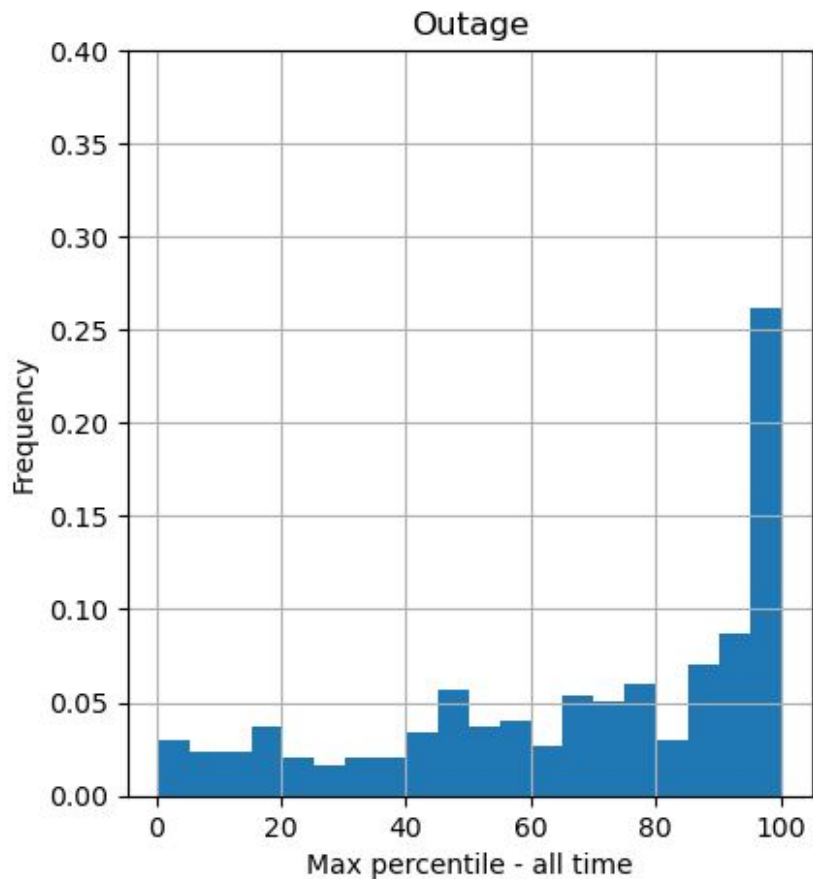

Outage v/s non-outage wind speed gust delta mean %ile - 24h buckets all time

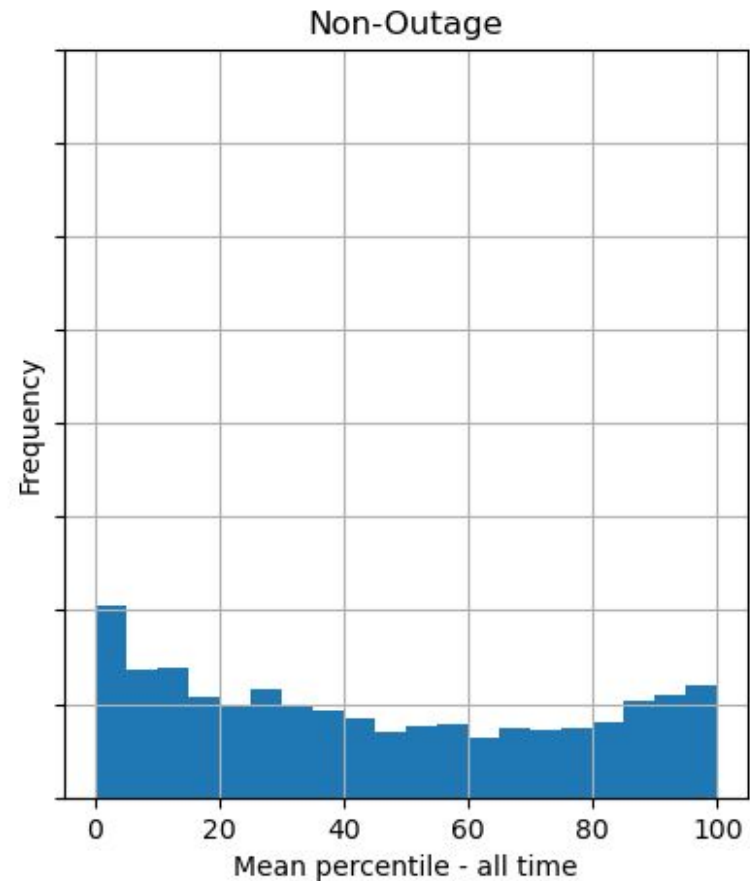
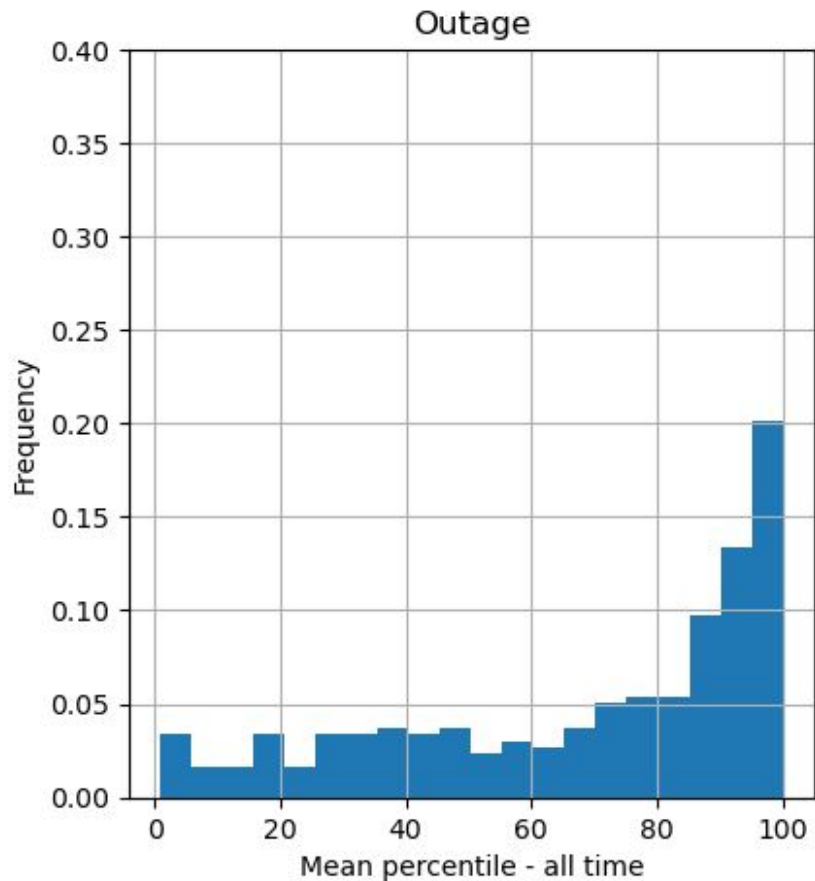

Grid-Level Statistics

Example 1: grid (47, 85)

Outage datetime: 2017-02-27 16:32:00

Season : Winter

Metric	Value (mph)
95th %ile overall (wind speed mean)	7.2044
95th %ile seasonal (wind speed mean)	8.2301
95th %ile overall (wind gust mean)	15.3022
95th %ile seasonal (wind gust mean)	17.1471

Example 2: grid (59, 87)

Outage datetime: 2018-04-14 15:16:00

Season : Spring

Metric	Value (mph)
95th %ile overall (wind speed mean)	10.3428
95th %ile seasonal (wind speed mean)	10.3621
95th %ile overall (wind gust mean)	15.8062
95th %ile seasonal (wind gust mean)	16.5535

Next Steps

- Perform analysis for delta(speed,gust) for seasons and months
- Perform analysis for HFTD vs. non-HFTD regions
- Extend analysis to include more metrics:
 - Span between high winds and outage occurrence
 - Frequency of high winds leading to outage occurrence
- Others?

Attachment B: Joint IOU Covered Conductor Working Group Report



JOINT IOU COVERED CONDUCTOR WORKING GROUP REPORT

2023 Wildfire Mitigation Plan



Table of Contents

1	Introduction.....	1
2	Overview.....	1
3	Testing.....	2
3.1	Introduction.....	2
3.2	Summary of Testing Results.....	4
3.2.1	Arc Testing.....	4
3.2.2	Simulated Wire-down Testing.....	5
3.2.3	Fire risk / Flammability Testing.....	5
3.2.4	Corrosion Testing.....	6
3.2.5	Aging Susceptibility Testing.....	7
3.2.6	System Strength Testing.....	7
3.2.7	Electrical Properties Testing.....	7
3.2.8	Covering Properties Testing.....	8
3.3	Next Steps.....	8
4	Recorded Effectiveness.....	9
4.1	Covered Conductor Recorded Effectiveness.....	9
4.1.1	SCE.....	9
4.1.2	PG&E.....	11
4.1.3	SDG&E.....	13
4.1.4	PacifiCorp.....	14
4.1.5	BVES.....	15
4.1.6	Liberty.....	15
4.2	Next Steps.....	17
5	Alternatives.....	17
5.1	Overview.....	17
5.2	Combination of Mitigations:.....	17
5.3	Next Steps.....	20
6	New Technologies.....	21
6.1	Introduction.....	21
6.2	Summary of Approach.....	21
6.2.1	New Technologies.....	21
6.2.2	Practices and Implementation Strategies.....	22

6.2.3	Effectiveness Values.....	22
6.3	Next Steps	23
7	M&I Practices	23
7.1	Introduction	23
7.2	Summary of Approach:	23
7.2.1	Key Distribution Data	24
7.2.2	Types of Distribution Inspections	25
7.2.3	General M&I Practices	26
7.2.4	Specific M&I Practices.....	27
7.2.5	Training	27
7.2.6	QA/QC	28
7.3	Next Steps	28
8	Estimated Effectiveness:	28
8.1	Overview	28
8.2	Covered Conductor Estimated Effectiveness.....	29
8.2.1	SCE.....	29
8.2.2	PG&E	30
8.2.3	SDG&E	32
8.2.4	PacifiCorp	33
8.2.5	BVES	36
8.2.6	Liberty	37
8.3	Next Steps	37
9	PSPS	37
9.1	Introduction	37
9.2	Summary	38
9.3	Next Steps	38
10	Benchmarking.....	38
11	Costs	39
11.1	Introduction	39
11.2	Updated Covered Conductor Capital Cost Per Circuit Mile	39
11.3	Initial Undergrounding Capital Cost Per Circuit Mile:.....	40
11.3.1	SCE.....	41
11.3.2	PG&E	42
11.3.3	SDG&E	44

11.3.4	PacifiCorp	49
11.3.5	BVES	51
11.3.6	Liberty	51
11.4	Next Steps	53
12	Lessons Learned	53
12.1	Introduction	53
12.2	Lessons Learned	54
12.2.1	CC Effectiveness Values	54
12.2.2	Data Sharing	55
12.2.3	Inclusion of REFCL, OPD, EFD, and DFA as alternatives, including for PSPS considerations 55	
12.2.4	Cost Impacts and Drivers	55
12.2.5	Changes made to initiative selection based on effectiveness and benchmarking across alternatives.	55
12.3	Next Steps	55
13	Conclusion	56

List of Figures

Figure 1: SCE Faults Per Mile-Day as a Function of Covered Conductor	10
Figure 2: PG&E Covered Conductor Effectiveness – Example 1	12
Figure 3: PG&E Covered Conductor Effectiveness – Example 2	13
Figure 4: PG&E Covered Conductor Effectiveness – Example 3	13
Figure 5: PacifiCorp Covered Conductor Effectiveness Examples	14
Figure 6: Liberty Spacer Cable System Preventing a Fault – Viewpoint 1	16
Figure 7: Liberty Spacer Cable System Preventing a Fault – Viewpoint 2	16
Figure 8 SCE Preliminary Framework – Calculation of a Combination of Mitigations.....	18
Figure 9: PG&E Distribution Outage Database Record	31
Figure 10: PacifiCorp Map Showing the Two Circuits Plotted with the HFTD Overlay	34

List of Tables

Table 1: Covered Conductor Type and Approximate Circuit Miles Deployed by Utility.....	2
Table 2: Heat Flux Ranges by Fire Type	5
Table 3: SCE Fault Events on Fully and Partially Covered Circuits Compared to Bare Circuits.....	10
Table 4: PG&E Recorded Effectiveness Snapshots	11
Table 5: BVES Recorded Outages (2016-2022)	15
Table 6: SCE Independent Mitigation Effectiveness Values.....	19
Table 7: SCE Combined Mitigation Effectiveness Values.....	20

Table 8: New Technologies by Utility.....	22
Table 9: Key Distribution Data by Utility.....	24
Table 10: Types of Distribution Inspections performed by SCE, PG&E and SDG&E	25
Table 11: Types of Distribution Inspections performed by PacifiCorp, BVES, and Liberty	26
Table 12: SCE Covered Conductor Mitigation Effectiveness Estimate.....	29
Table 13: PG&E Covered Conductor Mitigation Effectiveness Estimate	32
Table 14: SDG&E Covered Conductor Mitigation Effectiveness Estimate	33
Table 15: PacifiCorp Outage Frequency for Bare Wire and Spacer Cable Circuits (2005 – present; Asterisk (*) indicates the year spacer cable was installed)	34
Table 16: PacifiCorp Risk Drivers for Bare Wire and Spacer Cable Circuits (2021 – present; Asterisk (*) indicates the year spacer cable was installed).....	35
Table 17: BVES Covered Conductor Mitigation Effectiveness Estimate	36
Table 18: IOU Comparison of Covered Conductor Capital Costs Per Circuit Mile	39
Table 19: SCE, PG&E and SDG&E Comparison of Undergrounding Capital Costs Per Circuit Mile.....	40

List of Appendices

Appendix A: Effectiveness and Implementation Considerations of Covered Conductors: Testing and Analysis

1 Introduction

In the 2021 WMP Update Final Action Statements, Energy Safety ordered the Joint IOUs¹ to coordinate to develop a consistent approach to evaluating the long-term risk reduction and cost-effectiveness of covered conductor (CC) deployment, including 1) the effectiveness of CC in the field in comparison to alternative initiatives and 2) how CC installation compares to other initiatives in its potential to reduce PSPS risk. The utilities thus formed a Joint IOU Covered Conductor Working Group and developed an approach, assumptions, and preliminary milestones to enable the utilities' to better discern the long-term risk reduction effectiveness of CC to reduce the probability of ignition, assess its effectiveness compared to alternative initiatives, and assess its potential to reduce PSPS risk in comparison to other initiatives. The approach consisted of multiple workstreams including: Benchmarking, Testing, Estimated Effectiveness, Recorded Effectiveness, Alternatives Comparison, Potential to Reduce PSPS Risk, and Costs. In the 2022 WMP Update filings, the utilities produced a joint report that provided an update on their progress for each of the workstreams, added efforts, and preliminary plans for 2023.

In the 2022 WMP Update Final Decisions, Energy Safety identified Areas of Continued Improvement and Required Progress (ACI) for all utilities to expand this working group to include: 1) Joint CC Lessons Learned, 2) CC Maintenance and Inspection (M&I) Practices, and 3) New Technologies Implementation. Given these directions, the utilities expanded the Joint IOU Covered Conductor Working Group to include 10 workstreams and began meeting on the new workstreams in Q3/Q4 2022.

2 Overview

The information compiled and assessments completed in 2022 continue to indicate CC effectiveness between approximately 60 to 90 percent in reducing the drivers of wildfire risk, consistent with benchmarking, testing and utility estimates. In 2022, laboratory testing on CC has largely been completed with a few tests remaining.

In 2023, the utilities plan to conduct workshops across several workstreams to assess testing results, identify CC M&I best practices, develop a common framework for calculating the effectiveness of a combination of alternatives, assess data and information for effectiveness of new technologies and share practices and implementation strategies, and assess studies to be performed on CC's ability to reduce PSPS impacts amongst other actions. The utilities will also continue to meet to further benchmark efforts, improve methods for estimating and measuring effectiveness, and continue to track and compare unit costs. Below, the utilities describe the progress made on each workstream and steps planned to continue this effort in 2023.

As explained in the 2022 WMP Update report, the current type of CC being installed in each of the utilities' service areas is an extruded multi-layer design of protective high-density or cross-linked polyethylene material. In this report, "covered conductor" or "CC" refers generally to a system installed on cross-arms, in a spacer cable configuration, or as aerial bundled cable (ABC). Distinctions are made where utilities install CC on cross arms and in a spacer cable configuration. Table 1 below, provides an

¹ In this progress report, "Joint IOUs," "IOUs," or "utilities" refers to SDG&E, PG&E, SCE, PacifiCorp, BVES, and Liberty.

updated snapshot of the approximate amount and types of CC installed in the utilities’ service areas through 2022.

Table 1: Covered Conductor Type and Approximate Circuit Miles Deployed by Utility

Utility	First covered conductor installation (year)	Type of covered conductor installed	Approx. miles of covered conductor deployed through 2022	Notes
SCE	2018	Covered Conductor	4,400	Includes WCCP and Non-WCCP Pilot
	2022	Spacer Cable	0.15	
	Installed Historically	Tree Wire	50	
	Installed Historically	ABC	64	
PG&E	2018	Covered Conductor	960	Primary distribution overhead only Like for like replacement
	2022	ABC	3	
SDG&E	2020	Covered Conductor	84	
		Tree Wire	2	
		Spacer Cable	6	
Liberty	2019	Covered Conductor	11	
	2019	Spacer Cable	9	
PacifiCorp	2007	Spacer Cable	76	
	2022	Covered Conductor	7	
Bear Valley	2018	Covered Conductor	34	

3 Testing

3.1 Introduction

In 2022, the joint IOUs performed Phase 2, or testing of CC, to better understand the advantages, operative failure modes, and current state of knowledge regarding CCs. As explained in the utilities’ 2022 WMP Update filings, the utilities contracted with Exponent, Inc. (Exponent) to develop a report for a Phase 1 study (see Appendix A). The Phase 1 study consisted of a literature review, discussions with SMEs, a failure mode identification workshop, and a gap analysis comparing expected failure modes to currently available test and field data. The Phase 1 report was completed in December 2021 and was an attachment to the utilities’ 2022 WMP Update filings. The outcome of the Phase 1 report identified gaps in previous testing and informed the scope of laboratory testing. For the remainder of 2022, the IOUs executed Phase 2 to perform testing and analyses of CC, which had the following objectives:

- Develop test plans based on Phase 1 report identified gaps and recommendations
- Complete physical testing of CC
- Document and discuss results from physical testing of CC

Within Phase 2 of the study, SCE, SDG&E, and PG&E all performed specific testing scopes of work, informed by the findings and recommendations of the Phase 1 report issued by Exponent. The three utilities, led by SCE, contracted with Exponent to independently investigate the effectiveness of CC for overhead distribution systems and, in the case of PG&E and SDG&E, executed additional testing plans as

part of this joint effort.² Exponent conducted several testing scenarios that covered various contact-from-object, wire down, system strength, flammability, and water ingress scenarios. PG&E developed an additional test plan to ensure coverage of failure modes and additional CC types. SDG&E's additional test plan included environmental, service life, UV exposure, degradation, and mechanical strength tests. Exponent's investigation included lab-based testing of 15 kV rated 1/0 aluminum conductor, steel reinforced (ACSR) CC provided by SDG&E, 17 kV and 35 kV rated 1/0 ACSR provided by SCE, 22 kV rated 397.5 kcmil all aluminum conductor (AAC) provided by PG&E, and 17 kV rated 2/0 copper CC provided by SCE (corrosion testing only). PG&E's additional testing included 15 kV rated 397.5 AAC and 15 kV rated 1/0 ACSR. SDG&E's additional testing included a 15 kV rated 1/0 ACSR conductor.

SCE's testing began in Q1 2022 and was completed in Q4 2022. Exponent completed its final report in late December 2022.³ SDG&E and PG&E began testing in Q2 2022. PG&E completed its testing and finalized its report in December 2022.⁴ SDG&E has not completed all its testing with some tests anticipated to be completed in Q1 and early Q2 2023. All testing is not yet complete; however, the utilities have recently started to collaborate on the results of the tests that have been completed. This report provides a summary of the test results that have been completed. In 2023, the utilities plan to continue discussing the results of the tests as further described below.

Based on all the testing completed as of the end of December 2022, the following high-level conclusions were made:⁵

- CC effectiveness was evaluated by phase-to-phase contact and simulated wire-down testing. The study indicated that CCs are up to 100% effective at preventing arcing and ignition in tested scenarios at rated voltages. This is consistent with documented field experience as reported in the Phase I report.
- The study indicated CCs showed effectiveness at preventing arcing and ignition and limited current flow to less than 2.5 mA in 100% of tested phase-to-phase contact scenarios at rated conductor voltages, which included different types of vegetation, balloons, simulated animals, and conductor slapping.
- CCs exceeded insulation ratings for rated voltage with 50% covering removed.
- In wire down situations, broken CCs and CCs with damage that exposed the underlying metal showed potential for arcing/ignition. However, pursuant to the CCs tested, the results showed the CCs prevented arcing and ignition during simulated wire-down events in dry brush in the Exponent testing.
- Thermal testing was performed to understand the impact of a nearby wildfire on CC installations. Results suggested that the heat fluxes and times required for auto-ignition of the polyethylene sheaths were unlikely to be encountered during a surface or low-lying brush fire; however, a canopy fire may be sufficient to cause conductor sheath ignition.

²To distinguish between the results described below, "SCE testing" refers to the joint IOU Exponent testing, "PG&E testing" refers to the testing PG&E conducted, and "SDG&E testing" refers to the testing SDG&E has completed and is still conducting for the Joint IOU effort.

³ The joint IOU Exponent report entitled, "Joint-IOU Covered Conductor Testing Cumulative Report 12-22-22" is included in each utility's Supporting Documents.

⁴ The PG&E report entitled, "PGE Covered Conductor Testing-1219" is included in each utility's Supporting Documents.

⁵All tests were performed under controlled conditions. Actual field performance may vary depending on a variety of factors.

- Water ingress testing was performed to understand if implementation of CCs inherently seals the conductor from moisture exposure, recognizing moisture is often a factor in corrosion occurrences. Stripped ends of CCs and CCs with insulation-piercing connectors (IPCs) were found to be susceptible to water ingress. While the test conditions were extreme relative to typical service conditions, water may travel down the conductor length from a stripped end.
- Corrosion was observed under the CC sheath near the stripped ends but was not observed under IPCs following salt spray testing. While this indicates that subsurface corrosion is possible near a stripped CC end, subsequent tensile testing showed minimal reduction in total strength of the conductor after corrosive environmental exposure for 1,000 hours. Potential water-ingress mitigation measures may help to prevent corrosion in areas where precipitation is likely to collect on the conductor.
- Mechanical testing was performed to assess the strength of CCs and their associated hardware. Strength testing of splices met or exceeded the rated strengths of the conductors. In simulated tree-fall conditions and insulator slip tests, one insulator type exhibited deformation of the metal pin but at a slip strength beyond GO 95 requirements. Another type of insulator exhibited conductor slippage with no apparent signs of damage but at a slip strength below GO 95 requirements.

3.2 Summary of Testing Results

3.2.1 Arc Testing

The purpose of the Arc testing was to understand the effectiveness of CC in mitigating faults and ignition for various contact-from-object scenarios. These tests involved simulating wire-to-wire contact and contact from foreign objects by bridging two conductors, one energized and one grounded. Several permutations of CC, sheath damage, and bare conductors were tested. Overall, CC was successful at mitigating arcing/ignition under all tested conditions at their design voltages. Current flows for CC were recorded to be less than 2.5 mA. In comparison, current flows for bare wire were recorded to be greater than 2,000 mA. For a five-minute contact duration, no arcing, insulation breakdown, or visual damage was observed.

The testing of phase-to-phase contact demonstrates that CC is effective at reducing arcing and the potential for ignitions whenever the insulation is intact, and the operating voltage is within normal ranges. Potential for ignition exists when the insulation is damaged/removed which may occur when objects collide with the CC. This testing also involved energizing the CC at extreme voltages much higher than the CC was designed to withstand. At 90 kV, which far exceeds the conductor ratings, there was no insulation breakdown, pinhole formation, or arcing/ignition observed.

These test results illustrate the effectiveness of CC at mitigating ignitions due to contact-from-object events. Future testing may be done to simulate branches or other debris striking the conductor at speed to determine the ability of the insulation to withstand impact. Future testing may also include simulating the effects of long-term object contact.

3.2.2 Simulated Wire-down Testing

The wire-down testing investigated ignition risk posed by CC and bare wire wire-down events. Flaws were introduced to the covering to represent various scenarios during a CC wire-down. These flaws included the full removal of the covering, removing half the thickness of the covering, and having a broken end. The SCE wire-down testing demonstrated that conductors whose covering was still intact upon contacting the dry brush did not result in an ignition. Upon introducing a full thickness flaw into the covering, which exposed the bare conductor, arcing and ignition were observed. PG&E testing showed that Individual conductor strands can be exposed from the covering during simulated conductor breaks.

SCE testing was also performed by inserting a half-thickness flaw into the covering which did not result in arcing or ignition; this indicates that the CC can sustain significant damage without exposing the bare conductor and still be effective at mitigating ignitions. This conclusion is also corroborated through testing that showed that the CCs had a minimum of 66% of the insulation rating even with 50% abraded insulation.

3.2.3 Fire risk / Flammability Testing

SCE's Fire Risk testing subjected a small segment of conductor to local radiant heat to simulate how CCs would react to various magnitudes of wildfires. The magnitude of the heat represents surface fires, brush fires, and crown fires. Crown fires with a long residence time have the highest potential to cause damage to the covering of the conductor. The study noted that the measurements were taken with direct contact of the flame; however, properly maintained vegetation clearances would decrease an overhead primary distribution line's potential of being in contact with a flame. According to the inverse square law for heat, the intensity of the flame is inversely proportional to the distance squared $X=1/d^2$. Using this equation, we can approximate the amount of radiated heat the conductor might experience at a particular distance away from a flame. The shortest distance that should be expected between vegetation and the conductor would be when there are crowns of trees nearby (6-foot clearance, GO 95). There would be a significantly greater distance between the conductor and vegetation for surface and brush fires. At 6 feet, the heat flux is approximately 30% of what would be felt directly at the flame. At a distance of 6 feet (1.8288m) and utilizing the scenario-based heat fluxes provided, we can approximate the amount of heat the conductor would encounter. See Table 2 below that shows the heat flux ranges for direct contact and contact at six feet for the different fire types.

Table 2: Heat Flux Ranges by Fire Type

Fire Type	Heat Flux (kW/m ²) Range with Direct Contact		Heat Flux (kW/m ²) Range with Contact at 6 feet (1.8288m)	
	Min	Max	Min	Max
Surface fires	18	77	5	23
Brush fires	97	110	29	33
Crown fires	179	263	54	79

3.2.4 Corrosion Testing

To make electrical and structural connections, some utilities remove the covering of the conductor to expose bare wire. When a bare wire is exposed to the elements, it becomes more susceptible to various types of corrosion. This was a common failure mode that was identified when benchmarking with other utilities. To mitigate this failure mode, some utilities use medium voltage fusion tape (MVFT) on electrical connections to the line. SDG&E utilizes Insulated Piercing Connectors (IPCs) to make electrical connections and a tensioning clamp for structural connections. Water ingress testing was performed by both SCE and PG&E to evaluate the corrosion susceptibility for instances when the covering is removed. SCE varied the test by utilizing a tool specifically designed to remove the covering to expose a length of bare conductor and removing the covering manually without unique tools; they also varied the conductor material to include copper and aluminum. The conductor was then placed vertically with a dedicated reservoir of fluorescent water at the top to simulate moisture intrusion. In all the tests, water was visible at the opposite end of the conductor segment within 5-10 minutes. PG&E's version of the testing was varied to test various types of CC with and without water-blocking agents. PG&E's test was also slightly different because a length of exposed conductor was not left at the top, but rather a clean cut was made on each of the conductors. For the conductors without water-blocking agents, fluorescent water was observed at the opposite ends of the conductor while there was no liquid observed for the conductors with water-blocking.

Although the water ingress testing setup, conducted in a submersible configuration, is not likely to occur in the field, water ingress can lead to accelerated corrosion. Additional preventative actions taken during installation and/or maintenance, such as the use of IPCs, tension clamps, gel wraps/packs, wildlife covers, or MVFT, may help limit moisture ingress and related corrosion effects. For example, PG&E's water immersion test of gel wraps demonstrates this mitigation's ability to prevent water intrusion for splice and other electrical connections. Additionally, corrosion can potentially be mitigated with the use of copper CCs due to copper being less susceptible to corrosion than aluminum in high corrosive areas.

Salt spray testing was performed by SCE to evaluate the susceptibility of exposed ends of CC to corrosion in coastal and industrial environments. This testing utilized a 5% salt solution for 168 hours with a SO₂ solution introduced intermittently. The testing varied like the water intrusion testing, but also added artificial defects to simulate mid-span damage and performed the testing on bare conductors as well. Corrosion was identified on the exposed portion of the CC as well as under the covering. When a conductor had simulated damage, the most severe corrosion occurred. Exponent did identify that a segment of CC was evaluated which utilized an IPC; however, this did not demonstrate corrosion.

PG&E's atmospheric corrosion tests consisted of 1,000 hours of exposure using a 5% salt solution. This test evaluated bare conductor, CC, and splice connections with MVFT or gel packs. PG&E summarized that aluminum CCs are more susceptible to corrosion compared to bare conductor when exposed to a corrosive environment. This ingress is reduced with the application of MVFT and altogether eliminated with the use of gel packs. It is also important to note that all conductors met the rated breaking strength after the testing was completed.

3.2.5 Aging Susceptibility Testing

PG&E performed UV weathering tests with 1,000 hours of exposure time (ASTM G155-21). Two types of CCs were tested and neither met the tensile or elongation requirements of ANSI/ICEA S-121-733 to be considered resistant to sunlight. The results indicate that the covering is susceptible to degradation and cracking after long-term exposure to UV for the conductors tested.

Exponent, with SDG&E, performed accelerated aging testing by monitoring a segment of the cover at 10% thickness. It is assumed that the rate of change that is observed with a segment at 10% thickness can be used to anticipate the amount of deterioration over 40 years. Three tests were performed at 80C, 110C, and 130C; one test was performed at 80C with 1.60W/m² at 340nm UV. The UV data would then be interpolated with the results of the 110C and 130C samples to test the properties of interest; those include dielectric constant, mechanical strength, chemical changes, and visual changes. The results of this test also indicate that the covering is susceptible to degradation and cracking after long-term exposure to UV.

3.2.6 System Strength Testing

After the salt-spray corrosion testing, Exponent evaluated the tensile testing strength of the various aluminum, copper, and steel strand samples. The results from the individual strands can be used to assess the condition of the whole conductor. They showed that even though the aluminum strands underwent corrosion due to the accelerated aging, there was not a significant loss of strength in the conductor overall. For conductors with IPCs installed, there was a measurable decrease in tensile strength of the conductor strands related to the damage caused by the IPC, the degradation was not due to corrosion. Other utilities that utilize IPCs to make electrical connections have not identified this to be a concern.

PG&E evaluated the tensile strength of the conductors to confirm that they met the rated breaking strength and to evaluate how the conductor and cover would react. Both conductors tested exceeded the rated breaking strength. At the point of fracture, necking occurred but was more significant for the covering than the aluminum and steel wires. Small segments of exposed conductor could be seen protruding from the covering. Because of this, breaks in the conductor could result in phase-to-ground contact, which could lead to an ignition.

SCE's system strength tests included a splice maximum load test, insulator slip test, and a tree fall test. For the splice max load test, all splices met or exceeded specifications. For the insulator slip test and tree fall test, two different types of insulators were used. One experienced deformation of the metal pin while the other showed signs of slippage with no apparent damage. For a simulated tree fall on a dead-end configuration, a failure occurred with smaller sized conductor due to it slipping out of the dead-end shoe. It was noted that the failure likely occurred above the rated strength of the conductor. For larger conductors, the failure point was at the crossarm.

3.2.7 Electrical Properties Testing

PG&E performed leakage current and dielectric withstand tests on the covering and various splice coverings. For the covering tests, two different types and sizes of conductor were used, both with full cover thickness and 50% cover thickness to simulate a flaw. In all the covering test cases, the insulation

failed at a voltage level that greatly exceeded its rated value. The splice covers tests consisted of a compression splice with gel pack, compression splice with MVFT, and a fired wedge connector with a cover. In all cases the splice coverings met or exceeded the ratings of the CC insulation rating.

To understand if CC could be susceptible to tracking damage, inclined plane tracking and erosion tests and tracking resistance with salt fog tests were performed. For the inclined plane and erosion tests, both conductor samples passed; however, one of the conductors showed a greater erosion depth. The tracking resistance with salt fog tests were designed to understand the impacts of long-term vegetation contact. Again, for these tests, both conductors met the passing criteria but, again, the same conductor showed a greater erosion depth.

PG&E tested the damaging effects that lightning might have on the covering. This was a custom test with guidance from IEEE Std. 4 and IEC 60060-1. The conductor samples were subjected to lightning impulses starting at 85 kV and then increased in the magnitude of the voltage until a breakdown occurred. Both of the conductor samples tested experienced breakdowns between 90-110 kV for each of the 5 samples. The conclusion of the lightning tests is that both coverings have the potential to be damaged by lightning; however, damage is expected to be localized and would be unlikely to cause auto-ignition of the covering.

3.2.8 Covering Properties Testing

The thermal properties of conductor layers were tested by PG&E to verify the glass transition temperatures for each layer of two different conductors. One of the conductors exhibited an onset of glass transition in the conductor shield layer at a lower than emergency temperature rating which could indicate possible early covering degradation if exposed to emergency temperatures repeatedly. The other conductor showed no signs of degradation up to the emergency operating temperatures.

3.3 Next Steps

As explained above, several testing results were completed in December 2022 with a few still remaining. The utilities have met to overview the results of some completed tests but have not yet discussed all results nor in detail yet. In 2023, the utilities will conduct meetings and workshops to assess the testing results, determine if any additional tests are needed, determine if any mitigations are warranted (such as changes to materials, construction methods, or inspection practices), and will meet to assess whether changes to effectiveness estimates are warranted. Additionally, and as part of the workshops, the utilities will discuss the testing results in relation to PSPS de-energization thresholds. Below, we present a preliminary schedule for workshops and discussion themes.

- March 2023 – Corrosion Testing
- April 2023 – Aging Susceptibility Testing
- May 2023 – Arc Testing
- June 2023 – High Impedance Faults
- July 2023 – Tree Fall-in

Once the utilities finalize the workshop schedule, Energy Safety will be invited. Based on findings from the workshops, additional workshops may be scheduled in 2023. Additionally, the utilities will continue

to meet on a biweekly basis. Should the results of the workshops lead to changes in materials, construction practices, effectiveness values, etc., the utilities will establish plans to implement these changes and document as part of lessons learned.

4 Recorded Effectiveness

As explained throughout this report, the utilities have continued to implement CC and are using recorded data to help assess its effectiveness in the field. Though the utilities' data is still relatively limited, the outcomes in 2022 in addition to previous years outcomes, as presented below, continue to show CC effectiveness at reducing the risk drivers that can lead to wildfires range between approximately 60 to 90 percent, which is consistent with the utilities' estimated effectiveness values and supported by recent testing results. Below, the utilities provide an update on its 2022 WMP Update report describing data and analyses used to measure recorded effectiveness of CC and plans for 2023 to continue to discuss and share recorded data and methods to measure effectiveness, and document lessons learned.

4.1 Covered Conductor Recorded Effectiveness

4.1.1 SCE

SCE has continued to refine its data and methods to measure the effectiveness of CC in the field. In 2022, SCE set up a CC dashboard that tracks fault rates on overhead distribution circuits with 100% CC installed, circuits that are partially covered, and circuits with no CC installed (bare wire). The data can be broken down by fault sub-drivers such as CFO, EFF, and Other. The data is based on all circuits that traverse HFTD and includes a breakdown of how many miles fall into the fully covered, partially covered, and not covered categories. The dashboard refreshes daily with updated fault and CC data. Because faults that occur on partially covered circuits are difficult to determine if occurred on the covered or bare portion, SCE has further delineated this data into the following partially covered groups: Less than 25%, 25% to 49%, 50% to 74%, 75% to less than 100%. Furthermore, SCE is now using a faults per mile-day method that factors in how long the circuit was fully or partially covered. In 2022, SCE provided overviews of its dashboard, grouping and methods to this working group. Faults per mile-day data from 2019-2022 are shown in Figure 1 below.

Figure 1: SCE Faults Per Mile-Day as a Function of Covered Conductor

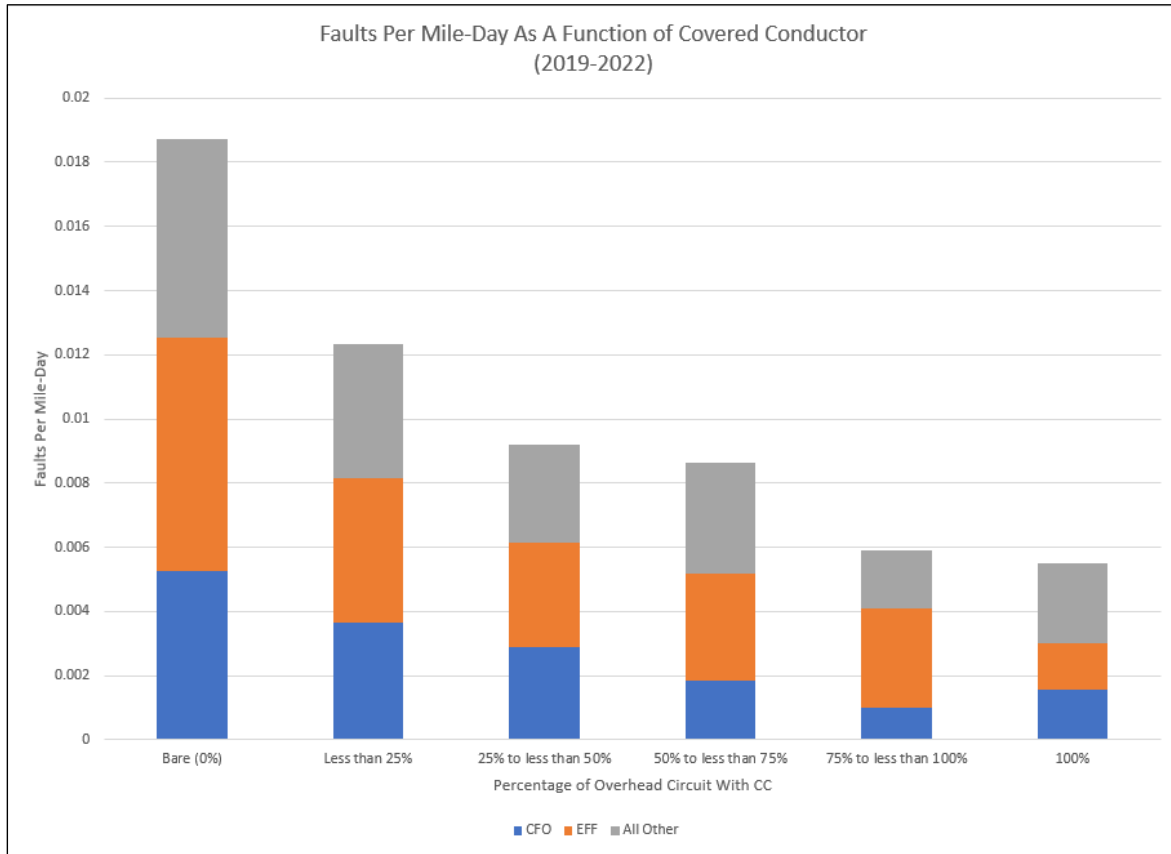

By comparing fault events on fully and partially covered circuits to bare circuits in its HFRA on a per mile-day basis from 2019 to 2022, the data shows that circuits fully covered experience approximately 70% less faults than bare conductor when factoring in all sub-drivers (see Table 3 below). Additionally, circuits that are in the 75% to less than 100% covered group experience a similar improvement over bare conductor at approximately 69% less faults. The data also shows a predicted trend with an increasing reduction in faults as more of a circuit is covered. Furthermore, on segments where SCE has covered bare wire, there has not been a CPUC-reportable ignition from the drivers that CC is expected to mitigate.

Table 3: SCE Fault Events on Fully and Partially Covered Circuits Compared to Bare Circuits

Grouping	Reduction Compared to Bare			
	CFO	EFF	All Other	Total
Bare (0%)	0.0%	0.0%	0.0%	0.0%
Less than 25%	30.6%	38.3%	32.0%	34.1%
25% to less than 50%	45.3%	54.9%	50.7%	50.8%
50% to less than 75%	65.0%	54.0%	43.9%	53.8%

Grouping	Reduction Compared to Bare			
	CFO	EFF	All Other	Total
75% to less than 100%	81.0%	57.6%	70.8%	68.5%
100%	70.3%	80.3%	59.2%	70.5%

4.1.2 PG&E

As of the end of 2022, the number of ignitions observed on the CC lines does not provide statistically significant data for calculating effectiveness with respect to ignitions. As most distribution outages (momentary and sustained) typically involve a fault condition, PG&E assumes that all distribution outages can potentially result in an ignition, regardless of other prevailing conditions. Therefore, PG&E is measuring the recorded effectiveness of CC by comparing the outages on the circuit segments with CCs to outages on circuit segments with bare conductors.

PG&E's recorded effectiveness is calculated in three different snapshots. The first snapshot considers all CC installations by the end of 2019 and average yearly outages in 2020-2022. The 2nd snapshot considers the CC installations by the end of 2020 and average yearly outages in 2021-2022. Lastly, all CC installations by the end of 2021 and outages in 2022 are considered in the 3rd snapshot.

PG&E has not included CC installations that were completed in the middle of year 2022. PG&E is only including locations that were completed by end of year (EOY) 2021, so that there is a minimum of 1 year of outage performance data to be able to compare with outage performance in areas with bare conductor.

The comparison was conducted on an outages per year, per mile basis to normalize outage rates pre- and post- CC. Table 4 below presents the results of this preliminary recorded effectiveness analysis.

Table 4: PG&E Recorded Effectiveness Snapshots

Snapshot	Category of OH HFTD circuit segments (downstream of SSDs)	Total CC miles in this category	Total OH HFTD miles in this category	% CC'ed	Average yearly HFTD outages	Outage / Total OH HFTD miles / year	Improvement compared to Category 1
1: CC miles % of total OH miles by the end of 2019	Outages considered: 2020-2022						
	Category 1: not covered at all	0	24,849	0%	9339.7	0.38	-
	Category 2: 1-80% (partial)	27	242	11%	53.7	0.22	41%
	Category 3: 80%+ (mostly)	36	38	95%	4.3	0.11	69%
2: CC miles % of total OH miles by the end of 2020	Outages considered: 2021-2022						
	Category 1: not covered at all	0	24,950	0%	9544	0.38	-
	Category 2: 1-80% (partial)	122	640	19%	157.5	0.25	36%
	Category 3: 80%+ (mostly)	178	185	96%	19.5	0.11	72%
3: CC miles % of total OH miles by the end of 2021	Outages considered: 2022						
	Category 1: not covered at all	0	24,942	0%	5978	0.24	-
	Category 2: 1-80% (partial)	148	877	17%	151	0.17	28%
	Category 3: 80%+ (mostly)	238	248	96%	18	0.07	70%

The calculated outage reduction percentage (used as a measure for the recorded effectiveness) shows that CC sections experience approximately 28-70% fewer faults compared to bare conductor circuit segments.

PG&E's results are presented in Table 4. These results are preliminary due to the following factors:

- Using an averaged per mile rate for the outages inherently omits the granular perspective related to each individual section of the circuits in PG&E's service area because it does not capture the impact of localized environmental/weather conditions. Hence, this analysis may over or under-represent effectiveness.
- It is assumed that all distribution outages could potentially result in an ignition. It does not factor in if one type of outage is more or less likely to result in an ignition. However, there are several failure modes such as tie-wire failure that have a much lower likelihood of ignition compared to an outage due to a broken conductor.
- The outages in partially covered and mostly covered categories (category 2 and 3) could have occurred on parts of the line that are not covered, which cannot be validated due to lack of exact geospatial information for the outages.

As part of PG&E's ignition investigation process, it is incorporating additional review of ignition identification that occurs on a CC line to ensure visibility of failures based on observed incidents. Below are some examples related to the effectiveness of CCs in the field that have been observed in PG&E's service area.

Example 1: On 5/10/2021, a 125-foot ponderosa pine that was 55-feet away from a pole, failed approximately 40-feet above ground, severing the CC, causing a wire down, and a subsequent CPUC reportable ignition.

Figure 2: PG&E Covered Conductor Effectiveness – Example 1



Example 2: On 5/2/2022, a 120-foot ponderosa pine that was being abated for previously reported structural concerns, fell on a CC line, severing it, and starting a CPUC reportable ignition.

Figure 3: PG&E Covered Conductor Effectiveness – Example 2



These two incidents highlight some limitations concerning CC. In both incidents, there were vegetation management inspections and CC deployed. But even with the combined mitigations, it still resulted in an ignition.

Example 3: On 12/27/2021, two CCs were supporting an entire tree. There was no ignition; however, an electrical outage did occur on the line.

Figure 4: PG&E Covered Conductor Effectiveness – Example 3



4.1.3 SDG&E

As CCs become a larger part of the system, the performance indicators that impact the efficacy of this mitigation will continue to be monitored and measured, including the measured effectiveness. As there are approximately 84 miles of CC installed with an average age of less than one year, SDG&E does not have sufficient data yet to draw any conclusions on the recorded effectiveness of CC.

Moving forward, SDG&E will continue to track the mileage, years of service, and faults on all CC circuit segments and will continue to collaborate with this working group to improve methods to measure the effectiveness of its system hardening initiatives. SDG&E's approach is to calculate the risk events per

one hundred miles per year on segments that have been covered and compare the risk event rate before and after the installation of CC.

4.1.4 PacifiCorp

PacifiCorp continues to track risk events within each zone of protection (ZOP) with known conductor types and assumes homogenous performance across the ZOP. Current processes do not establish specific locations where fault events occur, but are reconciled to the device that protects the ZOP. To establish the recorded effectiveness, PacifiCorp queried pre- versus post-installation performance with risk event drivers for all ZOPs having CC (specifically spacer cable construction). It was important to recognize that legacy projects were focused on reliability and thus did not require reconductoring of the entire ZOP. As such, the recorded effectiveness calculations accounted for the percentage of the ZOP that wasn't reconducted. The smaller the percentage of the ZOP the less the confidence of the recorded effectiveness, while the higher the percentage of the ZOP the higher the confidence of the calculation.

PacifiCorp has also documented known contact-related events with CC. As shown in Figure 5 below, these events did not result in faults, wires down, or ignitions because spacer cable was deployed and provide examples of effectiveness in the field.

Figure 5: PacifiCorp Covered Conductor Effectiveness Examples

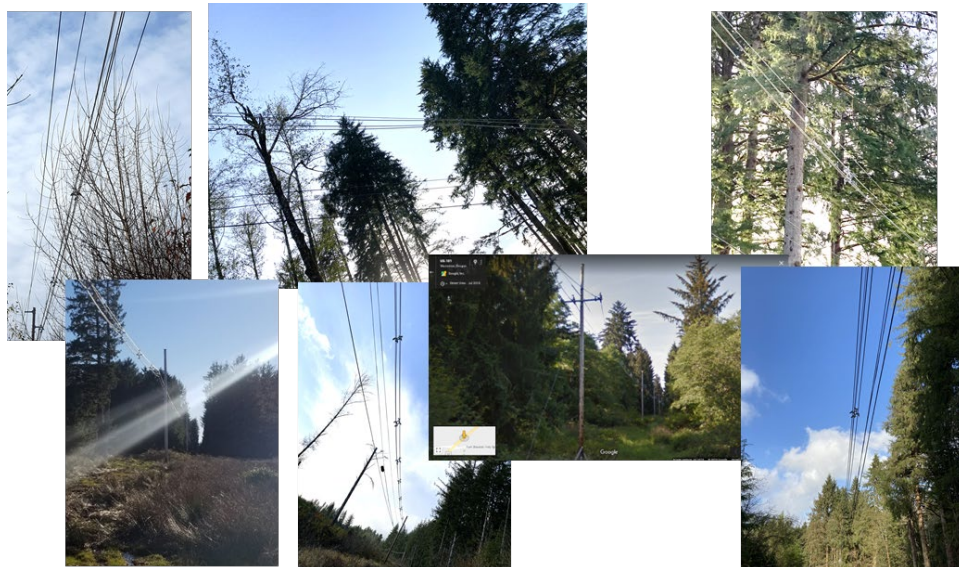

PacifiCorp will continue to monitor and track all faults on our CC circuits and track performance as compared to bare wire installs. PacifiCorp will also continue to collaborate in this working group to ensure we gather and share information from the other IOUs.

4.1.5 BVES

BVES has approximately 211 circuit miles of overhead conductor between 34.5 kV and 4.16 kV in its system. BVES started a CC pilot program in Q2 2018 and completed it in Q3 2019 using two different type of cover conductor wires (394.5 AAAC Priority wire and 336.4 ACSR Southwire). Then, BVES started the cover conductor WMP in late 2019 with plans to cover 4.3 circuit miles on 34.5 kV over the next 4 years and 8.6 circuit miles on 4.16 kV over the next 10 years. As of end of Dec. 2022, BVES has covered approximately 34 miles between its 34 kV and 4 kV systems.

In Q3 2018, BVES started a new tree-trimming contract with a new tree service contractor. BVES has been very aggressive with its vegetation manage program having up to four tree crews or more at a time to complete its three-year cycle and remediating any issue trees which has helped reduce outages from vegetation contacts. As of end of 2021, BVES has completed its vegetation three-year cycle and in 2022 has started a new three-year cycle vegetation manage program.

As part of its wildfire mitigation efforts, in June 2019, BVES began replacing all explosion fuses in its service area with Trip Savers and Elf Fuses. BVES completed this project in May 2021, which eliminated the potential for ignitions from explosion fuses.

Though 2022, BVES has still not had any outages, wire down, tree limbs and/or ignitions on the lines that have been covered. BVES is still in the early stages of its CC program. As more areas are covered and as more time passes, BVES will compile more recorded data to inform on the effectiveness of CC. The Table 5 below provides a simple assessment of recorded outages since 2016 and through 2022.

Table 5: BVES Recorded Outages (2016-2022)

Year	# of Outages
2016	75
2017	95
2018	34
2019	26
2020	57
2021	46
2022	52

4.1.6 Liberty

Liberty's CC program is relatively new, having begun in 2020. Because the program is new, data on the performance of CC effectiveness do not yet demonstrate meaningful recorded effectiveness results based on the limited sample period and the wide variations in weather conditions from year-to-year. In addition, the CC projects completed thus far represent a small percentage of each circuit's total line miles.

Based on a review of Liberty’s Outage Management System (OMS) data, there have been zero reported outages or ignitions caused by an event on CC spans. The only known event that occurred on a CC span, in a spacer cable configuration, happened during a winter storm in early January 2023. The event did not create an outage or ignition and it was found as a result of a post-storm aerial patrol. In this incident, a tree fell across a spacer cable span that was installed in 2020. The tree pulled down the span and caused three poles to lean significantly; however, the messenger wire held up the tree and prevented a fault and a wire from falling to the ground. Figure 6 and Figure 7 below represent this one incident.

Figure 6: Liberty Spacer Cable System Preventing a Fault – Viewpoint 1



Figure 7: Liberty Spacer Cable System Preventing a Fault – Viewpoint 2



Upon finding the damage, the poles were reset to vertical and the damaged support brackets were replaced. No damage was found related to the conductor.

Liberty intends to continue to monitor CC effectiveness and reinforce the need to collect and highlight any events that occur on CC. As more CC is installed and is in service for a longer period of time, the data collected will become more meaningful.

4.2 Next Steps

In 2023, the utilities will continue meet on a regular basis, provide updates on risk event recorded data, discuss the methods used to measure the effectiveness of CC in the field, and continue to work towards developing consistent methods to measure the effectiveness of CC for better comparability. The utilities also plan to discuss outage data, causation identification and reporting. These efforts will require SME discussions and review of outage, wire-down and ignition data across the utilities. The utilities will also document any lessons learned.

5 Alternatives

5.1 Overview

In the 2022 WMP Update filings, the utilities identified a list of viable alternatives to CC and conducted workshops with SMEs that assessed the effectiveness of those alternatives against the same risk drivers that CC is designed to mitigate. In 2022, the utilities focused on the combination of mitigations utilities deploy as it relates to CC and alternatives to CC and discussing a framework to calculate the effectiveness of the combination of mitigations deployed on the same circuit or circuit-segment. Below, we describe these efforts and plans for 2023 to further this workstream.

5.2 Combination of Mitigations:

The combination of mitigations refers to the suite of mitigations utilities deploy in relation to CC and alternatives to CC on circuits or circuit-segments to mitigate wildfire risk and/or reduce the impacts of PSPS. For example, all utilities deploy CC and where CC is installed all utilities conduct vegetation management mitigations and asset inspection mitigations. Additionally, circuits that have CC are still in scope for potential PSPS and most utilities also employ fast curve settings on these circuits during elevated fire-weather conditions. Likewise, several utilities deploy undergrounding to mitigate wildfire risk and PSPS impacts and where circuits are undergrounded, vegetation management mitigations are significantly lessened if not eliminated, the potential for PSPS is in most cases eliminated, and asset inspection mitigations can also be reduced. Notwithstanding system configuration, geography, terrain, permitting, costs, the time to deploy, operational/resource constraints, environmental constraints and other considerations, utilities can choose to install CC or other mitigations such as traditional hardening, new bare conductor, undergrounding, a remote grid, and/or new technologies to mitigate wildfire risk and/or reduce the impacts of PSPS. In choosing between CC and alternatives to CC, utilities will also

deploy other mitigations. As such, the utilities understand the need to explore methods to assess the effectiveness of a combination of mitigations.

Historically, utilities have largely estimated the effectiveness of mitigations separately. The utilities have discussed methods to calculate the effectiveness of multiple mitigations deployed on the same circuit or circuit-segment. In 2022, the utilities discussed efforts to perform such a combination of mitigations calculation. While PG&E and SDG&E have not yet adopted a framework for this evaluation, SCE shared its preliminary framework (Figure 8) to calculate the effectiveness of a combination of mitigations.

Figure 8 SCE Preliminary Framework – Calculation of a Combination of Mitigations

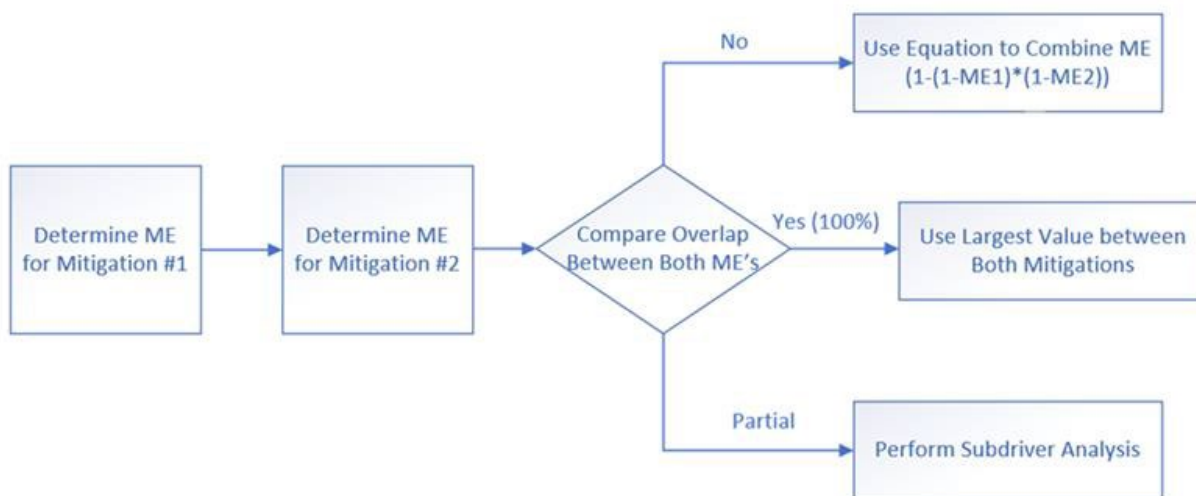

SCE’s preliminary framework includes three prongs given that mitigation measures can target the same or different risk drivers. For example, CC is highly effective at reducing most contact-from-object sub-drivers such as light vegetation contact, animal contact, and metallic balloons. However, CC is not highly effective at reducing faults/ignitions from large trees that can fall into lines. The framework thus distinguishes the overlap of multiple mitigations. In the first prong, if multiple mitigations have no overlap in the risk drivers they mitigate, a standard equation can be used to calculate the combined effectiveness, as seen in Figure 8. In the second prong, SCE considers where mitigations directly overlap with one another for a particular risk driver. In these instances, the mitigation with the highest effectiveness would be the combined effectiveness value. In the third prong, SCE considers where mitigations may target the same risk driver but they reduce the risk differently. In these situations, further analysis is needed to determine the incremental effectiveness prior to then combining the effectiveness values. Additionally, once the effectiveness of combined mitigations by driver are calculated, those values then need to be applied to the frequency of the driver risk events. Given that these estimated values are based on calculations and quantitative data can be limited and not always available, the utilities have also discussed discounting the individual estimated mitigation values.

To illustrate this framework, we use a subset of SCE’s CC++ portfolio mitigation strategy. CC++ represents deploying CC, vegetation management, asset inspections, and other mitigations on the same circuit / circuit-segment that work collectively to better address the risk drivers than each by

themselves. The tables and descriptions below are based on assessing the combination of CC, asset ground inspections, enhanced line clearing, pole brushing, and SCE’s HTMP.

Table 6 shows independent estimated mitigation effectiveness values for the selected mitigations across selected contact-from-object and equipment failure sub-drivers. For purposes of this illustration, no discounting of individual estimated mitigation values was included.

Table 6: SCE Independent Mitigation Effectiveness Values

Risk Driver Description	WCCP	Distr Ground Asset Inspections	VM - Hazard Tree	VM - Expanded Pole Brushing	VM - Expanded Line Clearing
Animal contact- Distribution	65%	48%	0%	0%	0%
Balloon contact- Distribution	99%	0%	0%	0%	0%
Other contact from object - Distribution	77%	0%	0%	0%	0%
Unknown contact - Distribution	80%	0%	0%	0%	0%
Veg. contact- Distribution	71%	77%	64%	33%	36%
Vehicle contact- Distribution	82%	0%	0%	0%	0%
Capacitor bank damage or failure- Distribution	20%	87%	0%	20%	0%
Conductor damage or failure — Distribution	82%	80%	0%	7%	0%
Switch damage or failure- Distribution	2%	76%	0%	20%	0%
Transformer damage or failure - Distribution	20%	66%	0%	20%	0%

Using the risk driver vegetation contact, Table 6, above, shows varying estimated effectiveness values for WCCP, asset inspection, HTMP, expanded pole brushing, and expanded line clearing. All these mitigations work together to reduce the risk of vegetation contact causing a fire. For example, though CC addresses vegetation making contact with wires, line clearance and HTMP activities are also necessary to reduce heavy branches or trees falling into lines that CC may not be able to withstand. Asset inspection work assures equipment is in good condition, covers are in place, and if abnormalities are found, these are scheduled for remediation. These inspections also identify where vegetation may be in contact with equipment and conductors. While CC has shown, in the field, that there are times where it can withstand a large limb / tree fall-in and not create an outage and/or ignition, CC is not designed to withstand tree fall-ins. As such, and for purposes of this illustration, it is assumed these two mitigations do not overlap. Using the formula, described above, these two mitigations have an estimated combined mitigation effectiveness of approximately 90% $(1-(1-71%)*(1-64%))$. Asset inspections, expanded pole brushing, and expanded line clearing all have overlaps with CC for mitigating vegetation contact and thus require separate analyses. For purposes of this illustration, we assume these mitigations provide an approximate 9% incremental effectiveness for reducing vegetation contact risk. Combining all these values provides an estimated approximately 99% effectiveness value for risk of vegetation contact when all five mitigations are deployed on the same circuit / circuit-segment.

Following the same process, Table 7, below, shows the illustrative combined effectiveness values without considering quality control discounts. Additionally, applying the average annual frequency of

historic faults and ignitions for these risk drivers, Table 7 shows the combined weighted average estimated effectiveness value for the selected mitigations.

Table 7: SCE Combined Mitigation Effectiveness Values

Risk Driver Description	Combined Effectiveness	Annual Fault Frequency in HFRA (2015-2020 Avg)	Fault-Weighted Combined Effectiveness	Annual Ignition Frequency in HFRA (2015-2020 Avg)	Ignition-Weighted Combined Effectiveness
Animal contact- Distribution	71%	644	6%	4.8	12%
Balloon contact- Distribution	99%	866	11%	5.0	17%
Other contact from object - Distribution	77%	420	4%	1.7	4%
Unknown contact - Distribution	80%	0	0%	0.0	0%
Veg. contact - Distribution	99%	469	6%	4.7	16%
Vehicle contact - Distribution	82%	550	6%	3.7	10%
Capacitor bank damage or failure- Distribution	92%	382	4%	0.2	1%
Conductor damage or failure - Distribution	85%	2,280	24%	8.3	24%
Switch damage or failure - Distribution	82%	58	1%	0.0	0%
Transformer damage or failure - Distribution	78%	2,334	23%	1.3	4%
Total Estimated Combined Effectiveness			84%		86%

In this illustration, Table 7 shows that when you combine WCCP with asset inspections, HTMP, expanded pole brushing, and expanded line clearing, the combined estimated effectiveness in mitigating faults and ignitions for the selected risk drivers and without discounting is approximately 84% and 86%, respectively.

Understanding the effectiveness of the combination of mitigations can be a helpful guide in utility decision-making. A common framework could also assist in greater comparability across the utilities. Challenges to developing such calculations include data availability, disaggregating effectiveness below the driver/sub-driver level to determine mitigation overlaps, and limitations in a purely formulaic method.

5.3 Next Steps

In 2023, the utilities will meet regularly to discuss methods to determine effectiveness for the combination of mitigations. This will include building on the preliminary framework described above by detailing examples across the utilities. Because many mitigations overlap with one another and can reduce a driver of a risk event differently, the utilities will also discuss and share available data and analytical methods to determine these differences. Additionally, the utilities will explore the process to develop suites of mitigation measures that include new technologies in continuing to evaluate methods to calculate the effectiveness of a combination of mitigations.

6 New Technologies

6.1 Introduction

In the utilities' 2022 WMP Update Action Statements, Energy Safety identified an ACI for all utilities to collaborate to evaluate the effectiveness of new technologies supporting grid hardening and situational awareness such as REFCL and DFA/efd, particularly in combination with other initiatives. The utilities were also ordered to share practices and evaluate implementation strategies and that this effort should be a continuation of the CC study from the 2021 WMP Action Statements, including Energy Safety as a participant. Below, we outline the utilities' approach, information gathered to date, and 2023 milestones to assess the effectiveness of new technologies and share practices and implementation strategies.

6.2 Summary of Approach

The utilities initiated this workstream in Q4 2022 and have since conducted bi-weekly meetings. The initial meetings focused on identifying utility SMEs, discussing types of alternative technologies employed by the utilities, the status of those technologies, effectiveness values, approaches to sharing practices and implementation strategies and how to meet the ACI requirements, timelines/milestones. Evaluating the effectiveness of the technologies in combination with other mitigations is addressed in the scope for the Alternatives workstream, as described in the section above. Based on these initial discussions, it was first decided to document the various alternative technologies the utilities are employing. As seen below, very few technologies are employed across all utilities. The utilities then generally discussed effectiveness values and whether the new technologies can help reduce the impact of PSPS. It was learned that the majority of new technologies are still undergoing investigation and have limited data regarding effectiveness values. The utilities also discussed practices of how the technologies are being employed and learned that where utilities all employ a technology such as disabling reclosing settings, the practices are not all consistent. These areas of focus are further described below along with 2023 plans to conduct regular meetings and workshops focused on specific technologies. Beyond assessing the new technologies, the utilities also plan to document questions for benchmarking with other utilities and discuss any new research and/or other new technologies that the utilities are made aware of.

6.2.1 New Technologies

The utilities have identified 15 new technologies that one or more utilities employ, are piloting, and/or investigating. These include, for example, disabling reclosing settings, fuse replacements, fast curve settings, RAR/RCS, DFA, EFD, REFCL, and OPD. Table 8, below, identifies the new technologies or protection strategies being employed, piloted, and/or investigated to either mitigate wildfire risk and/or reduce the impacts of PSPS.

Table 8: New Technologies by Utility

New Technology / Protection Strategy	SCE	SDG&E	PG&E	Liberty	BVES	PacifiCorp
Fuse replacement (current limiting fuses, expulsion fuses)	Yes	Yes	Yes	Yes	Yes	Yes
Reclosing Settings (Disabling)	Yes	Yes	Yes	Yes	Yes	Yes
Fast curve settings / EPSS / SRP	Yes	Yes	Yes	Yes	No	Yes
Remote Controlled Automatic Reclosers / Remote Controlled Switches (RAR/RCS)	Yes	Yes	Yes	Yes	Yes	Yes
Distribution Fault Anticipation (DFA)	Yes	Yes	Pilot - Moving to Deployment	Investigating	No	Pilot
Early Fault Detection (EFD)	Yes	Yes	Pilot	No	No	No
Rapid Earth Fault Current Limiter (REFCL)	Pilot - Moving to Deployment	No	Pilot	No	No	No
Open Phase Detection (OPD)	Yes	No	Yes	No	No	No
Falling Conductor Protection (FCP)	No	Yes	Pilot	No	No	No
Smart meter (MADEC)	Yes	Yes	Yes	No	No	No
Household Outlet	Pilot	No	Pilot	No	No	No
Sensitive ground fault detection (relays)	Pilot	Yes	Yes	No	No	No
Electrical Grid Monitoring (EGM)	No	No	No	No	Pilot	No
Thor Hammer	No	No	Pilot	No	No	No
Intumescaent wrap / Fire-wrap poles	Yes	No	Yes	No	Yes	Yes

As seen in Table 8, there are only three types of new technology or protection strategies employed by all utilities. These include fuse replacements, disabling reclosing settings, and RAR/RCS. The other technologies are either being deployed, piloted, and/or investigated by a few utilities. Two technologies, DFA and REFCL, are moving from a pilot phase to deployment for PG&E and SCE, respectively. The utilities will further discuss the differences of these technologies to understand overlaps and similarities. For example, OPD and FCP have a similar purpose.

6.2.2 Practices and Implementation Strategies

The utilities have started to share practices for the new technologies. For example, while all utilities disable reclosing settings to mitigate wildfire risk, utility practices vary. For instance, SCE, PG&E and Liberty disable reclosing settings on circuits in HFRA during fire season, SDG&E disables settings, also on circuits in HFRA, but does it year-round, and BVES disables from April to October. The utilities believe that focused meetings and workshops on specific technologies are needed to share practices and implementation strategies. As such, the utilities will conduct focused workshops for specific technologies, as described below, to determine if best practices can be identified and will continue to share practices and implementation strategies in bi-weekly meetings.

6.2.3 Effectiveness Values

In many instances, the utilities are still investigating or have limited data as it relates to effectiveness values. The utilities have documented and shared effectiveness values for a few technologies but have not yet discussed these in detail. For example, effectiveness values for fast curve settings (when

operating) range from approximately 49% to 100% effective at reducing ignitions (based on limited data that is not statistically significant). Given the large range, the utilities will conduct a workshop on the effectiveness of fast curve settings to share data and methods. Additionally, the utilities will discuss whether the technologies help reduce the impact of PSPS. As described in the next steps, the utilities have identified certain technologies for workshops and will continue to document estimated effectiveness values and the potential to reduce PSPS across all technologies.

6.3 Next Steps

In 2023, the utilities will continue to document and assess the estimated effectiveness of new technologies where data is available, their ability to reduce PSPS impacts, and will continue to document and share practices and implementation strategies. These objectives will be accomplished through biweekly meetings and a series of workshops. Based on discussions to date, the utilities provide the following preliminary workshop schedule and themes.

- April 2023 – Disable Reclosing Settings – Discuss practices and effectiveness
- May 2023 – Fast Curve Settings – Discuss practices and effectiveness
- June 2023 – DFA – Discuss implementation strategies, practices and effectiveness
- July 2023 – EFD – Discuss implementation strategies, practices and effectiveness
- Aug 2023 – REFCL Discuss implementation strategies, practices and effectiveness

Once the utilities finalize the workshop schedule, Energy Safety will be invited. Additional workshops may also be scheduled in Q3/Q4 2023. Should the results of the workshops lead to best practices, the utilities will establish plans to implement the changes and document as part of lessons learned.

7 M&I Practices

7.1 Introduction

In the utilities' 2022 WMP Update Action Statements, Energy Safety identified an ACI for all utilities to share and determine best practices for inspecting and maintaining CC, including either augmenting existing practices or developing new programs, to include this effort as part of the Joint IOU Covered Conductor Working Group, and for the IOUs to continue to lead this study and to include Energy Safety as a participant. Below, we outline the utilities' approach, information gathered to date, and 2023 milestones to assess the utilities' CC M&I practices, determine if best practices can be identified, and if best practices can be identified, put in place plans to implement those best practices.

7.2 Summary of Approach:

The utilities initiated this workstream in Q4 2022 and have since conducted weekly meetings. The initial meetings focused on identifying utility SMEs, discussing approaches to determine best practices and how to meet the ACI requirements, and timelines and milestones. Based on these initial discussions, the utilities agreed to a common approach that is both broad and focused. The approach includes first capturing information such as each key utility facts (e.g., service area size in HFRA), types of inspections utilities perform on distribution overhead conductor, general M&I practices for distribution overhead

conductor, specific practices for CC, general and specific training the utilities conduct, and QA/QC information. Capturing broad information such as the types of inspections utilities perform provides a high-level understanding of how each utility performs inspections, the frequency it performs them at, and other related information. In assessing these sets of information, the utilities believe the determination of best practices will require a series of focused workshops and follow up meetings with SMEs, engineers, inspectors, QA/QC personnel and other resources as needed. Focused workshops are needed to facilitate determining if best practices can be identified. For example, all utilities perform ground and aerial inspections which are generally conducted similarly; however, they are not all performed the same way. Determining a best practice relating to performing a ground and/or aerial inspection for CC will require detailed discussions focusing on very specific aspects of the resources that do the work, tools and equipment used, the methods used, and other factors, some of which may only be obtained by conducting field observations across the utilities. It is also important to note that while there are differences in practices, determining best practices can take months, if not years, and that a best practice for one utility may not be a best practice for another utility for reasons such as costs, geographic size of the utility, and resource limitations. Given these facts, the utilities will also document any lessons learned that may be helpful for one or more utilities and can be added to existing M&I practices. Beyond assessing existing practices, the utilities also plan to document M&I-related questions for benchmarking with other utilities, learn from the testing workstream (should any CC inspection and/or maintenance practice be recommended from that workstream), and discuss any new research and/or new technologies that the utilities are made aware of as it relates to CC M&I practices.

7.2.1 Key Distribution Data

The joint utilities vary in size and it is important to consider this information when assessing best practices. Table 9, below, provides a few data points in HFRA, unless as otherwise noted, regarding the utilities’ service area size, the facilities they maintain, and the average number of distribution inspectors. The figures in Table 9 are approximate values.

Table 9: Key Distribution Data by Utility

Key Data in HFRA	PG&E	SCE	SDG&E	PacifiCorp	Liberty	BVES
Distribution Overhead Circuit Miles	25,200	9,600	3,400	813	676	211
Distribution Poles	630,000	290,000	81,000	20,378	23,058	8,860
Square Miles	41,000	14,000	2,600	7,155	938	32
Average Number of Ground Inspectors (Systemwide)	203	153	50	5	4	2

As illustrated in Table 9 above, PG&E has significantly more square miles, distribution overhead circuit miles, and distribution poles in its HFRA to inspect and maintain. Conversely, BVES has the smallest HFRA square miles and least amount of distribution overhead circuit miles and distribution poles to maintain and inspect. As described more below, due to HFRA size alone, a best practice at PG&E may not be an ideal practice for BVES and vice versa.

7.2.2 Types of Distribution Inspections

The utilities perform several types of inspections on distribution facilities. These include detailed ground inspections, aerial inspections, infrared, patrols, Areas of Concern (AOCs) and LiDAR. These distribution inspection types are designed to meet or exceed GO 95 and GO 165, and also to mitigate wildfire risk. Table 10 and Table 11 below highlight the types of distribution inspections the utilities perform.

Table 10: Types of Distribution Inspections performed by SCE, PG&E and SDG&E

Types of Distribution Inspections	SCE	PG&E	SDG&E
Detailed - Ground	Every distribution structure inspected between twice a year and up to once every 3 years, and high-risk structures inspected at least every year; Inspectors on the ground can use binoculars and/or cameras when needed	HFTD: Structures inspected every 1-3 years based on wildfire consequence; Top 10% risk structures inspected every year; Non-HFTD: every 5 years Inspectors use binoculars when needed	Every distribution structure inspected every 5 years
Detailed - Aerial	Every distribution structure inspected between twice a year and up to once every 3 years, and high risk structures inspected at least every year; SCE does 360 degree inspection from ground and the air with the same resources (drone) in the same time period	Will cover ~48K distribution structures in 2023 in the highest wildfire consequence areas; Longer-term plan will be developed based on the learnings from 2023 drone program	Drone inspections are performed on high-risk assets each year; Risk assessment performed annually to determine scope of assets to be inspected that year; Approximately 15,000 structures inspected per year.
Infrared	5,100 distribution overhead circuit miles targeted for inspection in 2023; performed on the ground	Conducted at high risk locations on an ad hoc basis	18,000 structures per year; plus ad hoc based on cause-unknown outages; Combination of aerial and ground
Patrol	100% of above ground and subsurface assets inspected annually; Conducted by ground mostly and helicopter/drone if needed (e.g., access issues)	HFTD: 100% of assets that are not inspected each year Non-HFTD: Based on urban/rural designations	100% of assets inspected annually
Areas of Concern (AOCs)	Additional inspections based on area of concern analysis conducted in late spring / early summer	Additional inspections are performed in areas of concern when needed.	See drone inspections - areas of concern determined by risk assessment and these are performed via drone
LiDAR	In 2023, will evaluate the use of this technology for asset-condition assessments; Historically, used for construction, planning, crew access, vegetation, etc.	Utilized to update pole orientation and associated attributes such as communication line, guy, anchor Database is then leveraged to conduct pole loading assessment to identify overloaded poles for replacement	Only utilized for construction planning purposes

Table 11: Types of Distribution Inspections performed by PacifiCorp, BVES, and Liberty

Types of Distribution Inspections	PacifiCorp	BVES	Liberty
Detailed - Ground	Every distribution structure inspected every 5 years; Inspections on ground use cameras and binoculars	Every distribution structure inspected every 5 years	Every distribution structure inspected every 5 years
Detailed - Aerial	Every distribution structure is inspected every year in Tier 2/3 areas and every 2 years in non-Tier areas; Inspection is performed from the ground with same resources in the same time period	Contractor performs drone inspections yearly with infrared on 100% of 34 kV and 4 kV distribution circuits	No aerial inspections on distribution at this time.
Infrared	Only when requested	100% of 34 kV and 4 kV distribution circuits per year	No infrared at this time
Patrol	100% of assets inspected annually	100% of assets inspected annually	100% of assets inspected annually
Areas of Concern (AOC)	Additional inspections performed when requested	May complete addition patrol inspection during extreme dry day with possible high fire risk	Additional inspections are performed in areas of concern when needed
LiDAR	Not performed on distribution circuits, but has been used in the past for vegetation	Use yearly for vegetation management (Check to see if vegetation is near lines)	Use for vegetation management

As shown in Table 10 and Table 11 above, the utilities perform similar types of inspections. Given the requirements of GO 95 and GO 165, this was to be expected. There are differences, however, in some inspection types as well as in some practices. For example, not all utilities conduct detailed ground inspections on high-risk / high consequence structures (and conductor) every year. Being that the focus of this effort is on CC M&I practices, obtaining findings for CC during these inspections and discussing amongst the utilities will help inform if a best practice can be identified and whether that best practice should and can be applied to all utilities. Similarly, some utilities conduct Areas of Concern (AOCs) inspections and SCE is evaluating LiDAR for asset condition assessments, which has historically been used for vegetation clearances and construction-related purposes. The utilities will discuss these types of inspections, focused on CC, and assess how useful they are in maintaining CC to determine if they should and can be utilized across all utilities.

7.2.3 General M&I Practices

Because utilities have performed inspections and remediation on overhead facilities for decades, the utilities have shared and discussed various aspects of what inspectors look for when assessing the

condition of overhead conductor, regardless if covered or bare (as most assessments for bare will also apply to covered). For example, during detailed ground inspections, inspectors will assess (naked eye and/or binoculars) all components and equipment attached to a pole and any materials connected to conductors. These inspections look for deterioration/corrosion, pitting, damage, clearance issues, sagging, loading, alignment issues (e.g., dead-end covers), misconfigurations, conformance with construction standards (e.g., missing covers/guards), exposed sections for splices, connectors, vegetation in immediate need for remediation, and other abnormal conditions. All of these potential issues apply to bare and CC. In large part, many of the methods and potential issues inspectors look for with bare conductor equally apply to CC. Given this fact, it is important to understand the general M&I practices for overhead conductor that utilities use. The utilities will also explore determining abnormal conditions that could cause a safety or fire ignition risk resulting in remediation and how these are prioritized. Additionally, inspectors that perform this work have understanding and knowledge that can inform the assessment of potential best practices and the utilities intend to include these resources in the workshops. The utilities will continue to discuss and document these practices and prepare for workshops to determine if best practices for CC can be determined.

7.2.4 Specific M&I Practices

This category refers to specific M&I practices for CC. SCE has shared its specific M&I practices which include prompts for data accuracy including types of CC and directions CC is installed, construction standard checks including any missing items such as dead-end covers, connector covers, fuse covers, lightning arrestors and covers, and pothead covers, and identifying abnormal conditions such as visible signs of tracking or damage on the outer jacket. Additionally, in 2023, PG&E updated their Detailed Ground Inspection checklist to include prompts for identifying failure modes that are unique to CC such as CC wire jacket cut into and bare conductor exposed, CC exposed and burnt, and dead-end cover misaligned on CC construction. While other utilities may not have tools that have these specific prompts, as part of their training, they look for visible signs of tracking and/or damage on the covering as well as discoloration. As noted above, the majority of M&I practices for bare conductor apply to CC. Because damage to the outer layer of CC may lead to faults/failures, this is an important inspection assessment all utility inspectors perform. Likewise, all utility inspectors are trained on their CC construction standards and thus assess conformance to the construction standard in the field. Most utilities do not collect asset information for data quality checks as some SCE prompts provide for; however, if deficiencies are noted during other utilities' inspections, they can be submitted through their processes. The utilities will assess these details in workshop settings to determine if best practices can be identified. Field observations may also be conducted to capture additional information.

7.2.5 Training

All utility inspectors are trained to understand CC construction standards and maintenance of CC through new inspector training, refresher training, ad hoc training and/or training conducted by the conductor manufacturer or through industry partners. The large utilities have similar types of training including new inspector training, refresher training, and ad hoc training for changes to standards, materials, etc. that may occur. The small utilities have few inspectors and typically are trained linemen with 20+ years' experience. These inspectors are trained on CC through industry organizations and/or the manufacturer as opposed to through a utility-developed training curriculum. For example, BVES has

two inspectors that are trained linemen with over 20 years' experience. As such, developing a training curriculum for two inspectors may not be cost-effective when alternative training through the manufacturer or industry partner is available. The utilities will continue to collect training information and conduct a workshop to determine any best practices.

7.2.6 QA/QC

All utilities employ a quality assurance / quality check (QA/QC) process for asset inspections as well as construction of CC lines. For example, the large utilities will QA/QC CC as part of their QA/QC program, which are based on sampling methods. BVES and Liberty QA/QC all CC installations. Given the difference in size of utilities, it makes sense that the large utilities use QA/QC sampling methods whereas the small utilities QA/QC all new CC work. The utilities will further discuss and assess each utility's QA/QC practices related to CC in a workshop setting to determine if best practices can be identified.

7.3 Next Steps

In 2023, the utilities will continue to capture general and specific CC M&I practices across the utilities and will conduct workshops to determine if best practices can be identified. Meetings will also be held to follow up on the workshops and set plans to implement any best practices that are identified. Below, the utilities provide a preliminary workshop schedule and themes.

- April 2023 – General conductor and specific CC M&I practices
- May 2023 – General conductor and specific CC Training
- June 2023 – QA/QC of CC
- July 2023 – Recommendations from Testing Results
- Aug 2023 – Inspection Types and Tools Used

Once the utilities finalize the workshop schedule, Energy Safety will be invited. Additional workshops may also be scheduled if needed. Should the workshops lead to best practices, the utilities will establish plans to implement the changes and document as part of lessons learned.

8 Estimated Effectiveness:

8.1 Overview

As explained in the 2022 WMP Update report, each utility's CC programs are different due to factors such as location, terrain, and existing overhead facilities. The utilities also have different frequencies of risk drivers. Additionally, the utilities are still at different phases of installing CC as some have limited miles deployed while others have deployed thousands of miles of CC. These features, amongst others, result in data, calculations, and methods of estimating effectiveness that are different. As such, the utilities have been working on understanding differences and discussing methods for better consistency. In 2022, the utilities focused on testing, recorded effectiveness, and the new requirements. The utilities' continue to estimate CC effectiveness from approximately 60 to 90 percent at reducing outages/ignitions and/or the drivers of wildfire risk.

Below, the utilities describe any updates to their data, analyses, and methods used to estimate the effectiveness of CC to mitigate outages/ignitions and/or the drivers of wildfire risk and present their estimated effectiveness values, and describe next steps to improve consistency of data, calculations and methods.

8.2 Covered Conductor Estimated Effectiveness

8.2.1 SCE

SCE’s Wildfire Covered Conductor Program (WCCP) consists of replacing bare conductor with CC, the installation fire-resistant poles (FRPs) where applicable, wildlife covers (animal safe construction), lighting arresters, and vibration dampers below 3,000 feet. Additionally, in 2022, SCE modified its CC construction standard to include the replacement of open wire secondary or weather-resistant aluminum (OWS or WAL) with multiplex secondary conductors. Weather resistant aluminum wire on the secondary system are outdated technology and will be updated to the new standard when WCCP is installed. Because this standard update will only affect WCCP installations starting in 2024, and not WCCP completed in 2022 or planned for 2023, This activity is not yet accounted for in determining the overall mitigation effectiveness of SCE’s WCCP.

In 2022, SCE assessed the Joint IOU testing results and mapped the test results to risk drivers and sub-drivers to determine if any changes were warranted. Results from the Wire Down Event Scenarios demonstrate that the bare portion of the conductor must be exposed to lead to an ignition. The System Strength Tests demonstrates that tangent structures will not significantly damage the conductor enough to expose the bare conductor. Tangent structures without equipment do not have any exposed bare conductor or taps (~50% of all structures are tangent). As a result, the current mitigation effectiveness of Vehicle Contacts did not account for the performance of CC on tangent structures, therefore SCE increased the mitigation effectiveness from 50% to 82%. SCE also evaluated phase-to-phase contact and simulated wire-down testing. CCs were 100% effective at preventing arcing and ignition in tested scenarios at rated voltage, consistent Exponent’s Phase I field reporting. Per the testing results, adjustments were also made for vegetation contact and unknown contacts. Below, SCE provides the updated estimated mitigation effectiveness for WCCP. Overall, the estimated mitigation effectiveness for WCCP increased from approximately 67% to 72%.

Table 12: SCE Covered Conductor Mitigation Effectiveness Estimate

Driver Type	Sub-Driver/ Consequence Type	% Drivers	Current Driver ME	New Drive ME	Directional Change	Indicative Test Result
D-CFO	Vegetation contact	12%	60%	71%	Increased	Wire Down Events + System Strength
D-CFO	Animal contact	13%	65%	65%	No Change	Wildlife cover test
D-CFO	Balloon contact	13%	99%	99%	No Change	
D-CFO	Vehicle contact	10%	50%	82%	Increased	Wire Down Events + System Strength
D-CFO	Unknown contact	8%	77%	80%	Increased	Aggregate of CFO Result
D-CFO	Other contact from object	3%	77%	77%	No Change	
D-WTW	Wire-to-wire contact / contamination	3%	99%	99%	No Change	
D-EFF	Conductor damage or failure	13%	90%	90%	No Change	Degraded covering
D-EFF	Connection device damage or failure	5%	90%	90%	No Change	
D-EFF	Connector damage or failure	5%	90%	90%	No Change	
D-EFF	Crossarm damage or failure	~0%	50%	50%	No Change	System Strength
D-EFF	Insulator and brushing damage or failure	4%	90%	90%	No Change	
D-EFF	Splice damage or failure	5%	90%	90%	No Change	

8.2.2 PG&E

PG&E's overhead hardening program consists of primary and secondary CC replacement along with pole replacements, replacement of non-exempt equipment, replacement of overhead distribution line transformers, framing and animal protection upgrades, and vegetation clearing. PG&E understands the focus of this request to be centered on CC, however our efforts to estimate effectiveness include all elements of our Overhead Hardening program, which PG&E believes is more complete.

Determining whether a specific event could result in an ignition depends upon a wide variety of factors, including the nature of the event itself and prevailing environmental conditions (e.g., weather, ground moisture level, time of year). As PG&E does not have complete information to make this determination for each event, estimating overhead hardening effectiveness relies upon the following proxy to derive its estimates. Most distribution outages (momentary and sustained) typically involve a fault condition. Thus, for purposes of estimating overhead hardening effectiveness, it is assumed that all distribution outages could potentially result in an ignition, regardless of other prevailing conditions. This approach aligns with what has been previously stated in PG&E's 2020 WMP as well as its 2020 RAMP filing.

In early 2023, PG&E assessed the Joint IOU testing results to re-evaluate the SME effectiveness designations and adjusted the effectiveness in a few key areas. While this is expected to be an ongoing process, we have refreshed our effectiveness values based on updated designations and the data as follows:

- Tree fall-in associated with wire on object, and wire on ground, changed from "none" (not effective) to "medium" (some effectiveness). While other IOUs considered a higher effectiveness than PG&E, there are large enough trees in our service area that can damage CC and as such, CC does not have as substantial an increase in effectiveness.
- Contact from Object Vehicle changed from "none" (not effective) to "medium" (some effectiveness). We agree with other IOUs that this has some limited benefit. Given that we are installing larger poles to support CCs, the larger poles have the potential to sustain more impact from vehicle than existing infrastructure.
- Animal caused outages associated with conductor contact changed from "none" (not effective) to "All" (very high effectiveness). Testing on the covering material of the CCs showed a high resiliency to damage. Also, PG&E found that the insulating properties of the covering did not diminish significantly when damaged. Therefore, we have increased CC effectiveness for mitigating damage caused by animals like squirrels and birds.

Additionally, PG&E has refreshed our data for estimated effectiveness to include outage data through 2022. Previously, the last PG&E update including outage data was from PG&E's 2023 GRC filing, which had data through 2020.

With the above assumptions from the PG&E's 2020 WMP as well as our 2020 RAMP filing, PG&E updated the estimated effectiveness factor for overhead hardening in 2023, incorporating the 2023 re-evaluated SME effectiveness designations:

1. SMEs identified ~80k distinct outages between 2016-2022 by using all known combinations of basic cause, supplemental cause, equipment type and equipment condition from the distribution outage database as show in Figure 9 below. Whenever an outage is reported, an

operator fills in different fields that provide information about the outage. Through SME evaluation, it was decided that a combination of the four aforementioned fields provide an appropriate distinction of different outage types.

Figure 9: PG&E Distribution Outage Database Record

Circuit	182222102	District	Monterey
Type	Unplanned	Customer Minutes	
Customers	297	Weather	Overcast;32-90 F
Active	NO	Fault Type	Force Out
Interval	Sustained	Action Required	No
EquipID	7835	Construction Type	UG
Equipment Type	Fuse	OIS Outage#	927380, 927970, 927929, 927922, 927971, 927921
Equipment Condition	Transformer (UG), Deteriorated	Targets	
Crew Notified Time		Supervisor Notified	
Equipment Address			
Fault Location	AT T1288		
Previous Switching Details			
Action Description			
Cause	Equipment Failure/Involved, Underground	No Access Reason	
Multi Damage Location	No	# of Operations	
Counter Read		Created By	
Outage Level	Distribution Circuit	Last Updated By	
GPS MA Data		Latitude & Longitude	
Fault Location Info		FNL	
Reviewed By	Not Required	End Date	
Actions			

2. Subject matter experts identified whether overhead hardening would eliminate, reduce significantly, reduce moderately, reduce minimally, or not affect the likelihood of a certain type of outage occurring leading to an ignition when an asset has been hardened. From this classification the following qualitative categorization was performed:
 - All = Eliminates likelihood of a certain type of outage occurring resulting in an ignition
 - High = Reduces likelihood significantly of a certain type of outage occurring resulting in an ignition
 - Medium = Reduces likelihood moderately of a certain type of outage occurring resulting in an ignition
 - Low = Reduces likelihood minimally of a certain type of outage occurring resulting in an ignition
 - None = Will not affect the likelihood of a certain type of outage occurring resulting in an ignition
3. Each qualitative category was assigned a quantitative value, which measured the likelihood of outage reduction:
 - All = 90%
 - High = 70%
 - Medium = 40%
 - Low = 20%

- None = 0%
4. The above criteria were applied to historical outages, and this resulted in the likelihood of outage reduction for each outage.
 5. Outages were classified by drivers. The outage drivers identified were: Animal, D-Line Equipment Failure, Environmental/External, Third Party, Vegetation. The Wildfire Mitigation driver was excluded as it captures all PSPS triggered outages.
 6. A Pivot table was then created to aggregate Outages in HFTD. The aggregation was done at the outage driver level and the result are shown below in Table 13.

Table 13: PG&E Covered Conductor Mitigation Effectiveness Estimate

Driver	Average Yearly Count of Incident ID	Average of SH_Effect_Pct
Animal	429	75%
D-Line Equipment Failure	2,233	69%
Environmental/External	255	42%
Third Party	397	57%
Vegetation	2,735	62%
Grand Total	6,049	64%

Based on the latest update using outage data through 2022 and repeating the process from PG&E’s 2020 WMP filing, the updated estimated effectiveness is 64% where Overhead Hardening has been completed. Therefore, a section of a line that has been hardened is approximately 64% less likely to have an outage of any type. Similarly, a section of a line that has been hardened is approximately 64% less likely to have an outage of each of the drivers. This result is consistent with the previous results that were completed using data for the 2020 WMP.

8.2.3 SDG&E

SDG&E initially began to examine CC from a personnel safety and reliability standpoint. The three-layered construction showed prospective reduction of injuries to people in the event of an energized wire-down in which the wire contacted a person and/or also might reduce the step potential to people in the vicinity. Outages that result from light momentary contacts (i.e. mylar balloons, birds, palm fronds) also have shown the potential to be reduced. In late 2018, focus was shifted towards using CC as an alternative to SDG&E’s traditional overhead hardening program with the primary focus of reducing utility-caused ignitions.

SME’s conducted research on the history and use of CC in the industry. Additionally, the SMEs reached out to utilities on the East Coast and internationally to receive their feedback of the effectiveness and work methods for installation purposes.

In addition to other studies/tests that have been and will be performed by SCE and PG&E, as described in the Testing section, SDG&E will have a third-party evaluate the likelihood and effect specific to conductors clashing at various wind speeds. Accelerated aging studies will also be performed to mimic a

40-year service life; after which, the samples will be subjected to tests designed to understand the potential for both mechanical degradation, as well as reduction in dielectric strength. These tests will be performed in accordance with ASTM or other industry recognized standards. Final reports for this testing are expected to be completed in April 2023.

In order to quantify the risk reduction of wildfires that would be achieved by CC, SDG&E evaluated 80 events that resulted in ignitions. SMEs weighed in on the likelihood that CC installation would prevent an ignition for the particular type of outage depending on the severity of the incident. As seen in Table 14 below, the result is a reduction in ignitions from 60 to 20.6, and a resulting effectiveness estimate of 65.7%.

In 2022, SDG&E has been participating in collaborating with other utilities as part of the Joint IOU working groups in the evaluation of the testing that has been and is currently still being performed. Once all testing has been completed in 2023, SDG&E will perform an analysis based on risk drivers to re-evaluate the estimated efficacy of CC.

Table 14: SDG&E Covered Conductor Mitigation Effectiveness Estimate

Fault/Ignition Cause	Number of Ignitions	SME Effectiveness	Post-Mitigation Ignitions
Animal contact	7	90%	0.7
Balloon contact	9	90%	0.9
Vegetation contact	2	90%	0.2
Vehicle contact	8	20%	6.4
Other contact	3	10%	2.7
Other	4	10%	3.6
Equipment - All	26	80%	5.2
Unknown	1	10%	0.9
Total	60	65.7%	20.6

Table 14 above was updated with the number of ignitions occurring between 2017-2021 compared to last year’s report that was based on 2016-2020 data. Updates to SDG&E’s overall effectiveness methodology are anticipated to be completed by December 2023.

8.2.4 PacifiCorp

Prior to development of the WMP, PacifiCorp historically pursued CC designs and systems due to historical experience with elevated outage count from trees, limbs, and incidental contact (resulting in grow in) throughout its service area. Additionally, access conditions on some of its circuits are extremely difficult in certain times of the year, and those circuits also tend to have elevated outage rates. For the above-mentioned reasons, when siting its historic CC pilot projects, PacifiCorp tended to focus its deployment on circuit-segments that had above average vegetation and/or animal outage rates in conjunction with difficult access. Now, as part of the company’s line rebuild program to install CC and mitigate wildfire risk, PacifiCorp is actively pursuing both CC and spacer cable systems. Most projects

completed so far as part this program have leveraged a spacer cable system, which primarily includes CC, a structural member (messenger), and specialized attachment brackets. Therefore, the effectiveness examples and estimations were determined for spacer cable.

As an example of how to assess the effectiveness of newly installed spacer cable, PacifiCorp compared two circuits, one with bare wire and one with spacer cable installed. Both circuits are in the same general geographic area and shown in Figure 10 below. Additionally, the circuits are in a HFTD, with the spacer cable partially located in a tier 3 area near Mt. Shasta and the bare conductor located completely within a tier 2 area, though it is still located within a few miles of the tier 3 boundary.

Figure 10: PacifiCorp Map Showing the Two Circuits Plotted with the HFTD Overlay

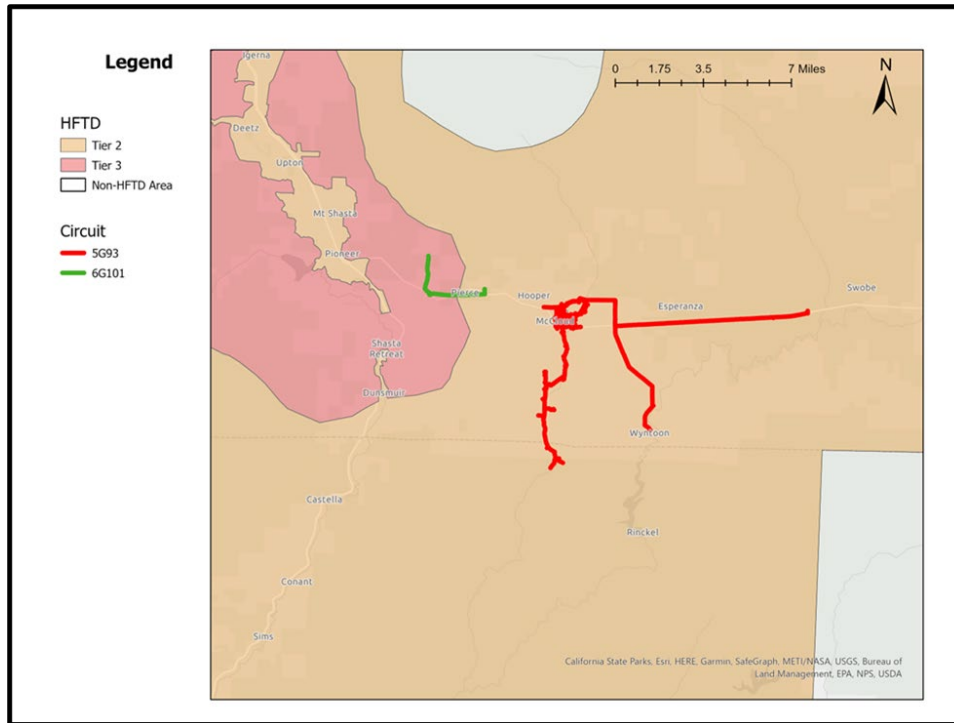

To begin characterizing outage frequency variation prior to and after the installation of spacer cable, 18 years of outage data (2005-present) for both circuits was reviewed and is summarized in Table 15, below.

Table 15: PacifiCorp Outage Frequency for Bare Wire and Spacer Cable Circuits (2005 – present; Asterisk (*) indicates the year spacer cable was installed)

Year:	Outages - Bare Wire Circuit:	Outages - Spacer Cable Circuit (Q4 2021):
2005	8	0
2006	6	2
2007	2	2
2008	10	10

Year:	Outages - Bare Wire Circuit:	Outages - Spacer Cable Circuit (Q4 2021):
2009	0	0
2010	6	12
2011	42	18
2012	6	4
2013	10	2
2014	2	0
2015	2	2
2016	2	2
2017	2	4
2018	0	0
2019	4	2
2020	4	0
2021	2	4 *
2022	8	0
2023	4	0

Generally, the data demonstrates that outage frequency can significantly vary year over year. Additionally, in this example, the bare wire circuit has historically experienced either an equivalent or higher frequency of outages than the circuit the spacer cable was installed, except in 2010. While many factors can impact outages and reliability, this general trend is expected given the significant differences in circuit length. This same data was then normalized based on circuit mile and summarized in Table 16 below.

In Table 15 and Table 16, the data generally shows that for the spacer cable installation (completed in Q4 2021), there was a reduction in outages in all years following the rebuild project (0 for 2022 and 2023 so far). Additionally, the nearby bare wire circuit experienced a total of 12 outage events in 2022 and 2023 (as of January 2023). While certainly not conclusive or representative of a clear trend, the data does support that potential impact spacer cable can have on outage frequency.

A further analysis into outage causes for each circuit at the time of spacer cable installation was performed and included in Table 16 below. The table shows the spacer cable experienced 0 outages in 2022 and 2023 (as of January 2023) for all risk drivers. However, for the bare wire circuit, there was a total of 12 outages across all risk drivers, with trees being the main driver in 2022.

Table 16: PacifiCorp Risk Drivers for Bare Wire and Spacer Cable Circuits (2021 – present; Asterisk (*) indicates the year spacer cable was installed)

Year:	Risk Drivers:	Bare Wire Circuit:	Spacer Cable Circuit (Q4 2021):
2021	TREES	2	0 *
2021	LOSS OF SUPPLY	0	4 *
2022	TREES	4	0
2022	INTERFERENCE	2	0

Year:	Risk Drivers:	Bare Wire Circuit:	Spacer Cable Circuit (Q4 2021):
2022	PLANNED	2	0
2023	TREES	2	0
2023	WEATHER	2	0

While promising, this analysis is neither conclusive nor representative of a clear trend. Additionally, this individual analysis may not be representative of macro trends. The circuit that has the spacer cable is installed on only 6.1 miles which serves only 12 customers and has been in place since Q4 2021. Furthermore, PacifiCorp believes that determining the long-term effectiveness of CC, both in its ability to reduce wildfire risk and PSPS impacts, requires additional data and time. At a minimum, a longer history of outage data would be necessary to fully understand the impacts of the spacer cable.

8.2.5 BVES

BVES has approximately 211 circuit miles of overhead conductor between 34.5 kV and 4.16 kV in its system. BVES started a CC pilot program in Q2 2018 and completed it in Q3 2019 using two different types of cover conductor wires (394.5 AAAC Priority wire and 336.4 ACSR Southwire). Then BVES started the cover conductor WMP in late 2019 with a plan to cover 4.3 circuit miles on 34.5kV over the next 5 years and 8.6 circuit miles on 4.16 kV over the next 10 years. As of the end of Dec. 2021, BVES has covered approximately 21.1 miles between its 34 kV and 4 kV systems. BVES' average span length is approximately 150 feet and installing CC on cross arms. As part of its CC program when there are spliced locations, BVES installs premade cold shrink kits (3M) and installs avian protection (raptor protection/wildlife guard).

Based on benchmarking with other utilities' estimated effectiveness against ignition risks, discussions with its CC supplier, and the short amount of time that it has installed CC, BVES continues to believe that the estimate of effectiveness on ignition risk drivers in its service area is approximately 90%. As BVES installs more CC and gathers more historical data, it will continue to assess the estimate of effectiveness. BVES presents its estimated effectiveness in Table 17 below.

Table 17: BVES Covered Conductor Mitigation Effectiveness Estimate

Ignition Risk Driver	Percent Reduction	Discussion (Contacts on Cover Conductor cable)
Vegetation Contact	90% +	Vegetation contact on 1, 2, 3 phase and/or neutral wire.
Animal Contact	90% +	Animal contact on 1, 2, 3 phase and/or neutral wire.
Balloon Contact	90% +	Balloon contact on 1, 2, 3 phase and/or neutral wire.
Wire down contact	90% +	Due to the following: tree/tree limb fallen on line, car hit pole, wind gust, etc.
Vehicle Contact	90% +	Vehicle Contact due to wire down on vehicle.
Wire to Wire Contact	90% +	Due to the wind gust forces causing tree/tree limb fall on line or just wire to wire contact.

Ignition Risk Driver	Percent Reduction	Discussion (Contacts on Cover Conductor cable)
Splice location contact	90% +	BVES installs Avian protection/raptor protection/wildlife guards and uses premade cold shrink kits (3M) on splice locations.
Vandalism/Theft	90% +	In BVES' service area there is a low risk of conductor theft as well as vandalism. If vandalism occurs, Ex. damage from "gunshot" to the conductor covering installed.
Lightning Contact	90% +	During raining seasons, sometimes encounter a good amount of lightning strikes in BVES' service area. BVES using priority covered conductor (flame resistant) cable.
Third Party	90% +	Third party including contact from joint use, boom arms, etc. should be mostly mitigated with covered conductor cable.
Flame Propagation along the covered conductor	90% +	Caused by Lightning or other.
Flame particle dripping	90% +	Caused by Lightning or other.

8.2.6 Liberty

The CC mitigation estimated effectiveness values for the various ignition risk drivers in 2023 remain unchanged from values in Liberty's 2022 WMP report update. The estimated effectiveness ranges from 95% for vegetation contact risk driver to 15% for lightning risk driver.

8.3 Next Steps

As detailed above, the utilities estimate the effectiveness of CC between approximately 60 and 90 percent. In 2023, the utilities will continue to meet on a regular basis to discuss estimated effectiveness methods, data and calculations. The utilities will learn from the testing, and recorded results and collaborate to improve each utilities' understanding and approach to estimate effectiveness. The utilities will also discuss opportunities to align data and methods for greater comparability and will document any lessons learned.

9 PSPS

9.1 Introduction

In the 2022 WMP Update report, the utilities described their general PSPS approach and how a CC system can reduce PSPS impacts, and provided an assessment of alternatives and their ability to reduce PSPS impacts compared to CC. As described in the 2022 WMP Update report, only SCE has increased PSPS thresholds for fully-isolatable circuit-segments that are covered in comparison to bare conductor. Other utilities, such as SDG&E, informed that circuits with CC could likely withstand higher wind speed tolerances; however, more real-world experience and studies would be required prior to increasing PSPS thresholds. As SDG&E completes construction and obtains this data, it will inform wind-speed tolerances for PSPS. Below, the utilities describe its efforts to better understand the ability of CC and alternatives to reduce the impacts of PSPS as well as plans for 2023 to further this effort.

9.2 Summary

In 2022, the utilities continued to meet and discuss CC and its ability to reduce the impact of PSPS. No utility made changes, per descriptions in last year's report, to their general PSPS practices and thresholds in 2022. The utilities did discuss studies being considered to further assess CC and other mitigations in their ability to reduce the impact of PSPS. Additionally, the utilities have recently discussed the testing results in relation to reducing the impact of PSPS. For example, SCE described how the testing results can provide boundary conditions/limits that enable more granular analysis. While other data such as improved understanding of local hazards are needed to fully inform of potential changes to PSPS thresholds, the testing results can help enable analyses that could provide additional benefits like changes in PSPS de-energization thresholds. SCE and SDG&E will be conducting studies to investigate different aspects and conditions of CC and local conditions to further inform potential changes to PSPS de-energization thresholds. Additionally, and as identified in the Testing workstream, the utilities will discuss the results of the testing in relation to PSPS de-energization thresholds in the testing workshops.

9.3 Next Steps

In 2023, the utilities will assess new technologies in their ability to reduce PSPS impacts as part of the New Technology workstream. Additionally, the utilities will discuss the testing results to further inform PSPS de-energization thresholds as part of the testing workshops. The utilities will also regularly meet to assess the status of related studies and discuss any changes to PSPS practices. If changes to PSPS de-energization thresholds are made and/or to general PSPS practices, the utilities will document any lessons learned.

10 Benchmarking

In 2021, the utilities benchmarked with utilities around the world to improve its understanding of CC deployment and applications. A survey was sent to over 150 utilities around the globe. In total, 19 utilities participated in the benchmarking survey. The survey consisted of 24 questions that focused on CC usage, performance metrics, conductor applications, and system protection. While a limited number of utilities responded (compared to the outreach), the benchmarking survey provided helpful information on CC deployment and performance metrics. This information supported the utilities understanding of the benefits of CC including reliability and safety improvements and wildfire risk reduction. The utilities did not conduct additional benchmarking outside of this joint IOU effort in 2022. In 2023, the utilities will develop a new survey that accounts for results from the testing workstream, learnings from the M&I best practices and new technologies workstreams, and other information that becomes available. The utilities will deploy a new survey in Q3/Q4 2023. Based on the results of the survey and the collaboration and learnings from the other workstreams, the utilities will look to continue to benchmark over this WMP period.

11 Costs

11.1 Introduction

In the 2022 WMP Update filings, the utilities presented an initial capital cost per circuit mile comparison of installation of CC and described the types of costs incurred, cost accounting methods, and the factors that can drive CC costs higher or lower. The utilities demonstrated that based on each utilities' CC / system hardening program, costs are relatively comparable taking into account each utilities' resources, scope, and operational constraints. Since the 2022 WMP Update, the utilities have continued to meet and discuss CC unit costs and undergrounding unit costs. Below, the utilities provide an updated CC capital cost per circuit mile, initial undergrounding unit costs, and plans for 2023.

11.2 Updated Covered Conductor Capital Cost Per Circuit Mile

The utilities have prepared an updated capital cost per circuit mile comparison of the installation of CC. To construct this unit cost comparison, the utilities used the same six cost categories presented in the 2022 WMP Update filings including labor, material, contract, overhead, other, and financing.⁶ These cost categories are intended to capture the total capital cost per circuit mile of CC installations. For purposes of this report, the utilities obtained recorded and/or estimated costs for construction that occurred during 2022. Table 18, below, shows the current CC capital unit cost per circuit mile comparison across the six utilities.

Table 18: IOU Comparison of Covered Conductor Capital Costs Per Circuit Mile

Cost Components	SCE		PG&E		SDG&E		Liberty		PacifiCorp		BVES	
	Cost per Circuit Mile	%	Cost per Circuit Mile	%	Cost per Circuit Mile	%	Cost per Circuit Mile	%	Cost per Circuit Mile	%	Cost per Circuit Mile	%
Labor (Internal)	\$ 9,000	1%	\$ 130,000	16%	\$ 321,000	22%	\$ 117,000	10%	\$ 18,000	2%	\$ 18,000	2%
Materials	\$ 132,000	19%	\$ 151,000	18%	\$ 84,000	6%	\$ 73,000	6%	\$ 218,000	28%	\$ 360,000	49%
Contractor	\$ 383,000	56%	\$ 394,000	48%	\$ 303,000	21%	\$ 857,000	70%	\$ 446,000	57%	\$ 300,000	41%
Overhead (division, corporate, etc.)	\$ 141,000	20%	\$ 140,000	17%	\$ 355,000	24%	\$ 163,000	13%	\$ 50,000	6%	\$ 60,000	8%
Other	\$ 14,000	2%	\$ 3,000	0%	\$ 317,000	22%		0%	\$ 25,000	3%		0%
Financing Costs	\$ 9,000	1%	\$ 8,000	1%	\$ 71,000	5%	\$ 10,000	1%	\$ 21,000	3%		0%
2022 Total	\$ 688,000	100%	\$ 826,000	100%	\$1,451,000	100%	\$ 1,220,000	100%	\$ 777,000	100%	\$ 738,000	100%

As illustrated in Table 18, the 2022 CC capital cost per circuit mile ranges from approximately \$688 thousand to approximately \$1.45 million. While not a true comparison, because the figures are in

⁶ Labor represents internal utility resources, such as field crews, that charge directly to a project work order. Materials include conductor, poles, etc. that get installed as part of a project. Contract represents all contractors, such as field crews and planners, and consultants utilities use as part of their CC programs. Overhead represents costs, such as engineers, project managers and administrative and general, that get allocated to project work orders. Other represents costs such as land fees, permit fees and costs not assignable to the other categories. Financing represents allowance for funds used during construction (AFUDC) which is the estimated cost of debt and equity funds that finance utility plant construction and is accrued as a carrying charge to work orders.

nominal dollars, the 2022 unit cost range is similar to the 2021 unit cost range of approximately \$565 thousand to approximately \$1.5 million. As discussed in the 2022 WMP Update report, the capital cost per circuit mile for CC can vary due to multiple factors such as type of CC system and components installed, terrain, access limitations, permitting, environmental requirements and restrictions, construction method (e.g., helicopter use), amount of poles/equipment replaced, degree of site clearance and vegetation management needed, and economies of scale. Below, the utilities describe any changes to their cost make-up and the factors that contribute to the cost changes from 2021.

11.3 Initial Undergrounding Capital Cost Per Circuit Mile:

PG&E, SCE and SDG&E have prepared an initial capital cost per circuit mile comparison of the conversion of overhead conductor to underground. Liberty and BVES are not installing undergrounding as part of their wildfire mitigations. PacifiCorp has only installed one half of a mile so does not have sufficient recorded data to add; however, PacifiCorp is installing undergrounding projects over this WMP period and thus unit cost data will be assembled once more undergrounding is installed. Similar to the construction of the CC unit cost comparison, the utilities organized their capital costs (and/or estimates) into the same six cost categories. These cost categories are intended to capture the total capital cost per circuit mile of undergrounding. For purposes of this report, the utilities obtained recorded and/or estimated costs for construction that occurred during 2022. Table 19, below, shows the initial undergrounding capital unit cost per circuit mile comparison across the three large utilities.

Table 19: SCE, PG&E and SDG&E Comparison of Undergrounding Capital Costs Per Circuit Mile

Cost Components	SCE		PG&E		SDG&E	
	Cost per Circuit Mile	%	Cost per Circuit Mile	%	Cost per Circuit Mile	%
Labor (Internal)	\$ 25,000	1%	\$ 231,000	9%	\$ 45,000	2%
Materials	\$ 417,000	19%	\$ 271,000	11%	\$ 165,000	7%
Contractor	\$ 1,201,000	56%	\$ 1,665,000	66%	\$ 1,754,000	71%
Overhead (division, corporate, etc.)	\$ 438,000	20%	\$ 247,000	10%	\$ 417,839	17%
Other	\$ 35,000	2%	\$ 63,000	3%	\$ 14,654	1%
Financing Costs	\$ 29,000	1%	\$ 31,000	1%	\$ 77,756	3%
Total	\$ 2,145,000	100%	\$ 2,508,000	100%	\$ 2,474,739	100%

As illustrated in Table 19, the 2022 undergrounding capital cost per circuit mile ranges from approximately \$2.03 million to approximately \$2.51 million. The capital cost per circuit mile for undergrounding across the three utilities is remarkably consistent given that undergrounding costs typically have a much larger cost range than CC. Similar to CC, undergrounding costs vary due to multiple factors such as type of undergrounding system and conductor, terrain, access limitations, route changes, permitting, environmental requirements and restrictions, construction methods, and economies of scale. Below, SCE, SDG&E and PG&E describe the make-up of their undergrounding capital costs and the factors that contribute to the cost differences.

11.3.1 SCE

11.3.1.1 CC Unit Cost Make Up

The 2022 CC costs are based on work completed in 2022. Some projects completed in 2022 have incurred costs from prior years. SCE's unit cost is based on the average cost of nine different regions within SCE's service area. SCE's unit costs are typically presented as direct costs only (exclude corporate overheads and financing costs). For purposes of this report, SCE has added corporate overheads (to the overhead cost category) and financing costs to its direct unit cost for comparison with the other utilities. SCE continues to use two CC designs, a 17 kV and 35 kV CC with multiple ACSR and copper conductor sizes.

In 2022, SCE did make a change to its WCCP construction standard by adding the replacement of open wire secondary or weather-resistant aluminum (OWS or WAL) with multiplex secondary conductors; however, this change is not anticipated to show up in the unit costs until 2024. No CC projects completed in 2022 included replacement of secondaries. SCE estimates, on average, replacing secondaries will cost approximately \$60 thousand per circuit mile.

11.3.1.2 CC 2022 Cost Changes:

Using the nominal amounts of the 2021 and 2022 unit costs, SCE experienced an approximate 16% increase. The primary drivers of this increase include a combination of a larger percentage of work in the Rural region, e.g., the Arrowhead District, and contractor rate increases. Work in higher elevations in rugged areas tend to take longer, increasing contract labor costs. This increase coupled with higher contractor rates were the main cost drivers. Additionally, SCE experienced material and supply price increases. Also, in 2022, SCE began to use SCE labor in some regions.

11.3.1.3 Undergrounding Cost Make up

The 2022 undergrounding costs are based on work completed in 2022. Projects completed in 2022 have incurred costs from prior years. SCE's unit cost is based on approximately 14 miles of undergrounding. The 14 miles of undergrounding had a low level of difficulty and did not include secondaries or services.

A low difficulty level means the terrain was relatively flat, there was less civil construction due to existing infrastructure, and there were none to minimal re-routing required. SCE anticipates higher costs in future unit cost assessments because the projects will have a mix of low to high difficulty.

11.3.1.4 Undergrounding Cost Drivers

For undergrounding projects, SCE leverages its Integrated Wildfire Mitigation Strategy consequence model, which defines the most severe locations in SCE's HFRA. These are locations that meet one or more of the following characteristics: 1) egress constrained, 2) burn-in buffer, 3) 10,000+ acres burned at 8 hours, 4) extreme high wind areas, and 5) communities of elevated fire concern. The costs to underground in these areas can vary significantly. Below, SCE describes several cost drivers that could lead to increased costs.

Construction – in various types of terrain, geography, topography, and population density. Different levels of difficulty in construction can significantly impact the costs. For example, a low difficulty level project that includes straight/minimal bends and minimal re-routing will likely be a lower cost compared

to a high difficulty level project, which can have rocky, hilly terrain requiring significant re-routing. Additionally, any unanticipated changes in design after release can impact costs. For example, sometimes, during construction, a trench is not able to be constructed due to other infrastructure already there (an outcome of outdated basemaps). In this type of circumstance, the planning department would re-design the route including seeking agency feedback which would take additional time to complete and impact schedule and costs.

Permitting and environmental clearances – acquiring permits, resolving land rights and agency requirements, and curing cultural discoveries can be a lengthy process. The number of permits, the types of permits, the amount of land right issues that need to be resolved, and the types of cultural discoveries can increase the costs of a project.

Labor type and resource availability – Both civil crews and QEW electrical crews are required and using internal SCE labor versus contract labor may impact costs.

Additionally, delays can occur due to weather (e.g., rain/snow, RFW days, etc.), supply chain constraints, permit requirements, and environmental constraints (e.g., nesting birds), which can also increase costs.

11.3.2 PG&E

11.3.2.1 CC Unit Cost Make Up

PG&E's unit cost analysis is based on completed projects. Projects are defined by circuit and span. Costs are recorded using SAP software. Of the 335 miles used to analyze the unit cost, these were projects that were marked completed in 2022. Some of the mileage may have been constructed in previous years. Five of the miles were fire rebuild, which typically have a lower unit cost. 329 miles completed were regular system hardening work and one mile was classified as other.

Costs were organized per the six main categories agreed upon with the other utilities. 200 miles were constructed using external crews, categorized as Contract and 135 miles were constructed using Internal labor, categorized as Labor.

PG&E's Overhead Hardening (CC Installation) scope achieves risk reduction through these foundational elements: bare primary and secondary conductor replacement with covered equivalent, pole replacements, non-exempt equipment replacement, overhead distribution line transformer replacement, framing (composite crossarms and insulators) and animal protection, and vegetation clearing.

11.3.2.2 CC Cost Drivers:

PG&E's CC installation costs are driven by these key contributors:

1. Pole replacement – nearly 100% of the poles require replacement due to the additional weight/sag of the new CC.
2. PG&E incorporates numerous initiatives into a single hardening project. Non-exempt equipment and ignition component replacement impacts the cost by including the material and labor installation cost of the new equipment where it requires replacement.
3. Vegetation clearing in support of the new overhead line can be a significant cost added to these projects. Both the increased height of the poles, the widened cross-arms, and the increased sag

of the line can vary the cost considerably. This cost alone can add between \$50k to \$400k per mile depending on the terrain and the location of the line. The rural nature of much of the high-risk HFTD infrastructure drives this need.

11.3.2.3 CC Cost and Impact Driver changes for 2022

For PG&E, unit costs have steadily decreased for the Overhead System Hardening program, that includes CC, into 2022. Major cost drivers include a decreased volume of vegetation impacts on overhead hardened lines and unit cost RFPs (request for proposals) to stabilize contract pricing.

It is likely that these unit costs have mostly leveled off and will only increase due to inflation and economic pressures as this program continues.

Continued costs for PG&E are labor costs, both internal and external (contractor) costs.

For impact drivers to CCs, PG&E is continuing to utilize a combination of undergrounding and microgrids as the primary system hardening effort to reduce wildfire risks. Where these efforts are less feasible, PG&E may use CC as a wildfire mitigation tool for Overhead System Hardening. As PG&E continues undergrounding efforts and finds additional areas that are prohibitive to the undergrounding program, PG&E may increase CC use for those specific areas.

11.3.2.4 Undergrounding Cost Make up

PG&E's unit cost analysis is based on completed projects with costs recorded in our SAP software. Of the 76 miles used to analyze the unit cost, these were projects that were marked completed in 2022. Some of the mileage may have been constructed in previous years, 46 of the miles were fire rebuild, which typically have a lower unit cost, and 30 miles completed were regular system hardening work.

Costs were organized per the six main categories agreed upon with the other utilities, 53 miles were constructed using external crews, categorized as Contract, and 23 miles were constructed using internal labor, categorized as Labor.

11.3.2.5 Undergrounding Cost Drivers:

In executing the System Hardening program, PG&E first uses a scoping criterion that identifies the highest risk areas, and then selects the appropriate risk mitigation approach for that circuit which may include undergrounding, remote grid installation, line removal, or overhead hardening (depending on the local circumstances). Since late 2021, PG&E has prioritized undergrounding as the preferred approach to reduce the most system risk. Once a circuit is selected for undergrounding, PG&E evaluates each proposed circuit segment quantitatively and qualitatively to mitigate the maximum amount of risk and evaluate feasibility and executability. Potential cost drivers can include:

- Existing infrastructure (e.g., water, natural gas, and sewer/stormwater drainage systems, bridges, streetlights, SCADA communications, number of services and transformers, community traffic and access impacts)
- Major execution dependencies (e.g., land rights, environmental permitting, requirements for future road widening, paving plans, or moratoriums by local governments)
- Land and environment considerations (e.g., accessibility for ingress and egress of areas, waterway crossings, sensitive species habitats, land rights and easements, tribal lands, steep gradient, hard rock, tree density)

- Community and Customer Considerations (e.g., cultural considerations, community, and customer impact)

Any of the above considerations may create delays or complexities that can impact the scope, cost, and schedule of undergrounding projects.

Furthermore, undergrounding projects are executed in multiple stages once the circuit segment has been identified based on the criterion described above for undergrounding:

1. **Scoping:** Identifying the proposed route of undergrounding the electric distribution lines, including gathering base map data (e.g., LiDAR and survey data of the expected route) and identifying any long lead time dependencies (e.g., land acquisitions, environmental sensitivities and permits). Scoping includes breaking out planned circuit segments into smaller, more manageable projects. Scoping is the first step necessary to provide visibility to the construction feasibility and possible execution timing.
2. **Designing/Estimating:** Designing the specific project to determine trench location, connection points, equipment details, materials needed, and all related details, such as circuitry and pull boxes. This design also provides specifics for the land rights needed and the drawings that are submitted for permits. The total project cost, including expected labor and materials, is calculated at this stage.
3. **Dependencies:** During this stage we may need to obtain land rights, environmental permits, construction contracts, encroachment permits from local counties, order long-lead materials, finalize construction cost estimates, and determine the construction schedule. The two longest lead dependencies often include obtaining 1) land rights and 2) environmental permits.
4. **Construction:** Executing the undergrounding takes place in two phases: 1) civil construction and 2) electric construction. Project schedules may be significantly impacted during civil construction for some of the following reasons: unanticipated weather, discovery of hard rock, and detection of unmarked existing utility infrastructure. Once civil construction is complete with conduit and boxes installed, then electric construction resources pull the cable through the conduit, splices segments together and re-connects the customers to the new underground system. Customer input to the timing of re-connection, material availability, weather and other risks can impact the electric construction schedule, as well.

As projects move through each stage, schedule certainty improves. Project schedules can change at any time from project dependencies, which may cause specific projects to move across years. Generally, if a project is not completed during the year that it was originally targeted for completion, it will continue through all the job phases and be completed in a subsequent year.

PG&E works closely with customers, governments, agencies, tribes, and regulatory officials to manage these issues within the program to minimize delays and optimize the efficiency of projects wherever possible.

11.3.3 SDG&E

11.3.3.1 CC Cost Make Up

Each project goes through a six-stage gate process as follows:

- Stage 1 – Project Initiation (duration ~1-3 months)
- Stage 2 – Preliminary Engineering & Design (duration ~6-9 months)
- Stage 3 – Final Design (duration ~3-5 months)
- Stage 4 – Pre-Construction (duration ~1-2 months)
- Stage 5 – Construction (duration ~3-4 months)
- Stage 6 – Close Out (duration ~6-12 months)

The total duration of a project has an estimated duration of approximately 20 to 35 months.

SDG&E's CC per mile unit capital costs is made up of the following six major cost categories:

1. Labor (internal) – directs costs associated with SDG&E full-time employees (FTE), including but not limited to individuals from project management, engineering, permitting, environmental, and land management departments.
2. Materials – estimated costs of material used for construction including steel poles, wire, transformers, capacitors, regulators, switches, fuses, crossarms, insulators, guy wire, anchors, hardware (nuts, bolts, and washers), signage, conduit, cable, secondary wire, ground rods, and connectors.
3. Contractor – estimated costs for construction-related services, including civil construction contractors for pole hole digging, anchor digging and substructures, and street/sidewalk repair; electrical construction for pole setting, wire stringing, electric equipment installation and removals; vegetation management where required including tree trimming or removal, and vegetation removal for poles and access paths; environmental support services including biological and cultural monitoring; traffic control; and helicopter support for pole setting, wire stringing, and removals. SDG&E's contractor costs is an estimated average for both internal and contracted electric construction activities, where contract crews are estimated to account for approximately 50% of the construction costs typically completed in a year starting in 2023 versus the 75% that was in the previous estimate.
4. Overheads – estimated costs associated with contracted services not related to construction including engineering, design, project management, scheduling, reporting, document management, GIS services, material management, constructability reviews by Qualified Electrical Worker (QEW), staging yard leases/setup/teardown/maintenance, and permitting support throughout the entire lifecycle of a project, as well as services related to program management including long term planning and risk assessment.
5. Other – estimated costs associated with indirect capital costs. These costs are estimated to be approximately 22% of direct capital costs that accumulate on a construction work order. This includes administrative pool accounts that are not directly charged to a specific project, including internal labor vacation, sick, legal, and other expenses.
6. Financing Costs – estimated costs associated with the collection of AFUDC when a construction work order remains active. Most SDG&E jobs are active for approximately 6 to 10 months from the time the job is issued to construction until it is fully completed and the collection of AFUDC charges stop.

11.3.3.2 CC Cost Drivers Update

Costs can vary significantly from project to project for a variety of reasons, including engineering and design, land rights, environmental, permitting, materials, and construction. Below is a description of these factors and why the costs can vary from project-to-project.

Engineering & Design

SDG&E collects LiDAR (Light Imaging Data and Ranging) survey data before the start of design and again after construction is completed. During the LiDAR data capture, other data including photos (i.e., ortho-rectified images of the poles and surrounding area, and oblique pole photos), and weather data is acquired. After collection of the raw LiDAR and Imagery data, it is processed to SDG&E's specification and includes feature coding and thinning of the LiDAR data, and selection and processing of the imagery data. The entire process for delivery to SDG&E's specification can take weeks to months depending on the size of the data capture. This LiDAR data capture is used to support the base-mapping, engineering, and design processes (Stage 1 and Stage 6).

Currently, the engineering and design of all CC projects are conducted by engineering and design consultants, and their deliverables are reviewed by a separate Owner's Engineering (OE) consultant to ensure compliance with SDG&E standards and guidelines. At this time, SDG&E does not have the resources to conduct the engineering and design required at this scale of work; however, there are assigned SDG&E full time engineering staff that provide oversight of all engineering and design consultants, including the OE. The engineering component of work relates to the structural analysis, including Power Line Systems – Computer Aided Drafting and Design (PLS-CADD) modeling, foundation calculations, or geotechnical studies. The design component includes the drafting, entering design units into SAP for material ordering and costing system, and building the job packages that are sent to construction. In some cases, one consultant can perform both the engineering and design function, and in others cases an engineering consultant collaborates with a design consultant. In all cases, SDG&E's Owner's Engineer will perform both engineering and design review support. Costs from consultants can vary depending on the size and complexity of the project, and due to various other factors including environmental constraints, land constraints, permitting requirements, or scoping changes that can occur from the start of design and throughout construction. The design stage (i.e., start of design to issuance of job package to construction) typically takes anywhere from six months to two years depending on the size and complexity of the project and the challenges with acquisition of land rights, environmental release, and/or permits. In some cases, our environmental releases cannot be released until we receive the permit from the agency as they may require additional environmental measure to be placed on the work and will need to be outlined in the environmental release.

SDG&E requires every pole be engineered using PLS-CADD software during the design phase and the post-construction phase. This software allows SDG&E to leverage LiDAR survey data (pre- and post-construction) and AutoCAD drawings, and to design the poles, wire, and anchors to meet General Order (GO) 95 Loading (Light and Heavy Loading) and Clearance Requirements, as well as to meet Known Local Wind requirements (e.g., 85 mph and in some cases 111 mph wind). SDG&E also requires its engineering and design contractors who use PLS-CADD software to have a California-registered Professional Engineer review and approve the final PLS-CADD model.

Land and Environmental

SDG&E requires all projects to go through a land and environmental review process at each stage of the design process. These processes are predominantly supported with the help of land management and environmental service consultants but are overseen by SDG&E representatives in each respective department. The land process includes research of our land rights, interpretation, and may include support obtaining the proper land rights when required. Through the land rights design review process, SDG&E determines the land ownership of facilities (e.g., poles and wire) to determine if the scope of work is will stay within existing land rights or if new/amendment land rights would be necessary. These results are shared with the engineering, design, and environmental teams. Once the land rights are determined, environmental performs an assessment, determines the environmental impacts if any, and provides input to the design process to minimize and/or avoid environmental impacts. These land and environmental reviews can drive changes to the design and add time and cost to the project. For example, in many cases, SDG&E does not have the land rights to build the overhead CC design within its existing easement, or in some cases it only has prescriptive rights. In those cases, SDG&E has to amend or acquire the proper land rights, or redesign the project, if possible, to stay within the land and/or environmental constraints. If acquiring or amending land rights is required, this can take weeks to months depending on the property owner (e.g., private, BIA, State, Federal, or Municipality) and the level of change to the existing conditions.

Materials

SDG&E's philosophy with CC, like SCE, is to install it in an open-crossarm configuration. In this configuration, the conductor is self-supporting and attached to insulators on crossarms at the structure. Where connections are necessary, insulation piercing connectors (IPCs) are used to avoid stripping the wire and causing damage to the conductor and negating the need to wrap the connection with insulating tape. SDG&E also requires the use of vibration dampers, where necessary, to mitigate conductor damage due to Aeolian vibration. SDG&E replaces most wood poles to steel, and in some cases replaces existing steel poles if they are not adequate to support the new wire (e.g., inadequate clearance and/or mechanical loading capacity). In many cases equipment is replaced during these reconductor projects if it is older, is showing signs of failure, and/or needs to be brought up to current standards. The reason to replace wood poles with steel is due to several reasons, including the fact steel is more resilient to fires than wood and is seen as a defensive measure, steel is a man-made material and the strength and dimensions are consistent and have much smaller tolerances than wood, and because many of SDG&E's wood poles are over 50 years old. In some cases, SDG&E may also need to relocate the pole line to an area where it is more accessible to build and maintain but will require obtaining a new easement. SDG&E also replaces wood crossarms with fiberglass crossarms, insulators with polymer insulators, and replaces switches and regulators as necessary. For transformers, SDG&E developed specific criteria for replacement. A transformer will be replaced if it is internally-fused regardless of age, if it's greater than 7 years old, if it has visual defects or damage (leaks, burns, corrosion, etc.), is less than 25 kVA, or if the transformer does not pass volt-drop-flicker calculation. SDG&E also replaces secondary wire that is either open (non-insulated) or "grey wire" (covered secondary wire where the insulation is grey in color). On most projects, there is a smaller underground job associated with the overhead work. This typically occurs when a pole feeds underground (aka a Cable or Riser Pole) and the new pole location may be too far from the existing position such that the existing cable, conduit, and terminations may not reach the new pole position. In these cases, a small underground job will be initiated to have the crews intercept the run of underground conduit, install a

new handhole, install a new run of conduit and cable to the new pole location, and splice the cable in the new handhole to make the connection to the existing underground system.

In 2021 and 2022, SDG&E experienced material supply chain issues, with CC materials as well as materials common to bare and CC. These supply chain issues were the result of various factors including impacts from COVID-19. In the case of CC, SDG&E currently sources the conductor from multiple suppliers; however, the associated materials such as piercing connectors and clamp dead-ends come from one supplier out of Europe and experienced significant delivery delays due to COVID-19 and issues with US Customs paperwork in 2021. In 2022 SDG&E had material delays with secondary conductor, 10 ft fiberglass guy strain insulators, transformers, guy grips, and fiberglass crossarms. SDG&E also experienced delays receiving other material due to COVID-19 supply chain disruptions and competition for the same materials used by other utilities including transformers and other materials common to various utilities across the country. Material delays can cause construction delays or cause construction to work less efficiently, thus impacting project schedules and costs. To mitigate material delays SDG&E's engineering and design team, as well as suppliers, work together to provide long term forecasting and ensures materials are ordered with enough lead time to receive the materials in time for construction, and when necessary, substituting material.

Construction

One of the most significant variables, and most difficult to predict, is the civil portion of construction. The civil portion of a project includes the pole hole, anchor, and handhole digging and can vary significantly depending on several factors including accessibility (truck accessible versus non-truck accessible), soil conditions (rock versus soft soil), methods of digging (hand tools versus machine), and environmental constraints that may limit the method of digging or access protocols. For example, a 0.7 miles project completed a couple of years ago was on the side of a steep mountain side and all the material, equipment (pneumatic drill and hand tools), and crews had to be flown in and out every day for months. The civil crews encountered significant rock at most locations and the spoils from the digging had to be flown out due via helicopter to environmental concerns rather than spreading the spoils on location. Each pole and anchor were back-filled with concrete using helicopters because of the slope of the mountain and due to the significant mechanical loading due to winter storms (wind and ice loading). In contrast to this mountain side project example, SDG&E has had other projects that are truck accessible, that do not require concrete backfill and allow the spoils to be spread out on location.

Another reason costs can vary significantly from project to project is due to the time of year and location. SDG&E often deals with elevated fire weather conditions which requires a dedicated fire watch crew to be present at each location where there is work happening that can pose a fire risk. In some cases, SDG&E has multiple dedicated fire watch crews on a project as there may be multiple civil and electric crews working at different locations at the same time on the same project. Some locations are also so remote that the drive time from the staging yard to the site can take a significant amount of time out of each workday that the crew may work longer hours and/or over the weekend, including Sundays, thus increasing overtime hours for the construction crew and all other support services (e.g., traffic control, environmental monitors, etc.). In some cases, generators are used due to the remote nature of some customers and the lack of ties with other circuits in SDG&E's service area. Generators require special protection schemes, equipment, and resources to adequately plan, deploy, setup, monitor, and tear-down which increase the installation costs.

Lastly, construction costs can vary depending on the crew building the project and issues encountered during construction that were not anticipated during design. SDG&E currently uses four primary construction contractors who perform the electrical construction and typically sub-contract the civil work (e.g., pole hole, anchor, handhole digging), helicopter, traffic control and dedicated fire watch. SDG&E also uses internal electric construction teams who typically contract out the helicopter, traffic control, dedicated fire watch and civil work (pole hole and anchor digging). Based on SDG&E's experience with its traditional hardening program, in 2023 it is estimated that 50% of the construction work costs will be performed by contractors and 50% by internal crews. The costs between external and internal crews can vary depending on the work scope, location (rural versus very rural), methods of construction (e.g., truck accessible versus non-truck accessible), time of year (e.g., fire season and non-fire season, and wet versus dry conditions), and issues encountered during construction. Larger projects (typically 20 or more poles) that are not assigned to an internal crew are sent out to bid with the three prime electrical construction contractors and are often bundled with other projects on the same circuit to gain economies of scale. SDG&E has determined that its ideal bid size is 100-200 poles; however, some bids have been significantly greater and some can be much smaller. The size of bids can change significantly depending on the location of a project, time of year, and schedule of the project. SDG&E has seen changes with pricing due to competition for construction resources with the other utilities in the state and this can drive-up costs depending on the volume of work and timing with other projects statewide.

11.3.4 PacifiCorp

11.3.4.1 CC Unit Cost Make Up

For purposes of this comparison, PacifiCorp has again aligned its costs into the six major categories. No changes were made in 2022 related to how costs are organized into the six main categories. PacifiCorp is basing the cost per mile on ten projects totaling about 33 miles of primarily spacer cable. These projects were placed in service during 2022; however, design, material procurement, permitting, and some construction may have taken place prior to 2022.

11.3.4.2 CC Cost Drivers

PacifiCorp has identified eight main cost drivers for the installation of CC. The cost drivers are discussed below in terms of cost increases that have been experienced, highlighting how impactful these components can be on the overall project cost.

Access

PacifiCorp includes costs for required access to facilitate project construction in projects charged to the work order. These costs may include vegetation clearing, road construction, or other site preparation activities. These costs will typically be included in the contractor total for purposes of this cost analysis as this work is predominantly contracted. Additionally, these costs can also range significantly between projects based on the specific location and terrain where work is conducted. Projects that include significant off-road scopes tended to be most impacted, though this is somewhat offset by limited flagging costs.

Pole Replacement:

PacifiCorp evaluates all poles for strength and clearance using PLS CADD on spacer cable projects. Poles are then selected for replacement for the following reasons: insufficient strength to accommodate CC, insufficient minimum clearance, relocation is required, or not constructible in the current state. Projects completed in 2022 averaged 25 poles per mile due to projects with larger conductor sizes, short spans on in-town projects, and two projects designed for double circuits. Additionally, nearly all poles identified are replaced with non-wood fire resistant materials (predominantly fiberglass) at a greater cost than like-for-like replacement with wood.

Construction Labor

In 2022, PacifiCorp continued to receive higher bid prices. Contractors reported needing to include incentives to attract adequate labor to complete projects. Increases in construction labor costs were the single largest driver in project cost increases. As of January 31, 2023, PacifiCorp has awarded approximately one third of the 2023 planned construction work scope and is forecasting that these higher costs will continue.

Post Construction Inspections

In 2022, it was recognized that the total amount of construction exceeded the capacity of internal staff to adequately inspect as the construction was taking place. Based on this, external construction inspectors have been hired to monitor construction, while it is taking place, and complete a formal inspection of each line segment as it is placed into service. While this comes at a higher cost per line mile, it assures that the completed project matches the design. This will be an ongoing addition to project costs.

Permitting

As included in the company's 2021 Change Order, significant cost increases have been experienced for locations requiring access into seasonal wetlands and transmission under build projects. Future projects include environmentally sensitive areas that have been in NEPA or CEQA review with high environmental review costs. Additionally, projects scheduled for completion in 2023 have required cultural monitors for all ground disturbing activities and several re-designs to accommodate changes in current infrastructure layout requested by permitting agencies.

Materials

PacifiCorp experienced material cost increases on most commodity materials in 2022; however, this impact was limited for the group of projects in this analysis as much of the material was on order prior to 2022. Projects scheduled for completion in 2023 are expecting to experience more impact from these cost increases.

Internal Labor and Overhead

Internal labor increased on a per mile basis while overhead costs decreased. This is largely driven by a shift in staff charging directly to projects they are working on rather than an overhead account. These should be viewed largely as offsetting cost shifts.

Design Type

In 2022, PacifiCorp rebuilt approximately 7 miles of overhead distribution lines with CC. While there are many factors impacting the projects overall costs, a cursory review indicates a lower cost per mile as compared to spacer cable, generally attributed to the lower cost of materials, shortened project timeline, and reduction in engineering and design requirements. However, some of these costs are offset by the increase in pole replacements required with using a more standardized product. Based on this one project, PacifiCorp expects that CC could be a cost-effective option in many locations but requires more experience to understand the cost variability.

Based on the cost drivers discussed above, PacifiCorp anticipates higher costs for projects in 2023 and beyond.

11.3.5 BVES

11.3.5.1 CC Unit Cost Make Up

BVES continues to contract out most of the work with an internal Field Inspector overseeing the whole project. The design consists of our contractor performing field visits, wind loading calculations, developing the design and assembling the material lists. BVES purchases the materials and its contractor does the construction. The overhead costs consist of BVES internal groups. The capital cost per circuit mile are based on a double circuits' area in 2022.

11.3.5.2 CC Cost Drivers

CC unit costs decreased in 2022 compared to 2021. A higher percentage of poles were installed which support both 34.4 kV and 4 kV CC lines. These double circuit lines reduce installation and material costs. In addition, the construction crews have gained more experience installing CC and are more efficient.

11.3.6 Liberty

11.3.6.1 CC Unit Cost Make Up

Liberty's CC program is still relatively new and limited in scope compared to the large utilities. Liberty first piloted CC projects in 2020 in select areas that already needed line upgrades because of asset age and condition, and later focused on projects that targeted short line segments in HFTD areas, had reliability issues, and were in remote areas. An average of recent CC projects amounted to less than one circuit mile per project and only a total of 20 miles of CC were installed over the last 3 years. Liberty's CC work is substantially less than, for example, SCE's approximate 1,000+ miles of CC installed each year. Liberty's CC unit costs vary depending on terrain, number of poles replaced, type of conductor installed, project design and permitting requirements, and amount of vegetation management work required for the job order. Liberty used the same cost categories as described in the 2022 WMP Update report and did not make any major changes to its CC program.

11.3.6.2 CC Cost Drivers

Liberty's project life cycle ranges from 18-36 months depending on project scope and permitting complexity. There are many factors that may impact the total project life cycle and costs, including permitting and environmental requirements, easements, geography and terrain, and construction resource availability. Contractor costs for construction in its service area are a major cost driver for

Liberty. Projects typically take longer to construct because of the mountainous terrain and require more costly construction methods like helicopter use and hand digging. Other cost factors include permitting, weather, and environmental restrictions that limit scheduling flexibility and reduce productivity, causing construction costs to increase.

Conductor Type

Liberty has two CC designs that vary depending on project site access and terrain. These include 14.4 kV delta Aerial Spacer Cable (ACS or spacer cable) and CC solutions at this voltage level. In addition, because some of Liberty's service area includes 12.5 kV grounded Wye system, Liberty has piloted the use of CC. Liberty selects the two different system options based on the installation and maintenance of the two solutions.

The ACS solution has two or three covered conductors supported by a steel messenger. The framing for ACS includes brackets that hold the messenger under tension and for the current carrying conductors at full sag or zero tension. Installing and maintaining spacers requires a bucket truck; however, if accessibility is an issue, crews may require a bosun's chair to access the line adding to the costs.

The covered conductor solution includes various sizes of covered wire such as a 1/0, 2/0, or 397 kcmil AAC. The ACS solution projects have installed 1/0 AA wire with 1-052 AWA messenger and 1/0 AAC with 6AW messenger. Covered conductor is installed with framing similar to bare conductor wire in an open-crossarm configuration for framing and installation. CC is the preferred solution in areas with limited bucket truck access. Conductors are sized based on circuit load for both solutions. Wind and ice loading are major concerns in the Liberty service area and do not utilize conductors smaller than 1/0.

Location

A vast majority of Liberty's service area is in HFTD Tier 2 and Tier 3. In the initial phases of its covered conductor program, Liberty selected areas of its service area based on local knowledge of the wildland/urban interface, locations of high fire threat districts, remoteness of overhead lines, and the age and condition of the infrastructure. Areas were also chosen based on their accessibility and egress options during an emergency. Most of Liberty's covered conductor projects are in Tier 2 and Tier 3 at elevations between 6,200 to 7,500 feet over rugged, rocky terrain with limited seasonal access. Projects typically utilize helicopter pole sets, and crews are tasked with digging pole holes with pneumatic tools by hand versus trucks with augers. Pole holes take days versus hours to excavate, increasing labor hours and costs.

Pole and Asset Replacements

Most of the covered conductor projects Liberty has designed and constructed have required a significant number of pole replacements per circuit mile. When replacing existing poles, Liberty uses taller and larger class poles. This is due to new loads and increased weights of the covered conductor, as well as the age of existing infrastructure. Projects include installation of poles, insulators, crossarms, anchors (rock anchors), down guys, transformers, and switches.

Economies of Scale

Liberty has limited contract resources available during its construction period compared to the larger IOUs that have replaced thousands of circuit miles with CC. Liberty's contract costs are higher on a per

mile basis than those of large IOUs, given Liberty's ratio of miles installed as compared to IOUs with significantly more miles installed. This factor has likely contributed to Liberty's higher CC cost per circuit mile.

Construction

Liberty's primary construction window is May 1 to October 15 due to weather and Tahoe Regional Planning Agency (TRPA) dig season restrictions. The construction window also coincides with seasonal tourism, a high number of RFW days, and during the typical fire season that further limits construction efforts and effects costs. These restrictions also constrain resources and add a premium on labor during construction season.

Vegetation Management

Liberty's service area is in a high elevation and mountainous terrain that is densely forested, averaging over one hundred trees per mile within maintenance distance of the conductor, given recent LiDAR data. Vegetation management inspectors and tree crews often need to access work sites on foot while carrying tools and equipment, resulting in much higher labor costs compared to typical work areas. In addition, due to the robust tree canopy in the Tahoe region, tree crew cost per circuit mile of construction has increased significantly due to SB 247 labor rate increases. Tree removals and pruning costs are unique to Liberty's service area and will increase the overall CC project costs.

In 2022, Liberty experienced an approximate 20% decrease in CC costs compared to 2021. This cost decrease was mainly due to Liberty's use of internal construction crews instead of contractors in 2021. Additionally, 2022 projects required fewer helicopter pole sets and less hand-digging than 2021 projects.

11.4 Next Steps

In 2023, the utilities will continue this workstream and further discuss and document CC recorded/estimated unit costs, undergrounding unit costs and cost drivers as well as assess adding initial unit costs for other alternatives. The utilities will also document any lessons learned.

12 Lessons Learned

12.1 Introduction

In the utilities' 2022 WMP Update decisions, Energy Safety identified an ACI for all utilities to provide goals and timelines for implementing lessons learned from the CC joint effectiveness study. Specifically, Energy Safety ordered all utilities to:

- Provide a concrete list of goals with planned dates of implementation for any lessons learned in the CC effectiveness joint study.
- Provide a table indicating which WMP sections include changes (compared to its 2021 and 2022 Updates) as a result of the CC effectiveness joint study. This should include, but not be limited to:
 - Changes made to CC effectiveness calculations.

- Changes made to initiative selection based on effectiveness and benchmarking across alternatives.
- Inclusion of REFCL, OPD, EFD, and DFA as alternatives, including for PSPS considerations.
- Changes made to cost impacts and drivers.
- An update on data sharing across utilities on measured effectiveness of CC in-field and pilot results, including collective evaluation.

As described in the sections above, the utilities are sharing and documenting information and lessons learned, and are driving to understand if best practices, common methods, and greater comparability can be established. Where utilities have made improvements based on this working group, they are described in the sections above. Importantly, consistent with the 2022 WMP Update filings, while not an objective of the working group, the utilities anticipated that there could be lessons to learn from one another such as construction methods, engineering/planning, execution tactics, etc. that could help improve each utilities' deployment of CC. Since the final decisions on the utilities' 2022 WMP Update filings and as part of each workstream meeting, the utilities have discussed whether or not there are lessons learned and if so, documented these and any plans the utilities have to implement those lessons. In the limited time the utilities have had in 2022 to meet this requirement, we have documented a few lessons learned; however, it is important to note that each utilities' CC program (the initial focus of this effort) had been previously established and was based on past benchmarking, research, testing, and lessons learned from other utilities including SCE (see, e.g. the Covered Conductor Compendium), i.e., many lessons learned were already incorporated into each utilities' CC program. Notwithstanding this, and considering the expansion of this working group, the utilities are committed to documenting lessons learned and plans to implement them.

12.2 Lessons Learned

The utilities agree that it is helpful to share information, practices, and data across the utilities as this can lead to improvements in reducing wildfire risk, safety incidents, and the impacts of PSPS, and improvements with other utility objectives. In furtherance of this objective, and given that a simple table cannot provide the information in a readable format with the ACI requirements, the utilities describe their lessons learned for this working group by the required subject areas.

12.2.1 CC Effectiveness Values

Pursuant to the testing results and further analysis, SCE and PG&E modified their estimated effectiveness values for certain risk drivers since its 2022 WMP Update submissions and have implemented these changes. SDG&E refreshed its effectiveness analysis per previous methodology but have not yet incorporated the updated value in its decision making. SDG&E anticipates completing this by December 2023. Based on the other utilities' previous estimates, the testing results, and their own data, no changes to CC effectiveness values were warranted at this time. These changes are described above in the Estimated Effectiveness workstream. The changes to effectiveness values have and are being incorporated into RSE calculations which in turn will feed into the utilities' decision-making processes. These updated RSE calculations will also be incorporated into utilities' future filings such as RAMP, GRC, and as applicable the WMP. If additional changes are made to effectiveness values, the utilities will document those lessons learned.

12.2.2 Data Sharing

An update on data sharing across utilities on measured effectiveness of CC in-field and pilot results, including collective evaluation. The utilities have and continue to share information across all workstreams. During 2022, utilities provided updates on recorded effectiveness. These included presentations and overviews on data, dashboards, and areas of continued improvement. The utilities also discussed their CC efforts including any pilots and shared these experiences.

12.2.3 Inclusion of REFCL, OPD, EFD, and DFA as alternatives, including for PSPS considerations

As described in the New Technologies section of this report, the utilities will discuss and document data and methods that can be used to estimate the effectiveness of these technologies. This workstream is new and the utilities have identified a series of workshops to develop this workstream. To date, the utilities have not documented any lessons learned or changes from 2021 or 2022 for inclusion of new technologies.

12.2.4 Cost Impacts and Drivers

As described in the Cost section of this report, the utilities have provided an updated CC capital cost per circuit mile and document the cost changes and drivers. As explained in last year's report, each CC project is unique and will have different costs. Additionally, there are many factors that can increase costs including, for example, economies of scale, the mix of work across regions and differing terrain, contractor rates, permitting, resource constraints, and environmental restrictions. In 2022, the utilities provided updates with one another on these costs through presentations and overviews including trends, material price changes, and other cost-related information. Please see the Cost section in this report for further details the changes in cost impacts and drivers from last year's report.

12.2.5 Changes made to initiative selection based on effectiveness and benchmarking across alternatives.

The utilities have not made changes to initiative selection based on this joint IOU effort. The data and information compiled has confirmed the utilities understanding that CC is effective at reducing wildfire risk and highly effective at reducing most contact from object and wire-to-wire risk drivers. The testing has also shown CC is effective at reducing other risk drivers as well. Should one or more utilities make changes to initiative selection as a result of this effort, we will document those lessons learned as well as plans to implement them.

12.3 Next Steps

In 2023, the utilities will document all lessons learned across all workstreams and will develop plans to implement those lessons learned, as applicable.

13 Conclusion

This joint IOU report provides descriptions of the progress the utilities have made to better understand the long-term effectiveness of CC and its ability to reduce wildfire risk and PSPS impacts (and, in comparison to alternatives) as well as CC M&I practices, new technologies, and lessons learned. The utilities have made progress on this effort and describe plans for 2023 to conduct a large number of workshops to further understand the data and analyses that have been compiled, identify best practices for CC M&I, assess new technology effectiveness and the sharing of practice and implementation strategies, and discuss methodologies that can be employed across all utilities to improve comparability. The utilities look forward to continuing these efforts in 2023 and providing future updates.

Appendix A: Effectiveness and Implementation Considerations of Covered Conductors: Testing and Analysis

Materials and Corrosion Engineering

Exponent[®]

**Effectiveness and
Implementation
Considerations of Covered
Conductors: Testing and
Analysis**





**Effectiveness and Implementation
Considerations of Covered Conductors:
Testing and Analysis**

Prepared for

Southern California Edison Company
1 Innovation Way
Pomona, CA 91768

Applied Technology Services
Pacific Gas & Electric Company
3400 Crown Canyon Rd.
San Ramon, CA 94583

San Diego Gas & Electric
8316 Century Park Ct
San Diego, CA 92123

Prepared by

Exponent
149 Commonwealth Drive
Menlo Park, CA 94025

December 22, 2022

© Exponent, Inc.

Contents

	<u>Page</u>
Acronyms and Abbreviations	v
Executive Summary	vi
Introduction	1
Background and Motivation	1
Scope	2
Phase-to-Phase Contact Testing	2
Wire-Down Ignition Testing	3
Corrosion Susceptibility	3
Flammability Testing	3
System Strength	3
Conductor Specifications	4
Phase-to-Phase Contact Testing	6
Scope	6
Experimental Setup	7
Test Setup and Equipment	7
Testing Procedure	8
Foreign Objects and Vegetation	9
Ambient Conditions	10
Results	11
Phase-to-Phase Contact Testing—Bare Conductors	14
Phase-to-Phase Contact Testing with CCs—Rated Voltage	15
Extended Phase-to-Phase Contact Testing—Rated Voltage	21
Phase-to-Phase Contact Testing with CCs—Extreme Voltage	24
Sequential Breakdown Testing	31
Discussion and Conclusions: Phase-to-Phase Contact Testing	33
Simulated Wire-Down	35
Scope	35
Experimental Setup	35

Results	37
Discussion and Conclusions: Simulated Wire-Down	40
Corrosion Testing	42
Motivation and Scope	42
Water Ingress Testing	45
Experimental Setup	46
Results	47
Salt Spray Testing	51
Experimental Setup	51
Results	53
Cyclic Polarization Testing	71
Experimental Setup	71
Results	73
Discussion and Conclusions: Corrosion Testing	79
Flammability Testing	80
Motivation and Scope	80
Experimental Setup	81
Results	83
Discussion and Conclusions: Flammability Testing	83
System Strength Testing	87
Scope	87
Experimental Setup	87
Splice Maximum Load Test	87
Insulator Slip Test	90
Full System Tree-Fall Test	92
Results	94
Splice Maximum Load Test	94
Insulator Slip Test	97
Full-System Tree-Fall Test	101
Discussion and Conclusions: System Strength	106
Limitations	107

Appendix A	Methods
Appendix B	Simulated Wire-Down Tests: Additional Figures
Appendix C	Standards and Guidelines
Appendix D	Literature References
Appendix E	SCE Covered Conductor Dead-End Strength Testing
Appendix F	Kinectrics Mechanical Testing Reports

Acronyms and Abbreviations

AAC	all aluminum conductor
AC	alternating current
ACSR	aluminum conductor, steel reinforced
ASTM	ASTM International (formerly American Society for Testing and Materials)
CC	covered conductor
CPUC	California Public Utilities Commission
GO	General Order
ICEA	Insulated Cable Engineers Association
IEEE	Institute of Electrical and Electronics Engineers
IOU	investor-owned utility
IPC	insulation-piercing connector
kcmil	one thousand circular mils (a unit of wire gauge)
kN	kilonewton
kV	kilovolt
mA	milliamp (a unit of current equal to one-thousandth of an ampere)
ms	millisecond
NaCl	sodium chloride
PE	polyethylene
PG&E	Pacific Gas & Electric
RTS	rated tensile strength
SCE	Southern California Edison
SDG&E	San Diego Gas & Electric
UTM	universal testing machine
UTS	ultimate tensile strength
XL-HDPE	cross-linked high-density polyethylene
XL-LDPE	cross-linked low-density polyethylene

Executive Summary

Exponent, Inc. (Exponent) was retained by Southern California Edison as part of a joint effort with investor-owned utilities to independently investigate the effectiveness of covered conductors (CCs) for overhead distribution systems. Our investigation included lab-based testing of 15-kV rated 1/0 aluminum conductor, steel reinforced (ACSR) CC provided by SDG&E, 17-kV and 35-kV rated 1/0 ACSR provided by SCE, 22-kV rated 397.5 kcmil all aluminum conductor (AAC) provided by PG&E, and 17-kV rated 2/0 copper CC provided by SCE (corrosion testing only). Based on our investigation, we have come to the following conclusions:

1. CC effectiveness was evaluated by phase-to-phase contact and simulated wire-down testing. CCs were 100% effective at preventing arcing and ignition in tested scenarios at rated voltages. This is consistent with documented field experience as reported in Exponent's Phase I report.
2. CCs prevented arcing and ignition and limited current flow to less than 2.5 mA in 100% of tested phase-to-phase contact scenarios at rated conductor voltages, which included different types of vegetation, balloons, simulated animals, and conductor slapping.
3. CCs prevented arcing and ignition in 100% of simulated wire-down events in dry brush. Broken conductors and conductors with damage that exposed the underlying metal showed potential for ignition.
4. Thermal testing was performed to understand the impact of a nearby wildfire on CC installations. Results suggested that the heat fluxes and times required for auto-ignition of the polyethylene sheaths were unlikely to be encountered during a surface or low-lying brush fire; however, a canopy fire may be sufficient to cause conductor sheath ignition.
5. Water ingress testing was performed to understand if implementation of CCs introduces a unique corrosion risk relative to bare conductors. Stripped ends of CCs and CCs with insulation-piercing connectors (IPCs) were found to be susceptible to water ingress. While the test conditions were extreme relative to typical service conditions and did not account for potential heating/evaporation in service, water may percolate down the conductor length from a stripped end in some scenarios.
6. Corrosion was observed under the CC sheath near the stripped ends but was not observed under IPCs following salt spray testing. While this indicates that subsurface corrosion is possible near a stripped CC end, subsequent tensile testing showed minimal reduction in total strength of the conductor. Potential water-ingress mitigation measures may help to prevent corrosion in areas where precipitation is likely to collect on the conductor.
7. Mechanical testing was performed to assess the strength of CCs and their associated hardware. Strength testing of splices met or exceeded the rated strengths of the

conductors. In simulated tree-fall conditions and insulator slip tests, vise-top pin insulators exhibited deformation of the metal pin. Clamp-top post insulators exhibited conductor slippage with no apparent signs of damage to the hardware.

Note that this Executive Summary does not contain all of Exponent's technical evaluations, analyses, conclusions, and recommendations. Hence, the main body of this report is at all times the controlling document.

Introduction

Background and Motivation

In 2021, California investor-owned utilities (IOUs) Pacific Gas & Electric (PG&E), Southern California Edison (SCE), and San Diego Gas & Electric (SDG&E) engaged Exponent to investigate the effectiveness of covered connectors (CCs) for hardening of overhead distribution electric lines. During the project, three additional California IOUs joined the effort: Liberty, PacifiCorp, and Bear Valley Electric Service. CCs have gained industry attention due to their potential for mitigating risks associated with public safety, reliability, and wildfire ignition. The initial phase of this investigation (“Phase I”) was a literature-based study of CC performance to better understand the advantages, operative failure modes, and current state of knowledge regarding CCs. The Phase I study included a review of publicly available literature, utility-provided data, and manufacturer information. Additionally, a high-level failure mode identification workshop was conducted to identify any gaps between the current state of knowledge and operative failure modes.¹

The Phase I analysis concluded that CCs are a mature technology and have the potential to mitigate several safety, reliability, and wildfire risks inherent to bare conductors.¹ One of the most common bare conductor failure modes is arcing due to external contact (from a foreign object or conductor slapping), a failure mode shown by field applications to be mitigated by CC use. Field studies from around the world have demonstrated increases in safety and reliability with adoption of CCs. However, those studies do not provide quantitative, lab-based data assessing the degree to which individual bare conductor failure modes are remediated (or accelerated) by CC adoption. Based on the relative scarcity of laboratory analyses offering this type of information, Exponent proposed additional CC testing to target specific knowledge gaps identified in Phase I. SCE independently retained Exponent to perform follow-up testing to address these gaps. The high-level recommendations from Phase I and the testing performed for the current study (“Phase II”) are outlined in Table 1.

¹ “Effectiveness of Covered Conductors: Failure Mode Identification and Literature Review,” Exponent Report No. 2103590.000 – 6880, December 22, 2021.

Table 1. Exponent proposed testing based on Phase I recommendations.

Phase I Recommendations	Phase II Testing	Notes
Characterize CC susceptibility to certain mechanical failure modes (Aeolian vibration, galloping, etc.).	System strength testing.	An analytical study of appropriate line tension considering CC size/weight is recommended but outside the current testing scope. System strength tests will inform analytical studies.
Characterize key understudied contact-mediated fault scenarios (e.g., foreign object contact).	Phase-to-phase contact testing, wire-down ignition testing.	
Characterize CC-specific failure modes.	Moisture ingress testing, flammability testing, corrosion testing, system strength testing.	
Research early fault detection technologies.	N/A	Subject of current research. Additional literature investigation is recommended but outside the current testing scope.

Scope

Exponent designed a testing program to address the various knowledge gaps identified in the Phase I study, and as outlined in Table 1. This program sought to quantify the performance of CCs relative to bare conductors in terms of contact-mediated faults, fire ignition risk, corrosion susceptibility, and physical system strength. This testing program focused on performance of covered conductors in the as-installed condition, and did not investigate aging or potential material degradation. While the testing presented here is unique and sought to replicate specific field scenarios, tests were designed and performed according to relevant industry guidance, testing standards (Appendix C), and literature sources (Appendix D) where possible. The five primary categories of CC testing are described below.

Phase-to-Phase Contact Testing

Electric distribution lines are subject to contact with a variety of foreign objects, including vegetation (branches, sticks, palm fronds, etc.), birds and small animals, helium balloons, and other wind-blown objects. Additionally, windy conditions can induce a phenomenon known as conductor slapping, in which adjacent phases intermittently contact one another. Traditional bare conductors are susceptible to arcing in these scenarios, which can lead to potential fire ignition and/or service outages. This group of tests was conducted to understand the effectiveness of CCs at mitigating phase-to-phase arcing in simulated contact scenarios.

Wire-Down Ignition Testing

Energized downed conductors are a major risk for fire ignition, especially in dry/windy wildfire-prone conditions. A wire-down event may occur due to tree fall, third-party damage, conductor breakage, or other hardware/structure failure. Downed bare conductors can result in direct contact between the energized conductor and any underlying fuel source such as dry brush, leading to fire ignition. This group of tests evaluated the performance of CCs relative to bare conductors in a simulated wire-down event.

Corrosion Susceptibility

Electric distribution lines are perpetually exposed to the environment and are thus susceptible to corrosion from prolonged moisture exposure and deposition of various environmental, agricultural, and industrial contaminants. CCs are, by design, largely protected from environmental ingress. In this way, use of CCs mitigates a large portion of the corrosion risk. However, scenarios exist that require stripping of the CC sheath (e.g., dead-end terminations, midspan splicing, etc.), which can create the potential for corrosion and water ingress at these locations.

First, water ingress testing was performed on CC samples to understand the propensity for water to enter a covered section from a nearby stripped end. This is important for evaluating the likelihood of prolonged moisture contact. Second, accelerated salt fog corrosion testing was performed on sections of CC stripped ends to understand potential effects of water pooling at these locations and/or potential crevice corrosion effects relative to bare conductors. Lastly, the copper and aluminum conductor, steel reinforced (ACSR) CCs were subject to electrochemical testing to evaluate the resistance of the conductors to localized corrosion.

Flammability Testing

CCs are unique in that they incorporate a polyethylene (PE) sheath along the entire length of the conductor. It is important to understand the propensity of the PE sheath to ignite in the event of a nearby wildfire. This group of tests systematically measured the time and heat flux required for auto-ignition to better understand the limits of the CC sheath relative to the conditions expected under different wildfire scenarios (e.g., low-lying brush fire, canopy fire, etc.).

System Strength

CCs are physically different from bare conductors in weight, diameter, and stiffness. Further, specified hardware in a CC installation may differ from that of a bare conductor installation. Therefore, the system response to external stimuli such as wind, tree fall, or ice accretion may be modified by using CCs. Understanding these differences is critical for evaluating the relative risk of these scenarios to CC installations. Both component-level and system-level mechanical strength tests were conducted to assess the performance of CCs and their associated hardware. The results of these tests, which include the strength of CC-specific splices, the slip strength of

post insulator clamps, and the mechanical response of the pole/cross-arm/hardware assembly, may inform risk calculations and subsequent finite element modeling efforts.

Conductor Specifications

The IOUs requested that Exponent perform testing on five conductor types: 15-kV rated 1/0 ACSR CC provided by SDG&E, 17-kV and 35-kV rated 1/0 ACSR provided by SCE, 22-kV rated 397.5 kcmil all aluminum conductor (AAC) provided by PG&E, and a 17-kV rated 2/0 copper CC provided by SCE. The copper conductor was also used for corrosion testing only, as the electrical and physical characteristics of the polymer sheath is the same as the 17-kV ACSR CC. All conductor types incorporate a three-layer design, which includes:

- A semiconducting shield layer, which reduces voltage stress concentrations caused by flux lines from individual strands.
- A cross-linked low-density polyethylene (XL-LDPE) insulating layer for impulse strength.
- A cross-linked high-density polyethylene (XL-HDPE) insulating layer for impulse strength and abrasion/impact resistance.

The 15-kV, 17-kV, and 35-kV 1/0 ACSR conductors have the same underlying conductor construction (six aluminum strands and one steel wire at the core) and polymer sheath stack-up. The 15-kV and 17-kV conductors have similar polymer sheath layer thicknesses while the 35-kV conductor layers are slightly thicker, as shown in Table 2. The 22-kV 397.5 kcmil AAC contains 19 aluminum strands but has a similar polymer sheath layer stack-up to the 1/0 ACSR covered conductors. Representative cross-section images of each conductor type are shown in Figure 1. Additional specifications are shown in Table 3.

Table 2. CC sheath dimensions.

Layer	Specified Thickness / Measured Thickness ²			
	15-kV ACSR (SDG&E)	17-kV ACSR (SCE)	35-kV ACSR (SCE)	22-kV AAC (PG&E)
Conductor Shield Layer	0.38 mm / 0.60 mm	0.38–0.64 mm / 0.58 mm	0.38–0.64 mm / 0.58 mm	0.64 mm / 0.50 mm
XL-LDPE Inner Layer	1.91 mm / 1.91 mm	1.91 mm / 1.91 mm	4.45 mm / 4.11 mm	1.91 mm / 2.10 mm
XL-HDPE Outer Layer	1.91 mm / 1.80 mm	1.91 mm / 1.83 mm	3.18 mm / 3.33 mm	1.91 mm / 1.82 mm

² Reported thickness measurements are the average of eight individual measurements taken around the circumference of a single conductor cross section.

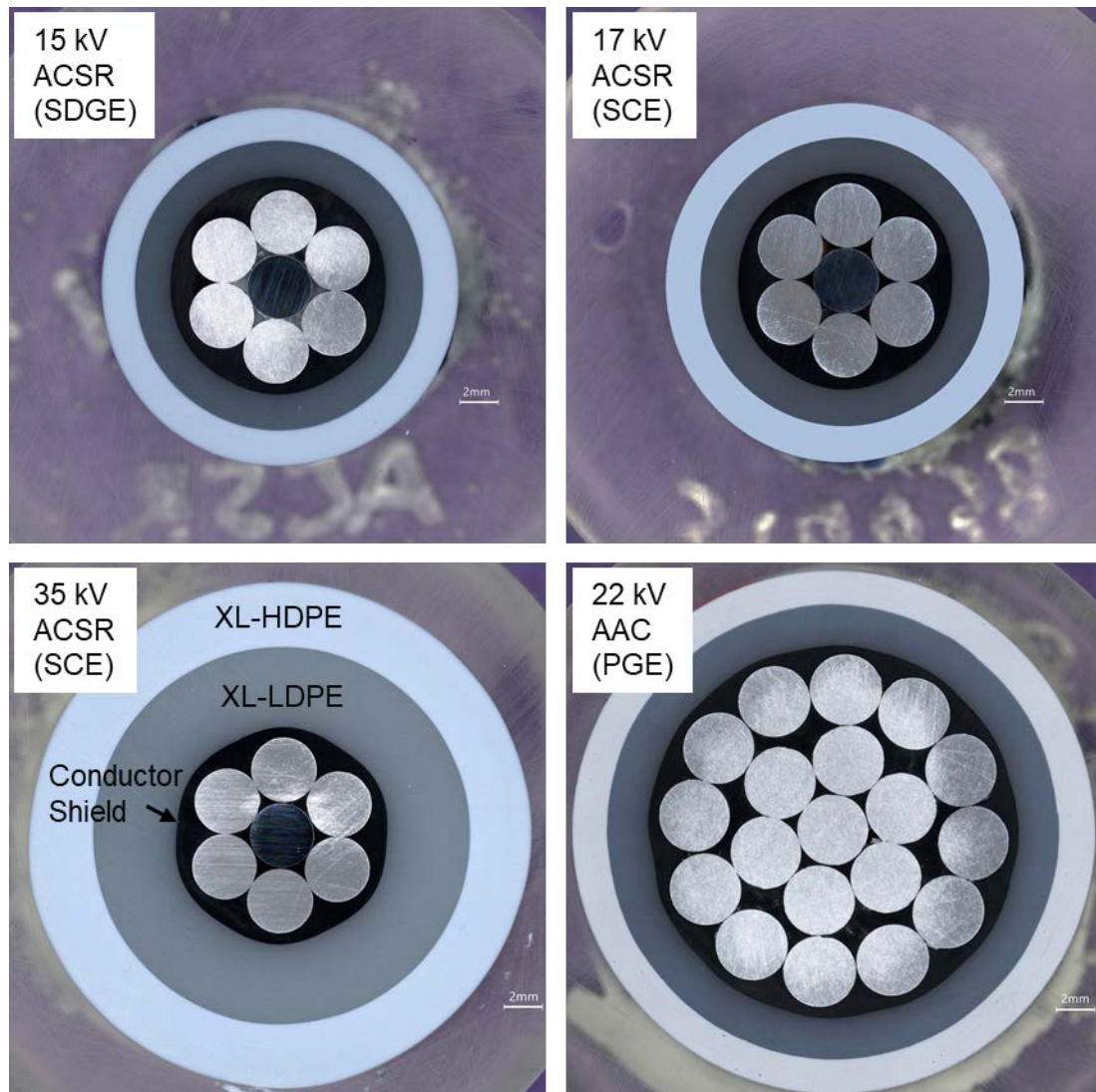

Figure 1. Cross-sectional images of all four CC types used in the present study. The measured layer thicknesses are compared to their nominal values in Table 2.

Table 3. Conductor specifications.

Rated Voltage	Size/Type	Max. Nominal Overall Dia.	Max. Rated Strength (lb.)	Ampacity per Conductor (A)
15-kV	1/0 ACSR (6x1)	18.5 mm	4,160	*
17-kV	1/0 ACSR (6x1)	19.0 mm	4,160	271
22-kV	397.5 kcmil AAC	27.3 mm	6,754	*
35-kV	1/0 ACSR (6x1)	26.6 mm	4,160	255

* Not specified.

Phase-to-Phase Contact Testing

Scope

Phase-to-phase contact testing was conducted to understand the effectiveness of CCs in mitigating current flow, arcing, and/or ignition in various contact scenarios. To simulate the potential difference across two phases of a three-phase distribution system, one conductor span was energized to the phase-to-phase voltage while the other conductor was grounded. The two conductors were bridged by a foreign object or tied together to simulate conductor slapping.

Tests consisted of several permutations of standard CCs, CCs with artificially induced sheath damage, and equivalent bare conductors (Table 4). The first stage of testing assessed the conductor performance at rated operating voltages for each respective conductor type. The second stage of testing investigated the conductor behavior in extreme conditions above their rated voltages (up to ~6x rated voltage).

Table 4. Phase-to-phase contact tests.

Side A (Energized)	Foreign Object	Side B (Grounded)	Conditions
Bare	Leafy Branch	Bare	Dry
CC	Leafy Branch	CC	Dry/Wet
CC	Conductor Slapping	CC	Dry
CC	Bare Conductor	CC	Wet
CC	Stick	CC	Dry/Wet
CC	Palm Frond	CC	Dry/Wet
CC	Mylar Balloon	CC	Dry
CC w/ splice	Palm Frond	CC	Dry
Bare	Leafy Branch	CC	Dry
Bare	Conductor Slapping	CC	Dry
CC	Messenger Wire	Bare	Dry
CC, full-thickness flaw	Leafy Branch	CC	Dry/Wet
CC, half-thickness flaw	Leafy Branch	CC	Dry/Wet
CC, pinhole flaw	Leafy Branch	CC	Dry
CC w/ wildlife guard*	Leafy Branch	CC w/ wildlife guard*	Dry/Wet
CC w/ wildlife guard*	Simulated Animal	CC w/ wildlife guard*	Dry
CC w/ wildlife guard*	Simulated Animal	CC, 1 ft stripped	Dry
CC	Control Test	CC	Dry

A total of 264 tests were performed on the various CC types (15-kV, 17-kV, and 35-kV 1/0 ACSR as well as 22-kV 397.5 kcmil AAC). Foreign objects included fresh leafy eucalyptus

branches, large eucalyptus branches without leaves or secondary branches, palm fronds, Mylar balloons, and simulated small animals (simulated by raw meat procured from a butcher). Additional tests were also performed to assess the impact of installing a wildlife guard over a one-foot stripped segment of conductor at a dead-end connection. Selected tests were carried out in both wet and dry conditions to assess the impact of precipitation on CC performance in the field. An extended (seven-day) contact study was conducted to better understand the potential effects of long-term phase-to-phase contact. Finally, testing was performed to evaluate the performance of CCs after a high-fault event such as a lightning strike; these tests were termed “sequential” tests. To ensure test reproducibility, tests were conducted in triplicate.

Experimental Setup

Test Setup and Equipment

One energized conductor and one grounded conductor were physically arranged in parallel with a spacing of 18 inches to 24 inches to simulate two phases of a three-phase distribution line (Figure 2). The two conductors were bridged by a foreign object or tied tightly together to simulate conductor slapping according to the scenarios outlined in Table 4. The potential on the energized side was set to the rated phase-to-phase voltage for the conductor type while the remaining conductor was kept at 0V potential via a high-voltage insulated cable connected to ground.

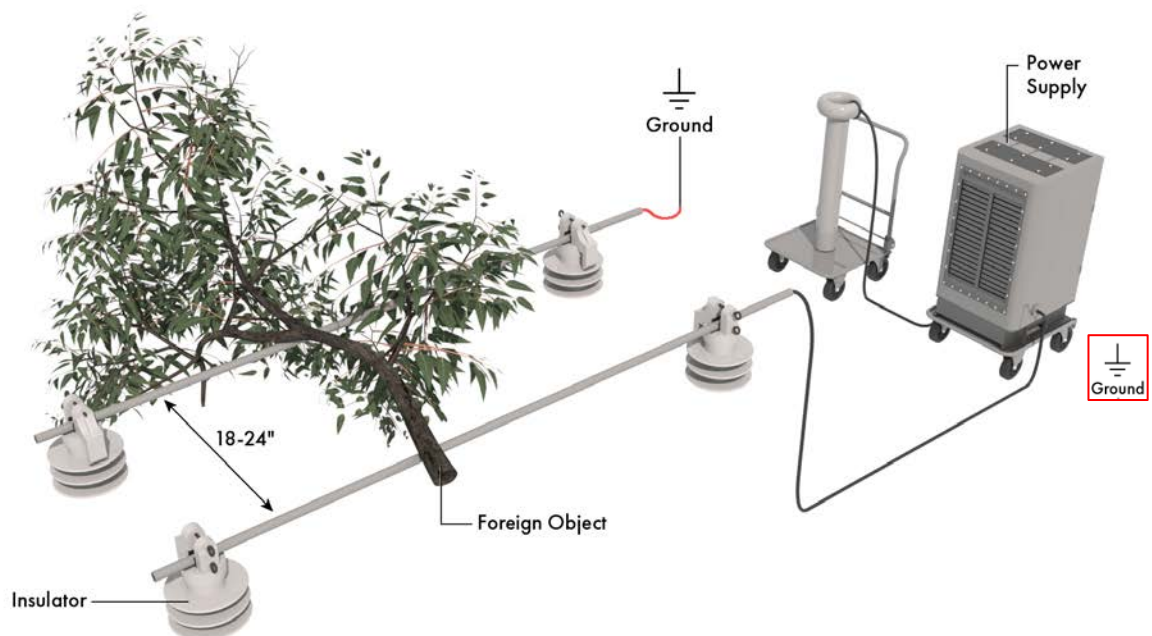

Figure 2. Schematic of experimental test setup for simulated contact testing.

The span length generally ranged from six to twelve feet, though longer spans were used for some tests in which a potential risk of damage to the equipment was identified. The conductors were secured using four polymer vise-top insulators. The phase separation for each conductor type was set according to California Public Utilities Commission (CPUC) General Order (GO) 95 specified minimum separations³ and is shown in Table 5. Approximately 1.5 inches of insulation were stripped from one end of each conductor to provide the connection to power and to ground. The leakage current through the circuit was measured with a current transducer placed around the grounded conductor cable.

Table 5. GO-95⁴ standard phase spacings.

Rated Voltage	Size/Type	Phase Separation
15-kV	1/0 ACSR (6x1)	17.5 inches
17-kV	1/0 ACSR (6x1)	
22-kV	397.5 kcmil AAC	24 inches
35-kV	1/0 ACSR (6x1)	

The CC contact tests were performed using an 800 kV, 3 amps alternating current (AC) resonant power supply, while the extended (seven-day) tests were performed using a 30 kV, 1 amp transformer. Differences in power supply did not affect results for tests with at least one CC due to the high system impedance and very limited observed current flow. Phase-to-phase contact tests involving two bare conductors utilized a third power supply rated at 7.1 kV, 2 amps.

Testing Procedure

For the first stage of testing, the voltage was increased to the rated voltage and held for five minutes. The leakage current was measured at the beginning and end of the five-minute hold. For the second stage, the voltage was increased by approximately 1 kV/sec to ~90 kV and the leakage currents were recorded as a function of applied voltage. A limited number of tests experienced a setup-related arcing event at voltages above the conductor rating. In these cases, the maximum voltage and leakage current were recorded and the test was concluded to protect the equipment. For tests that involved two bare conductors bridged by a foreign object, the full voltage could not be achieved due to low system impedance, high leakage currents, and power supply limitations. However, these tests consistently resulted in ignition of vegetation (the expected outcome) and were considered successful for their intended purpose.

Full-thickness and half-thickness coating flaws were introduced with an adjustable cable midspan stripping tool. These flaws were designed to simulate abrasion from vegetation or other third-party objects, or from animal chewing.

³ California Public Utilities Commission (CPUC) General Order (GO) 95. Section III. Requirements for All Lines. Table 2.

⁴ Ibid.

Wildlife guards are used near dead-end structures to mitigate the risk of animal contact to exposed bare conductor sections. Two scenarios were designed to test the effectiveness of wildlife guards in preventing current flow. In the first scenario, two wildlife guards covering approximately one-foot sections of exposed bare conductor were bridged by a leafy eucalyptus branch or a simulated animal (using raw meat from a local butcher). In the second scenario, one of these wildlife guards was removed to expose the bare conductor and to simulate the loss of a wildlife guard. One-foot sections of insulation were removed with an adjustable cable midspan stripping tool.

Extended (seven-day) tests were performed to simulate prolonged foreign object contact. This is especially important with CC systems since the contact results in little to no current flow and is unlikely to trip protection relays. One CC was energized to the rated voltage and was subjected to a loop current of 270 amps, the maximum ampacity determined by the ACSR technical datasheets.⁵ The loop current was intended to cause resistive heating of the conductor to simulate a loaded distribution line.

Sequential tests were performed to evaluate the performance of CCs after a fault event such as a lightning strike. The CCs were wrapped in a grounded metal braid at midspan, and the voltage was increased until the electric field was strong enough to induce breakdown in the insulation. Following breakdown, the CCs were exposed to high voltage a second time to effectively “grow” the flaw. The CCs were then phase-to-phase contact tested at rated and extreme voltages.

Foreign Objects and Vegetation

A variety of foreign objects previously identified as potential risks to distribution lines were used for the phase-to-phase contact tests. Foreign objects included leafy eucalyptus branches, eucalyptus branches without leaves or secondary branches (i.e., sticks), palm fronds, Mylar balloons, and simulated small animals (raw meat procured from a butcher).

Eucalyptus trees, non-native and invasive species in southern California, present a risk to power distribution systems because of their ability to grow quickly at high densities (eight-foot spacing on average between trees)⁶ and because of their high flammability potential.⁷ Oily eucalyptus resins reportedly have a lower activation energy for ignition compared to other species.⁸

Three mature eucalyptus cinerea trees were sourced from Gilroy, California, for use in phase-to-phase contact testing. The trees were consistently watered to maintain their freshness and

⁵ Southern California Edison Covered Conductor Data Sheet for 17 kV and 35 kV. 2020.

⁶ McBride, J.R. (2014) The History, Ecology and Future of Eucalyptus Plantations in the Bay Area: A lecture at the Commonwealth Club of San Francisco Understanding Eucalyptus in the Bay Area. San Francisco Forest Alliance.

⁷ Nance, A. (2014). The Plight of the Eucalyptus Trees in San Francisco: A Case Study on the Values and Considerations Involved in a Decision that Requires Comparative Valuation of Species. *Hastings W.-Nw. J. Env't'l L. & Pol'y*, 20, 429.

⁸ Dickinson, K. J. M., and J. B. Kirkpatrick. 1985. The flammability and energy content of some important plant species and fuel components in the forests of southeastern Tasmania. *Journal of Biogeography* 12:121-134.

moisture. Branches were cut into 4.5-foot sections and labeled according to their original position on the tree. Diameter and moisture measurements were made at the cut end and center of each branch. Immediately after cutting, the ends were sealed and the branches were packaged in thick plastic bags under vacuum. Additional information regarding branch preparation, quality control, and moisture content is referenced in Appendix A. The palm fronds (*ravenea rivularis*), Mylar balloons, and raw meats were locally sourced at the testing lab, and the bare conductor was provided by SCE, as shown in Table 6.

Table 6. Sourcing of foreign object for phase-to-phase contact tests.

<u>Foreign Object</u>	<u>Source</u>
Leafy Eucalyptus Branch	Eucalyptus cinerea from Gilroy, CA
Bare Conductor	Bare conductor provided by SCE
Eucalyptus Stick	Eucalyptus cinerea from Gilroy, CA
Palm Frond	Ravenea rivularis (majesty palm)
Mylar Balloon	34" mylar balloon
Messenger Wire Contact	Bare conductor provided by SCE
Raw Meat	Rabbit and pork ribs from Ontario

Ambient Conditions

Since high-voltage tests are known to be sensitive to environmental conditions,⁹ the temperature and relative humidity in the lab were recorded for each test. The ambient temperature in the facility averaged 72.7°F while the relative humidity averaged 25.5%. The approximate elevation of the testing lab was 120 m above sea level. All testing conditions fell within the range specified by IEEE Standard 4-2013 (Table 7).¹⁰

Table 7. Normal environmental conditions for high-voltage tests and measurements specified by IEEE Standard 4.

	<u>IEEE Standard 4</u>	<u>Test Conditions</u>
Temperature	50°F to 104°F	58.1°F to 84.4°F
Relative Humidity	< 95%	9.7% to 45.0%
Elevation	< 1000 m	120 m

While dry environmental conditions are thought to be “worst case” from a fire ignition perspective, wet conditions may improve conduction and may affect the propensity for current

⁹ Yousefpour, K. “Effect of Ambient Conditions on Insulation Strength of High Voltage Protection Devices.” HAL Open Science. 2020.

¹⁰ IEEE Std. 4™-2013 “IEEE Standard for High Voltage Testing Techniques,” Institute of Electrical and Electronics Engineers, 2013.

flow. Wet tests were performed to evaluate the performance of CCs under specified precipitation conditions. The vertical and horizontal components of the precipitation rate as well as the water temperature and conductivity were controlled using a purpose-built rain system. All wet test and precipitation parameters were in accordance IEEE Standard 4-2013 specifications.¹¹ Additional information regarding the wet testing is referenced in Appendix A.

Results

CCs prevented arcing/ignition and limited current flows to less than 2.5 mA under all tested conditions at rated voltages. The results of the phase-to-phase contact testing are summarized in Table 8.

In stark contrast to the low current flows (<2.5 mA) detected at rated voltages for tests with CCs, much higher currents were detected (>2000 mA) in tests with two bare conductors. Energized bare conductors bridged by leafy branches consistently resulted in rapid expulsion of moisture, smoking, and ignition of the vegetation.

For CC phase-to-phase contact testing at rated voltages, no arcing event or ignition was observed in any test. The conductors were energized to their rated voltages and held for five minutes. No arcing, insulation breakdown, or visual damage to the energized and/or grounded conductors was observed. Leakage currents were low (less than 2.5 mA) and likely influenced by coupling effects rather than current flow through the insulation.

For CC contact testing at extreme voltages (1 kV/sec ramp rate from rated voltage), the results were as follows:

- **No arcing event or ignition:** Test was energized to approximately 90 kV with no insulation breakdown, pinhole formation, or phase-to-phase arcing. Minor charring was observed on the eucalyptus branches when direct contact was made with exposed bare conductor at extreme voltages.
- **Setup-related arcing:** In the range of 60 kV to 90 kV (well above the rated voltages), some early tests with a six-foot span length experienced setup-related arcing. Under these voltage conditions, arcing sometimes occurred due to surface tracking and/or breakdown through the air. This was mitigated in later tests by using longer (10 feet) conductor spans.
- **Insulation breakdown:** Test experienced a breakdown of the insulation, resulting in pinhole formation well above the rated voltage. This occurred in the range of 55 kV to 85 kV for the 15-kV and 17-kV ACSR CCs and 22-kV AAC CCs when an artificial half-thickness coating flaw was introduced. Insulation breakdown did not occur for the 35-kV ACSR CC with a half-thickness flaw up to 90 kV.

¹¹ IEEE Std. 4™-2013 “IEEE Standard for High Voltage Testing Techniques,” Institute of Electrical and Electronics Engineers, 2013.

There were no significant differences in leakage current observed between dry and wet tests at rated or extreme voltages. This suggests that CCs are effective at preventing current flow in both dry and wet conditions. For tests in which direct contact was made at high voltage with exposed bare conductor, the rain suppressed charring of the branch.

Table 8. Results of phase-to-phase contact testing at rated voltages.

Test Configuration			Conditions	Maximum Leakage Current at Rated Voltage (mA)				Negligible Detected Current at Rated Voltage? (<2.5 mA)
Side A (Energized)	Foreign Object	Side B (Grounded)		15 kV ACSR	17 kV ACSR	35 kV ACSR	22 kV AAC	
Bare	Leafy Branch	Bare	Dry	>2000**	>2000**	>2000**	>2000**	No
CC	Leafy Branch	CC	Dry/Wet	0.1 / 0.1	0.8 / 0.3	0.8 / 0.7	0.2 / 1.0	Yes
CC	Conductor Slapping	CC	Dry	0.2	0.9	0.8	0.2	Yes
CC	Bare Conductor	CC	Wet	0.2	0.1	0.5	0.8	Yes
CC	Stick	CC	Dry/Wet	0.1 / 0.1	0.7 / 0.3	0.7 / 0.4	0.1 / 0.5	Yes
CC	Palm Frond	CC	Dry/Wet	0.1 / 0.4	0.7 / 0.5	0.2 / 0.5	0.2 / 0.7	Yes
CC	Mylar Balloon	CC	Dry	0.1	0.1	0.2	0.1	Yes
CC w/ splice	Palm Frond	CC	Dry	0.2	0.2	0.3	0.2	Yes
Bare	Leafy Branch	CC	Dry	0.2	0.9	0.8	0.5	Yes
Bare	Conductor Slapping	CC	Dry	0.4	0.9	0.8	0.6	Yes
CC	Conductor Slapping	Bare	Dry	0.5	0.4	0.4	0.7	Yes
CC, full-thickness flaw	Leafy Branch	CC	Dry/Wet	0.2 / 0.4	0.5 / 0.1	0.5 / 0.2	1.0 / 2.4	Yes
CC, half-thickness flaw	Leafy Branch	CC	Dry/Wet	0.1 / 0.2	0.2 / 0.1	0.2 / 0.5	0.1 / 0.5	Yes
CC, pinhole flaw	Leafy Branch	CC	Dry	-	0.4	1.0	0.3	Yes
CC w/ animal guard*	Leafy Branch	CC w/ animal guard*	Dry/Wet	0.1 / 0.1	0.4 / 0.8	0.2 / 0.2	0.1 / 0.2	Yes
CC w/ animal guard*	Simulated Animal	CC w/ animal guard*	Dry	0.1	0.1	0.2	0.1	Yes
CC w/ animal guard*	Simulated Animal	CC, 1 ft stripped	Dry	0.1	0.1	0.2	0.1	Yes
CC	Control Test	CC	Dry	-	0.1	0.2	-	-

*Animal guards were placed over 1ft a section of exposed bare conductor.

**Tests with two bare conductors could not reach full voltage due to high leakage currents and power supply limitations. Current limited to 2 A.

Phase-to-Phase Contact Testing—Bare Conductors

Control tests were performed with traditional bare conductors (Figure 3) to provide a point of reference that can be used to compare to CC performance. Two bare conductors of equivalent size to their CC counterpart were bridged by a leafy eucalyptus branch. Three tests were performed for each bare conductor type.

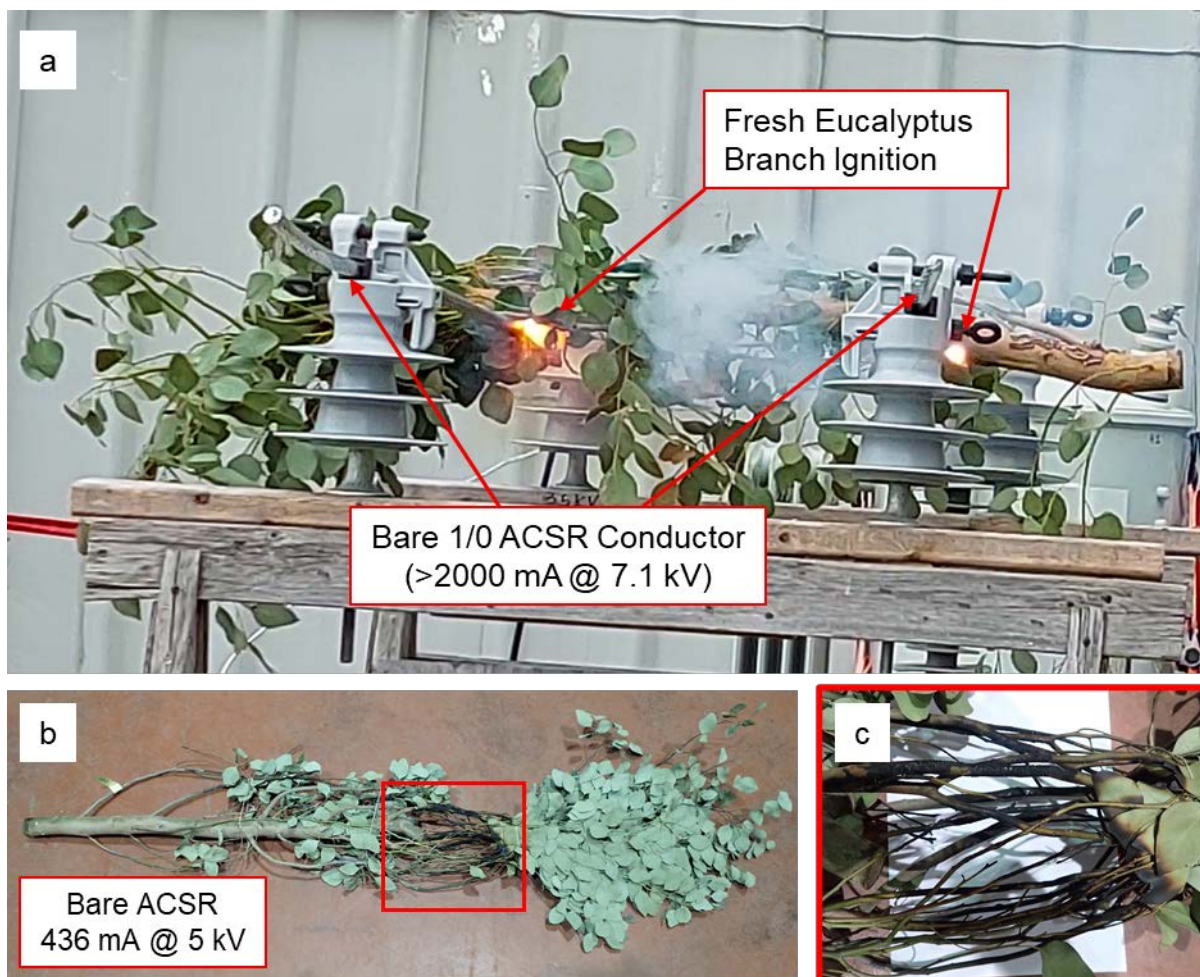

Figure 3. Phase-to-phase contact tests with two bare conductors. (a) Leafy eucalyptus branch spanning two bare 1/0 ACSR conductors with a 7.1-kV voltage drop. (b) Post-test inspection of the points of contact between the branch and conductors identified evidence of ignition. (c) Close-up view of (b).

Immediately after energizing, a loud, high-pitched noise was clearly audible, consistent with rapid evaporation of branch moisture. After three seconds, smoking and ignition were observed at both points of contact between the branch and the bare conductors (Figure 3a). Upon inspection of the branch post-test, clear evidence of ignition, burning, and tracking along the surface of the branch were observed (Figure 3b,c). The highest attainable voltage for these tests

was 7.1 kV (using a 7.1-kV, 2 amp power supply) due to low system impedance, high leakage current, and equipment power limitations.

Across the six bare conductor tests, three different power supplies were used. Applied voltages ranged from 3 kV to 7.1 kV and leakage currents ranged from 200 mA to 2,000 mA. In all tests, the power supply limit was reached. It is likely that significantly higher currents could have been attained at full voltage with sufficient power supply capacity, as would be available in an actual distribution system. Leakage currents increased with voltage and depended strongly upon the diameter and moisture of the branch. Larger branches resulted in greater leakage current, consistent with literature sources that the electrical impedance of live branches is variable and depends on diameter and moisture content.¹²

Phase-to-Phase Contact Testing with CCs—Rated Voltage

CC phase-to-phase contact tests were broken up into four sub-groups:

- Two standard CCs (Figure 4).
- One spliced CC and one standard CC (Figure 5).
- One CC with an artificially induced insulation flaw and one standard CC (Figure 6).
- One bare conductor and one standard CC (Figure 7).
- Simulated dead-end configuration with (a) two wildlife guards, each covering one foot of bare conductor (simulated dead-end connection), and (b) one wildlife guard covering one foot of exposed conductor and one CC with one foot of exposed conductor (Figure 8).

Selected tests were carried out in both wet and dry conditions to assess whether precipitation might impact CC performance in the field.

Two Standard CCs at Rated Voltage

Leakage currents for all tests with two standard CCs were below 2.5 mA and were stable at rated voltages for the duration of the five-minute hold. No insulation breakdown, phase-to-phase arcing, damage to the insulation, or damage to the foreign objects was observed in any scenarios at rated voltages with two CCs. Minor corona discharge was observed near the surface of the energized CCs at the point of contact with the foreign object. This occurs because the presence of the foreign object causes a sharp potential gradient and strong electric field, resulting in local dielectric breakdown and ionization of the surrounding air, observed visually as corona discharge.

The dry tests simulating CC slapping (Figure 4c) and wet tests with two CC bridged by a bare conductor (Figure 4d) were designed to represent the two worst-case scenarios, as these lowest impedance configurations should lead to the highest likelihood of energy transfer between the two conductors. There was no evidence of significant current flow for either of these tests, nor for any other scenarios tested with two CCs.

¹² Goodfellow and Appelt. “How Trees Cause Outages.” Environmental Consultants, Inc.

There were no significant differences in leakage current observed between dry and wet tests at rated voltages, as is evident from Table 8. This suggests that the CCs are effective at preventing current flow in both dry and wet conditions.

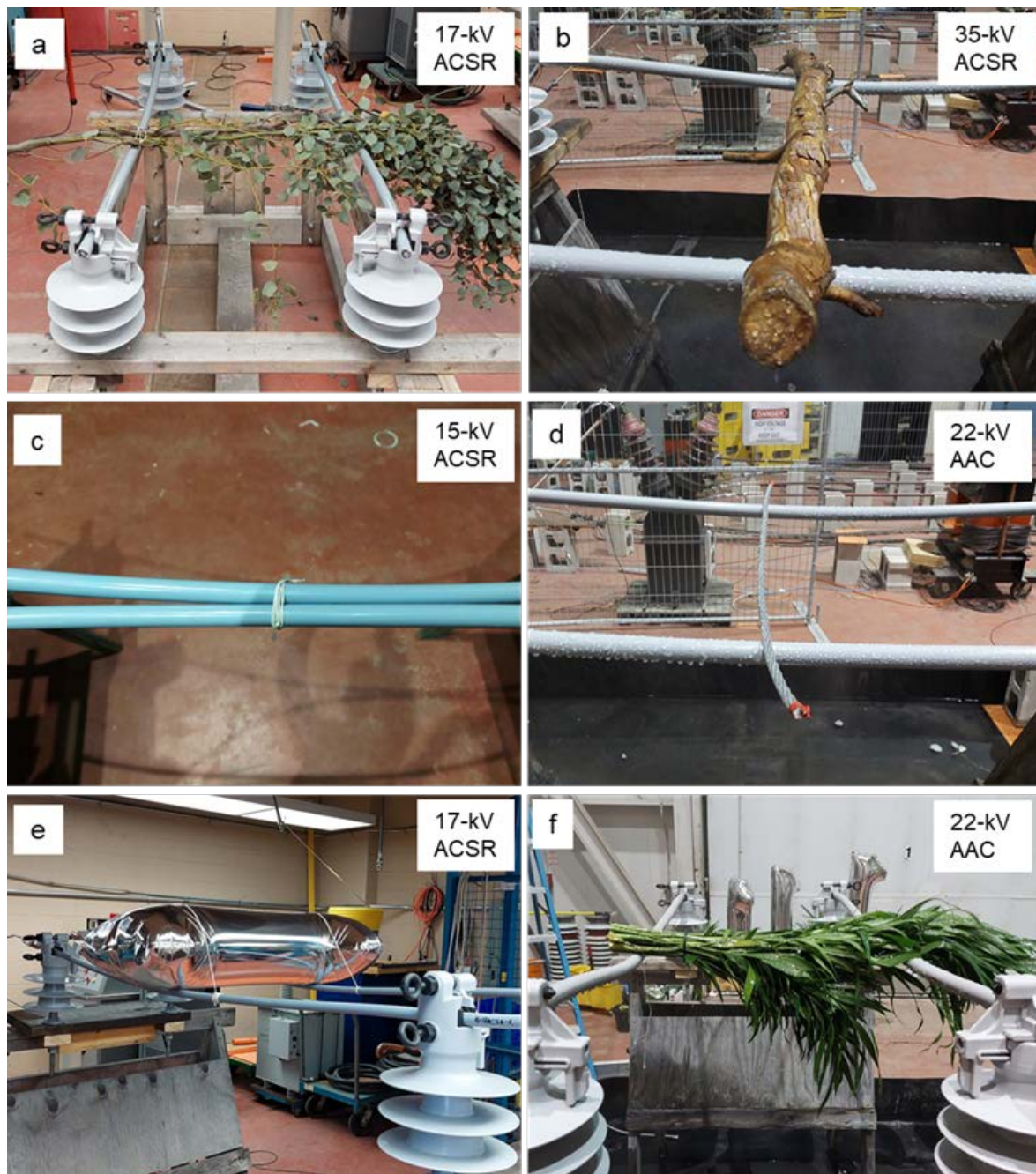

Figure 4. Rated voltage testing of two standard covered conductors with various bridging objects: (a) Leafy eucalyptus branch. (b) Large eucalyptus stick (wet test). (c) Conductor slapping of two CCs. (d) Bare ACSR conductor (wet test). (e) Mylar balloon. (f) Palm frond (wet test).

One Spliced CC at Rated Voltage

In this scenario, the energized CC was spliced with the splice hardware specified in Table 9 and cold shrink insulation. The spliced CC was bridged to a standard CC with a palm frond to simulate vegetation contact, as shown in Figure 5. Splice test leakage currents were 0.34 mA or lower and were stable at rated voltages for the duration of the five-minute hold.

Table 9. Splices used for phase-to-phase testing.

Rated Voltage	Size/Type	Splice
15-kV	1/0 ACSR (6x1)	Splice A
17-kV	1/0 ACSR (6x1)	Splice B
22-kV	397.5 kcmil AAC	Splice C
35-kV	1/0 ACSR (6x1)	Splice B

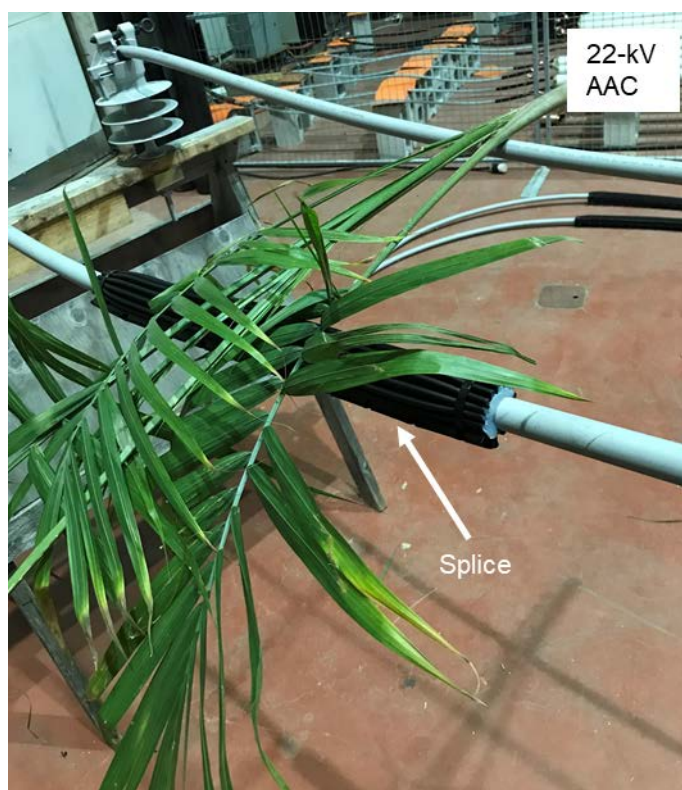

Figure 5. Rated voltage testing of a spliced CC and a standard CC bridged by a palm frond (22-kV AAC pictured).

One CC with a Simulated Flaw at Rated Voltage

One-inch full-thickness (Figure 6a) and one-inch half-thickness (Figure 6b) insulation flaws were artificially introduced to CCs on the energized side of the setup to simulate abrasion from vegetation contact or animal chewing. Full-thickness flaws exposed the underlying conductor, while half-thickness flaws removed roughly half of the polymer sheath thickness. A standard CC was used on the grounded side of the system. A leafy eucalyptus branch was used to bridge the two conductors and was tightly secured against the flaws (Figure 6c,d). The leakage currents for both tests with insulation flaws were below 1 mA and were stable at rated voltages for the duration of the five-minute hold.

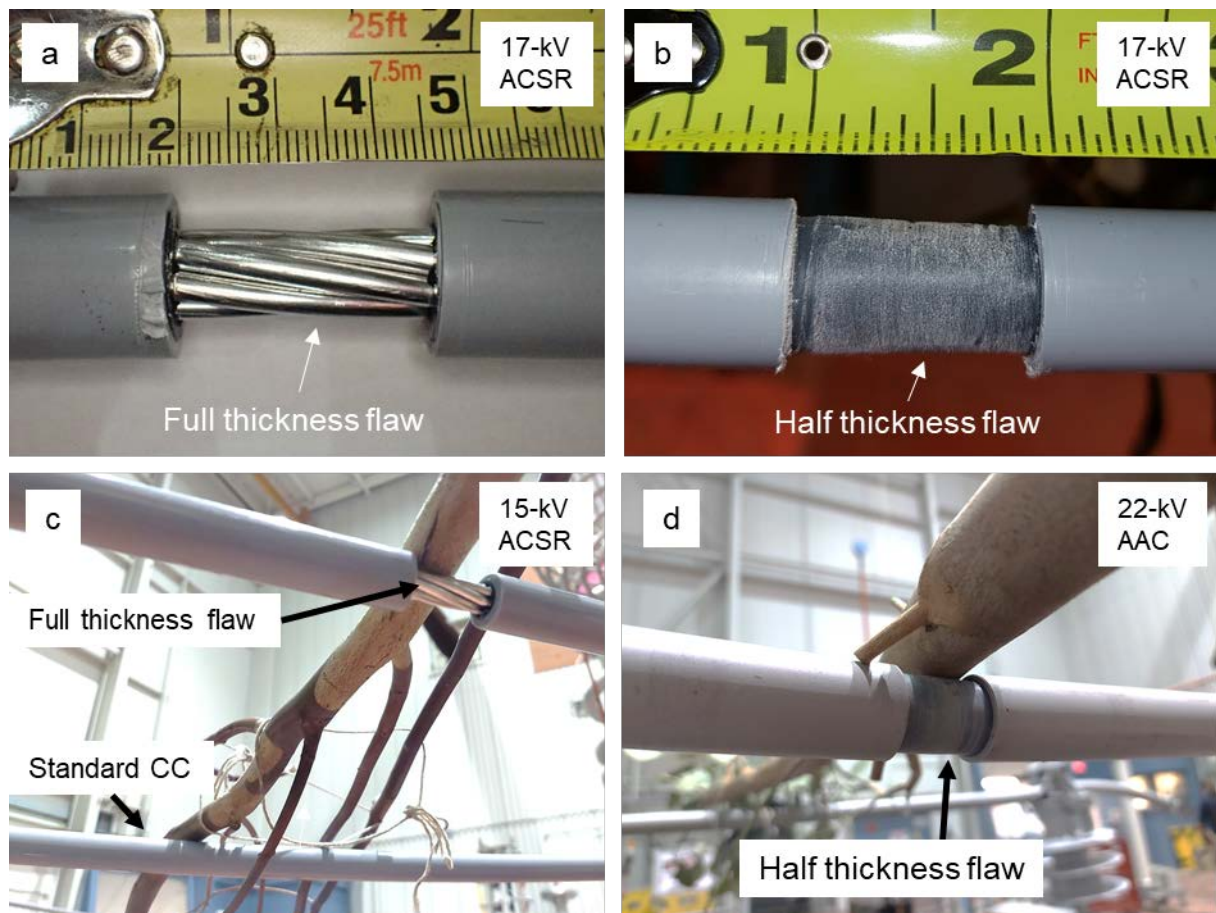

Figure 6. Simulated full- and half-thickness defects at rated voltages. (a) 17-kV ACSR CC with a through-thickness flaw. (b) 17-kV ACSR CC with a half-thickness flaw. (c) 22-kV AAC CC with a through-thickness flaw. (d) 22-kV AAC CC with a half-thickness flaw.

One CC and One Bare Conductor at Rated Voltage

In mixed systems (i.e., one bare conductor and one standard CC, shown in Figure 7a-d), leakage currents at rated voltages were comparable to systems with two CCs. All leakage current values remained below 1 mA for all classes of covered conductors and were stable for the duration of the five-minute hold. No insulation breakdown, phase-to-phase arcing, or damage to the CC was observed for any tests. As with two CCs, direct physical contact between one CC and one bare conductor did not result in significant current flow. This suggests that damage to the covering that exposes the underlying conductor on a single phase does not significantly increase the risk of arcing or ignition at rated voltages.

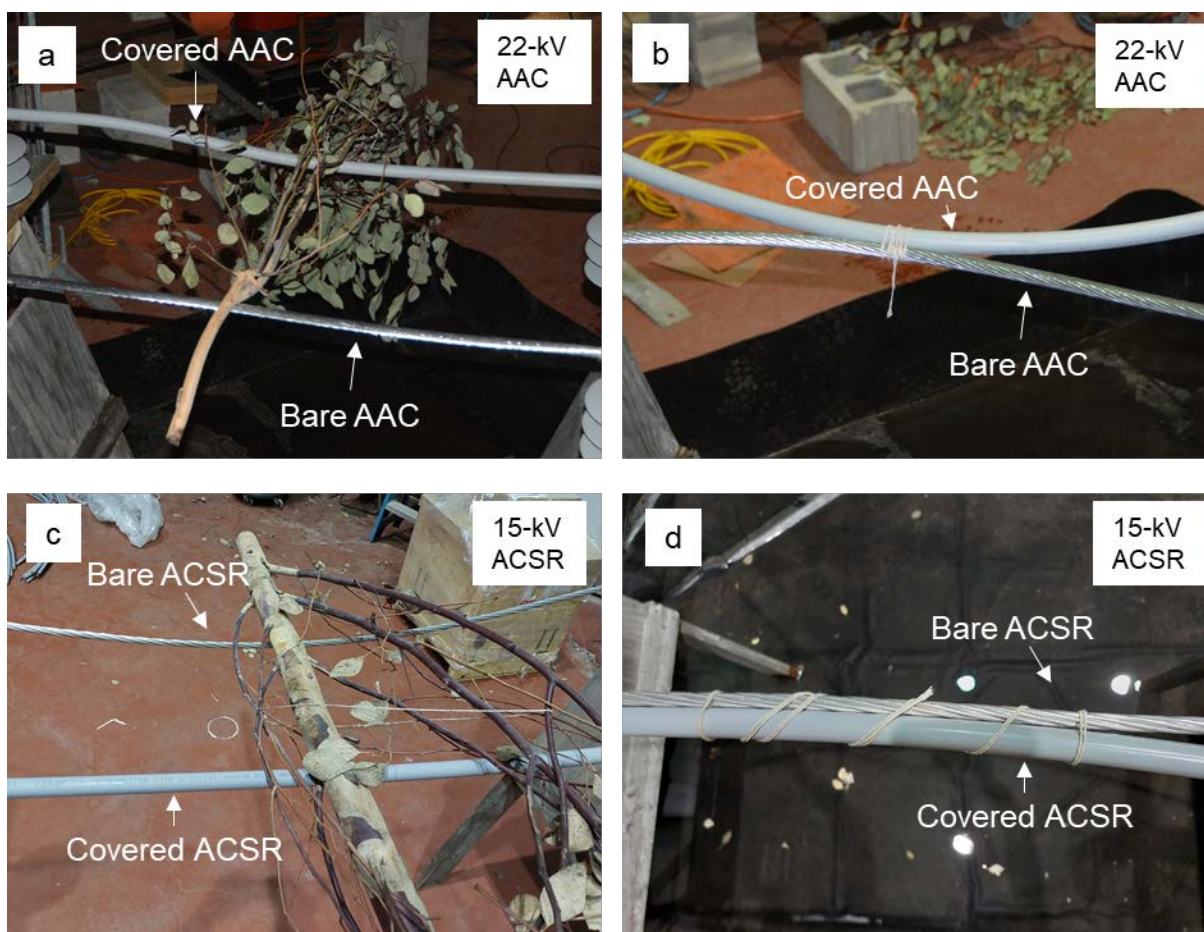

Figure 7. Mixed systems (one CC and one bare conductor) at rated voltages. (a) One bare conductor and one 22-kV AAC CC bridged by a leafy eucalyptus branch. (b) Simulated conductor slapping between a bare conductor and a 22-kV AAC CC. (c) One bare conductor and one standard 15-kV ACSR CC bridged by a large eucalyptus branch. (d) Simulated conductor slapping between a bare conductor and a 15-kV ACSR CC.

Wildlife Guard Tests at Rated Voltage

Wildlife guards are used near dead-end structures to mitigate the risk of animal contact to exposed bare conductor sections. Two scenarios were designed that involved testing wildlife guards at rated voltages. In the first scenario, two wildlife guards covering approximately one-foot sections of exposed bare conductor were bridged by a leafy eucalyptus branch or a simulated animal (using raw meat from a local butcher; see Figure 8a,c,d). The second scenario was similar, though one phase had a wildlife guard whereas the other conductor was exposed to simulate the loss of a wildlife guard (Figure 8b). Leakage currents were low (< 1 mA) in all tests with all four CC types, and no activity was observed for any of the tests at the rated voltages.

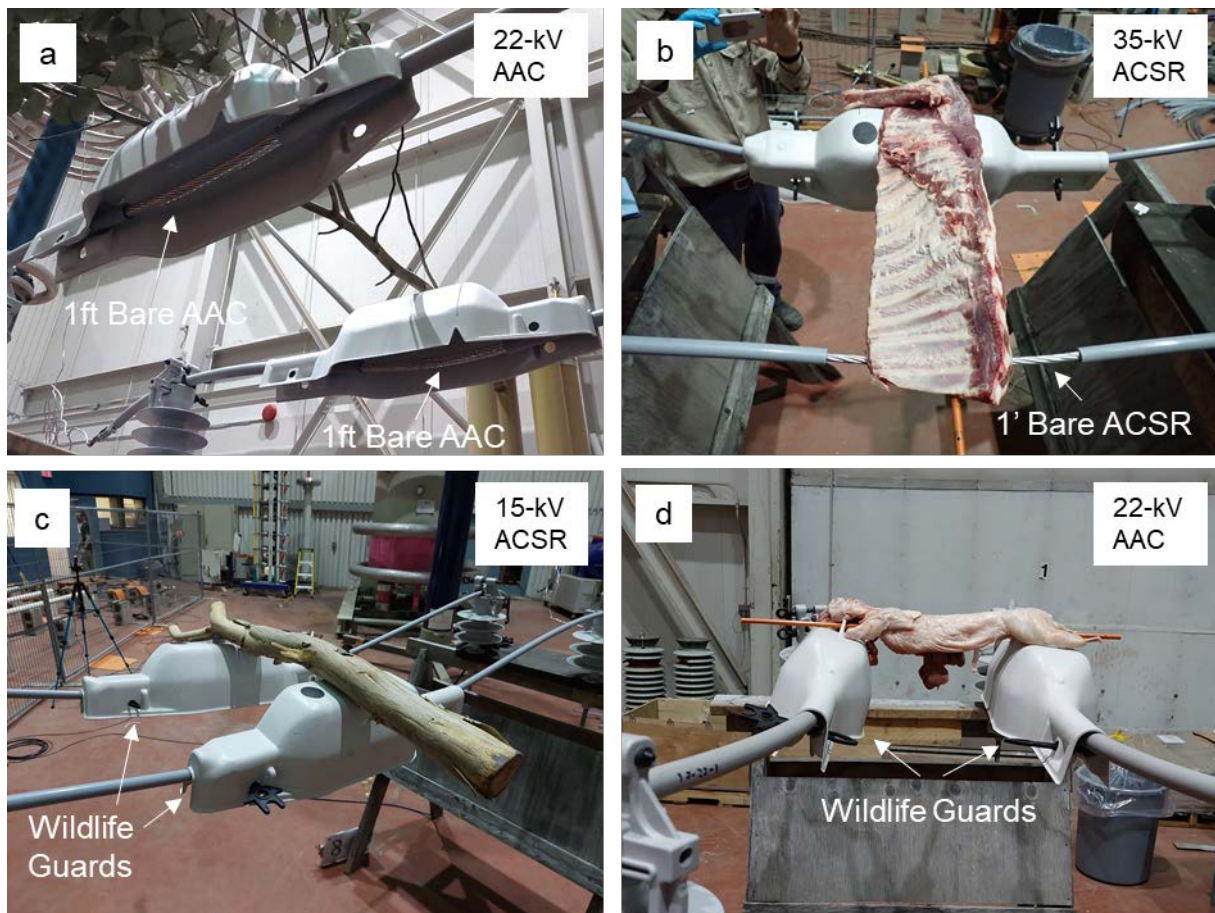

Figure 8. Wildlife guard tests in various configurations at rated voltages. (a) Leafy branches bridging two 22-kV AAC CCs with wildlife guards covering one foot of bare conductor on either side. (b) Simulated animal bridging one 35-kV ACSR CC with a wildlife guard and one 35-kV ACSR CC with one foot of bare conductor exposed. (c) Large eucalyptus stick bridging two 15-kV ACSR CCs with wildlife guards covering one foot of bare conductor on either side. (d) Simulated animal bridging one 22-kV AAC CC with wildlife guards covering one foot of bare conductor on either side.

Extended Phase-to-Phase Contact Testing—Rated Voltage

During the Phase I literature study, subject matter experts identified the potential risk of long-term foreign object contact.¹³ In addition to the relatively short-term contact scenarios discussed previously, extended contact tests were performed to investigate the time-dependent effects of foreign object contact, such as what might be experienced if a tree branch grew into a CC line but did not immediately cause an outage. While month-long tests (or longer) were out of scope for the current study, tests were designed to explore this concept within the constraints of the project timeline.

Two CCs were bridged by a leafy eucalyptus branch for seven days, as shown in Figure 9. One CC was energized to the rated voltage while the other CC was grounded. The energized conductor was also subjected to a loop current of 270 amps, the maximum ampacity determined by the technical datasheet.¹⁴ The loop current was intended to cause resistive heating of the conductor to simulate a loaded distribution line.

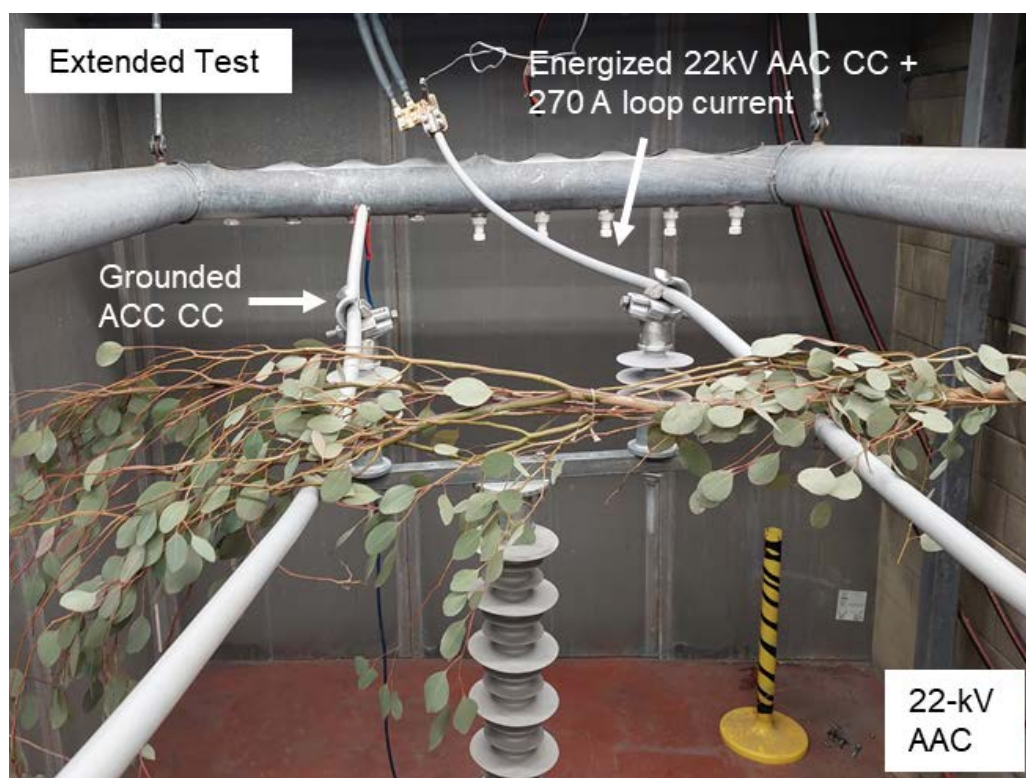

Figure 9. Test setup for 22-kV AAC CC one-week extended hold test at rated voltage and 270 amp loop current.

¹³ “Effectiveness of Covered Conductors: Failure Mode Identification and Literature Review,” Exponent Report No. 2103590.000 – 6880, December 22, 2021.

¹⁴ Southern California Edison. Covered Conductor Data Sheet for 17 kV and 35 kV. 2020.

No insulation breakdown, phase-to-phase arcing, or damage to the leafy branches (except for natural drying over time) was observed in these tests. Figure 10 and Figure 11 show images of the surface of the energized CCs after the one-week hold. The surface of the polymer sheaths on both the ACSR and AAC CCs were discolored at the point of contact with the branch at the conclusion of the test. The surface of the 35-kV CC also showed signs of minor insulation damage.

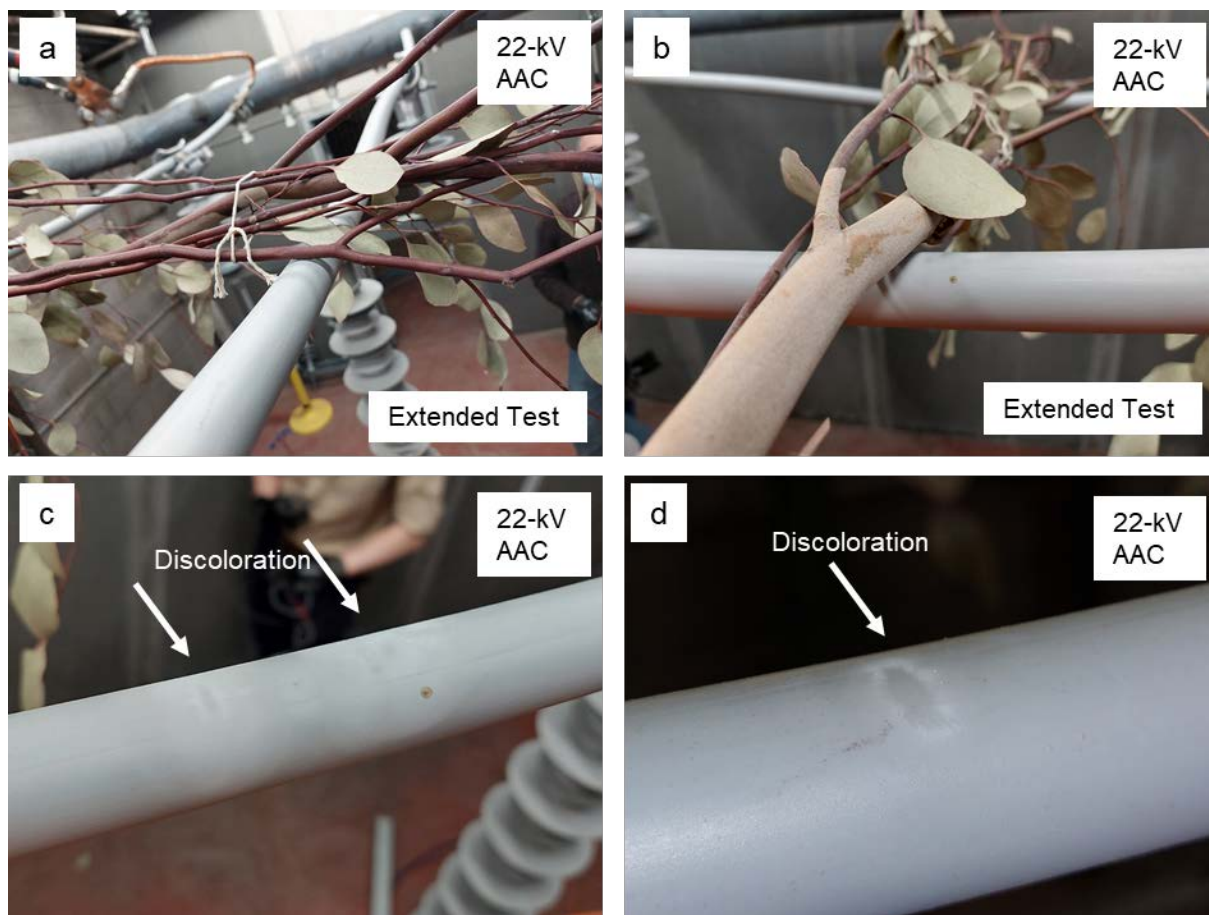

Figure 10. (a,b) Test setup for one-week extended test at rated voltage (22-kV AAC pictured). (c,d) Discoloration on the surface of 22-kV AAC after one week.

For all four conductor types, evidence of corona discharge was observed in the vicinity of the point of contact between the energized conductor and the leafy branch. Corona discharge refers to the ionization of surrounding air due to a sharp local potential gradient resulting in the formation of a plasma. The plasma facilitates the formation of ozone gas. The discoloration/damage observed may be consistent with oxidation of the PE sheath due to extended exposure to a plasma and/or ozone. In situations where the potential for extended contact exists, it may be prudent to perform additional long-term studies to identify the potential impact of extended exposure to corona discharge on the material properties of the insulation.

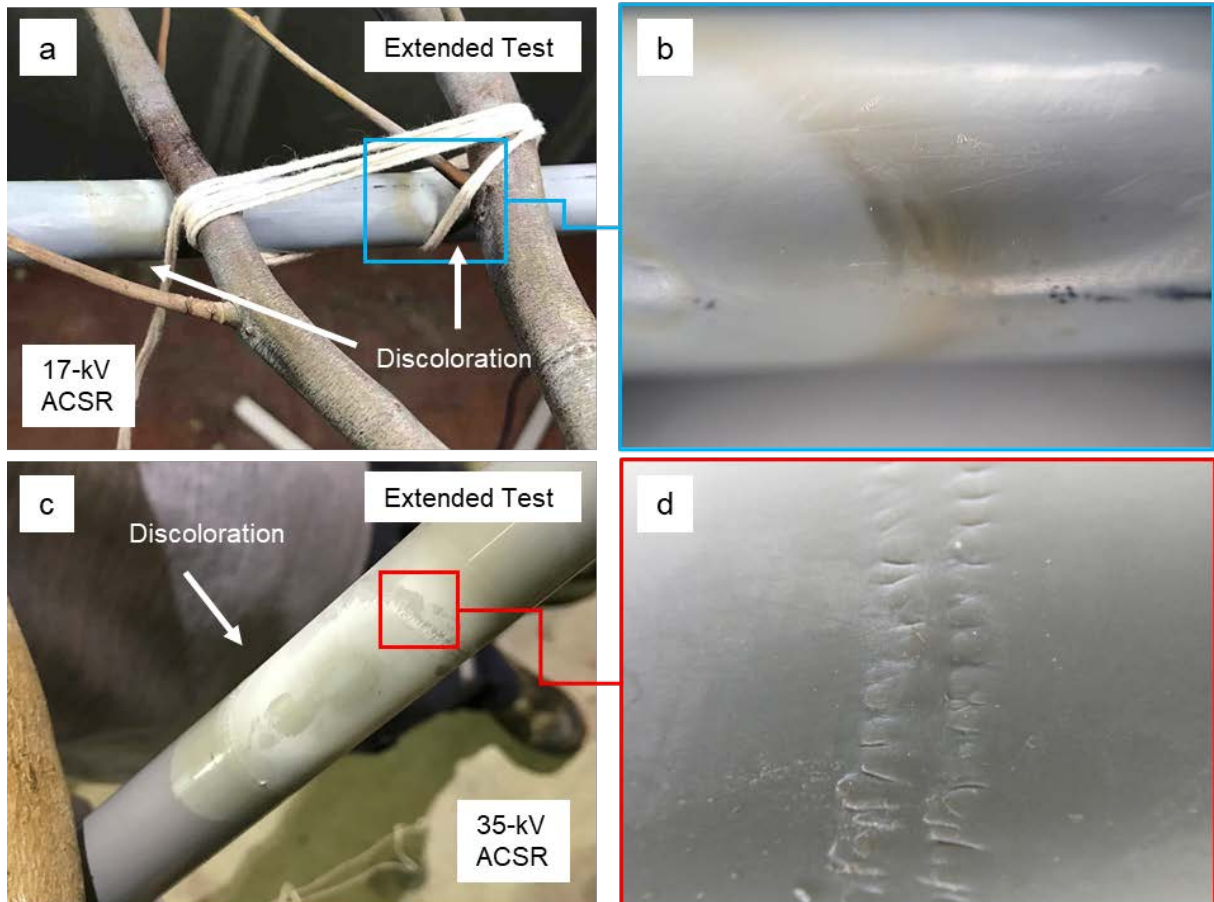

Figure 11. Results of one-week extended contact test at rated voltages. (a) Discoloration on the surface of 17-kV ACSR CC after one week and (b) higher-magnification image of the indicated area in (a). (c) Discoloration and damage on the surface of a 35-kV ACSR after one week, and (d) higher-magnification image of the indicated area in (c).

Phase-to-Phase Contact Testing with CCs—Extreme Voltage

For all phase-to-phase contact tests, the voltage was increased at a rate of 1 kV/sec to approximately 90 kV after the five-minute hold at rated voltages. Most tests were energized to ~90 kV with no observed insulation breakdown, pinhole formation, or phase-to-phase arcing. Some early tests with shorter (six-foot) conductor span lengths suffered from setup-related arcing events in the range of 60 kV to 90 kV. At these voltage levels, arcing sometimes occurred due to surface tracking and/or breakdown through the air. This effect was mitigated in later tests by increasing the conductor span length to 10 feet.

Insulation breakdown was observed in the 15-kV and 17-kV ACSR CC as well as the 22-kV AAC CC, but only when an artificial half-thickness coating flaw was introduced and the voltage was increased to greater than three times the rated voltage. Insulation breakdown was never observed in the 35-kV ACSR CC, even when the half-thickness coating flaw was introduced.

Two Standard CCs at Extreme Voltage

For tests with two CCs, the leakage current increased with applied voltage (Figure 12). Leakage current magnitudes at 90 kV were below 10 mA for all tested conductor types. The conductor slapping tests exhibited the highest leakage currents for this group, likely due to facilitated surface tracking and increased coupling effects because the conductors were physically fixed together.

It should be considered, however, that conductor slapping is a dynamic process with incidental contact; therefore, the static fixation used in this scenario represents an extreme (i.e., conservative) case. Interpretation of the leakage data requires an understanding of the possible current paths to ground:

- Tracking along the surface of the conductors and foreign object
- Coupling through the air
- Through the CC insulation (small component)
- Through the grips and insulating supports (small component)

Control tests were performed on the 17-kV and 35-kV ACSR CCs to better understand the effects of coupling on the measured current at ground. The setup for the control tests was identical to the foreign object contact tests, but no foreign object was used to bridge the two phases. The measured leakage currents at the rated voltages were approximately 0.1 mA and 0.2 mA for the 17-kV and 35-kV ACSR CCs, respectively. The measured leakage current at 90 kV was approximately 0.4 mA for both conductor classes (Figure 12).

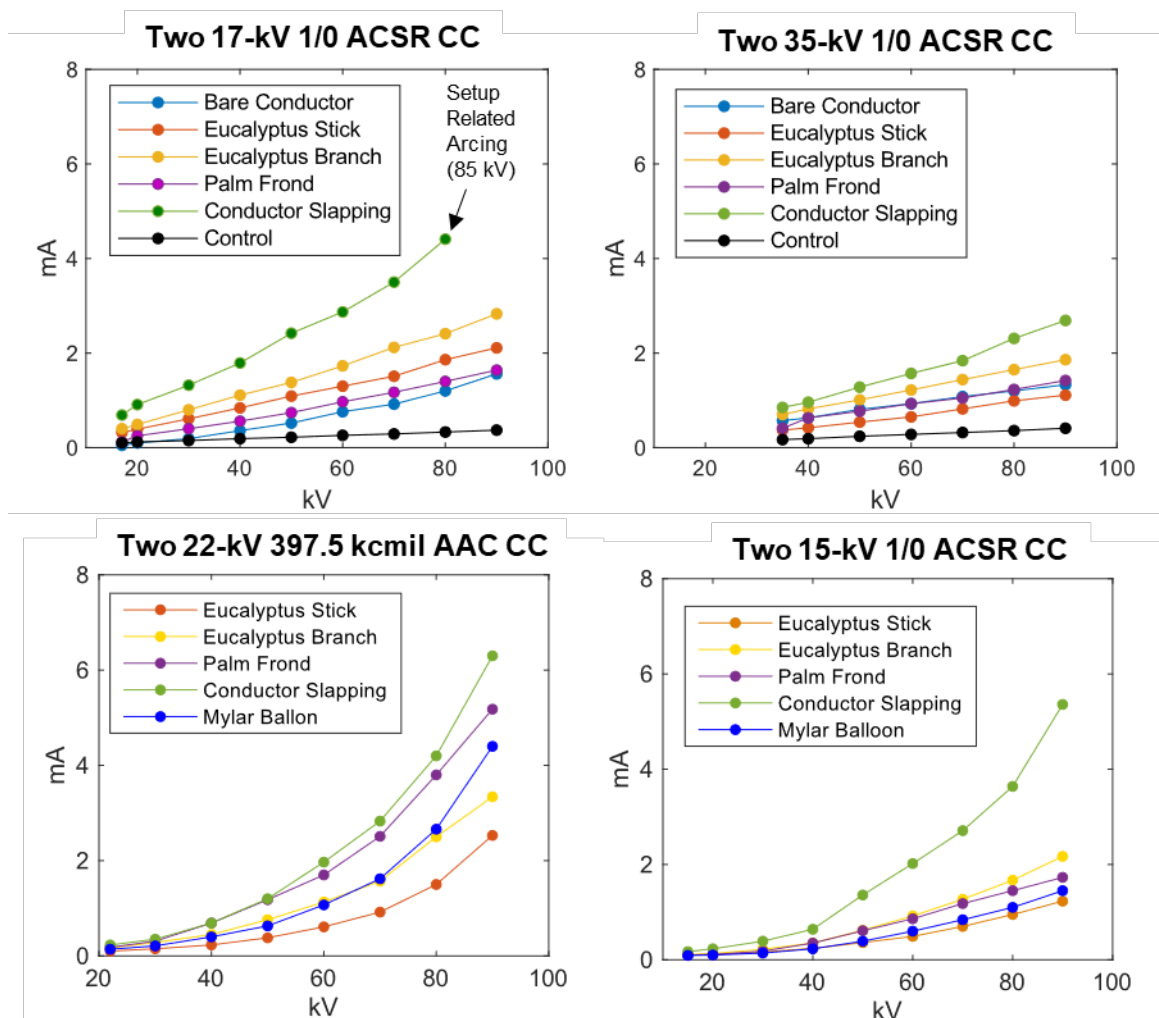

Figure 12. Leakage current as a function of voltage for two 17-kV ACSR CCs (top left), two 35-kV ACSR CCs (top right), two 22-kV AAC CCs (bottom left), and two 15-kV ACSR CCs (bottom right) with various bridging objects.

Above 60 kV, the development of corona discharge and surface tracking was evident for all conductor classes. For tests with two standard CCs bridged by a foreign object, the corona discharge and surface tracking were observed on both the energized and grounded CCs, concentrated near the points of contact with the foreign object.

One Spliced CC at Extreme Voltage

Spliced CCs exhibited similar leakage currents to standard CCs in the extreme voltage regime. Leakage current magnitudes at 90 kV were below 4.0 mA for all tested conductor/splice configurations.

One CC with a Simulated Flaw at Extreme Voltage

For CC tests with a full-thickness insulation flaw bridged to a standard CC by a leafy eucalyptus branch, minor charring was observed at the point of contact between the branch and flaw after 90 kV exposure (Figure 13). A distinct odor of eucalyptus could also be identified post-test, consistent with expulsion of moisture from the branch. The branch was also slightly warm to the touch, consistent with resistive heating due to the passage of current. Despite observing minor charring on the outer surface of the branch following high-voltage exposure, there was no evidence of ignition or flame spreading to other parts of the branch.

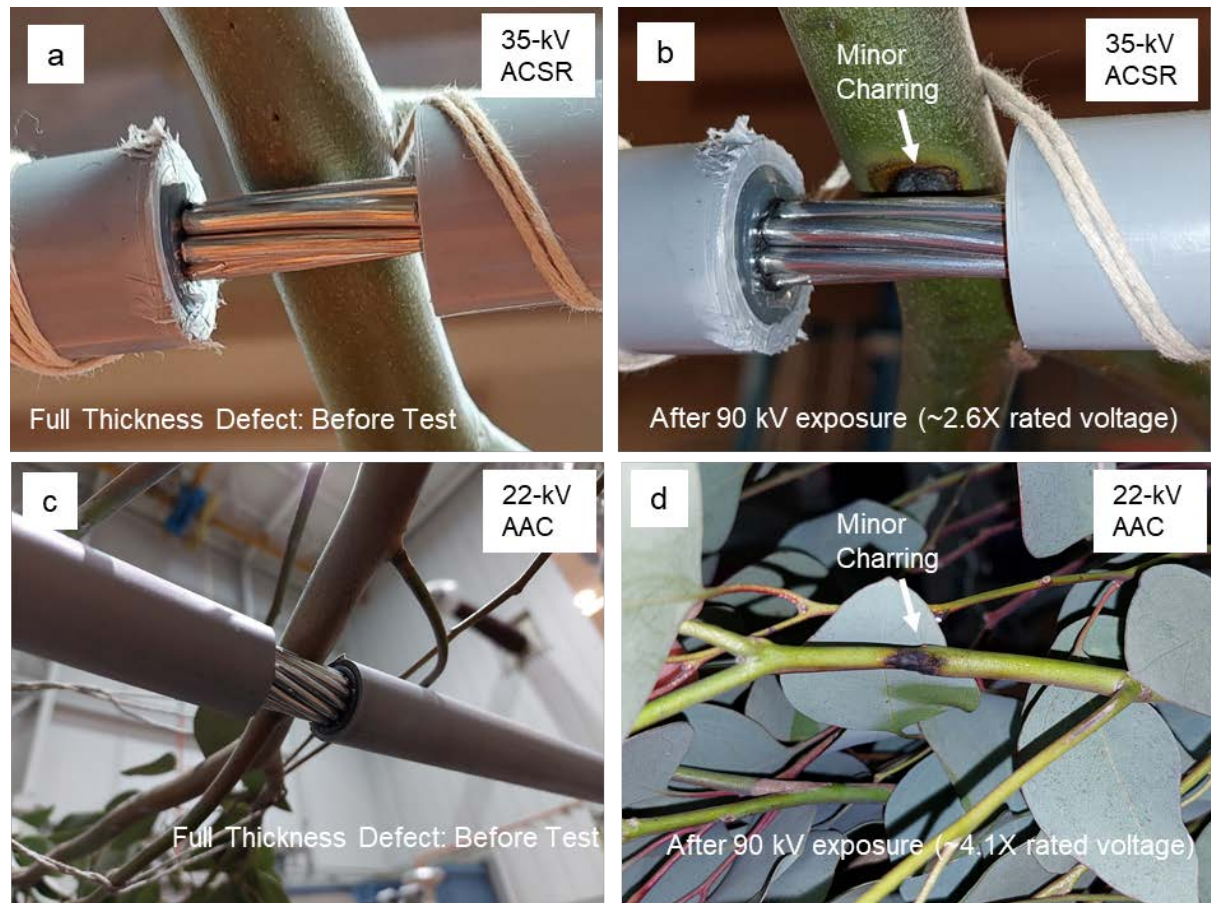

Figure 13. Full-thickness defect tests at rated voltages and extreme voltages. (a) One 17-kV ACSR CC with a full-thickness flaw and a standard CC. (b) Charring was observed at the point of contact between the branch and exposed conductor after high-voltage exposure at 90 kV (~2.6X rated voltage). (c) One 22-kV AAC CC with a full-thickness flaw and a standard CC. (d) Charring was observed at the point of contact between the branch and exposed conductor after high-voltage exposure at 90 kV (~4.1X rated voltage).

After exposure to extreme voltages, breakdown and pinhole formation were observed in all covered conductor tests with a half-thickness coating flaw (Figure 14) except for the 35-kV ACSR CC, likely due to increased sheath layer thicknesses. The statistics and breakdown voltages are presented in Table 10. In dry tests, minor charring was observed on the eucalyptus

branch at the point of contact with the flaw following breakdown and pinhole formation. Despite minor charring on the outer surface, there was no evidence of ignition or flame spreading to other parts of the branch. Charring was suppressed in the wet tests.

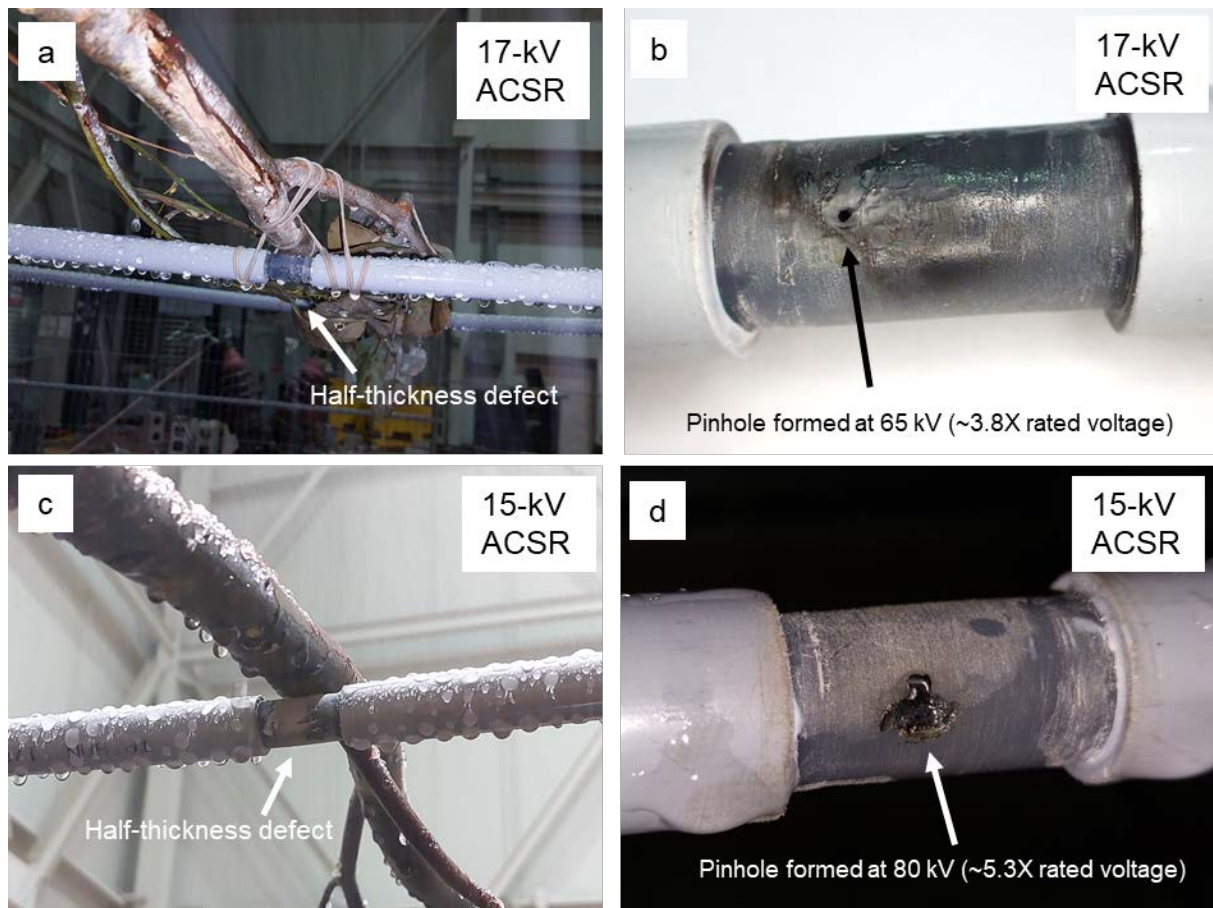

Figure 14. One CC with a simulated flaw at extreme voltages. (a) Wet 17-kV ACSR CC with a half-thickness flaw and a standard CC bridged by a eucalyptus branch. (b) Insulation breakdown and pinhole formation at 65 kV (~3.8X rated voltage). (c) Wet 15-kV ACSR CC with a half-thickness flaw and a standard CC bridged by a eucalyptus branch. (d) Insulation breakdown and pinhole formation at 80 kV (~5.3X rated voltage).

Table 10. Summary of pinhole formation in phase-to-phase contact tests at extreme voltages where one CC contains a half-thickness defect

Covered Conductor Type	Total # of Half-Thickness Defect Tests (wet + dry)	Fraction of Tests with Pinhole Observed Up to 90 kV	Average Voltage at Breakdown (kV) (times rated voltage)
15-kV ACSR CC	6	2 out of 6	65 (4.3X)
17-kV ACSR CC	6	5 out of 6	67 (3.9X)
22-kV AAC CC	6	2 out of 6	83 (3.8X)
35-kV ACSR CC	6	0 out of 6	N/A

The plots in Figure 15 present leakage currents as a function of applied voltage for the four conductor classes. Prior to breakdown, leakage currents for the half-thickness insulation flaw tests were similar to those of the standard CCs. Following the formation of the pinhole, leakage currents for the half-thickness flaw were elevated and were similar to those of the full-thickness flaw. No insulation breakdown or current increase was observed for the 35-kV ACSR CC.

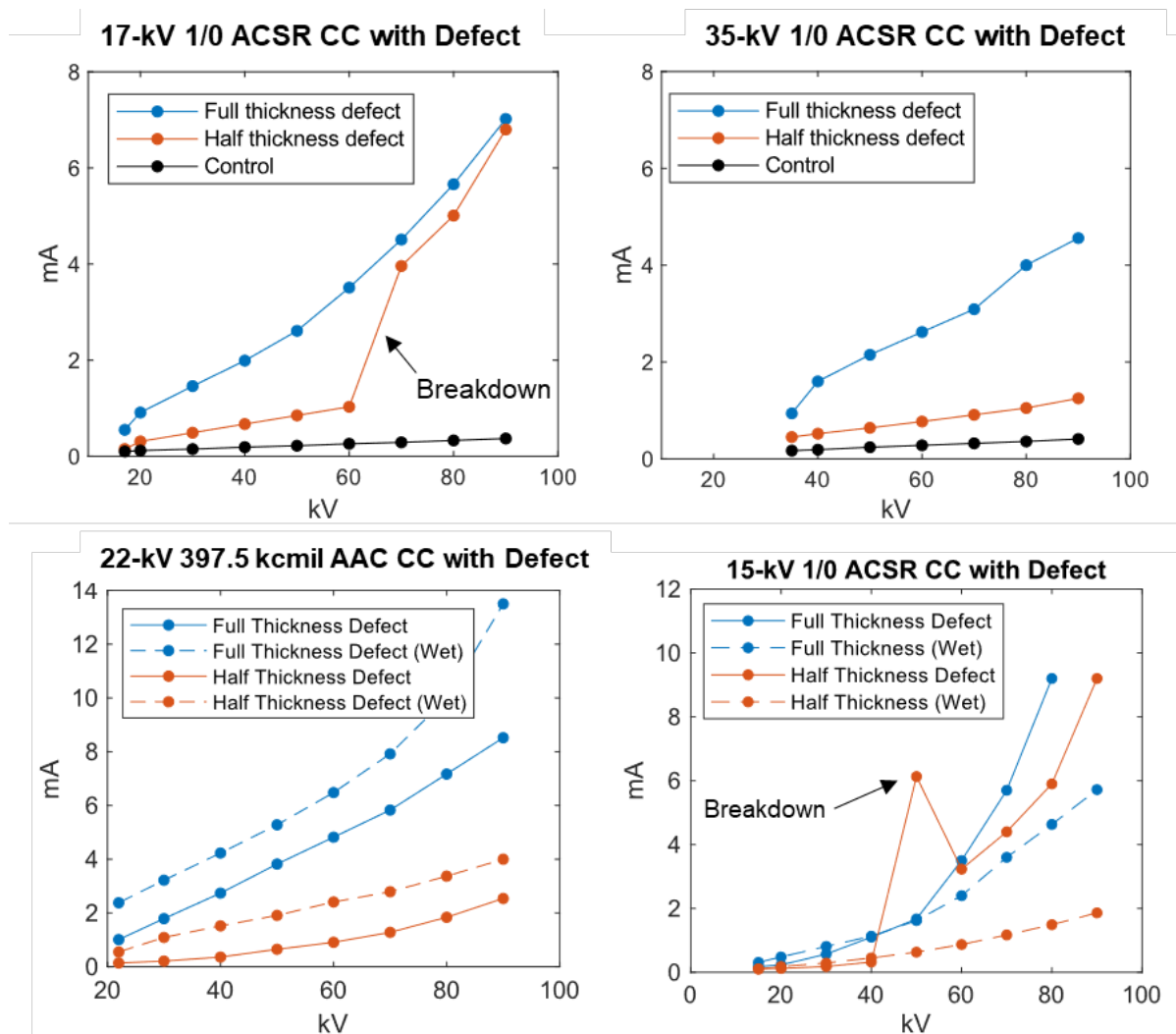

Figure 15. Leakage current as a function of voltage for one CC with a flaw and one standard CC for 17-kV ACSR (top left), 35-kV ACSR (top right), 22-kV AAC (bottom left), and 15-kV ACSR (bottom right).

One CC and One Bare Conductor at Extreme Voltage

When the bare conductor was exposed on the energized side of a mixed system, corona discharge and surface tracking were frequently observed on the grounded CC above 60 kV. Again, this was concentrated near the point of contact with the foreign object. In these cases, tracking along the insulation of the grounded conductor to the ground wire resulted in conclusion of the test prior to reaching 90 kV. Tracking to ground could be mitigated by increasing the span length of conductor.

Wildlife Guard Tests at Extreme Voltage

The wildlife guard tests were unique in that they consisted of exposed sections of bare conductor on both sides. For tests with two wildlife guards covering one-foot sections of exposed bare conductor bridged by a leafy eucalyptus branch (Figure 16a,c), breakdown through the air and around the wildlife guard occurred for three out of six tests in the range of 82 kV to 90 kV. These occurred due to branch extremities extending around the wildlife guard and near the exposed conductor. No breakdown through the air was observed when two wildlife guards were used and the bridging object was an animal simulated by raw meat.

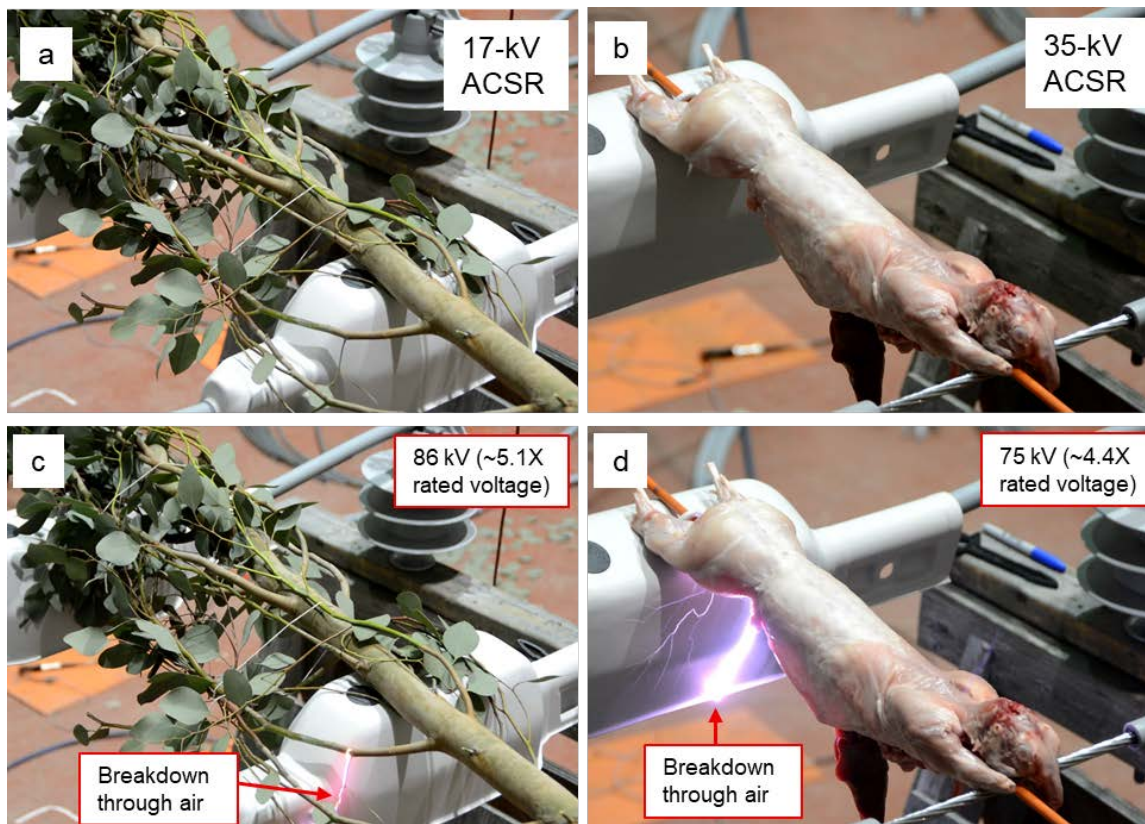

Figure 16. Wildlife guard tests. (a) Leafy eucalyptus branch test at rated voltage bridging two 17-kV ACSR CCs with animal guards covering one foot of bare conductor on either side. (b) Animal simulated by raw meat test at rated voltage bridging one 17-kV ACSR CC with an animal guard and one CC with one foot of bare conductor exposed. (c) Breakdown through the air around the animal guard observed at 86 kV (~5.1X rated voltage). (d) Breakdown through the air around the animal guard observed at 75 kV (~4.4X rated voltage).

For tests with one missing wildlife guard (Figure 16b,d), breakdown through the air occurred for all six tests between 60 kV and 75 kV. The arcs tracked around the animal guard on the grounded side. This is notably an aggressive scenario since the voltages are extreme and the foreign object is in direct contact with the bare conductor. This scenario would have a low probability of occurrence in the field.

Sequential Breakdown Testing

The purpose of the sequential test was to better understand performance of CCs following a significant overvoltage or fault, such as a lightning strike. To force breakdown, the CCs were wrapped in a grounded metal braid at midspan and were exposed to high voltage, up to 150 kV (Figure 17a,b). The large potential difference between the conductor and metal braid resulted in a strong electric field, capable of inducing a breakdown in the insulation (Figure 17c,d). Several breakdown tests were performed on 40-foot segments of covered conductor. For the first test on 17-kV ACSR CC, breakdown occurred around 95 kV. For the second test on 17-kV ACSR CC, breakdown occurred around 85 kV. Following breakdown, each conductor was exposed to high voltage a second time to effectively “grow” the flaw.

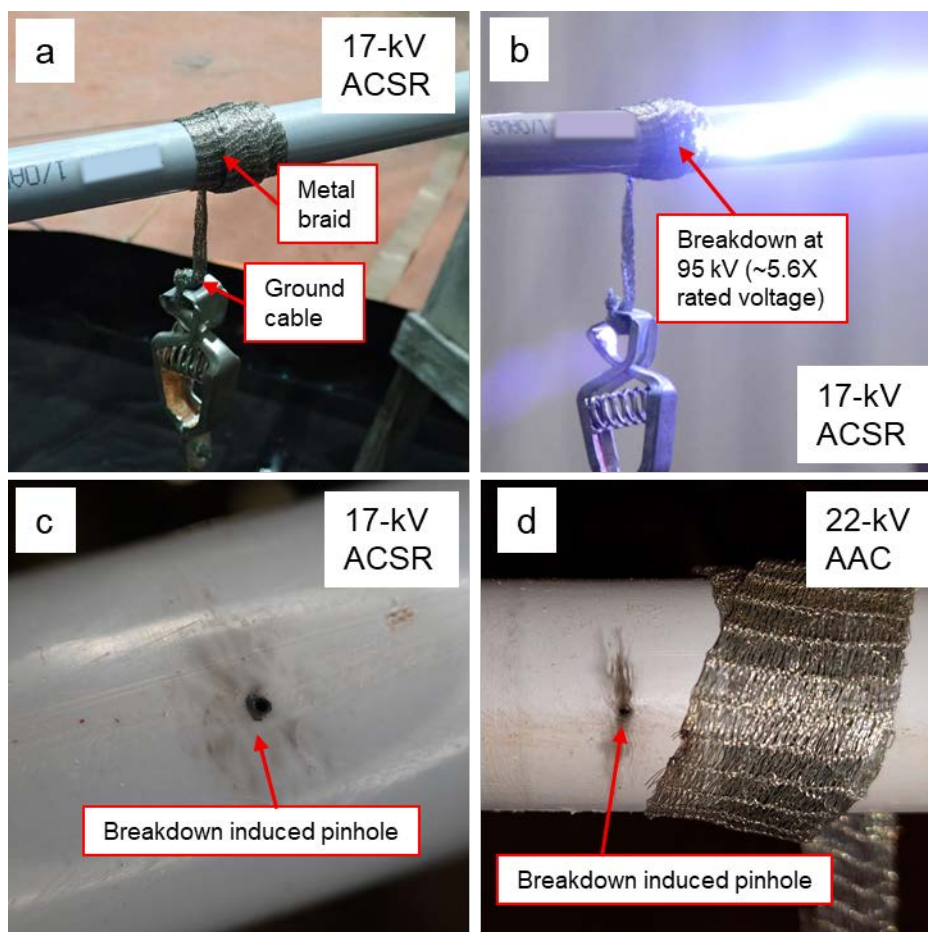

Figure 17. Breakdown test setup. (a) 17-kV ACSR CC was wrapped in a grounded metal braid and was exposed to voltage until (b) breakdown of the insulation at 95 kV resulted in (c) pinhole formation. (d) Pinhole formation in 22-kV AAC after high-voltage breakdown test.

Since the thickness of the polymer sheath was 4.31 mm, this corresponded to an approximate minimum breakdown strength between 20 kV/mm and 22 kV/mm. It should be noted that this was not an ASTM standard breakdown strength procedure, so these values are expected to differ

from values determined from standardized tests. The voltage for the 35-kV ACSR CC could not be increased above 150 kV due to high power losses from surface tracking. Given an insulation thickness of 8.02 mm, the breakdown strength of the 35-kV ACSR CC exceeded 18.7 kV/mm.

Surface tracking was a significant concern at high voltage for both conductor classes, so 40-foot spans were used to prevent damage to the equipment (Figure 18a). The presence of sustained high-voltage corona and surface tracking resulted in arc-tracking damage to the surface of the CC (Figure 18b).

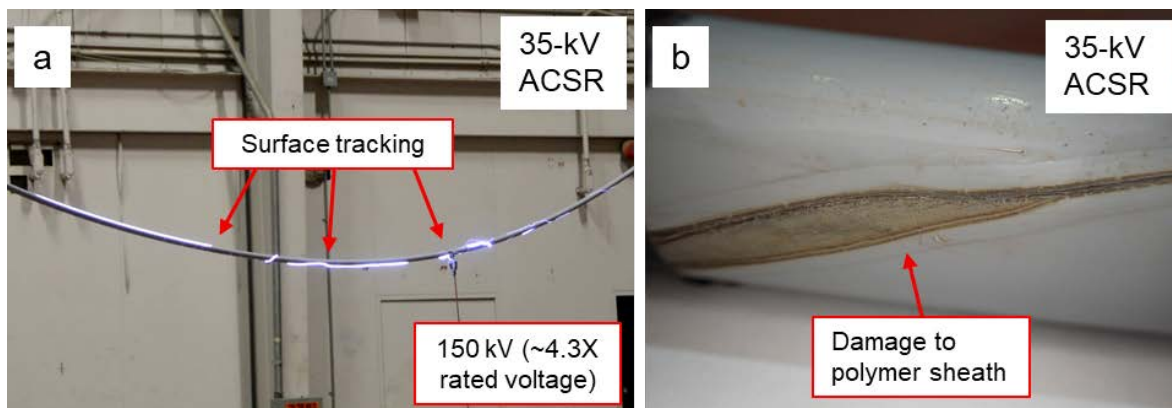

Figure 18. (a) Surface tracking during breakdown test at 150 kV in the 35-kV ACSR CC. (b) Damage to the surface of the CC due to sustained exposure to high-voltage corona and surface tracking.

The CCs with induced pinhole flaws were bridged by a leafy eucalyptus branch to one standard CC for contact testing at rated and extreme voltages (Figure 19a). The branches were tied down tightly with electrical tape to ensure good contact with the pinhole flaw. The leakage currents were stable and below 1 mA during the five-minute hold at rated voltages. Following high-voltage exposure, the defect in the covering grew in size and minor charring was observed at the point of contact with the branch (Figure 19b-d). There was no evidence of ignition or flames, and charring did not spread to other parts of the branch. Note that this represented the second extreme voltage exposure for these conductors, as the first exposure was used to induce the pinhole.

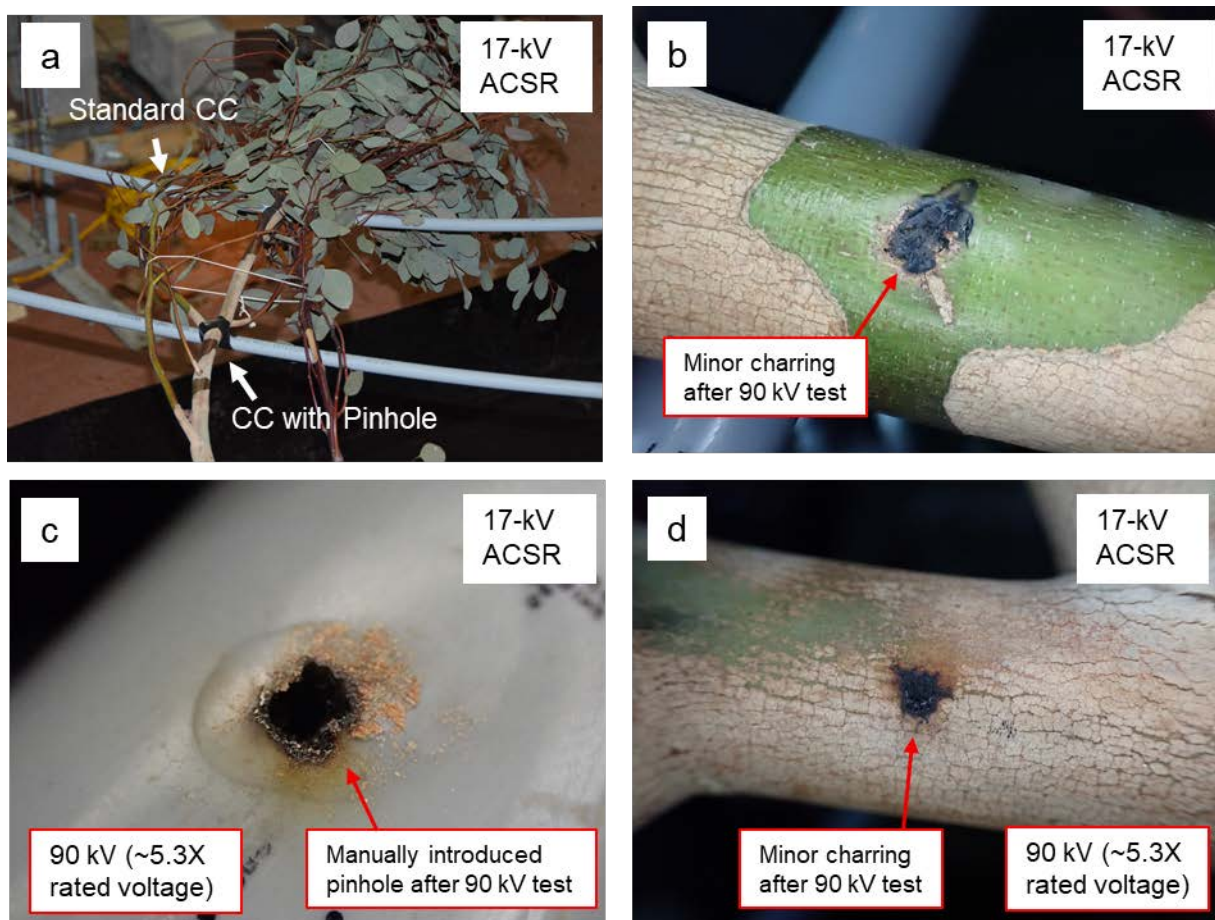

Figure 19. (a) Sequential phase-to-phase contact testing after induced breakdown. (b) Contact point showing minor charring on leafy eucalyptus branch after exposure to 90 kV. (c) Manually introduced pinhole flaw in 35-kV ACSR CC after contact testing at 90 kV. (d) Contact point showing minor charring on leafy eucalyptus branch after exposure to 90 kV.

Discussion and Conclusions: Phase-to-Phase Contact Testing

Tests with two bare conductors demonstrated the clear ignition risks associated with contact by leafy branches or other potential foreign objects. Immediately after applying voltage, the branches started screeching, consistent with the rapid expulsion of moisture, and smoking at both points of contact with the bare conductors. Leakage currents reached the maximum allowed by the test setup (2000 mA), suggesting that current was able to pass freely through the branch. Three seconds after applying voltage, ignition of the branch was clearly observed at both points of contact.

However, for tests in which at least one CC was present, no current transfer greater than 2.5 mA was detected in any scenario at rated voltages involving contact of a foreign object, splice, or conductor slapping. These results demonstrate that the insulation of the tested CCs is highly

effective at preventing current flow, arcing across phases, and ignition at rated voltages regardless of environmental condition (wet or dry), or the nature of the object between phases. The only time when significant current transfer was observed was when sections of bare conductor were exposed on *both* sides of the system.

Extended contact of a eucalyptus branch across two CCs at rated voltages for one week resulted in discoloration of the polymer sheath in all four conductor classes. The 35-kV CC suffered minor damage to the surface of the sheath in addition to discoloration. The yellowing and damage were likely due to the sustained presence of corona discharge at the point of contact with the branch. The corona effect was more significant at higher voltages. For situations in which extended foreign object contact is of particular concern, further long-term testing is recommended to investigate the impact of longer times and the effect on the insulating strength of the sheath.

CCs were also effective at preventing current flow, phase-to-phase arcing, and ignition well above their rated voltages and up to 90 kV. Leakage current magnitudes at 90 kV with two CCs present were below 9 mA for all four conductor classes. In tests with one bare conductor, and only after exposure to 90 kV, minor charring was observed on the leafy eucalyptus branches. However, there was no evidence of ignition, flame, or spreading of charring to other parts of the branch. When a half-thickness insulation flaw was manually introduced on the energized conductor, insulation breakdown occurred in the 15-kV ACSR, 17-kV ACSR, and 22-kV AAC at an average voltage of 65 kV, 67 kV, and 83 kV, respectively. No breakdown was observed up to 90 kV in the 35-kV ACSR.

Simulated Wire-Down

Scope

The Phase I literature study identified the need for additional testing to investigate the effectiveness of CCs at mitigating fire ignition risks during a wire-down event. A 2015 study commissioned by the Australian State of Victoria's Powerline Bushfire Safety Program concluded that intact CCs effectively mitigate the ignition risks posed by wire-down events.¹⁵ However, the same study also concluded that CCs with full-thickness insulation flaws may pose an ignition risk, in addition to bare conductors. The present testing investigated this scenario as well as others such as partial (half-thickness) insulation removal and a severed conductor end, as outlined in Table 11. Three flaw types were investigated for CCs: full-thickness insulation flaws, half-thickness insulation flaws, and a broken end.

Table 11. Simulated wire-down ignition risk scenarios.

Conductor Type	Flaw Type
Bare 1/0 ACSR and 397.5 kcmil AAC	N/A
CC – all four types	Standard CC (No flaw)
CC – all four types	1" full thickness sheath removed
CC – all four types	1" half thickness sheath removed
CC – all four types	Broken end

Experimental Setup

A schematic representation of the experimental setup used to conduct the simulated wire-down testing is shown in Figure 20. A 460 V AC variable power supply was "stepped up" to 7.1 kV with a transformer. The power supply was capable of producing greater than 40 amps of current depending on the overall system impedance. The conductor was suspended, energized, and abruptly dropped into the fuel bed to simulate the dynamics of a wire-down event. A high-speed control unit continuously monitored the voltage and current waveforms. Fault currents generally ranged from 6 amps to 15 amps. If a fault was generated, the control unit would trip, and the power would shut off after a set amount of time governed by an adjustable delay switch (0-1000 ms).

¹⁵ Marxsen, T. "Powerline Bushfire Safety Program, Vegetation Conduction Ignition Test Report-Final." 2015.

The expected outcome of dropping a bare conductor into the soil was the generation of a power arc with sufficient energy to cause ignition of the nearby dry grass fuel. If no fault was detected, the wire was dropped into the fuel bed two more times to confirm the result.

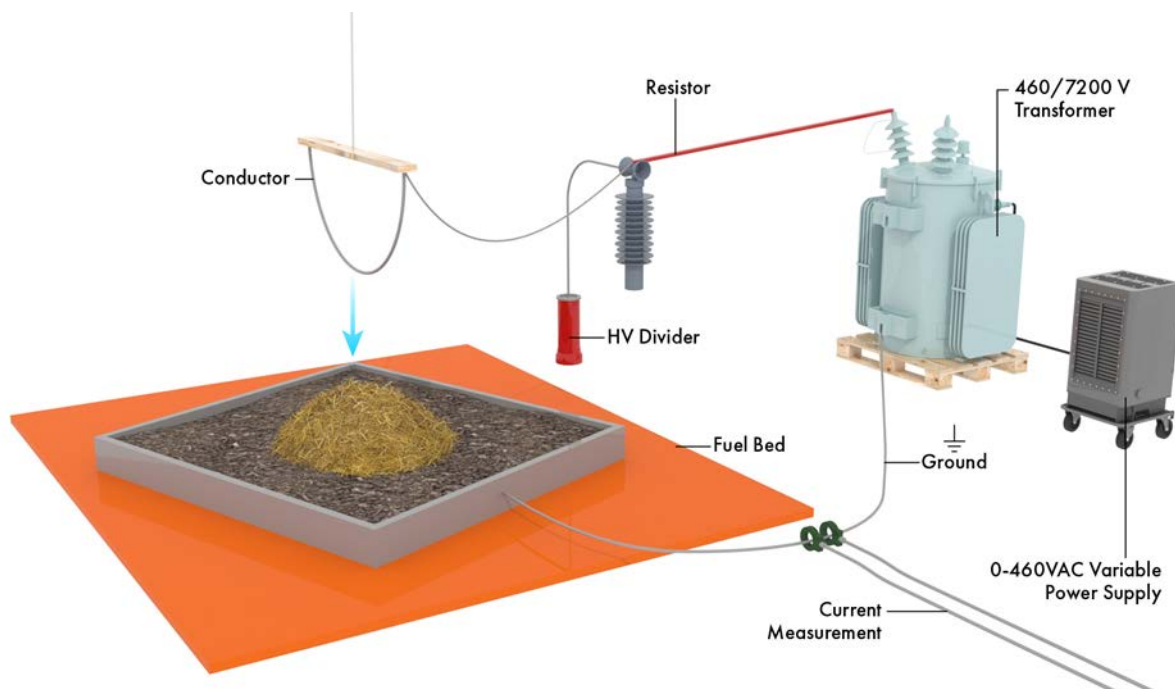

Figure 20. Schematic representation of experimental setup used in simulated wire-down testing. The conductor was energized to 7.1 kV and dropped abruptly into the fuel bed. Fault currents ranged from 6 amps to 15 amps. If no fault was observed, the conductor was dropped two more times to confirm the result.

Test development trials were performed with the bare conductor to tune the equipment and to better understand the impact of voltage, current, and fault duration on the ignition probability. These trials demonstrated that dropping a bare conductor into the fuel bed could produce a power arc at voltages as low as 1.5 kV up to 7.1 kV. This analysis also showed that the probability of ignition for a downed bare conductor depended strongly on the fault current. In these preliminary tests, fault currents ranged from 0.9 amps to 40 amps. Ignition did not occur for tests with a peak leakage current of less than 4 amps. However, ignition occurred in most tests with a peak leakage current greater than 5 amps. In later trials, a 500-ohm resistor was employed to maintain more consistent fault currents. Fault durations in development trials ranged from 17 ms to 272 ms. Trials with low current did not result in ignition regardless of fault duration whereas trials with sufficiently high current (>5 amps) resulted in ignition regardless of fault duration.

Following the development phase, equipment parameters were held constant to ensure direct comparison across the tested scenarios. The applied voltage for all “real” tests was 7.1 kV and the fault duration was 125 ms. The leakage currents remained sensitive to system impedance, but all fell within the range of 6 amps to 15 amps.

The fuel bed was composed of a soil mixture and conditioned dry excelsior in a grounded steel pan. Excelsior is a wood wool product made of fine wooden slivers cut from logs. The soil mixture, which simulated the topsoil composition from Southern California's rolling uplands, was modeled after data obtained from the University of California, Berkeley College of Agriculture's Generalized Soil Map of California.¹⁶ The soil consisted of a granular sandy loam with relatively high clay content. The soil mixture was composed of four parts organic loamy topsoil, two parts coarse deco sand, and one part natural clay by mass.

Prior to assembly of the fuel bed and testing, the excelsior was conditioned in accordance with ASTM D4933 in an environmental chamber at 104° F and 20% relative humidity for 24 hours. The approximate moisture content of the excelsior was 5% following conditioning, consistent with CAL FIRE's Powerline Fire Prevention Field Guide guidelines for simulating dry grass fuel.¹⁷ Finally, the fuel bed was assembled by placing approximately two inches of the topsoil mixture in a rectangular steel container and partially embedding the conditioned excelsior into the soil. Figure 21 shows a photograph of a representative fuel bed assembled.



Figure 21. Example of simulated California soil and fuel bed used in wire-down testing.

Electrical equipment operation and measurements were informed by IEEE4: High Voltage Testing Techniques. The soil was nominally dry during the initial testing trials. However, initial results suggested that the high resistance of the fuel bed prevented current from making it to ground. Thus, for subsequent testing, a small amount of water was added to the soil prior to each test to improve its conductivity.

Results

The results of the five tested scenarios are shown in Table 12. No arcing events were observed when standard CCs or CCs with half-thickness insulation flaws were energized to the phase-to-ground voltage and dropped into the fuel bed (Figure 22). In contrast, the bare conductor tests demonstrated a propensity for arcing and fire ignition even at voltage and current conditions

¹⁶ R. Storie and W. Weir. "Generalized Soil Map of California." California Agricultural Experiment Station Extension Service.

¹⁷ Powerline Fire Prevention Field Guide: 2008 Edition. CAL FIRE, 2008.

lower than would be expected from a real distribution system (Figure 23). Tests involving CCs in which the underlying conductor was directly exposed to the fuel bed, i.e., in the case of a full-thickness flaw or a severed conductor end, also showed propensity for arcing and ignition (Figure 24 and Figure 25). The body of this report shows representative images for the 17-kV and 35-kV ACSR CC wire-down tests. The results for the 22-kV AAC CC and 15-kV ACSR CC are presented in Appendix B.

Table 12. Results for simulated wire-down tests.

Test	Result			
	15 kV ACSR	17 kV ACSR	35 kV ACSR	22 kV AAC
Standard CC	No arcing observed	No arcing observed	No arcing observed	No arcing observed
CC w/ half-thickness flaw	No arcing observed	No arcing observed	No arcing observed	No arcing observed
Bare conductor	Arcing / ignition	Arcing / ignition	Arcing / ignition	Arcing / ignition
CC w/ full-thickness flaw	Arcing / ignition	Arcing / ignition	Arcing / ignition	Arcing / ignition
Broken CC w/ exposed end	Arcing / ignition	Arcing / ignition	Arcing / ignition	Arcing / ignition

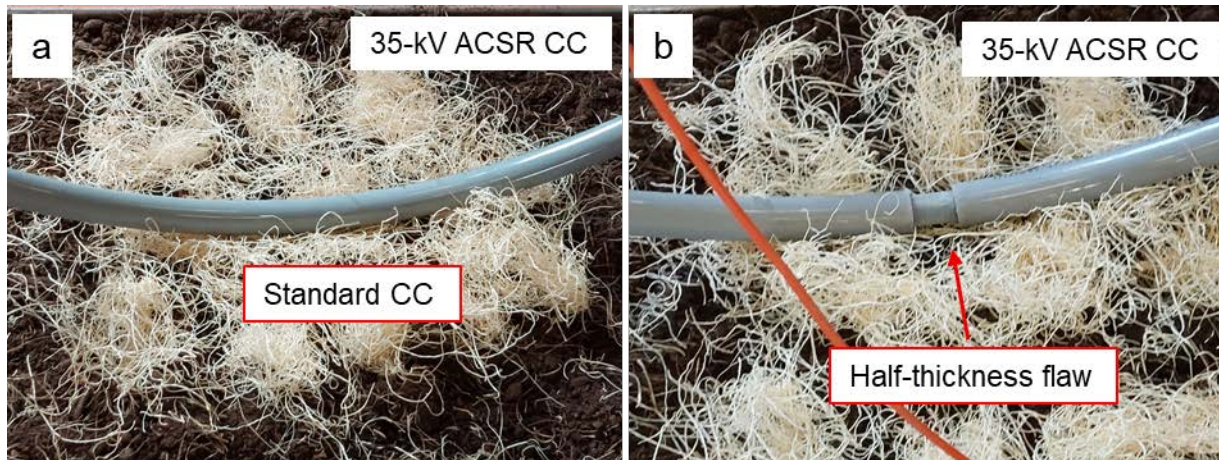

Figure 22. (a) Simulated wire-down test of a 35-kV ACSR CC. No ignition was observed after three tests. (b) Simulated wire-down test of a 35-kV ACSR CC with a half-thickness flaw. No ignition was observed after three tests.

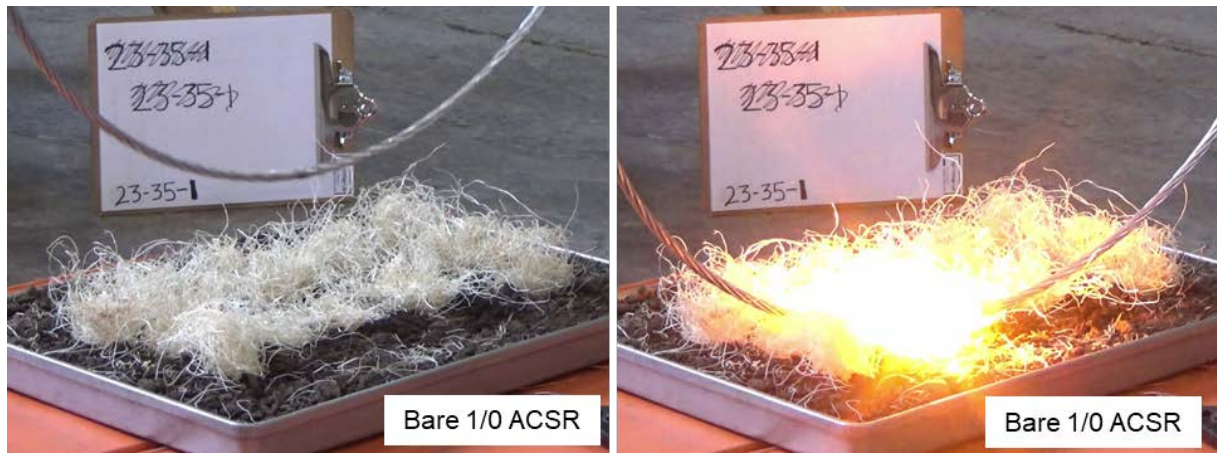

Figure 23. Simulated wire-down test of a bare ACSR conductor demonstrating the potential for ignition of the dry brush.

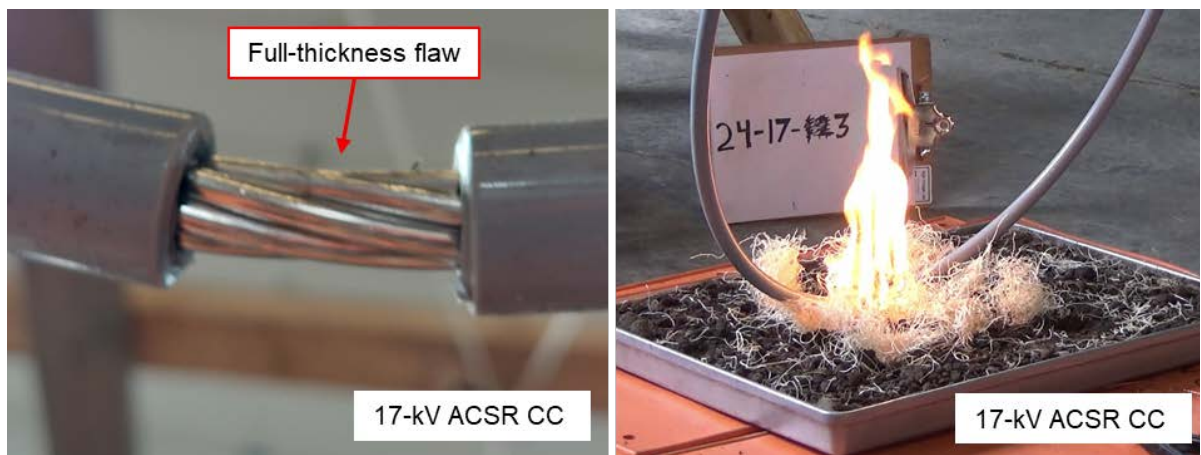

Figure 24. Simulated wire-down test of a 17-kV ACSR CC with a full-thickness flaw demonstrating the potential for ignition of the dry brush.

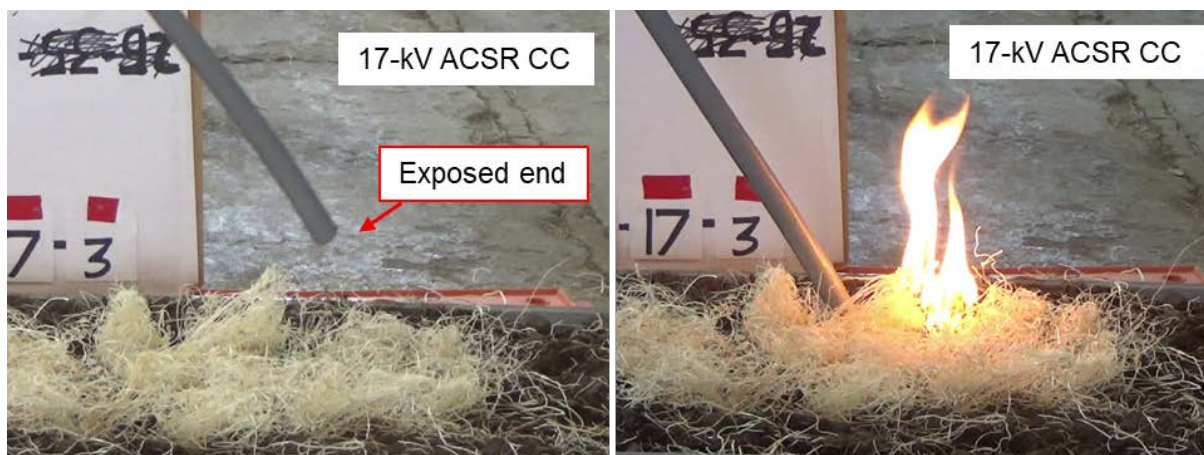

Figure 25. Simulated wire-down test of a 17-kV ACSR CC with a broken end demonstrating the potential for ignition of the dry brush.

Since arcing was not observed with the given test setup for any standard CCs or CCs with a half-thickness flaw, it was necessary to confirm that application of the full phase-to-ground voltage would also not result in arcing or insulation breakdown. Separate simulated wire-down tests were performed with a hi-pot 800 kV power supply. The CCs and CCs with a half-thickness flaw were energized to the appropriate phase-to-ground voltage and dropped into the fuel bed. No breakdown was observed for the standard CC or CC with a half-thickness flaw. This result was consistent with phase-to-phase contact tests discussed in the previous section.

Discussion and Conclusions: Simulated Wire-Down

This testing showed that CCs in a wire-down event are not likely to pose an ignition risk unless they are sufficiently damaged such that the bare wire beneath the coating is exposed and can arc to ground.

In each simulated wire-down test, one of three outcomes was observed:

1. An arc was generated, resulting in ignition of the dry fuel. The conductor impacted the soil and drew a current arc between it and the earth. The electric arc heated the nearby dry grass, generating pyrolysis gases such as methane, hydrogen, and carbon monoxide. The gases accumulated near the arc and ignited. The resultant flame heated more neighboring dry grass, generating more gases, and created a sustained fire.¹⁸ No ignition of the CC polymer sheath was observed for the test duration.
2. An arc was generated upon impact with the soil, but no sustained fire was observed. This could have occurred for a number of reasons. The arc may have been too far away from the grass to cause enough pyrolysis gases to be generated. The gases may also have dispersed and never reached the minimum concentration necessary for ignition. If an

¹⁸ Tony Marxsen. "Ignition Tests – lo-sag conductor." Powerline Bushfire Safety Program. 2015.

initial small flame did form, it may have been extinguished by windy conditions or may not have been close enough to other grasses to create sufficient pyrolysis gases required for a sustained fire. Finally, the conductor itself may have covered and extinguished the initial flame.¹⁹ Since the formation of an arc had the potential to ignite nearby fuel, regardless of whether ignition was observed in each individual test, these outcomes were categorized as a potential ignition event.

3. No arcing event or current flow was observed despite good contact between the wire and the fuel bed.

As there is a wide variety of conductor-falling velocities and angles in the field, tests were similarly varied in the velocity and incident angle of the dropping conductor. Although steps were taken to ensure consistency and conservatism in this testing, the probability of ignition was nevertheless still a function of the proximity of the generated arc to the nearest vegetation.

¹⁹ Tony Marxsen. "Ignition Tests – lo-sag conductor." Powerline Bushfire Safety Program. 2015.

Corrosion Testing

Motivation and Scope

As discussed in the introduction, the Phase I literature review recommended better understanding of failure modes specific to CCs that would not be present in bare conductor use cases. The Phase I work identified localized corrosion of CCs near stripped ends as a potential failure mode unique to CCs. While, for the most part, the polymer sheath of CCs acts to *improve* the corrosion resistance of conductors, in some cases the sheath is removed or pierced to expose or make contact to the bare conductor (e.g., at dead-end structures and connectors). Crevices may form at polymer sheath removal sites between the sheath and the conductor, and water ingress into these crevices may facilitate localized corrosion processes.

Exponent used three methods to evaluate the corrosion resistance of CCs relative to bare conductors; these tests are summarized in Table 13. These analyses probed the potential for water ingress and corrosion at the interface between the exposed conductor and the polymer sheath as well as further underneath the polymer sheath. First, water ingress testing probed how, and to what degree, liquids may enter and pass along CCs at stripped ends or connection points. Next, salt spray testing evaluated whether CCs showed accelerated corrosion relative to bare conductors under harsh environmental conditions. By artificially damaging some CCs at the stripped ends and at midspan sections, this testing evaluated whether polymer sheath damage may lead to localized corrosion acceleration. Finally, cyclic polarization testing characterized the localized corrosion resistance of CC stripped ends relative to bare conductors for both as-received samples and samples that were artificially aged in a highly aggressive environment.

Initial testing assessed the corrosion susceptibility of 17-kV ACSR and 17-kV copper CCs using all three test methods (water ingress, salt spray, and cyclic polarization) and two different stripping methods (manual stripping versus a dedicated Ripley WS5A end stripper tool). Corrosion susceptibility of the 22-kV AAC and 15-kV ACSR CCs was assessed using only water ingress and salt spray testing, as results from the cyclic polarization testing of the 17-kV CCs were not conclusive. In addition, the 22-kV AAC CC was limited to a single stripping method (using a dedicated Ripley WS64-U-EM tool), as different stripping methods were not observed to significantly affect the corrosion susceptibility of the 17-kV CCs. Finally, the 15-kV ACSR CC testing was primarily focused on the use of insulation-piercing connectors (IPCs) rather than stripping lengths of polymer sheath, as this is the implementation method reportedly used by SDG&E in the field. The 35-kV ACSR CC was not tested, as the underlying metal conductor is the same as in the 17-kV ACSR CC case.

Table 13. Detailed test matrix for evaluating corrosion resistance of CCs relative to bare conductors.

Test Method	Conductor Type	Stripping Method	Strip/Damage Type
Water Ingress	17 kV ACSR CC	Ripley ¹	End Strip
		Manual	End Strip
	17 kV Cu CC	Ripley ¹	End Strip
		Manual	End Strip
	22 kV AAC CC	Ripley ²	Midspan Strip
15 kV ACSR CC	-	IPC	
Salt Spray	17 kV ACSR CC	Ripley ¹	End Strip
			Midspan Damage
			Artificial Crevice
		Manual	End Strip
			Midspan Damage
			Artificial Crevice
	17 kV Cu CC	Ripley ¹	End Strip
		Manual	Midspan Damage
			End Strip
	17 kV Bare ACSR	-	-
	17 kV Bare Cu	-	-
	22 kV AAC CC	Ripley ²	End Strip
			Midspan Damage
			Artificial Crevice
22 kV Bare AAC		-	-
15 kV ACSR CC		-	IPC
15 kV Bare ACSR	Ripley ²	Midspan Damage	
15 kV Bare ACSR	-	-	
	Ripley ¹	End Strip	
		Artificial Crevice	
	Manual	End Strip	
		Artificial Crevice	
	Cyclic Polarization: (as-received and after 1 week immersion testing)	17 kV ACSR CC	Ripley ¹
Manual			Artificial Crevice
17 kV Cu CC		Ripley ¹	End Strip
		Manual	End Strip
17 kV Bare ACSR	-	-	
17 kV Bare Cu	-	-	

¹ Ripley WS5A End Stripper Tool

² Ripley WS64-U-EM Cable Stripper Tool

Different polymer sheath stripping techniques generate different sheath/conductor interfaces, as illustrated in Figure 26. For some samples, Exponent used a dedicated and assumed representative cable stripping tool (Ripley) to remove the sheath from the CCs. Although this tool easily removed the polymer sheath, it left a visible gap between the sheath and the conductor at the stripped interface (Figure 26a). The presence of such gaps may allow for water ingress and thus may enhance localized corrosion of the conductor. To assess differences, a “manual” stripping method was also investigated. This consisted of cutting into the polymer sheath with a razor blade and then manually removing it. This technique generally resulted in smaller gaps between the polymer sheath and the conductor but resulted in minor damage to the conductor at the stripped interface due to razor blade contact with the conductor strands (Figure 26b). Further, some variability in workmanship (i.e., damage) is expected to occur occasionally in the field during sheath removal and may affect the corrosion susceptibility of the conductor. To model an example of poor workmanship, Exponent induced “artificial crevices” at the stripped ends by cutting into the polymer sheath and removing a small area of the PE. Electrical tape was then applied to cover the cut-away area and form an occluded area at the sheath/conductor interface (Figure 26c). In addition, artificial damage on “midspan” areas of the conductor was used to mimic abrasion of CCs. A small area of the polymer sheath was cut away using a razor blade and the area was then left exposed during testing (Figure 26d). For the 15-kV ACSR CCs, IPCs installed on CCs (Figure 26e) were tested as received.

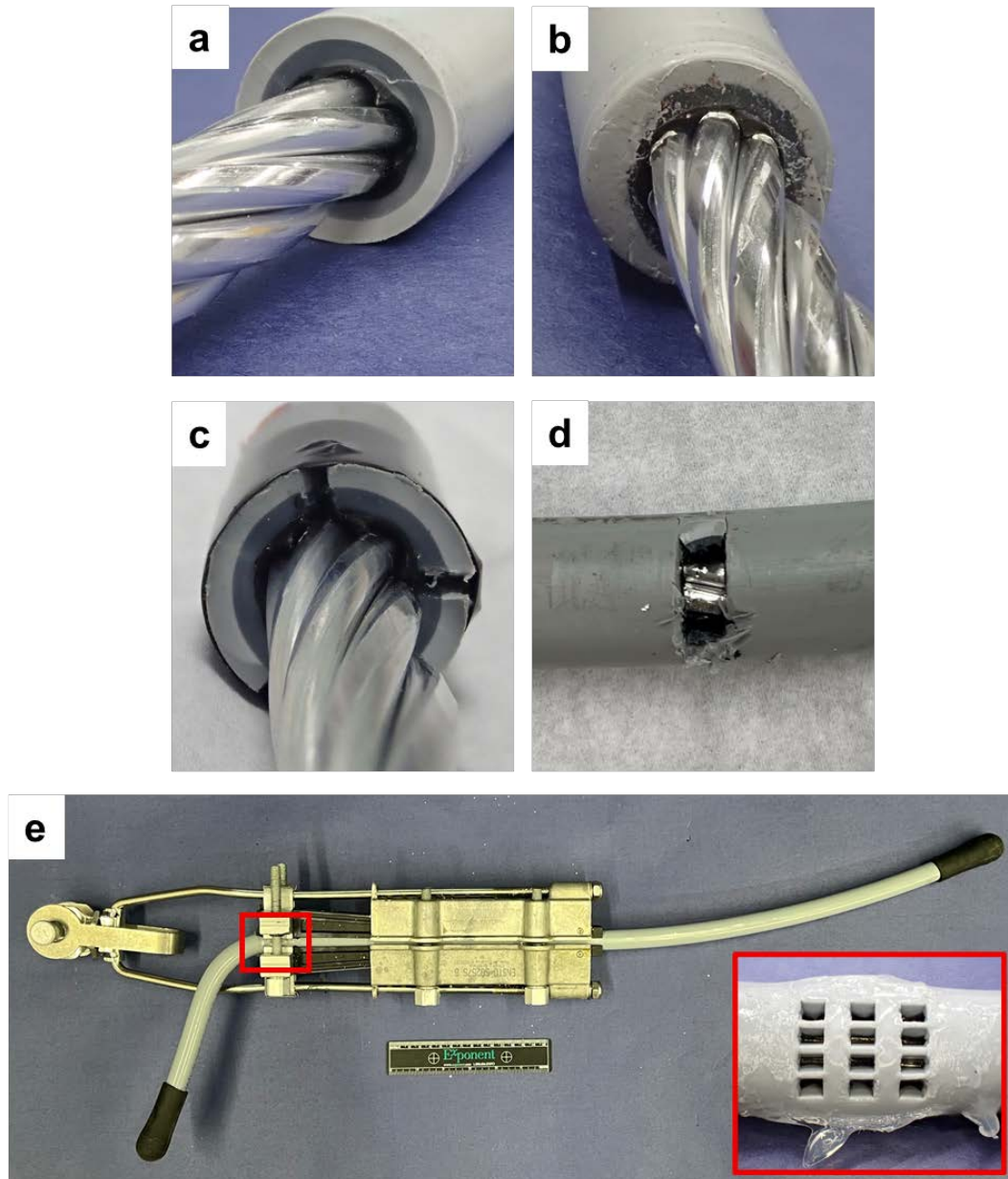

Figure 26. Representative images showing (a) Ripley and (b) manual stripping techniques and (c) creviced end (intended to mimic poor workmanship), (d) midspan artificial damage (to simulate abrasion), and (e) IPCs (inset shows pierced CC area after IPC is removed) used throughout testing.

Water Ingress Testing

Water ingress testing evaluated the ability of water to enter a CC at a stripped or exposed area and to percolate down the length of the conductor once inside.

Experimental Setup

Water ingress testing procedures were adapted from ANSI/ICEA T-31-610-2018 Section 4.²⁰ A schematic of the test setup is provided in Figure 27. For the 17-kV CCs, Exponent removed a ~2.5-inch section of the polymer sheath from one end of a length of CC. The remaining length was cut such that the covered section measured ~36 inches in length. Exponent tested six samples each of 17-kV ACSR CC and 17-kV copper CC. Of each of these six, three were stripped using the Ripley WS5A tool and three were stripped manually. The prepared conductors were then vertically mounted with the stripped end at the top. A watertight upper reservoir was attached such that the top of the reservoir was above the top of the stripped end and the bottom of the reservoir was below the bottom of the stripped end. Subsequently, a mixture of water and fluorescent dye was introduced to the reservoir such that the liquid level covered a portion of the stripped section, not including the bare conductor end. The far end of the conductor was monitored for leakage. If liquid was observed at the far end, the polymer sheath was removed, and the conductor and polymer sheath were visually inspected to identify the ingress pathway.

Similar testing was performed with the 22-kV AAC CCs and 15-kV ACSR CC; each of these conductor types was tested in duplicate. For the 22-kV AAC CC, the test procedure was similar to that used for the 17-kV CCs except that a ~2.5-inch section of the polymer sheath was removed using a Ripley tool from a midspan area near the end of the conductor wire. This method was used to prevent spreading of individual aluminum strands when cut at a free end, which could potentially introduce additional water ingress pathways. For the 15-kV ACSR CC, the entire IPC assembly was submerged in a container of water with the cable ends sticking out so they were isolated from liquid contact. The ends of the cable were monitored for liquid output. These tests were performed with pure water, as, in the event of liquid ingress, the longitudinal ingress pathway is expected to be similar to that observed with the 17-kV CCs.

The conditions in this test are far more aggressive than those encountered in the field (i.e., conductors in the field would not be mounted vertically and/or fully immersed in liquid, and resistive heating may reduce liquid ingress on live lines). However, these conditions were modeled after the ICEA T-31-610-2018 standard and conservatively identify potential ingress paths.

²⁰ ICEA T-31-610-2018 “Test Method for Conducting Longitudinal Water Penetration Resistance Tests on Blocked Conductors,” Insulated Cable Engineers Association, 2018.

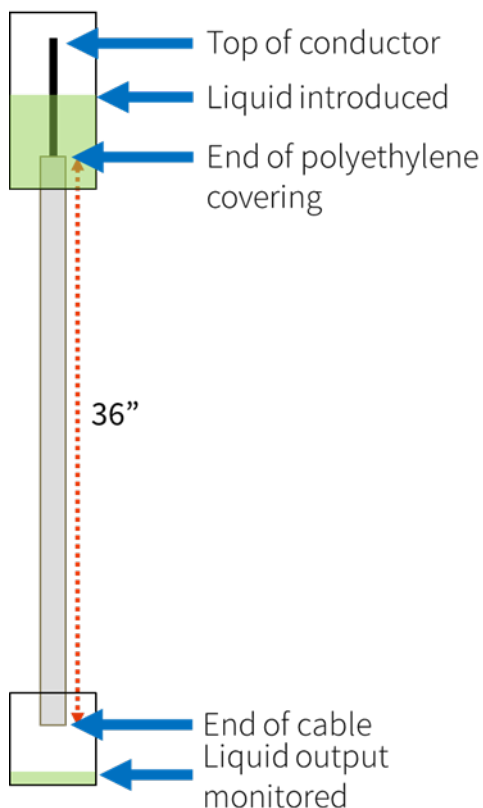

Figure 27. Schematic of water ingress test configuration. Liquid was introduced to the stripped end of a CC 36 inches in length, and the far end was monitored for liquid output.

Results

- Liquid easily passed through the length of the CCs without externally applied pressure for all CC types. Liquid ingress and flow seemed to occur primarily between the individual conductor strands, although some minor liquid flow was also observed between the conductor and the polymer sheath for 17-kV ACSR CCs.
- Although IPCs do not require stripping of the covering, liquid was still found to pass through the cover-piercing location to the metal conductor under full immersion.
- Liquid ingress did not appear to be significantly affected by the stripping method used.
- Although these conditions are extreme relative to what would be encountered during normal use conditions in the field, the results indicate that it is possible for liquid to enter beneath the polymer sheath of a CC and to traverse distances and possibly collect at low spots.

In all cases, liquid passed through the full sample length without externally applied pressure. Representative photographs of liquid ingress testing for 17-kV ACSR, 17-kV copper CCs, and 15-kV ACSR CCs with IPC hardware are presented in Figure 28, Figure 29, and Figure 30, respectively.

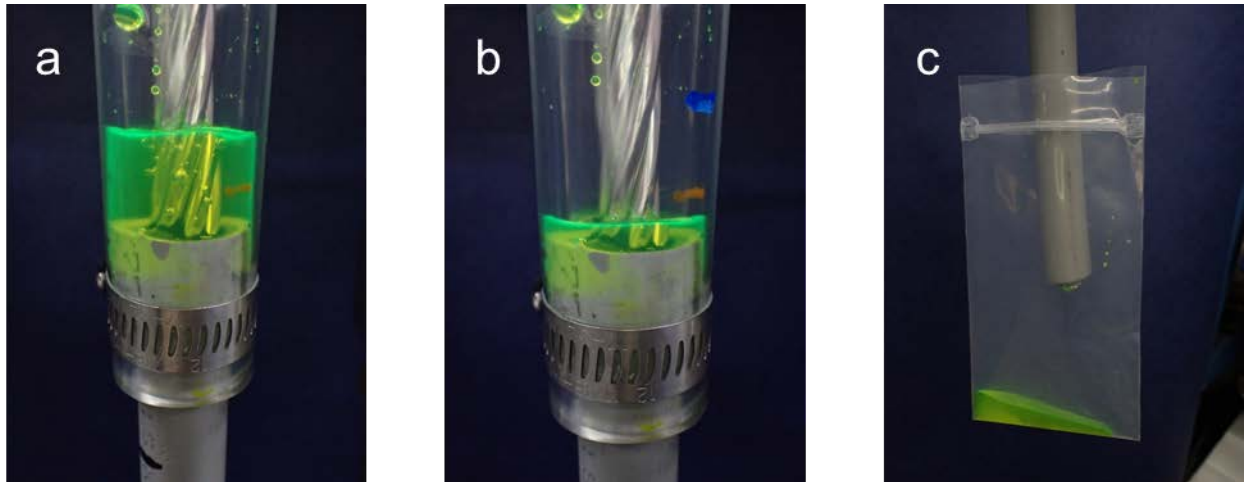

Figure 28. Representative photographs of liquid ingress testing performed on 17-kV ACSR CCs. (a) Liquid was introduced to the stripped end of a 17-kV ACSR CC at $t=0$. (b-c) After five minutes, the liquid level had dropped significantly at the stripped end (b), and liquid output was observed at the far end of the CC (c).

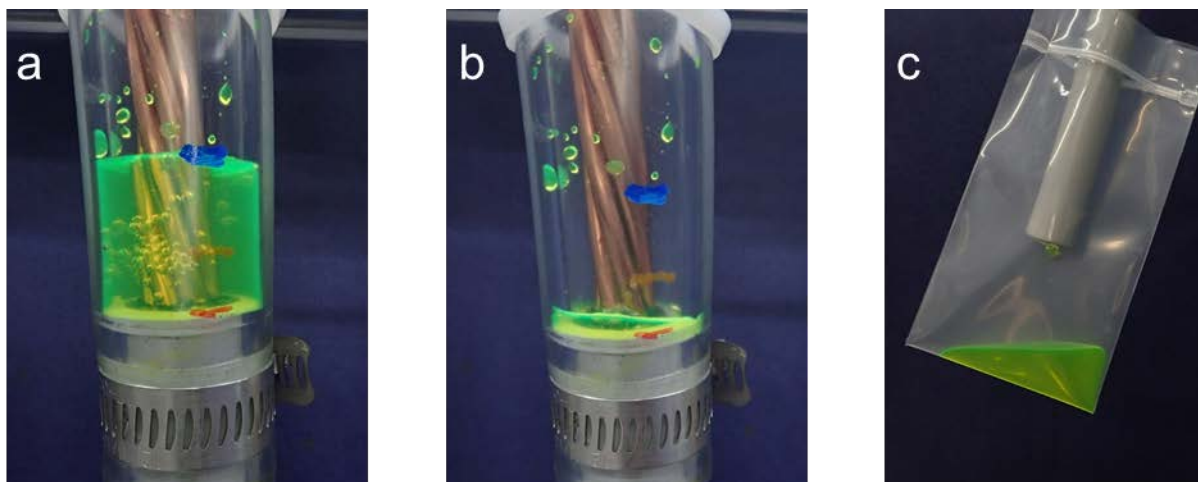

Figure 29. Representative photographs of liquid ingress testing performed on 17-kV copper CCs. (a) Liquid was introduced to the stripped end of a 17-kV copper CC at $t=0$. (b-c) After five minutes ($t=5$), the liquid level had dropped significantly at the stripped end (b), and liquid output was observed at the far end of the CC (c).

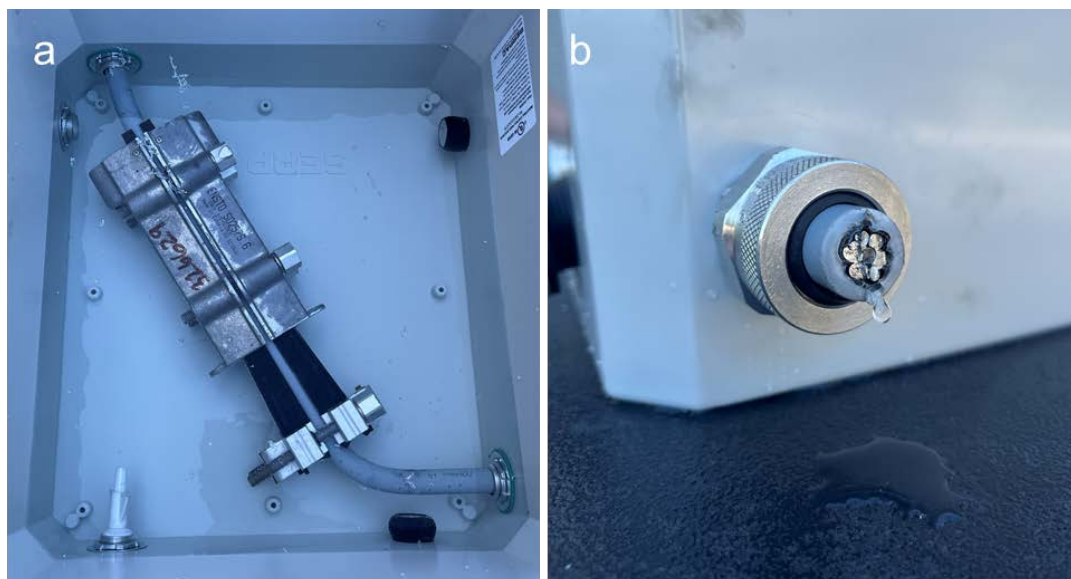

Figure 30. Representative photographs of liquid ingress testing performed on 15-kV ACSR CCs with IPC hardware. (a) The CC with IPC hardware was placed in a water reservoir with the cut ends outside of the reservoir. (b) Liquid output was observed at the cut ends outside of the reservoir.

Following testing of the 17-kV CCs, Exponent stripped and examined the conductors to determine the flow path. Figure 31 shows representative photographs of the flow paths in 17-kV ACSR and 17-kV copper CCs. In both cases, fluorescence was observed between individual strands and around the conductor core. All six 17-kV ACSR samples exhibited some evidence of flow on the stripped polymer sheath, while only one 17-kV copper conductor presented similar evidence. These results suggest that flow along the interface between the conductor

strands and polymer sheath may occur more readily in the ACSR CCs than in the copper CCs. However, further study would be required to better understand this observation. Figure 32 shows representative photographs of the flow paths on the polymer sheaths from 17-kV ACSR and copper CCs (Figure 32a, b, respectively). No clear differences in flow path or flow speed due to the stripping method (Ripley versus manual) were identified. The 22-kV AAC CCs and 15-kV ACSR CCs were not disassembled after testing, but in all samples tested liquid flow at the cable end was observed between the individual strands and around the conductor core.

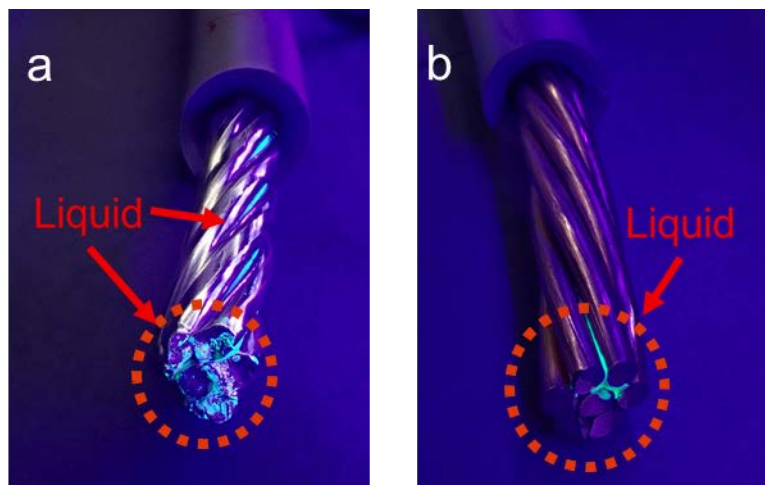

Figure 31. Representative photographs of (a) 17-kV ACSR and (b) 17-kV copper conductors after water ingress testing and sheath removal. Fluorescence was observed between the individual strands as well as around the core.

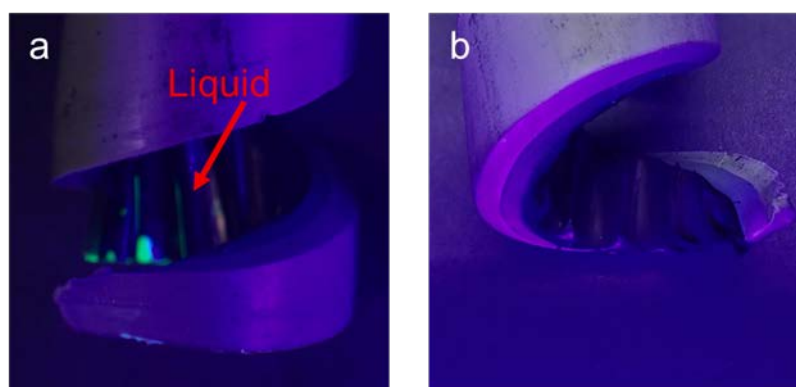

Figure 32. Representative photographs of polymer sheaths from (a) 17-kV ACSR and (b) 17-kV copper CCs after water ingress testing and sheath removal.

While these results indicate that liquid ingress may pose a risk for CCs, the conditions investigated present a far more extreme case than would likely be observed during actual operation. In addition to the extreme conditions (i.e., immersion of the stripped end and vertical mounting, full immersion of the IPC), this analysis neglects potential passive factors that may

reduce ingress (i.e., heating of the conductor improving evaporation and reducing crevice size due to thermal expansion) and active remediation methods (e.g., wildlife guards acting as rain shields). Nevertheless, this risk is worth considering, and appropriate mitigation measures may be warranted.

Salt Spray Testing

Salt spray testing was performed to evaluate the relative performance of bare conductors to CCs with stripped ends. This testing presents a highly aggressive environment containing both sodium chloride (NaCl) and sulfur dioxide (SO₂) fog to accelerate atmospheric corrosion over a short period of time. Although this environment is likely much more aggressive than what would be observed in the field, it does provide a means of comparing the relative corrosion performance of different types of conductor systems (bare versus CCs with exposed sites). This test is not designed to be representative of any specific duration of time in service. The test conditions were further exacerbated by introducing artificial crevices and/or localized damage (simulated midspan damage) to the polymer sheath to serve as positive controls.

Experimental Setup

Salt spray testing was performed using a salt spray chamber configured as shown in Figure 33. The tests were run in accordance with ASTM G85-19 Standard Practice for Modified Salt Spray (Fog) Testing using the conditions outlined in Annex 4.²¹ A standard 5 wt.% NaCl solution was used (5 parts NaCl and 95 parts H₂O by weight). The setup was arranged to prevent liquid pooling or dripping of one sample onto another. The salt fog was supplied continuously to the chamber, and SO₂ gas was introduced for one hour every six hours, as indicated in Figure 34. The salt fog and SO₂ were introduced via a large tube located centrally in the chamber. The samples were dispersed around the tube and were oriented approximately 60–75° off the vertical to mimic the orientation of overhead conductors under tension. The test chamber was held at 35° C ± 2° C, and the total exposure time was 168 hours (one week). These conditions simulate severe environmental conditions, which may be encountered only intermittently, if at all, in the field (i.e., very near the coastline or in the vicinity of heavy industry). At the end of the 168-hour exposure, the samples were rinsed with deionized water and allowed to dry for 24 hours. Approximately one week later, the samples were disassembled: the polymer sheath was stripped to expose regions that were covered during testing, and the conductors were disassembled into their constituent individual strands. The exposed conductor strands were further cleaned by rinsing under running tap water and cleaning with a soft brush. Samples were then visually inspected using an optical microscope, and tensile testing was performed on conductor strands to evaluate any reduction in strength due to corrosion.

²¹ ASTM G85-19 “Standard Practice for Modified Salt Spray (Fog) Testing,” American Society for Testing and Materials, 2019.

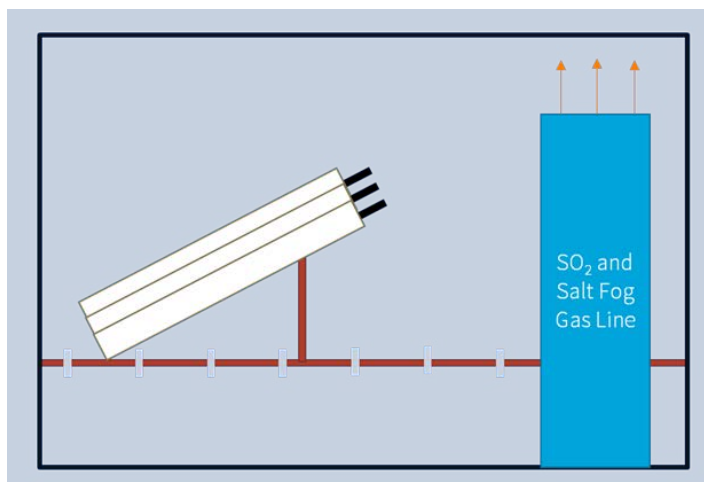

Figure 33. Schematic of salt spray testing apparatus. SO_2 and 5 wt.% salt fog were introduced through a central tube. Samples were arranged on a plastic platform with grid openings to prevent pooling of runoff. The samples were oriented approximately $60\text{--}75^\circ$ from vertical.

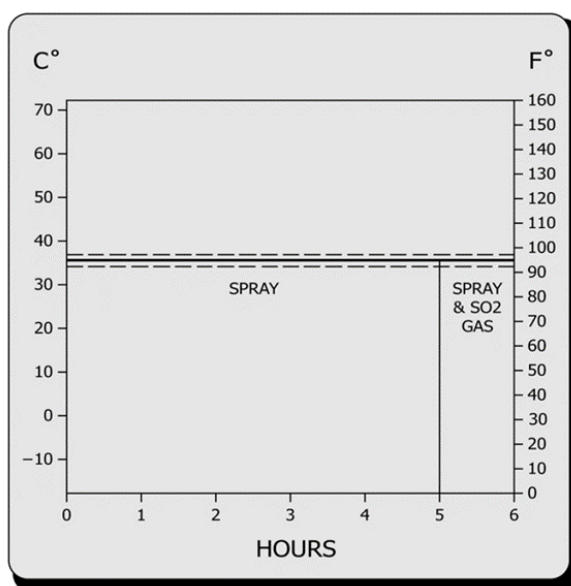

Figure 34. SO_2 /salt fog test conditions. The chamber was held at $35^\circ\text{C} \pm 2^\circ\text{C}$ and salt fog was introduced continually for 168 hours. SO_2 was introduced for one hour out of every six, as indicated. From ASTM G85-19: Standard Practice for Modified Salt Spray (Fog) Testing.²²

²² ASTM G85-19 “Standard Practice for Modified Salt Spray (Fog) Testing,” American Society for Testing and Materials, 2019.

Results

- Corrosion was observed on both bare conductors and on stripped CCs for 17-kV ACSR, 17-kV copper, and 22-kV AAC. Corrosion was observed on bare and CCs with midspan damage for 15-kV ACSR. Corrosion on CCs occurred both on regions that were exposed and on regions that were covered by the polymer sheath during testing.
- No corrosion was observed on 15-kV ACSR CCs with IPC hardware installed.
- Corrosion severity was variable, and in some tests the corrosion observed on regions beneath the polymer sheath was more severe than that observed on exposed, uncovered regions. Corrosion beneath the polymer sheath was observed to occur as far as 2–3 feet from the nearest exposed end. This distance also represents the maximum covered length used in these tests.
- For 17-kV ACSR conductors, corrosion occurred on both aluminum and galvanized steel strands. Similarly, corrosion was observed on both exterior and core strands for 17-kV copper conductors.
- For the 22-kV AAC conductors, corrosion primarily occurred on the outer aluminum strands.
- The stripping method and artificial crevicing at stripped ends did not appear to significantly affect the extent of corrosion on CCs. However, the presence of midspan damage did appear to result in corrosion that was more severe than that resulting from the stripped end.
- Salt spray testing was not observed to result in an appreciable change in the tensile strength of either copper conductor strands or ACSR steel core strands for the 17-kV and 15-kV conductors. A decrease in tensile strength was not observed for salt-spray-tested AAC CCs relative to either as-received or salt-spray-tested bare AAC conductors.
- Tensile testing on aluminum strands from salt spray tested ACSR CCs (without IPC hardware) showed a measurable difference in tensile strength relative to equivalent aluminum strands from both as-received bare conductors and bare conductors after salt spray testing. However, as this difference may be attributable to annealing of the conductor strands during the application of the polymer sheath, additional controls are needed to better elucidate the effect of corrosion on mechanical strength.
- Despite the measured decrease in strength of the aluminum strands from salt-sprayed ACSR CCs, the calculated overall conductor strength, which assumed six equivalent aluminum strands and a single steel strand, did not show a significant (> 10%) difference in ultimate tensile strength between salt-sprayed ACSR CCs (without IPC hardware) and either the as-received bare ACSR conductors or the bare ACSR conductors after salt spray testing.
- Tensile testing on aluminum strands from salt-sprayed ACSR CCs with IPC hardware showed a measurable decrease in tensile strength relative to equivalent aluminum strands from as-received bare conductors. This decrease is due to mechanical damage to the strands from IPC installation.
- Although Exponent expects that the testing conditions investigated here are much more extreme than what would typically be encountered in the field, the results indicate that it is possible for corrosion to occur beneath the polymer sheath of CCs near stripped ends.

Visual Characterization

17-kV ACSR Conductors (Stripped)—Aluminum Strands

Individual aluminum and steel strands from ACSR conductors were targeted for analysis. As the aluminum strands are in direct contact with the polymer sheath on the ACSR CCs and the galvanized steel core, they may be prone to crevice corrosion. Figure 35 presents representative optical microscopy images from salt-spray-tested aluminum conductor strands taken from bare 17-kV ACSR conductors (Figure 35a) and 17-kV ACSR CCs (Figure 35b-d). Both the bare and covered 17-kV ACSR conductors showed evidence of shallow localized corrosion (pitting) following salt spray testing. Given the aggressive nature of the test environment, the corrosion observed on both the bare conductors and the CCs was relatively minor. However, the CCs showed evidence of pitting both on areas that were exposed during testing and on areas that were underneath the polymer sheath. The pitting underneath the covered regions also appeared, in some cases, to be more severe (qualitatively) than the pitting observed on the bare conductor. There did not appear to be a clear correlation between extent of corrosion damage and stripping method. The most severe pitting was observed on the covered regions adjacent to midspan damage, as shown in Figure 35d. Exponent observed evidence of corrosion at the midpoint between the stripped end and the cut end, at least 10–15 cm from the nearest exposed metal (either the stripped end or the cut end). Salt spray testing thus demonstrated that corrosion can occur on the 17-kV ACSR CC at least 10–15 cm from the nearest exposed metal. Additional studies with longer sample lengths would be needed to conclusively determine the maximal longitudinal distance beneath the polymer sheath that corrosion may occur away from exposed metal.

As it is expected that damage to the polymer sheath may occur during stripping in the field, this testing additionally sought to determine if the presence of large, artificially induced crevices at the stripped ends would lead to more severe localized corrosion. However, unlike in the midspan damage case, the corrosion appears relatively similar between the artificially creviced and cleanly stripped samples (not shown). This observation suggests that large or intentionally introduced crevices are not a requirement for corrosion to occur beneath the polymer sheath.

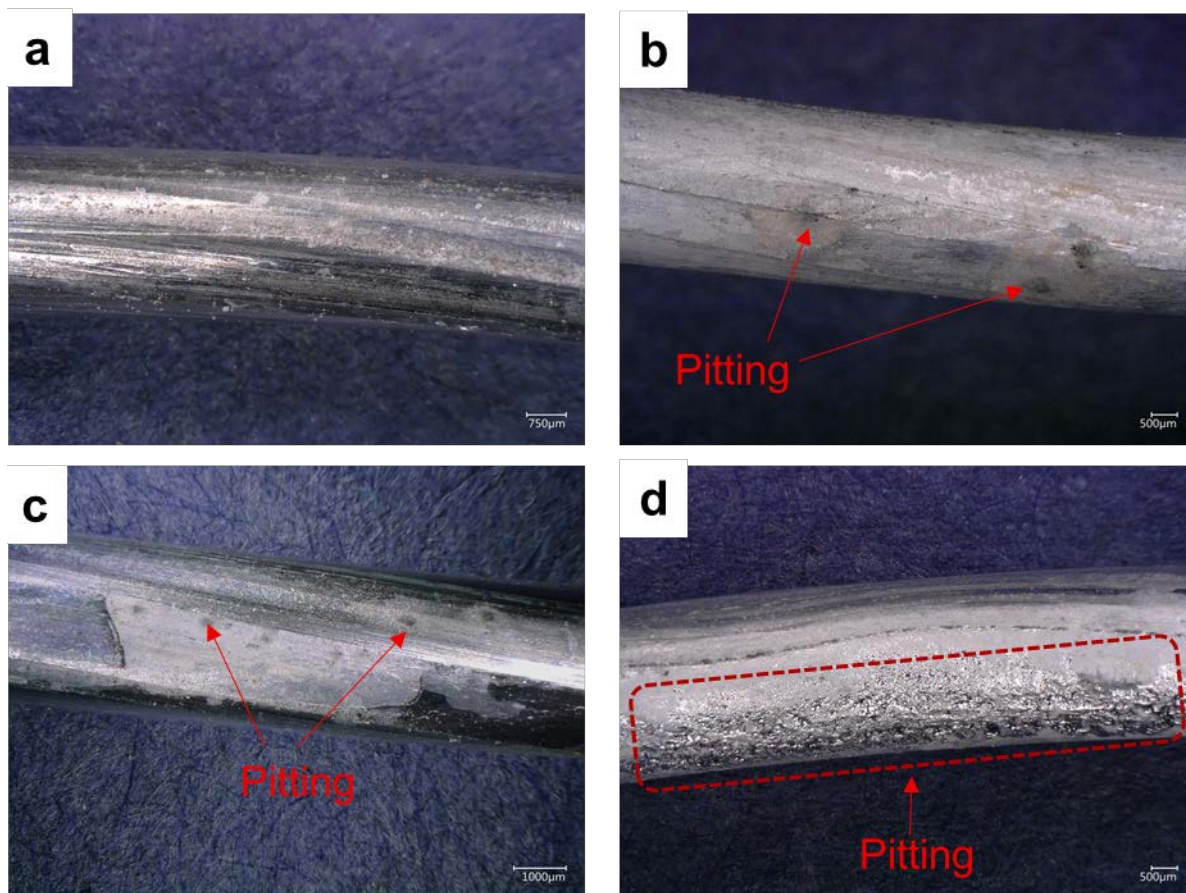

Figure 35. Representative optical microscopy images of aluminum conductor strands from (a) a bare 17-kV ACSR conductor and (b-d) covered regions of 17-kV ACSR CCs after salt spray testing. The polymer sheath was stripped from CCs samples prior to testing (b) using a Ripley tool or (c) manually; in addition to being stripped at one end, (d) was damaged along a midspan section. For CCs, pitting corrosion was observed underneath the polymer sheath regardless of the stripping method. The pitting associated with the midspan damage appeared to be the most severe of the four cases investigated (d).

17-kV ACSR Conductors (Stripped)—Steel Core

Galvanized steel core strands from both covered and bare 17-kV ACSR conductors were also inspected. Figure 36 presents a comparison of the galvanized steel core strand from a bare 17-kV ACSR conductor (Figure 36a) and the galvanized steel core strands from underneath the polymer sheaths of 17-kV ACSR CCs (Figure 36b-d). As shown in Figure 36b, a significant amount of an insoluble, white zinc-based corrosion product developed on the Ripley-stripped sample during testing. Although the differences from the bare conductor are more subtle, the manual stripping method also showed evidence of zinc corrosion (Figure 36c). The most severe corrosion was observed at the midspan damage site (Figure 36d). Localized areas of rust (steel

corrosion product) were occasionally observed, as shown in the inset to Figure 36d; these areas suggest potential penetration of the zinc layer.

In general, it was observed that the extent of corrosion appeared to be more severe for 17-kV ACSR CCs relative to the bare 17-kV ACSR conductors. This may be the result of longer duration of water entrapment underneath the polymer sheath in the CCs as opposed to bare conductors from which water may be able to drip off. Water may also be able to pool and concentrate in areas between the conductor strands and polymer sheath. Furthermore, when the exteriors of the samples were rinsed with deionized water post-testing, it is possible that only some of the liquid would have been removed from underneath the covered sections. If this were the case, the portions of the conductors underneath the polymer sheath would continue to undergo corrosion until the samples were fully disassembled and recleaned. This suggests that water entrapment and the concentration of corrosive species underneath the polymer sheath may present a potential issue in the field.

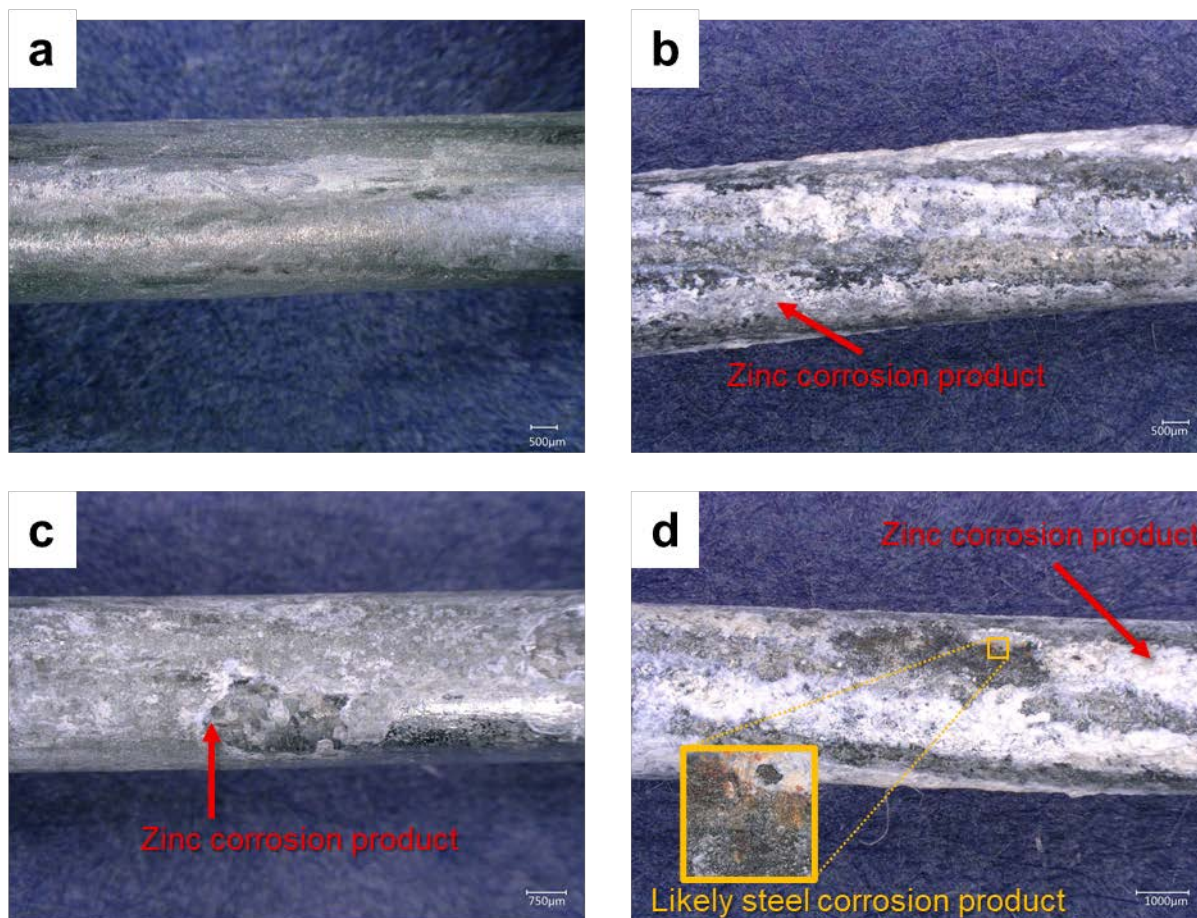

Figure 36. Representative optical microscopy images of galvanized steel conductor strands from (a) a bare 17-kV ACSR conductor and (b-d) covered regions of 17-kV ACSR CCs after salt spray testing. The polymer sheath was stripped from CCs samples prior to testing (b) using a Ripley tool or (c) manually; in addition to being stripped at one end, (d) was damaged along a midspan section.

15-kV ACSR Conductors with IPCs—Aluminum Strands

Bare and covered 15-kV ACSR conductors were analyzed after salt spray testing, as well as 15-kV ACSR CCs that had IPC hardware installed prior to salt spray testing. Figure 37 shows representative optical microscopy images from exterior aluminum strands of salt-spray-tested 15-kV ACSR conductors. The exterior strand from the bare 15-kV ACSR conductors (Figure 37a) showed some evidence of both uniform corrosion and pitting, as well as some general damage that was present prior to salt spray testing. No corrosion was observed on the exterior aluminum strands from the 15-kV ACSR CC with IPC hardware (Figure 37b). Some mechanical damage was observed where the IPC connector contacted the outer aluminum strands, which was a result of normal installation and was unrelated to the salt spray testing. Evidence of shallow localized corrosion was observed on aluminum strands of 15-kV ACSR CCs that had midspan damage, i.e., away from the IPC location (Figure 37c). This corrosion

occurred on regions under the polymer sheath during salt spray testing and appeared qualitatively similar to that observed on the bare conductor.

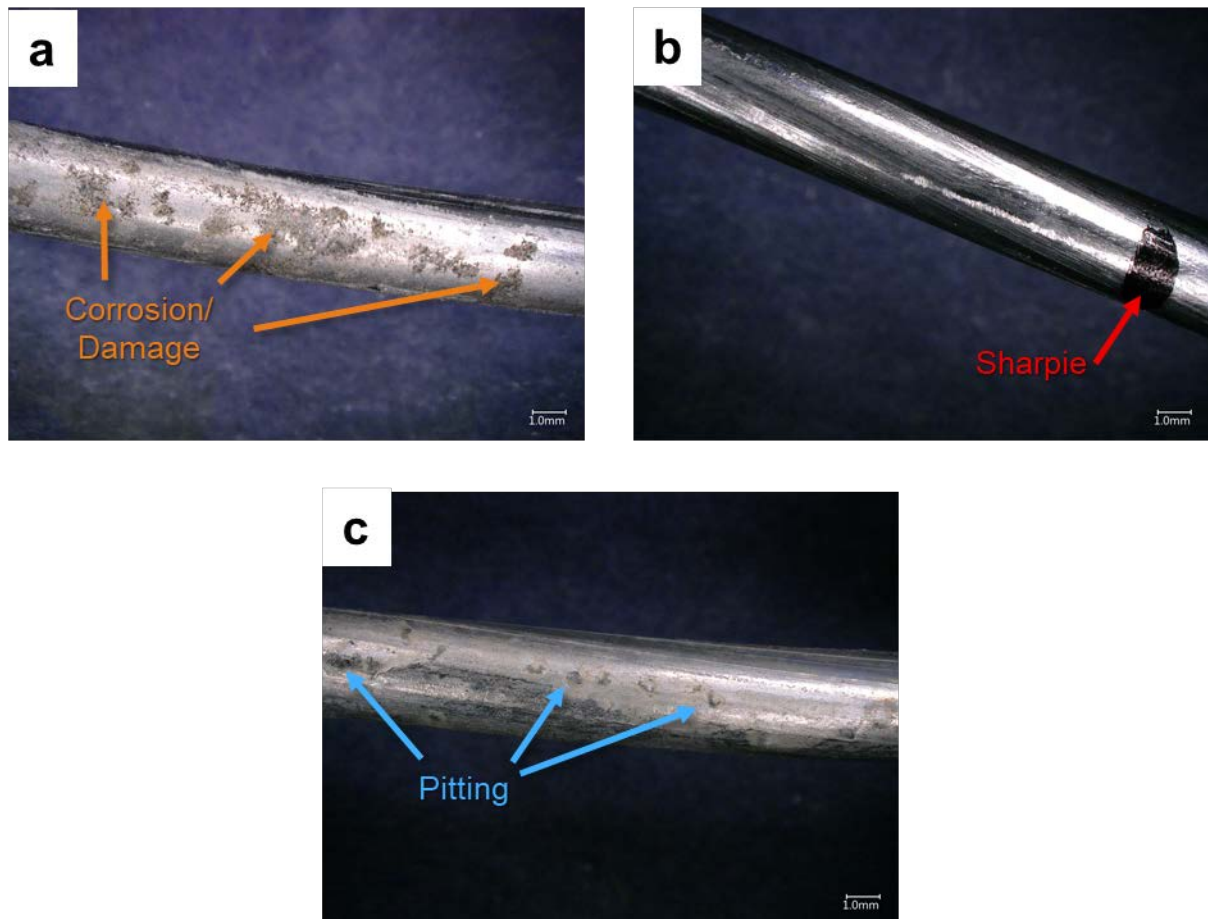

Figure 37. Representative optical microscopy images of aluminum conductor strands from a salt-spray-tested (a) bare 15-kV ACSR conductor, (b) 15-kV ACSR CC with IPC hardware, and (c) 15-kV ACSR CC with midspan damage. The areas in (b) and (c) were underneath the polymer sheath during salt spray testing.

15-kV ACSR Conductors with IPCs—Steel Core

The steel core strands from bare, covered, and IPC-covered 15-kV ACSR conductors were also inspected after salt spray testing. Figure 38 presents representative optical microscopy images from interior steel strands of salt-spray-tested 15-kV ACSR conductors. The core steel strands from the bare 15-kV ACSR conductors (Figure 38a) showed some evidence of minor corrosion and/or damage. No corrosion was observed on the core steel strands of the 15-kV ACSR CCs with IPC hardware (Figure 38b). Evidence of corrosion, including the presence of insoluble, white, zinc-based corrosion product, was observed on the core steel strands from the 15-kV ACSR CCs that had midspan damage (Figure 38c).

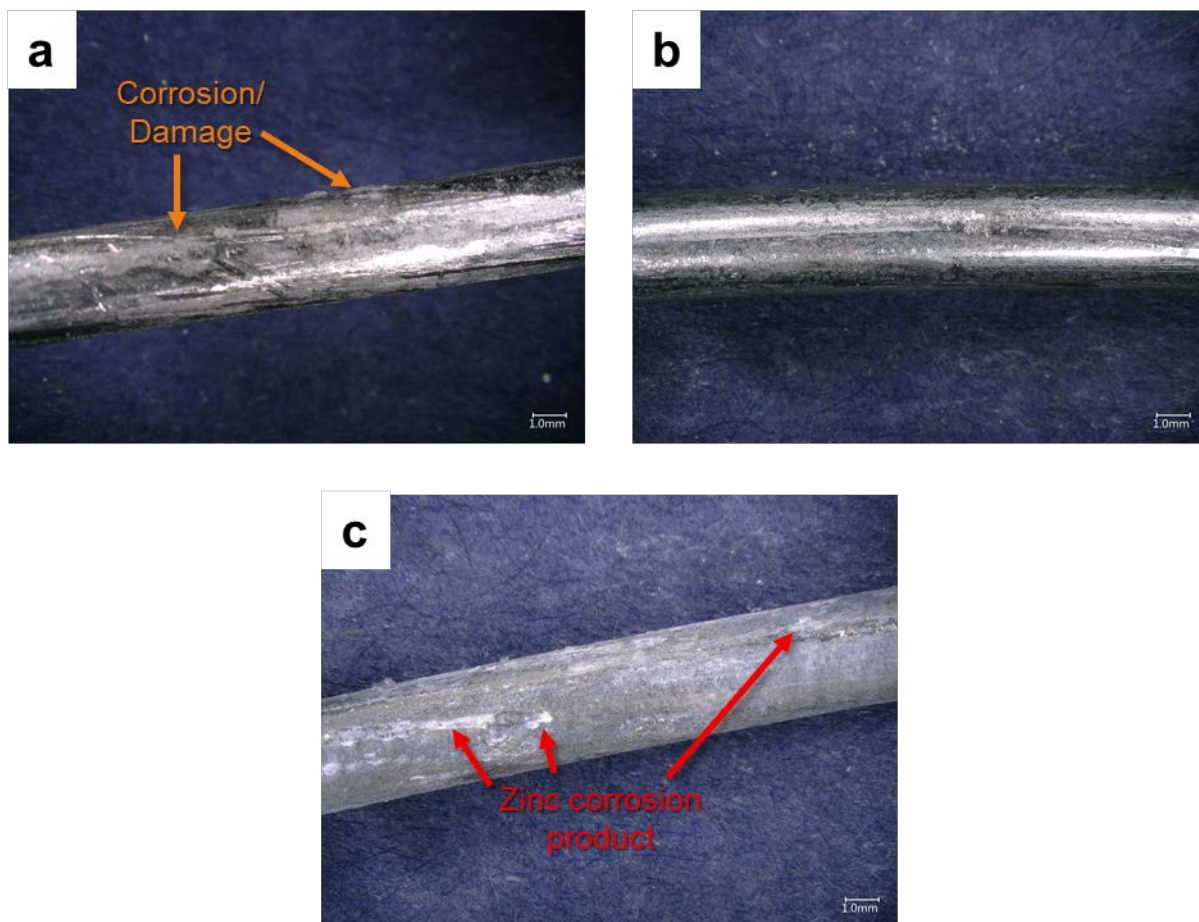

Figure 38. Representative optical microscopy images of steel conductor strands from a salt-spray-tested (a) bare 15-kV ACSR conductor, (b) 15-kV ACSR CC with IPC hardware, and (c) 15-kV ACSR CC with midspan damage. The areas in (b) and (c) were underneath the polymer sheath during salt spray testing.

17-kV Copper Conductors—Outer Strands

Individual strands from the 17-kV copper conductors, both bare and covered, were separated for targeted analysis. Figure 39 presents representative optical microscopy images from exterior strands of salt-spray-tested 17-kV copper conductors. The exterior strand from the bare copper conductor (Figure 39a) showed some evidence of both uniform corrosion and pitting. The corrosion observed on the exposed regions of CCs (Figure 39b-c) appeared similar to the corrosion observed on the bare conductor (Figure 39a). Note that the black spots observed in Figure 39b-d are marks added by Exponent to track the edge of the covered area. Additionally, it was observed that, in some cases, the black layer from the polymer sheath could not be cleanly removed from the copper conductors. This phenomenon was observed on as-received copper CCs and thus is likely not due to salt spray testing itself. Evidence of more severe corrosion and accumulation of corrosion product was observed on the sample with midspan damage (Figure 39d). However, because this likely occurs less frequently in the field than the others (i.e., accidental damage is likely less frequent than intentional sheath removal), this result should be considered an extreme case.

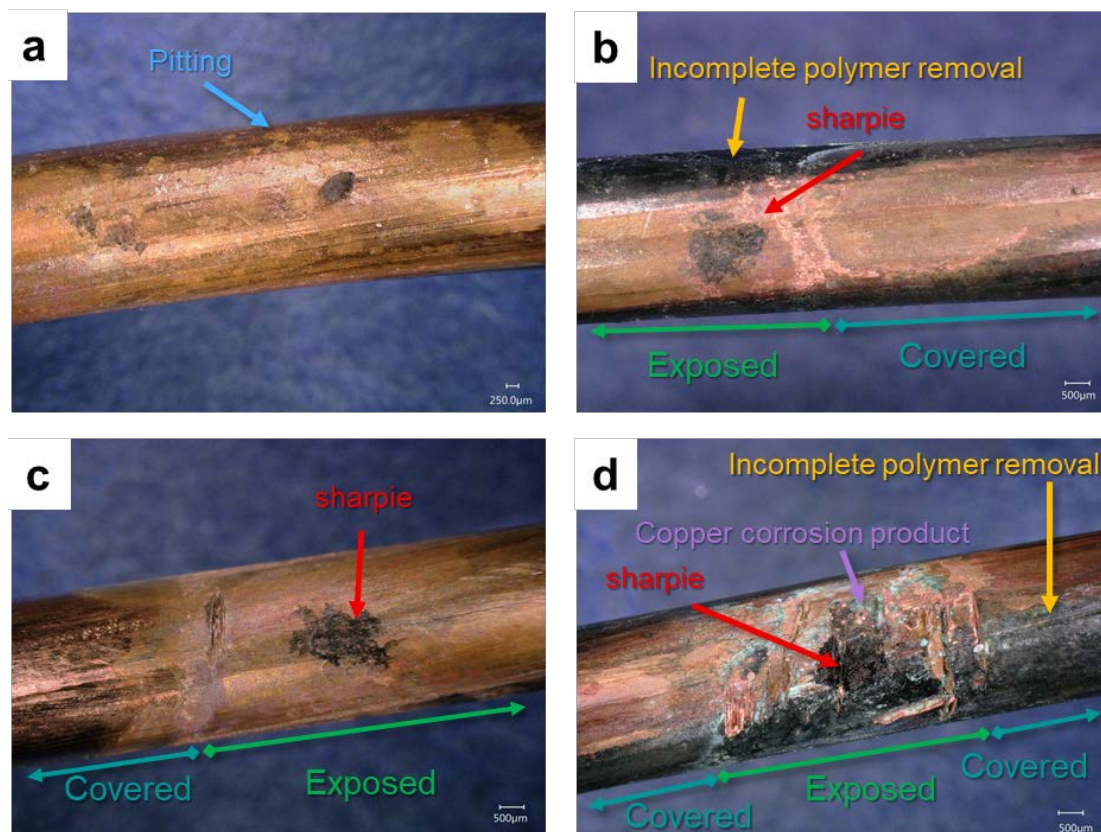

Figure 39. Representative optical microscopy images of exterior strands from a salt-spray-tested (a) bare 17-kV copper conductor, (b) Ripley-stripped 17-kV copper CC, (c) manually stripped 17-kV copper CC, and (d) 17-kV copper CC with midspan damage. The areas in (b-d) show the interfacial area between covered regions and exposed regions as indicated. The CCs showed evidence of corrosion underneath the polymer sheath (b-c) for both Ripley-stripped CC (b) and manually stripped CC (c). The midspan damage region appeared to have the most extensive corrosion of the four sample types (d).

17-kV Copper Conductors—Core Strands

The extent of corrosion on the core strands was also evaluated for salt-spray-tested 17-kV copper conductors, as shown in Figure 40. The core strand from the bare 17-kV copper conductor (Figure 40a) showed some evidence of both uniform corrosion and pitting. The localized corrosion observed on core strands from covered regions of 17-kV copper CCs appeared more severe than that observed on core strands from the bare conductor (Figure 40b-c). Additionally, evidence of localized corrosion was identified at the midpoint of the covered regions of these samples, at least 10–15 cm from the nearest exposed metal (either the stripped end or the cut end). Thus, these experiments indicate that corrosion can occur at least 10–15 cm from a stripped end, although additional studies with longer covered sample lengths would be needed to determine the maximal longitudinal distance beneath the polymer sheath that corrosion may occur away from exposed metal.

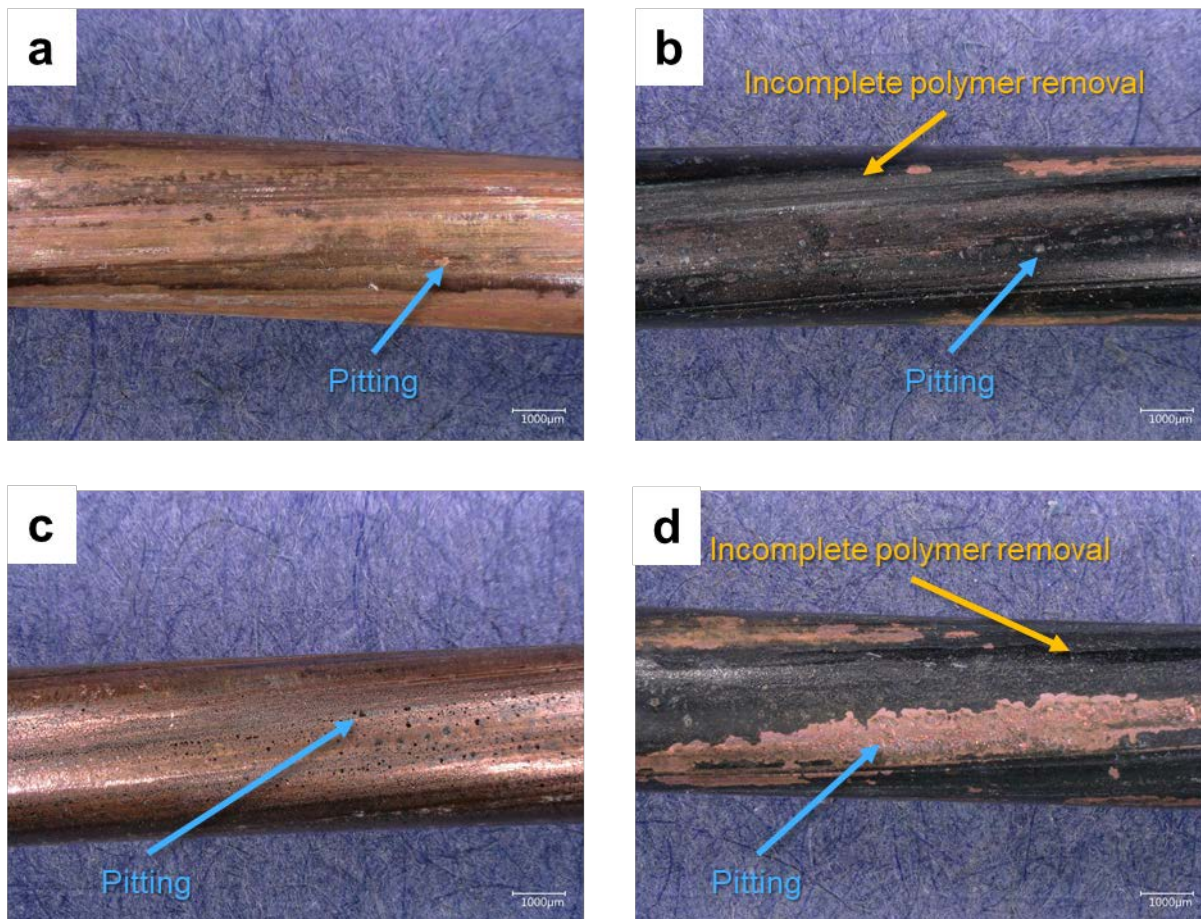

Figure 40. Representative optical microscopy images of core strands from a salt-spray-tested (a) bare 17-kV copper conductor, (b) Ripley-stripped 17-kV copper CC, (c) manually stripped 17-kV copper CC, and (d) 17-kV copper CC with midspan damage. The areas in (b-d) were underneath the polymer sheath during salt spray testing.

22-kV AAC Conductors

Bare and covered 22-kV AAC conductors were analyzed after salt spray testing. Figure 41 presents representative optical microscopy images of salt-spray-tested 22-kV AAC conductors. The images shown are taken prior to disassembly and show the outer strands of the conductor bundles; no corrosion was observed on the interior conductor strands following disassembly. The exterior strands from the bare AAC conductors (Figure 41a) showed minimal evidence of corrosion. Evidence of shallow localized corrosion (pitting) was observed on 22-kV AAC CCs (Figure 41b,c). This corrosion occurred on regions that were underneath the polymer sheath during salt spray testing and appeared qualitatively more severe than that observed on the bare conductor. There did not appear to be a significant difference in the severity of corrosion observed on CCs that had the ends of the polymer sheath removed versus those that had midspan damage. Evidence of corrosion was observed at the midpoint between the stripped end and the cut end, at least 1.5 feet from the nearest exposed metal.

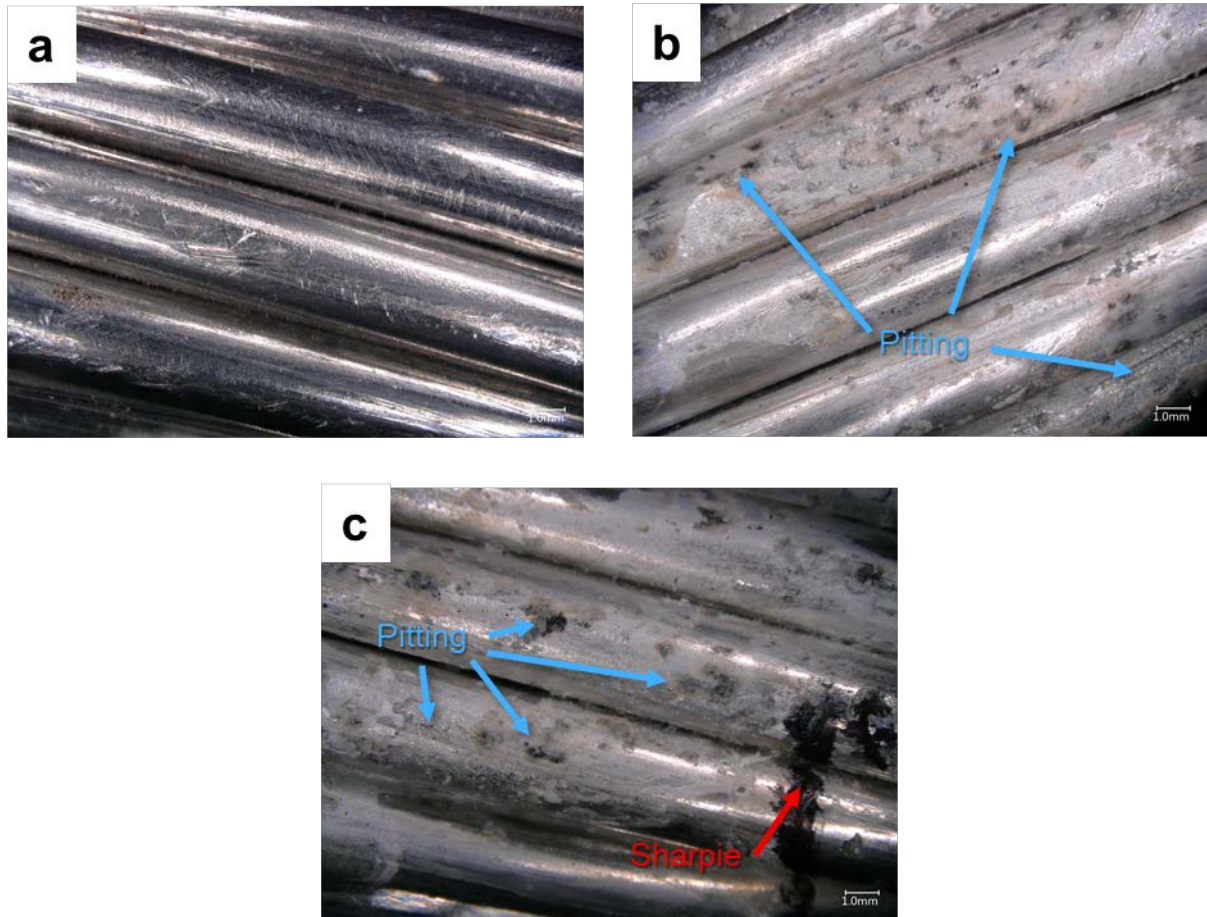

Figure 41. Representative optical microscopy images from a salt-spray-tested (a) bare 22-kV AAC conductor, (b) Ripley-stripped 22-kV AAC CC, and (c) 22-kV AAC CC with midspan damage. The areas in (b) and (c) were underneath the polymer sheath during salt spray testing. The optical microscopy images shown were taken of the entire conductor cable prior to disassembly and show multiple outer strands. No corrosion was observed on the inner strands.

Remaining Strength

Following salt spray exposure, Exponent performed tensile testing on a subset of samples to identify any changes in mechanical strength of the conductors using a 5982 Instron universal testing machine (UTM) equipped with a 100-kN load cell and an Instron AVE 2 non-contact video extensometer. To be consistent with prior conductor testing methodologies,^{23,24} individual conductor strands were tested rather than the full conductors. The conductor strands were pulled with a displacement rate of 5 mm/min. Tensile specimens generally have reduced cross-sectional areas to induce failure in between the grips (in the gauge section). However, as the

²³ Lequien, F., et al. "Characterization of an aluminum conductor steel reinforced (ACSR) after 60 years of operation." *Engineering Failure Analysis* 120 (2021): 105039.

²⁴ Refsnæs, S., Magnusson N., Ulleberg T. "Laboratory corrosion tests on overhead line conductors with bird protection systems." *Int. Trans. Electr. Energ. Syst.* 24(2014): 1185.

goal of this work was to assess differences in individual conductor strands arising from salt spray testing, machining the samples was not possible. Thus, the ends of the conductor strand were wrapped with aluminum foil to reduce the likelihood of failure at the grips. Figure 42 presents a representative sample with aluminum foil wrapped ends. Note that the aluminum foil wrapping was found to be less effective for copper samples.

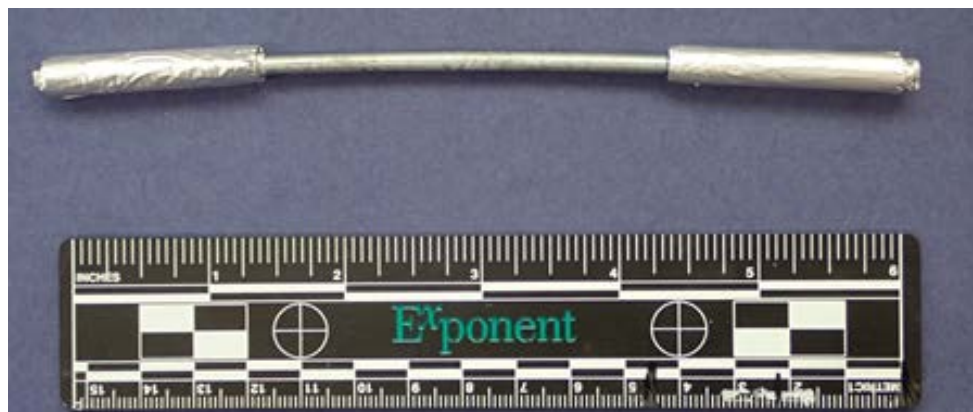

Figure 42. Representative photograph of a tensile specimen with aluminum foil wrapped ends. The aluminum foil reduces the likelihood of failure outside the gauge length.

17-kV ACSR Conductors (Stripped)

Figure 43 presents engineering stress-strain curves for aluminum strands (Figure 43a) and steel strands (Figure 43b) from 17-kV ACSR conductors. In these plots, sample IDs 316133, 316134, and 316139 are from salt-spray-tested CCs, and sample ID 316175 is a salt-spray-tested bare conductor. The as-received sample was a bare conductor that was not subjected to salt spray testing. The salt-spray-tested aluminum strands from CCs had lower tensile strengths than both the salt-spray-tested and as-received bare aluminum conductor strands by approximately 16–19%. However, the high-temperature processing of the polymer sheath likely leads to some annealing (and thus strength loss) of the aluminum conductor strands in CCs. Thus, understanding the degree of strength loss (if any) attributable to corrosion of these strands would require additional testing on aluminum strands from as-received 17-kV ACSR CCs. Both bare and covered salt-spray-tested steel strands showed higher ultimate tensile strengths than the as-received bare conductor. Thus, based on the limited tests conducted, changes to the steel strand were considered insignificant. It should be noted that a limited number of tests were performed to characterize strength loss after exposure to a corrosive environment. Should a greater level of statistical confidence be desired, more tests would be recommended.

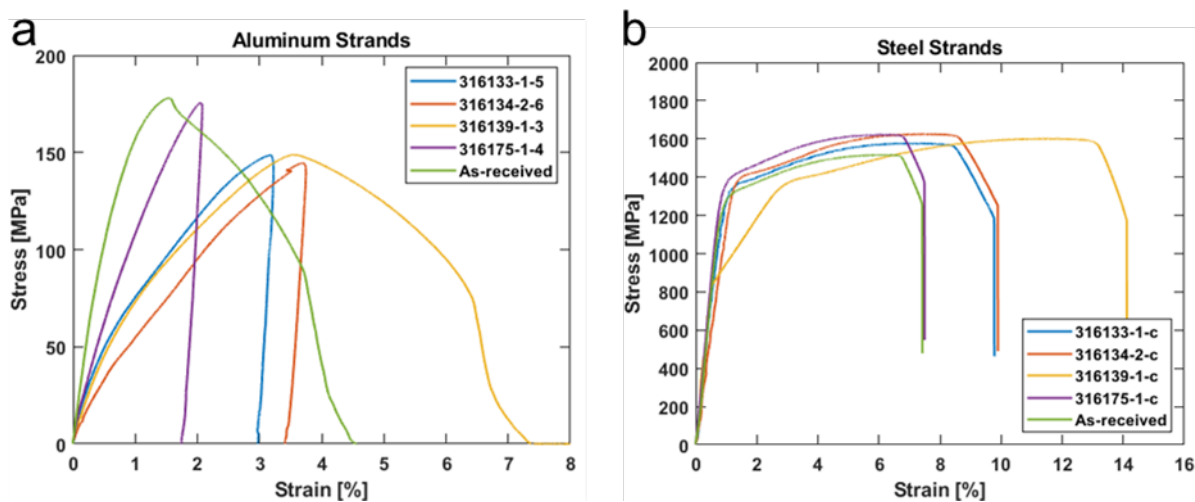

Figure 43. Engineering stress-strain curves for salt-spray-tested (a) aluminum and (b) steel strands from covered and bare 17-kV ACSR conductors. Sample IDs starting with 316133, 316134, and 316139 are from salt-spray-tested CCs. Sample IDs starting with 316175 are from a salt-spray-tested bare conductor. The as-received sample is also a bare conductor.

Table 14 summarizes the tensile strength results for salt-spray-tested and as-received 17-kV ACSR conductors. All samples with a sample ID number underwent salt spray testing. Three out of the four salt-spray-tested aluminum strands fractured outside the gauge length. This effect, coupled with the unquantified impacts of annealing expected during CC manufacturing, prevents firm conclusions from being drawn regarding the strength loss due to corrosion. Although grip failure in selected samples may hinder the ability to understand the maximum strength, the tested strands must be at least as strong as the load at grip failure. The salt spray testing does not appear to have had a significant impact on the steel strand strength. These results are consistent with the optical microscopy results that suggest widespread attack of the zinc galvanizing layer but very little attack of the underlying steel.

Table 14. Tensile strengths for single strands of 17-kV ACSR conductors. Samples listed with a sample ID had undergone salt spray testing prior to tensile testing. Samples denoted with * fractured outside the gauge length.

Sample ID	Strand Material	Sample Type	Tensile Strength [MPa]
316133-1-5	Aluminum	CC Ripley	148.62*
316134-2-6	Aluminum	CC Ripley Midspan	144.55*
316139-1-4	Aluminum	CC Manual Creviced	148.84
316175-1-4	Aluminum	Bare	175.61*
As-received	Aluminum	Bare	178.05
316133-1-c	Galvanized Steel	CC Ripley	1576.38
316134-2-c	Galvanized Steel	CC Ripley Midspan	1624.70
316139-1-c	Galvanized Steel	CC Manual Creviced	1600.70
316175-1-c	Galvanized Steel	Bare	1621.01
As-received	Galvanized Steel	Bare	1515.66

Lequien et al. report that the ultimate tensile strength (UTS) for ACSR conductors can be calculated using the following equation:²⁵

$$UTS_{ACSR} = \sum_{Al\ strands} [A_{Al} \times TS_{Al}] + \sum_{Steel\ Strands} [A_{steel} \times \sigma_{steel}(TE_{steel} = TUE_{Al})]$$

where UTS_{ACSR} is the ultimate tensile strength for the ACSR conductor (reported in the literature as a load in kN), A_{Al} and A_{steel} are the nominal cross-sectional areas for the aluminum and steel strands, respectively, and TS_{Al} is the measured tensile strength (in MPa) from Table 14 for the aluminum strands. Because the total elongation of the steel strands was much larger than the total uniform elongation of the aluminum strands (not shown), the aluminum strands should break first; thus, the final term $\sigma_{steel}(TE_{steel} = TUE_{Al})$ describes the steel stress σ_{steel} at the total elongation of the steel (TE_{steel}) corresponding to the total uniform elongation of the aluminum (TUE_{Al}).

Table 15 presents the calculated ultimate tensile strengths (in kN) for 17-kV ACSR conductors. By this method, the calculated ultimate tensile strength losses of salt-spray-tested 17-kV ACSR CCs are 2–7% relative to as-received and salt-spray-tested bare 17-kV ACSR conductors. Nevertheless, as noted previously, some of the calculated strength loss may be attributed to annealing during manufacturing, making it difficult to draw firm conclusions on the strength loss due to corrosion.

²⁵ Lequien, F., et al. "Characterization of an aluminum conductor steel reinforced (ACSR) after 60 years of operation." *Engineering Failure Analysis* 120 (2021): 105039.

Table 15. Calculated ultimate tensile strengths for 17-kV ACSR conductors. Samples listed with a sample ID had undergone salt spray testing prior to tensile testing.

Conductor	Conductor Type	Ultimate Tensile Strength [kN]
316133-1	CC Ripley	21.61
316134-2	CC Ripley Midspan	21.26
316139-1	CC Manual Creviced	20.55
316175-1	Bare	22.21
As-received	Bare	22.10

15-kV ACSR Conductors with IPCs

Tensile testing was performed on salt-spray-tested 15-kV ACSR conductors. Figure 44 presents engineering stress-strain curves for aluminum strands (Figure 44a) and steel strands (Figure 44b) from 15-kV ACSR conductors. Aluminum and steel strands from salt-spray-tested CCs with IPC hardware installed (Sample IDs: 326622 and 332625), CCs with midspan damage (Sample IDs: 332916 and 332917), and bare conductors (Sample IDs: 332932 and 332933) were tensile tested, as well as aluminum and steel strands from an as-received bare conductor that was not subjected to salt spray testing.

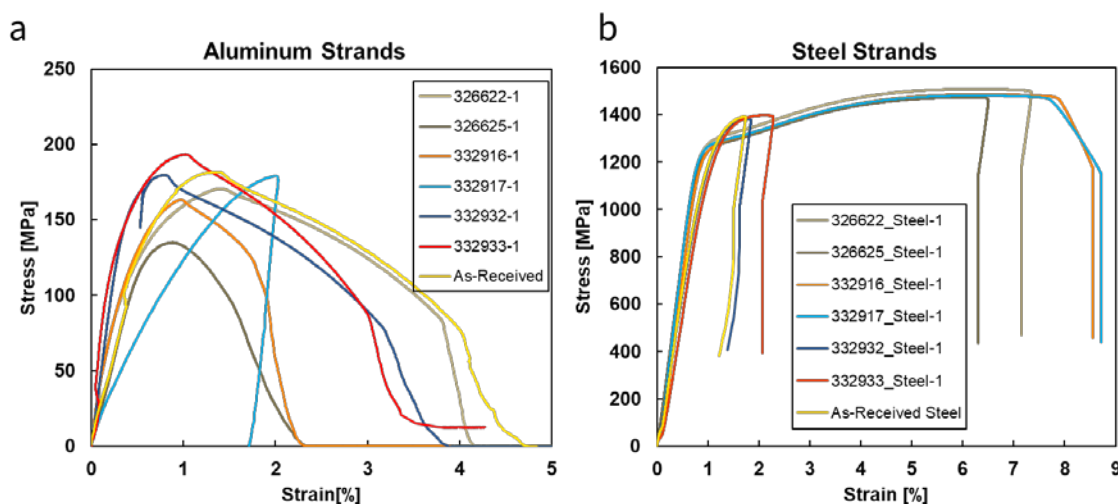

Figure 44. Engineering stress-strain curves for salt-spray-tested (a) aluminum and (b) steel strands from covered and bare 15-kV ACSR conductors. Sample IDs starting with 326622 and 332625 are from salt-spray-tested CCs with IPC hardware. Sample IDs starting with 332916 and 332917 are from salt-spray-tested CCs with midspan damage. Sample IDs starting with 332932 and 332933 are from a salt-spray-tested bare conductor. The as-received sample is also a bare conductor.

Table 16 summarizes the tensile strength results for individual aluminum and steel strands for salt-spray-tested and as-received 15-kV ACSR conductors as well as the calculated ultimate

tensile strengths (in kN) for these conductors. The ultimate tensile strength calculations were similar to those used for the 17-kV ACSR conductors discussed above. The lowest calculated ultimate tensile strength was for a salt-spray-tested ACSR CC with IPC hardware (326625-1), which showed a ~17% decrease in ultimate tensile strength compared to a bare, as-received conductor that did not undergo salt spray testing. The tensile strength of the aluminum strand for this sample was significantly lower than the other aluminum strands tested, likely due to the mechanical damage caused by IPC hardware installation, as shown in Figure 45. The lack of corrosion observed on the IPC hardware samples also supports the notion that the decrease in tensile strength is a result of mechanical damage to the conductor by the IPC installation rather than a result of corrosion of the conductor material. These results suggest that ACSR CCs with IPC hardware may have a measurable decrease in conductor strength relative to bare conductors, likely due to mechanical damage caused by the IPC installation.

Salt-spray-tested 15-kV ACSR CCs with midspan damage had ultimate tensile strength losses of ~1–9% compared to bare, as-received conductors that did not undergo salt spray testing. The ultimate tensile strength losses for salt-spray-tested bare conductors relative to bare, as-received conductors that did not undergo salt spray testing were ~4–14%. These results suggest that there may be some decrease in ultimate tensile strength for 15-kV ACSR CCs after salt spray testing, but the strength loss is not markedly different from bare conductors tested under the same conditions.

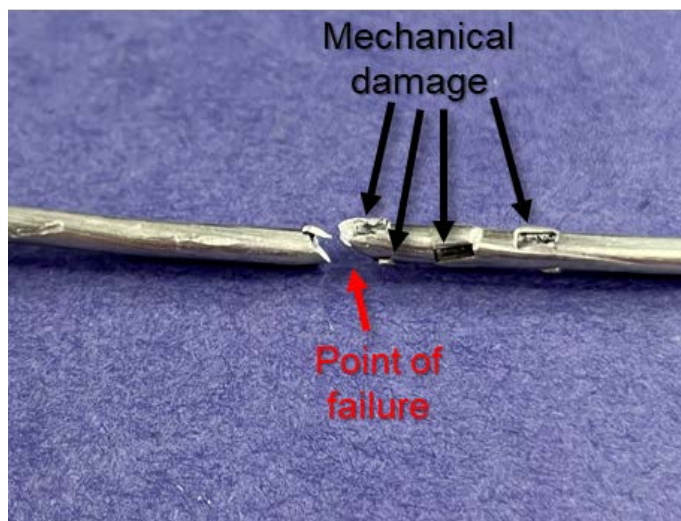

Figure 45. Photograph of a single aluminum strand from a 15-kV ACSR CC with IPC hardware after salt spray exposure and tensile testing. The mechanical damage was caused by the IPC hardware and was unrelated to either the salt spray testing or the tensile testing.

Table 16. Tensile strengths for single strands of 15-kV ACSR conductors and calculated ultimate tensile strengths. Samples listed with a sample ID had undergone salt spray testing prior to tensile testing. Samples denoted with * fractured outside the gauge length.

Sample ID	Sample Type	Aluminum Strand Tensile Strength [MPa]	Steel Strand Tensile Strength [MPa]	Ultimate Tensile Strength [kN]
326622-1	ACSR CC IPC	170.6	1507.9*	20.9
326625-1	ACSR CC IPC	134.9	1473.6*	18.1
332916-1	ACSR CC Midspan	163.3	1485.7	19.8
332917-1	ACSR CC Midspan	179.1*	1481.6	21.7
332932-1	ACSR Bare	179.7	1384.0*	18.7
332933-1	ACSR Bare	193.4	1397.7*	20.4
As-Received	ACSR Bare	181.6	1392.3*	21.9

17-kV Copper Conductors

Exponent also performed tensile testing on the salt-spray-tested 17-kV copper conductors; Exponent understands through discussions with SCE that CC installations in coastal areas will utilize copper conductors. Figure 46 presents the engineering stress-strain curves for salt-spray-tested CCs (Sample IDs 316068-2-5, 316068-1-2, and 316071-1-2) and bare conductors (Sample ID 316081-1-3). The curve for an as-received bare conductor that was not subjected to salt spray testing is also presented.

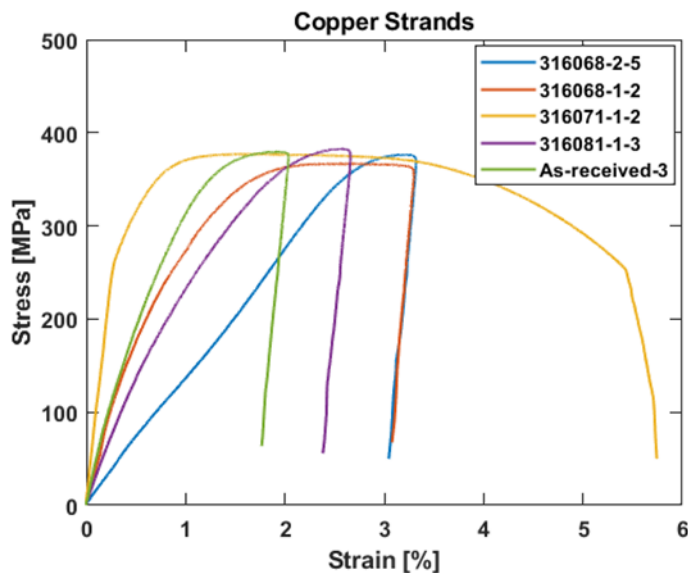

Figure 46. Engineering stress-strain curves for salt-spray-tested 17-kV copper strands from covered and bare conductors. Sample IDs 316068-2-5, 316068-1-2, and 316071-1-2 are from salt-spray-tested CCs. Sample ID 316081-1-3 is a salt-spray-tested bare conductor. The as-received sample is a bare conductor that did not undergo salt spray testing.

Table 17 summarizes the tensile strengths measured for the 17-kV copper conductors. Of the five samples tested, four fractured outside the gauge length. Although grip failure in selected samples may hinder the ability to understand the maximum strength, the tested strands must be at least as strong as the load at grip failure. Sample 316068-1-2 showed an approximately 3% decrease in tensile strength as compared to the bare as-received sample. However, as is the case with the 17-kV ACSR CCs, application of the polymer sheath may lead to some strength loss, making it difficult to attribute this decrease solely to corrosion. Furthermore, as this represents a relatively small change, additional studies on variations in tensile strength for individual copper conductor strength would be needed to rule out sample variation as an explanation for this difference.

Table 17. Tensile strength for single strands of 17-kV copper conductors. Samples listed with a sample ID had undergone salt spray testing prior to tensile testing. Samples denoted with * fractured outside the gauge length.

Sample ID	Sample Type	Tensile Strength [MPa]
316068-2-5	CC Ripley Midspan	376.52*
316068-1-2	CC Ripley	366.63*
316071-1-2	CC Manual	377.04
316081-1-3	Bare	382.54*
As-received-3	Bare	379.50*

22-kV AAC Conductors

Tensile testing was performed on salt-spray-tested 22-kV AAC conductors. Figure 47 presents engineering stress-strain curves for individual outer aluminum strands from salt-spray-tested CCs (Sample IDs 332921, 332923, and 332927) and bare conductors (Sample IDs 326619 and 326621), as well as for an individual aluminum strand from a bare, as-received conductor that did not undergo salt spray testing.

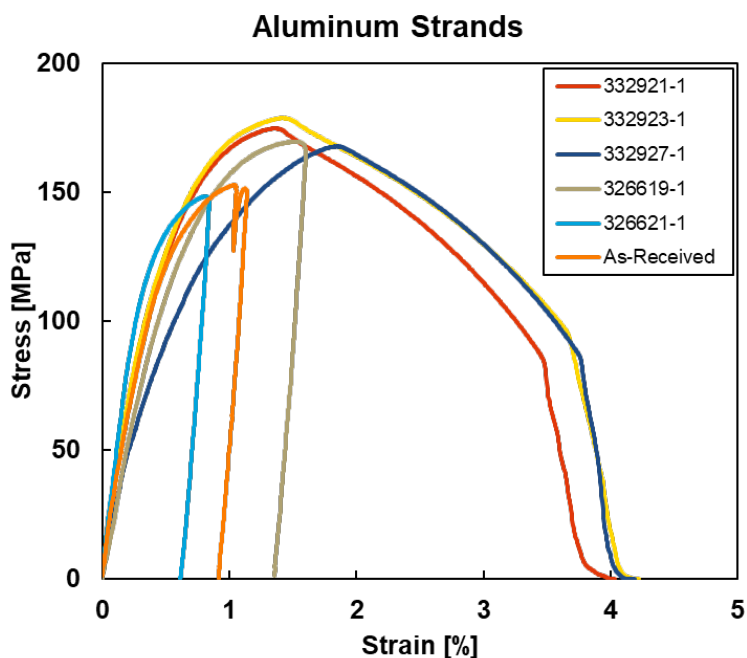

Figure 47. Engineering stress-strain curves for salt-spray-tested 22-kV AAC strands from covered and bare conductors. Sample IDs 332921, 332923, and 332927 are from salt-spray-tested CCs. Sample IDs 326619 and 326621 are from salt-spray-tested bare conductors. The as-received sample is a bare conductor that did not undergo salt spray testing.

Table 18 summarizes the tensile strengths measured for the 22-kV AAC conductors. The tensile strengths of all aluminum strands from CCs exposed to salt spray testing were larger than the average tensile strength for aluminum strands from bare conductors exposed to salt spray testing, as well as the tensile strength for a bare, as-received conductor. All aluminum strands from bare conductors fractured outside the gauge length. Although grip failure in these samples may hinder the ability to understand the maximum strength, the tested strands must be at least as strong as the load at grip failure. Further studies with larger sample sizes would be needed to draw firm conclusions about the mechanical properties of bare and covered conductors, but these results suggest that corrosion caused by salt spray testing does not lead to a significant decrease in tensile strength for AAC CCs relative to bare conductors.

Table 18. Tensile strength for single strands of 22-kV AAC conductors. Samples listed with a sample ID had undergone salt spray testing prior to tensile testing. Samples denoted with * fractured outside the gauge length.

Sample ID	Sample Type	Tensile Strength [MPa]
332921-1	AAC CC End Strip	174.6
332923-1	AAC CC Creviced End	178.6
332927-1	AAC CC Midspan	167.7
326619-1	AAC Bare	169.5*
326621-1	AAC Bare	148.4*
As-Received	AAC Bare	152.8*

Cyclic Polarization Testing

As mentioned previously, Phase 1 studies identified accelerated localized corrosion as a potential threat to CC systems. As the water ingress and salt spray testing demonstrated, stripping of the polymer sheath may facilitate liquid ingress and corrosion beneath the polymer sheath. Thus, to better understand this phenomenon, cyclic polarization testing was performed to electrochemically characterize the localized corrosion susceptibility of CCs with stripped ends in an aqueous environment. Specifically, the effects of material type, sheath removal method, presence of artificially induced crevices, and the age of the samples were investigated. Note that as pre-aged samples were not provided, some samples were put through an accelerated aging process to simulate extended use.

Experimental Setup

A detailed description of the conductor sample preparation and cyclic polarization testing is provided in Appendix A. Briefly, electrical connection was made to a small section of conductor and then the connection and each end of the conductor were sealed with silicone sealant. Testing was performed in 3.5% NaCl at 35 ° C. All electrochemical testing was conducted using Gamry potentiostats. All potentiostats used for testing successfully passed the criteria outlined in ASTM G5-14.²⁶ The sample was polarized from the rest potential (E_r), the potential measured when no net current is flowing through the system, to a vertex potential of 1.1 V versus a standard calomel reference electrode (or to a maximum vertex current of either 300 mA or 600 mA, depending on the potentiostat capabilities) and then the scan was reversed and scanned back to E_r . A schematic of the electrochemical test setup is provided in Figure 48.

Cyclic polarization testing was limited to only the 17-kV ACSR and 17-kV copper conductors. In addition to testing as-received ACSR and copper conductors, cyclic polarization was also performed on a set of samples that were subjected to cyclic immersion aging prior to testing. These samples were immersed in a 3.5% NaCl solution at 35° C for 16 hours and then taken out and allowed to dry at room temperature for 8 hours; the wet/dry cycling was repeated for a total

²⁶ ASTM G5-14 “Standard Reference Test Method for Making Potentiodynamic Anodic Polarization Measurements,” American Society for Testing and Materials, 2014.

of seven days. This immersion aging was intended to mimic exposure to harsh environmental conditions (i.e., near the ocean) and to evaluate the effect of such exposure on the corrosion resistance of the CCs and bare conductors. Figure 49 presents representative images of immersion-aged 17-kV ACSR and 17-kV copper CCs prior to cyclic polarization testing.

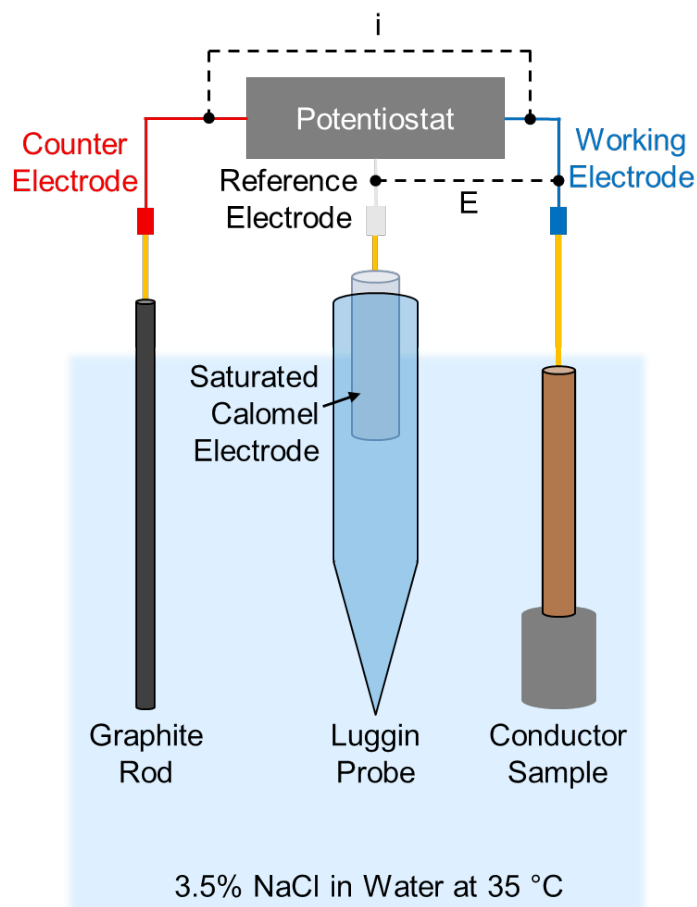

Figure 48. Schematic showing a typical setup for cyclic polarization testing. The potential of the sample was measured relative to a saturated calomel electrode. Graphite was used as the counter electrode. A 3.5% NaCl solution was used for the electrolyte and was held at 35° C.

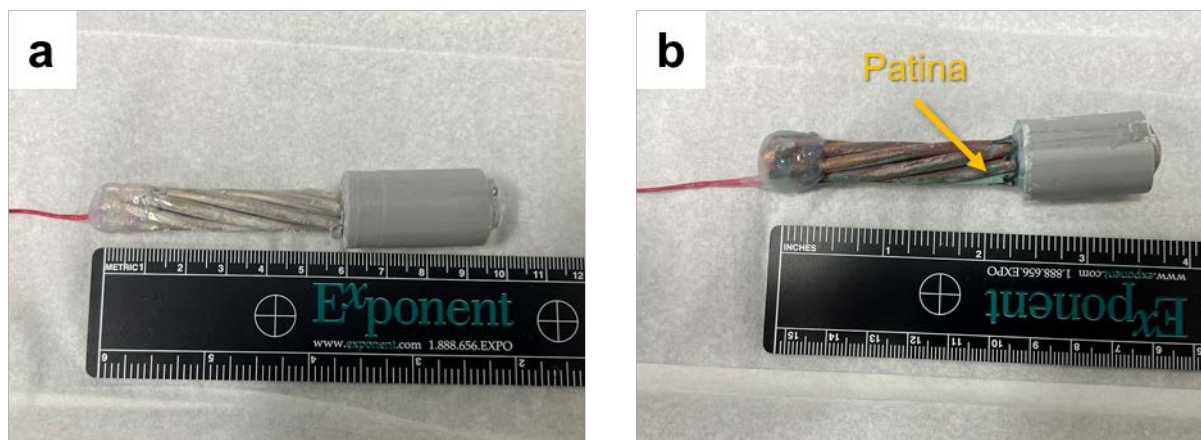

Figure 49. Representative pre-test photographs of aged (a) 17-kV ACSR and (b) 17-kV copper CCs. The immersion aging resulted in patina formation on copper conductors.

Following testing, the samples were visually inspected, and the cyclic polarization scans were evaluated for evidence of corrosion. Typically, large, sudden increases in current during the forward scan indicate localized corrosion and are referred to as breakdown. The potential at which breakdown occurs (E_b) and the relationship of E_b to E_r provide a metric for evaluating corrosion susceptibility, i.e., higher $E_b - E_r$ values indicate better corrosion resistance. In addition, the current density at E_r (j_{E_r}) was calculated by fitting the linear region of the current versus potential traces within the first few hundred millivolts of the forward scan and extrapolating back to E_r . Comparison of the current densities at E_r provides an analysis of the corrosion activity at the rest potential, wherein lower current densities indicate less corrosion.

Results

- No significant adverse effect in localized corrosion susceptibility for CCs compared to bare conductors was observed.
- The 17-kV ACSR conductors exhibited a mix of active and passive behavior, indicating that the breakdown potential in this test environment (3.5% NaCl) is close to the rest potential.
- All 17-kV copper conductors (bare and covered) exhibited active corrosion in this test environment and could not be differentiated.
- Both 17-kV copper and 17-kV ACSR conductors (bare and covered) are susceptible to localized corrosion if an aggressive environment is present. Care should be taken to prevent water ingress and the concentration of contaminants underneath the polymer sheath that can result in the formation of an aggressive environment.
- Neither the sheath removal method nor the presence of artificially created crevices had a significant effect on the corrosion resistance of the 17-kV copper and 17-kV ACSR conductors tested.

17-kV ACSR Conductors

Figure 50 presents representative plots of current density versus potential for 17-kV ACSR conductors and for individual, polished aluminum strands. An increase in current density is generally observed as the sample is polarized in the anodic direction. If a passive film forms, one would expect the current density to remain relatively constant until a breakdown potential is reached. At the breakdown potential, a rapid increase in current density is observed. The 17-kV ACSR conductors had a mix of active and passive behavior.

Table 19 presents average current density at the E_r (j_{Er}) measurements for 17-kV ACSR conductors and for individual, polished aluminum strands. The j_{Er} is a representation of the corrosion rate of the sample in a particular environment when no external bias is applied. It is of note that the average j_{Er} values measured for single, polished aluminum strands was much lower than the average j_{Er} values measured for either 17-kV ACSR bare conductors or CCs. This suggests that j_{Er} measurements on both bare conductors and CCs is driven primarily by creviced geometries resulting from the stranded nature of the conductor bundle rather than any potential crevices at the conductor/sheath interface (in the case of CCs). Note also that, in these results, the stripping method and presence of artificial end crevices did not appear to significantly affect the corrosion susceptibility, although variability in the data make it difficult to determine conclusively.

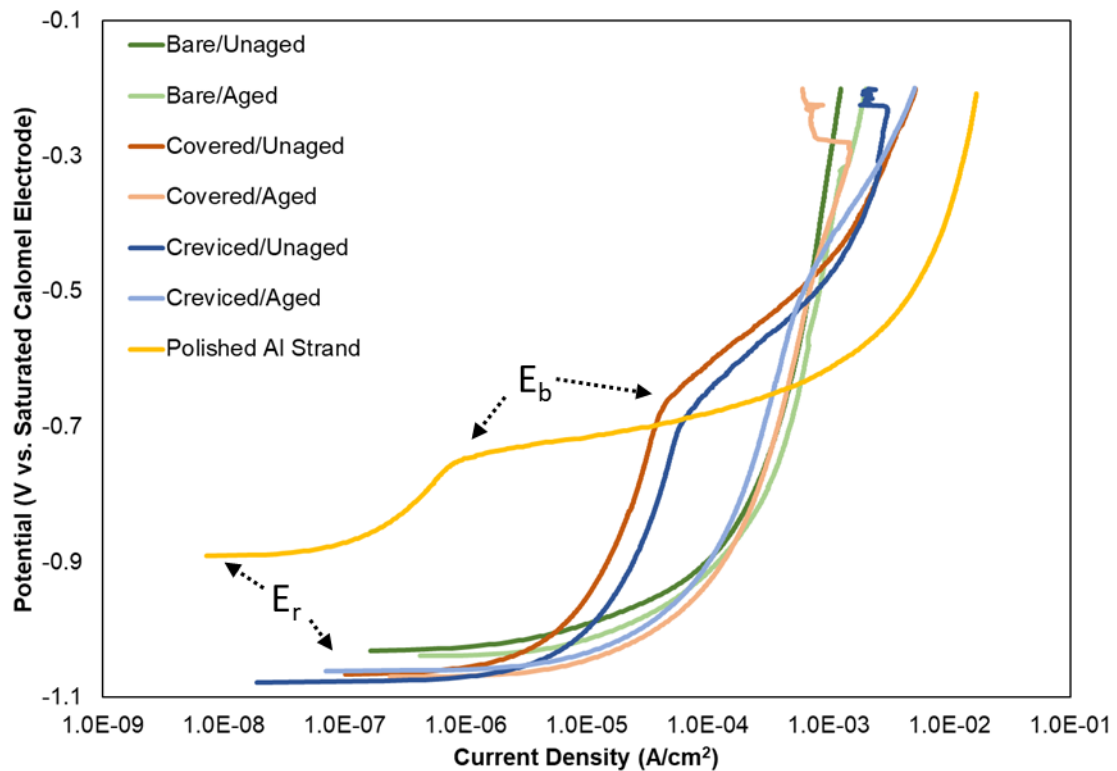

Figure 50. Representative plots of current density vs. potential for 17-kV ACSR conductor samples and for an individual polished aluminum strand. The plots shown here only present data from the forward scan up to -0.20 V vs. saturated calomel electrode for clarity and to highlight the particular regions of interest in evaluating the corrosion susceptibility. E_b and E_r denote the breakdown potential and the rest potential, respectively.

Table 19. Measured current densities at the rest potential (j_{Er}) for cyclic-polarization-tested 17-kV ACSR conductors and individual polished aluminum strands. Averaged values are reported with the standard deviation; some test conditions resulted in anomalies, and only a single test was considered reliable.

Conductor Type/Condition	j_{Er} ($\mu\text{A}/\text{cm}^2$)
Bare, Unaged	2.84 ± 0.47
Covered, Unaged	2.66 ± 1.44
Crevice End, Unaged	2.44
Bare, Aged	4.88
Covered, Aged	3.67 ± 1.81
Crevice End, Aged	3.49 ± 0.49
Individual Polished Al Strand	0.11 ± 0.00

Figure 51 presents representative optical microscopy images of exposed (Figure 51a) and covered (Figure 51b) regions of an unaged 17-kV ACSR CC after cyclic polarization testing. Extensive pitting was observed on exposed regions, consistent with the electrochemical data. In addition, pitting was observed on areas that were covered during testing; it is noted that these surfaces appeared similar to the surfaces that were covered during salt spray testing (Figure 35). These data indicate that water may ingress beneath the polymer sheath and cause corrosion of the underlying conductor in regions that are not directly exposed to the surrounding environment.

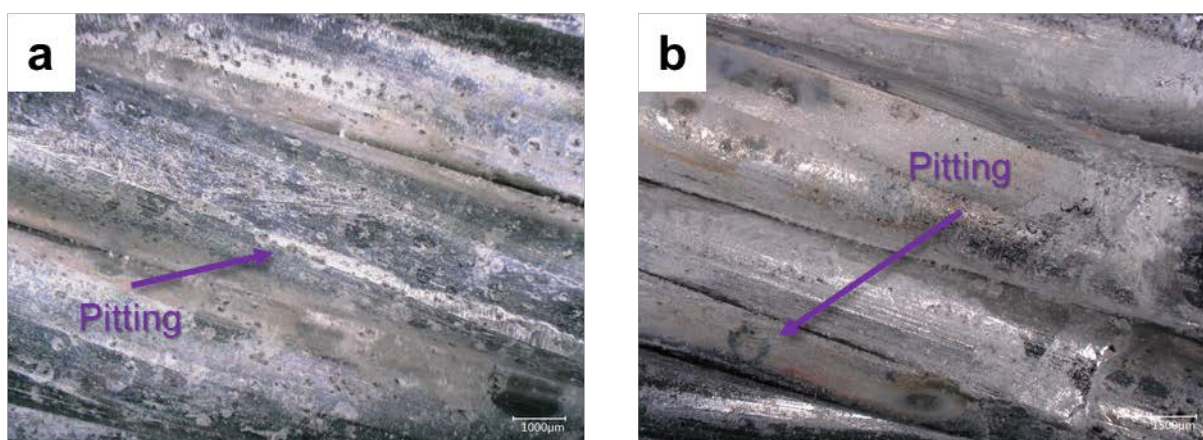

Figure 51. Representative optical microscopy images of (a) stripped and (b) covered portions of an unaged cyclic-polarization-tested 17-kV ACSR CC.

17-kV Copper Conductors

Figure 52 presents representative plots of current density versus potential for 17-kV copper conductors and for individual, polished copper strands. A breakdown potential was not observed in the electrochemical data for cyclic polarization of copper conductors. However, the rapid increase in current density to a very high value at the beginning of the polarization indicates that the samples do not exhibit passive behavior and undergo active corrosion at potentials very near E_r . Similar results were observed for single, polished copper strands.

Table 20 presents average j_{E_r} measurements for 17-kV copper conductors and for individual, polished copper strands. The average j_{E_r} values were similar for 17-kV copper bare conductors, CCs, and single, polished strands. This indicates that j_{E_r} is primarily a function of the active corrosion rate of copper and is not critically dependent on the sample geometry in this test environment investigated. No significant differences in behavior were observed between the stripping methods (not shown).

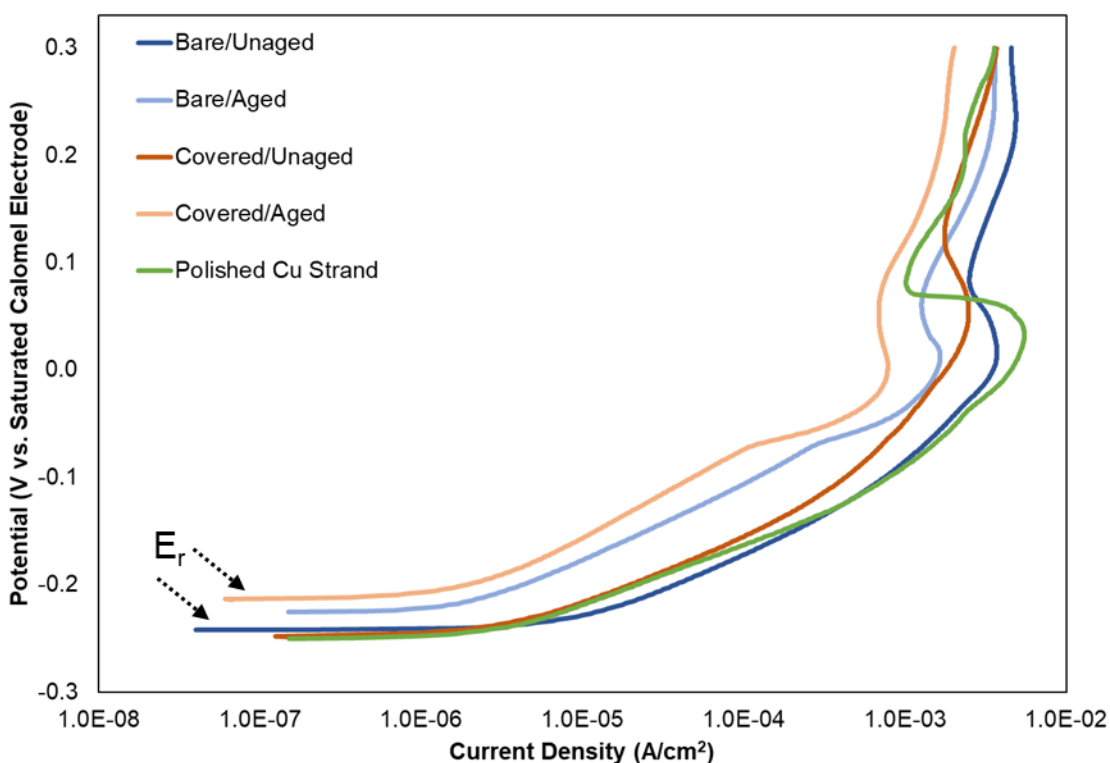

Figure 52. Representative plots of current density vs. potential for 17-kV copper conductor samples. The plots shown here only present data from the forward scan up to 0.30 V vs. saturated calomel electrode for clarity and to highlight regions of interest in evaluating the corrosion susceptibility. E_r denotes the rest potential.

Table 20. Measured current densities at the rest potential (j_{Er}) for cyclic-polarization-tested 17-kV copper conductors. Averaged values are reported with the standard deviation.

Conductor Type/Condition	j_{Er} ($\mu\text{A}/\text{cm}^2$)
Bare, Unaged	8.70 ± 0.92
Covered, Unaged	2.99 ± 0.62
Bare, Aged	1.81 ± 0.13
Covered, Aged	2.04 ± 0.37
Individual Polished Cu Strand	2.61 ± 0.47

Figure 53 presents representative optical microscopy images of exposed (Figure 53a) and covered (Figure 53b) regions of an unaged 17-kV copper CC after cyclic polarization testing. Both localized and general corrosion were observed on the exposed regions, consistent with the electrochemical data. A patina was observed on exposed and covered regions after cyclic polarization, as well as on exposed copper surfaces after immersion aging (Figure 49b). The observation of a patina on covered areas after cyclic polarization testing indicates that water may penetrate beneath the polymer sheath and cause corrosion of the copper conductor in regions that are not directly exposed to the surrounding environment.

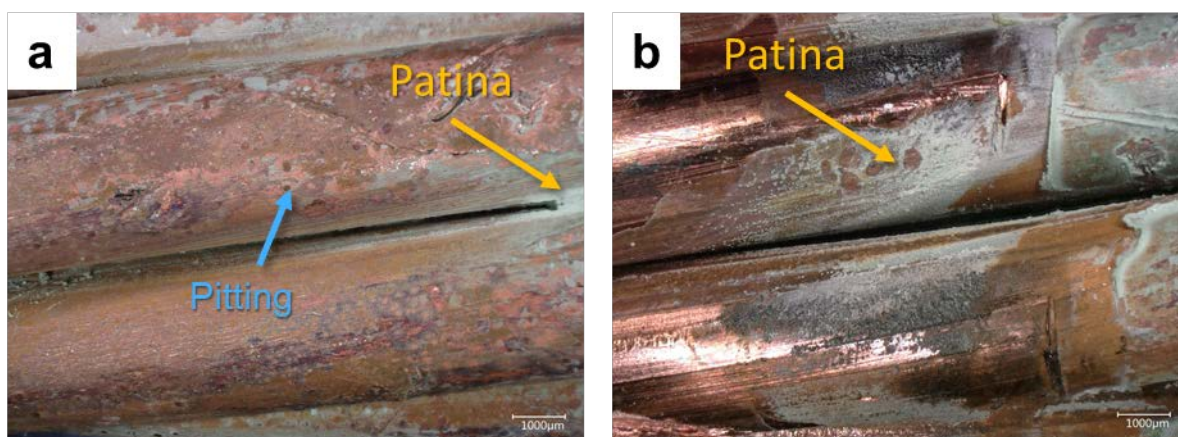

Figure 53. Representative optical microscopy images of (a) stripped and (b) covered portions of an unaged cyclic polarization tested 17-kV copper CC.

Discussion and Conclusions: Corrosion Testing

The testing described in this section investigated the corrosion susceptibility of CCs relative to bare conductors. To assess this, Exponent performed liquid ingress testing, salt spray testing, and cyclic polarization testing. The major conclusions from this combined set of tests are:

- Stripped ends of CCs, as well as CCs with IPC hardware, are susceptible to water ingress. The methods used here to test water ingress are more aggressive than what would typically be encountered in the field but indicate that water may penetrate and traverse through the conductor core to the nearest elevation minimum.
- Corrosion can occur beneath the polymer sheath in highly corrosive environments. Corrosion was observed at least 2–3 feet away from the nearest exposed metal under the tested conditions.
- Although the salt spray testing conditions used here are more severe than what would be encountered in the field, and no potential mitigation measures were considered, the results indicate that it is possible for corrosion to occur beneath the polymer sheath of CCs, and, in some cases, the corrosion that occurs beneath the sheath may be more severe than that which occurs on bare, exposed conductors.
- The condition of the stripped end, including the technique used to remove the polymer sheath and the presence of artificial crevices, did not appear to have a significant effect on the corrosion susceptibility of CCs. The presence of damage to the polymer sheath at midspan regions of CCs did appear to have potential for more severe corrosion than that observed at stripped ends. CCs with IPC hardware did not appear to be susceptible to corrosion at the IPC installation area under the tested conditions despite the previous evidence of water ingress. This apparent discrepancy is likely due to the aggressive nature of the ingress test (i.e., full immersion).
- The corrosion that was observed did not have a significant adverse effect on the tensile strength of the conductor strands. A small decrease in tensile strength was observed for salt-spray-tested aluminum and copper strands from CCs relative to salt-spray-tested aluminum and copper strands from bare conductors and to as-received aluminum and copper strands from bare conductors. This may be due to annealing of the conductor strands during application of the polymer sheath; additional testing would be needed to fully evaluate these differences.
- A decrease in tensile strength was observed for salt-spray-tested aluminum strands from ACSR CCs with IPC hardware relative to bare, as-received ACSR conductors; this decrease is likely due to mechanical damage to the conductor strands from IPC installation, as no visual evidence of corrosion was observed on the IPC samples.
- Electrochemical testing indicated that both ACSR and copper conductors are susceptible to localized corrosion at or very near their rest potentials. This may be due to crevices introduced by the stranding or mechanical damage from the stranding process. No significant difference in corrosion susceptibility between CCs and bare conductors was observed electrochemically.
- Pitting and general corrosion was evident on bare conductors and exposed areas of CCs after electrochemical testing. Corrosion was also observed beneath the polymer sheath after electrochemical testing, particularly for ACSR CCs.

Flammability Testing

Motivation and Scope

CCs may be subject to unique failure modes compared to traditional conductors. Specifically, the polymer sheath of a CC may be damaged from nearby wildfires or may have the potential to ignite under certain circumstances. To improve understanding of the latter, a cone calorimeter was utilized to determine the conditions under which heat from a nearby wildfire could ignite the polymer sheath. ASTM E1354 provides a methodology on determining the incident heat flux and time required to induce sustained flaming ignition of the sample.²⁷ However, as ASTM E1354 specifies a flat sample with dimensions of 10 cm x 10 cm, which was incompatible with testing CCs, the setup was modified to use a 10-centimeter-long CC in its place. The modified test setup was designed to subject the sample to a heat flux that is representative of its intended geometry and orientation without compromising the integrity of the data.

Table 21 describes the test cases used to assess the autoignition (ignition without a spark) properties of the polymer sheaths on CCs. Test cases are indicated in Table 21 with an “X.” Exponent performed heat flux testing on 15-kV, 17-kV, and 35-kV ACSR CCs; 22-kV AAC CCs; and 17-kV-rated copper CCs. The time to autoignition was assessed for all CCs at the following incident heat fluxes: 25, 30, 35, and 50 kW/m². Exponent evaluated the behavior of the copper CCs at one additional heat flux, 28 kW/m² to clarify its minimum autoignition temperature, and evaluated the ignition behavior of the 15-kV ACSR and 22-kV AAC at 65 and 80 kW/m² to confirm its propensity for ignition at higher heat flux values. Results were then compared with known heat flux values for wildland fires from the literature.

Table 21. Incident heat flux tests conducted to determine autoignition properties.

Heat Flux (kW m ⁻²)	2/0 Cu CC	1/0 ACSR CC			AAC CC
	17 kV	17 kV	35 kV	15 kV	22 kV
25	X	X	X	X	X
28	X	Not Tested	Not Tested	Not Tested	Not Tested
30	X	X	X	X	X
35	X	X	X	X	X
50	X	X	X	X	X
65	Not Tested	Not Tested	Not Tested	X	X
80	Not Tested	Not Tested	Not Tested	X	X

²⁷ ASTM E1354-17 “Standard Test Method for Heat and Visible Smoke Release Rates for Materials and Products Using an Oxygen Consumption Calorimeter,” American Society for Testing and Materials, 2017.

Experimental Setup

The heat flux testing setup is shown in the Figure 54 schematic. The use of a conical radiant electric heater ensured that the sample experienced a constant heat flux across its top surface. The 10-centimeter-long CC sample was positioned on top of a refractory fiber blanket to support the sample and to ensure that an adiabatic surface was maintained. Additional pieces of refractory fiber blanket were used to cover approximately 1.3 cm of the cut ends of the conductor to reduce their impact on the ignition behavior and to ensure that the ignition conditions are representative of an extended piece of cable used in the field. Thus, a 7.6 cm portion of the CC was exposed to the radiant heat flux with the top edge of the CC 2.5 cm below the bottom surface of the electric heater.

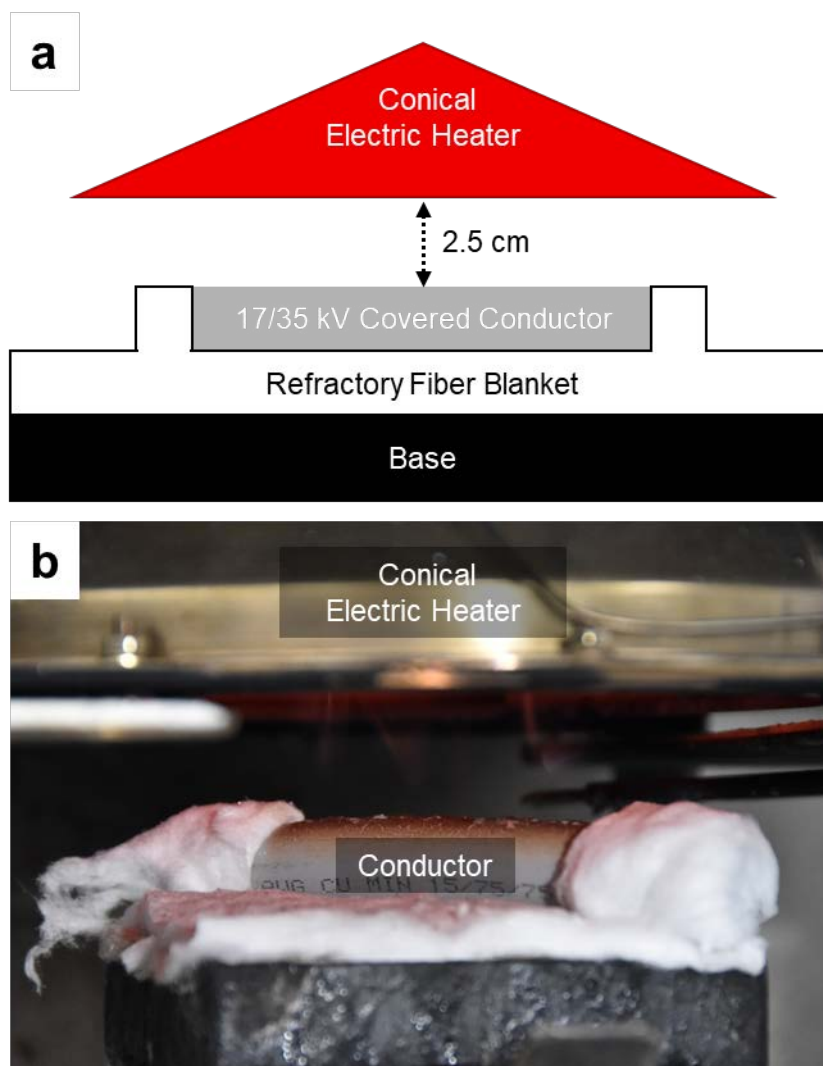

Figure 54. (a) Schematic and (b) representative photo of the heat flux testing apparatus. The top edge of the CC was spaced 2.5 cm from the bottom of the conical heat source. A refractory fiber blanket was used to provide an adiabatic back surface and protect the ends of the CC to reduce unwanted edge effects.

The test began when the CC was first exposed to the electric radiant heat source and was terminated when either no ignition occurred within a predetermined time or the combustible portion of the sample was fully consumed after ignition. The testing methodology evolved over the course of the experiment. Initially, Exponent imposed a 15-minute (900-second) time limit for testing. However, during testing it became clear that this time was insufficient to ignite the CCs for some of the heat fluxes of interest. Thus, in a few cases, the sample was heated until ignition occurred approximately 1,600 seconds after the test began.

Results

Table 22 presents the time to autoignition as a function of heat flux for all tested CCs. Note that due to the initial 900-second time limit on the test, the times to ignition for the 17-kV ACSR conductor, copper conductor, and AAC are unknown for 25 kW/m² because the tests were terminated before ignition occurred, indicating that more than 900 seconds of exposure would be required to ignite the materials at 25 kW/m², if ignition is possible at 25 kW/m². In practice, exposure times for CCs subjected to wildland fires are expected to be significantly less than 900 seconds. Therefore, higher heat fluxes would be required for autoignition.

Table 22. Autoignition times as a function of heat flux for all tested CCs.

Heat Flux (kW/m ²)	Cu t _{ig} (s)	ACSR t _{ig} (s)			AAC t _{ig} (s)
	17 kV	17kV	35kV	15kV	22kV
25	Unknown		1594 (26.6 min)	776 (12.9 min)	Unknown
28	1616 (26.9 min)	Not tested			
30	677 (11.3 min)	975 (16.3 min)	831 (13.9 min)	635 (10.6 min)	667 (11.1 min)
35	239 (4.0 min)	376 (6.3 min)	444 (7.4 min)	383 (6.4 min)	481 (8.0 min)
50	128 (2.1 min)	118 (2.0 min)	84 (1.4 min)	101 (1.7 min)	178 (3.0 min)
65	Not tested			63 (1.1 min)	44 (0.7 min)
80	Not tested			27 (0.5 min)	28 (0.5 min)

Discussion and Conclusions: Flammability Testing

Ignition of solid materials can be divided into two distinct regimes: thermally thin ignition and thermally thick ignition. In general, the time to autoignition (t_{ig}) for a thermally thin sample (i.e., one with a uniform temperature across the sample) is linearly related to the inverse incident heat flux (ϕ_q). For a thermally thick sample (i.e., one with a thermal gradient from the surface to the interior), the heat flux is expected to be inversely proportional to the square root of the time to ignition (i.e., $\phi_q \propto \frac{1}{\sqrt{t_{ig}}}$). In both instances, the time to ignition is expected to decrease as a function of increasing heat flux. Based on the thickness of the polymer sheath (see Table 2), Exponent expected that the CCs were best described using a thermally thick ignition regime. Thus, Figure 55 portrays the inverse square root of the ignition time, $\frac{1}{\sqrt{t_{ig}}}$ (using data from Table 22), as a function of incident heat flux. As expected, the ignition times and corresponding heat fluxes for ignition produce a linear trend of ignition times exponentially increasing as the heat flux decreases. Given that the CC polymer sheath is the same material for all conductor

types (copper, ACSR, and AAC) and a thermally thick regime is employed, the conductor material and sheath thickness do not impact the autoignition behavior. Thus, using the data from all conductor types, Exponent found a correlation between the ignition time (in seconds) and incident heat flux (in kW/m²) to be $t_{ig}^{-0.5} = 0.003\phi_q - 0.0543$.

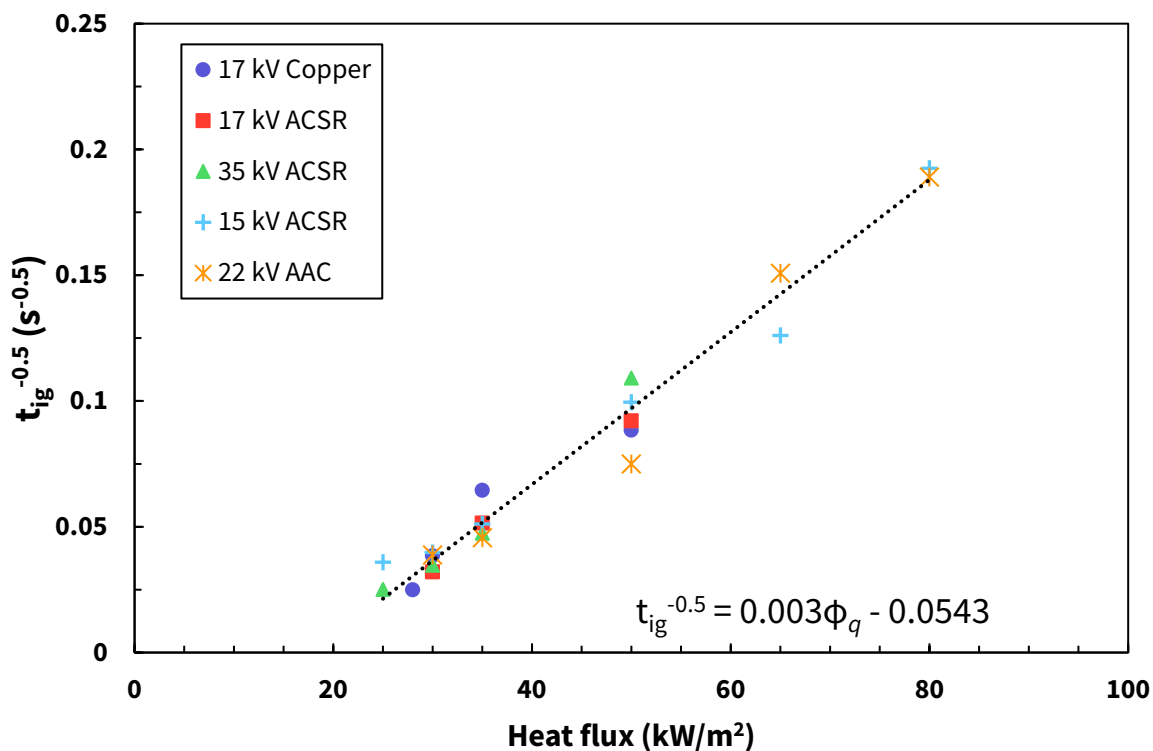

Figure 55. Symbols portray the autoignition time (plotted as the inverse square root) as a function of incident heat flux from cone calorimetry tests. The line is a linear best fit providing a correlation between heat flux and ignition times for the CCs.

Wildland fires are generally categorized into three different groups. The first group, surface fires, represent fires that primarily burn surface vegetation such as twigs and dried leaves. The second group, brush fires, include fires in which the fuel load significantly consists of grasses and brush vegetation that extends several meters above the ground. The third group, crown fires, include fires that burn primarily in the canopy of trees and spread from treetop to treetop. To evaluate the CCs' propensity for autoignition, experimental results from the cone calorimetry tests were compared to representative heat fluxes and corresponding residence times of wildland fires.

A detailed review of available literature was performed, and multiple sources that gathered real-world data from numerous actual wildland fires were identified.^{28,29,30,31} Representative time-averaged radiative heat fluxes and associated residence times from wildland fires were reviewed for each of the three wildland fire groups discussed previously. The residence time represents the duration in which the fire was in contact with the sensor (i.e., the duration used for the time-averaging). It was found that surface fires exhibited a range of time-averaged radiative heat fluxes of 18–77 kW/m² over a duration of approximately 4–42 seconds with an instantaneous peak recorded heat flux of 115 kW/m².

Next, the brush fires were found to have a time-averaged heat flux on the order of 97 to 110 kW/m² with a residence time of 10–40 seconds and a measured peak heat flux of 132 kW/m². Finally, the crown fires were shown to produce time-averaged radiative heat fluxes ranging from 179 to 263 kW/m² over a period of 50 seconds with a measured peak heat flux of 300 kW/m². It is important to note that for each of the heat flux ranges above, the measurements were collected from sensors positioned approximately one meter above the ground and were collected from sensors positioned inside the flame in direct contact with the flame of the passing fire front.

To provide a conservative comparison between the estimated autoignition heat flux and reported heat flux values from wildland fires, the peak radiative heat flux values discussed above were employed. Peak radiative heat fluxes and associated residence times from full-scale wildland fire measurements are shown as symbols in Figure 56 for surface, brush, and crown fires.³² The solid line in Figure 56 represents the minimum combination of heat flux and residence time for autoignition of the CCs computed using the correlation experimentally derived above. The region above the solid line represents a fire scenario (CC surface heat flux and exposure time) in which ignition is likely to occur, and the region below indicates fire regimes in which ignition of the CC sheath is unlikely.

²⁸ Butler, B., et al. “Measurements of radiant emissive power and temperatures in crown fires.” *Canadian Journal of Forest Research* (2004): 1577-1587.

²⁹ Morandini, F., et al. “Fire spread experiment across Mediterranean shrub: Influence of wind on flame front properties.” *Fire Safety Journal* 41 (2006) 229-235.

³⁰ Silvani, X., and Morandini, F. “Fire spread experiments in the field: Temperature and heat fluxes measurements.” *Fire Safety Journal* 44 (2009) 279-285.

³¹ Frankman, D., et al. “Measurements of convective and radiative heating in wildland fires.” *International Journal of Wildland Fire* 22.2 (2013): 157-167.

³² Ibid.

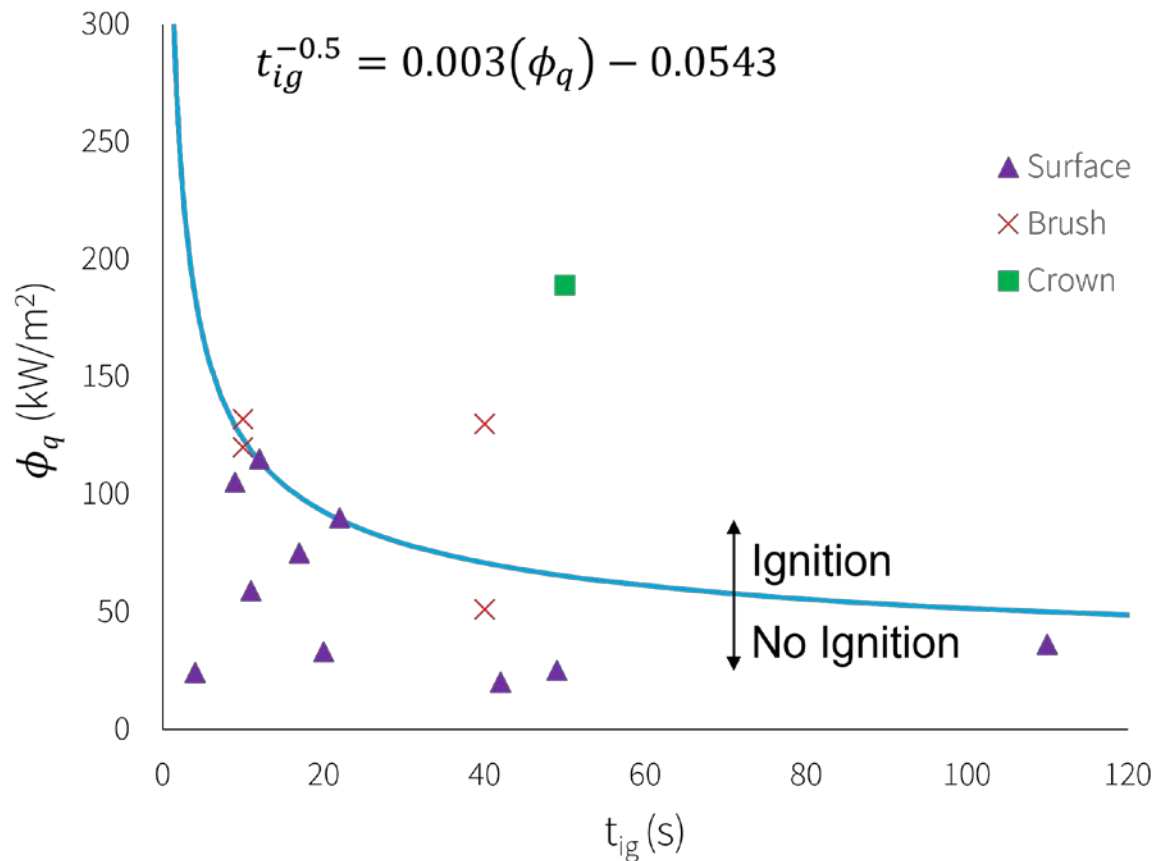

Figure 56. Critical heat flux and associated residence time for autoignition. Symbols represent full-scale wildland fire data. The blue line represents the theoretical minimum heat flux required for autoignition derived from cone calorimetry experiments and thermally thick ignition theory.

With respect to the ignition of CCs, which are often installed on poles high above the ground, Figure 56 demonstrates that certain scenarios have the potential to lead to an autoignition scenario while others are unlikely. Surface fires and low-lying brush fires exhibit a low probability that autoignition will occur, given the combination of average heat fluxes, associated residence times, and distance between the fire and the conductors. It is important to note that the individual data points presented in Figure 56 represent a peak value measured directly inside the flame. However, a typical crown/ canopy fire has the potential to ignite the CC due to its immense heat flux, extended residence times, and proximity to the distribution lines.

System Strength Testing

Scope

Mechanical strength testing was performed to measure the breaking strength of individual CC system components and to understand their failure modes/behaviors, as well as to understand their behavior within the context of the overall system. Testing was performed on 15-kV, 17-kV, and 35-kV 1/0 ACSR, as well as 22-kV-rated 397.5 kcmil AAC CCs. The specified dimensions, stranding, and rated tensile strengths of these CCs can be found in Table 3. Three unique tests were performed to achieve these goals:

1. **Splice Maximum Load Test:** This test was designed to measure the strength of the splice-conductor assembly under tension.
2. **Insulator Slip Test:** This test was designed to measure the tensile load at which conductor slippage relative to the tangent insulator occurs, and how the insulator may fail after the onset of slippage.
3. **Full-System Tree-Fall Test:** This test was intended to simulate the response of the full system (i.e., pole, cross-arm, insulators, and CC) if a tree were to fall into a span. Both load and failure behavior were recorded.

Further, SCE expressed specific interest in understanding the mechanical limits of selected combinations of dead-end hardware and equipment. Exponent worked with SCE to design and execute mechanical tests similar to the joint-IOU mechanical tests discussed here, but with use of dead-end hardware instead of tangent structures/insulators. The results of this dead-end testing are included in Appendix E.

Experimental Setup

Splice Maximum Load Test

Test Setup and Equipment

The maximum load tests were performed using unique splice designs/manufacturers for the 15-kV ACSR CCs, 17-kV and 35-kV ACSR CCs, and 22-kV AAC CC. Splices were provided pre-installed on the 15-kV conductor by SDG&E. All other splice installation was carried out using appropriate hydraulic crimping tools and dies.

Tests were performed in a hydraulic horizontal test machine, and epoxy resin dead-end fittings were used to terminate the free ends of the conductor and minimize stress concentration at the grips. ASO 398 bolted clamps were used to test the 15-kV ACSR CCs. The overall test sample length was approximately 12 feet for the 15-kV ACSR and 44 feet for all other conductors. In every case, the splice was positioned near the center of the span. Testing was performed in general accordance with the procedures outlined in ANSI C119.4-2016 (Clause 6.2.2.2,

Maximum Load)³³ and ANSI C119.0-2015.³⁴ A schematic diagram and representative photo of the test setup are shown in Figure 57 and Figure 58, respectively.

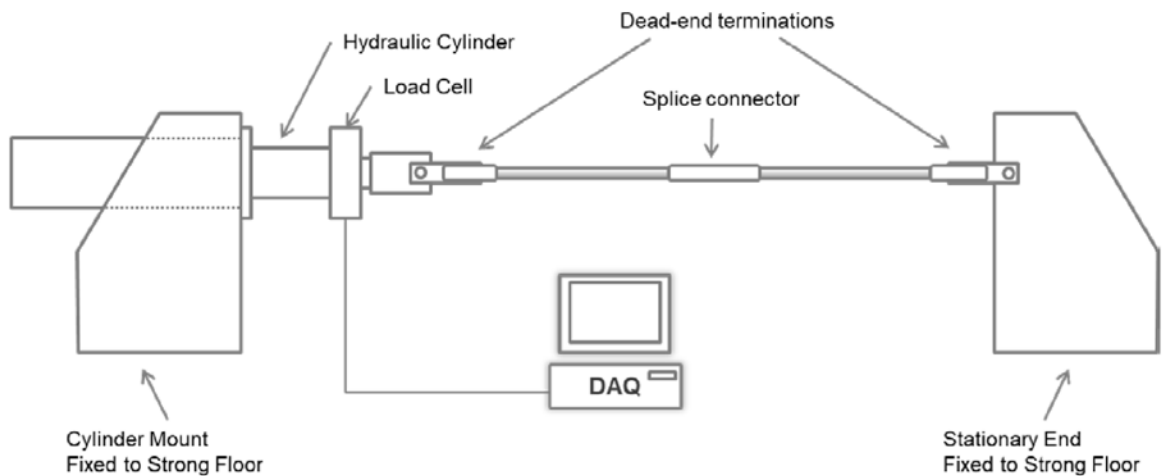

Figure 57. Schematic diagram of splice maximum load test.

³³ ANSI C119.4-2016, "American National Standard for Electric Connectors – Connectors for Use Between Aluminum-to-Aluminum and Aluminum-to-Copper Conductors Designed for Normal Operation at or Below 93C," Clause 6.2.2.2 (Maximum Load).

³⁴ ANSI C119.0-2015, "American National Standard for Electric Connectors – Testing Methods and Equipment Common to the ANSI C119 Family of Standards."

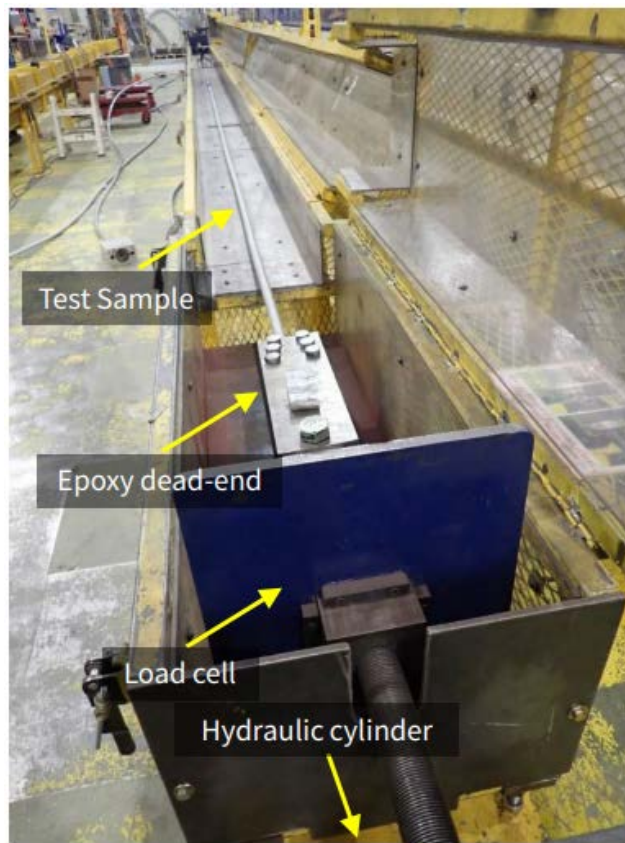

Figure 58. Representative photo of splice maximum load test.

Testing Procedure

The test sample (conductor-splice assembly) was installed in the horizontal test machine and was pre-tensioned to approximately 10% of the rated tensile strength (RTS) of the tested conductor. The conductor was marked with paint at the entrance points on each end of the splice to monitor movement of the conductor relative to the splice during the test. The south end was painted red and the north end was painted blue, where north and south relate to the orientation of the horizontal load frame.

The load was then increased to approximately 60% RTS and held for five minutes. The conductor was visually monitored for slippage at both ends of the splice. Upon completing the five-minute hold, the load was increased until failure was observed. A representative load versus time plot for this loading profile is shown in Figure 59. Tests on each conductor type were performed in triplicate.

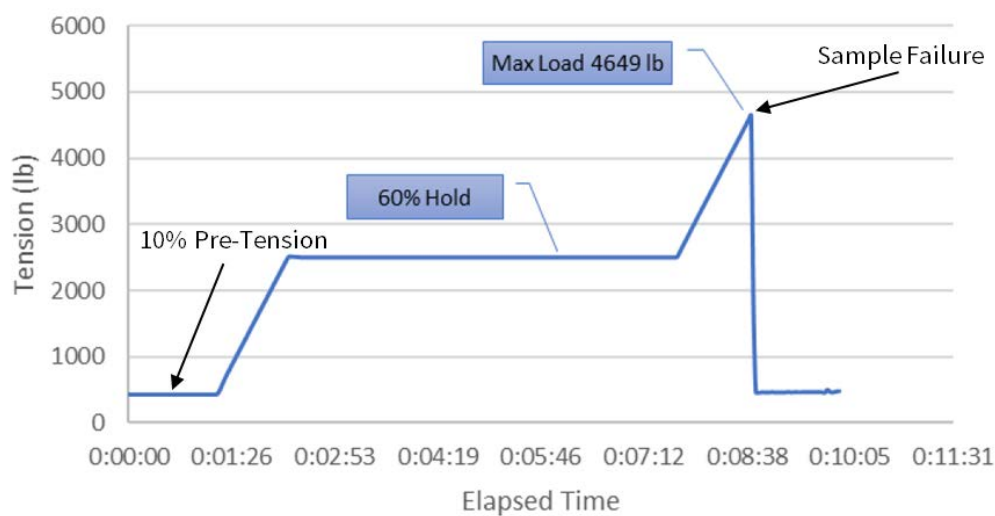

Figure 59. Representative load vs. time plot for the splice maximum load test (Test 1.1).

Insulator Slip Test

Test Setup and Equipment

The insulator slip tests were performed on vise-top pin insulators on all four CC types, as well as clamp-top post insulators on the 17-kV and 35-kV ACSR CCs. Insulators were installed on wooden blocks to simulate a typical cross-arm center phase connection.

Tests were performed in a hydraulic horizontal test machine, and epoxy resin dead-end fittings were used to terminate the free ends of the conductor and minimize stress concentration at the grips. Multiple insulator “stations” were positioned along the conductor in 10-foot intervals such that subsequent tests could be performed on the same conductor span in an area unaffected by the previous test. A schematic diagram and representative photo of the test setup are shown in Figure 60 and Figure 61, respectively.

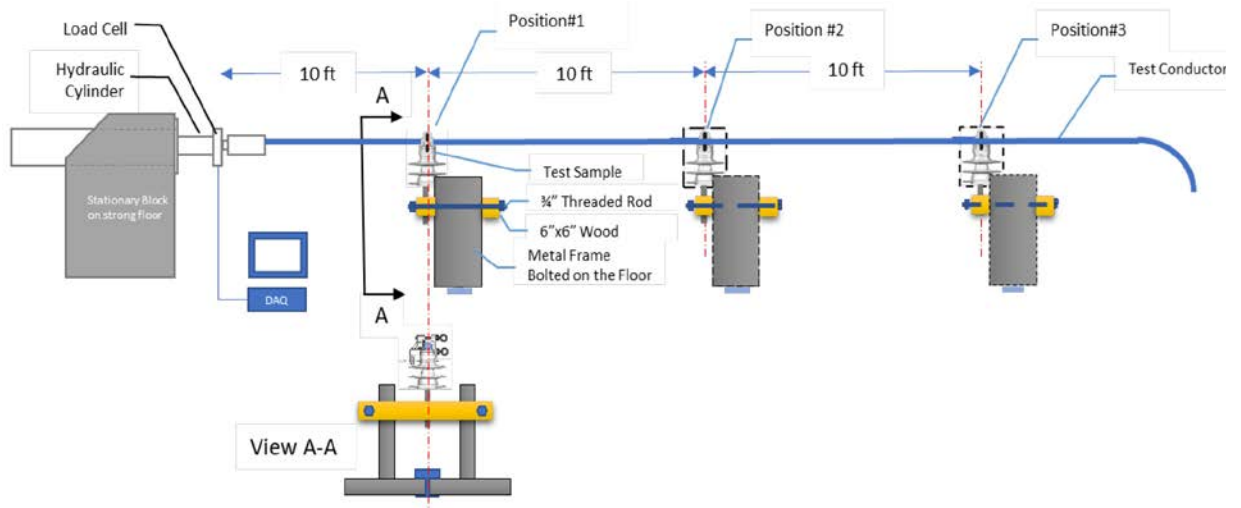

Figure 60. Schematic diagram of insulator slip test.



Figure 61. Representative photos of insulator slip test.

Testing Procedure

The insulators were installed on the simulated cross-arm, and the conductor was clamped into position atop the insulator. The conductor tension was increased to 10% RTS, and the conductor ends were marked at the entry points to the insulator clamp. The tension was then increased to

20% RTS, and the conductor was visually inspected for signs of slippage. Once complete, the tensile load was continuously increased at a rate of 1000 lb/min until slippage of the conductor inside the clamp occurred. A representative load versus time plot for this loading profile is shown in Figure 62. Tests on each conductor type were performed in triplicate.

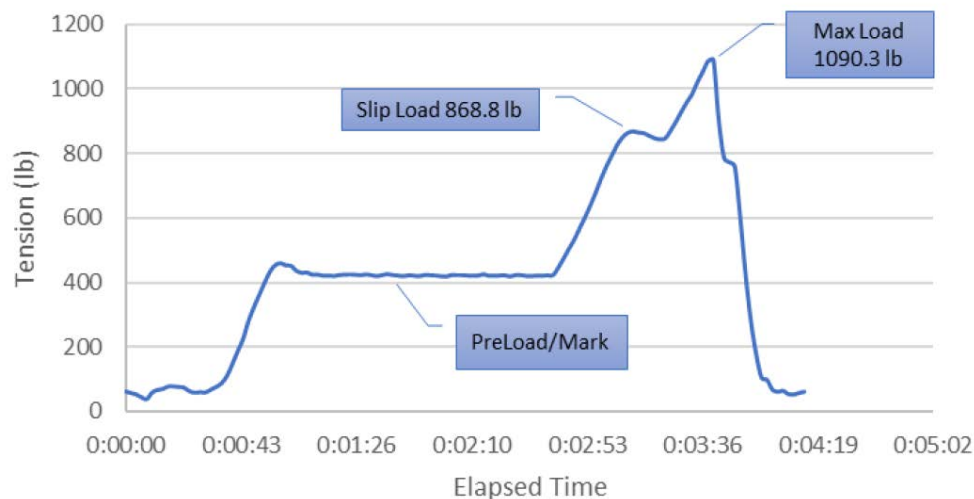

Figure 62. Representative load vs. time plot for the insulator slip test.

Full System Tree-Fall Test

Test Setup and Equipment

Full system mock-up tests were performed using all four conductor types and corresponding hardware, including representative insulators and composite cross-arms. Both vise-top pin and clamp-top insulators were tested for the 17-kV and 35-kV ACSR CCs. The cross-arm assemblies were mounted to a pole stub with standard hardware to simulate a realistic distribution pole configuration.

The tests were performed in a hydraulic horizontal test machine, and dead-ends were used to terminate the free ends of the conductor. A pulley system was implemented to induce a vertical loading component at the cross-arm, and a load cell was attached to the pulley adjacent to the cross-arm to measure vertical loads. The deflection of the conductor toward the pulley was approximately 40 degrees on the insulator side (north). The conductor span on the unloaded (north) side of the insulator was fixed at the end but was kept slack to simulate an adjacent conductor span. A schematic diagram and representative photo of the test setup are shown in Figure 63 and Figure 64, respectively.

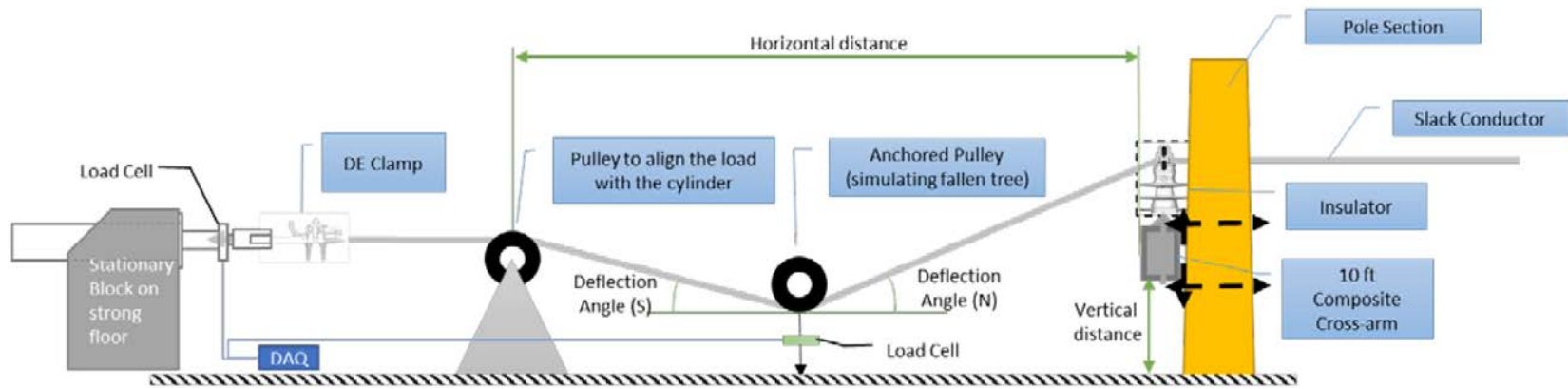

Figure 63. Schematic diagram of the full-system tree-fall test.

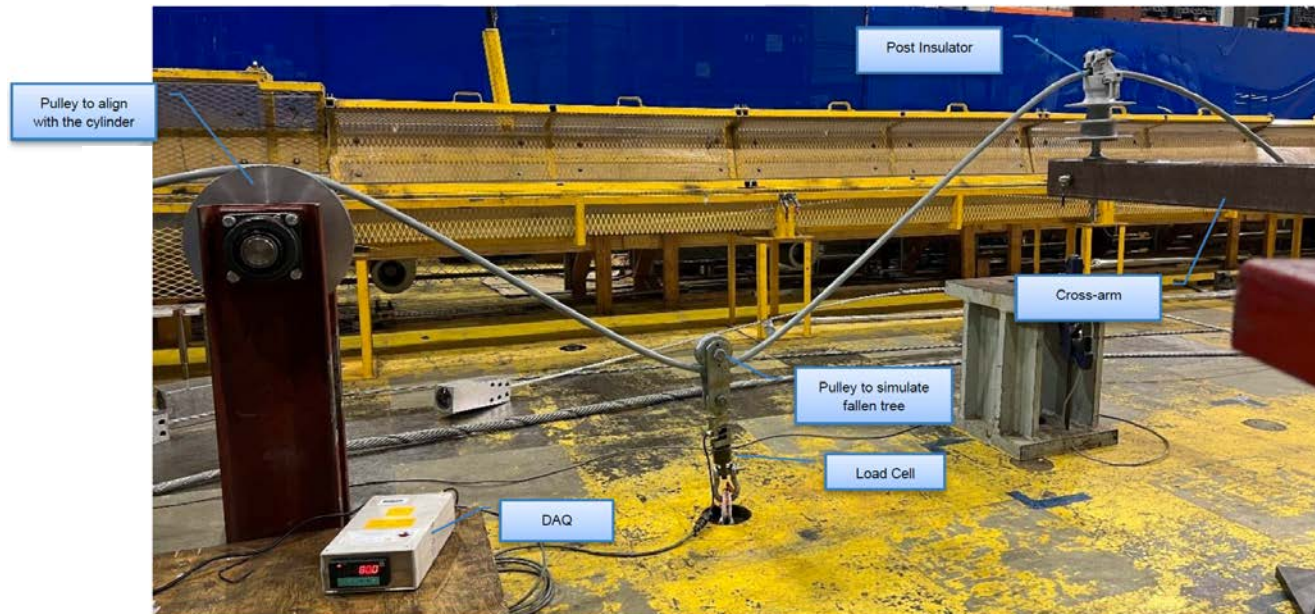

Figure 64. A representative photo of the full-system tree-fall test.

Testing Procedure

The test system including conductor, insulator, and cross-arm is shown in Figure 64. A small pre-tension was applied to remove the slack from the conductor, and the conductor was marked at the insulator clamp entry points to monitor for slippage. The horizontal load was continuously increased at a rate of 1,000 lb/min until damage to the cross-arm or slippage of the conductor occurred. The target vertical load on the pulley was approximately 1000 lb. Loads at the hydraulic cylinder and at the pulley attached to the floor were monitored throughout the test. The permanent deflection of the cross-arm was measured by referencing the vertical distance of the insulator attachment point on the cross-arm to the floor.

Results

Splice Maximum Load Test

Tabulated results of the splice maximum load tests are presented in Table 23. All tested splices exceeded 100% of the rated conductor strength. Further, no slippage was observed either at the five-minute hold at 60% RTS or just prior to failure. Complete test details, including load versus time plots and photos, can be found in Appendix F.

Separation of conductor strands, or “birdcaging,” was observed following installation of splices on both 17-kV and 35-kV ACSR CCs. An example of the birdcaging is shown in Figure 65. Subsequent failure of the conductor occurred in the birdcaged area in four out of six tests (66%). Despite this, all 17-kV and 35-kV spliced conductors exceeded 100% of the conductor RTS when tested.

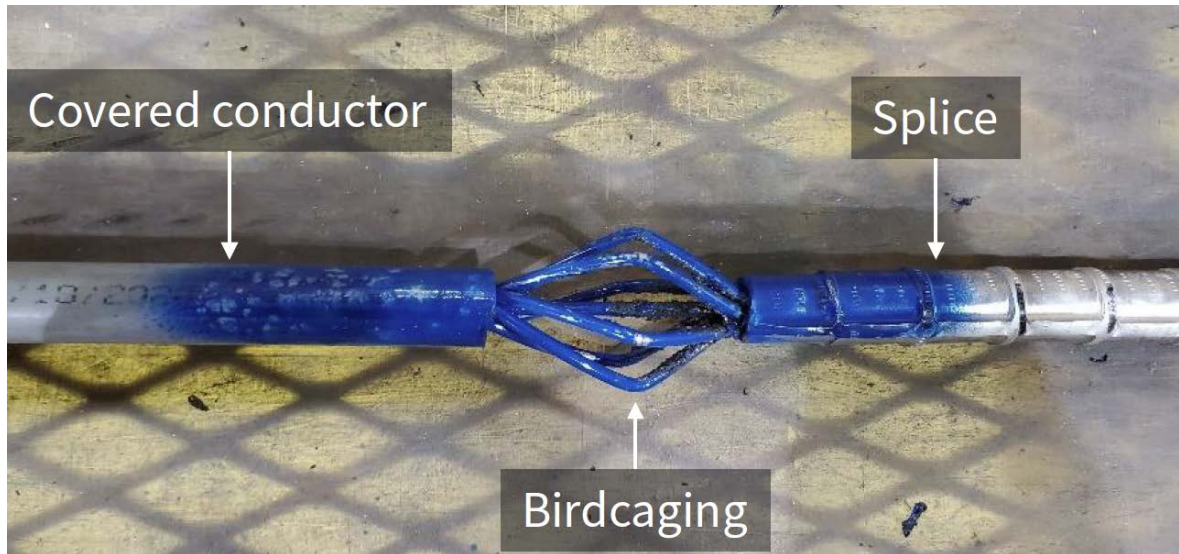

Figure 65. A representative photograph showing the birdcaging behavior of splices on 17-kV and 35-kV ACSR CCs.

Table 23. Results of splice maximum load tests.

Sample #	Conductor Type	Max. Load		Observations
		(lb)	(% RTS)	
1.1.1	17-kV, 1/0 AWG ACSR	4,659	112%	No slippage at 60% RTS. Aluminum strands broke near south end of splice. Steel core intact.
1.1.2	17-kV, 1/0 AWG ACSR	4,724	114%	No slippage at 60% RTS. Aluminum strands broke near south end of splice. Steel core intact.
1.1.3	17-kV, 1/0 AWG ACSR	4,517	109%	No slippage at 60% RTS. Conductor broke at north epoxy block. Steel core pulled out completely.
1.2.1	35-kV, 1/0 AWG ACSR	4,454	107%	No slippage at 60% RTS. Conductor broke near south end of splice. Steel core pulled out completely.
1.2.2	35-kV, 1/0 AWG ACSR	4,623	111%	No slippage at 60% RTS. Aluminum strands broke at south end of splice. Steel core intact.
1.2.3	35-kV, 1/0 AWG ACSR	4,213	101%	No slippage at 60% RTS. Conductor broke at north epoxy block.
1.3.1	22-kV, 397.5 kcmil AAC	6,979	103%	No slippage at 60% RTS. Conductor broke at south end of splice.
1.3.2	22-kV, 397.5 kcmil AAC	7,152	106%	No slippage at 60% RTS. Conductor broke at south end of splice.
1.3.3	22-kV, 397.5 kcmil AAC	7,245	107%	No slippage at 60% RTS. Conductor broke at south end of splice.
1.4.1	15-kV, 1/0 AWG ACSR	4,263	102%	No slippage at 60% RTS. Conductor pulled out of south dead-end.
1.4.2	15-kV, 1/0 AWG ACSR	4,625	111%	No slippage at 60% RTS. Conductor broke at north end of splice.
1.4.3	15-kV, 1/0 AWG ACSR	4,626	111%	No slippage at 60% RTS. Conductor broke at south dead-end.

Insulator Slip Test

Tabulated results of the insulator slip tests are presented in Table 24. Insulator slip behavior showed a minor dependence on conductor size (i.e., larger diameter conductor generally had a higher maximum load) likely due to increased contact area with the clamping hardware. Additionally, the slip behavior of vise-top and clamp-top insulators was different. Vise-top insulators held the conductor firmly in the plastic inserts, which resulted in deformation of the insulator at the mounting pin, as shown in Figure 66. This created a misalignment between the conductor and the insulator vise top, allowing the conductor to lift out of the plastic insert and start to slip. No damage to the insulator apart from the deformation of the pin was observed after testing. The conductor also remained largely undamaged except for some superficial damage to the polymer sheath, an example of which is shown in Figure 67.

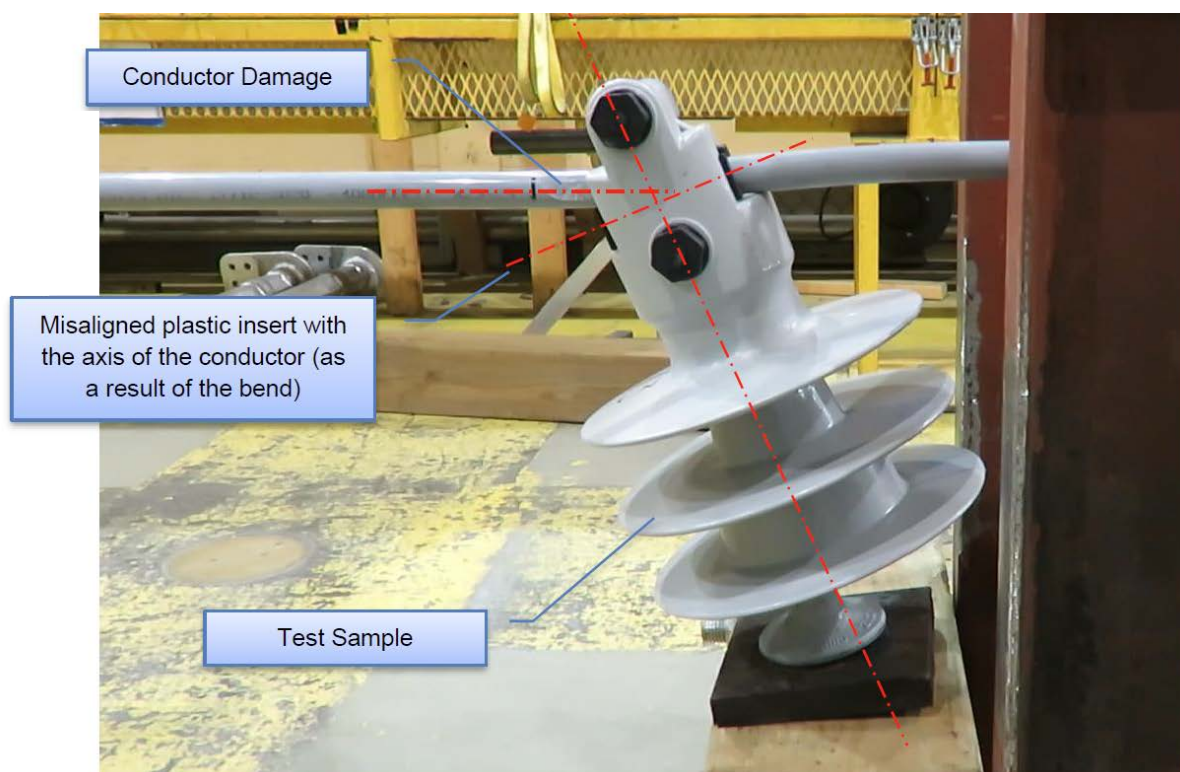

Figure 66. A representative post-test image of a vise-top insulator illustrating the bending behavior of the insulator that leads to conductor slippage (1/0 ACSR).



Figure 67. A representative post-test image of a 17-kV ACSR CC showing superficial damage to the polymer sheath caused by slippage.

Slippage of clamp-top post insulators (tested for the 17-kV and 35-kV ACSR CC only) occurred at significantly lower tensile loads relative to the vise-top pin insulators, with an average maximum load of 355 lb for 17-kV and 442 lb for 35-kV compared with 1,058 lb for 17-kV and 1,014 lb for 35-kV with the vise-top insulators. The mechanism of slippage was also different; despite a moderate forward “bend” during testing, no gross deformation was observed on the insulator or mounting hardware post-test. Rather, the conductors began to slip when tensile loads exceeded the clamping force of the insulator. A representative image illustrating the extent of conductor slippage is shown in Figure 68. No damage to the polymer sheath of the conductor was observed following slippage in the clamp-top insulators. Complete test details, including load versus time plots and photos, can be found in Appendix F.

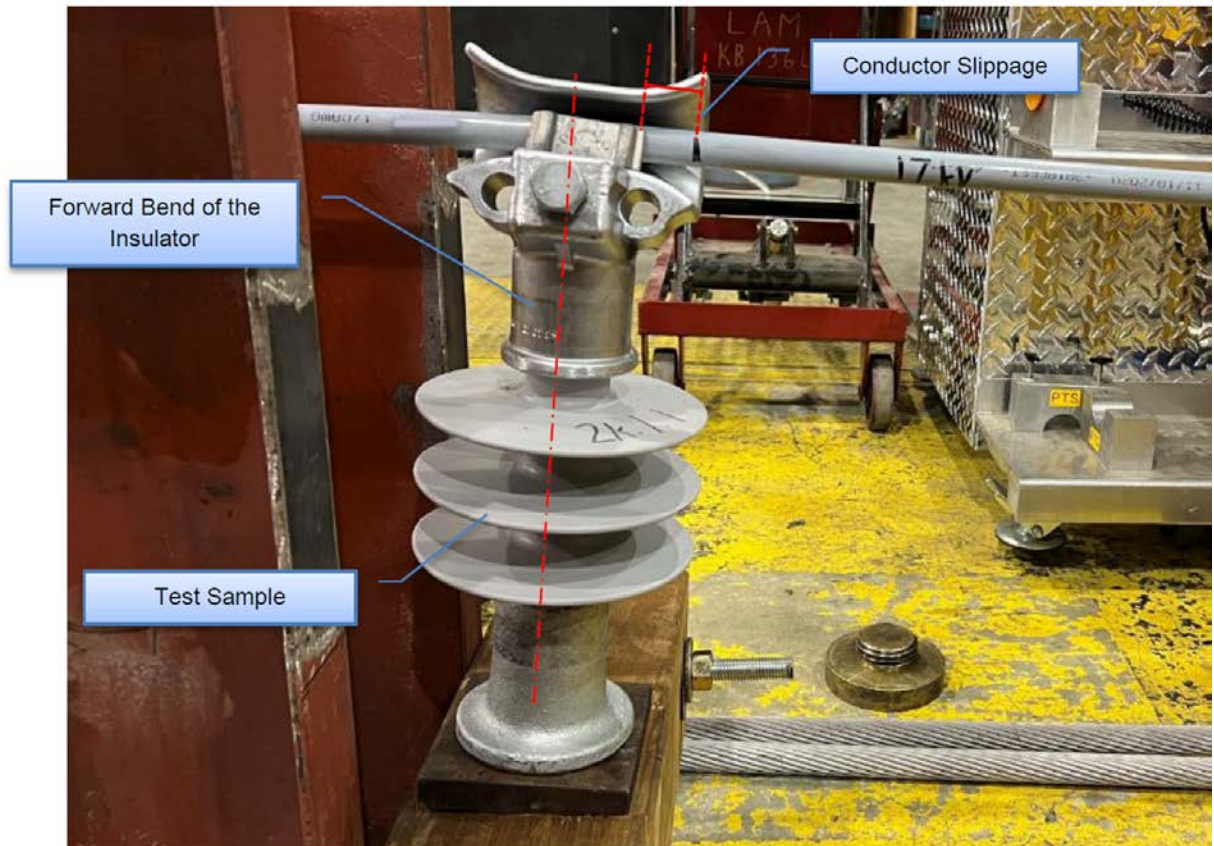

Figure 68. A representative post-test image of a clamp-top insulator illustrating the extent of conductor slippage (1/0 ACSR).

Table 24. Results of insulator slip tests.

Sample #	Insulator	Conductor Type	Max. Load		Observations
			(lb)	(% RTS)	
2.1.1	Vise-top pin	17-kV, 1/0 AWG ACSR	1090.3	26.2%	Slippage started at 868.8 lb.
2.1.2	Vise-top pin	17-kV, 1/0 AWG ACSR	1040.6	25.0%	Slippage started at 865.5 lb.
2.1.3	Vise-top pin	17-kV, 1/0 AWG ACSR	1043.9	25.1%	Slippage started at 870.2 lb.
2.2.1	Vise-top pin	35-kV, 1/0 AWG ACSR	970.9	23.3%	Slippage started at 879.8 lb.
2.2.2	Vise-top pin	35-kV, 1/0 AWG ACSR	1048.3	25.2%	Slippage started at 862.7 lb.
2.2.3	Vise-top pin	35-kV, 1/0 AWG ACSR	1024.1	24.6%	Slippage started at 872.0 lb.
2.3.1	Vise-top pin	22-kV, 397.5 kcmil AAC	1107.3	16.4%	Minimal slippage before max. load.
2.3.2	Vise-top pin	22-kV, 397.5 kcmil AAC	1195.1	17.7%	Minimal slippage before max. load.
2.3.3	Vise-top pin	22-kV, 397.5 kcmil AAC	1142.9	16.9%	Minimal slippage before max. load.
2.4.1	Vise-top pin	15-kV, 1/0 AWG ACSR	863.3	20.8%	Minimal slippage before max. load.
2.4.2	Vise-top pin	15-kV, 1/0 AWG ACSR	847.4	20.4%	Minimal slippage before max. load.
2.4.3	Vise-top pin	15-kV, 1/0 AWG ACSR	872.6	21.0%	Minimal slippage before max. load.
2K.1.1	Clamp-top post	17-kV, 1/0 AWG ACSR	380.4	9.1%	Slippage started before hold.
2K.1.2	Clamp-top post	17-kV, 1/0 AWG ACSR	391.8	9.4%	Slippage started before hold.
2K.1.3	Clamp-top post	17-kV, 1/0 AWG ACSR	291.9	7.0%	Slippage started before hold.
2K.2.1	Clamp-top post	35-kV, 1/0 AWG ACSR	486.7	11.7%	Slippage started before hold.
2K.2.2	Clamp-top post	35-kV, 1/0 AWG ACSR	393.1	9.4%	Slippage started before hold.
2K.2.3	Clamp-top post	35-kV, 1/0 AWG ACSR	446.7	10.7%	Slippage started before hold.

Full-System Tree-Fall Test

Tabulated results of the full-system tree-fall tests are presented in Table 25. The tree-fall tests all exhibited significant bending/damage to the insulator and cross-arm hardware, or insulator slippage well below the rated tensile strength of the tested CC. Like the insulator slip tests described above, the deformation and slip behavior showed a strong dependence on the insulator type (vise top versus clamp top). Tests with vise-top insulators exhibited no slippage of the conductor in the insulator grip up to the maximum vertical test load, and only superficial marks were observed on the conductor at the grip location after the test (see Figure 69). The steel insulator pin and fiberglass cross-arm deformed significantly under load and retained a permanent deflection after test completion. Additionally, tilting of the steel insulator flange during loading resulted in cracking and damage to the cross-arm at the mounting location, as shown in Figure 70. This cracking eventually led to full splitting of the cross-arm and pull-out of the insulator pin at final failure (Figure 71).



Figure 69. A representative post-test image showing superficial marks on the conductor at the vise-top insulator grip location (17-kV 1/0 ACSR).



Figure 70. A representative post-test image showing insulator deformation and damage to the cross-arm at its connection point (35-kV 1/0 ACSR).

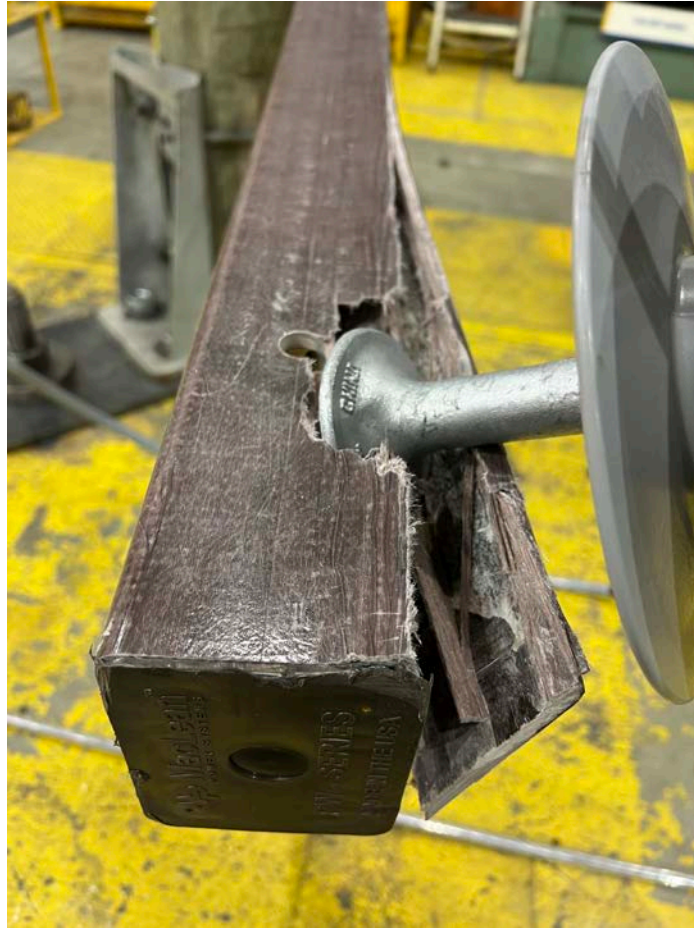

Figure 71. A representative post-test image showing pull-out of the insulator pin at final failure (17-kV 1/0 ACSR).

Tree-fall tests performed with clamp-top insulators exhibited insulator slippage at relatively low loads between approximately 400 and 700 lb, and none of the tests reached the target load of 1,000 lb. In contrast to the vise-top insulator tests, no bending or other damage was observed on the clamp-top insulators or fiberglass cross-arms, as shown in Figure 72. The moderate forward “bend” observed during insulator slip testing was not observed during the tree-fall tests, likely due to the relative compliance of the cross-arm in this configuration. Additionally, no damage was observed on the conductor polymer sheath post-test. Complete test details, including load vs. time plots and photos, can be found in Appendix F.

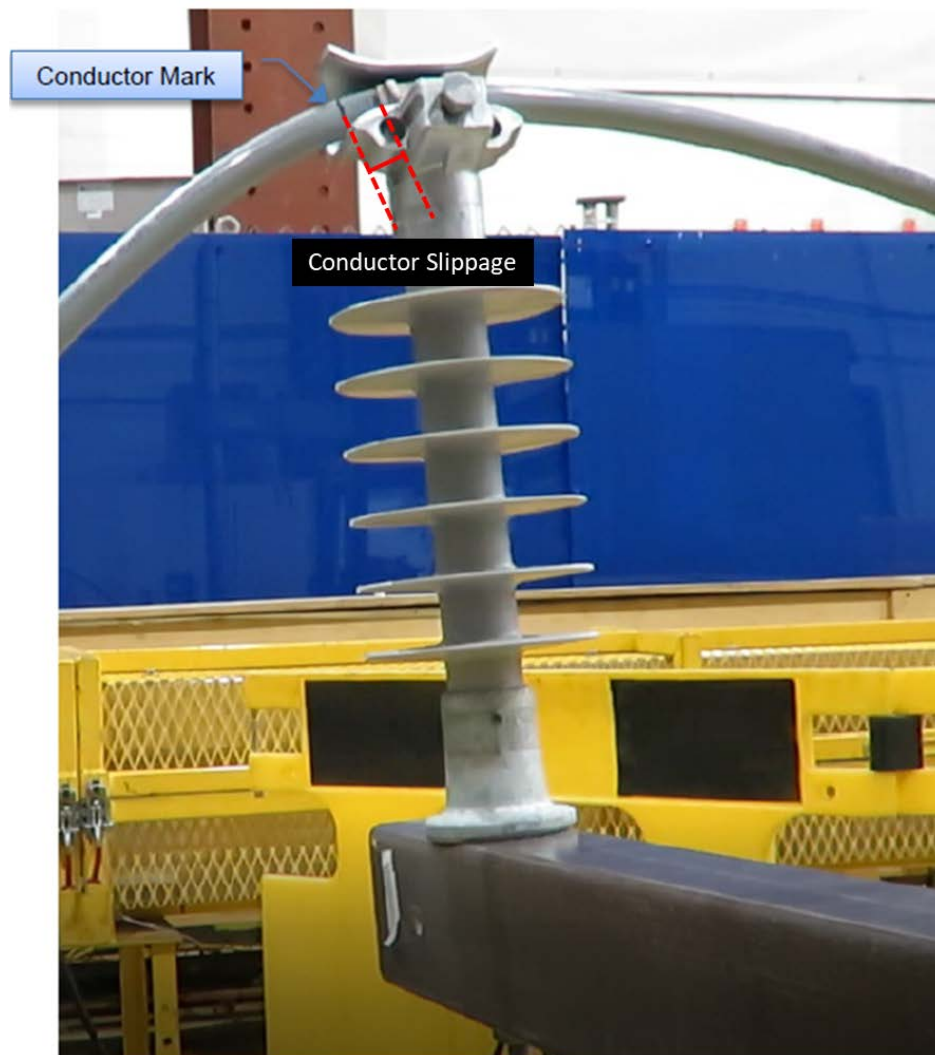

Figure 72. A representative post-test image of a clamp-top insulator tree-fall test (35-kV 1/0 ACSR).

Table 25. Results of full-system tree-fall tests.

Sample #	Conductor Type	Max. Vertical Load (lb)	Vertical Deflection of Cross-arm		Observations
			West* (in.)	East* (in.)	
3.1.1	17-kV, 1/0 AWG ACSR	939	-2.40	2.30	Cross-arm damaged at insulator flange. No slippage or conductor damage.
3.1.2	17-kV, 1/0 AWG ACSR	1,095	-3.00	2.64	No cross-arm damage, no slippage, no conductor damage.
3.1.3	17-kV, 1/0 AWG ACSR	1,042	-2.36	2.28	Cross-arm damaged at insulator flange. No slippage or conductor damage.
3.2.1	35-kV, 1/0 AWG ACSR	1,063	-1.97	1.65	Cross-arm damaged at insulator flange. No slippage or conductor damage.
3.2.2	35-kV, 1/0 AWG ACSR	985	-2.04	1.97	Cross-arm damaged at insulator flange. No slippage or conductor damage.
3.2.3	35-kV, 1/0 AWG ACSR	1,019	-1.26	1.02	Cross-arm damaged at insulator flange. No slippage or conductor damage.
3.3.1	22-kV, 397.5 kcmil AAC	1,326	-1.93	1.57	Cross-arm damaged at insulator flange. No slippage or conductor damage.
3.3.2	22-kV, 397.5 kcmil AAC	1,060	-1.77	1.61	Cross-arm damaged at insulator flange. No slippage or conductor damage.
3.3.3	22-kV, 397.5 kcmil AAC	988	-2.60	2.40	Cross-arm damaged at insulator flange. No slippage or conductor damage.
3.4.1	15-kV, 1/0 AWG ACSR	880	-0.35	0.35	Cross-arm damaged at insulator flange. No slippage or conductor damage.
3.4.2	15-kV, 1/0 AWG ACSR	1,090	-2.00	1.46	Cross-arm damaged at insulator flange. No slippage or conductor damage.
3.4.3	15-kV, 1/0 AWG ACSR	789	-1.54	1.42	Cross-arm damaged at insulator flange. No slippage or conductor damage.
3K.1.1	17-kV, 1/0 AWG ACSR	573	-1.57	1.57	Conductor slippage at clamp. No damage to cross-arm or conductor.
3K.1.2	17-kV, 1/0 AWG ACSR	396	-0.24	0.24	Conductor slippage at clamp. No damage to cross-arm or conductor.
3K.1.3	17-kV, 1/0 AWG ACSR	508	-0.20	0.12	Conductor slippage at clamp. No damage to cross-arm or conductor.
3K.2.1	35-kV, 1/0 AWG ACSR	555	-0.20	0.16	Conductor slippage at clamp. No damage to cross-arm or conductor.
3K.2.2	35-kV, 1/0 AWG ACSR	548	-0.08	0.04	Conductor slippage at clamp. No damage to cross-arm or conductor.
3K.2.3	35-kV, 1/0 AWG ACSR	693	-0.08	0.04	Conductor slippage at clamp. No damage to cross-arm or conductor.

* "East" and "west" refer to downward deflection on the insulator side of the cross-arm and upward deflection at the free end of the cross-arm, respectively. Negative values are toward the floor.

Discussion and Conclusions: System Strength

The major conclusions from the system strength tests are:

- All tested splices on CCs exceeded 100% of the rated conductor strength, and no conductor slippage was observed prior to failure.
- Insulator slip tests showed distinct slip behavior depending on insulator type. Vise-top pin insulators exhibited bending of the insulator pin and lift-out of the conductor from the plastic insert prior to slippage. Clamp-top post insulators showed slippage at significantly lower tensile loads with no damage to the insulator hardware.
- The full-system tree-fall tests all resulted in significant bending/damage to the insulator and cross-arm hardware or insulator slippage well below the rated tensile strength of the tested CC (i.e., no conductor breakage was observed).
- The failure mode of the tree-fall tests also exhibited a dependence on insulator type. Vise-top insulators showed bending of the insulator pin, permanent deflection of the cross-arm, and cracking/splitting of the cross-arm due to impingement of the insulator mounting flange. Clamp-top insulators showed insulator slippage at lower loads with no accompanying damage to the conductor, insulator, or cross-arm. These results are consistent with observations from the insulator slip tests and suggest that while clamp-top insulators have a lower threshold for conductor slippage, they may be less likely to result in damage to the conductor or supporting structure in the event of a tree fall.
- The tree-fall tests were performed under quasi-static loading conditions (approximately 1,000 lb/min). The dynamic loads experienced during a real-world tree-fall event will depend on many factors, including tree height and weight, as well as crown size and density. Although the strain rate sensitivity of the covered conductor system components is not well understood, the system-level behavior and component interactions observed in these tests give valuable insight into the most likely failure modes for individual pole configurations. Further, these results can be used to inform future modeling efforts to analyze specific scenarios and to study the sensitivity to various structural and environmental factors.

Limitations

At the request of SCE, SDG&E, and PG&E, Exponent has investigated the effectiveness of CCs for overhead distribution systems. Exponent investigated specific issues relevant to this technology, as requested by the three utilities. Not all risks have been investigated as part of this work. The scope of services performed during this investigation may not adequately address the needs of other users of this report, and any reuse of this report or its findings, conclusions, or recommendations presented herein is at the sole risk of the user. The opinions and comments formulated during this assessment are based on observations and information available at the time of the investigation. No guarantee or warranty as to future life or performance of any reviewed condition is expressed or implied.

The findings presented herein are made to a reasonable degree of engineering certainty. We have made every effort to accurately and completely investigate all areas of concern identified during our investigation. If new data become available or there are perceived omissions or misstatements in this report regarding any aspect of those conditions, we ask that they be brought to our attention as soon as possible so we have the opportunity to fully address them.

Appendix A

Methods

Appendix A: Methods

One-Line Diagrams

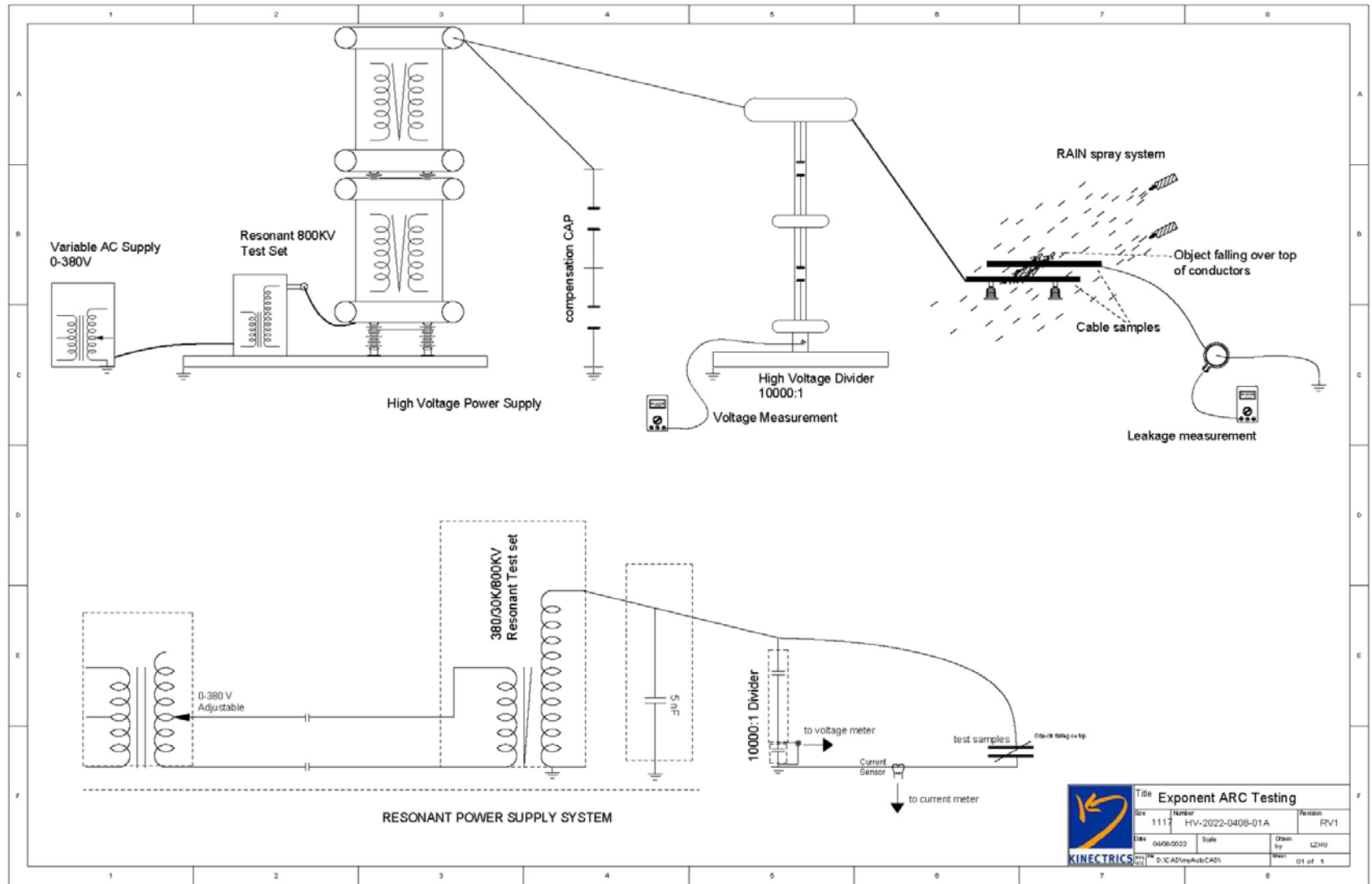

Figure A1. Phase-to-phase contact tests.

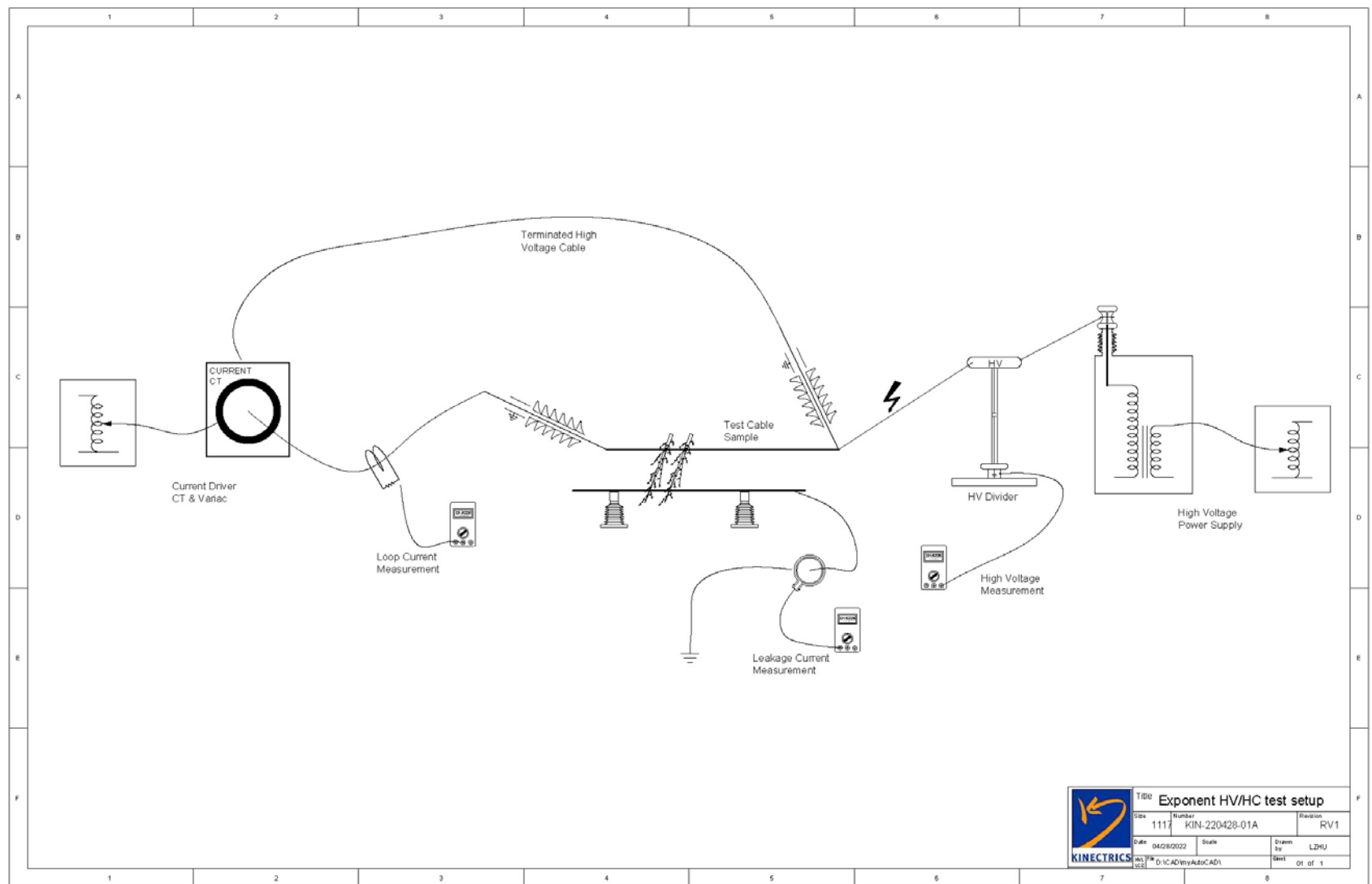

Figure A2. Extended phase-to-phase contact tests.

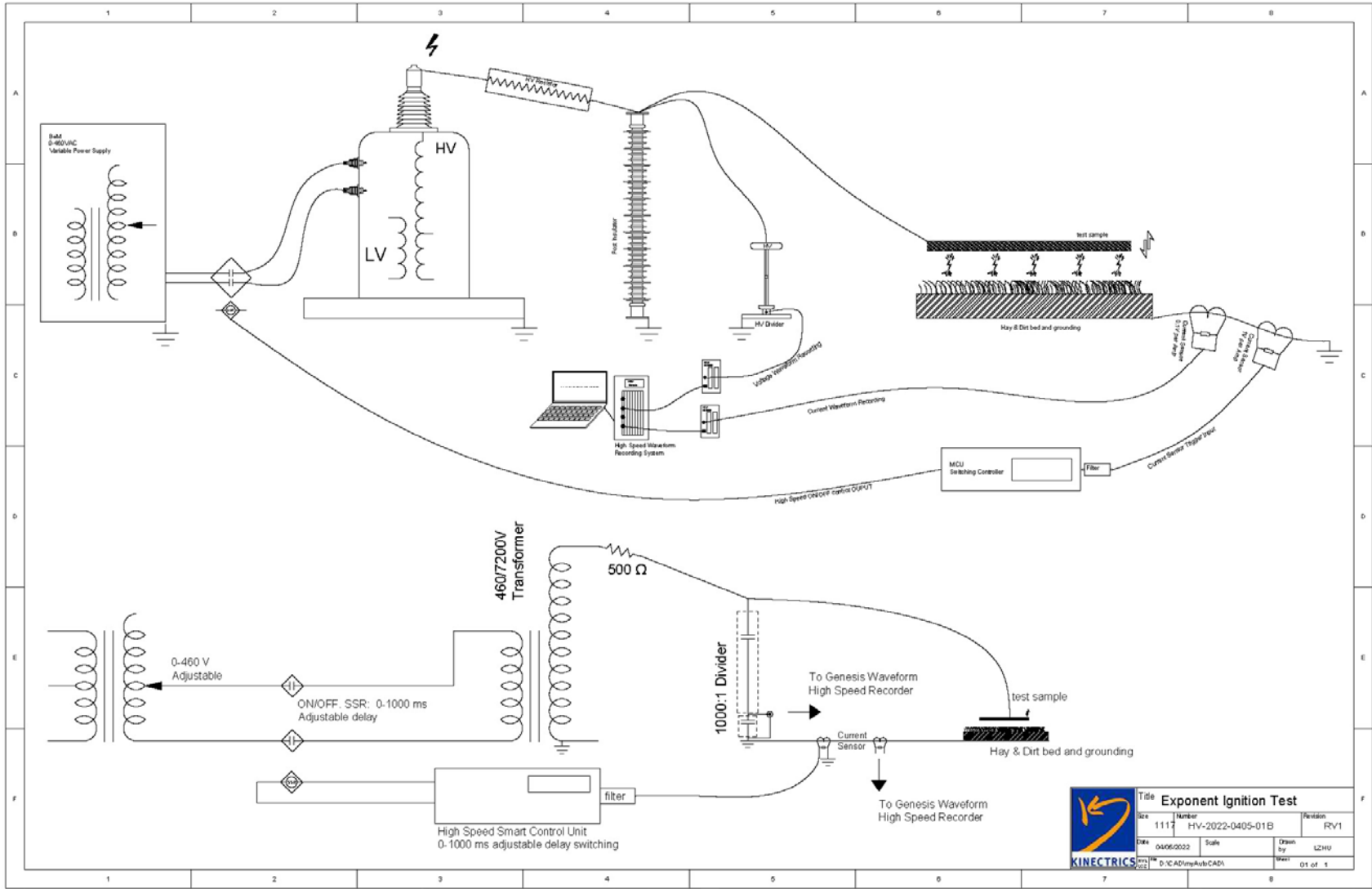

Figure A3. Simulated wire-down tests.

Phase-to-Phase Contact Testing in Wet Conditions



Figure A4. Wet test setup for phase-to-phase contact tests.

Table A1. Precipitation conditions for wet tests met IEEE Standard 4-2013 requirements.

Rain Parameter	Average and Std Dev	IEEE4 Standard
Vertical Rate	1.31 ± 0.20 mm/min	1.0 to 2.0 mm/min
Horizontal Rate	1.47 ± 0.22 mm/min	1.0 to 2.0 mm/min
Water Temperature	19.4 ± 1.2 °C	Ambient ± 15 °C
Water Conductivity	102.0 ± 4.5 μ S/cm	100 ± 15 μ S/cm

Vegetation, Branch Preparation, and Quality Control

Three mature eucalyptus cinerea trees were sourced from Gilroy, California, and were consistently watered with 12 gallons of water per day to maintain their freshness and moisture. Branches were cut into 4.5-foot sections and labeled according to their original position on the tree. Diameter and moisture measurements were made at the cut end and center of each branch. Branch diameters varied from 0.4 inches to 2.28 inches and averaged 1.15 inches.

Immediately after sectioning, the cut ends were painted with Anchor Seal, a water-based emulsion wax sealer used to prevent moisture loss from freshly cut wood. The painted end was then wrapped with industrial plastic wrap and secured with a rubber band. The prepped branches were placed in 100 gallon / 6 mil thick plastic bags. Two 84% relative humidity (RH) humidifier seasoning packets were placed in each bag for humidity control. The air inside was fully evacuated with a vacuum, and the plastic bags were sealed shut with a heat gun. The prepped and sealed branches were placed in a wooden crate and shipped to the high-voltage testing facility. Moisture measurements were repeated upon receipt at the testing lab to ensure that the moisture content of each branch was consistent with live vegetation.



Figure A5. Cutting and preparation of leafy eucalyptus branches for phase-to-phase arc testing.

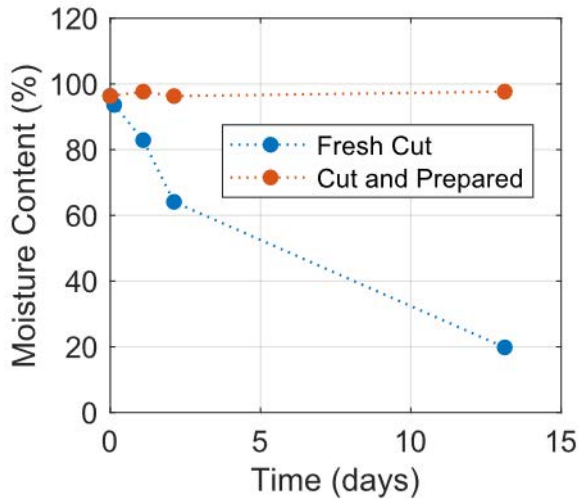

Figure A6. Moisture content as a function of time for a fresh-cut branch and a cut and prepared branch. The fresh-cut branch was exposed to atmosphere and lost 80% of its moisture over 14 days. The prepared branch retained its moisture over 14 days. Moisture meter readings were quantified by comparing to the oven-dry mass.

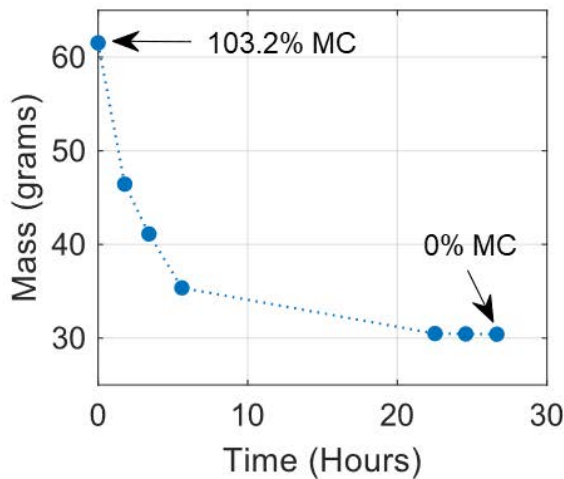

Figure A7. Mass of a fresh-cut branch as a function of time during heating in convection oven at 104° C to oven-dry condition, consistent with ASTM D4442-20.

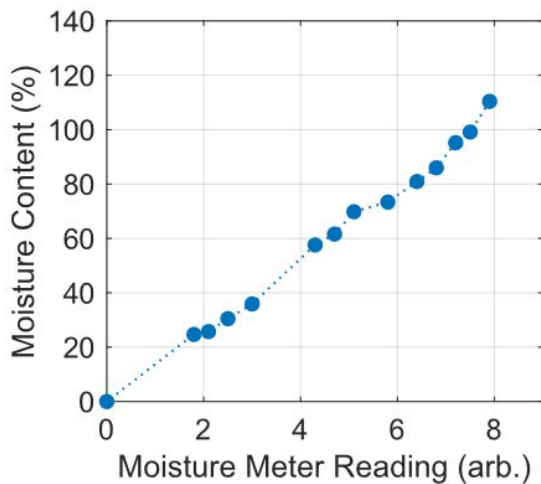

Figure A8. Method for quantifying moisture meter readings and converting to moisture content. The ASTM D4442-20 method of oven-dry mass was used. A fresh branch was cut and weighed, and its moisture content was measured with the moisture meter. The branch was allowed to dry in atmosphere over time. The mass and moisture meter readings were measured over time, until the mass of the branch was constant, indicating that the oven-dry mass was reached. Moisture meter readings above 5 (MC \approx 60%) were considered to be valid for phase-to-phase contact tests.

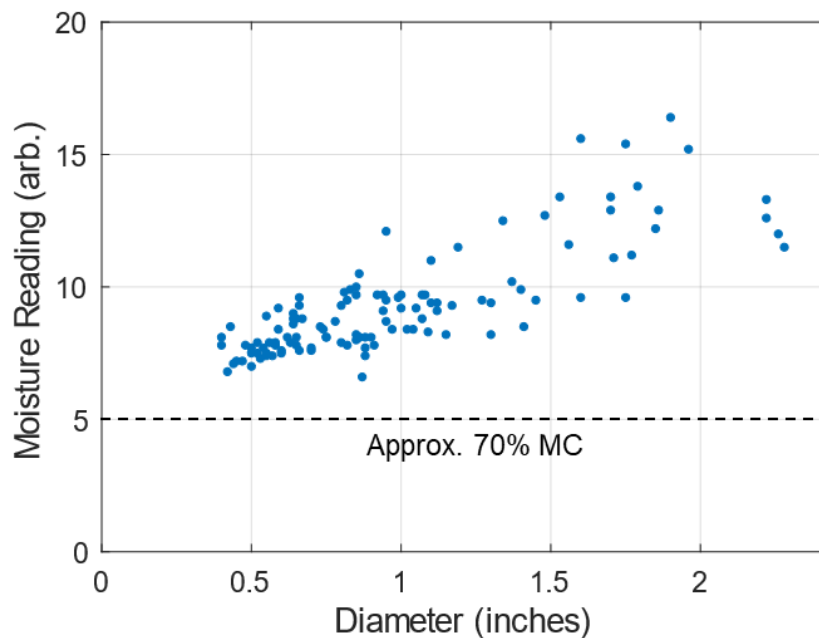

Figure A9. Leafy eucalyptus branch moisture content as a function of branch diameter. As branch diameter increases, moisture content trends upward.

Cyclic Polarization Sample Preparation

To prepare the samples for cyclic polarization testing, CCs and bare conductors were cut into ~4 inch pieces and the polymer sheath was removed from ~2.5 inches of one end of each of the CC samples. Electrical connection was made to each sample using a conductive silver epoxy. Silicone sealant was used to mask the silver epoxy connection and seal over both ends of the conductor. For bare conductors, silicone was applied along an additional length of conductor near the ends to achieve a similar exposed surface area to the exposed surface area of the CCs. Additional control samples were prepared in a similar manner using individual strands of disassembled bare conductors. The strands were polished prior to making electrical connection to minimize any surface scratches or defects to elucidate the electrochemical response of the conductor material without any geometry effects (i.e., without crevices). Figure A10 presents representative images of CCs and bare conductors prepared for cyclic polarization testing. For bare conductors, the length of exposed conductor (i.e., not covered with silicone sealant) for each sample was measured three times and averaged. The exposed conductor surface area of each sample was calculated using the average measured length and assuming the exposed area to be a cylinder. For CCs, because corrosion was observed beneath the polymer sheath, the entire length of the conductor was assumed to be active, but the calculation was otherwise the same. Due to the stranded nature of the conductors, the actual exposed surface areas are somewhat higher than the calculated values. Thus, the reported current densities (current per unit area) should be considered upper bounds. However, as the strand geometries of the CCs should be identical to their bare counterparts, relative comparisons of corrosion susceptibility between bare and CCs can be made.

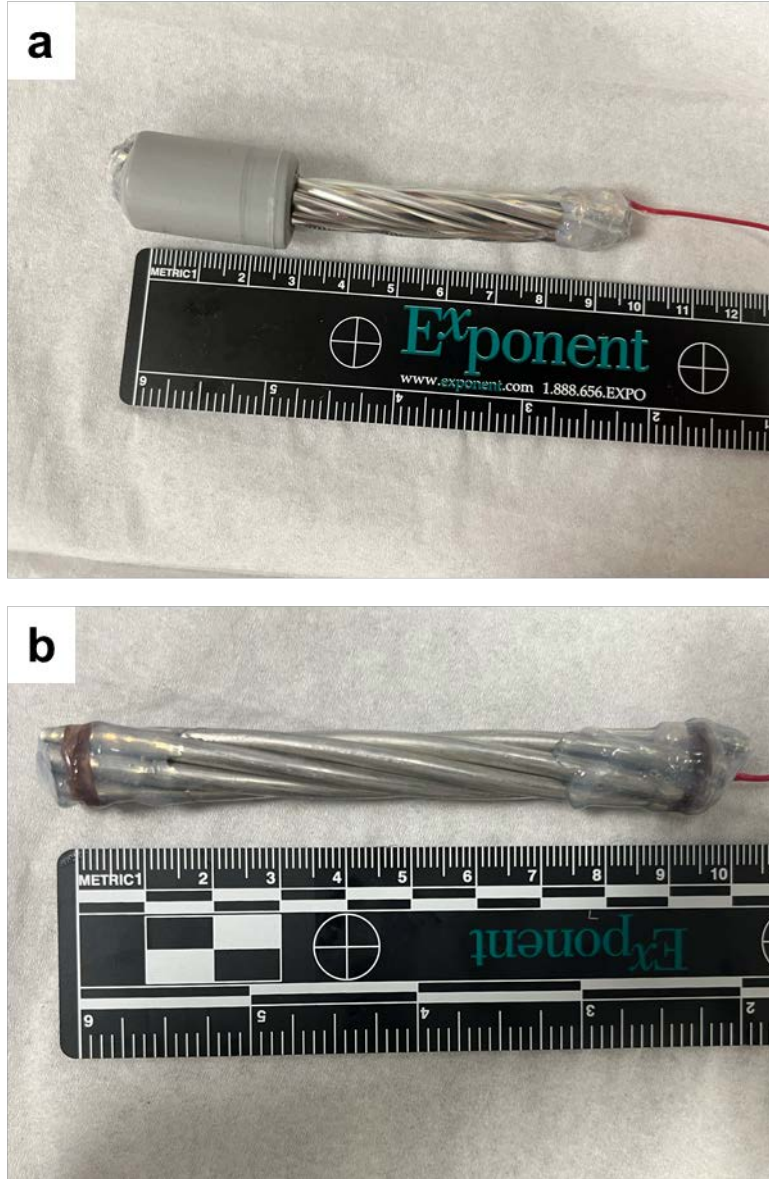

Figure A10. Representative photographs showing (a) CC and (b) bare conductor samples prepared for cyclic polarization testing. Electrical contact was made to one end of the conductor with conductive silver epoxy. The electrical connection and the other exposed end of the conductor were masked with silicone sealant.

Appendix B

Simulated Wire-Down Tests: Additional Figures

Appendix B: Simulated Wire-Down Tests: Additional Figures

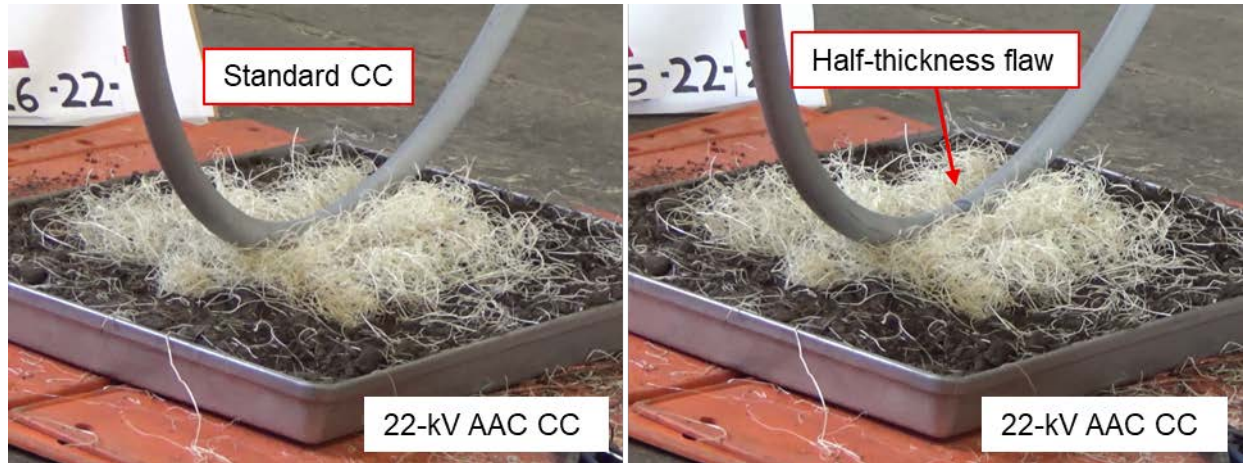

Figure B1. (Left) Simulated wire-down test of a 22-kV AAC CC. No ignition was observed after three tests. (Right) Simulated wire-down test of a 22-kV AAC CC with a half-thickness flaw. No ignition was observed after three tests.



Figure B2. Simulated wire-down test of a bare AAC demonstrating the potential for ignition of the dry brush.

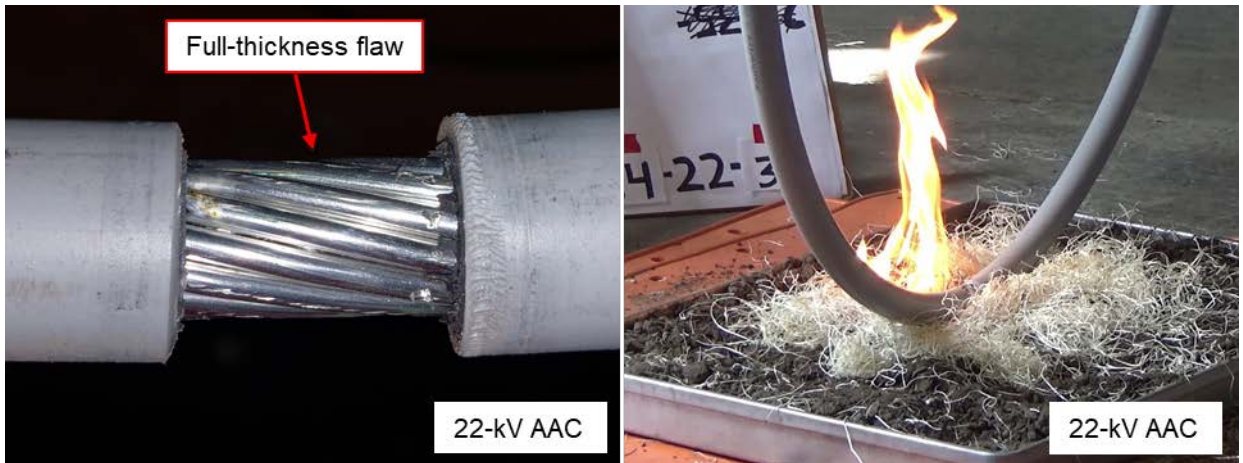

Figure B3. Simulated wire-down test of a 22-kV AAC CC with a full-thickness flaw demonstrating the potential for ignition of the dry brush.



Figure B4. Simulated wire-down test of a 22-kV AAC CC with a broken end demonstrating the potential for ignition of the dry brush.



Figure B5. (Left) Simulated wire-down test of a 15-kV ACSR CC. No ignition was observed after three tests. (Right) Simulated wire-down test of a 15-kV ACSR CC with a half-thickness flaw. No ignition was observed after three tests.

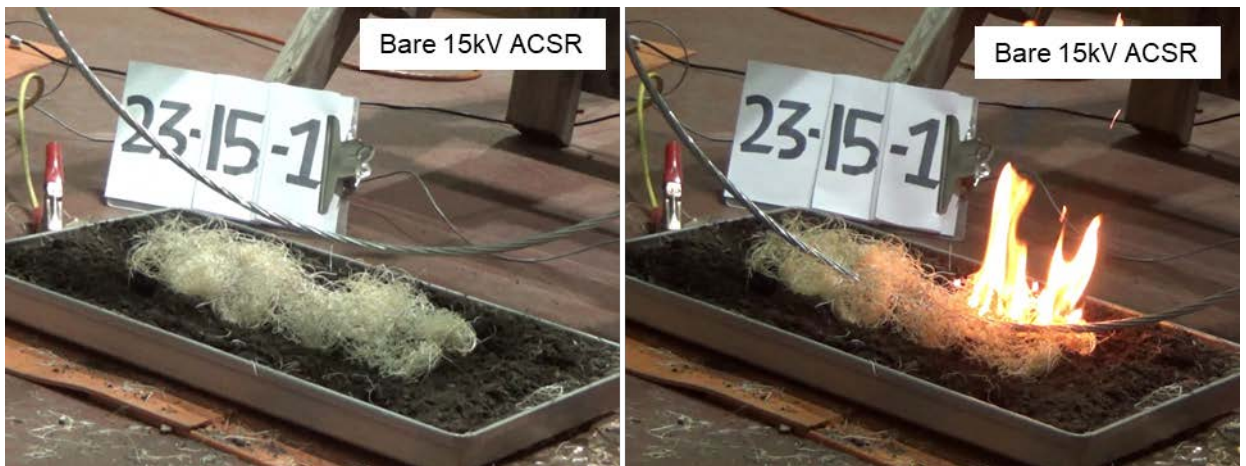

Figure B6. Simulated wire-down test of a bare 15-kV ACSR conductor demonstrating the potential for ignition of the dry brush.

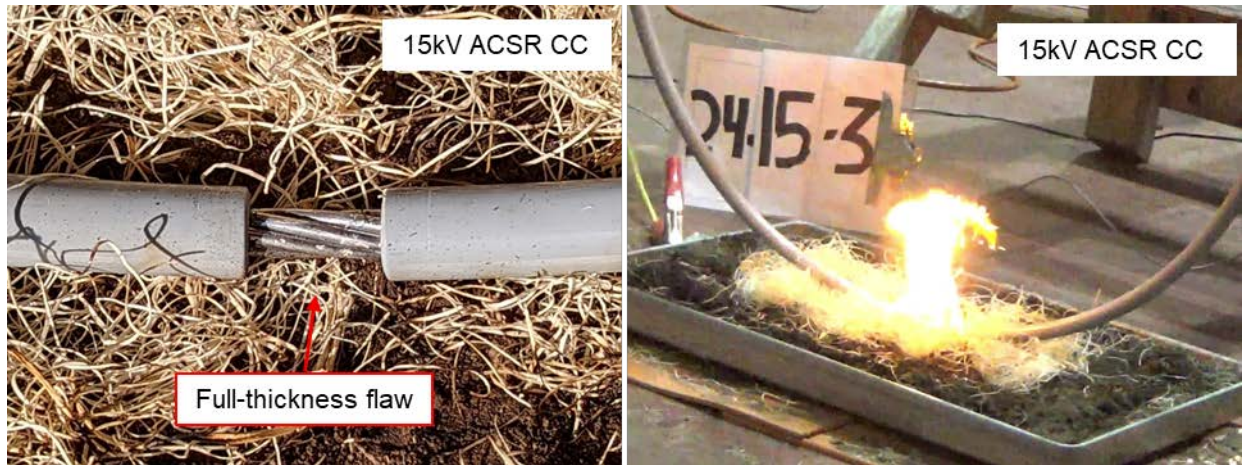

Figure B7. Simulated wire-down test of a 15-kV ACSR CC with a full-thickness flaw demonstrating the potential for ignition of the dry brush.

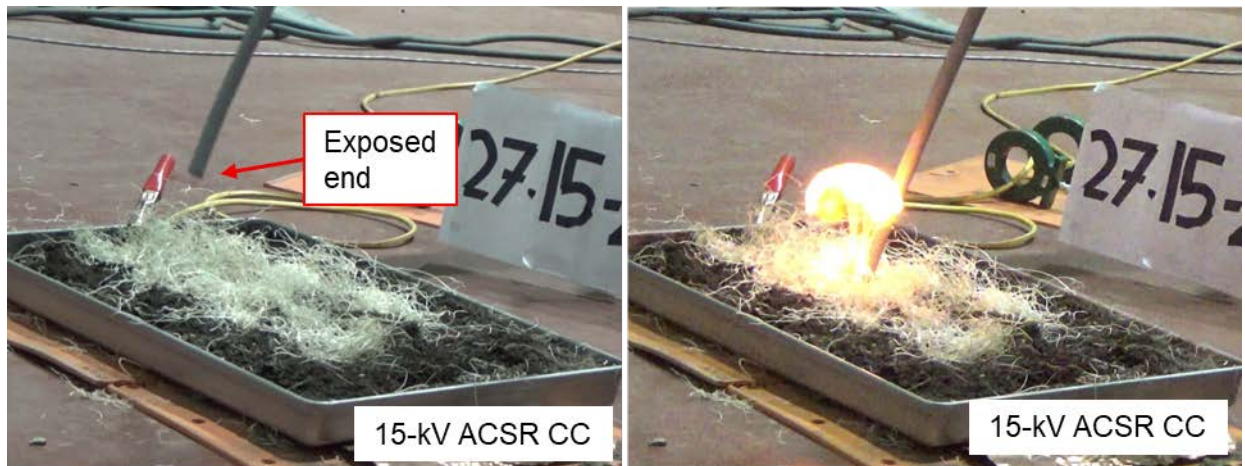

Figure B8. Simulated wire-down test of a 15-kV ACSR CC with a broken end demonstrating the potential for ignition of the dry brush.

Appendix C

Standards and Guidelines

Appendix C: Standards and Guidelines

Standards and Guidelines are listed with the footnote number of their first appearance.

3. California Public Utilities Commission (CPUC) General Order (GO) 95. Section III. Requirements for All Lines.
5. Southern California Edison Covered Conductor Data Sheet for 17-kV and 35 kV. 2020.
10. IEEE Std. 4TM-2013 “IEEE Standard for High Voltage Testing Techniques,” Institute of Electrical and Electronics Engineers, 2013.
20. ICEA T-31-610-2018 “Test Method for Conducting Longitudinal Water Penetration Resistance Tests on Blocked Conductors,” Insulated Cable Engineers Association, 2018.
21. ASTM G85-19 “Standard Practice for Modified Salt Spray (Fog) Testing,” American Society for Testing and Materials, 2019.
26. STM G5-14 “Standard Reference Test Method for Making Potentiodynamic Anodic Polarization Measurements,” American Society for Testing and Materials, 2014.
27. ASTM E1354-17 “Standard Test Method for Heat and Visible Smoke Release Rates for Materials and Products Using an Oxygen Consumption Calorimeter,” American Society for Testing and Materials, 2017
33. ANSI C119.4-2016, “American National Standard for Electric Connectors – Connectors for Use Between Aluminum-to-Aluminum and Aluminum-to-Copper Conductors Designed for Normal Operation at or Below 93C,” Clause 6.2.2.2 (Maximum Load).
34. ANSI C119.0-2015, “American National Standard for Electric Connectors – Testing Methods and Equipment Common to the ANSI C119 Family of Standards.”

Appendix D

Literature References

Appendix D: Literature References

Literature references are listed with the footnote number of their first appearance.

6. McBride, J.R. (2014) The History, Ecology and Future of Eucalyptus Plantations in the Bay Area: A lecture at the Commonwealth Club of San Francisco Understanding Eucalyptus in the Bay Area. San Francisco Forest Alliance.
7. Nance, A. (2014). The Plight of the Eucalyptus Trees in San Francisco: A Case Study on the Values and Considerations Involved in a Decision that Requires Comparative Valuation of Species. *Hastings W.-Nw. J. Env't'l L. & Pol'y*, 20, 429.
8. Dickinson, K. J. M., and J. B. Kirkpatrick. 1985. The flammability and energy content of some important plant species and fuel components in the forests of southeastern Tasmania. *Journal of Biogeography* 12:121-134.
9. Yousefpour, K. "Effect of Ambient Conditions on Insulation Strength of High Voltage Protection Devices." HAL Open Science. 2020.
12. Goodfellow and Appelt. "How Trees Cause Outages." Environmental Consultants, Inc.
15. Marxsen, T. "Powerline Bushfire Safety Program, Vegetation Conduction Ignition Test Report-Final." 2015.
16. R. Storie and W. Weir. "Generalized Soil Map of California." California Agricultural Experiment Station Extension Service.
18. Tony Marxsen. "Ignition Tests – lo-sag conductor." Powerline Bushfire Safety Program. 2015.
24. Refsnæs, S., Magnusson N., Ulleberg T. "Laboratory corrosion tests on overhead line conductors with bird protection systems," *Int. Trans. Electr. Energ. Syst.* 24(2014): 1185.
25. Lequien, F., et al. "Characterization of an aluminum conductor steel reinforced (ACSR) after 60 years of operation." *Engineering Failure Analysis* 120 (2021): 105039.28. Butler, B., et al. "Measurements of radiant emissive power and temperatures in crown fires." *Canadian Journal of Forest Research* (2004): 1577-1587.
29. Morandini, F., et al. "Fire spread experiment across Mediterranean shrub: Influence of wind on flame front properties." *Fire Safety Journal* 41 (2006) 229-235.
30. Silvani, X., and Morandini, F. "Fire spread experiments in the field: Temperature and heat fluxes measurements." *Fire Safety Journal* 44 (2009) 279-285.
31. Frankman, D., et al. "Measurements of convective and radiative heating in wildland fires." *International Journal of Wildland Fire* 22.2 (2013): 157-167.

Appendix E

SCE Covered Conductor Dead-End Strength Testing

Appendix E: SCE Covered Conductor Dead-End Strength Testing

Scope

Mechanical strength testing of covered conductor dead-end assemblies provided by SCE was performed to understand the failure behavior of a typical dead-end configuration. This testing was intended to simulate the response of a full dead-end “system” (i.e., cross-arm, insulator, dead-end clamp, and CC) if a tree were to fall into a span. Both load and failure behavior were recorded.

Experimental Setup

Test Setup and Equipment

Tests were performed using a total of seven conductor/dead-end clamp combinations provided by SCE, as shown in Table E1. Dead-end suspension insulators and composite cross-arms, also provided by SCE, were held constant for all tests. The cross-arm assemblies were mounted with standard hardware to simulate a realistic distribution pole configuration. Initial testing using a wood pole stub resulted in failure of the pole itself as the mounting plate tilted and impinged on the pole (see results section for more details). This failure mode is thought to be unique to the test setup, as the available pole was old, dry, and had been drilled many times, compromising its integrity. A steel plate fixture was substituted for the pole to eliminate this issue in subsequent tests.

Table E1. Conductor and hardware combinations used for dead-end testing.

Sample ID	Conductor	Conductor RTS (lb)*	Dead-End	Insulator	Cross-Arm
1	#2 CU (7 HDCU)	2,898	Type A	15 kV DE suspension	10 ft
2	2/0 CU (19 HDCU)	5,634	Type A	15 kV DE suspension	10 ft
3	4/0 CU (19 HDCU)	8,702	Type A	15 kV DE suspension	10 ft
4	1/0 ACSR (6/1)	4,160	Type A	15 kV DE suspension	10 ft
5	336.4 kcmil ACSR (18/1)	8,246	Type B	15 kV DE suspension	10 ft
6	336.4 kcmil ACSR (30/7)	16,435	Type C	15 kV DE suspension	10 ft
7	653.9 kcmil ACSR (18/3)	14,060	Type D	15 kV DE suspension	10 ft

* Conductor rated tensile strength (RTS) values were obtained from SCE Specification MS-0511-2020 Rev. 1.

The tests were performed in a hydraulic horizontal test machine, and matching dead-ends were used to terminate the free ends of the conductor. A pulley system was implemented to induce a vertical loading component at the cross-arm, and a load cell was attached to the pulley adjacent to the cross-arm to measure vertical loads. The deflection angles of the conductor on either side of the pulley were dependent on the test configuration and are reported in the results table below (Table E2). A schematic diagram and representative photo of the test setup are shown in Figure E1 and Figure E2, respectively.

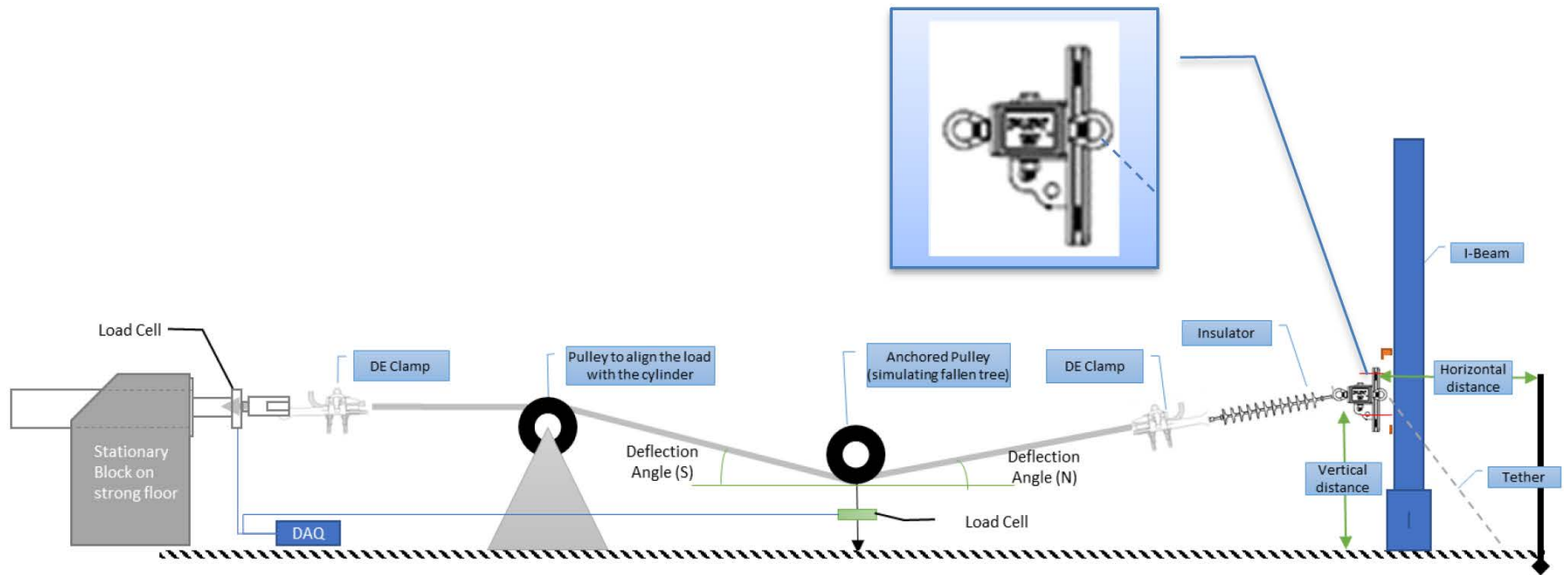

Figure E1. Schematic diagram of the dead-end tree fall test. The hydraulic actuator is located on the south end (left), and the cross-arm is located on the north end (right).

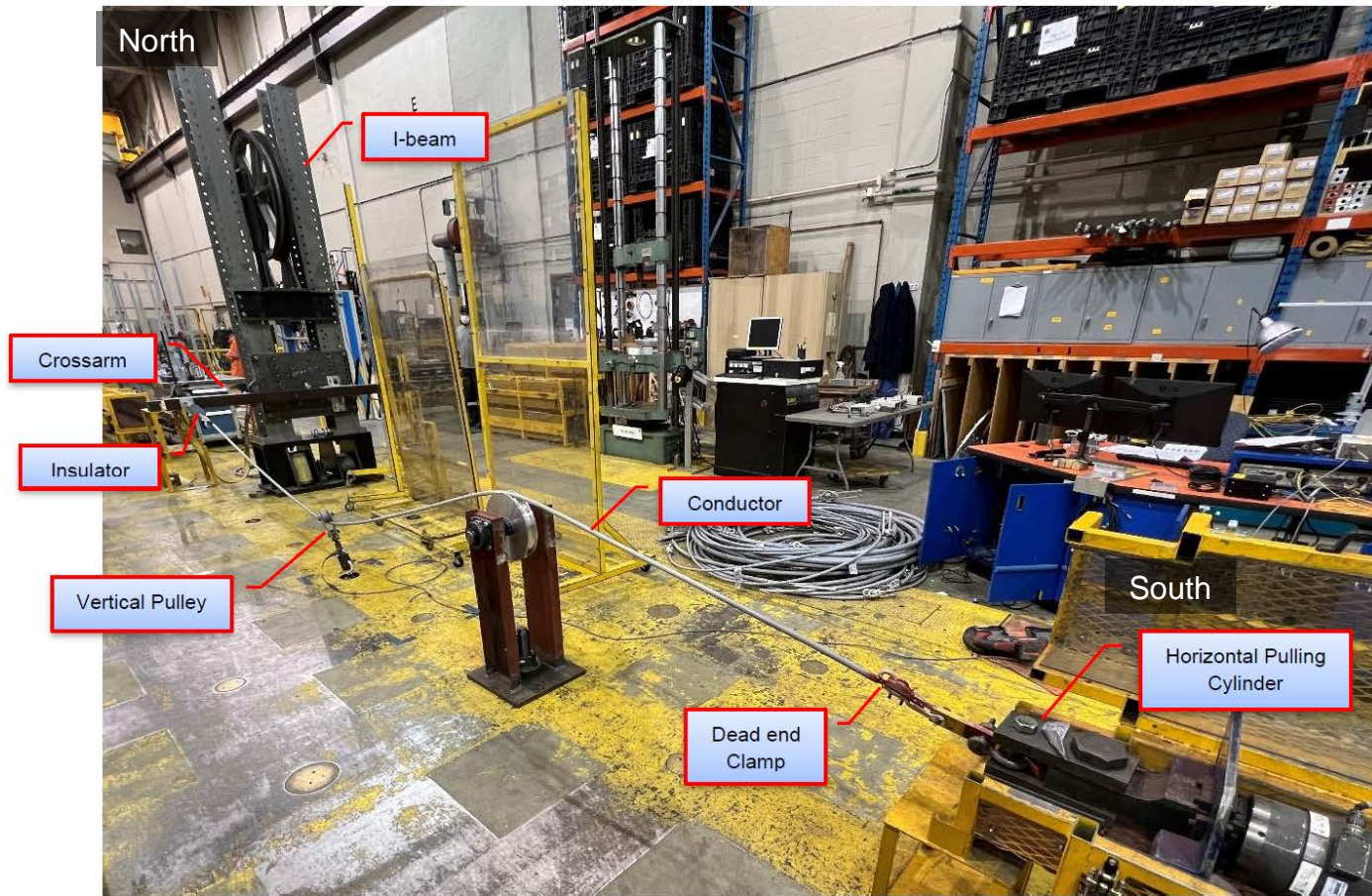

Figure E2. A representative photo of the dead-end tree fall test.

Testing Procedure

The test system including conductor, dead-end clamp, insulator, and cross-arm is shown in Figure E2. A small pre-tension was applied to remove the slack from the conductor, and the conductor was marked at the dead-end clamp entry points to monitor for slippage. The horizontal load was continuously increased at a rate of 1,000 lb/min until failure occurred. Vertical loads at the hydraulic cylinder and at the pulley attached to the floor were monitored throughout the test.

Results

Tabulated results of the dead-end tree-fall tests are presented in Table E2. For smaller size conductors (#2 Cu, 2/0 CU, 4/0 Cu, and 1/0 ACSR), failure occurred as a result of the conductor slipping out of the dead-end clamp (see Figure E3). For conductors with higher RTS (336.4 kcmil and 653.9 kcmil ACSRs), the typical failure point was the cross-arm. The failure of the cross-arm started at the bolts connecting the cross-arm to the mounting plate (see Figure E4). Deformation of the cross-arm mounting plate occurred in all instances, regardless of final failure mode. A representative image of the mounting plate deformation is shown in Figure E5. The deformation behavior of the mounting plate was likely influenced by the rigid fixturing method employed here; a standard wood pole may reduce the magnitude of the plate deformation. Complete test details, including load versus time plots and photos, can be found in Appendix F.

Table E2. Results of dead-end tree-fall tests.

Sample #	Conductor	Dead-End Hardware	Max. Vertical Load	Deflection Angle*		Observations
			(lb)	South (°)	North (°)	
1.1	#2 CU	Type A	1443	15.1	12.4	Conductor broke at south* dead-end; deformed cross-arm mounting plate.
1.2	#2 CU		1365	15.3	11.9	Conductor pulled out of south* dead-end; deformed cross-arm mounting plate.
1.3	#2 CU		1352	15.7	12.2	Conductor pulled out of south* dead-end; deformed cross-arm mounting plate.
2.1	2/0 CU		567	16.3	15.0	Conductor pulled out of north* dead-end; deformed cross-arm mounting plate.
2.2	2/0 CU		767	16.0	14.6	Conductor pulled out of south* dead-end; deformed cross-arm mounting plate.
2.3	2/0 CU		1375	16.9	16.8	Conductor pulled out of south* dead-end; deformed cross-arm mounting plate.
3.1	4/0 CU		693	17.0	12.3	Conductor pulled out of north* dead-end; deformed cross-arm mounting plate.
3.2	4/0 CU		1503	15.9	11.4	Conductor pulled out of south* dead-end; deformed cross-arm mounting plate.
3.3	4/0 CU		1509	17.0	16.0	Conductor pulled out of south* dead-end; deformed cross-arm mounting plate.
4.1	1/0 ACSR (6/1)		1776	15.8	13.5	Cross-arm fractured at center bolt. No conductor slippage at clamp.
4.2	1/0 ACSR (6/1)		1410	15.5	13.4	Conductor pulled out of north* dead-end; deformed cross-arm mounting plate.
4.3	1/0 ACSR (6/1)		1418	16.8	15.6	Conductor pulled out of south* dead-end; deformed cross-arm mounting plate.
5.1	336.4 kcmil ACSR (18/1)		Type B	1739	14.5	16.4
5.2	336.4 kcmil ACSR (18/1)	1771		16.5	12.3	Complete cross-arm failure. No conductor slippage at clamp.
5.3	336.4 kcmil ACSR (18/1)	1720		16.6	12.6	Complete cross-arm failure. No conductor slippage at clamp.
6.1	336.4 kcmil ACSR (30/7)	Type C	1628	16.1	13.2	Complete cross-arm failure. No conductor slippage at clamp.
6.2	336.4 kcmil ACSR (30/7)		1831	15.9	12.4	Complete cross-arm failure. No conductor slippage at clamp.
6.3	336.4 kcmil ACSR (30/7)		1786	16.2	12.0	Complete cross-arm failure. No conductor slippage at clamp.
7.1	653.9 kcmil ACSR (18/3)	Type D	2130	17.1	17.3	Complete cross-arm failure. No conductor slippage at clamp.
7.2	653.9 kcmil ACSR (18/3)		1973	17.2	14.6	Complete cross-arm failure. No conductor slippage at clamp.
7.3	653.9 kcmil ACSR (18/3)		1858	17.3	13.2	Complete cross-arm failure. No conductor slippage at clamp.

* North dead-end was attached to the insulator and cross-arm. South dead-end was attached to the hydraulic actuator.



Figure E3. A representative post-test image showing pull-out of the conductor at the dead-end clamp attached to the insulator (north end). 2/0 CU with Type A dead-end shown.



Figure E4. A representative post-test image showing splitting and failure of the composite cross-arm. 336.4 kcmil ACSR (30/7) with Type C dead-end shown.



Figure E5. A representative post-test image showing typical deformation of the cross-arm mounting plate.

Discussion and Conclusions: System Strength

The major conclusions from the system strength tests are:

- For smaller size conductors (#2 Cu, 2/0 CU, 4/0 Cu, and 1/0 ACSR), failure occurred as a result of the conductor slipping out of the dead-end clamp.
- For conductors with higher RTS (336.4 kcmil and 653.9 kcmil ACSRs), the typical failure point was the cross-arm. The failure of the cross-arm started at the bolts attaching the cross-arm to the mounting plate.
- Deformation of the cross-arm mounting plate occurred in all instances, regardless of final failure mode. The deformation behavior of the mounting plate was likely influenced by the rigid fixturing method employed in this testing; a standard wood pole may reduce the magnitude of the plate deformation.
- The tree-fall tests were performed under quasi-static loading conditions (approximately 1,000 lb/min). The dynamic loads experienced during a real-world tree-fall event will depend on many factors, including tree height and weight, as well as crown size and density. Although the strain rate sensitivity of the covered conductor system components is not well understood, the system-level behavior and component interactions observed in these tests give valuable insight into the most likely failure modes for individual pole configurations. Further, these results can be used to inform future modeling efforts to analyze specific scenarios and to study the sensitivity to various structural and environmental factors.

Appendix F

Kinectrics Mechanical Testing Reports



NOTE: Component manufacturer information has been redacted from this report.

MECHANICAL TESTING OF SPLICE CONNECTORS AND PIN INSULATOR CLAMPS FOR 1/0 AWG ACSR AND 397.5 KCMIL AAC COVERED CONDUCTORS

K-580740-RP-001 R00

Prepared for

Exponent

Purchase Order No. 00062928

<p>Prepared by</p> <p> Digitally signed by GORJA Genti Date: 2022.10.03 14:22:57 -04'00'</p> <p><i>Signature & Date</i></p> <p>Genti Gorja P.Eng. Principal Engineer Line Asset Management</p>	<p>Reviewed by</p> <p> Digitally signed by André Maurice Date: 2022.10.03 14:29:28 -04'00'</p> <p><i>Signature & Date</i></p> <p>André Maurice Service Line Manager Line Asset Management</p>	<p>Approved by</p> <p>PETER Zsolt  Digitally signed by PETER Zsolt Date: 2022.10.03 14:53:20 -04'00'</p> <p><i>Signature & Date</i></p> <p>Zsolt Peter Ph.D. Business Area Director Line Asset Management</p>
---	--	---

Revision History

Rev 00	Description: Original issue			
	Issue Date: 2022-09-28	Prepared by: Genti Gorja	Reviewed by: André Maurice	Approved by: Zsolt Peter

DISCLAIMER

Kinectrics prepared this report as a work of authorship sponsored by their client. This report has been prepared solely for the benefit of the Client and may not be used or relied upon in whole or in part by any other person or entity without Client permission or without Kinectrics' permission if required by the Contract between Client and Kinectrics Inc . Neither Kinectrics, their client nor any person acting on behalf of them: (a) makes any warranty or representation whatsoever, express or implied, or assumes any legal liability of responsibility for any third party's use, or the results of such use, with respect to (i) the use of any information, apparatus, method, process, or similar item disclosed in this report including the merchantability or fitness for any particular purpose of any information contained in this report or the respective works or services supplied or performed or (ii) that such use does not infringe on or interfere with privately owned rights, including any party's intellectual property; or (b) assumes responsibility for any damages or other liability whatsoever (including any consequential damages resulting from a third party's selection or use of this report or any information, apparatus, method, process, or similar item disclosed.

Copyright © Kinectrics Inc. 2022. All rights reserved.



Table of Contents

1	Executive Summary	4
2	Test Objective and Test Standard	5
3	Test Sample.....	5
3.1	Test Conductor	6
3.2	Test Connectors and Installation Procedure.....	7
4	Test Setup	8
5	Test Procedure	10
6	Test Results.....	10
7	Acceptance Criteria.....	20
8	Conclusion	20
Appendix A	Acronyms and Abbreviations	21
Appendix B	Product Specification of Splices	22
Appendix C	Conductor Data Sheet (<i>as provided by Exponent</i>).....	28
Appendix D	Instrument Sheet.....	30
Appendix E	Kinectrics ISO 9001 Certificate of Registration	31
Appendix F	Distribution	32

1 Executive Summary

This report describes the mechanical test program conducted for Exponent™ to evaluate the performance of splice connectors designed to be used with 15 kV 1/0 AWG ACSR covered conductor, 17 kV 1/0 AWG ACSR covered conductor, 35 kV 1/0 AWG ACSR covered conductor and 22 kV 397.5 kcmil AAC covered conductor.

The test were conducted in accordance with client’s requirements as outlined in the relevant sections of this document. The test program and completion dates are summarized in Table 1-1.

Table 1-1: Test Program

Test ID	Sample ID	Conductor	Splice	Date Completed	
Maximum Load Test on the Splice	1.1	1.1.1	17 kV 1/0 AWG ACSR	██████████	June 2, 2022
		1.1.2	17 kV 1/0 AWG ACSR	██████████	June 3, 2022
		1.1.3	17 kV 1/0 AWG ACSR	██████████	June 2, 2022
	1.2	1.2.1	35 kV 1/0 AWG ACSR	██████████	May 19, 2022
		1.2.2	35 kV 1/0 AWG ACSR	██████████	May 26, 2022
		1.2.3	35 kV 1/0 AWG ACSR	██████████	June 3, 2022
	1.3	1.3.1	22 kV 397.5 kcmil AAC	██████████	May 16, 2022
		1.3.2	22 kV 397.5 kcmil AAC	██████████	May 18, 2022
		1.3.3	22 kV 397.5 kcmil AAC	██████████	May 18, 2022
	1.4	1.4.1	15 kV 1/0 AWG ACSR	██████████	August 26, 2022
		1.4.2	15 kV 1/0 AWG ACSR	██████████	August 26, 2022
		1.4.3	15 kV 1/0 AWG ACSR	██████████	August 26, 2022

Exponent supplied samples and accessories required for testing. Kinectrics received all connectors and conductor assemblies, in good condition, on May 2, 2022.

Except for installation of ██████████, which was supplied pre-installed on conductor, the installation of the splice connectors on conductor and the test setup were performed by Kinectrics personnel.

The tests were performed by Kinectrics personnel at 800 Kipling Avenue, Toronto, Ontario, M8Z 5G5, Canada. The work was conducted under Exponent Purchase Order No. 00062928 dated January 14, 2022.

The tests were performed under Kinectrics’ ISO 9001 Quality Management System. A copy of ISO 9001 Certificate of Registration is included in Appendix E.

2 Test Objective and Test Standard

A Maximum Load Test was performed to verify the tensile strength of the connector/conductor assembly. The test was performed in general accordance with the procedures outlined in the following standards:

ANSI C119.4-2016, “*American National Standard for Electric Connectors – Connectors for Use Between Aluminum-to-Aluminum and Aluminum-to-Copper Conductors Designed for Normal Operation at or Below 93°C and Copper-to-Copper Conductors Designed for Normal Operation at or Below 100°C*”, Clause 6.2.2.2 (Maximum Load)

ANSI C119.0-2015, “*American National Standard for Electric Connectors – Testing Methods and Equipment Common to the ANSI C119 Family of Standards*”.

A five (5) minute hold at 60% of conductor’s Rated Tensile Strength (RTS) was introduced during the loading sequence to evaluate the performance of connectors under sustained (design) load.

3 Test Sample

A total of twelve (12) samples were tested. All test samples consisted of two (2) lengths of covered conductor, joined by a splice and terminated with epoxy dead-end or bolted dead-end clamp at the free ends of the conductor.

A schematic of a typical test sample is shown in Figure 3-1 and a summary of the test samples configuration is shown Table 3-1.

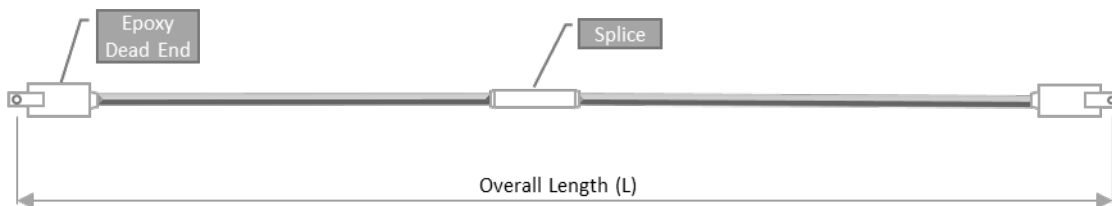

Figure 3-1: Schematic of Typical Test Sample for Maximum Load Test

Table 3-1: Test Sample Configuration

Sample No.	Connector Identification		Conductor Size (AWG or kcmil)	Overall Length [ft]
	Dead-end	Splice		
1.1.1	Epoxy Resin	██████████	17 kV, 1/0 AWG ACSR	44
1.1.2	Epoxy Resin	██████████	17 kV 1/0 AWG ACSR	44
1.1.3	Epoxy Resin	██████████	17 kV 1/0 AWG ACSR	44
1.2.1	Epoxy Resin	██████████	35 kV 1/0 AWG ACSR	44
1.2.2	Epoxy Resin	██████████	35 kV 1/0 AWG ACSR	44
1.2.3	Epoxy Resin	██████████	35 kV 1/0 AWG ACSR	44
1.3.1	Epoxy Resin	██████████	22 kV 397.5 kcmil AAC	44
1.3.2	Epoxy Resin	██████████	22 kV 397.5 kcmil AAC	44
1.3.3	Epoxy Resin	██████████	22 kV 397.5 kcmil AAC	44
1.4.1	Bolted Clamp ASO 398	██████████	15 kV, 1/0 AWG ACSR	12
1.4.2	Bolted Clamp ASO 398	██████████	15 kV 1/0 AWG ACSR	12
1.4.3	Bolted Clamp ASO 398	██████████	15 kV 1/0 AWG ACSR	12

3.1 Test Conductor

All test conductors used to prepare the test samples, comprised of a concentrically stranded conductor (1/0 AWG ACSR or 397.5 kcmil AAC) covered with a thin semi-conducting layer, a crosslinked low-density polyethylene (XL-LDPE) inner layer and a high-density XL-HDPE outer layer (see Figure 3-2).

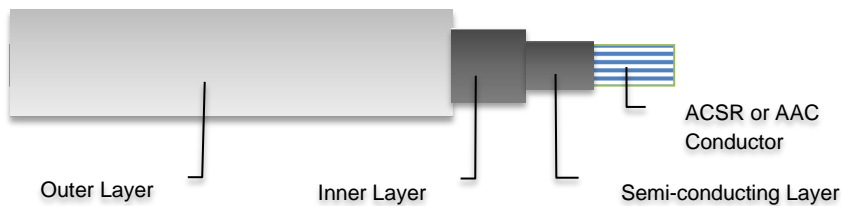

Figure 3-2: Schematic of Covered Conductor

The main conductor properties, as provided by Exponent, are shown in Table 3-2. See Appendix C for complete conductor data sheets.

Table 3-2: Test Conductor Main Characteristics

Conductor Description	Conductor Diameter [in]	Covering Thickness [mils]			Maximum Overall Diameter [in]	RTS [lb]
		Semi-conducting Layer	Inner Layer	Outer Layer		
██████ - 15 kV 1/0 AWG, 6/1 st. ACSR covered conductor	0.398	15	75	75	0.748	4,160
██████ - 17 kV 1/0 AWG, 6/1 st. ACSR covered conductor	0.398	15 - 25	75	75	0.748	4,160
██████ - 35 kV 1/0 AWG, 6/1 st. ACSR covered conductor	0.398	15 - 25	175	125	1.048	4,160
██████ - 22 kV 397.5 kcmil, 19 st. AAC covered conductor	0.723	25	75	75	1.074	6,754

3.2 Test Connectors and Installation Procedure

Test connectors are rated Class 1 in accordance with ANSI C119.4 and are identified as follows:

- ██████ for 17 kV 1/0 AWG ACSR covered conductor
- ██████ for 35 kV 1/0 AWG ACSR covered conductor
- ██████ for 22 kV 397.5 kcmil AAC covered conductor
- ██████ for 15 kV 1/0 AWG ACSR covered conductor

The installation of the ██████ splices was carried out by Kinectrics personnel using ██████ hydraulic crimping tool and ██████ dies U247 (for ██████) and U468 (for ██████). Note that the installation of the ██████ on 1/0 AWG ACSR resulted in significant bird-caging of the conductor on both ends of the splice (see Figure 3-3).

The ██████ was provided pre-installed on conductor by San Diego Gas & Electric (SDG&E).



Figure 3-3: ██████ installed on 35 kV 1/0 AWG, 6/1 ACSR



Figure 3-4: [REDACTED] Installed on 22 kV 397.5 kcmil, 19 strands AAC



Figure 3-5: [REDACTED] Installed on 15 kV 1/0 AWG, 6/1 ACSR

The insulating cover on the connectors was not installed as it was deemed not to affect the mechanical strength of the splice and would prevent observing slippage on the conductor at the ends of the splice.

Kinectrics personnel prepared and installed the epoxy resin dead-end fittings used to terminate the free ends of the conductor. The length of the exposed conductor between the splice and the epoxy dead-end was greater than 24 inches as recommended in Table 12 of ANSI C119.0-2015 (see Table 3-1 for actual lengths).

Product Specifications for all splices, as supplied by Exponent, are shown in Appendix B.

4 Test Setup

The Maximum Load Test was performed in a hydraulically-activated horizontal test machine. A schematic for the Maximum Load Test is shown in Figure 4-1 and representative picture of the typical setup is shown in Figure 4-2.

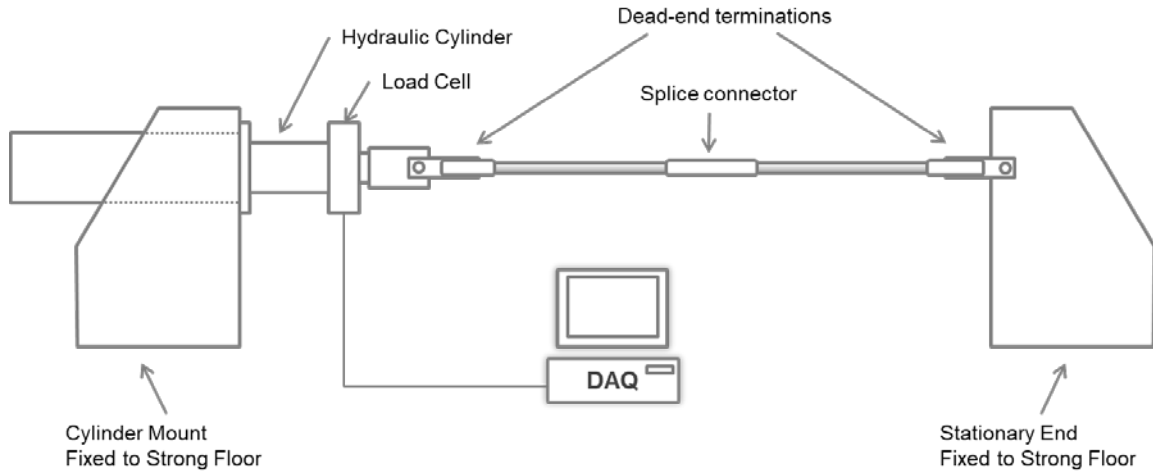

Figure 4-1: Maximum Load Test – Schematic of the Setup



Figure 4-2: Maximum Load Test - Typical Setup

The tension applied to the test assembly was measured by a load cell located at one end of the sample and was monitored continuously using a digital data logging system. The data logging rate was every one (1) second during loading and every ten (10) seconds during hold. The test was performed in a temperature-controlled laboratory at $22\text{ }^{\circ}\text{C} \pm 2\text{ }^{\circ}\text{C}$. The measuring instruments and equipment used in this test are listed in Appendix D.

5 Test Procedure

One at a time, the test samples were installed in the horizontal tensile machine and pre-tensioned to 10% of the conductor's RTS, corresponding to 400 lb for the 1/0 AWG ACSR, or 670 lb for the 397.5 kcmil AAC.

The conductor entrance points at the epoxy dead-end splice connector were marked with paint to monitor movement of conductor relative to the connector during the test. Red color paint was used to mark the conductor on the South end of the setup and blue color paint was used to mark the conductor on the North side of the setup. Note that North and South labels relate to the orientation of the horizontal test machine.

The load was then increased to 60% RTS and held for five (5) minutes. The conductor was visually monitored for slippage at both ends of the connector. Upon completing the five (5) minute hold, the load was increased until sample failure occurred.

6 Test Results

The maximum load recorded during the test and the failure location are summarized in Table 6-1. The graphical representation of the tensile load vs. elapsed time are shown in Figure 6-1 to Figure 6-4.

The sample appearing after testing and the failure locations are shown in Figure 6-3 to Figure 6-13.

[The remainder of this page is intentionally left blank.]

Table 6-1: Maximum Load Test Results

Sample No.	Splice	Conductor Size (AWG or kcmil)	Max. Load Recorded		Comments (Failure Location)
			[lb]	[%RTS]	
1.1.1	████████	17 kV, 1/0 AWG ACSR	4,659	112%	No slippage at 60% RTS. Conductor aluminum strands broke approx. 1" from the South end of the splice. Steel core was intact.
1.1.2	████████	17 kV 1/0 AWG ACSR	4,724	114%	No slippage at 60% RTS. Conductor aluminum strands broke near South end of the splice. Steel core was intact.
1.1.3	████████	17 kV 1/0 AWG ACSR	4,517	109%	No slippage at 60% RTS. Conductor broke at the North epoxy dead-end block. Steel core pulled out completely.
1.2.1	████████	35 kV 1/0 AWG ACSR	4,454	107%	No slippage at 60% RTS. Conductor broke near South end of the splice. Steel core pulled out completely.
1.2.2	████████	35 kV 1/0 AWG ACSR	4,623	111%	No slippage at 60% RTS. Conductor aluminum strands broke at the South end of the splice. Steel core was intact.
1.2.3	████████	35 kV 1/0 AWG ACSR	4,213	101%	No slippage at 60% RTS. Conductor broke at the North epoxy dead-end block.
1.3.1	████████	22 kV 397.5 kcmil AAC	6,979	103%	No slippage at 60% RTS. Conductor broke at the south entrance of the splice
1.3.2	████████	22 kV 397.5 kcmil AAC	7,152	106%	No slippage at 60% RTS. Conductor broke at the south entrance of the splice.
1.3.3	████████	22 kV 397.5 kcmil AAC	7,245	107%	No slippage at 60% RTS. Conductor broke at the south entrance of the splice
1.4.1	████████	15 kV, 1/0 AWG ACSR	4,263	102%	No slippage at 60% RTS. Conductor pulled out of South DE.
1.4.2	████████	15 kV 1/0 AWG ACSR	4,625	111%	No slippage at 60% RTS. Conductor broke at the North mouth of splice.
1.4.3	████████	15 kV 1/0 AWG ACSR	4,626	111%	No slippage at 60% RTS. Conductor broke at the South DE.

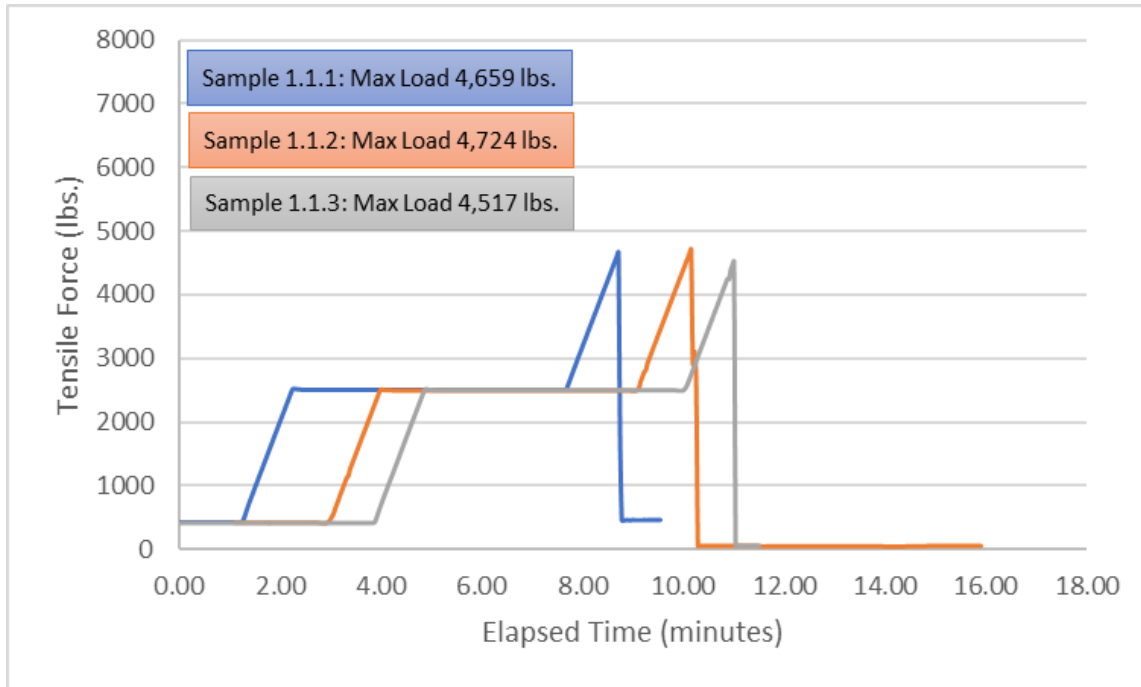

Figure 6-1: Maximum Load Test – 17 kV, 1/0 AWG ACSR

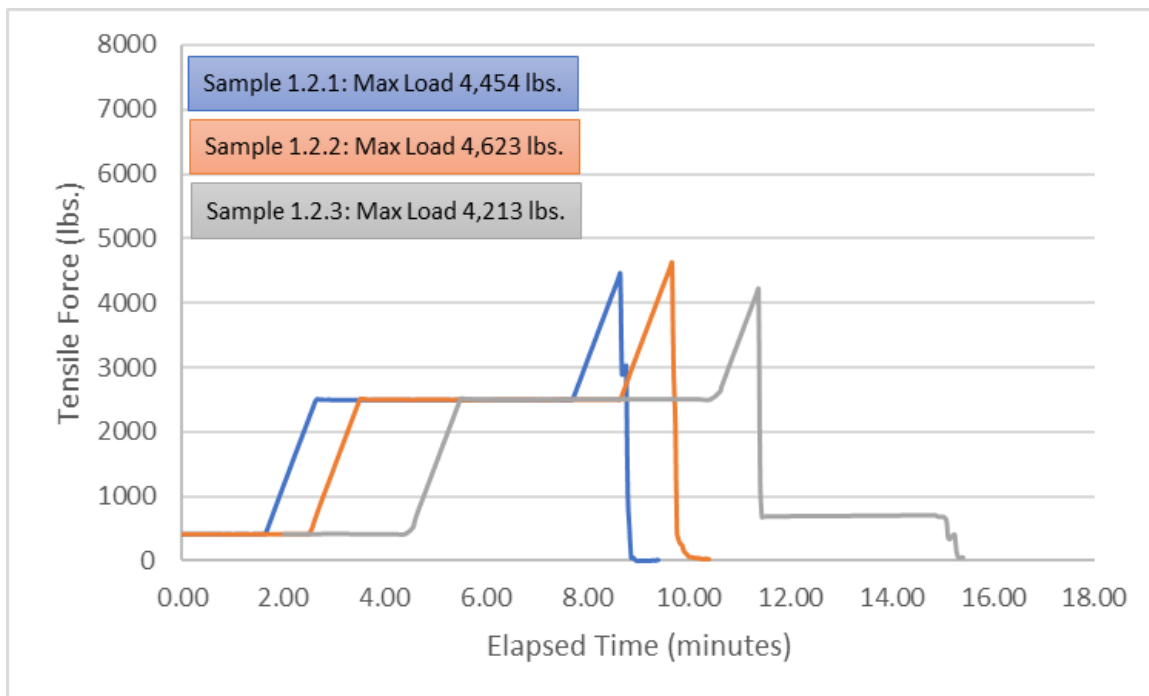

Figure 6-2: Maximum Load Test – 35 kV, 1/0 AWG ACSR

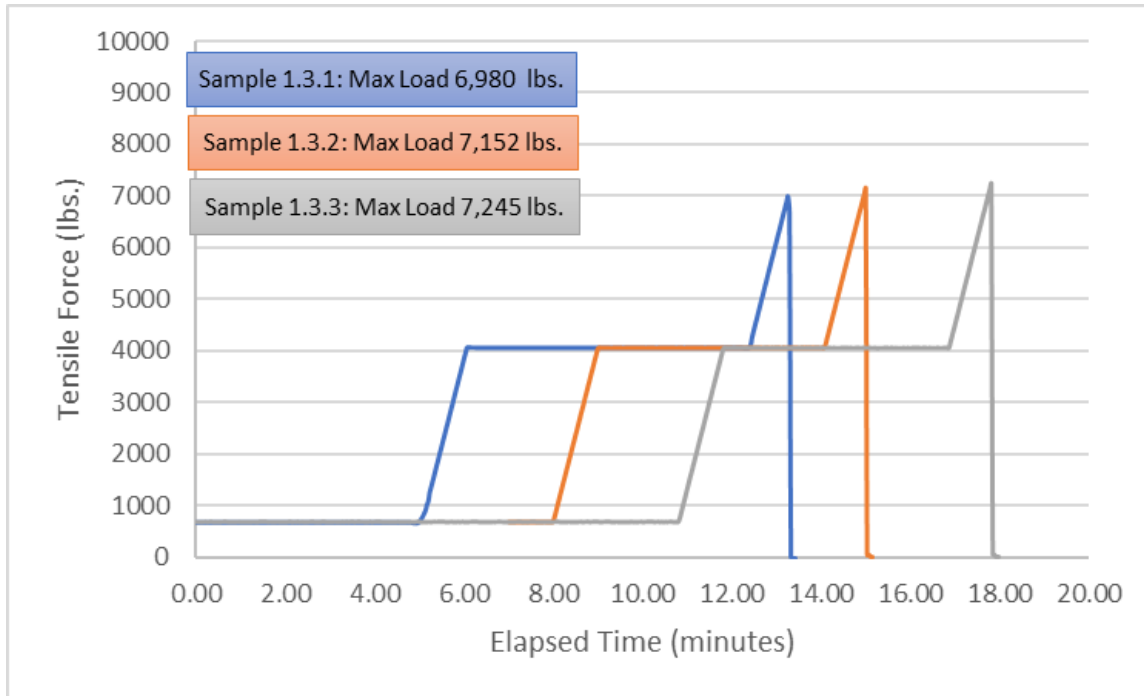

Figure 6-3: Maximum Load Test – 22 kV, 397.5 kcmil AAC

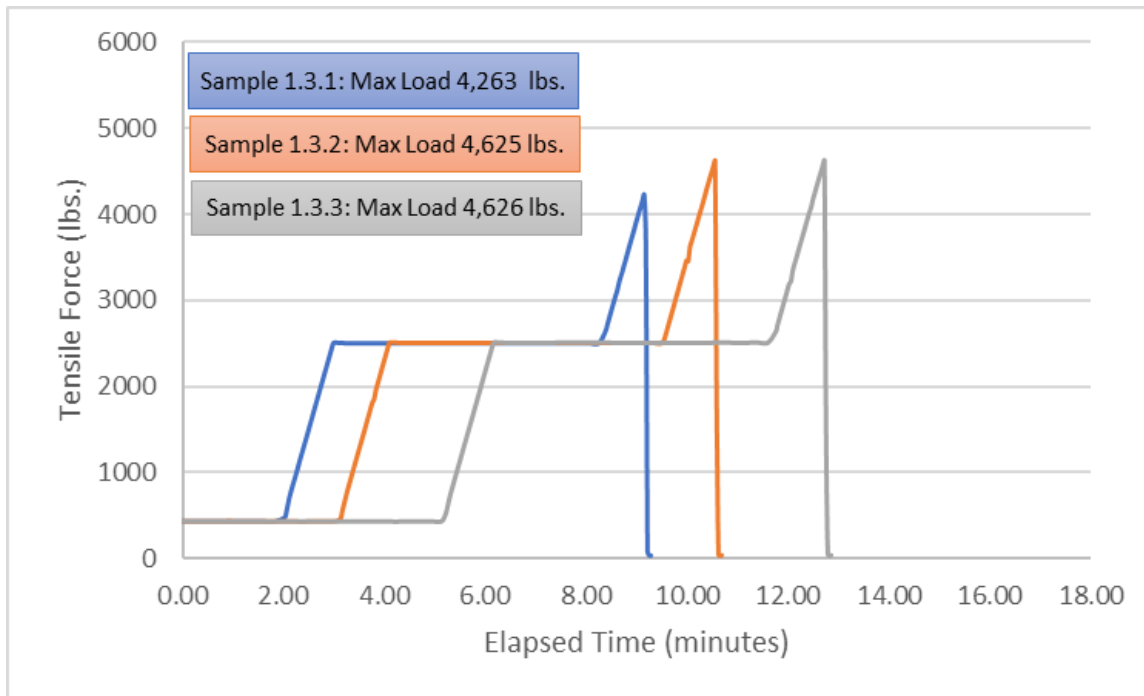

Figure 6-4: Maximum Load Test – 15 kV, 1/0 AWG ACSR

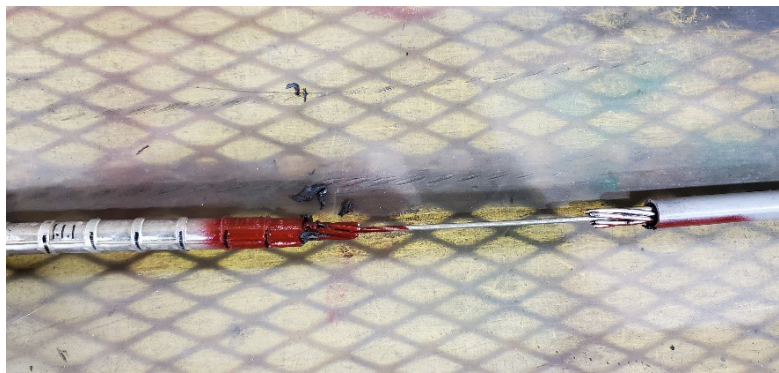
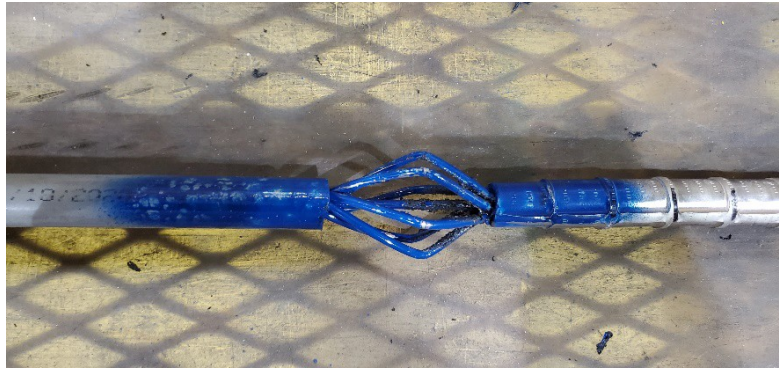

Figure 6-5: Sample 1.1.1 after test (conductor failed at South end of splice)



Figure 6-6: Sample 1.1.2 after test (conductor failed at South end of splice)

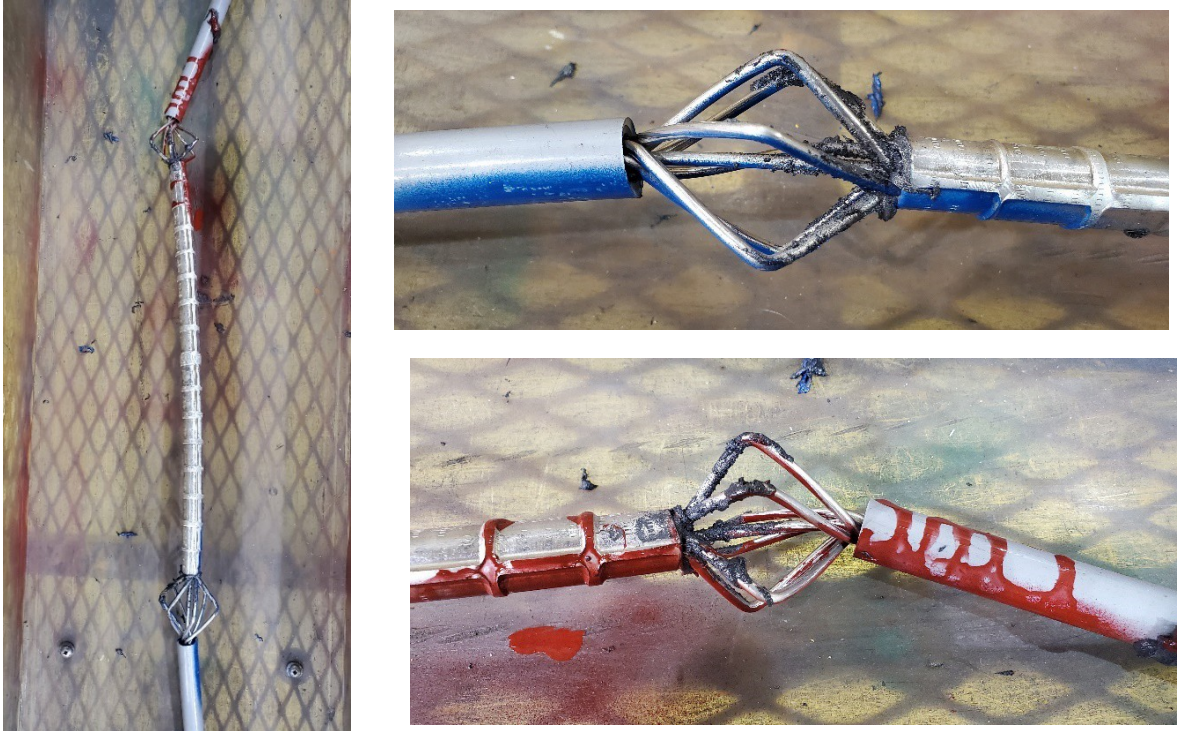

Figure 6-7: Sample 1.1.3 after test (conductor failed at North epoxy dead-end)



Figure 6-8: Sample 1.2.1 after test (conductor failed at North end of splice)

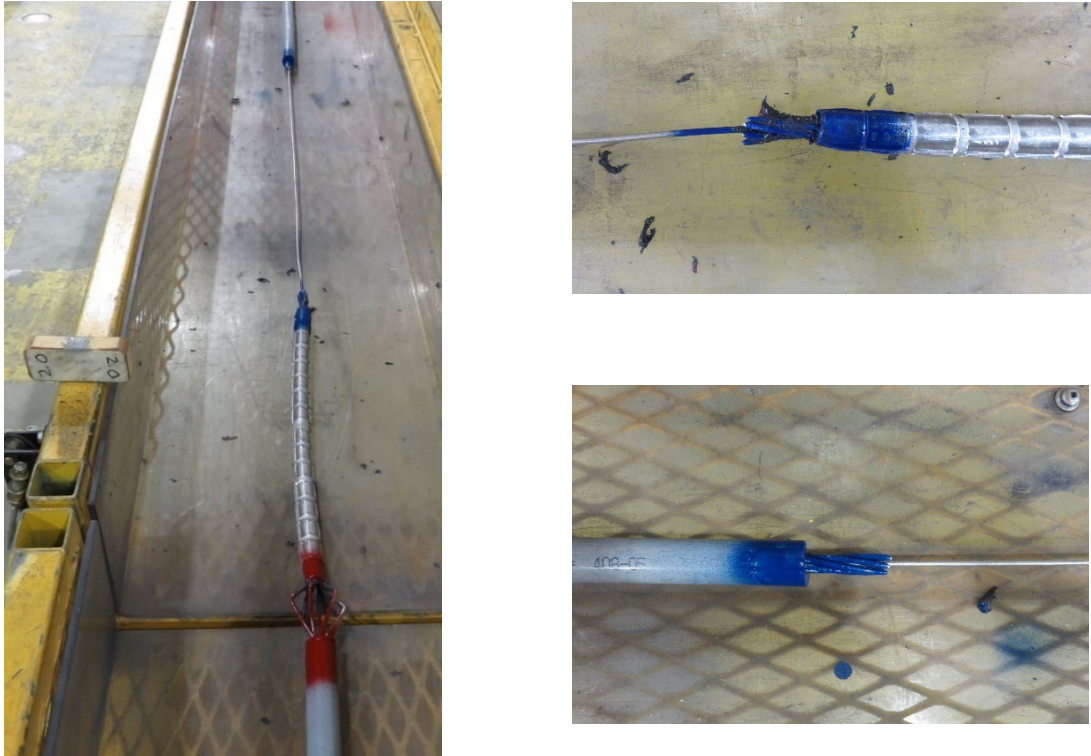

Figure 6-9: Sample 1.2.2 after test (conductor failed at North end of splice)

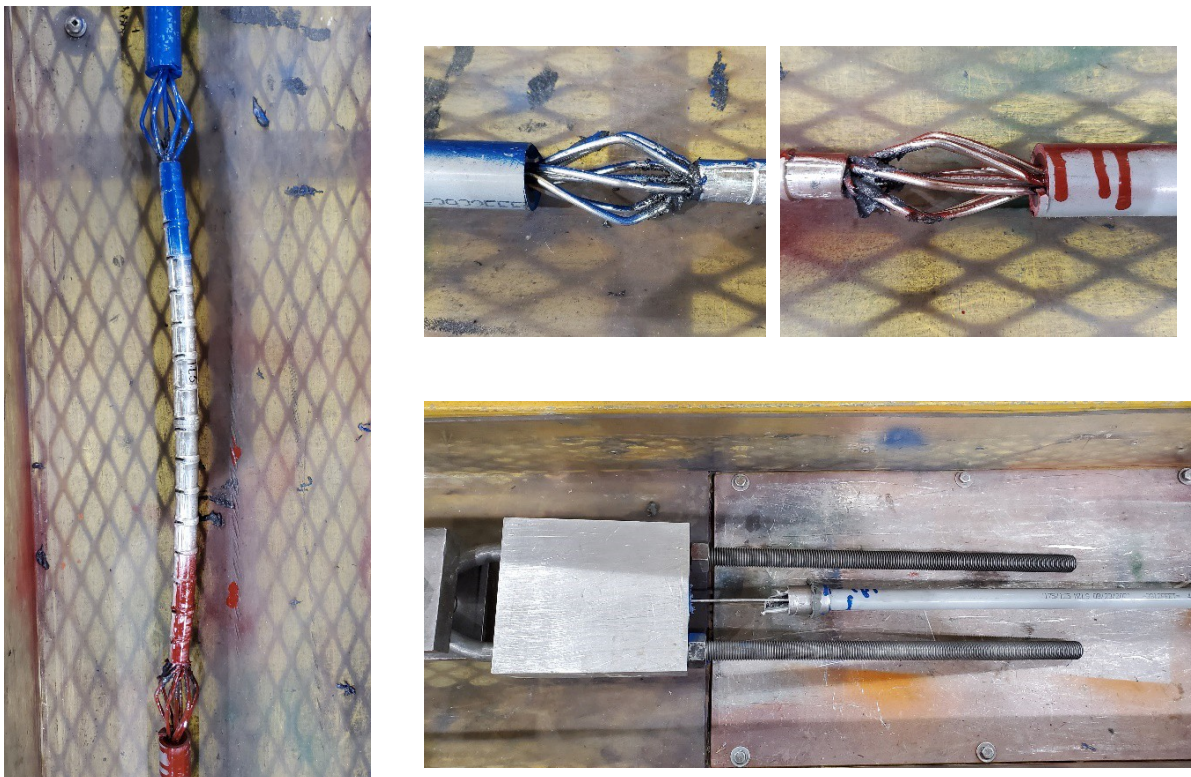

Figure 6-10: Sample 1.2.3 after test (failed at epoxy dead-end)

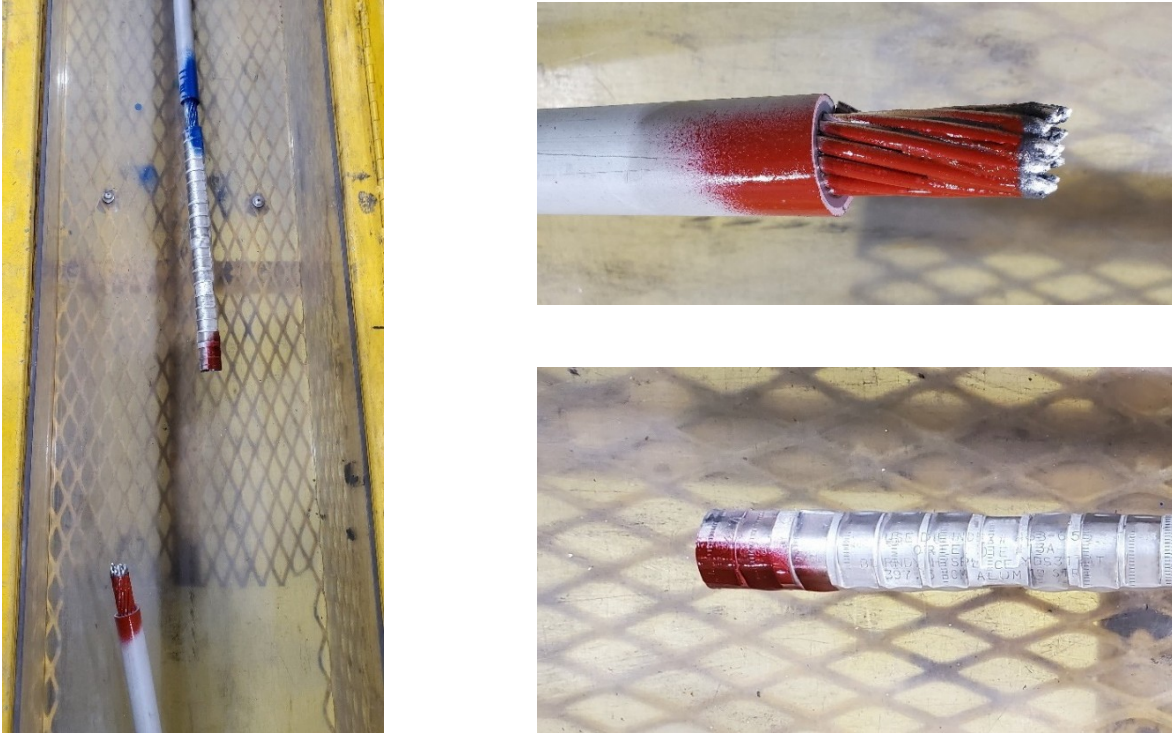

Figure 6-11: Sample 1.3.1 after test

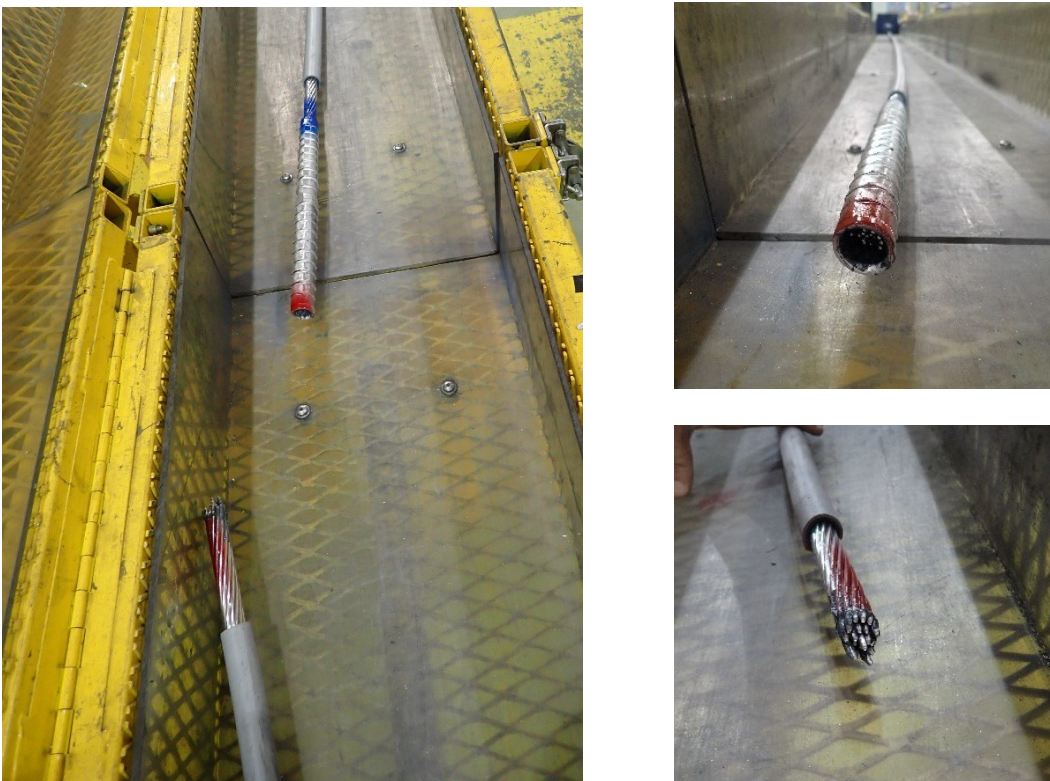

Figure 6-12: Sample 1.3.2 after test



Figure 6-13: Sample 1.3.3 after test

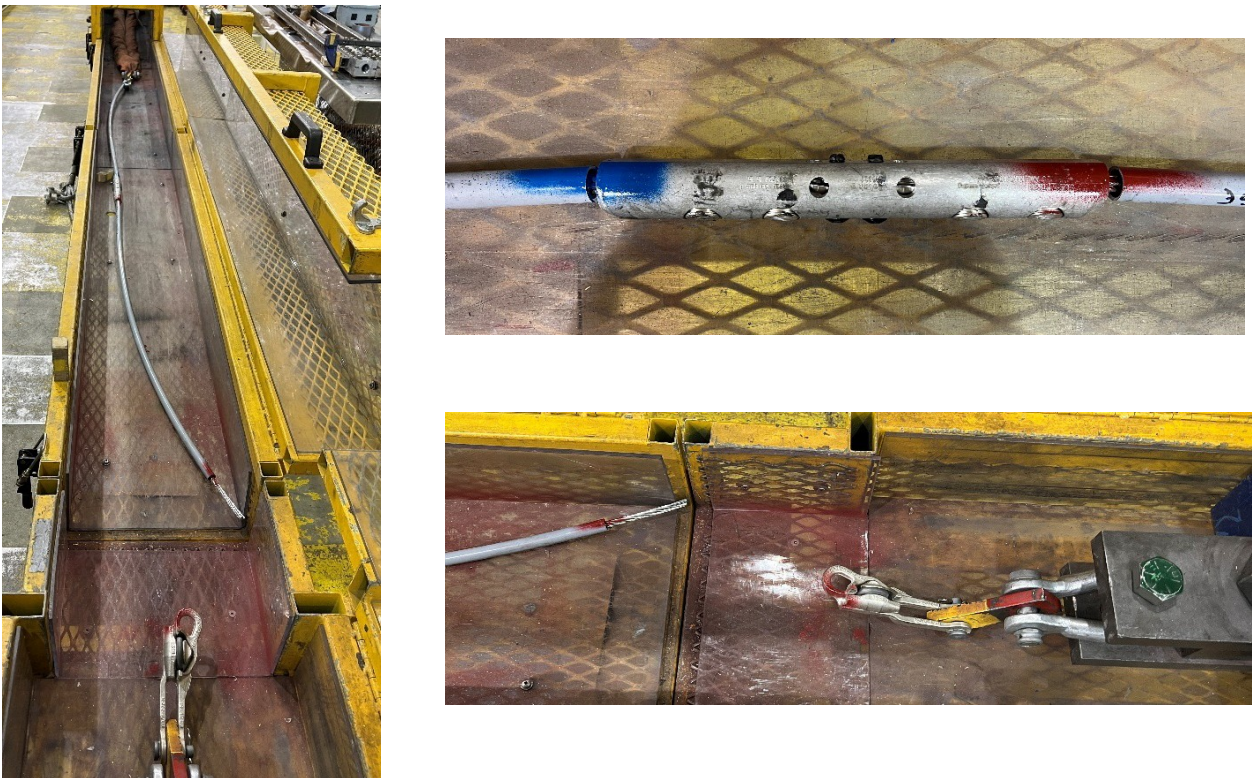

Figure 6-14: Sample 1.4.1 after test

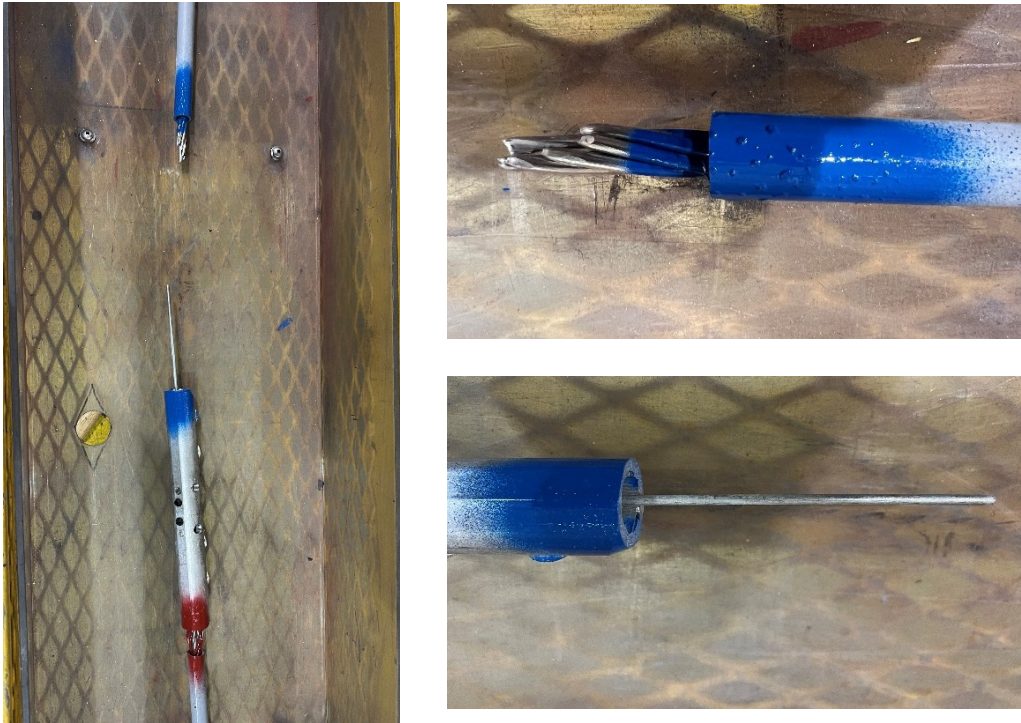

Figure 6-15: Sample 1.4.2 after test

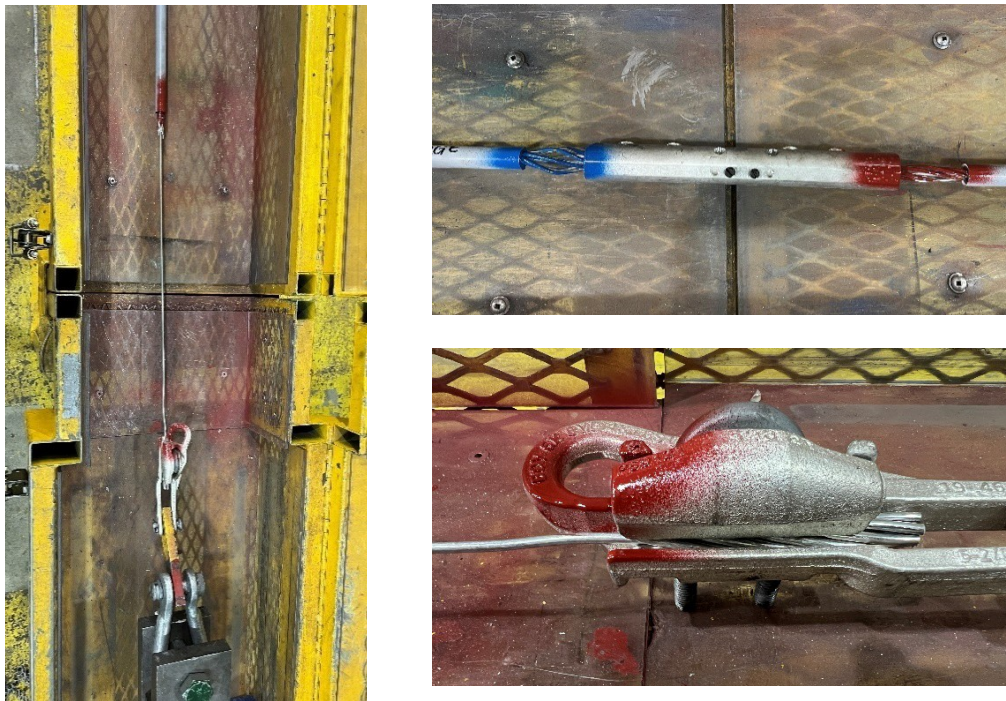

Figure 6-16: Sample 1.4.3 after test

7 Acceptance Criteria

There were no acceptance criteria provided by the client. The objective of the test program was to:

1. Evaluate the performance of the connectors (i.e. conductor slippage) at the end of five (5) minutes hold at 60% RTS; and,
2. Evaluate the maximum tensile strength of the connector/conductor assembly.

8 Conclusion

Test results show that the connectors tested performed without slippage during the five (5) minute hold at 60% RTS and that there was no slippage or breakage of the conductor strands below 100% RTS.

[The remainder of this page is intentionally left blank.]



Appendix A Acronyms and Abbreviations

AAC	- All Aluminum Conductor
ACSR	- Aluminum Conductor Steel Reinforced
ANSI	- The American National Standards Institute
AWG	- American Wire Gauge
DE	- Dead-end
ISO	- International Organization for Standardization
RTS	- Rated Tensile Strength
SDG&E	- San Diego Gas & Electric
XLPE	- Crosslinked Polyethylene

[The remainder of this page is intentionally left blank.]

Appendix B Product Specification of Splices

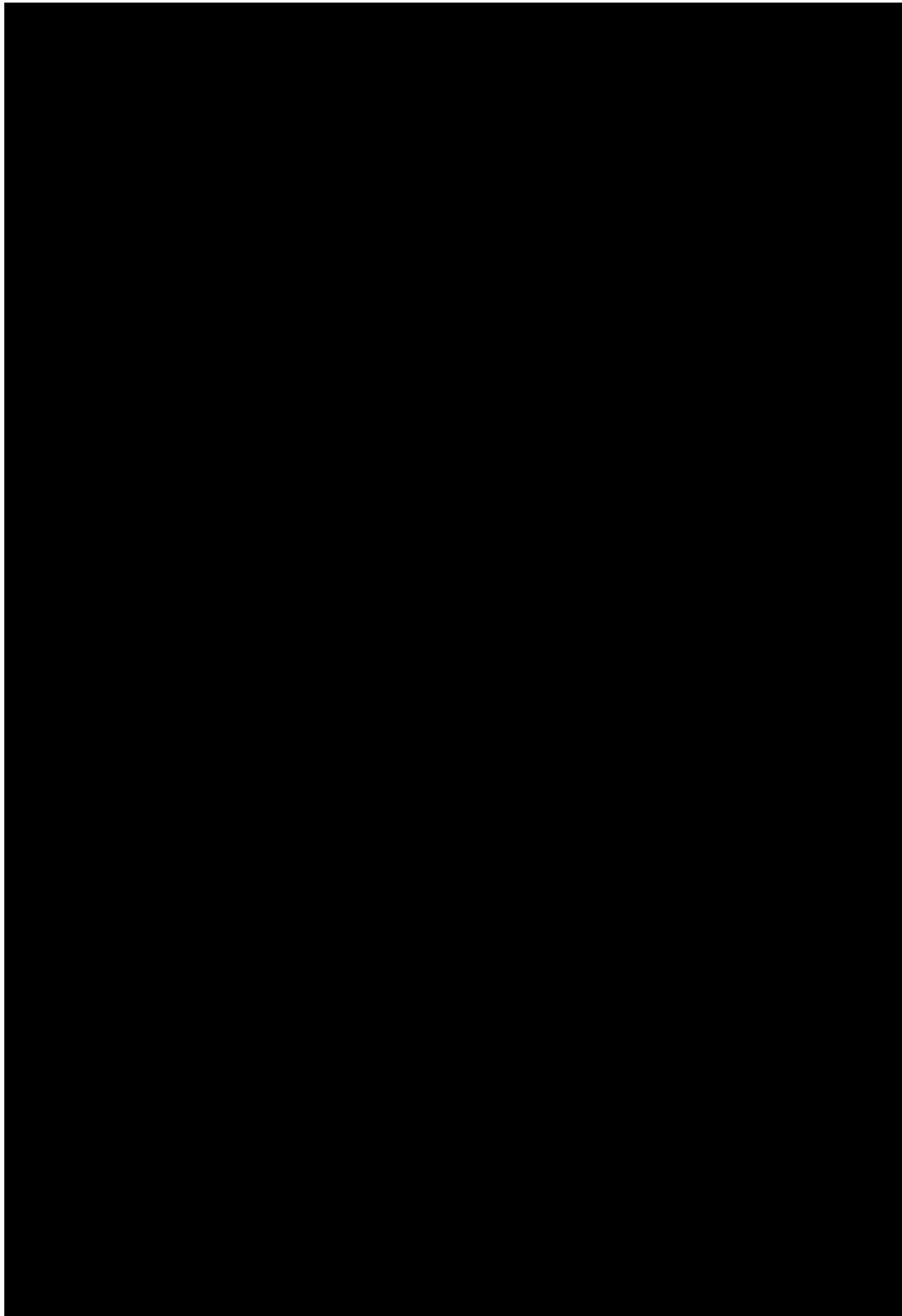

Figure B - 1: [REDACTED] (Page 1 of 2)

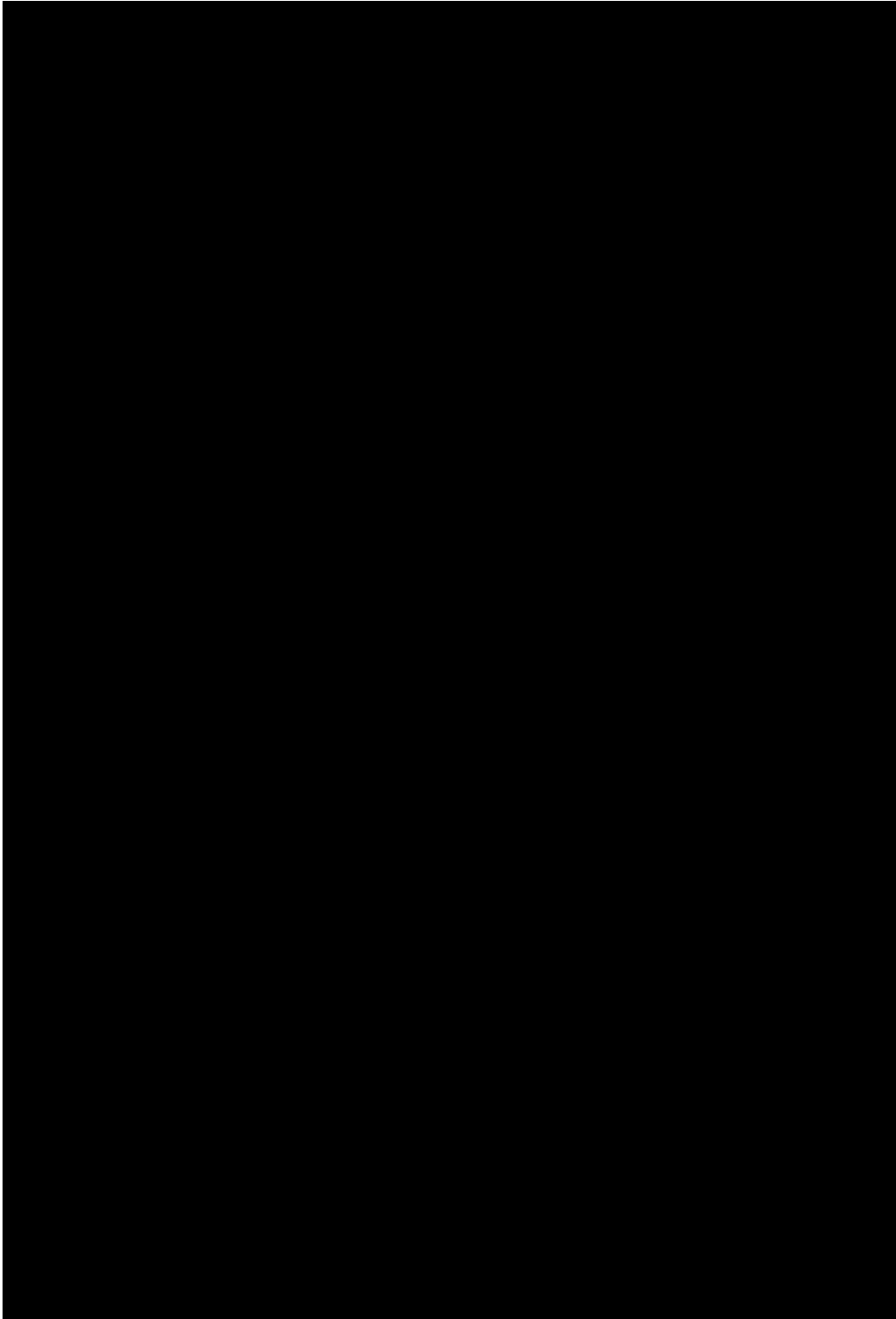

Figure B - 2:  (Page 2 of 2)

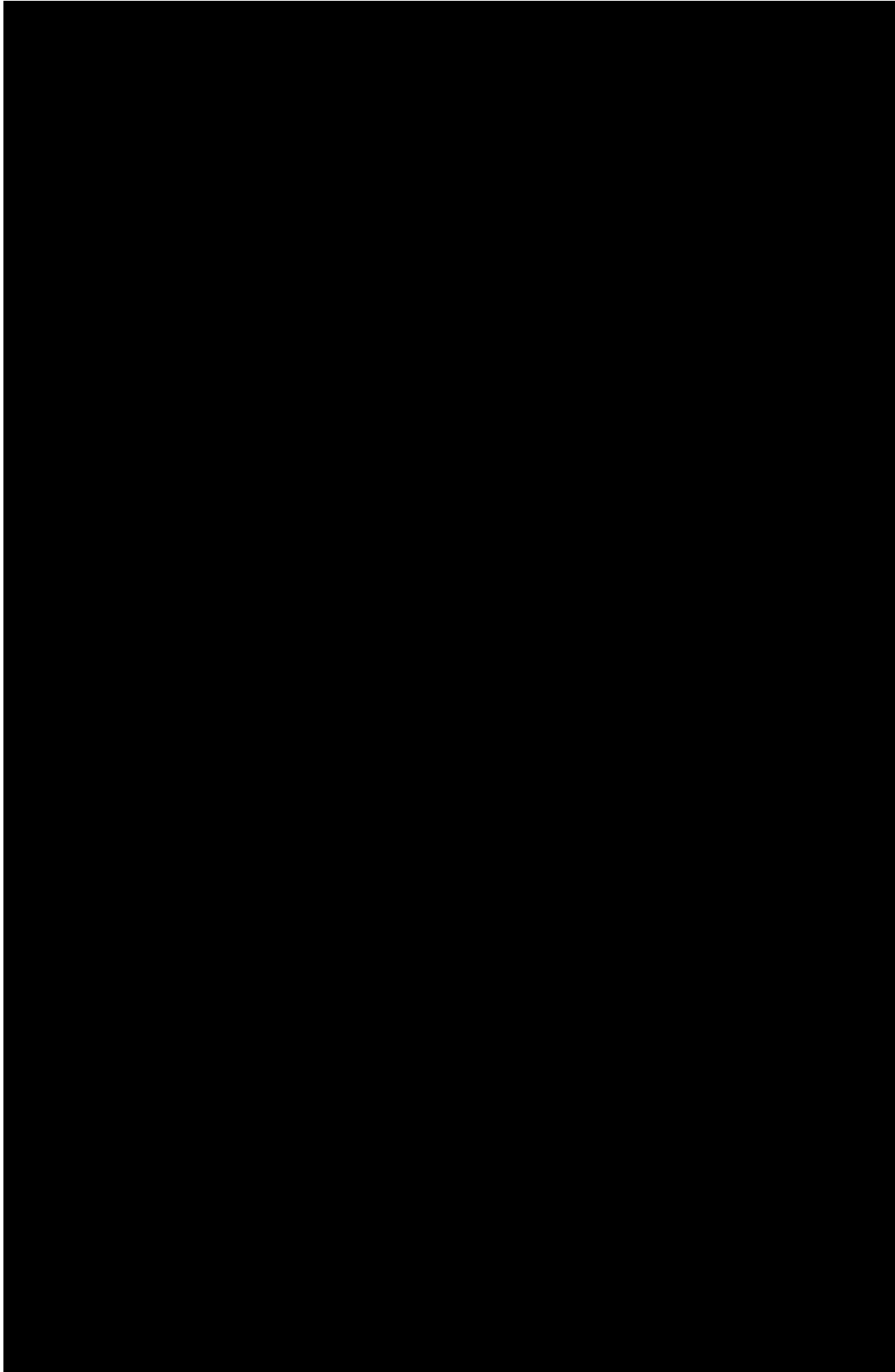

Figure B - 3: [REDACTED] (installation drawing)

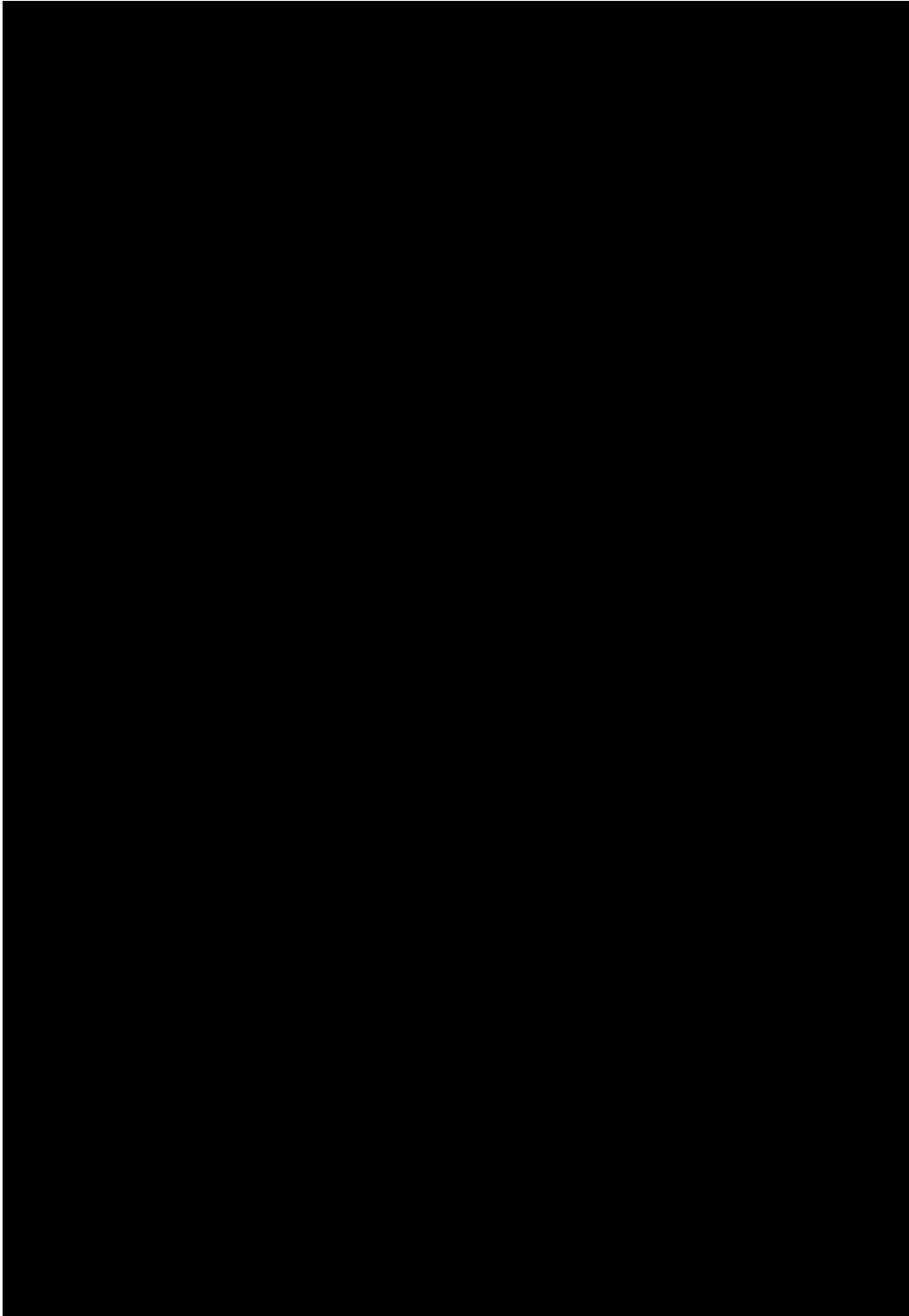

Figure B - 4: 

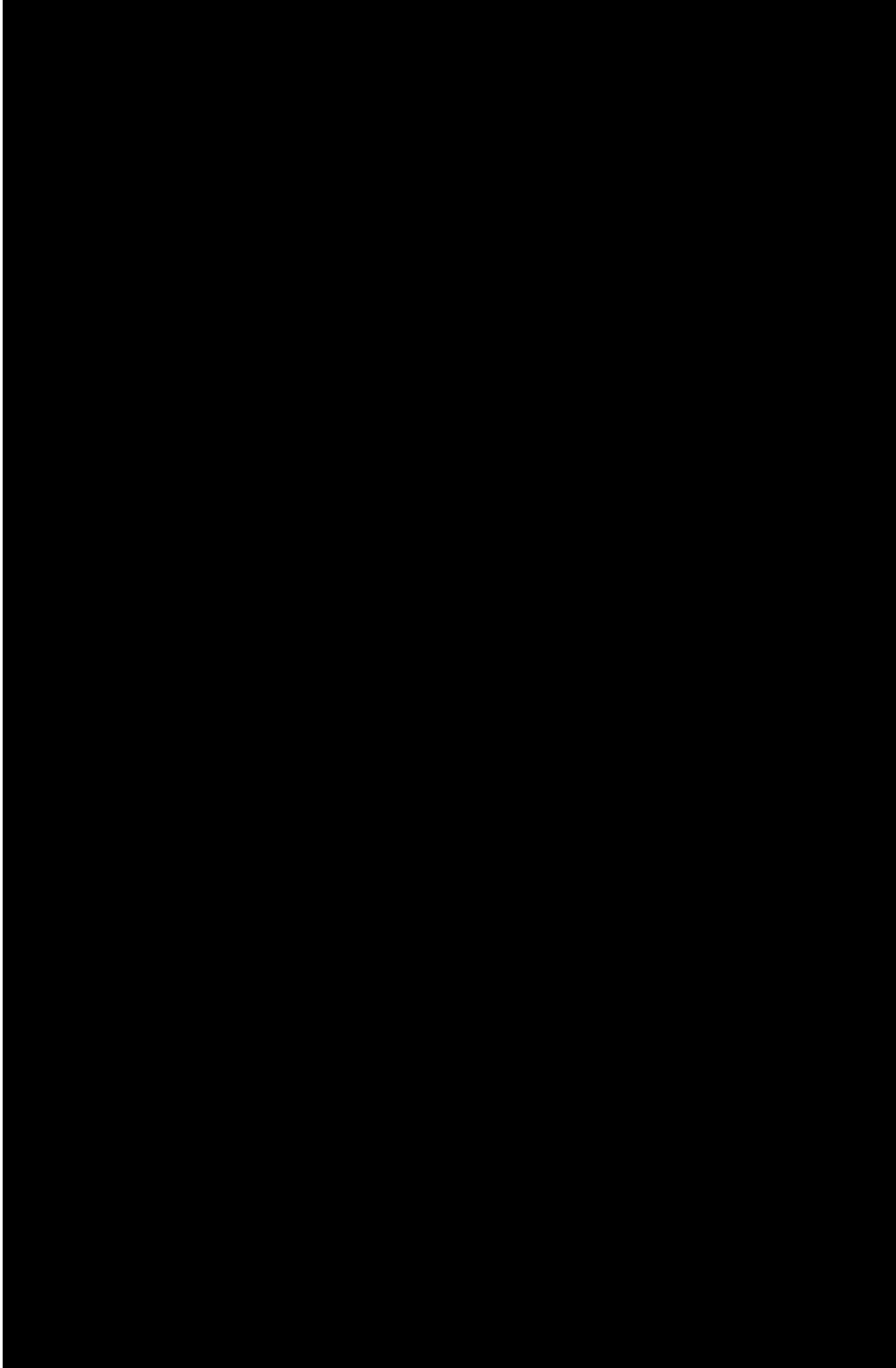

Figure B - 5: 

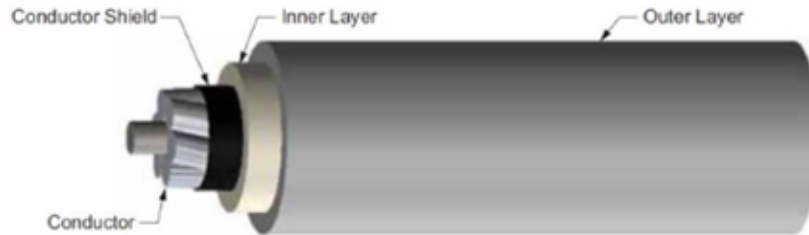

Figure B - 6:  datasheet

Appendix C Conductor Data Sheet (as provided by Exponent)

Covered Conductor Data Sheet

Covered Conductor for 17kV and 35kV



- Conductor:
 - Aluminum Conductor Steel-Reinforced (ACSR) or
 - Hard Drawn Copper (HDCU)
- Conductor Shield: Semiconducting Thermoset Polymer
- Inner Layer: Crosslinked Low Density Polyethylene (XL-LDPE)
- Outer Layer: Crosslinked High Density Polyethylene (XL-HDPE)
 - Track Resistant
 - Abrasion Resistant

Temperature Rating:

Normal Operating Temperature: 90°C

Emergency Operating Temperature: 130°C

Short Circuit Temperature: 250°C

17kV Covered Conductor

ACSR

Conductor Size (AWG)	Conductor Type (Stranding)	Weight (lb/ft)	Conductor Diameter (in)	Conductor Shield Thickness (in)	Inner Layer Thickness (in)	Outer Layer Thickness (in)	Max Nominal Overall Diameter (in)	Maximum Rated Strength (lb.)	Ampacity per Conductor ¹ (Amps)
1/0	ACSR (6x1)	0.289	0.398	0.015 - 0.025	0.075	0.075	0.748	4,160	271
336.4	ACSR (18x1)	0.584	0.684	0.015 - 0.025	0.075	0.075	1.034	8,246	550
336.4	ACSR (30/7)	0.750	0.741	0.015 - 0.025	0.075	0.075	1.091	16,435	561
653.9	ACSR (18x3)	0.998	0.953	0.020 - 0.025	0.080	0.080	1.323	14,060	835

¹ Covered Conductor Cable Normal Operating Rating Criteria:

Ambient Temperature = 40°C

Conductor Temperature = 90°C

Load Factor = 100%

Wind Speed = 4 ft/sec

Coefficient of Emissivity = 0.5

Coefficient of Absorption = 0.5

Latitude = 34°

Elevation of Conductor above Sea Level = 0 ft

Atmosphere = Clear

Local Sun Time = 1:00 pm

Figure C - 1: [REDACTED], 17 kV 1/0 AWG ACSR Conductor Data

35kV Covered Conductor

ACSR

Conductor Size (AWG)	Conductor Type (Stranding)	Weight (lb/ft)	Conductor Diameter (in)	Conductor Shield Thickness (in)	Inner Layer Thickness (in)	Outer Layer Thickness (in)	Max Nominal Overall Diameter (in)	Maximum Rated Strength (lb.)	Ampacity per Conductor ¹ (Amps)
1/0	ACSR (6x1)	0.460	0.398	0.015 - 0.025	0.175	0.125	1.048	4,160	255
336.4	ACSR (18x1)	0.850	0.684	0.015 - 0.025	0.175	0.125	1.334	8,246	518
336.4	ACSR (30x7)	0.981	0.741	0.015 - 0.025	0.175	0.125	1.391	16,435	529
653.9	ACSR (18x3)	1.242	0.953	0.020 - 0.025	0.175	0.125	1.602	14,060	784

¹ Covered Conductor Cable Normal Operating Rating Criteria:

- Ambient Temperature = 40°C
- Conductor Temperature = 90°C
- Load Factor = 100%
- Wind Speed = 4 ft/sec
- Coefficient of Emissivity = 0.5
- Coefficient of Absorption = 0.5
- Latitude = 34°
- Elevation of Conductor above Sea Level = 0 ft
- Atmosphere = Clear
- Local Sun Time = 1:00 pm

Specifications

Must be manufactured to the latest editions of the following standards:

- ASTM B8
- ASTM B232
- ICEA S-121-733

Figure C - 2: [REDACTED], 35 kV 1/0 AWG ACSR Conductor Data



Appendix D Instrument Sheet

EQUIPMENT DESCRIPTION	ASSET No.	ACCURACY CLAIMED	CALIBRATION DATE	CALIBRATION DUE DATE	TEST USE
Data Logger	KIN-01836	±0.1% of Reading	May 20, 2021 May 27, 2022	May 20, 2022 May 27, 2023	Data acquisition
Load Cell/ Conditioner	KIN-01725/ KIN-01724	±1% of Reading	October 26, 2021	October 26, 2022	Load
Tape Measure	KIN-06890	< 0.05% of Reading	June 8, 2021 Jun 29, 2022	June 8, 2022 Jun 29, 2022	Length
Thermocouple/ Transmitter	KIN-00918/ KIN-00919	± 1 °C	October 28, 2021 October 21, 2021	October 28, 2022/ October 21, 2022	Ambient Temperature

[The remainder of this page is intentionally left blank.]

Appendix E Kinectrics ISO 9001 Certificate of Registration



 **CERTIFICATE OF REGISTRATION**

This is to certify that
Kinectrics Inc.
Kinectrics North America Inc., Kinectrics International Europe ApS or Kinectrics International Inc.
800 Kipling Avenue, Unit 2, Toronto, Ontario M8Z 5G5 Canada

Refer to Attachment to Certificate of Registration dated November 5, 2021 for additional certified sites
operates a
Quality Management System
which complies with the requirements of
ISO 9001:2015
for the following scope of certification
This registration covers the Quality Management System for engineering, consulting, design, testing, project management, research, software development, assessments, operations support, and analysis within our facilities, and at field sites, for customers in the electricity industry and related energy sectors; both nuclear and conventional; as well as processing of radiological and conventional laundry and manufacture, inspection, and repair of personal protection equipment.

Certificate No.: CERT-0119296	Original Certification Date: July 7, 1998
File No.: 006555	Certification Effective Date: May 23, 2021
Issue Date: November 5, 2021	Certification Expiry Date: May 22, 2024

Frank Camasta
Global Head of Technical Services
SAI Global Assurance

Registered by:
QMI-SAI Canada Limited (SAI Global), 20 Carlton Court, Suite 200, Toronto, Ontario M5W 7Y5 Canada. This registration is subject to the SAI Global Terms and Conditions for Certification. While all due care and skill was exercised in carrying out the assessment, SAI Global accepts responsibility only for proven negligence. This certificate remains the property of SAI Global and must be returned to them upon request.
To verify that this certificate is current, please refer to the SAI Global On-Line Certification Register:
https://www.sai-global.com/en-us/assurance/auditing_and_certification/certification_registry/





Appendix F Distribution

Mr. Matt Bowers, Ph.D., P.E. Exponent
17000 Science Drive, Suite 200
Bowie, Maryland 20715
Email: mbowers@exponent.com

Mr. Genti Gorja Kinectrics AES Inc.
800 Kipling Ave, Unit No.2
Toronto, ON
Canada M8Z 5G5
Email: genti.gorja@kinectrics.com

[The remainder of this page is intentionally left blank.]



NOTE: Component manufacturer information has been redacted from this report.

SLIP LOAD TEST ON INSULATOR CLAMPS WITH COVERED CONDUCTORS

K-580740-RP-002 R01

Prepared for

Exponent

Purchase Order No. 00062928

<p>Prepared by</p> <p> Digitally signed by GORJA Genti Date: 2022.11.04 16:30:41 -04'00'</p> <p><i>Signature & Date</i></p> <p>Genti Gorja P.Eng. Principal Engineer Line Asset Management</p>	<p>Reviewed by</p> <p> Digitally signed by André Maurice Date: 2022.11.07 13:38:25 -05'00'</p> <p><i>Signature & Date</i></p> <p>André Maurice Service Line Manager Line Asset Management</p>	<p>Approved by</p> <p>PETER Zsolt  Digitally signed by PETER Zsolt Date: 2022.11.08 07:48:48 -05'00'</p> <p><i>Signature & Date</i></p> <p>Zsolt Peter Ph.D. Business Area Director Line Asset Management</p>
---	--	--

Revision History

Rev 00	Description: Original issue			
	Issue Date: 2022-09-28	Prepared by: Genti Gorja	Reviewed by: André Maurice	Approved by: Zsolt Peter
Rev 01	Description: The %RTS values reported for the [REDACTED] insulator in Table 6-1 are incorrect.			
	Issue Date: 2022-11-04	Prepared by: Genti Gorja	Reviewed by: André Maurice	Approved by: Zsolt Peter

DISCLAIMER

Kinectrics prepared this report as a work of authorship sponsored by their client. This report has been prepared solely for the benefit of the Client and may not be used or relied upon in whole or in part by any other person or entity without Client permission or without Kinectrics' permission if required by the Contract between Client and Kinectrics Inc. Neither Kinectrics, their client nor any person acting on behalf of them: (a) makes any warranty or representation whatsoever, express or implied, or assumes any legal liability of responsibility for any third party's use, or the results of such use, with respect to (i) the use of any information, apparatus, method, process, or similar item disclosed in this report including the merchantability or fitness for any particular purpose of any information contained in this report or the respective works or services supplied or performed or (ii) that such use does not infringe on or interfere with privately owned rights, including any party's intellectual property; or (b) assumes responsibility for any damages or other liability whatsoever (including any consequential damages resulting from a third party's selection or use of this report or any information, apparatus, method, process, or similar item disclosed).

Copyright © Kinectrics Inc. 2022. All rights reserved.



Table of Contents

1	Executive Summary	4
2	Test Objective and Test Standard.....	5
3	Test Sample.....	5
4	Test Setup	6
5	Test Procedure	8
6	Test Results.....	8
7	Acceptance Criteria.....	18
8	Conclusion	18
Appendix A	Acronyms and Abbreviations	19
Appendix B	Conductor Data Sheet (<i>as provided by Exponent</i>).....	20
Appendix C	Insulator Data Sheet.....	22
Appendix D	Instrument Sheet.....	24
Appendix E	Kinectrics ISO 9001 Certificate of Registration	25
Appendix F	Distribution	26

1 Executive Summary

This report describes the Slip Load Test performed on [REDACTED] Vise Top pin insulator (model [REDACTED] - [REDACTED] and [REDACTED] Clamp Top post insulator (model [REDACTED] and [REDACTED]

The Slip Load Test was conducted for Exponent™ to evaluate the performance of [REDACTED] and [REDACTED] post insulator clamps designed for use with 15 kV 1/0 AWG ACSR covered conductor, 17 kV 1/0 AWG ACSR covered conductor, 35 kV 1/0 AWG ACSR covered conductor and 22 kV 397.5 kcmil AAC covered conductor.

The test were conducted in accordance with client’s requirements as outlined in the relevant sections of this document. The test program and completion dates are summarized in Table 1-1.

Table 1-1: Test Program

Test ID	Sample ID	Conductor	Insulator Cat.ID.	Date Completed
2.1	2.1.1	17 kV 1/0 AWG ACSR	[REDACTED]	May 11, 2022
	2.1.2	17 kV 1/0 AWG ACSR	[REDACTED]	May 11, 2022
	2.1.3	17 kV 1/0 AWG ACSR	[REDACTED]	May 11, 2022
2.2	2.2.1	35 kV 1/0 AWG ACSR	[REDACTED]	May 12, 2022
	2.2.2	35 kV 1/0 AWG ACSR	[REDACTED]	May 12, 2022
	2.2.3	35 kV 1/0 AWG ACSR	[REDACTED]	May 12, 2022
2.3	2.3.1	22 kV 397.5 kcmil AAC	[REDACTED]	May 13, 2022
	2.3.2	22 kV 397.5 kcmil AAC	[REDACTED]	May 13, 2022
	2.3.3	22 kV 397.5 kcmil AAC	[REDACTED]	May 13, 2022
2.4	2.4.1	15 kV 1/0 AWG ACSR	[REDACTED]	July 26, 2022
	2.4.2	15 kV 1/0 AWG ACSR	[REDACTED]	July 26, 2022
	2.4.3	15 kV 1/0 AWG ACSR	[REDACTED]	July 26, 2022
2k.1	2k.1.1	17 kV 1/0 AWG ACSR	[REDACTED]	July 27, 2022
	2k.1.2	17 kV 1/0 AWG ACSR	[REDACTED]	July 27, 2022
	2k.1.3	17 kV 1/0 AWG ACSR	[REDACTED]	July 27, 2022
2k.2	2k.2.1	35 kV 1/0 AWG ACSR	[REDACTED]	July 27, 2022
	2k.2.2	35 kV 1/0 AWG ACSR	[REDACTED]	July 27, 2022
	2k.2.3	35 kV 1/0 AWG ACSR	[REDACTED]	July 27, 2022

Exponent™ supplied samples and accessories required for testing. Kinectrics received all samples, in good condition, on May 2, 2022.

The tests were performed by Kinectrics personnel at 800 Kipling Avenue, Toronto, Ontario, M8Z 5G5, Canada. The work was conducted under Exponent™ Purchase Order No. 00062928 dated January 14, 2022.

The tests were performed under Kinectrics’ ISO 9001 Quality Management System. A copy of ISO 9001 Certificate of Registration is included in Appendix E.

2 Test Objective and Test Standard

The intent of the Slip Test was to determine the tensile load which resulted in conductor slippage relative to the clamp of a [REDACTED] Vise Top pin insulator or [REDACTED] Clamp Top post insulator. The test was designed to simulate clamp/conductor system mechanical loading during field installation and operation. The test was performed in accordance with the procedures requested by Exponent™.

3 Test Sample

A total of eighteen (18) samples were tested. The test samples consisted of the following insulators (see Appendix C for the insulator data sheet):

- Twelve (12) [REDACTED] Vise Top pin insulator, model [REDACTED]
- Three (3) [REDACTED] Clamp Top post insulator, model [REDACTED]
- Three (3) [REDACTED] Clamp Top post insulator, model [REDACTED]

A 45 ft length of each conductor type was terminated with one dead-end for testing in conjunction with the corresponding insulator. Detailed data of the conductors used in this test program are shown in Appendix B. A summary of the test sample configurations is shown in Table 3-1.

Table 3-1: Test Sample Configuration

Sample No.	Connector Identification		Conductor Size (AWG or kcmil)	Overall Length [ft]
	Dead-end	Insulator		
2.1.1	Epoxy Resin	[REDACTED]	17 kV, 1/0 AWG ACSR	45
2.1.2		[REDACTED]		
2.1.3		[REDACTED]		
2.2.1	Epoxy Resin	[REDACTED]	35 kV 1/0 AWG ACSR	45
2.2.2		[REDACTED]		
2.2.3		[REDACTED]		
2.3.1	Epoxy Resin	[REDACTED]	22 kV 397.5 kcmil AAC	45
2.3.2		[REDACTED]		
2.3.3		[REDACTED]		
2.4.1	[REDACTED]	[REDACTED]	15 kV 1/0 AWG ACSR	45
2.4.2		[REDACTED]		
2.4.3		[REDACTED]		
2k.1.1	[REDACTED]	[REDACTED]	17 kV, 1/0 AWG ACSR	45
2k.1.2		[REDACTED]		
2k.1.3		[REDACTED]		
2k.2.1	[REDACTED]	[REDACTED]	35 kV, 1/0 AWG ACSR	45
2k.2.2		[REDACTED]		
2k.2.3		[REDACTED]		

4 Test Setup

The Slip Load Test was performed in a hydraulically-activated horizontal test machine. The conductor sample, terminated with the dead-end fitting installed at one end, was used for all three (3) insulator clamps. A different section of conductor was used for testing each new insulator.

The dead-end fitting, installed at one end of the conductor length was attached directly to the hydraulic piston. The test insulator (██████ Vise Top or ██████ Clamp Top) was setup vertically, on a support pedestal, to ensure that the center of the clamps was in line with the pulling axis of the cylinder.

Schematic of the slip test set-up is shown in Figure 4-1. The actual setup and clamp slip test is shown in Figure 4-2.

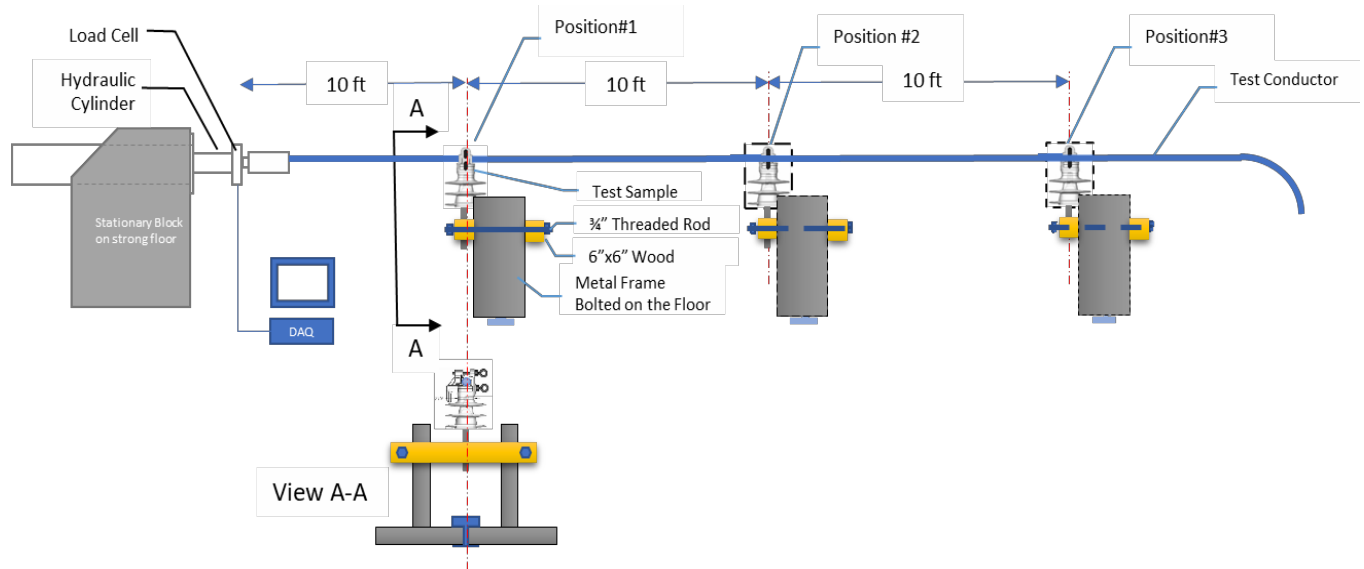

Figure 4-1: Clamp Slip Test Schematic

The Slip Load Test was performed by gradually increasing the load until slippage of the conductor inside the clamp occurred. The conductor tension and clamp slip load were measured by a load cell located at the end of the hydraulic cylinder. The test was performed in a temperature-controlled laboratory at $22\text{ }^{\circ}\text{C} \pm 2\text{ }^{\circ}\text{C}$. The measuring instruments and equipment used in this test are listed in Appendix D.



Test Sample

Conductor

Epoxy Dead End

Load Cell



Test Sample
Insulator



Test Sample
Insulator

Figure 4-2: Clamp Slip Test Setup

5 Test Procedure

The Slip Load Test was conducted as follows:

- The insulator was setup in the first position location approximately 10 ft from the cylinder (Position #1),
- The dead-end installed on the conductor was attached to the cylinder of the horizontal test machine and the conductor was secured in the vise top clamp of the insulator following manufacturer's instructions. When testing [REDACTED] Clamp Top insulators, a 40 ft-lb torque was used to secure the conductor in the clamp.
- The conductor tension is increased to 10% of RTS (pre-tension value) and the conductor was marked at the entry points in the clamp.
- The conductor tension is increased to 20% of RTS. The conductor was visually monitored for slippage.
- Tensile load was continuously increased at a rate of 1000 lb/min until continuous slippage of the conductor inside the clamp occurred, and the load could not be increased further.

Upon completing the test on the first sample, the same setup was repeated at a distance of 10 ft North of the first setup.

Upon completing the test on the second sample, the same setup was repeated at a distance of 10 ft North of the second setup.

6 Test Results

Test results are summarized in Table 6-1 and the loading profiles for each sample during test are shown in Figure 6-12 to Figure 6-17. Typical pictures of insulator and conductor condition after the test is shown in Figure 6-1 through Figure 6-6 for [REDACTED] insulators and Figure 6-7 through Figure 6-11 for [REDACTED] insulators.

Observations from the results of the test are listed below:

- When testing with [REDACTED] Vise Top insulators
 - o The slippage in all samples occurred as a result of the insulator bending under the tension applied to the conductor. This caused the conductor to come off a portion of the plastic inserts in the insulator clamp and slip. When testing the clamp with 397.5 AAC covered conductor, the larger diameter of the conductor made it easier to come off the clamp, as the insulator was bending under the effect of the tensile load on the conductor.
 - o There was no damage of the insulator (cracks or failure of the component). The insulator pin was bent in all test samples.
 - o There was some superficial damage on the outer jacket of the conductor.
- When testing with [REDACTED] Clamp Top insulators
 - o The slippage in all samples occurred at a lower tensile load as compared to the [REDACTED] Vise Top when tested with the same conductor

- The maximum tensile force achieved during the test with 35 kV 1/0 AWG ACSR conductor was higher than when testing with 17 kV 1/0 AWG ACSR conductor.
- There was no damage on the outer jacket of the conductor after the test.

Table 6-1: Suspension Clamps: Slip Test Results

Sample No.	Test Sample (Insulator)	Conductor Size (AWG or kcmil)	Max Slip Load Recorded		Comments (Observations)
			[lb]	[%RTS]	
2.1.1	██████████	17 kV, 1/0 AWG ACSR	1090.3	26.2 %	Slippage started at 868.8 lb
2.1.2	██████████	17 kV 1/0 AWG ACSR	1040.6	25.0 %	Slippage started at 865.5 lb
2.1.3	██████████	17 kV 1/0 AWG ACSR	1043.9	25.1 %	Slippage started at 870.2 lb
2.2.1	██████████	35 kV 1/0 AWG ACSR	970.9	23.3 %	Slippage started at 879.8 lb
2.2.2	██████████	35 kV 1/0 AWG ACSR	1048.3	25.2 %	Slippage started at 862.7 lb
2.2.3	██████████	35 kV 1/0 AWG ACSR	1024.1	24.6 %	Slippage started at 872.0 lb
2.3.1	██████████	22 kV 397.5 kcmil AAC	1107.3	16.4 %	Minimal slippage before reaching maximum load
2.3.2	██████████	22 kV 397.5 kcmil AAC	1195.1	17.7 %	Minimal slippage before reaching maximum load
2.3.3	██████████	22 kV 397.5 kcmil AAC	1142.9	16.9 %	Minimal slippage before reaching maximum load
2.4.1	██████████	15 kV, 1/0 AWG ACSR	863.3	20.8 %	Minimal slippage before reaching maximum load
2.4.2	██████████	15 kV 1/0 AWG ACSR	847.4	20.4 %	Minimal slippage before reaching maximum load
2.4.3	██████████	15 kV 1/0 AWG ACSR	872.6	21.0 %	Minimal slippage before reaching maximum load
2K.1.1	██████	17 kV, 1/0 AWG ACSR	380.4	9.1%	Slippage started before the hold.
2K.1.2	██████	17 kV 1/0 AWG ACSR	391.8	9.4%	Slippage started before the hold.
2K.1.3	██████	17 kV 1/0 AWG ACSR	291.9	7.0%	Slippage started before the hold.
2K.2.1	██████	35 kV 1/0 AWG ACSR	486.7	11.7%	Slippage started before the hold.
2K.2.2	██████	35 kV 1/0 AWG ACSR	393.1	9.4%	Slippage started before the hold.
2K.2.3	██████	35 kV 1/0 AWG ACSR	446.7	10.7%	Slippage started before the hold.

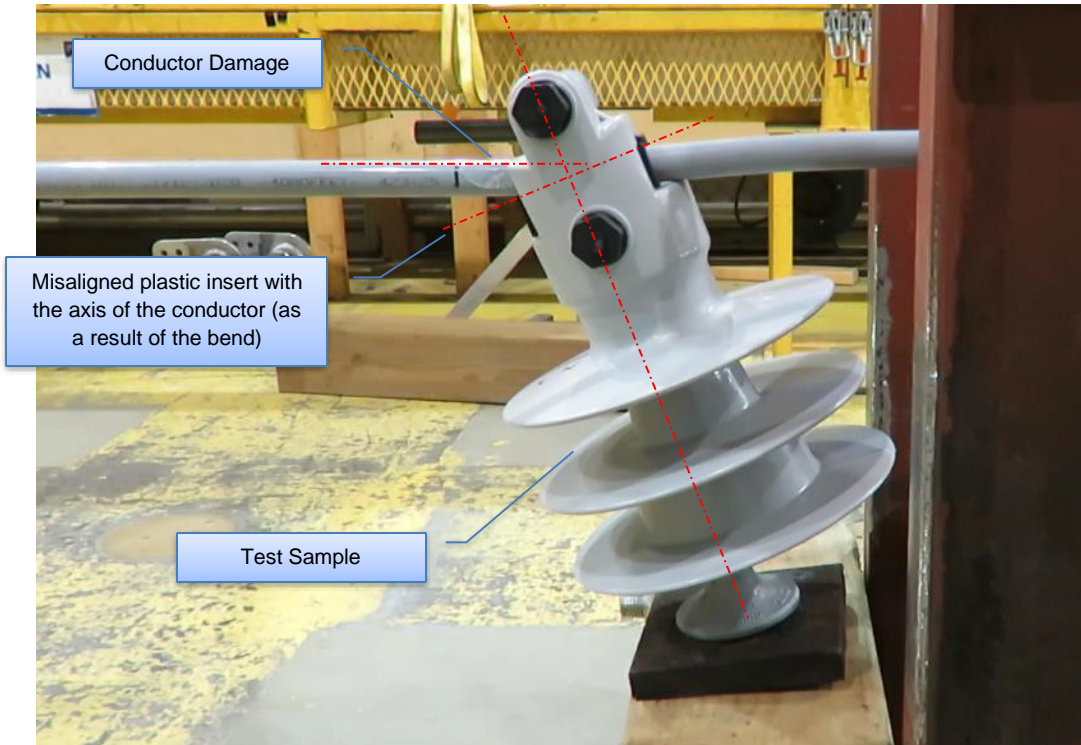

Figure 6-1: [REDACTED] - Typical Clamp and 1/0 AWG (17 kV) ACSR Conductor Position after Slip Test

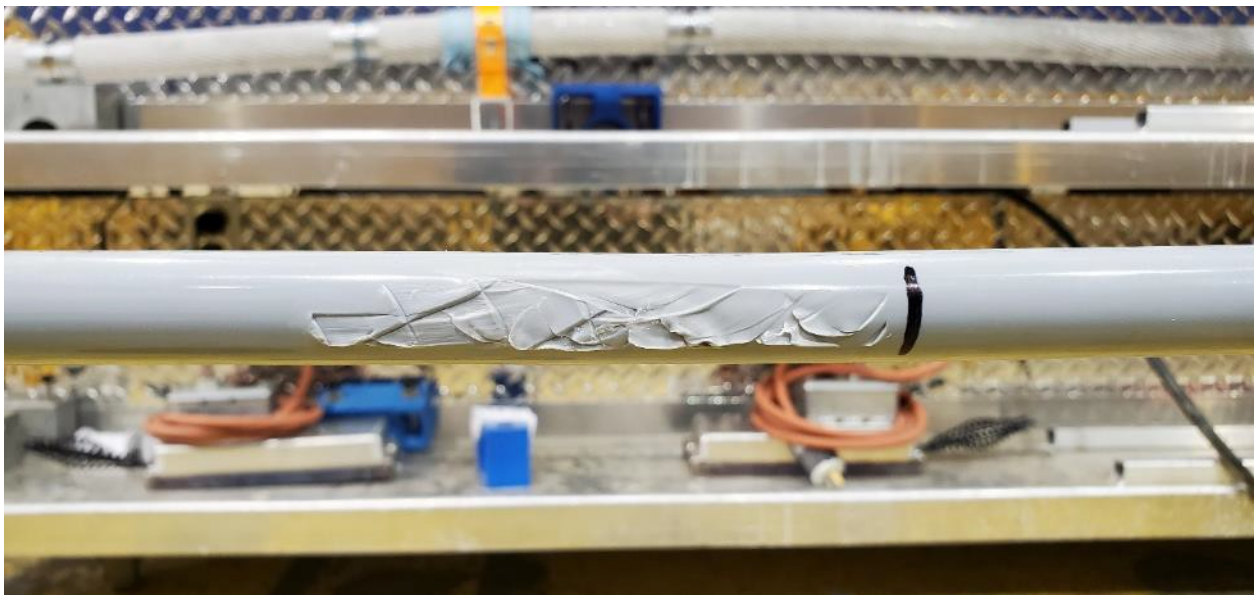

Figure 6-2: [REDACTED] - Typical 1/0 AWG (17 kV) ACSR Conductor Condition after Slip Test

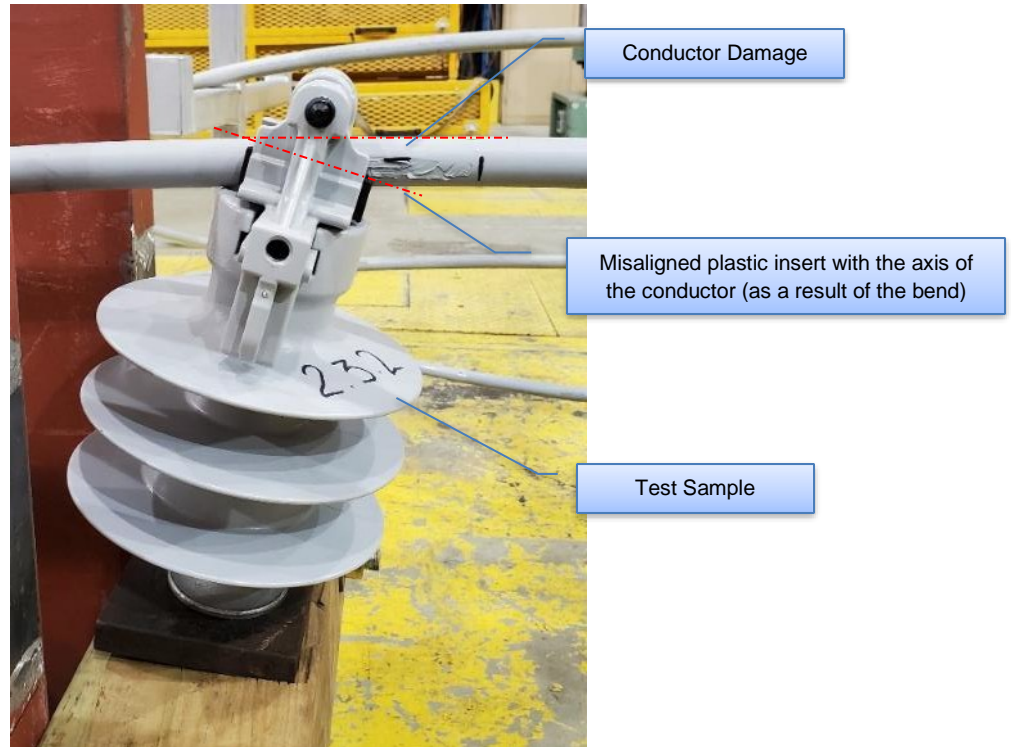

Figure 6-3: [REDACTED] - Typical Clamp and 397.5 kcmil (22 kV) AAC Conductor Position after Slip Test



Figure 6-4: [REDACTED] - Typical 397.5 kcmil (22 kV) AAC Conductor Condition after Slip Test



Figure 6-5: [REDACTED] - Typical Bend in Insulator Pin after Slip Test

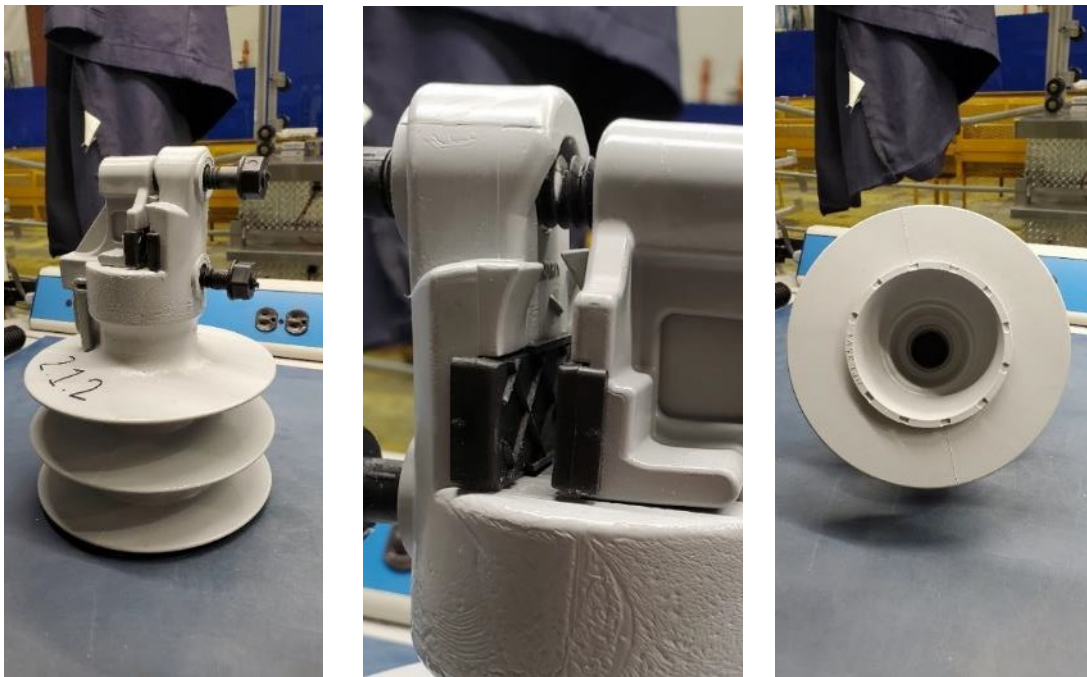

Figure 6-6: [REDACTED] - Typical Insulator Condition after Slip Test (no damage)

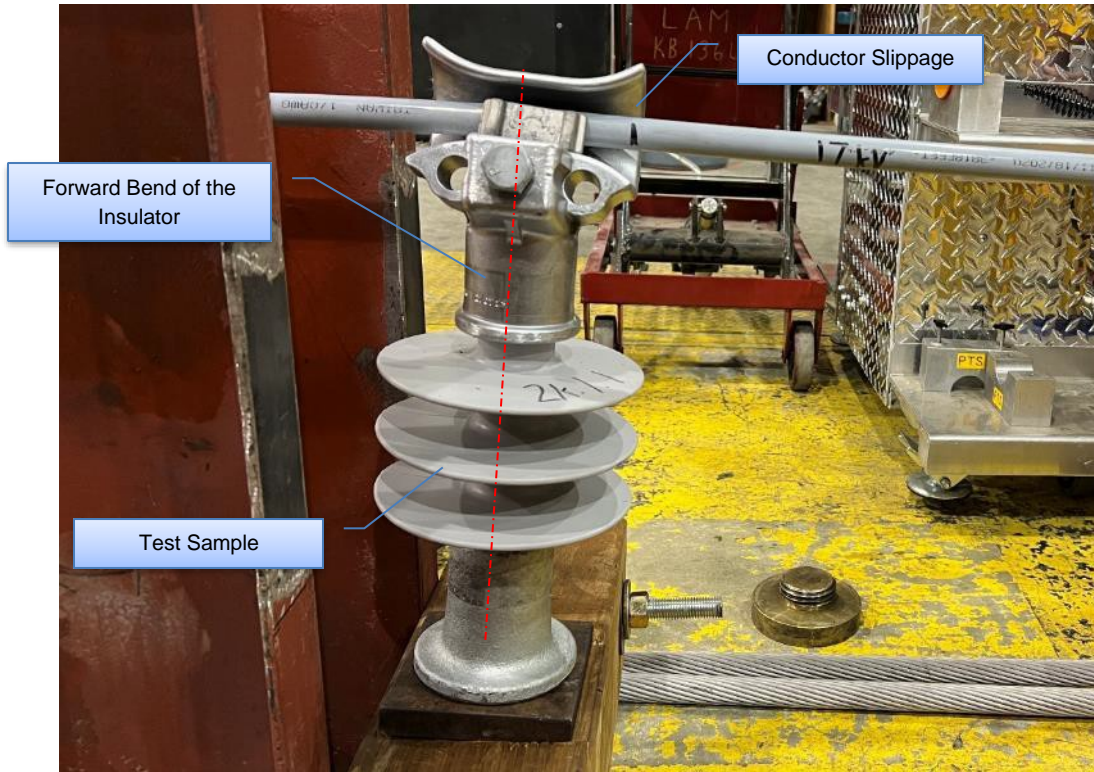

Figure 6-7: [REDACTED] - Typical Clamp and 1/0 AWG ACSR (17 kV) Conductor Position after Slip Test



Figure 6-8: [REDACTED] - Typical 1/0 AWG ACSR (17 kV) Conductor Condition after Slip Test

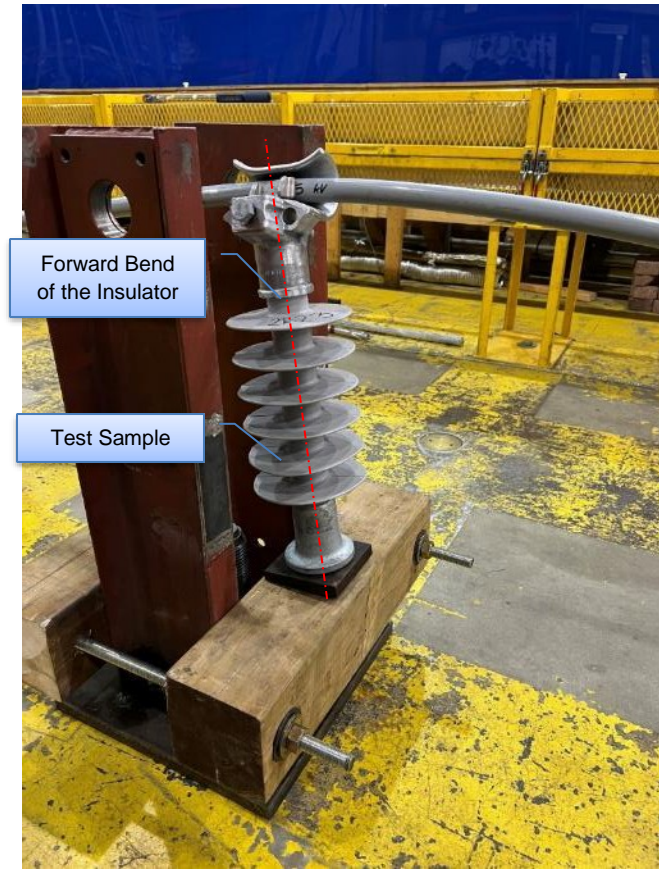

Figure 6-9: [REDACTED] - Typical Clamp and 1/0 AWG ACSR (35 kV) Conductor Position after Slip Test



Figure 6-10: [REDACTED] - Typical 1/0 AWG ACSR (35 kV) Conductor Condition after Slip Test



Figure 6-11: [REDACTED] - Typical Insulator and Pin Condition after Slip Test (no damage)

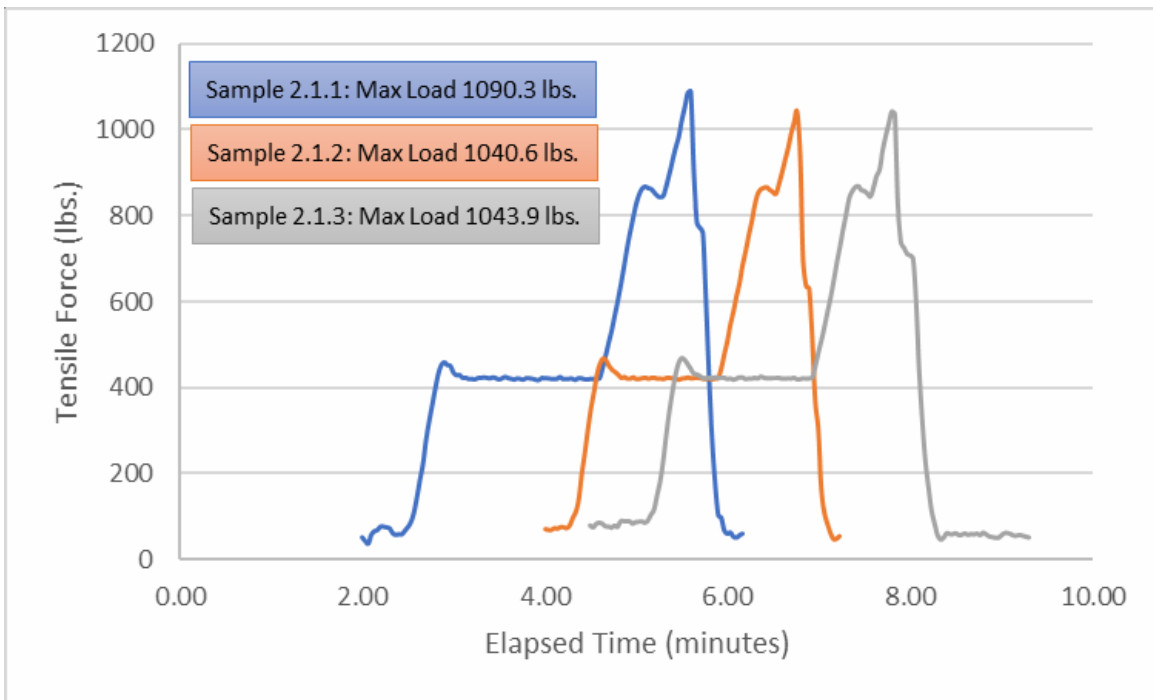

Figure 6-12: Slip Load Test – 17kV, 1/0 AWG ACSR with [REDACTED]

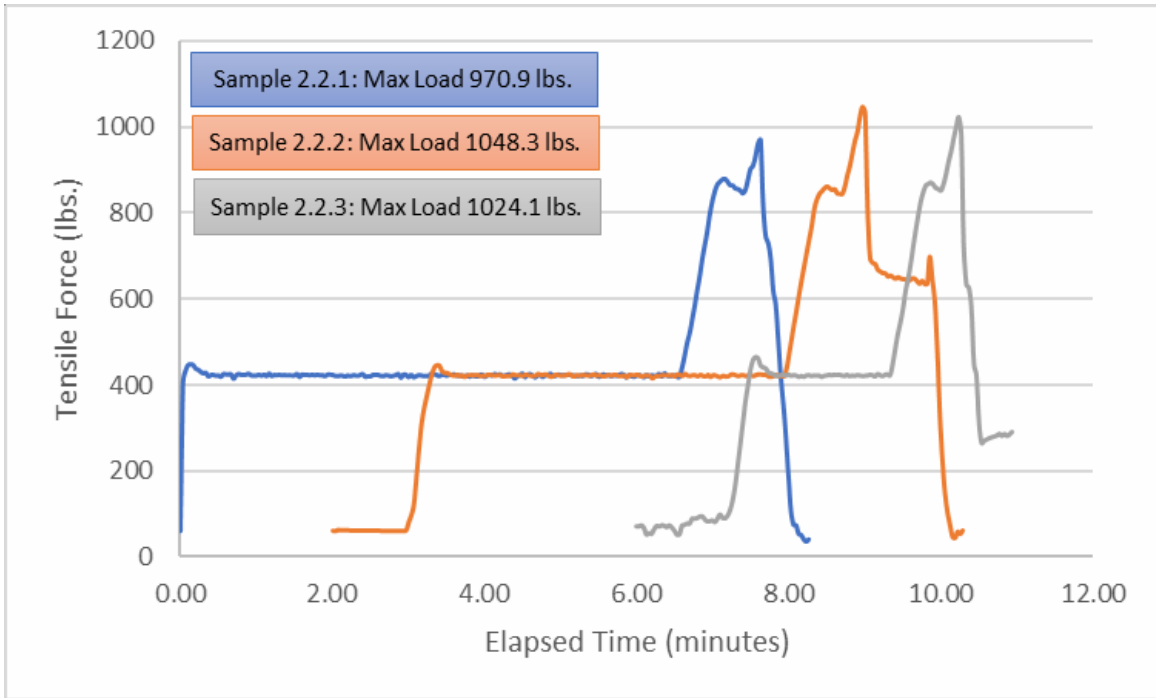

Figure 6-13: Slip Load Test – 35kV, 1/0 AWG ACSR with [REDACTED]

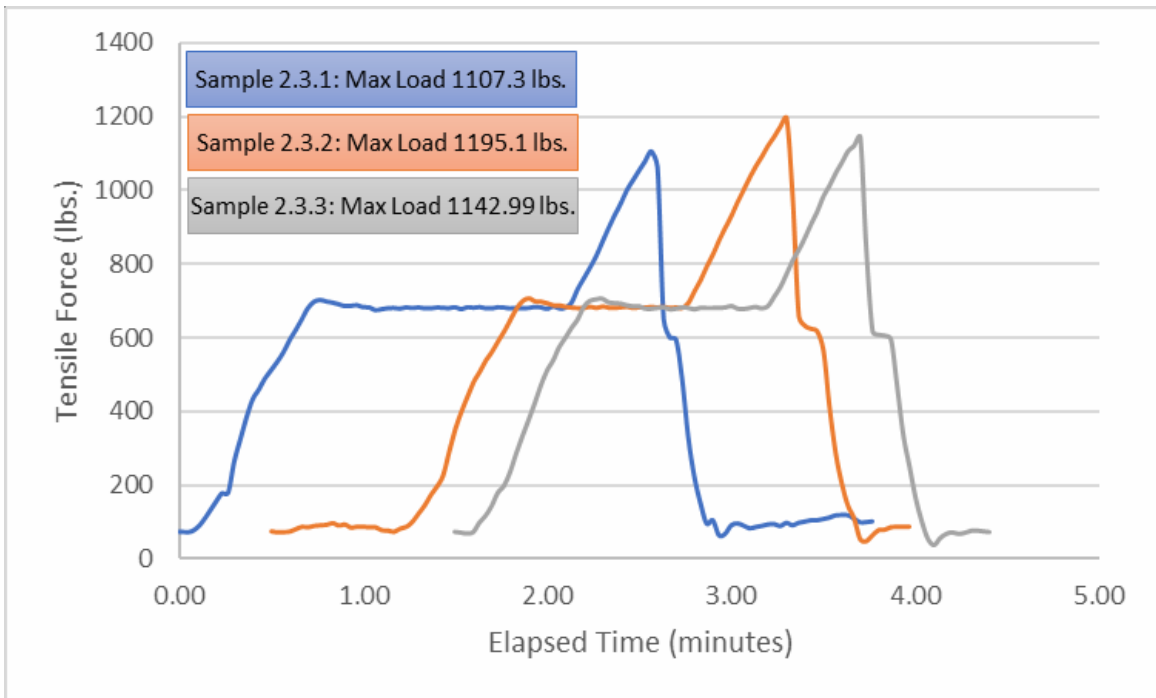

Figure 6-14: Slip Load Test – 22kV, 397.5 kcmil AAC with [REDACTED]

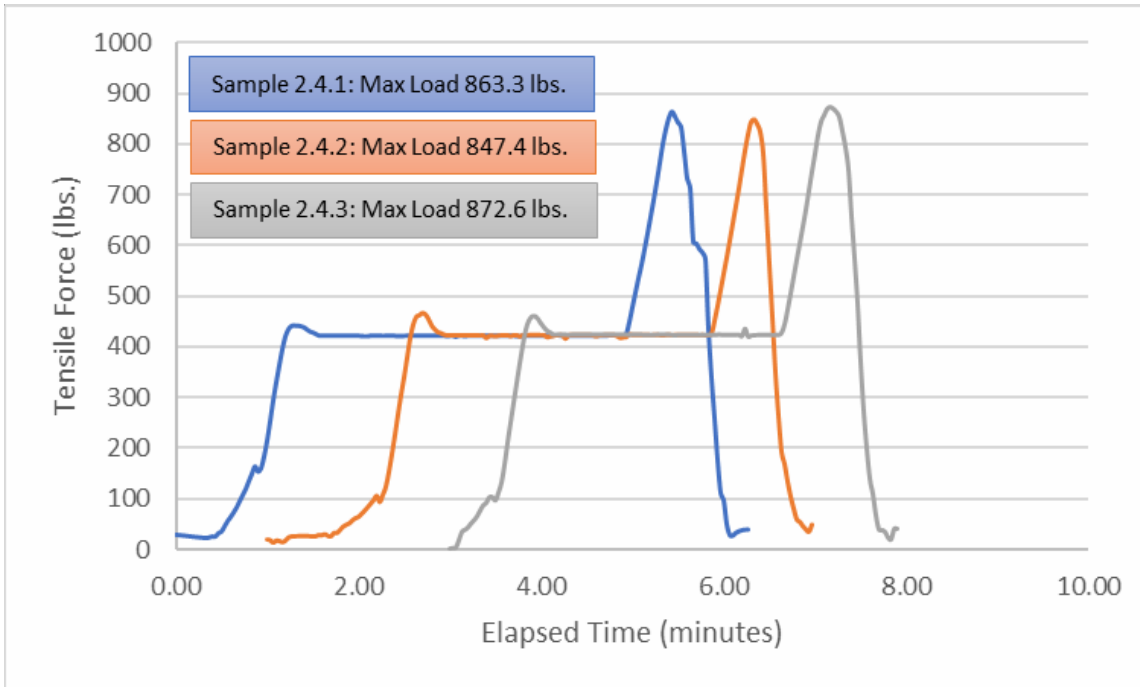

Figure 6-15: Slip Load Test – 15kV, 1/0 AWG ACSR with [REDACTED]

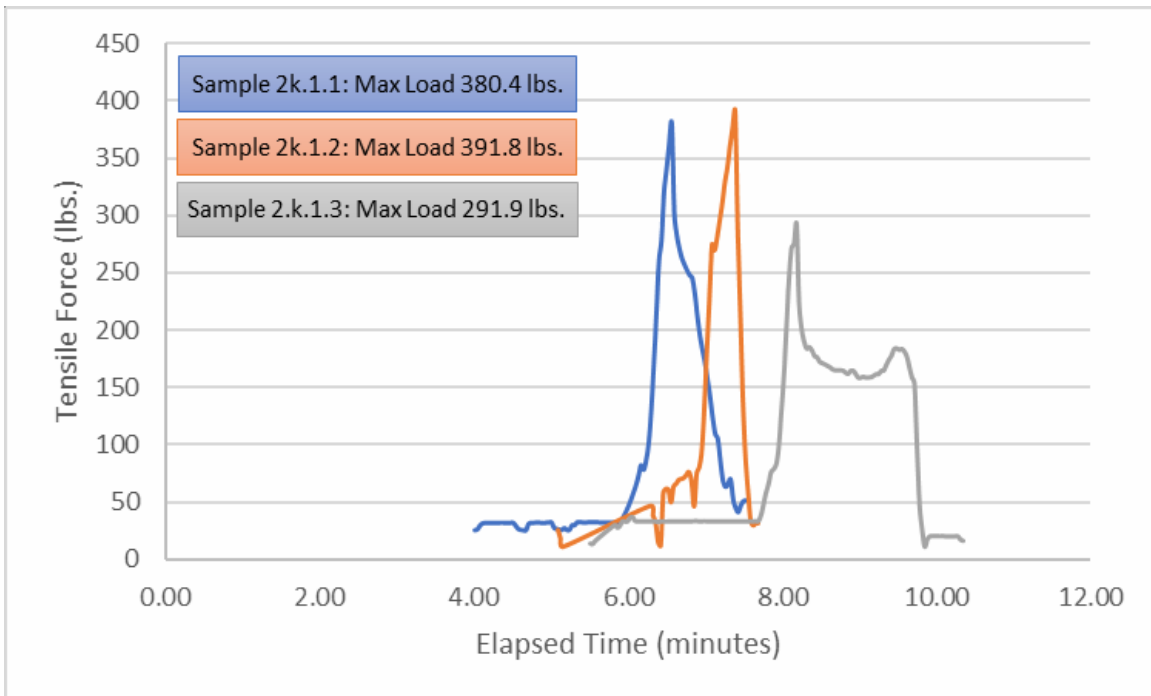

Figure 6-16: Slip Load Test – 17kV, 1/0 AWG ACSR with [REDACTED]

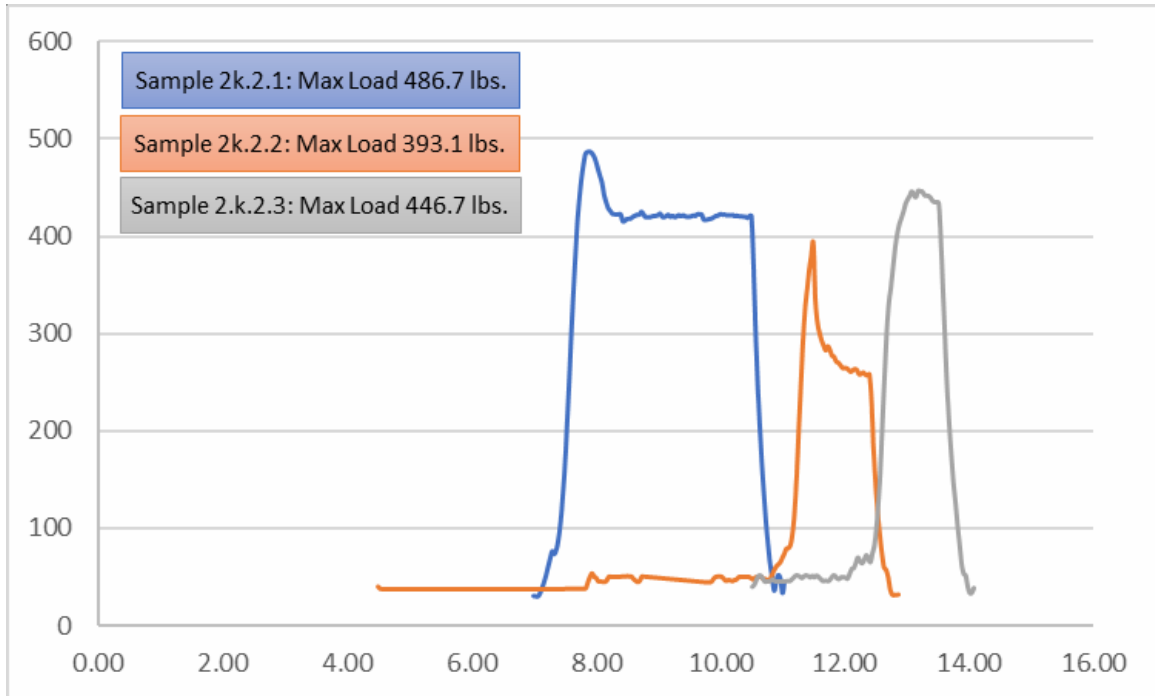

Figure 6-17: Slip Load Test – 35kV, 1/0 AWG ACSR with [REDACTED]

7 Acceptance Criteria

There were no acceptance criteria provided by the client. The objective of the test program was to determine the tensile load which resulted in conductor slippage relative to the clamp of a [REDACTED] Vise Top pin insulator or [REDACTED] Clamp Top post insulator.

8 Conclusion

When testing with [REDACTED] Vise Top insulators, the slip mechanism was the same for all samples: the slip occurred as a result of the insulator bending, causing the conductor to come off the plastic inserts in the insulator clamp. It is notable that all samples performed consistently around 1000 lb, regardless of the thickness of the insulation or conductor size.

When testing with [REDACTED] Clamp top insulators, the holding strength of the clamp was significantly lower than that of the [REDACTED] Vise Top insulator when installed on the same conductor. It is notable that when testing with the 35 kV 1/0 AWG conductor, the test samples performed better than when testing with 17 kV 1/0 AWG, suggesting that the thickness of the insulation could affect the results of the test.

Appendix A Acronyms and Abbreviations

AAC	- All Aluminum Conductor
ACSR	- Aluminum Conductor Steel Reinforced
ANSI	- The American National Standards Institute
AWG	- American Wire Gauge
Cat. ID.	- Catalogue Identification
ISO	- International Organization for Standardization
RTS	- Rated Tensile Strength
XLPE	- Crosslinked Polyethylene

[The remainder of this page is intentionally left blank.]

Appendix B Conductor Data Sheet (as provided by Exponent)

Covered Conductor Data Sheet

Covered Conductor for 17kV and 35kV

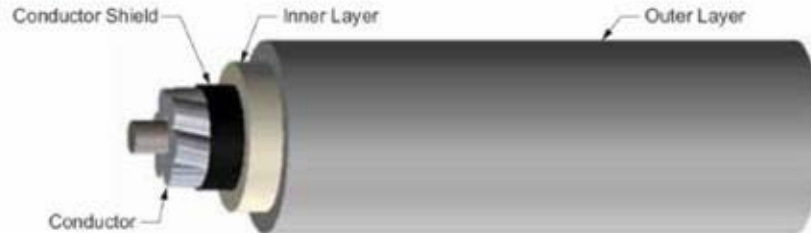

- Conductor:
 - Aluminum Conductor Steel-Reinforced (ACSR) or
 - Hard Drawn Copper (HDCU)
- Conductor Shield: Semiconducting Thermoset Polymer
- Inner Layer: Crosslinked Low Density Polyethylene (XL-LDPE)
- Outer Layer: Crosslinked High Density Polyethylene (XL-HDPE)
 - Track Resistant
 - Abrasion Resistant

Temperature Rating:

Normal Operating Temperature: 90°C

Emergency Operating Temperature: 130°C

Short Circuit Temperature: 250°C

17kV Covered Conductor

ACSR

Conductor Size (AWG)	Conductor Type (Stranding)	Weight (lb/ft)	Conductor Diameter (in)	Conductor Shield Thickness (in)	Inner Layer Thickness (in)	Outer Layer Thickness (in)	Max Nominal Overall Diameter (in)	Maximum Rated Strength (lb.)	Ampacity per Conductor ¹ (Amps)
1/0	ACSR (6x1)	0.289	0.398	0.015 - 0.025	0.075	0.075	0.748	4,160	271
336.4	ACSR (18x1)	0.584	0.684	0.015 - 0.025	0.075	0.075	1.034	8,246	550
336.4	ACSR (30/7)	0.750	0.741	0.015 - 0.025	0.075	0.075	1.091	16,435	561
653.9	ACSR (18x3)	0.998	0.953	0.020 - 0.025	0.080	0.080	1.323	14,060	835

¹ Covered Conductor Cable Normal Operating Rating Criteria:

Ambient Temperature = 40°C

Conductor Temperature = 90°C

Load Factor = 100%

Wind Speed = 4 ft/sec

Coefficient of Emissivity = 0.5

Coefficient of Absorption = 0.5

Latitude = 34°

Elevation of Conductor above Sea Level = 0 ft

Atmosphere = Clear

Local Sun Time = 1:00 pm

Figure C - 1: [REDACTED] 17 kV 1/0 AWG ACSR Conductor Data

35kV Covered Conductor

ACSR

Conductor Size (AWG)	Conductor Type (Stranding)	Weight (lb/ft)	Conductor Diameter (in)	Conductor Shield Thickness (in)	Inner Layer Thickness (in)	Outer Layer Thickness (in)	Max Nominal Overall Diameter (in)	Maximum Rated Strength (lb.)	Ampacity per Conductor ¹ (Amps)
1/0	ACSR (6x1)	0.460	0.398	0.015 - 0.025	0.175	0.125	1.048	4,160	255
336.4	ACSR (18x1)	0.850	0.684	0.015 - 0.025	0.175	0.125	1.334	8,246	518
336.4	ACSR (30x7)	0.981	0.741	0.015 - 0.025	0.175	0.125	1.391	16,435	529
653.9	ACSR (18x3)	1.242	0.953	0.020 - 0.025	0.175	0.125	1.602	14,060	784

¹ Covered Conductor Cable Normal Operating Rating Criteria:

- Ambient Temperature = 40°C
- Conductor Temperature = 90°C
- Load Factor = 100%
- Wind Speed = 4 ft/sec
- Coefficient of Emissivity = 0.5
- Coefficient of Absorption = 0.5
- Latitude = 34°
- Elevation of Conductor above Sea Level = 0 ft
- Atmosphere = Clear
- Local Sun Time = 1:00 pm

Specifications

Must be manufactured to the latest editions of the following standards:

- ASTM B8
- ASTM B232
- ICEA S-121-733

Figure C - 2: XXXXXXXXXX 35 kV 1/0 AWG ACSR Conductor Data

Appendix C Insulator Data Sheet

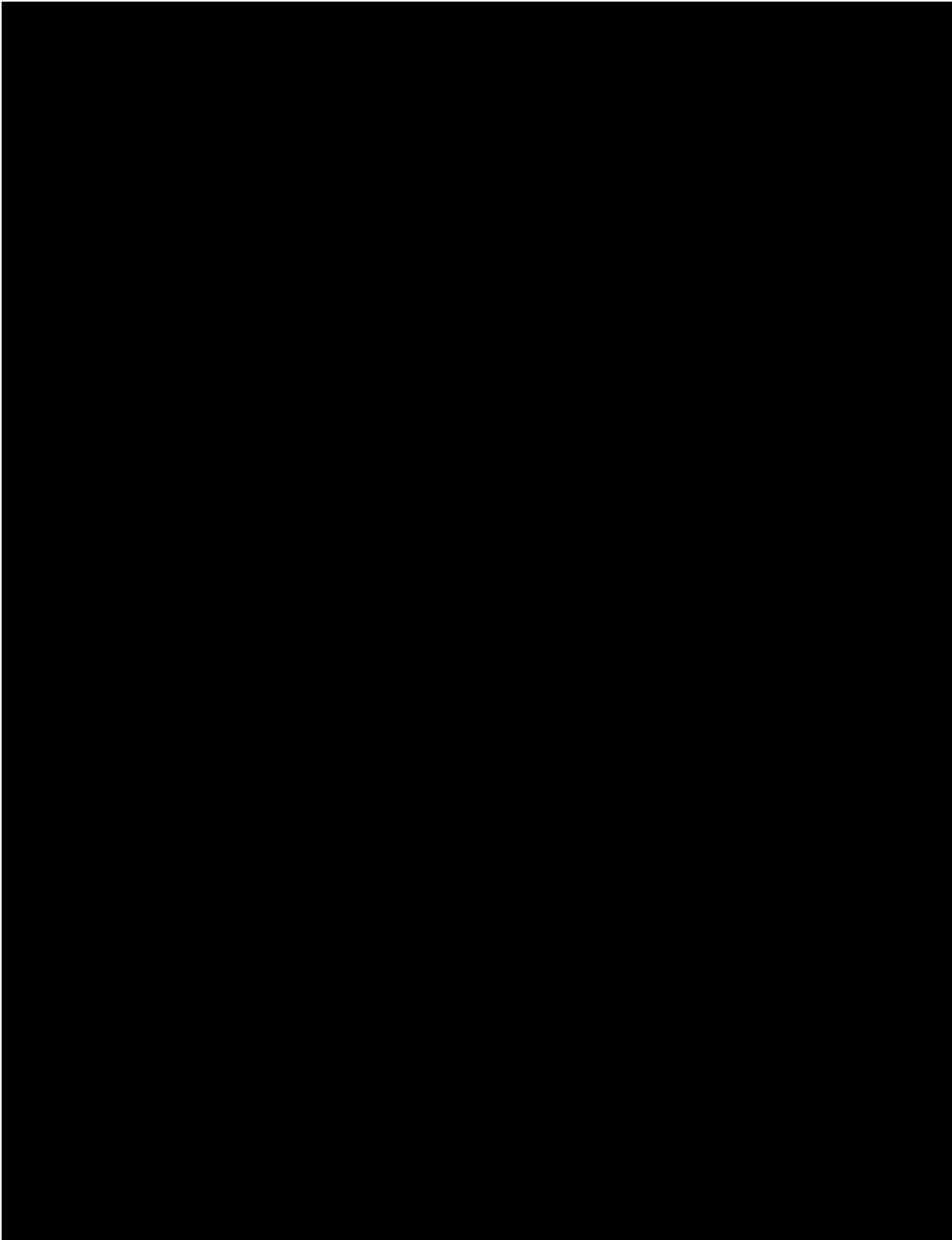

Figure D 1: [REDACTED] 35 kV Insulator [REDACTED]

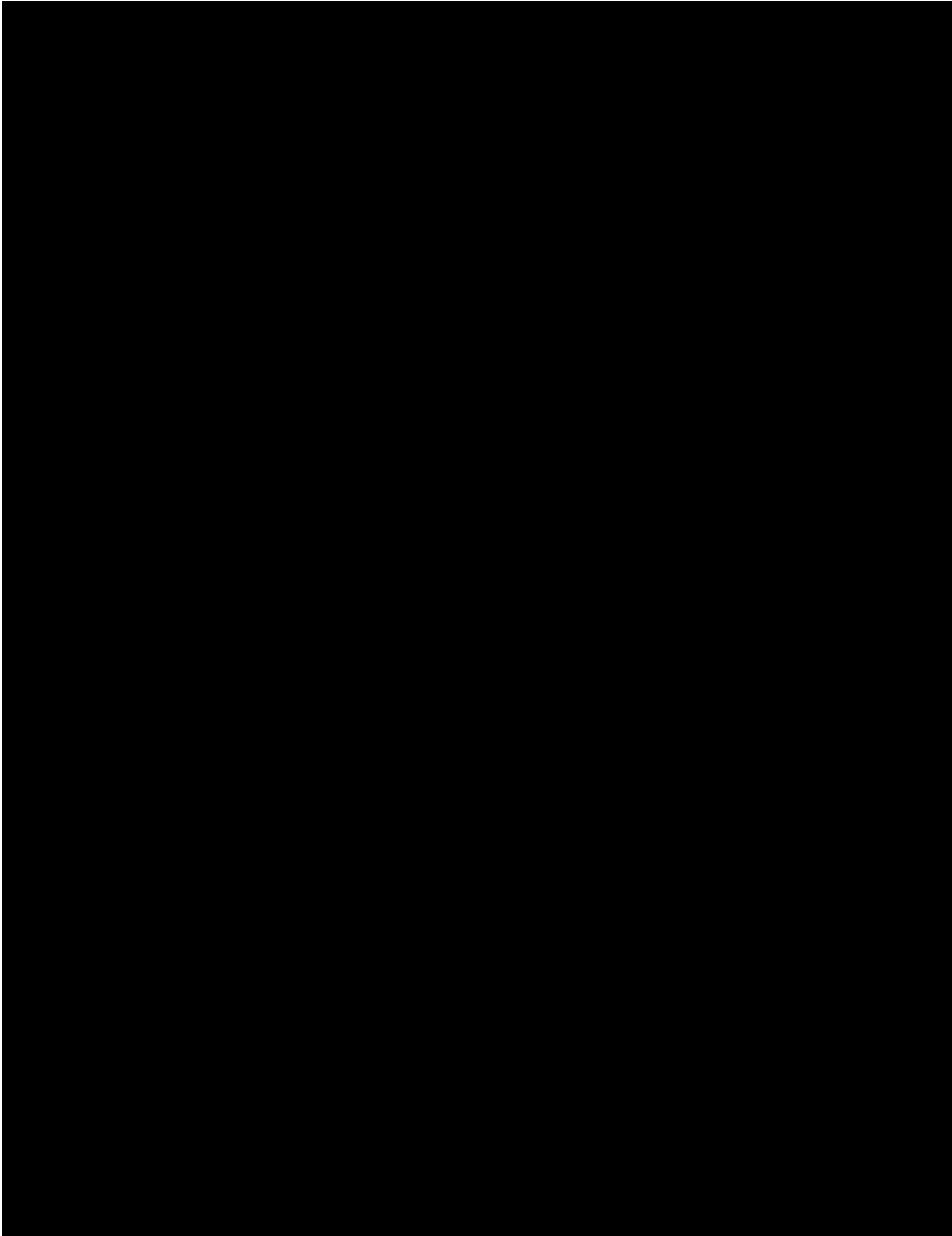

Figure D 2: [REDACTED] Post Insulators [REDACTED] and [REDACTED]



Appendix D Instrument Sheet

EQUIPMENT DESCRIPTION	ASSET No.	ACCURACY CLAIMED	CALIBRATION DATE	CALIBRATION DUE DATE	TEST USE
Data Logger	KIN-01836	±0.1% of Reading	May 20, 2021 May 27, 2022	May 20, 2022 May 27, 2023	Data acquisition
Load Cell/ Conditioner	KIN-01725/ KIN-01724	±1% of Reading	October 26, 2021	October 26, 2022	Load
Tape Measure	KIN-06890	< 0.05% of Reading	June 8, 2021 Jun 29, 2022	June 8, 2022 Jun 29, 2023	Length
Thermocouple/ Transmitter	KIN-00918/ KIN-00919	± 1 °C	October 28, 2021/ October 21, 2021	October 28, 2022/ October 21, 2022	Ambient Temperature

[The remainder of this page is intentionally left blank.]

Appendix E Kinectrics ISO 9001 Certificate of Registration



 **CERTIFICATE OF REGISTRATION**

This is to certify that
Kinectrics Inc.
Kinectrics North America Inc., Kinectrics International Europe ApS or Kinectrics International Inc.
800 Kipling Avenue, Unit 2, Toronto, Ontario M8Z 5G5 Canada

Refer to Attachment to Certificate of Registration dated November 5, 2021 for additional certified sites
operates a
Quality Management System
which complies with the requirements of
ISO 9001:2015
for the following scope of certification
This registration covers the Quality Management System for engineering, consulting, design, testing, project management, research, software development, assessments, operations support, and analysis within our facilities, and at field sites, for customers in the electricity industry and related energy sectors; both nuclear and conventional; as well as processing of radiological and conventional laundry and manufacture, inspection, and repair of personal protection equipment.

Certificate No.:	CERT-0119296	Original Certification Date:	July 7, 1998
File No.:	006555	Certification Effective Date:	May 23, 2021
Issue Date:	November 5, 2021	Certification Expiry Date:	May 22, 2024

Frank Camasta
Global Head of Technical Services
SAI Global Assurance

Registered by:
QMI-SAI Canada Limited (SAI Global), 20 Carlson Court, Suite 200, Toronto, Ontario M9W 7Y5 Canada. This registration is subject to the SAI Global Terms and Conditions for Certification. While all due care and skill was exercised in carrying out this assessment, SAI Global accepts responsibility only for gross negligence. This certificate remains the property of SAI Global and must be returned to them upon request.
To verify that this certificate is current, please refer to the SAI Global On-Line Certification Register:
https://www.sai-global.com/en-us/assurance/auditing_and_certification/certification_register/





Appendix F Distribution

Mr. Matt Bowers, Ph.D., P.E.

Exponent
17000 Science Drive, Suite 200
Bowie, Maryland 20715
Email: mbowers@exponent.com

Mr. Genti Gorja

Kinectrics AES Inc.
800 Kipling Ave, Unit No.2
Toronto, ON
Canada M8Z 5G5

Email: genti.gorja@kinectrics.com

[The remainder of this page is intentionally left blank.]



NOTE: Component manufacturer information has been redacted from this report

FULL MOCK-UP TEST ON COVERED CONDUCTORS & INSULATORS INSTALLED ON FIBERGLASS CROSS-ARM

K-580740-RP-003 R00

Prepared for

Exponent

Purchase Order No. 00062928

<p>Prepared by</p> <p> Digitally signed by GORJA Genti Date: 2022.10.03 14:24:16 -04'00'</p> <p><i>Signature & Date</i></p> <p>Genti Gorja P.Eng. Principal Engineer Line Asset Management</p>	<p>Reviewed by</p> <p> Digitally signed by André Maurice Date: 2022.10.03 14:31:13 -04'00'</p> <p><i>Signature & Date</i></p> <p>André Maurice Service Line Manager Line Asset Management</p>	<p>Approved by</p> <p>PETER Zsolt  Digitally signed by PETER Zsolt Date: 2022.10.03 14:59:09 -04'00'</p> <p><i>Signature & Date</i></p> <p>Zsolt Peter Ph.D. Business Area Director Line Asset Management</p>
---	--	---

Revision History

Rev 00	Description: Original issue			
	Issue Date: 2022-09-28	Prepared by: Genti Gorja	Reviewed by: André Maurice	Approved by: Zsolt Peter

DISCLAIMER

Kinectrics prepared this report as a work of authorship sponsored by their client. This report has been prepared solely for the benefit of the Client and may not be used or relied upon in whole or in part by any other person or entity without Client permission or without Kinectrics' permission if required by the Contract between Client and Kinectrics Inc . Neither Kinectrics, their client nor any person acting on behalf of them: (a) makes any warranty or representation whatsoever, express or implied, or assumes any legal liability of responsibility for any third party's use, or the results of such use, with respect to (i) the use of any information, apparatus, method, process, or similar item disclosed in this report including the merchantability or fitness for any particular purpose of any information contained in this report or the respective works or services supplied or performed or (ii) that such use does not infringe on or interfere with privately owned rights, including any party's intellectual property; or (b) assumes responsibility for any damages or other liability whatsoever (including any consequential damages resulting from a third party's selection or use of this report or any information, apparatus, method, process, or similar item disclosed.

Copyright © Kinectrics Inc. 2022. All rights reserved.



Table of Contents

1	Executive Summary	4
2	Test Objective and Test Standard	5
3	Test Sample.....	5
4	Test Setup	6
5	Test Procedure	7
6	Test Results.....	7
7	Acceptance Criteria.....	32
8	Conclusion	32
Appendix A	Acronyms and Abbreviations	33
Appendix B	Conductor Data Sheet (<i>as provided by the client</i>).....	34
Appendix C	Insulator Datasheet	36
Appendix D	Dead-End Bolted Clamps used in the test	38
Appendix E	Instrument Sheet.....	40
Appendix F	Kinectrics ISO 9001 Certificate of Registration	41
Appendix G	Distribution	42

1 Executive Summary

This report describes the “Full Mock-Up” Test performed on [redacted] Vise Top pin insulator (model [redacted]) and [redacted] Clamp Top post insulator (model [redacted] and [redacted]). The “Full Mock-Up” Test program was conducted for Exponent™ to evaluate the performance of [redacted] and [redacted] post insulators, installed on fiberglass crossarm, when used with:

- 15 kV 1/0 AWG, ACSR covered conductor
- 17 kV 1/0 AWG, ACSR covered conductor
- 35 kV 1/0 AWG, ACSR covered conductor and
- 22 kV 397.5 kcmil, AAC covered conductor.

Exponent™ supplied samples and accessories required for testing. Kinectrics received all samples, in good condition, on May 2, 2022. The test program and completion dates are summarized in Table 1-1.

Table 1-1: Test Program

Test ID	Sample ID	Conductor	Insulator Cat.ID.	Date Completed
3.1	3.1.1	17 kV 1/0 AWG ACSR	[redacted]	August 16, 2022
	3.1.2	17 kV 1/0 AWG ACSR	[redacted]	August 17, 2022
	3.1.3	17 kV 1/0 AWG ACSR	[redacted]	August 17, 2022
3.2	3.2.1	35 kV 1/0 AWG ACSR	[redacted]	August 17, 2022
	3.2.2	35 kV 1/0 AWG ACSR	[redacted]	August 17, 2022
	3.2.3	35 kV 1/0 AWG ACSR	[redacted]	August 18, 2022
3.3	3.3.1	22 kV 397.5 kcmil AAC	[redacted]	August 19, 2022
	3.3.2	22 kV 397.5 kcmil AAC	[redacted]	August 19, 2022
	3.3.3	22 kV 397.5 kcmil AAC	[redacted]	August 19, 2022
3.4	3.4.1	15 kV 1/0 AWG ACSR	[redacted]	August 18, 2022
	3.4.2	15 kV 1/0 AWG ACSR	[redacted]	August 18, 2022
	3.4.3	15 kV 1/0 AWG ACSR	[redacted]	August 18, 2022
3k.1	3k.1.1	17 kV 1/0 AWG ACSR	[redacted]	August 18, 2022
	3k.1.2	17 kV 1/0 AWG ACSR	[redacted]	August 18, 2022
	3k.1.3	17 kV 1/0 AWG ACSR	[redacted]	August 18, 2022
3k.2	3k.2.1	35 kV 1/0 AWG ACSR	[redacted]	August 18, 2022
	3k.2.2	35 kV 1/0 AWG ACSR	[redacted]	August 18, 2022
	3k.2.3	35 kV 1/0 AWG ACSR	[redacted]	August 18, 2022

The tests were conducted in accordance with Exponent™ requirements as outlined in the relevant sections of this document. The tests were performed by Kinectrics personnel at 800 Kipling Avenue, Toronto, Ontario, M8Z 5G5, Canada. The work was conducted under Exponent™ Purchase Order No. 00062928 dated January 14, 2022.

The tests were performed under Kinectrics’ ISO 9001 Quality Management System. A copy of ISO 9001 Certificate of Registration is included in Appendix F.

2 Test Objective and Test Standard

The Full Mock-up Test was intended to simulate mechanical loading in the event of a tree falling on the line and evaluate its effect on components (conductor, insulator, cross arm). The test was performed in general accordance with the procedures requested by Exponent™.

3 Test Sample

Three (3) insulator samples were tested for each conductor. The test samples consisted of [REDACTED] Vise Top pin insulator, model [REDACTED] or [REDACTED] Clamp Top pin insulator mounted on a fiberglass tangent crossarm, as indicated in Table 3-1.

A 45 ft length of each conductor type was terminated with one dead-end for testing in conjunction with the corresponding insulator design. Data sheets for the conductors, insulators and bolted dead-ends used in this test are shown in Appendix B through Appendix D.

Table 3-1: Full Mock-up Test: Sample ID and Configuration

Sample No.	Test Sample (Insulator Cat. ID.)	Conductor Size (AWG or kcmil)	Dead-end
3.1.1	[REDACTED]	17 kV, 1/0 AWG ACSR	[REDACTED]
3.1.2	[REDACTED]		
3.1.3	[REDACTED]		
3.2.1	[REDACTED]	35 kV 1/0 AWG ACSR	[REDACTED]
3.2.2	[REDACTED]		
3.2.3	[REDACTED]		
3.3.1	[REDACTED]	22 kV 397.5 kcmil AAC	[REDACTED]
3.3.2	[REDACTED]		
3.3.3	[REDACTED]		
3.4.1	[REDACTED]	15 kV 1/0 AWG ACSR	[REDACTED]
3.4.2	[REDACTED]		
3.4.3	[REDACTED]		
3K.1.1	[REDACTED]	17 kV, 1/0 AWG ACSR	[REDACTED]
3K.1.2	[REDACTED]		
3K.1.3	[REDACTED]		
3K.2.1	[REDACTED]	35 kV, 1/0 AWG ACSR	[REDACTED]
3K.2.2	[REDACTED]		
3K.2.3	[REDACTED]		

4 Test Setup

The test was performed in a hydraulically-activated horizontal test machine. The conductor length, terminated with the dead-end fitting installed at one end, was used for all three (3) insulator clamps. A different section of conductor was used for testing each new insulator.

The insulator was setup vertically, mounted on the fiberglass cross-arm supplied by Exponent™. The insulator was aligned in the vertical plane with the pulling cylinder. The cross-arm was mounted on a pole section, which was firmly fixed on the floor.

A system of pulleys ensured that the conductor was at an angle coming off the insulator clamp. The deflection angle of the conductor at the pulley was approximately 35° toward the cylinder (South) and 40° toward the insulator clamp (North). A schematic of the test set-up is shown in Figure 4-1 and a picture of the actual setup is shown in Figure 4-2.

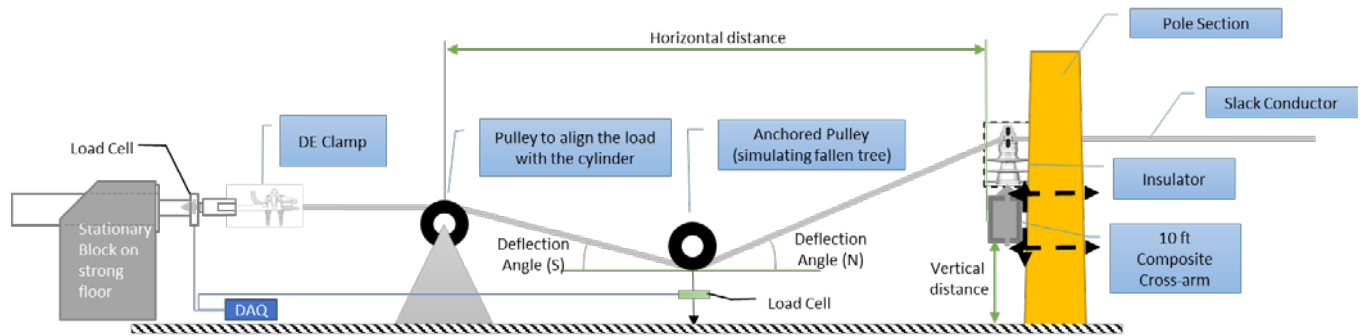

Figure 4-1: Full Mock-up Test - Schematic of the Setup

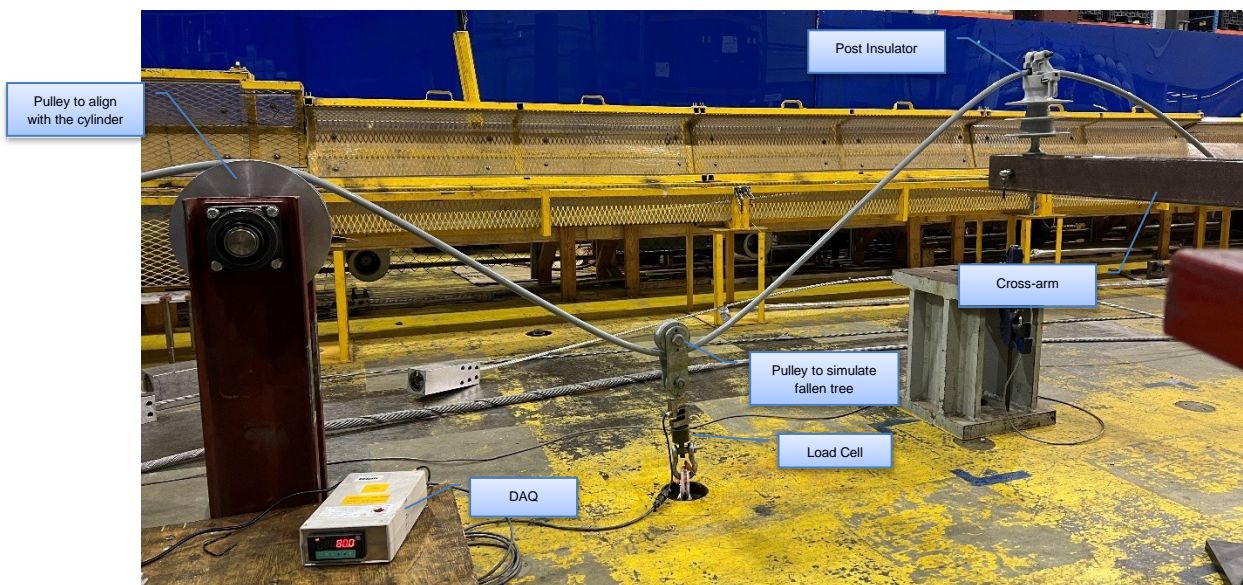

Figure 4-2: Full Mock-up Test - Picture of the Setup

The Full Mock-up Test was performed by increasing the horizontal tension until the vertical load on the pulley (simulating the fallen tree) reached 1,000 lb. The vertical load on the pulley was measured directly by attaching a load cell between the pulley and the floor. The vertical permanent deflection of both ends of the cross-arm was measured by referencing the vertical distance of the insulator attachment point on the cross-arm to the floor. The measurement of the vertical deflection on the side of the crossarm where the insulator was mounted (the force was applied) was labeled as “West” and the measurement on the opposite end of the crossarm was labeled as “East”. The data logging rate during the test was every one (1) second. The test was carried out in a temperature-controlled laboratory at $20\text{ }^{\circ}\text{C} \pm 2\text{ }^{\circ}\text{C}$.

5 Test Procedure

The Full Mock-up Test procedure was conducted as follows:

- The insulator/cross-arm and conductor assembly were setup as shown in Figure 4-2
- A small pretension value was applied (to remove the slack from the conductor) and the conductor was marked at the entry points in the clamp.
- The conductor tension was increased until the vertical load reached 1,000 lb on the pulley simulating the fallen tree. The conductor at the insulator clamp was visually monitored for slippage.
- The horizontal tensile load was continuously increased at a rate of 1,000 lb/min until damage to the cross-arm or slippage of the conductor inside the clamp occurred.

Upon completion of the test on the first sample, the same steps were repeated on a new insulator (second and third sample) on an unused section on the conductor (approx. 10 ft North of the first setup). A new cross-arm was installed in cases where the previous test resulted in damage. Video recordings of the tests were also provided for Exponent’s future reference.

6 Test Results

The load and conductor slippage during the test were monitored and recorded. Test results are summarized in Table 6-1 to Table 6-6. Loading profiles for each sample are shown in Figure 6-1 to Figure 6-6. Photos of the slippage and the sample after the test were taken for documentation purposes. Typical pictures of sample condition after the test are shown in Figure 6-7 through Figure 6-34. General observations from the test, common for all samples are provided below:

- When testing with [REDACTED] Vise Top insulators, the majority of test samples, achieved the target vertical load of 1,000 lb without slippage of the conductor at the clamp. There was no damage to the conductor (superficial marks only on the outer jacket), however there was damage on the fiberglass cross arm caused by the flange of the insulator pin.

- When testing with [REDACTED] Clamp Top insulators, the slippage in all samples occurred below the target vertical load of 1000 lb (and at a lower tensile load as compared to the [REDACTED] Vise Top when tested with the same conductor). There was no damage on the outer jacket of the conductor after the test and there was no damage observed on the fiberglass cross-arm after the test.

Table 6-1: Test Results: [REDACTED] and 17 kV 1/0 AWG ACSR

Sample No.	Max. Vertical Load	Vertical Deformation of Cross Arm		Comments (Observations)
	[lb]	West* [inch]	East** [inch]	
3.1.1	939.0	- 2.40	2.30	Cross-arm damaged under the flange of the insulator pin. No slippage at the clamp. No damage to conductor.
3.1.2	1095.0	- 3.00	2.64	No damage on the Cross-arm. No slippage at the clamp. No damage to conductor.
3.1.3	1042.0	- 2.36	2.28	Cross-arm damaged under the flange of the insulator pin. No slippage at the clamp. No damage to conductor.

(*) "West" references the downward deformation at the crossarm where the insulator was mounted

(**) "East" references the upward deformation at the free end of the crossarm, opposite to the side where the insulator was mounted

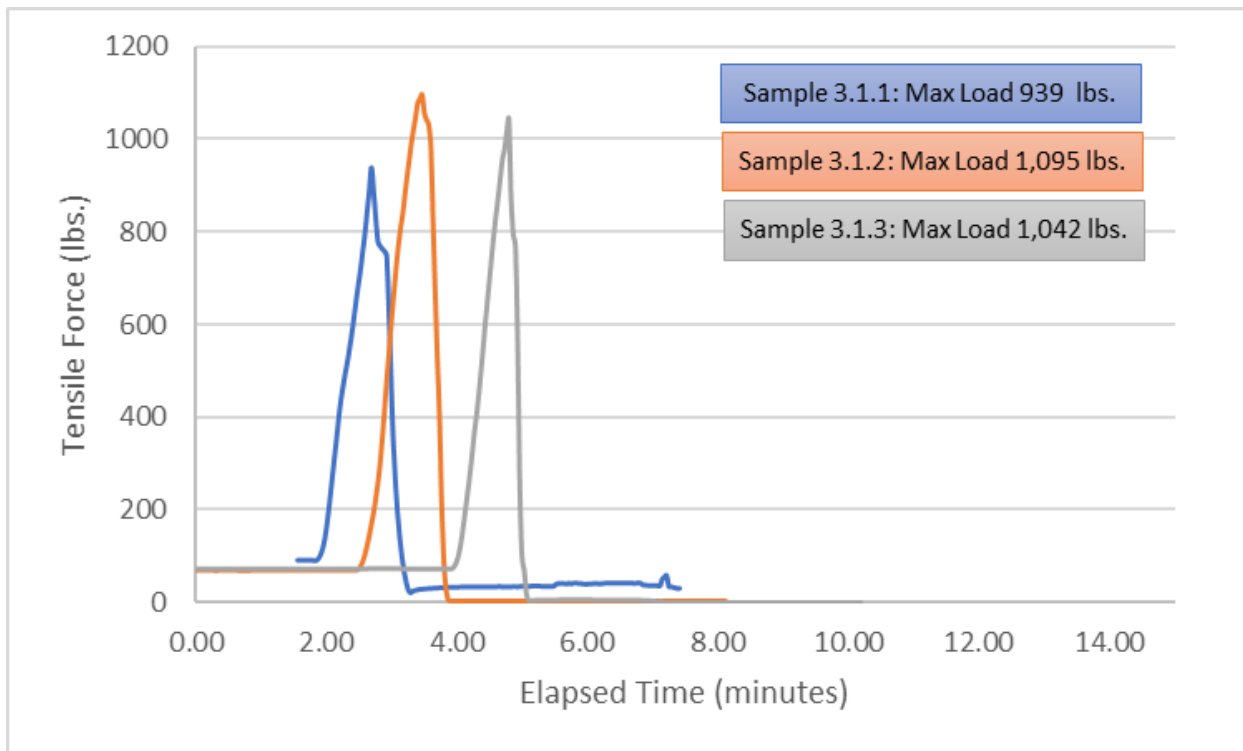

Figure 6-1: Test Load Profile: [REDACTED] and 17 kV 1/0 AWG ACSR

Table 6-2: Test Results: [REDACTED] and 35 kV 1/0 AWG ACSR

Sample No.	Max. Vertical Load	Vertical Deformation of Cross Arm		Comments (Observations)
	[lb]	West* [inch]	East** [inch]	
3.2.1	1063.0	- 1.97	1.65	Cross-arm damaged under the flange of the insulator pin. No slippage at the clamp. No damage to conductor.
3.2.2	985.0	- 2.04	1.97	Cross-arm damaged under the flange of the insulator pin. No slippage at the clamp. No damage to conductor.
3.2.3	1019.0	- 1.26	1.02	Cross-arm damaged under the flange of the insulator pin. No slippage at the clamp. No damage to conductor.

(*) "West" references the downward deformation at the crossarm where the insulator was mounted

(**) "East" references the upward deformation at the free end of the crossarm, opposite to the side where the insulator was mounted

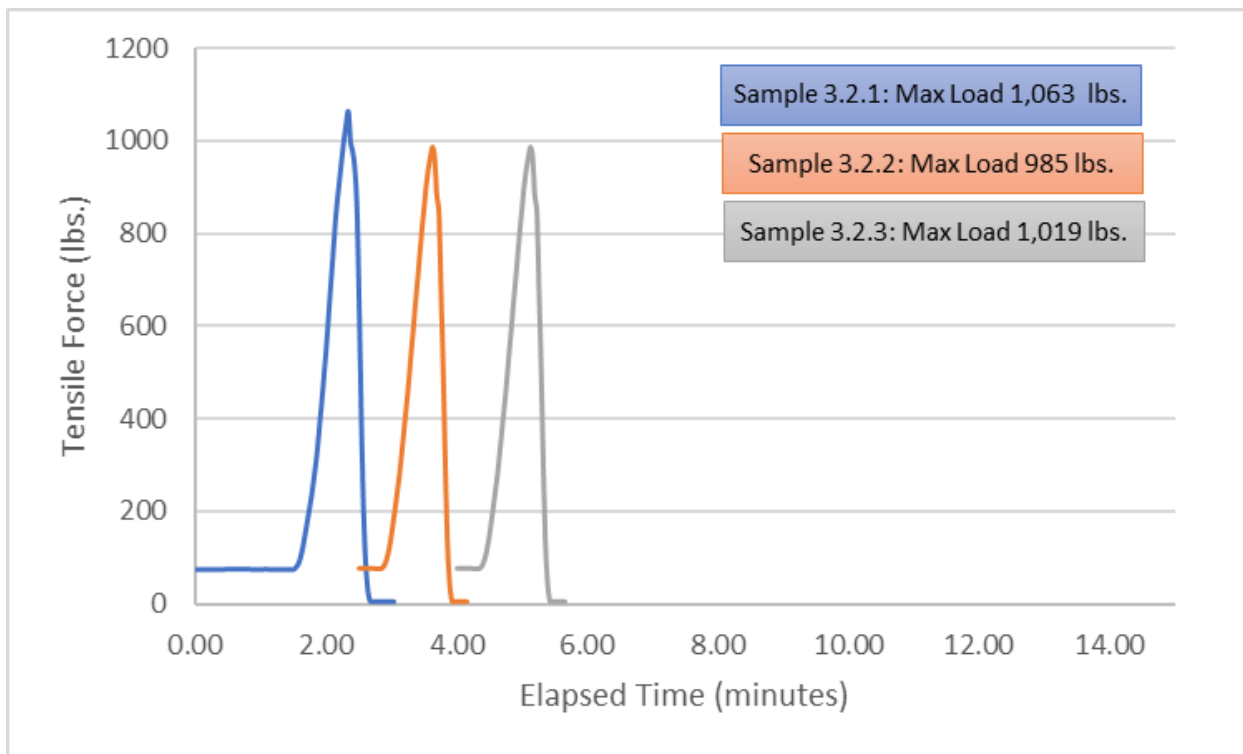

Figure 6-2: Test Load Profile: [REDACTED] and 35 kV 1/0 AWG ACSR

Table 6-3: Test Results: [REDACTED] and 22 kV 397.5 kcmil AAC

Sample No.	Max. Vertical Load	Vertical Deformation of Cross Arm		Comments (Observations)
	[lb]	West* [inch]	East** [inch]	
3.3.1	1326.0	- 1.93	1.57	Cross-arm damaged under the flange of the insulator pin. No slippage at the clamp. No damage to conductor.
3.3.2	1060.0	- 1.77	1.61	Cross-arm damaged under the flange of the insulator pin. No slippage at the clamp. No damage to conductor.
3.3.3	988.0	- 2.60	2.40	Cross-arm damaged under the flange of the insulator pin. No slippage at the clamp. No damage to conductor.

(*) "West" references the downward deformation at the crossarm where the insulator was mounted

(**) "East" references the upward deformation at the free end of the crossarm, opposite to the side where the insulator was mounted

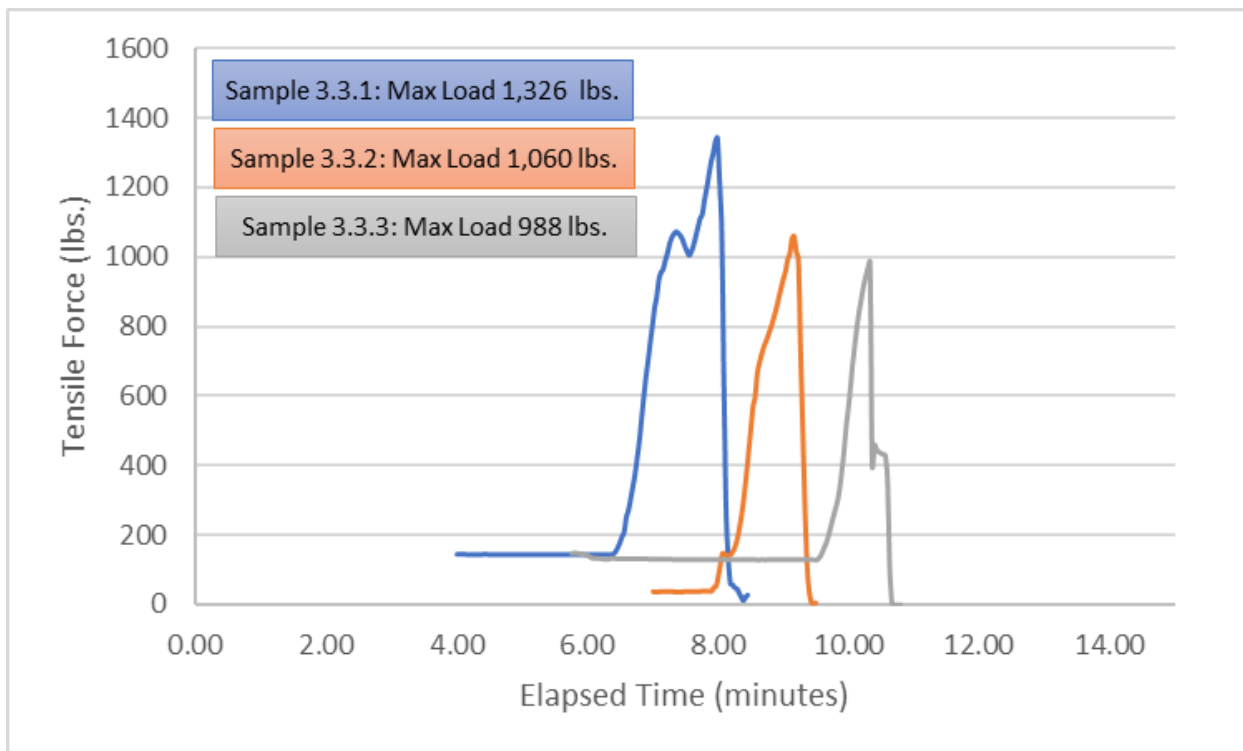

Figure 6-3: Test Load Profile: [REDACTED] and 22 kV 397.5 kcmil AAC

Table 6-4: Test Results: [REDACTED] and 15 kV 1/0 AWG ACSR

Sample No.	Max. Vertical Load	Vertical Deformation of Cross Arm		Comments (Observations)
	[lb]	West* [inch]	East** [inch]	
3.4.1	880.0	- 0.35	0.35	Cross-arm damaged under the flange of the insulator pin. No slippage at the clamp. No damage to conductor.
3.4.2	1090.0	- 2.00	1.46	Cross-arm damaged under the flange of the insulator pin. No slippage at the clamp. No damage to conductor.
3.4.3	789.0	- 1.54	1.42	Cross-arm damaged under the flange of the insulator pin. No slippage at the clamp. No damage to conductor.

(*) "West" references the downward deformation at the crossarm where the insulator was mounted

(**) "East" references the upward deformation at the free end of the crossarm, opposite to the side where the insulator was mounted

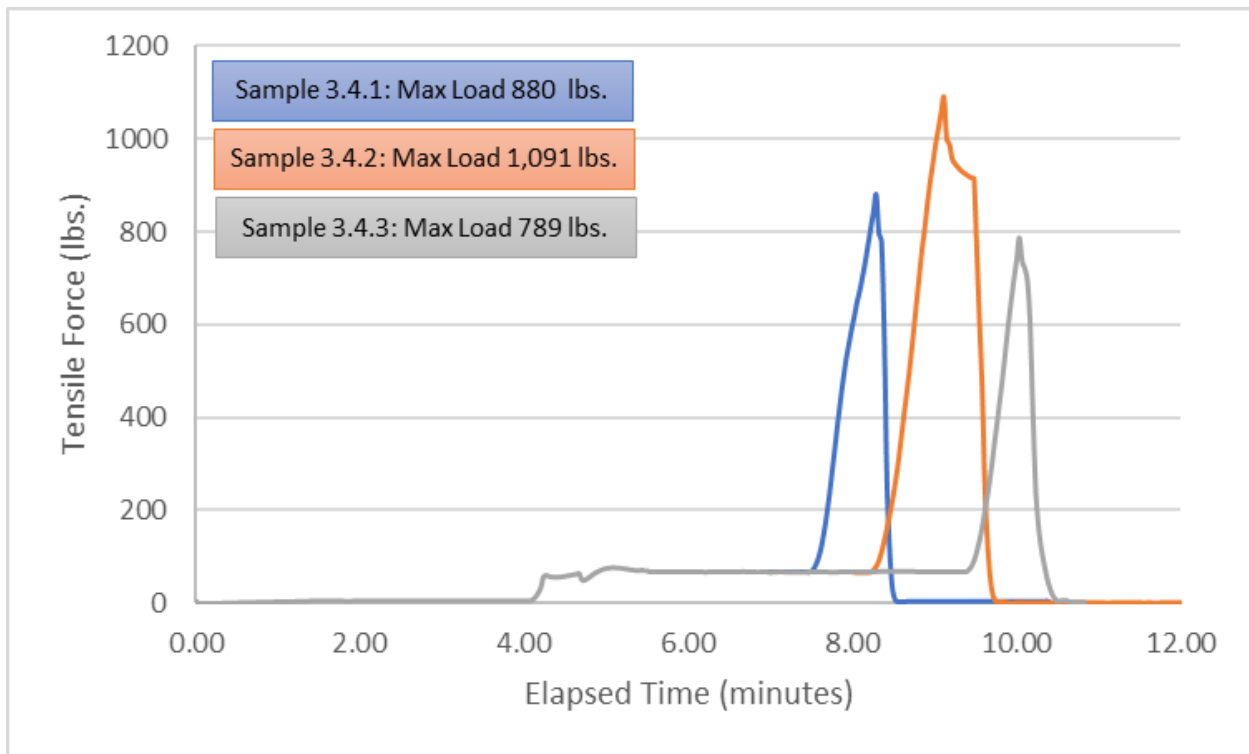

Figure 6-4: Test Load Profile: [REDACTED] and 15 kV 1/0 AWG ACSR

Table 6-5: Test Results: [REDACTED] and 17 kV 1/0 AWG ACSR

Sample No.	Max. Vertical Load	Vertical Deformation of Cross Arm		Comments (Observations)
	[lb]	West* [inch]	East** [inch]	
3K.1.1	573.0	- 1.57	1.57	Conductor slip at the clamp. No damage to the Cross-arm under the flange of the insulator pin. No damage to conductor
3K.1.2	396.0	- 0.24	0.24	Conductor slip at the clamp. No damage to the Cross-arm under the flange of the insulator pin. No damage to conductor
3K.1.3	508.0	- 0.20	0.12	Conductor slip at the clamp. No damage to the Cross-arm under the flange of the insulator pin. No damage to conductor.

(*) "West" references the downward deformation at the crossarm where the insulator was mounted

(**) "East" references the upward deformation at the free end of the crossarm, opposite to the side where the insulator was mounted

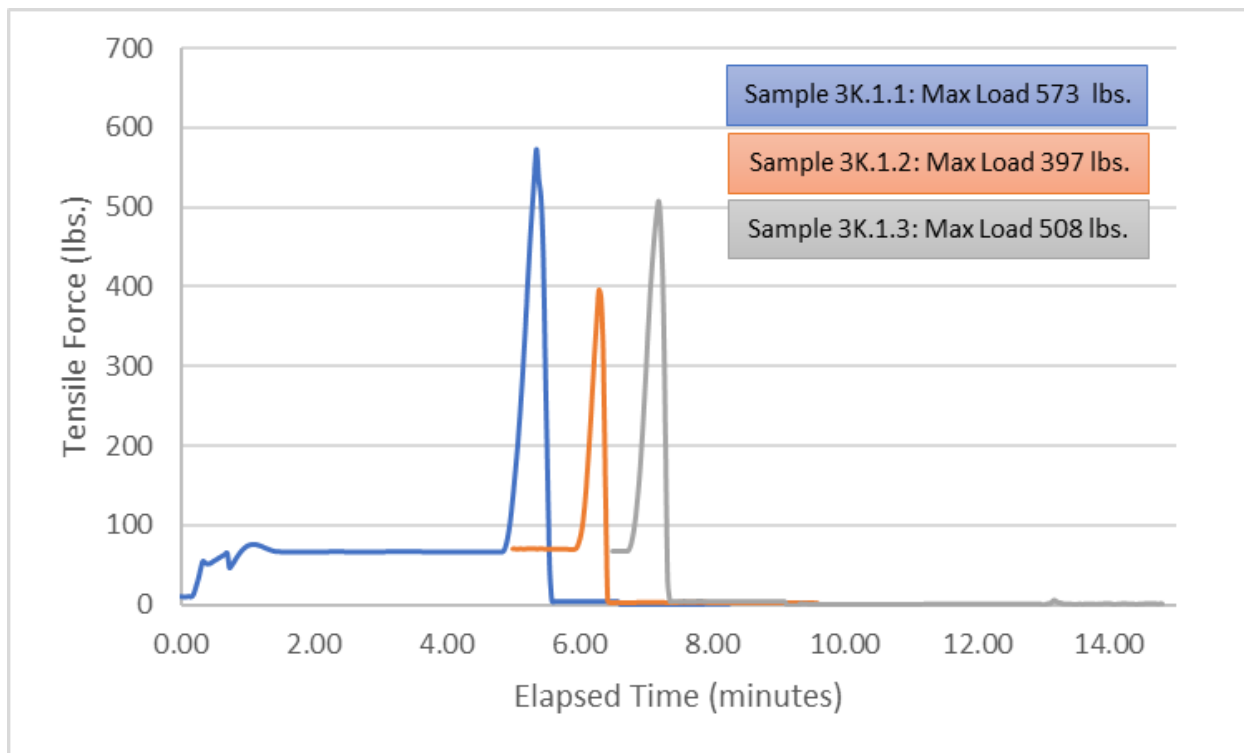

Figure 6-5: Test Load Profile: [REDACTED] and 17 kV 1/0 AWG ACSR

Table 6-6: Test Results: [REDACTED] and 35 kV 1/0 AWG ACSR

Sample No.	Max. Vertical Load	Vertical Deformation of Cross Arm		Comments (Observations)
	[lb]	West* [inch]	East** [inch]	
3K.2.1	555.0	- 0.20	0.16	Conductor slip at the clamp. No damage to the Cross-arm under the flange of the insulator pin. No damage to conductor
3K.2.2	548.0	- 0.08	0.04	Conductor slip at the clamp. No damage to the Cross-arm under the flange of the insulator pin. No damage to conductor
3K.2.3	693.0	- 0.08	0.04	Conductor slip at the clamp. No damage to the Cross-arm under the flange of the insulator pin. No damage to conductor

(*) "West" references the downward deformation at the crossarm where the insulator was mounted

(**) "East" references the upward deformation at the free end of the crossarm, opposite to the side where the insulator was mounted

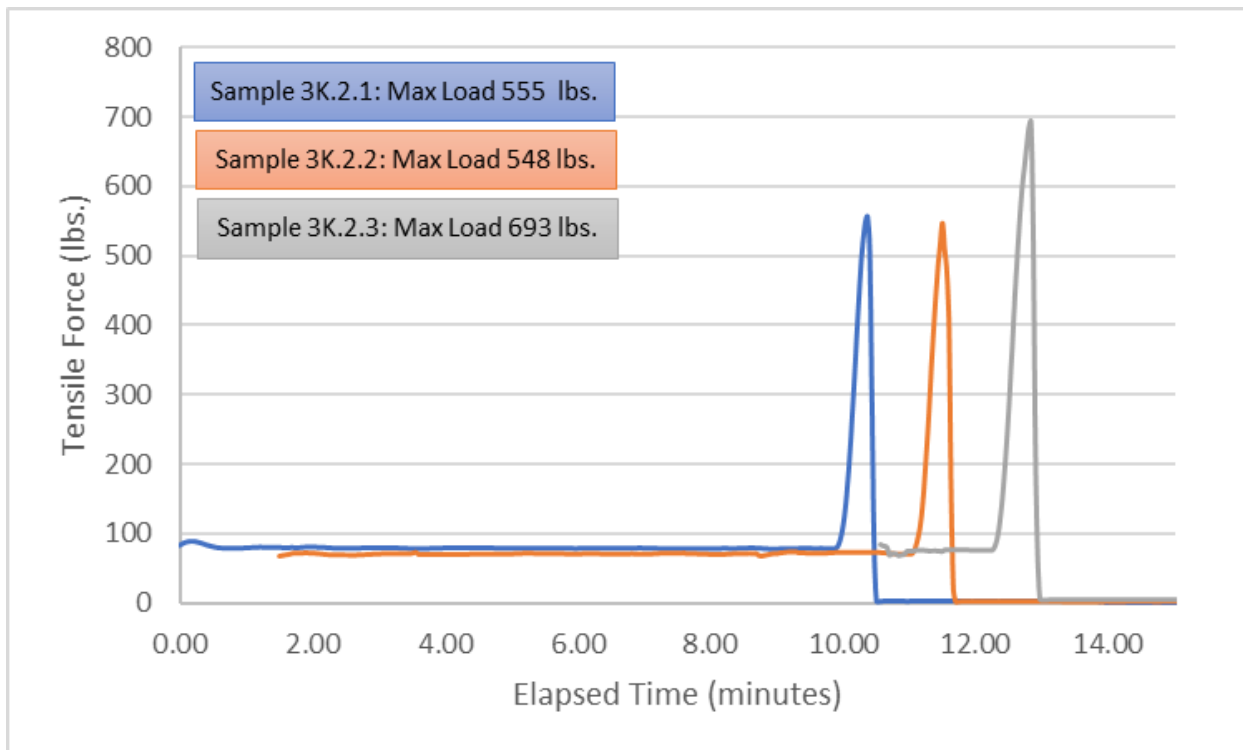

Figure 6-6: Test Load Profile: [REDACTED] and 35 kV 1/0 AWG ACSR

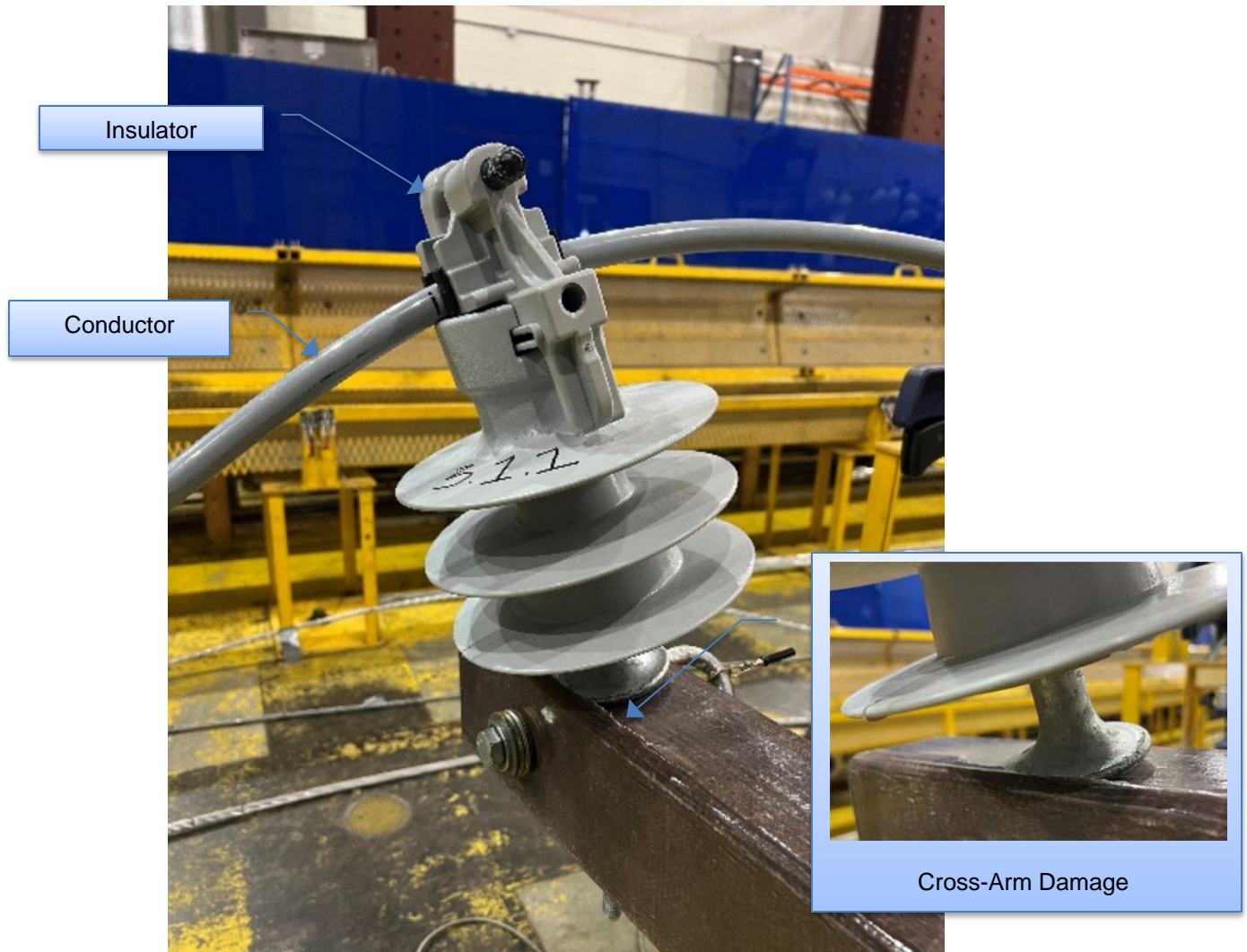

Figure 6-7: Sample 3.1.1 – Insulator and Cross-arm Condition after Test



Figure 6-8: Sample 3.1.1 - 17 kV, 1/0 AWG ACSR Condition after Test

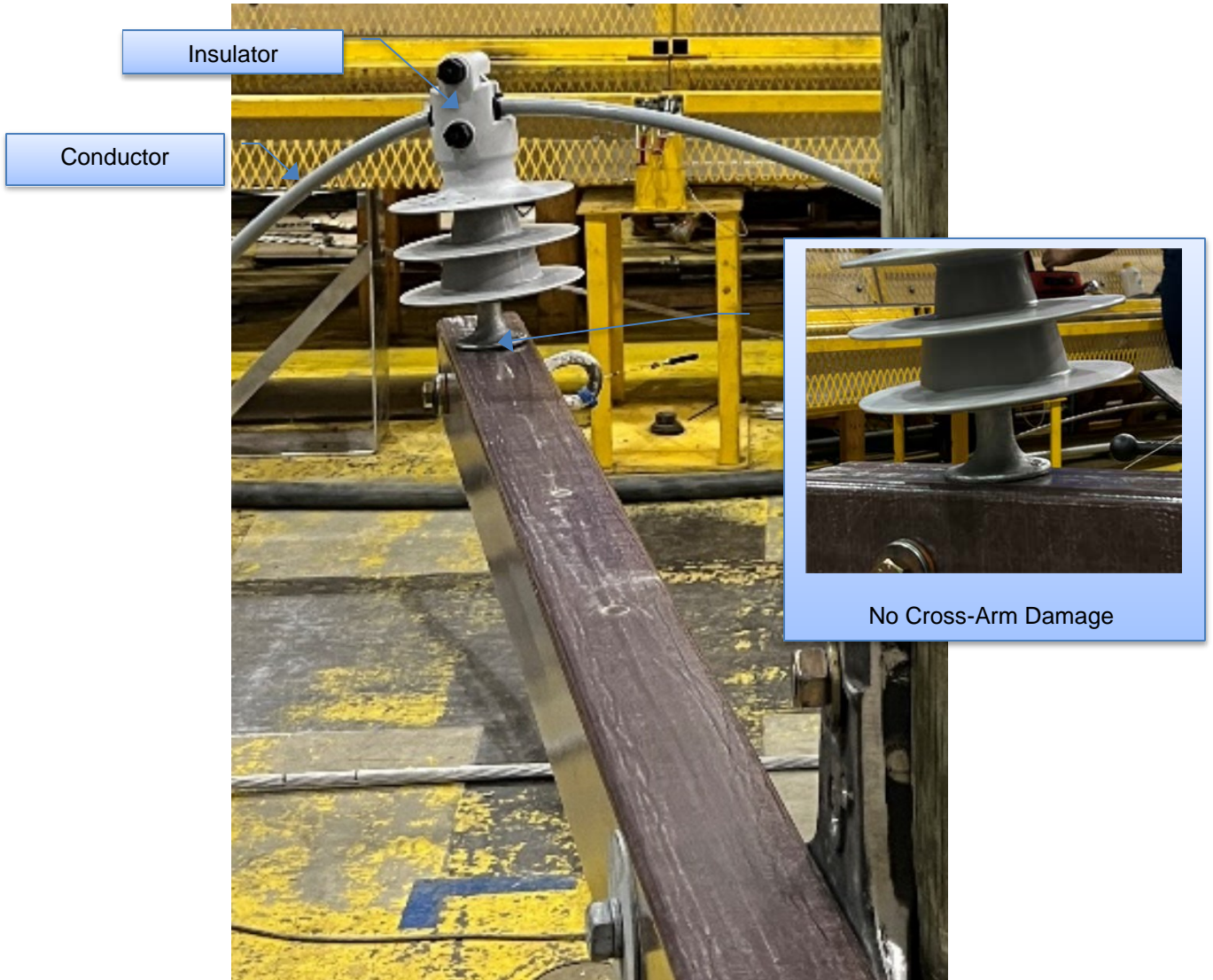

Figure 6-9: Sample 3.1.2 - – Insulator and Cross-arm Condition after Test



Figure 6-10: Sample 3.1.2 - 17 kV, 1/0 AWG ACSR Condition after Test

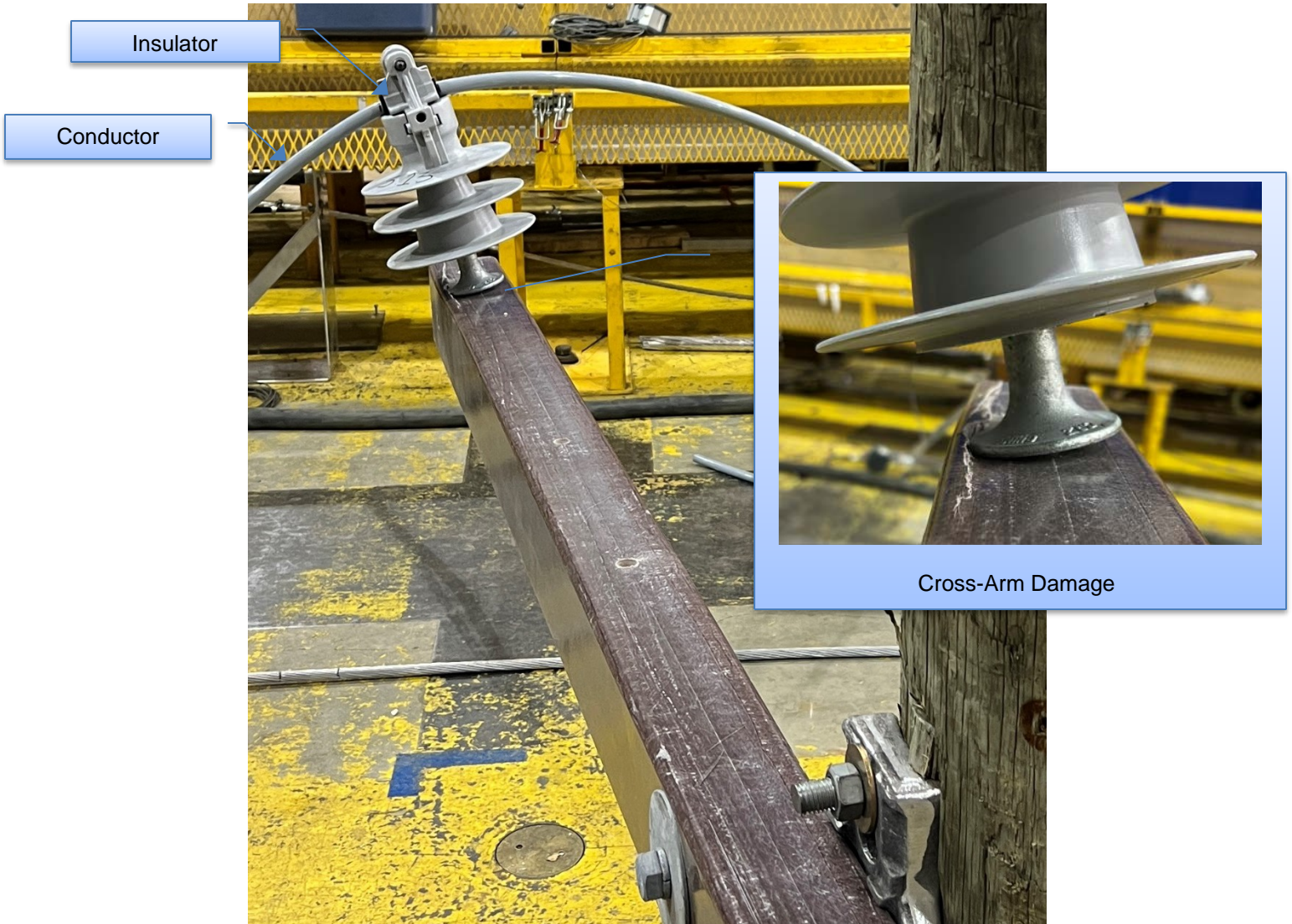

Figure 6-11: Sample 3.1.3 – Insulator and Cross-arm Condition after Test



Figure 6-12: Sample 3.1.3 - 17 kV, 1/0 AWG ACSR Condition after Test

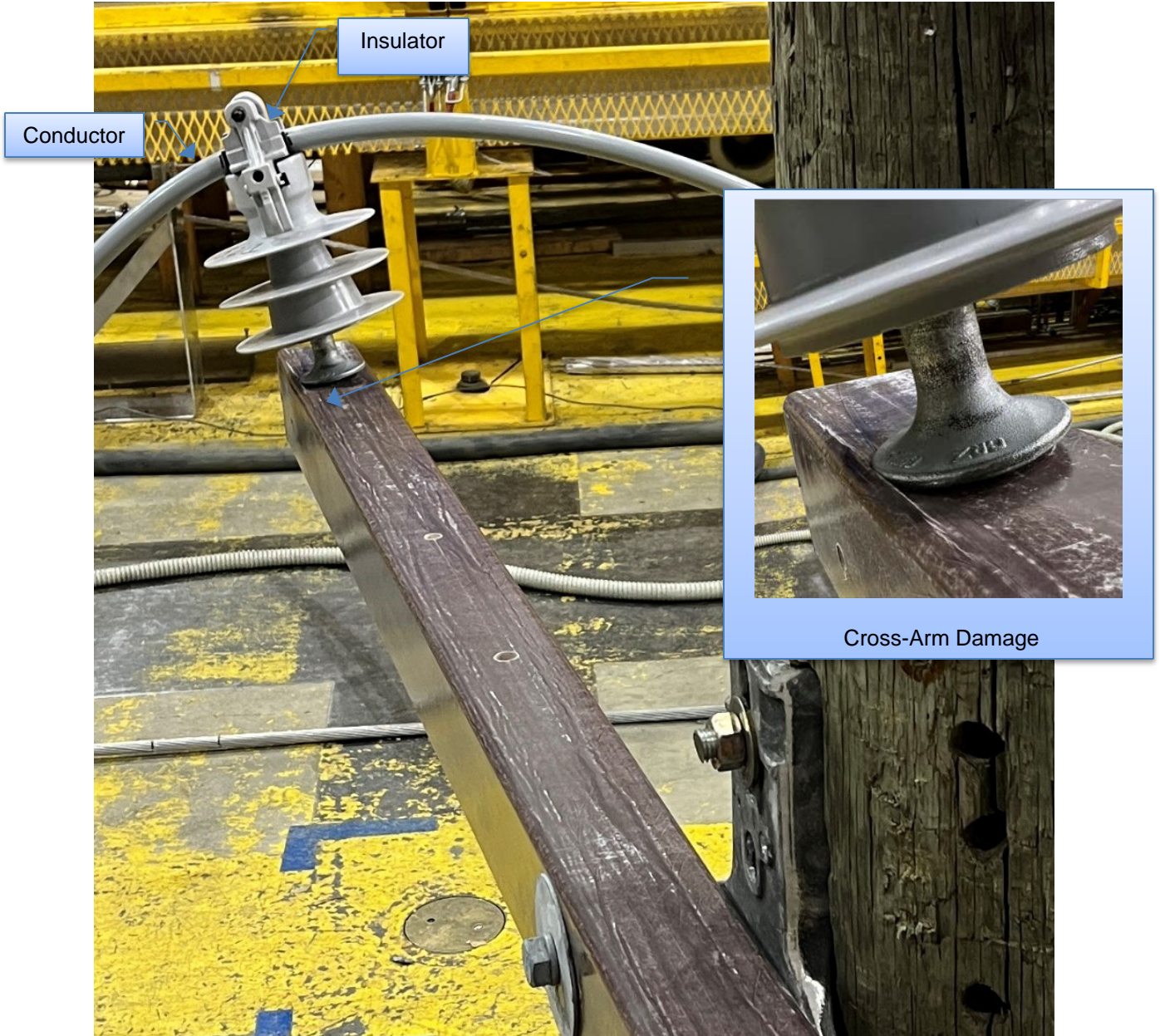

Figure 6-13: Sample 3.2.1 – Insulator and Cross-arm Condition after Test

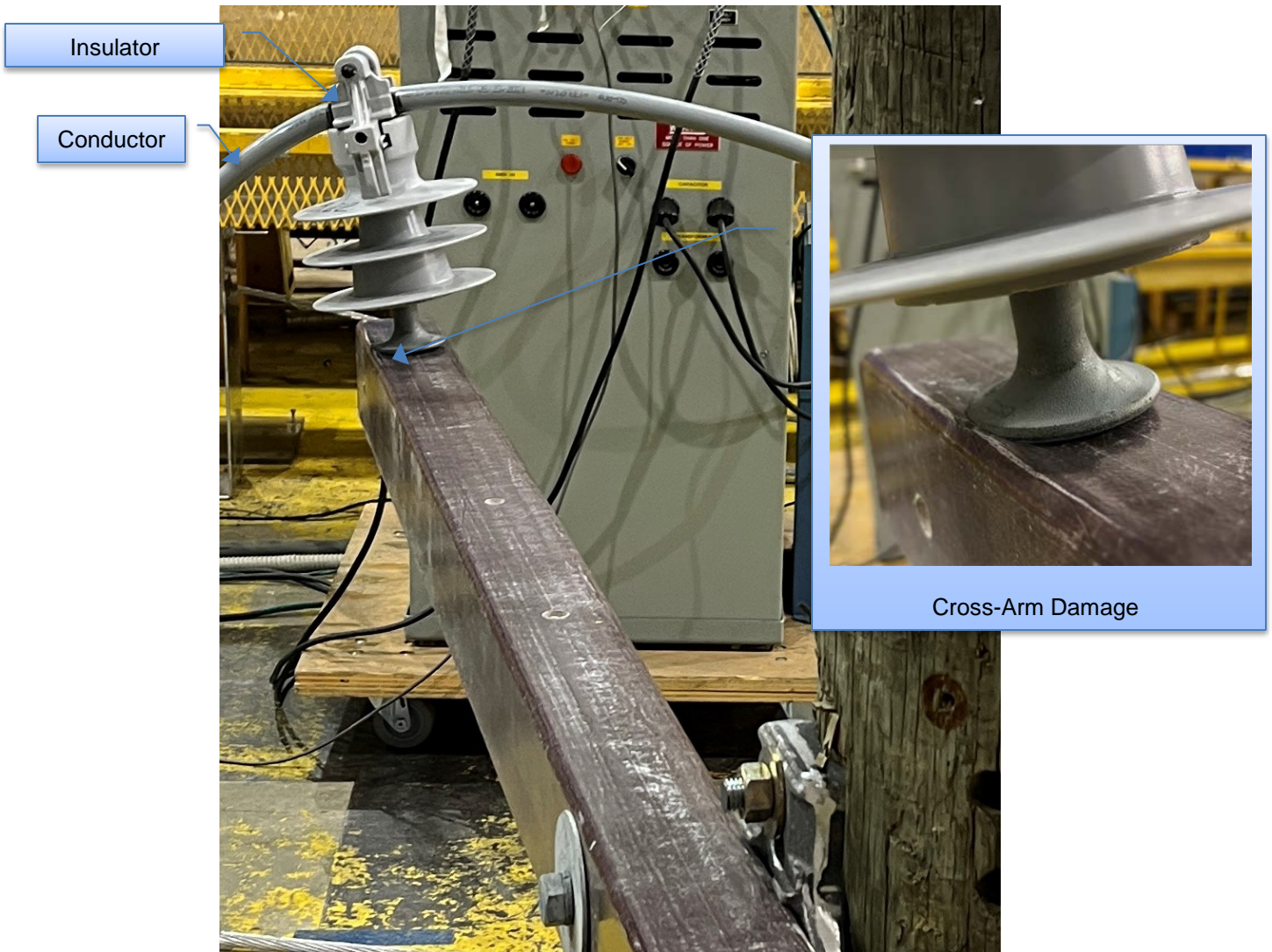

Figure 6-14: Sample 3.2.2 – Insulator and Cross-arm Condition after Test



Figure 6-15: Sample 3.2.2 - 35 kV, 1/0 AWG ACSR Condition after Test

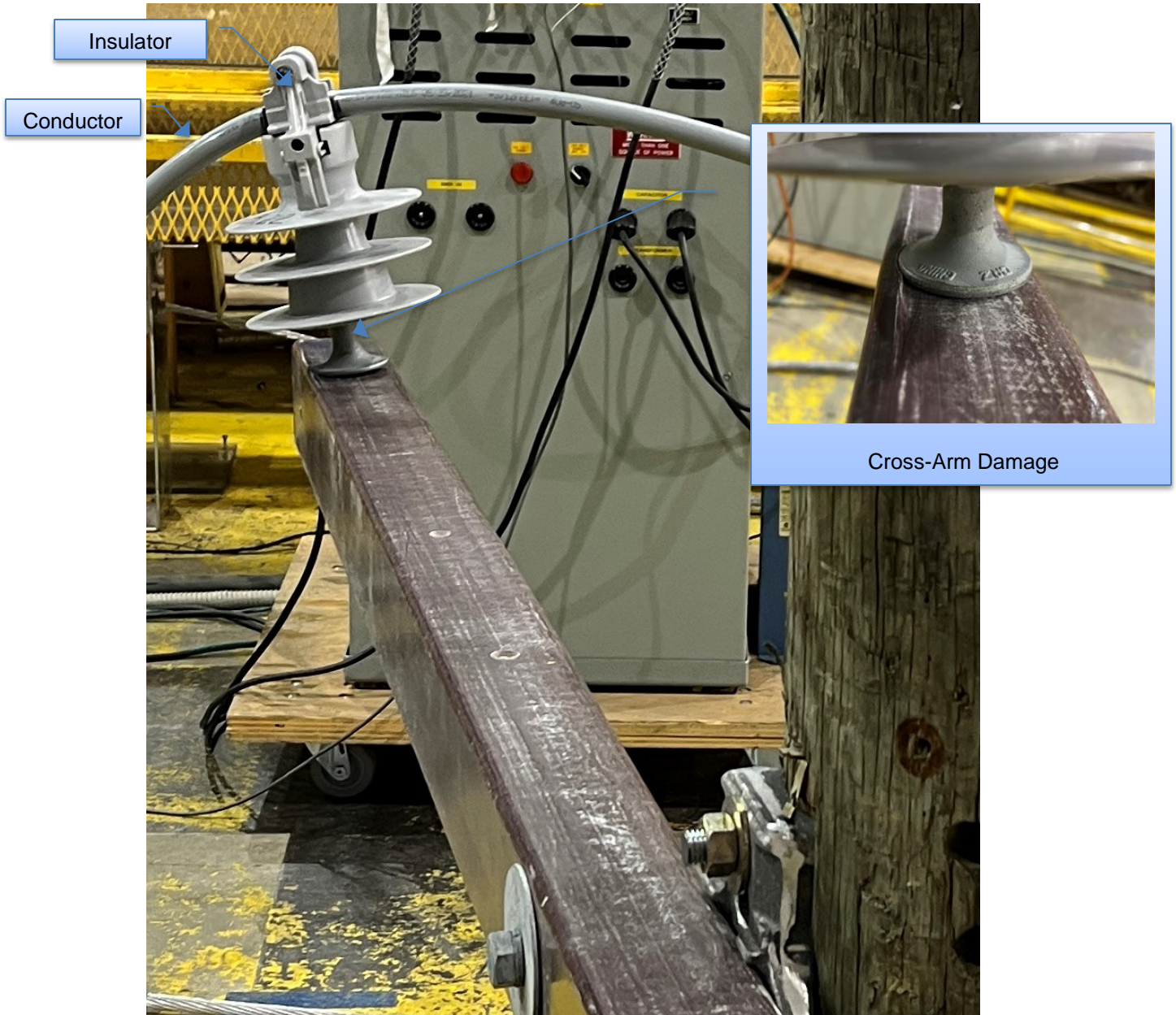

Figure 6-16: Sample 3.2.3 – Insulator and Cross-arm Condition after Test

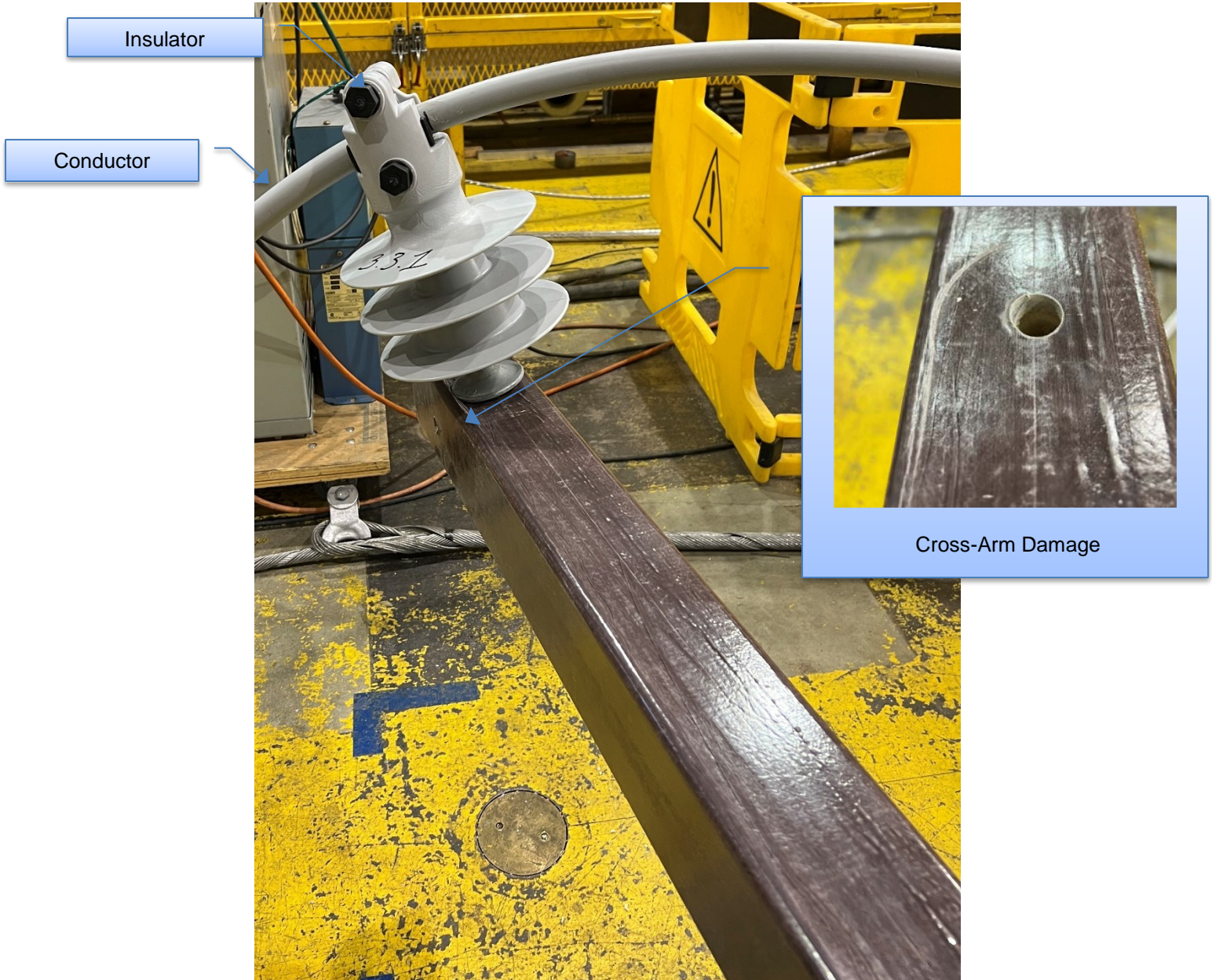

Figure 6-17: Sample 3.3.1 – Insulator and Cross-arm Condition after Test

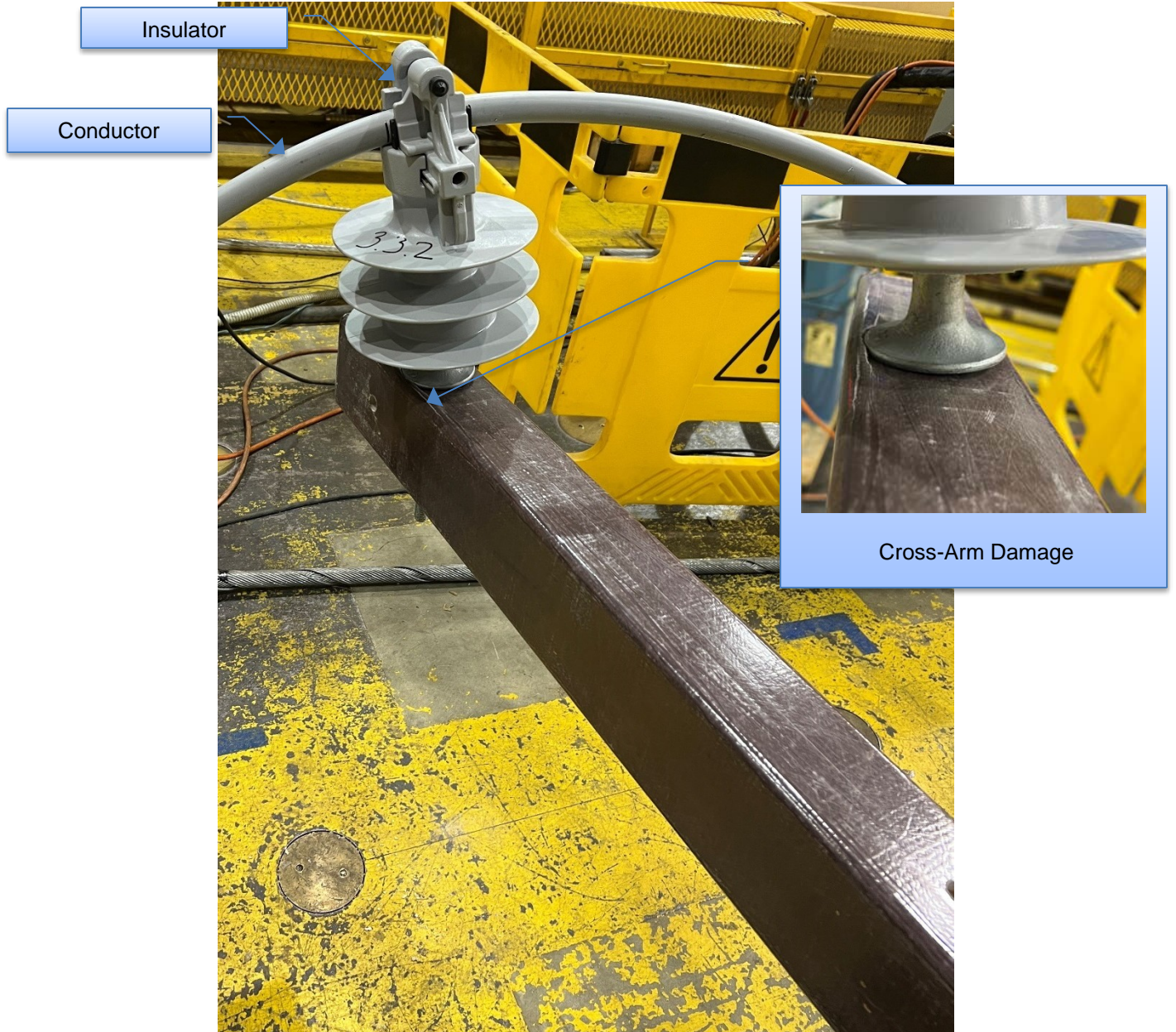

Figure 6-18: Sample 3.3.2 - Insulator and Cross-arm Condition after Test



Figure 6-19: Sample 3.3.3 - Insulator and Cross-arm Condition after Test



Figure 6-20: Sample 3.3.3 - 22 kV, 397.5 kcmil AAC Condition after Test

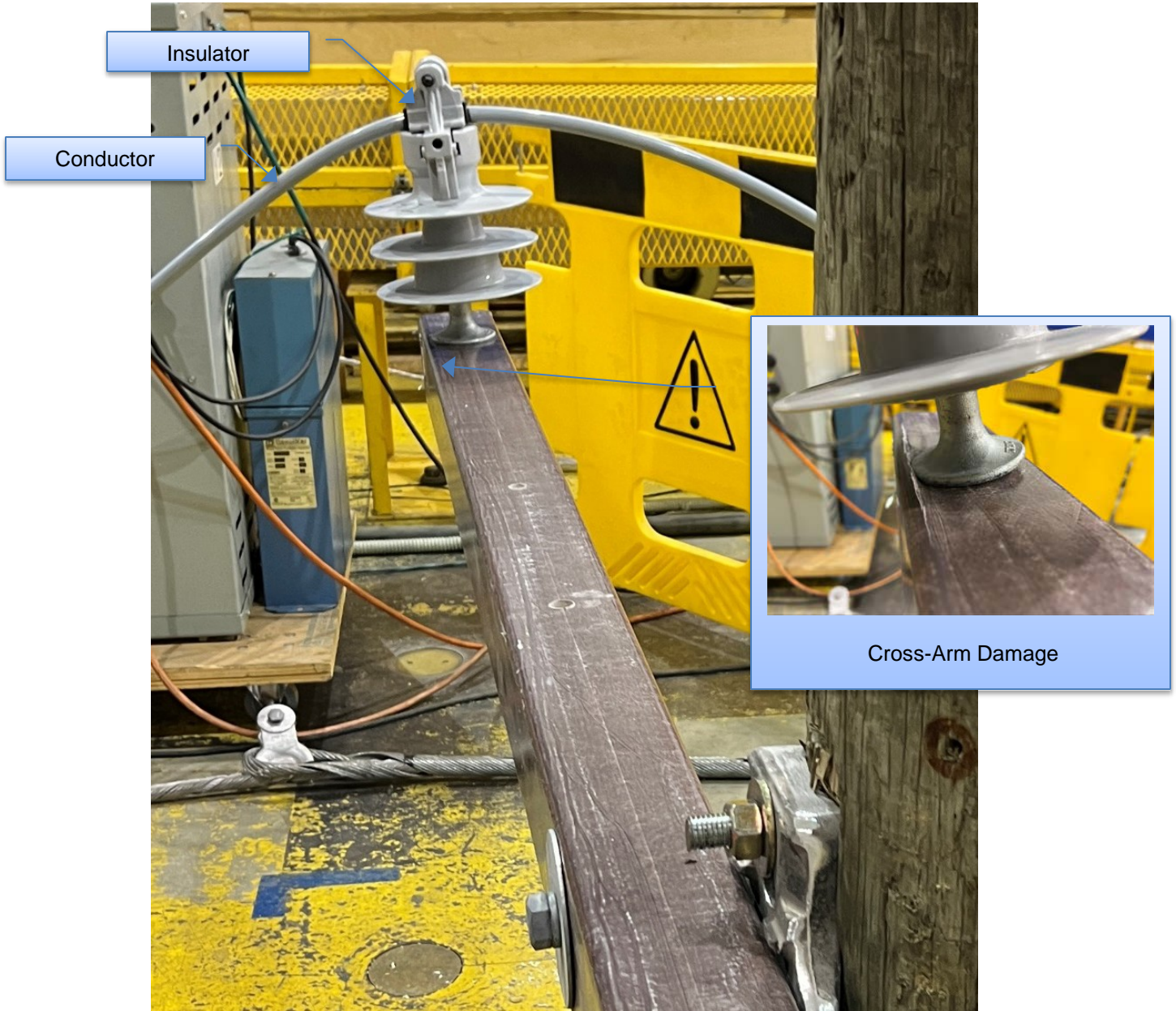

Figure 6-21: Sample 3.4.1 – Insulator and Cross-arm Condition after Test

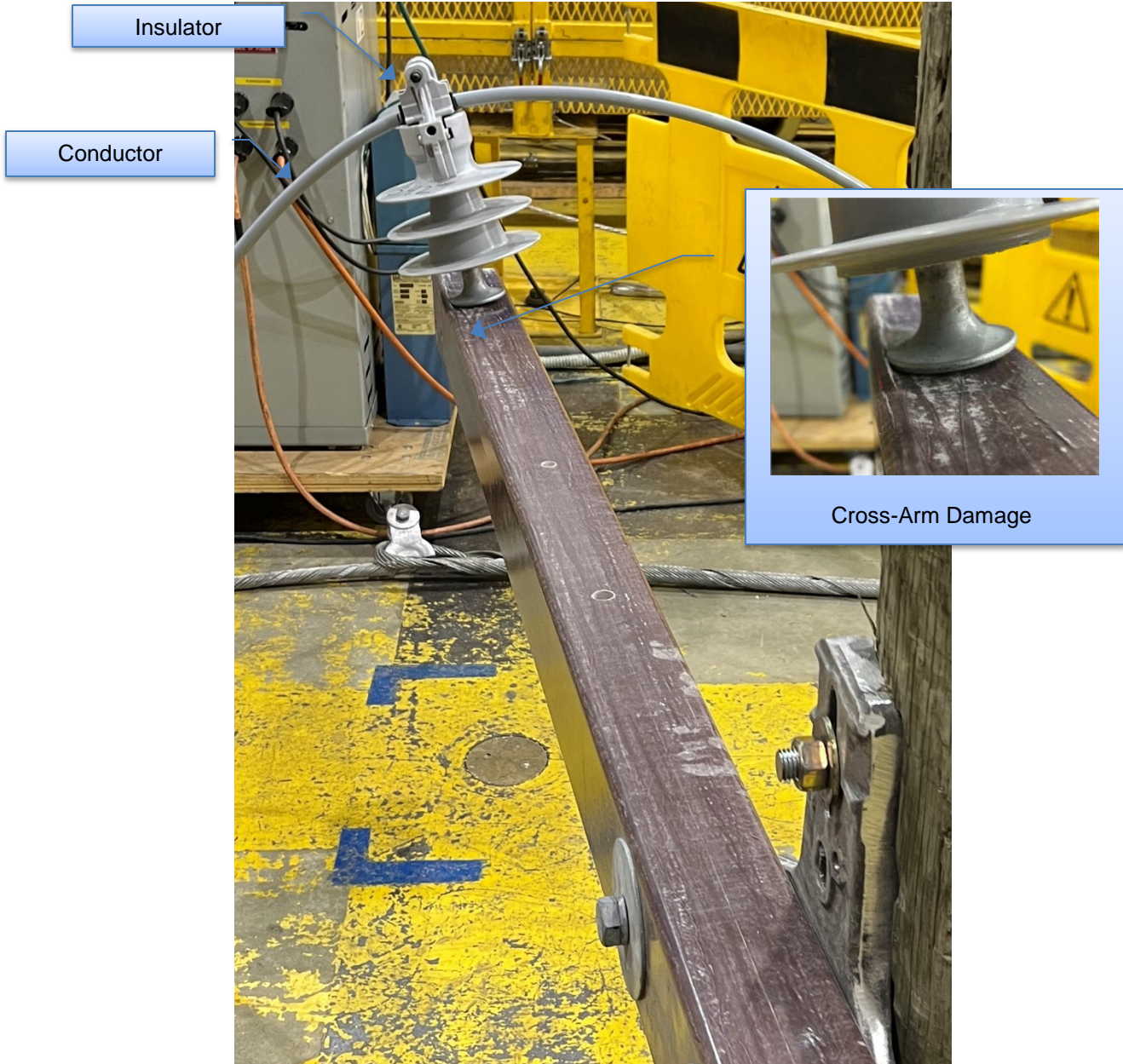

Figure 6-22: Sample 3.4.2 – Insulator and Cross-arm Condition after Test

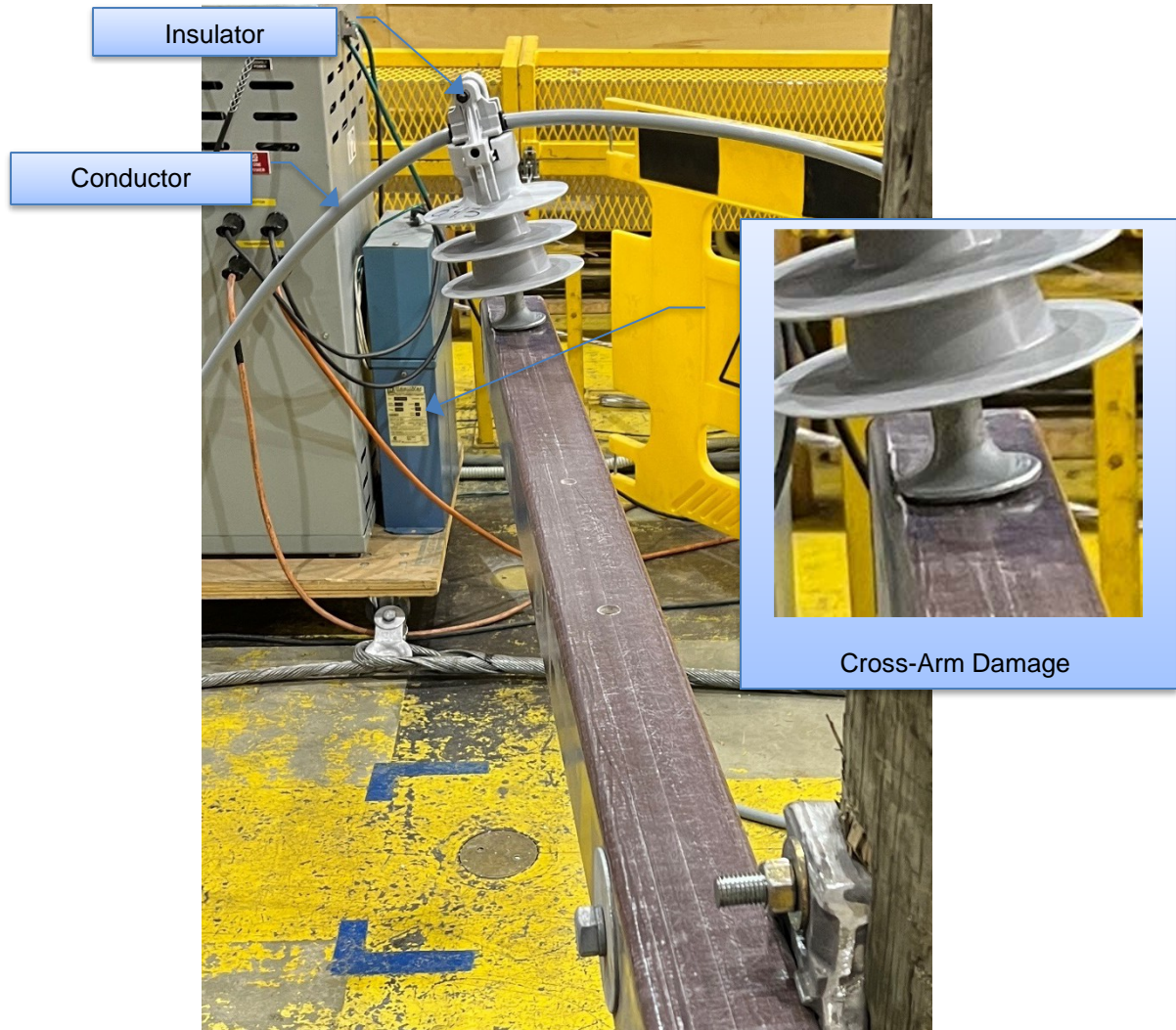

Figure 6-23: Sample 3.4.3 – Insulator and Cross-arm Condition after Test



Figure 6-24: Sample 3.4.3 - 15 kV, 1/0 AWG ACSR Condition after Test



Figure 6-25: Sample 3K.1.1 – Insulator and Cross-arm Condition after Test



Figure 6-26: Sample 3K.1.1 - 17 kV, 1/0 AWG ACSR Condition after Test



Figure 6-27: Sample 3K.1.2 – Insulator and Cross-arm Condition after Test



Figure 6-28: Sample 3K.1.2 - 17 kV, 1/0 AWG ACSR Condition after Test



Figure 6-29: Sample 3K.1. – Insulator and Cross-arm Condition after Test



Figure 6-30: Sample 3K.1.3 - 17 kV, 1/0 AWG ACSR Condition after Test



Figure 6-31: Sample 3K.2.1 – Insulator and Cross-arm Condition after Test



Figure 6-32: Sample 3K.2.2 – Insulator and Cross-arm Condition after Test

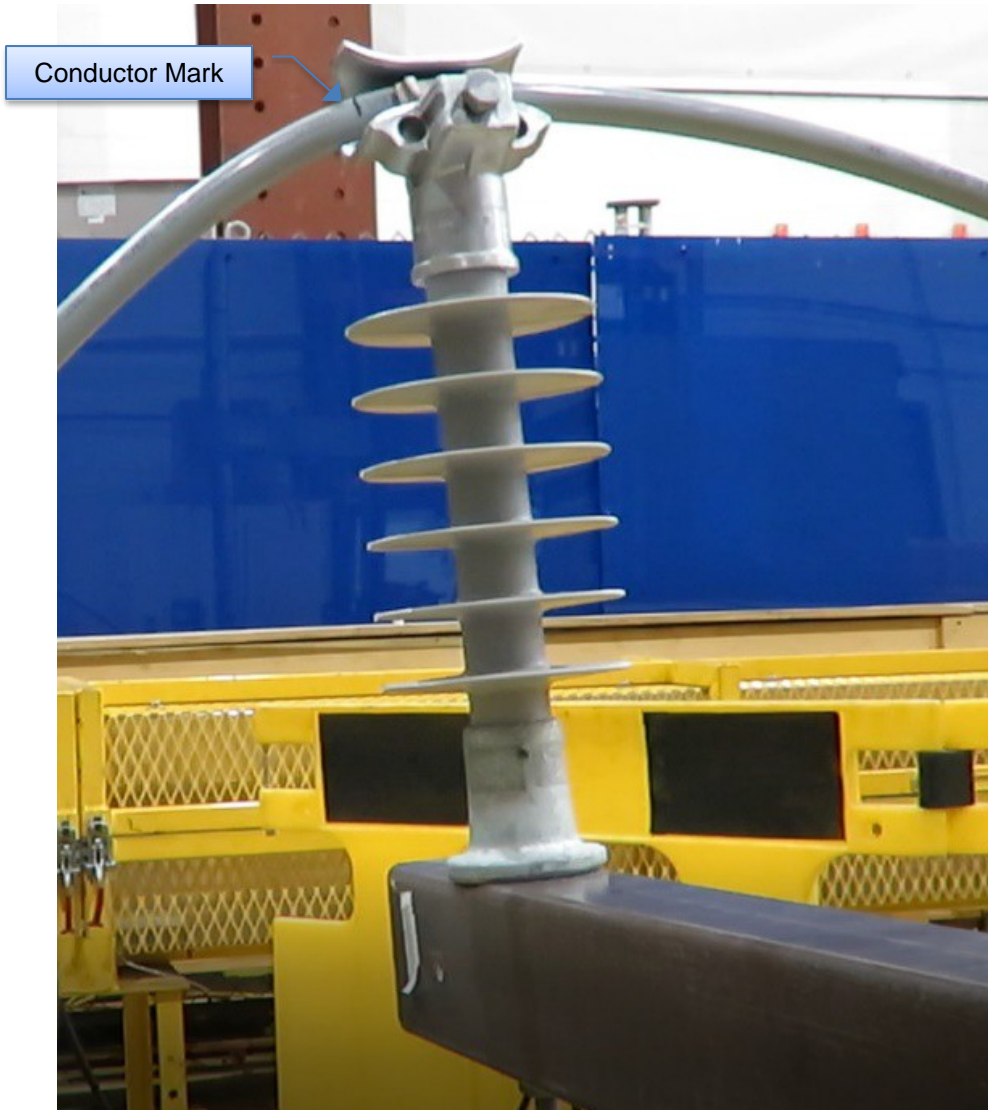

Figure 6-33: Sample 3K.2.3 – Insulator and Cross-arm Condition after Test



Figure 6-34: Sample 3K.1.3 - 17 kV, 1/0 AWG ACSR Condition after Test

7 Acceptance Criteria

There were no acceptance criteria provided by the client for this test. The objective of the Full Mock-up Test was to simulate mechanical loading in the event of a tree falling on the line and evaluate its effect on components (conductor, insulator, cross arm).

8 Conclusion

The test results show that [REDACTED] insulators provided a higher gripping strength on the conductor, as compared to the [REDACTED] clamps top. This translated into a higher slip load which in turn caused the insulator to bend at the pin. Due to the bending process, the shoulder of the pin damaged the cross-arm. In comparison, the [REDACTED] insulators caused the conductor to slip at a lower load which protected the insulator from bending and cross-arm from damage.

[The remainder of this page is intentionally left blank.]



Appendix A Acronyms and Abbreviations

AAC	- All Aluminum Conductor
ACSR	- Aluminum Conductor Steel Reinforced
ANSI	- The American National Standards Institute
AWG	- American Wire Gauge
ISO	- International Organization for Standardization
RTS	- Rated Tensile Strength
XLPE	- Crosslinked Polyethylene

[The remainder of this page is intentionally left blank.]

Appendix B Conductor Data Sheet (as provided by the client)

Covered Conductor Data Sheet

Covered Conductor for 17kV and 35kV

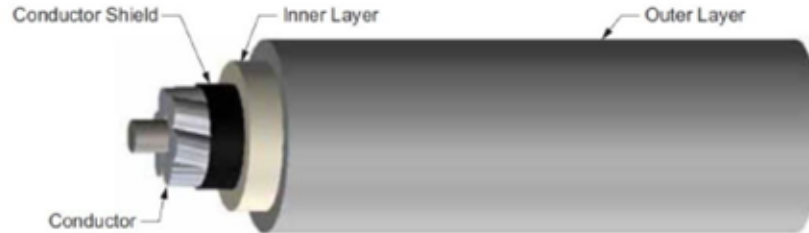

- Conductor:
 - Aluminum Conductor Steel-Reinforced (ACSR) or
 - Hard Drawn Copper (HDCU)
- Conductor Shield: Semiconducting Thermoset Polymer
- Inner Layer: Crosslinked Low Density Polyethylene (XL-LDPE)
- Outer Layer: Crosslinked High Density Polyethylene (XL-HDPE)
 - Track Resistant
 - Abrasion Resistant

Temperature Rating:

Normal Operating Temperature: 90°C

Emergency Operating Temperature: 130°C

Short Circuit Temperature: 250°C

17kV Covered Conductor

ACSR

Conductor Size (AWG)	Conductor Type (Stranding)	Weight (lb/ft)	Conductor Diameter (in)	Conductor Shield Thickness (in)	Inner Layer Thickness (in)	Outer Layer Thickness (in)	Max Nominal Overall Diameter (in)	Maximum Rated Strength (lb.)	Ampacity per Conductor ¹ (Amps)
1/0	ACSR (6x1)	0.289	0.398	0.015 - 0.025	0.075	0.075	0.748	4,160	271
336.4	ACSR (18x1)	0.584	0.684	0.015 - 0.025	0.075	0.075	1.034	8,246	550
336.4	ACSR (30/7)	0.750	0.741	0.015 - 0.025	0.075	0.075	1.091	16,435	561
653.9	ACSR (18x3)	0.998	0.953	0.020 - 0.025	0.080	0.080	1.323	14,060	835

¹ Covered Conductor Cable Normal Operating Rating Criteria:

Ambient Temperature = 40°C

Conductor Temperature = 90°C

Load Factor = 100%

Wind Speed = 4 ft/sec

Coefficient of Emissivity = 0.5

Coefficient of Absorption = 0.5

Latitude = 34°

Elevation of Conductor above Sea Level = 0 ft

Atmosphere = Clear

Local Sun Time = 1:00 pm

Figure C - 1: [REDACTED] 17 kV 1/0 AWG ACSR Conductor Data

35kV Covered Conductor

ACSR

Conductor Size (AWG)	Conductor Type (Stranding)	Weight (lb/ft)	Conductor Diameter (in)	Conductor Shield Thickness (in)	Inner Layer Thickness (in)	Outer Layer Thickness (in)	Max Nominal Overall Diameter (in)	Maximum Rated Strength (lb.)	Ampacity per Conductor ¹ (Amps)
1/0	ACSR (6x1)	0.460	0.398	0.015 - 0.025	0.175	0.125	1.048	4,160	255
336.4	ACSR (18x1)	0.850	0.684	0.015 - 0.025	0.175	0.125	1.334	8,246	518
336.4	ACSR (30x7)	0.981	0.741	0.015 - 0.025	0.175	0.125	1.391	16,435	529
653.9	ACSR (18x3)	1.242	0.953	0.020 - 0.025	0.175	0.125	1.602	14,060	784

¹ Covered Conductor Cable Normal Operating Rating Criteria:

- Ambient Temperature = 40°C
- Conductor Temperature = 90°C
- Load Factor = 100%
- Wind Speed = 4 ft/sec
- Coefficient of Emissivity = 0.5
- Coefficient of Absorption = 0.5
- Latitude = 34°
- Elevation of Conductor above Sea Level = 0 ft
- Atmosphere = Clear
- Local Sun Time = 1:00 pm

Specifications

Must be manufactured to the latest editions of the following standards:

- ASTM B8
- ASTM B232
- ICEA S-121-733

Figure C - 2: XXXXXXXXXX 35 kV 1/0 AWG ACSR Conductor Data

Appendix C Insulator Datasheet

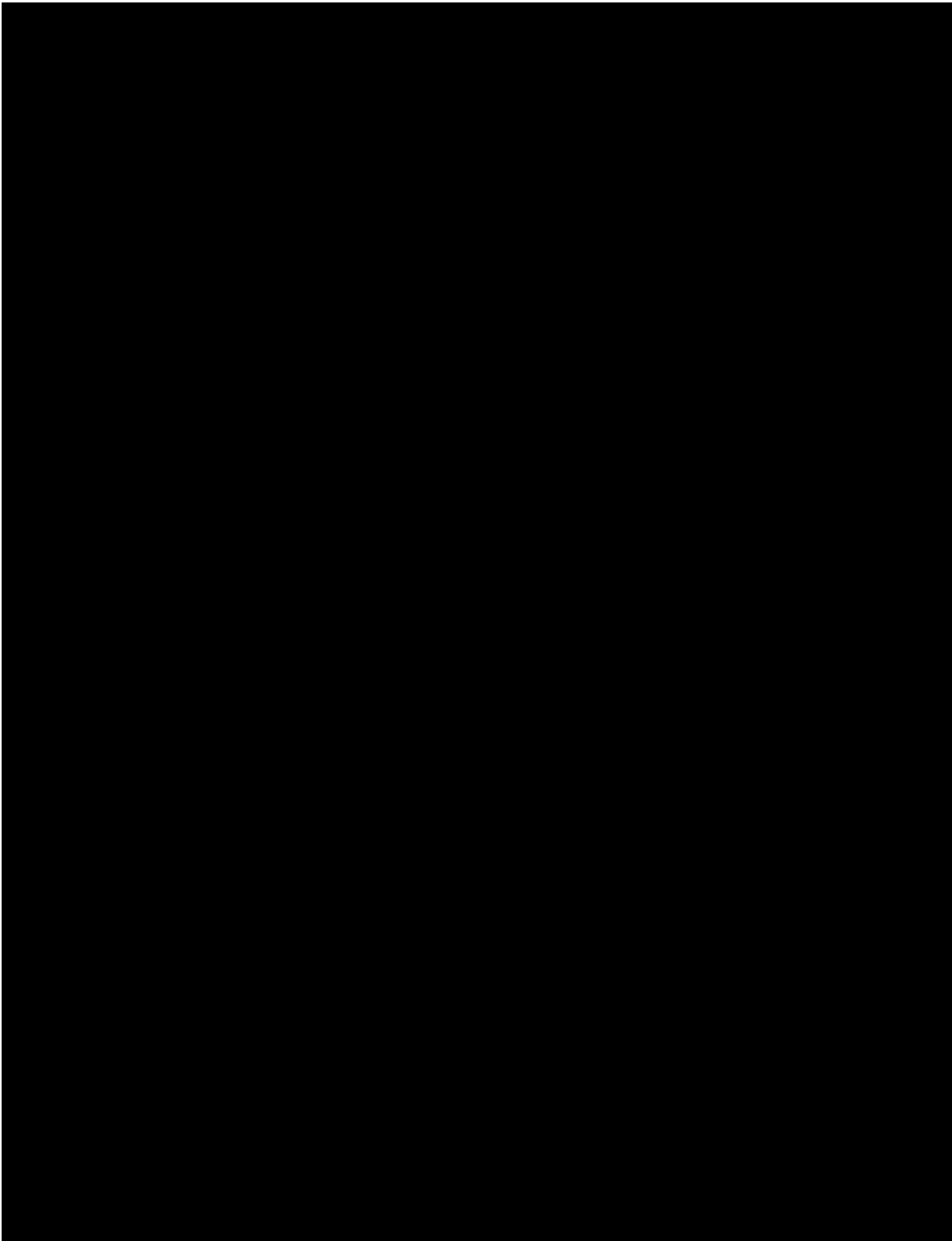

Figure D 1: [REDACTED] 35 kV Insulator [REDACTED]

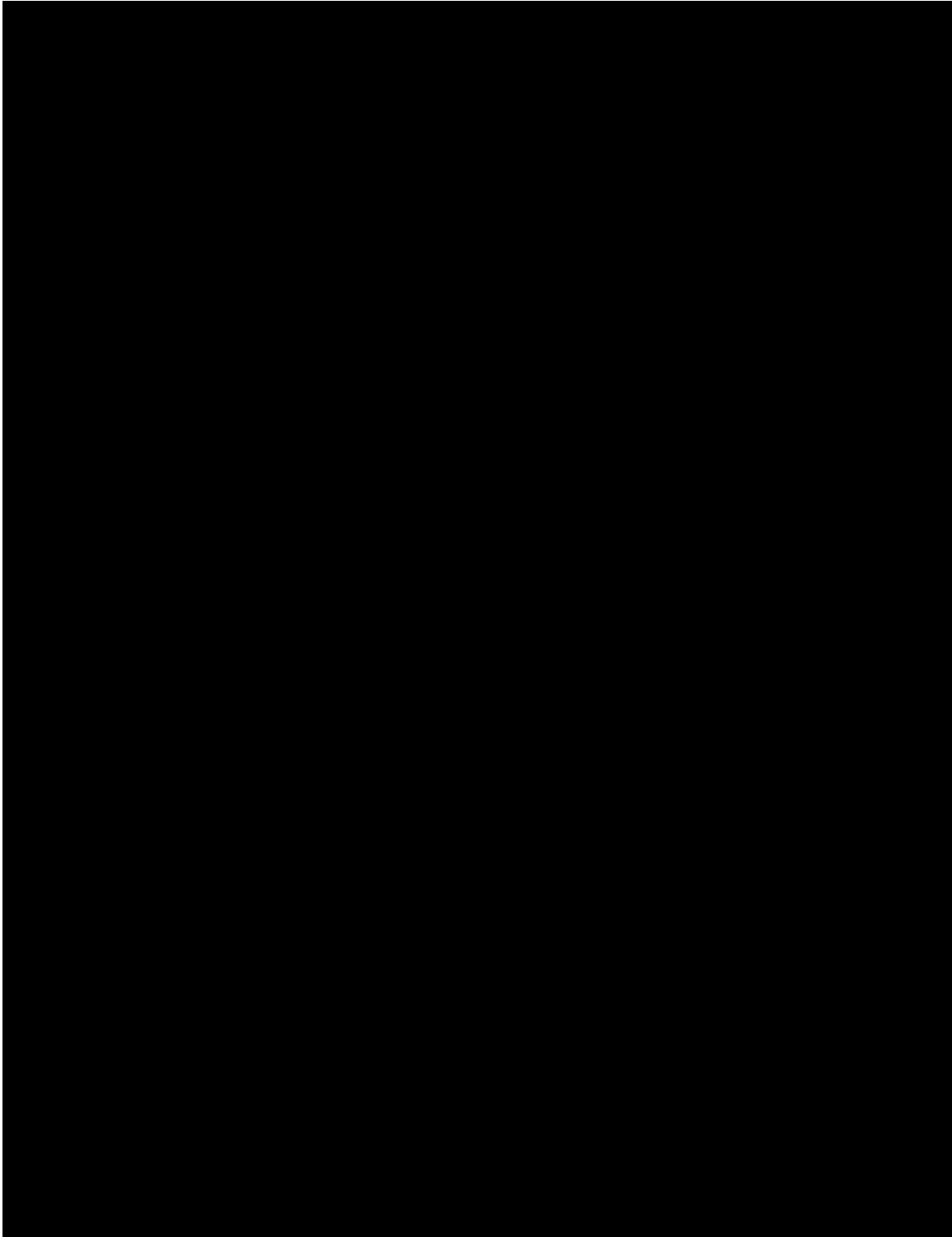

Figure D 2: [REDACTED] Post Insulators [REDACTED] and [REDACTED]

Appendix D Dead-End Bolted Clamps used in the test

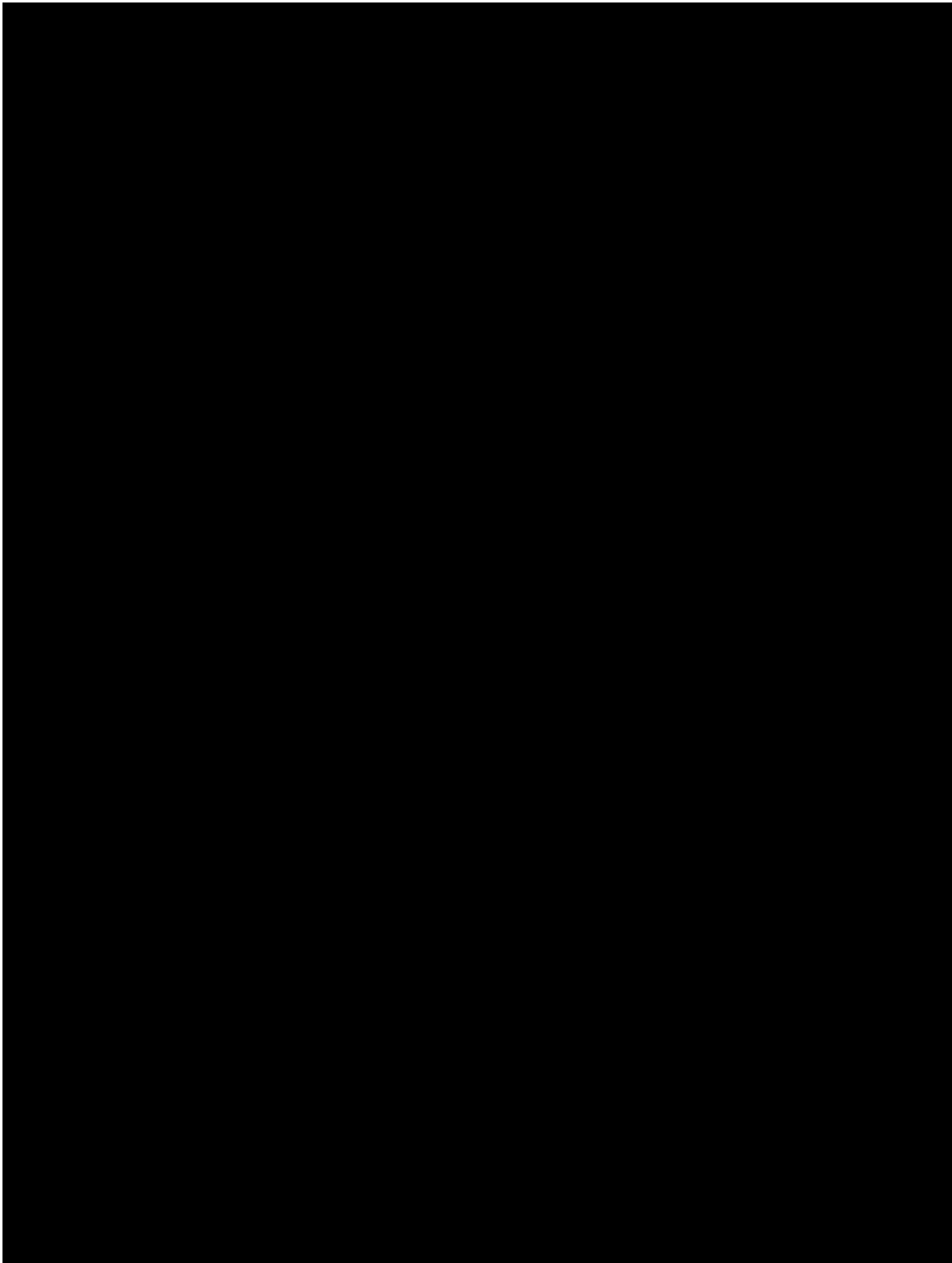

Figure 8-1: [REDACTED] Dead-End Bolted Clamp [REDACTED]

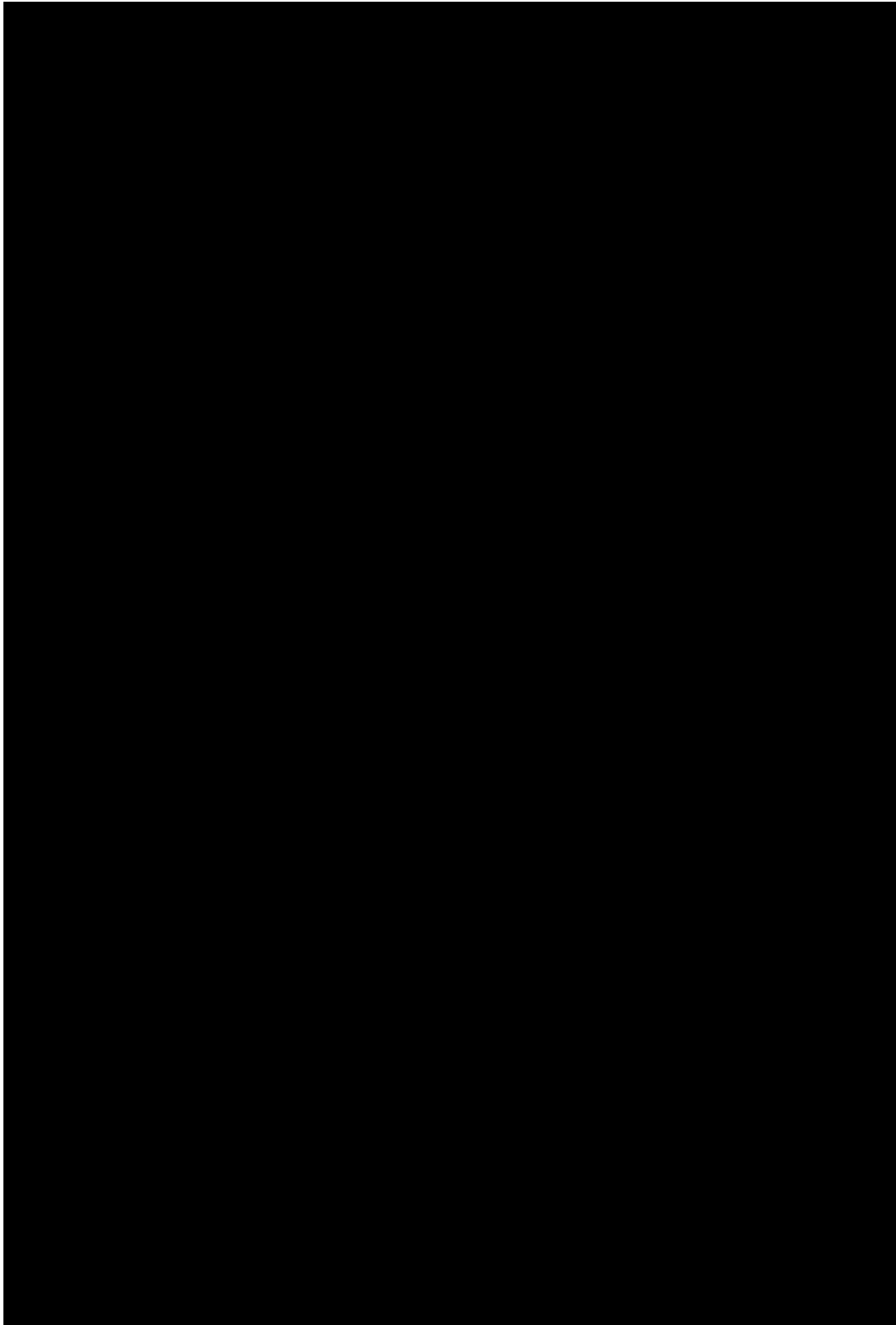

Figure 8-2: [REDACTED] Dead-End Bolted Clamp [REDACTED]

Appendix E Instrument Sheet

EQUIPMENT DESCRIPTION	ASSET No.	ACCURACY CLAIMED	CALIBRATION DATE	CALIBRATION DUE DATE	TEST USE
Data Logger	KIN-01836	±0.1% of Reading	May 27, 2022	May 27, 2023	Data acquisition
Load Cell/ Conditioner	KIN-01725/ KIN-01724	±1% of Reading	October 26, 2021	October 26, 2022	Load
Tape Measure	KIN-06890	< 0.05% of Reading	June 29, 2022	June 29, 2023	Length
Thermocouple/ Transmitter	KIN-00918/ KIN-00919	± 1 °C	October 28, 2021/ October 21, 2021	October 28, 2022/ October 21, 2022	Ambient Temperature

[The remainder of this page is intentionally left blank.]

Appendix F Kinectrics ISO 9001 Certificate of Registration



 **CERTIFICATE OF REGISTRATION**

This is to certify that
Kinectrics Inc.
Kinectrics North America Inc., Kinectrics International Europe ApS or Kinectrics International Inc.
800 Kipling Avenue, Unit 2, Toronto, Ontario M8Z 5G5 Canada

Refer to Attachment to Certificate of Registration dated November 5, 2021 for additional certified sites
operates a
Quality Management System
which complies with the requirements of
ISO 9001:2015
for the following scope of certification
This registration covers the Quality Management System for engineering, consulting, design, testing, project management, research, software development, assessments, operations support, and analysis within our facilities, and at field sites, for customers in the electricity industry and related energy sectors; both nuclear and conventional; as well as processing of radiological and conventional laundry and manufacture, inspection, and repair of personal protection equipment.

Certificate No.:	CERT-0119296	Original Certification Date:	July 7, 1998
File No.:	006555	Certification Effective Date:	May 23, 2021
Issue Date:	November 5, 2021	Certification Expiry Date:	May 22, 2024

Frank Camasta
Global Head of Technical Services
SAI Global Assurance

Registered by:
QM-SAI Canada Limited (SAI Global), 20 Denison Court, Suite 200, Toronto, Ontario M9N 7Y5 Canada. This registration is subject to the SAI Global Terms and Conditions for Certification. While all due care and skill were exercised in carrying out the assessment, SAI Global accepts responsibility only for proven negligence. This certificate remains the property of SAI Global and must be returned to them upon request.
To verify that this certificate is current, please refer to the SAI Global On-Line Certification Register:
https://www.sai-global.com/en-us/assurance/auditing_and_certification/certification_registry/





Appendix G Distribution

Mr. Matt Bowers, Ph.D., P.E.

Exponent
17000 Science Drive, Suite 200
Bowie, Maryland 20715
Email: mowers@exponent.com

Mr. Genti Gorja

Kinectrics AES Inc.
800 Kipling Ave, Unit No.2
Toronto, ON
Canada M8Z 5G5

Email: genti.gorja@kinectrics.com

[The remainder of this page is intentionally left blank.]



NOTE: Component manufacturer information has been redacted from this report.

MECHANICAL TESTING SIMULATING TREE FALLING ON A DEAD END SPAN OF COVERED CONDUCTORS

K-580861-RP-0001 R00

Prepared for

Exponent

Purchase Order No. 00067544

<p>Prepared by</p> <p> Digitally signed by GORJA Genti Date: 2022.11.18 10:27:57 -05'00'</p> <p>Signature & Date</p> <p>Genti Gorja P.Eng. Principal Engineer Line Asset Management</p>	<p>Reviewed by</p> <p> Digitally signed by André Maurice Date: 2022.11.18 11:02:06 -05'00'</p> <p>Signature & Date</p> <p>André Maurice Service Line Manager Line Asset Management</p>	<p>Approved by</p> <p>PETER</p> <p> Digitally signed by PETER Zsolt Date: 2022.11.18 15:53:31 -05'00'</p> <p>Zsolt</p> <p>Signature & Date</p> <p>Zsolt Peter Ph.D. Business Area Director Line Asset Management</p>
--	---	---

Revision History

Rev 00	Description: Original Issue			
	Issue Date: 2022-11-19	Prepared by: Genti Gorja	Reviewed by: André Maurice	Approved by: Zsolt Peter

DISCLAIMER

Kinectrics prepared this report as a work of authorship sponsored by their client. This report has been prepared solely for the benefit of the Client and may not be used or relied upon in whole or in part by any other person or entity without Client permission or without Kinectrics' permission if required by the Contract between Client and Kinectrics Inc. Neither Kinectrics, their client nor any person acting on behalf of them: (a) makes any warranty or representation whatsoever, express or implied, or assumes any legal liability of responsibility for any third party's use, or the results of such use, with respect to (i) the use of any information, apparatus, method, process, or similar item disclosed in this report including the merchantability or fitness for any particular purpose of any information contained in this report or the respective works or services supplied or performed or (ii) that such use does not infringe on or interfere with privately owned rights, including any party's intellectual property; or (b) assumes responsibility for any damages or other liability whatsoever (including any consequential damages resulting from a third party's selection or use of this report or any information, apparatus, method, process, or similar item disclosed).

Copyright © Kinectrics Inc. 2022. All rights reserved.



Table of Contents

1	Executive Summary	4
2	Test Objective and Test Standard.....	5
3	Test Sample.....	5
4	Test Setup	6
5	Test Procedure	8
6	Test Results.....	8
7	Acceptance Criteria.....	33
8	Conclusion	33
Appendix A	Acronyms and Abbreviations	34
Appendix B	Test Components	35
Appendix C	Instrument Sheet.....	39
Appendix D	Kinectrics ISO 9001 Certificate of Registration	40
Appendix E	Distribution	41

1 Executive Summary

This report describes the “Full Mock-Up” tests conducted on covered conductor assemblies to simulate a tree falling onto a dead-end span, as indicated by Exponent.

The tests were performed on various conductor sizes assembled with their respective dead-end clamps and insulators mounted on [REDACTED] composite crossarm. Exponent supplied all materials (test samples and accessories) required for testing. All connectors and conductor assemblies were received in good condition at Kinectrics on August 30, 2022.

The tests were conducted in accordance with client requirements, as outlined in the relevant sections of this document. The test is conducted for information purposes only and there are no acceptance criteria for this test. The test program is summarized in Table 1 1.

Table 1-1: Test Program

Test ID	Conductor	No. Samples Tested	Date Tested	
Full Mock-up	1	17KV #2 AWG CU Conductor	3	November 11, 2022
	2	17kV 2/0 AWG, CU Conductor	3	November 09, 2022
	3	17kV 4/0 AWG, CU Conductor	3	November 11, 2022
	4	17kV 1/0 AWG, 6/1 ACSR Conductor	3	November 10, 2022
	5	17kV 336.4 KCMIL, 18/1 ACSR Conductor	3	November 11, 2022
	6	17kV 336.4 KCMIL, 30/7 ACSR Conductor	3	November 11, 2022
	7	17kV 653.9 KCMIL, 18/3 ACSR Conductor	3	November 10, 2022

The test results show that for smaller size conductors (#2 AWG Cu; 2/0 AWG CU; 4/0 AWG Cu and 1/0 AWG ACSR) the typical failure occurred as a result of conductor slipping out of the dead-end clamp. For larger conductors with higher Rated Tensile Strength (RTS) (336.4 kcmil and 653.9 kcmil) the typical failure point was the composite crossarm. The failure of the crossarm started at the bolts on the mounting plate and propagated to the insulator attachment point. Deformation of the mounting plate on the crossarm occurred in all instances.

The tests were performed by Kinectrics personnel at 800 Kipling Avenue, Toronto, Ontario, M8Z 5G5, Canada. The work was conducted under Exponent Purchase Order No. 00067544 dated January 14, 2022. The tests were performed under Kinectrics’ ISO 9001 Quality Management System. A copy of ISO 9001 Certificate of Registration is included in Appendix D.

2 Test Objective and Test Standard

The Full Mock-up Test is designed to simulate mechanical loading in the event of a tree falling on a dead-end span of the power line and evaluate its effect on components (conductor, insulator, cross arm). The test is performed in general accordance with the procedures requested by Exponent.

3 Test Sample

The test sample consisted of a length of conductor, terminated on both ends with suitable dead-end clamps, as indicated in Table 3-1. The prepared conductor length was tested in combination with an associated dead-end and insulator mounted on the crossarm. All conductors and hardware used in this test program were provided by Exponent.

Table 3-1: Full Mock-up Test: Sample ID and Configuration

Sample ID	Conductor	Dead End	Insulator	Cross Arm
1.1	17KV #2 AWG CU Conductor	[REDACTED]	INSULATOR,15 KV, DEADEND SU	[REDACTED], 10 ft
1.2				
1.3				
2.1	17kV 2/0 AWG, CU Conductor	[REDACTED]	INSULATOR,15 KV, DEADEND SU	[REDACTED], 10 ft
2.2				
2.3				
3.1	17kV 4/0 AWG, CU Conductor	[REDACTED]	INSULATOR,15 KV, DEADEND SU	[REDACTED], 10 ft
3.2				
3.3				
4.1	17kV 1/0 AWG, 6/1 ACSR Conductor	[REDACTED]	INSULATOR,15 KV, DEADEND SU	[REDACTED], 10 ft
4.2				
4.3				
5.1	17kV 336.4 KCMIL, 18/1 ACSR Conductor	[REDACTED]	INSULATOR,15 KV, DEADEND SU	[REDACTED], 10 ft
5.2				
5.3				
6.1	17kV 336.4 KCMIL, 30/7 ACSR Conductor	[REDACTED]	INSULATOR,15 KV, DEADEND SU	[REDACTED], 10 ft
6.2				
6.3				
7.1	17kV 653.9 KCMIL, 18/3 ACSR Conductor	[REDACTED]	INSULATOR,15 KV, DEADEND SU	[REDACTED], 10 ft
7.2				
7.3				

Data sheets for the components (insulators and bolted dead-ends and crossarm) used in this test are shown in Appendix B. The main mechanical characteristics of the conductors used in this test are shown in Table 3-2.

Table 3-2: Test Conductor Main Characteristics

ID	Conductor	Manufacturer	Conductor Diameter [in]	RTS [lb.]
1	17KV #2 AWG, 7 HDCU Conductor	██████	0.292	2,898
2	17kv 2/0 AWG, 19 HDCU Conductor	██████	0.414	5,634
3	17kv 4/0 AWG, 19 HDCU Conductor	██████	0.522	8702
4	17kv 1/0 AWG, 6/1 ACSR Conductor	██████	0.398	4,160
5	17kv 336.4 KCMIL, 18/1 ACSR Conductor	██████	0.684	8,246
6	17kv 336.4 KCMIL, 30/7 ACSR Conductor	██████	0.741	16,435
7	17kv 653.9 KCMIL, 18/3 ACSR Conductor	██████	0.953	13,989

4 Test Setup

The loading was performed using a horizontal test machine. The dead-end span was simulated by attaching one end of the the test sample, as described above, to the pulling cylinder of the horizontal tensile machine and the other end to a dead-end insulator. The insulator was attached to composite crossarm (██████). The cross-arm was mounted on an I-beam frame, which was firmly fixed on the floor. A system of pulleys ensured that the conductor was at an angle coming off the insulator.

A schematic of the test set-up is shown in Figure 4-1 and Figure 4-2. A picture of the actual setup is shown in Figure 4-3.

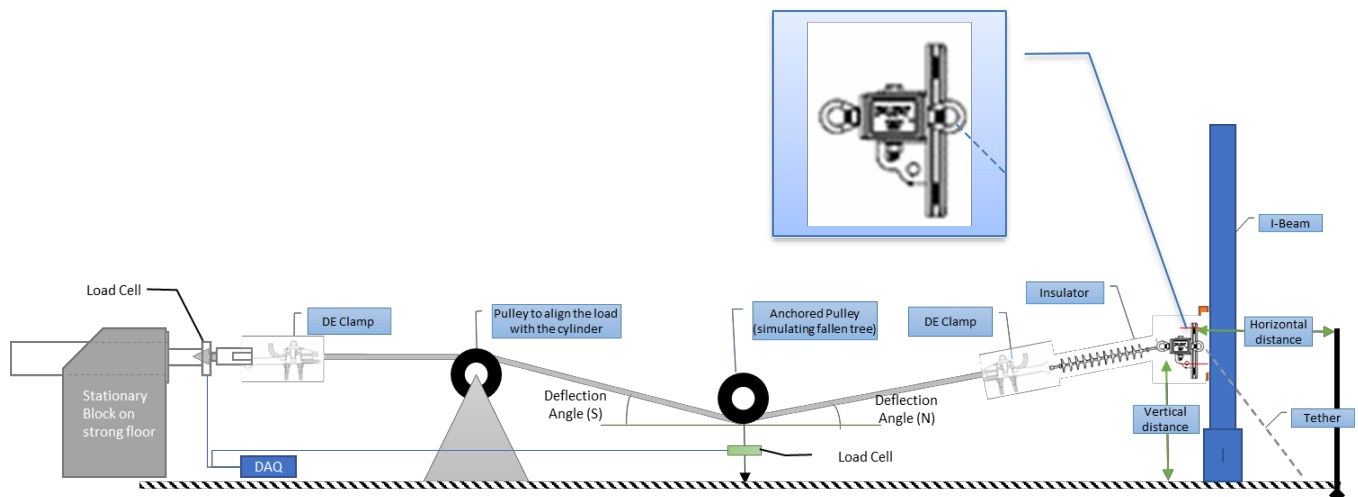

Figure 4-1: Full Mock-up: General View of the Test Setup

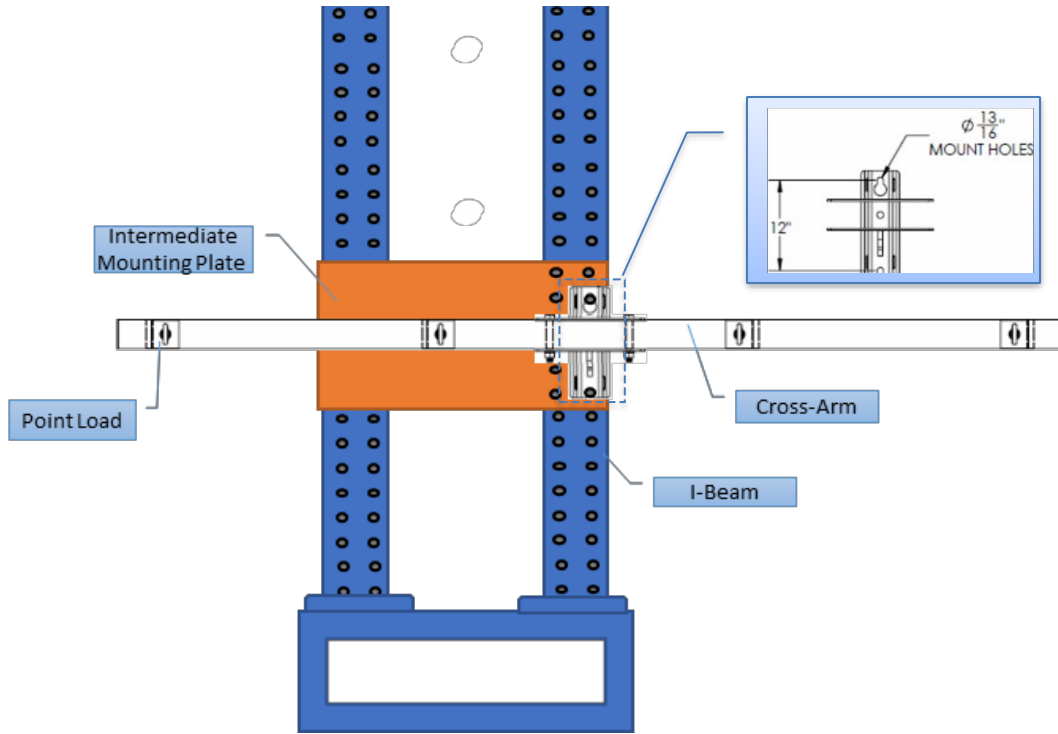

Figure 4-2: Full Mock-up: Front View of the Setup

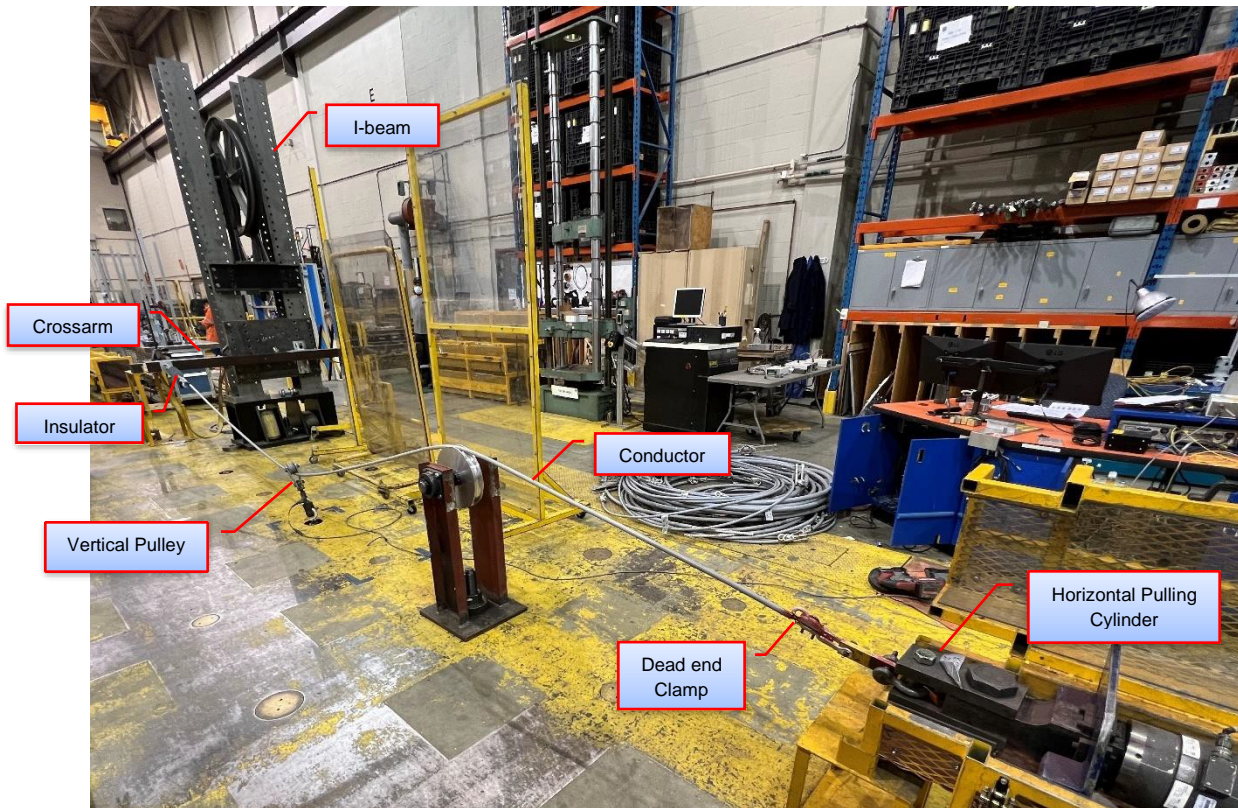

Figure 4-3: Full Mock-up: Picture of the Setup

The vertical load on the pulley was measured directly by attaching a load cell between the pulley and the floor. The conductor horizontal tension was measured by a load cell located at the hydraulic end of the sample. The controller for the hydraulically activated horizontal test machine recorded the horizontal tension. The data logging rate was every two (2) seconds.

The test was carried out in a temperature-controlled laboratory at $20\text{ }^{\circ}\text{C} \pm 2\text{ }^{\circ}\text{C}$.

5 Test Procedure

Once the setup is complete as shown in Figure 4-2, the test was conducted as follows:

1. A small pretension value was applied with the horizontal piston to remove the slack from the conductor and the conductor was marked at the entry points in the clamp.
2. The conductor tension was increased until the vertical load reached 1,000 lbs on the pulley simulating the fallen tree. The conductor at the insulator clamp was visually monitored for slippage.
3. The horizontal tensile load was then increased continuously at a rate of 1,000 lbs/min until failure occurred (either insulator, cross arm, or the conductor slips out of the insulator).

These steps were repeated for all samples. Pictures of the test samples were taken to document damage after the test. Video recordings of the tests were also provided for Exponent's future reference.

6 Test Results

The load and conductor slippage during the test were monitored and recorded. Test results are summarized in Table 6-1.

Loading profiles for each sample are shown in Figure 6-1 to Figure 6-7. Photos of the slippage and the sample after the test were taken for documentation purposes. Typical pictures of failure location are shown in Figure 6-11 to Figure 6-27. General observations from the test, common for all samples, are provided below:

- The test results show that, for smaller size conductors (#2 AWG Cu; 2/0 AWG CU; 4/0 AWG Cu and 1/0 AWG ACSR), the typical failure occurred as a result of the conductor slipping out of the dead-end clamp.
- For larger conductors with a higher RTS (336.4 kcmil and 653.9 kcmil) the typical failure point was the crossarm. The failure of the crossarm started at the bolts on the mounting plate and propagated to the insulator attachment point.
- Deformation of the mounting plate on the crossarm occurred in all instances.

Table 6-1: Summary of Test Results

Sample ID	Conductor	Dead End	Max Load		Deflection Angle		Failure Mode
			Horizontal (lbs.)	Vertical (lbs.)	South (degree)	North (degree)	
1.1	17kV CU, #2 AWG	[REDACTED]	3021	1443	15.1	12.4	Conductor broke at the South DE; deformed crossarm mounting plate.
1.2			2029	1365	15.3	11.9	Conductor pulled out of South DE; deformed crossarm mounting plate.
1.3			2900	1352	15.7	12.2	Conductor pulled out of South DE; deformed crossarm mounting plate.
2.1	17kV CU, 2/0 AWG	[REDACTED]	1367	567	16.3	15.0	Conductor pulled out of North DE; deformed crossarm mounting plate.
2.2			1570	767	16.0	14.6	Conductor pulled out of South DE; deformed crossarm mounting plate.
2.3			2753	1375	16.9	16.8	Conductor pulled out of South DE; deformed crossarm mounting plate.
3.1	17kV CU, 4/0 AWG	[REDACTED]	1447	693	17.0	12.3	Conductor pulled out of North DE; deformed crossarm mounting plate.
3.2			3257	1503	15.9	11.4	Conductor pulled out of South DE; deformed crossarm mounting plate.
3.3			3030	1509	17.0	16.0	Conductor pulled out of South DE; deformed crossarm mounting plate.
4.1	17kV ACSR 1/0 AWG, 6/1	[REDACTED]	3543	1776	15.8	13.5	Failure at the crossarm (fracture at the center bolt). No conductor slippage at the clamp.
4.2			2973	1410	15.5	13.4	Conductor pulled out of the North DE. deformed crossarm mounting plate.
4.3			2832	1418	16.8	15.6	Conductor pulled out of the South DE. deformed crossarm mounting plate.
5.1	17kV ACSR 336.4 KCMIL, 18/1	[REDACTED]	3683	1739	14.5	16.4	Complete crossarm failure; deformed mounting plate; No conductor slippage at the clamp.
5.2			3709	1771	16.5	12.3	Complete crossarm failure; deformed mounting plate; No conductor slippage at the clamp.
5.3			3607	1720	16.6	12.6	Complete crossarm failure; deformed mounting plate; No conductor slippage at the clamp.
6.1	17kV ACSR 336.4 KCMIL, 30/7	[REDACTED]	3387	1628	16.1	13.2	Complete crossarm failure; deformed mounting plate; No conductor slippage at the clamp.
6.2			3798	1831	15.9	12.4	Complete crossarm failure; deformed mounting plate; No conductor slippage at the clamp.
6.3			3726	1786	16.2	12.0	Complete crossarm failure; deformed mounting plate; No conductor slippage at the clamp.
7.1	17kV ACSR 653.9 KCMIL, 18/3	[REDACTED]	3957	2130	17.1	17.3	Complete crossarm failure; deformed mounting plate; No conductor slippage at the clamp.
7.2			3877	1973	17.2	14.6	Complete crossarm failure; deformed mounting plate; No conductor slippage at the clamp.
7.3			3833	1858	17.3	13.2	Complete crossarm failure; deformed mounting plate; No conductor slippage at the clamp.

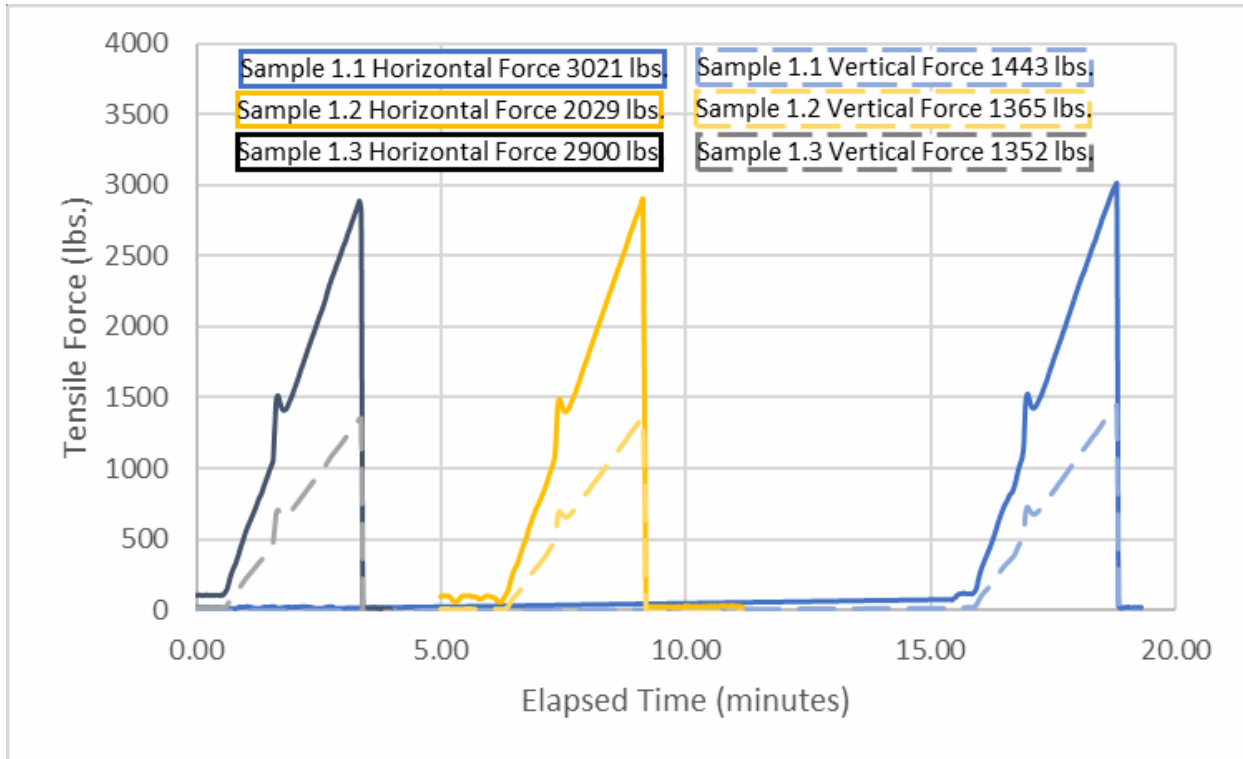

Figure 6-1: Test Load Profile: 17KV #2 AWG, 7 CU Conductor

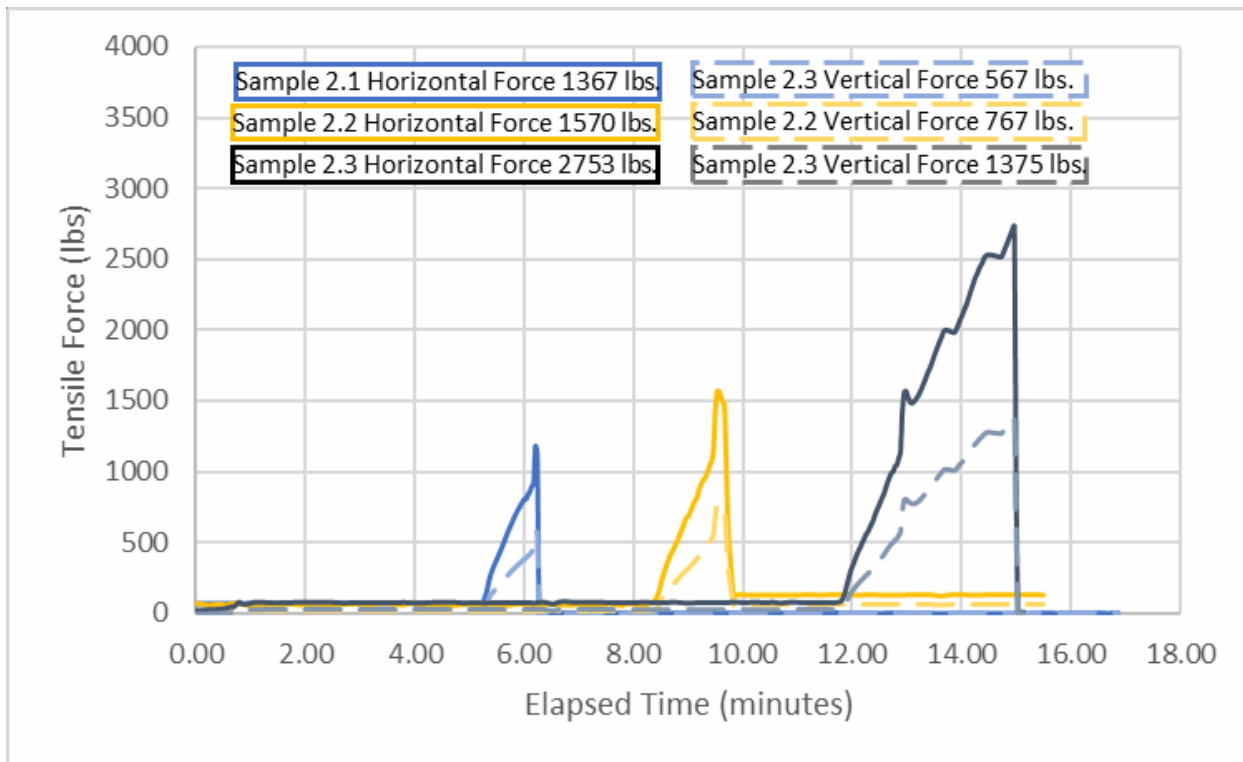

Figure 6-2: Test Load Profile: 17kV 2/0 AWG, 19 CU Conductor

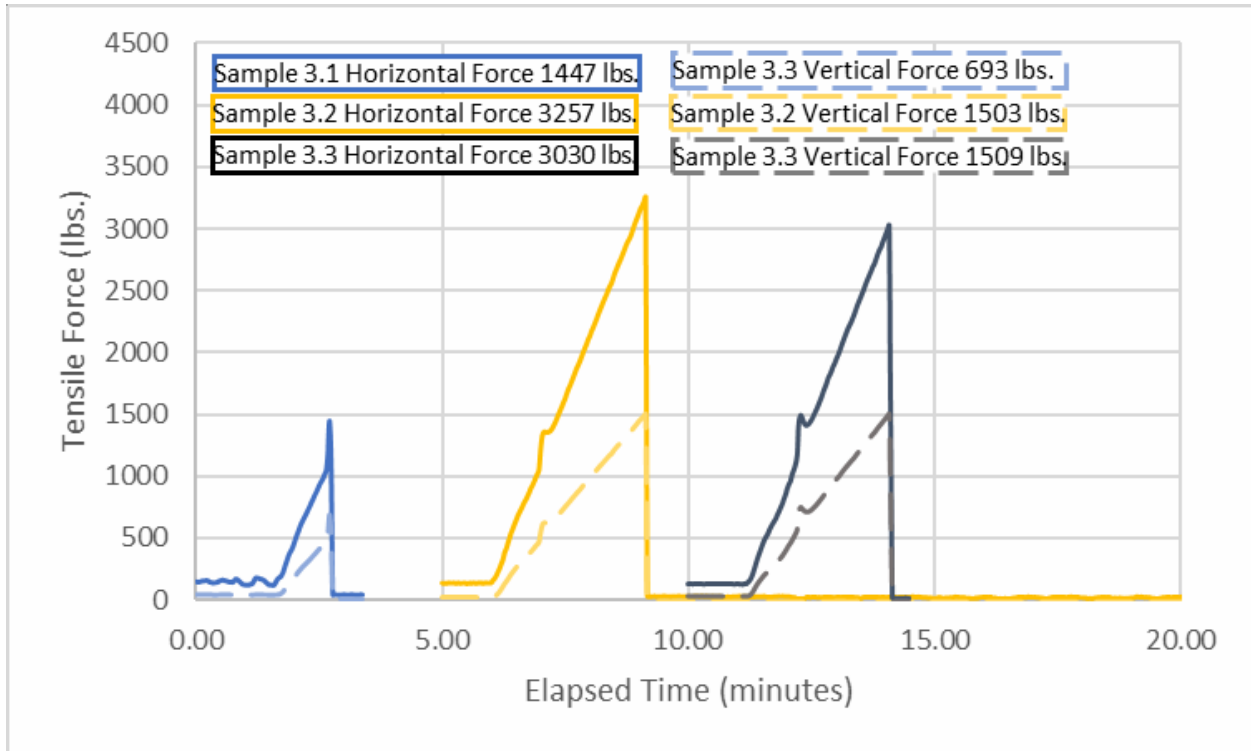

Figure 6-3: Test Load Profile: 17kV 4/0 AWG, 19 CU Conductor

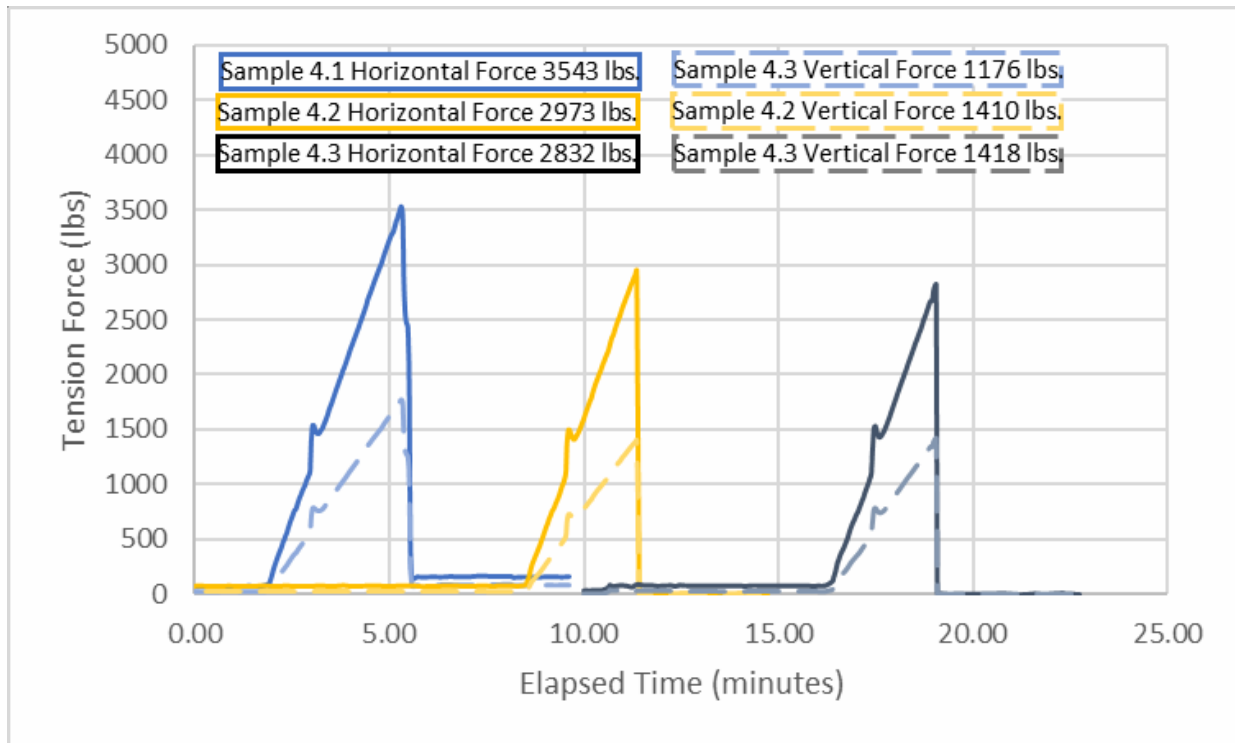

Figure 6-4: Test Load Profile: 17kV 1/0 AWG, 6/1 ACSR Conductor

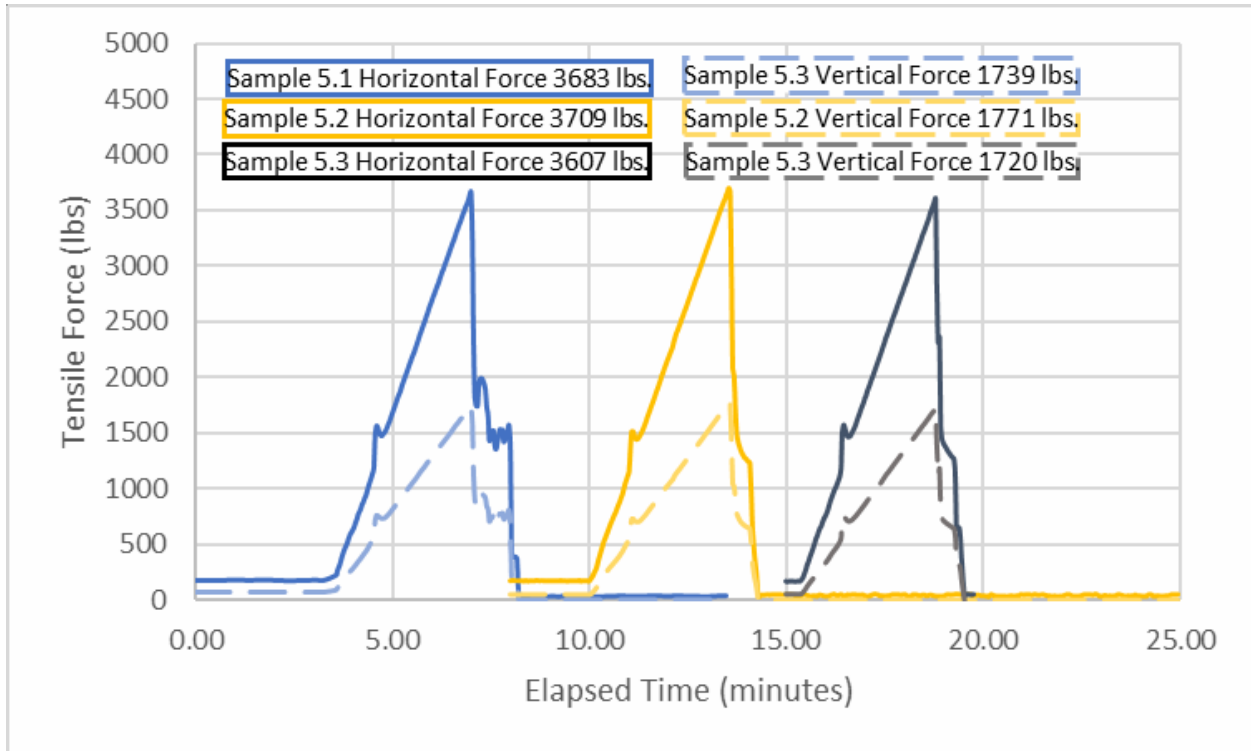

Figure 6-5: Test Load Profile: 17kV 336.4 KCMIL, 18/1 ACSR Conductor

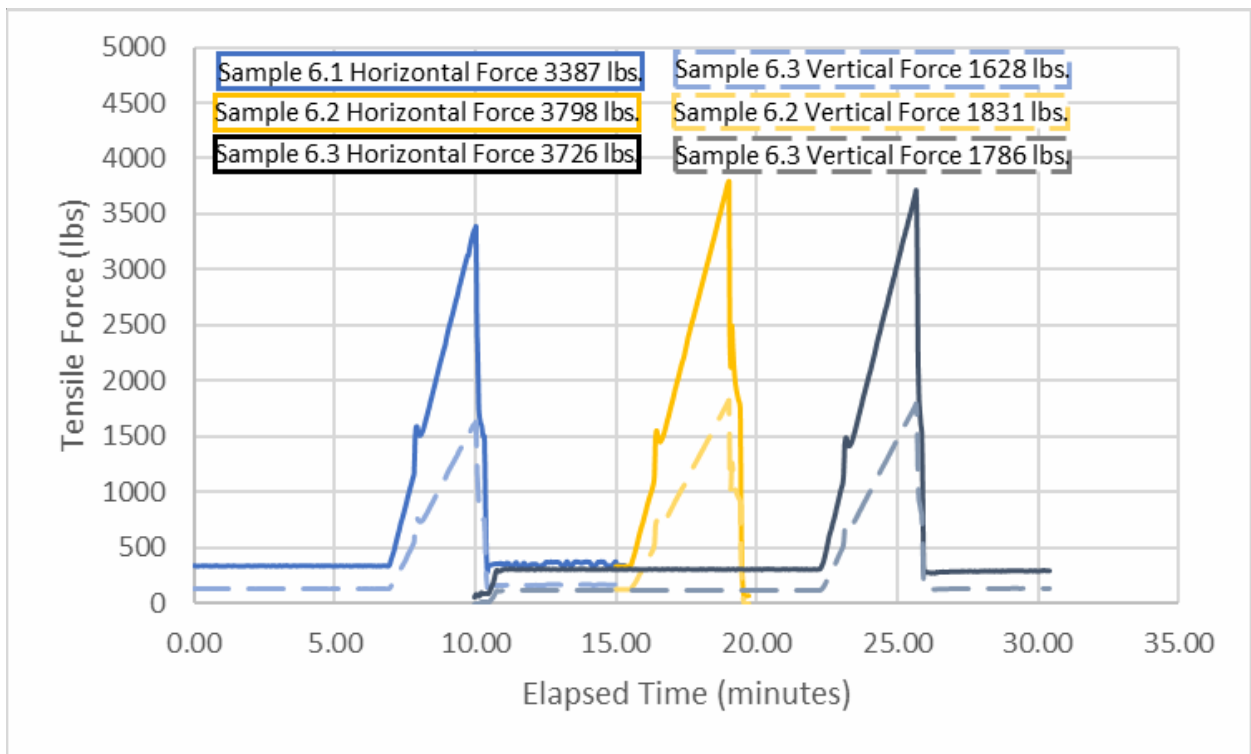

Figure 6-6: Test Load Profile: 17kV 336.4 KCMIL, 30/7 ACSR Conductor

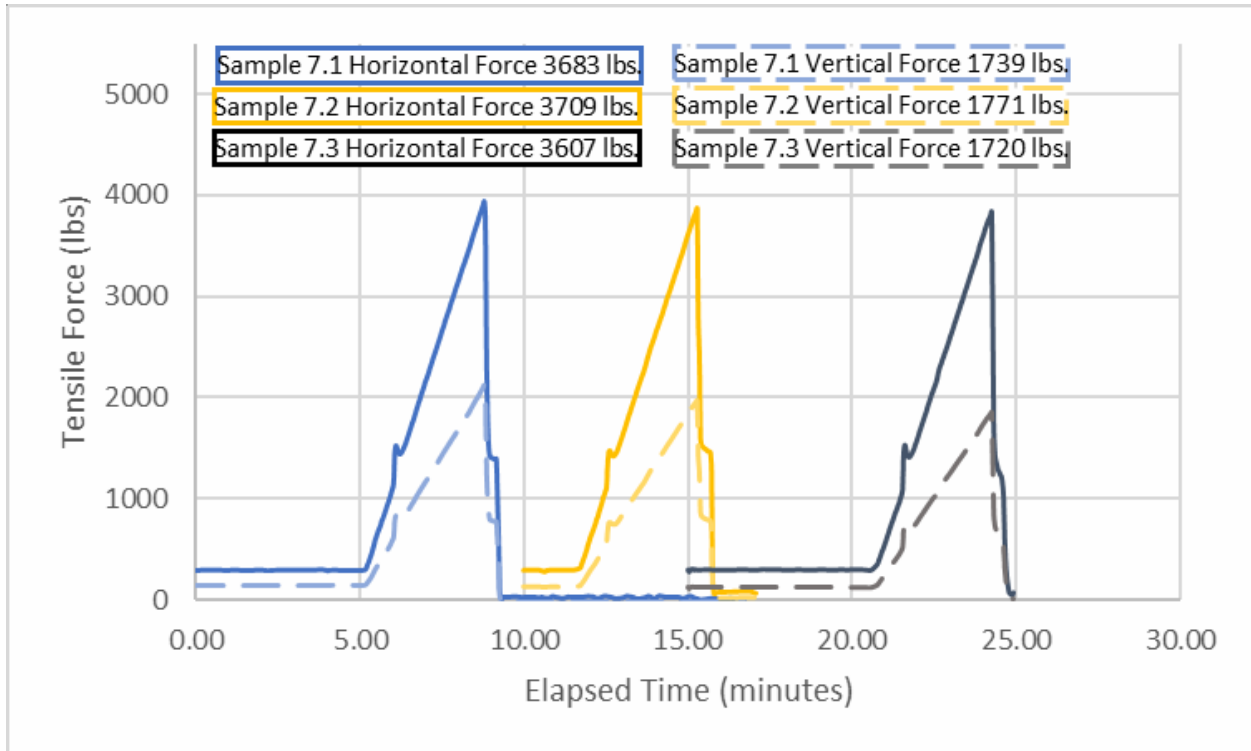

Figure 6-7: Test Load Profile: 17kV 653.9 KCMIL, 18/3 ACSR Conductor

[The remainder of this page is intentionally left blank.]

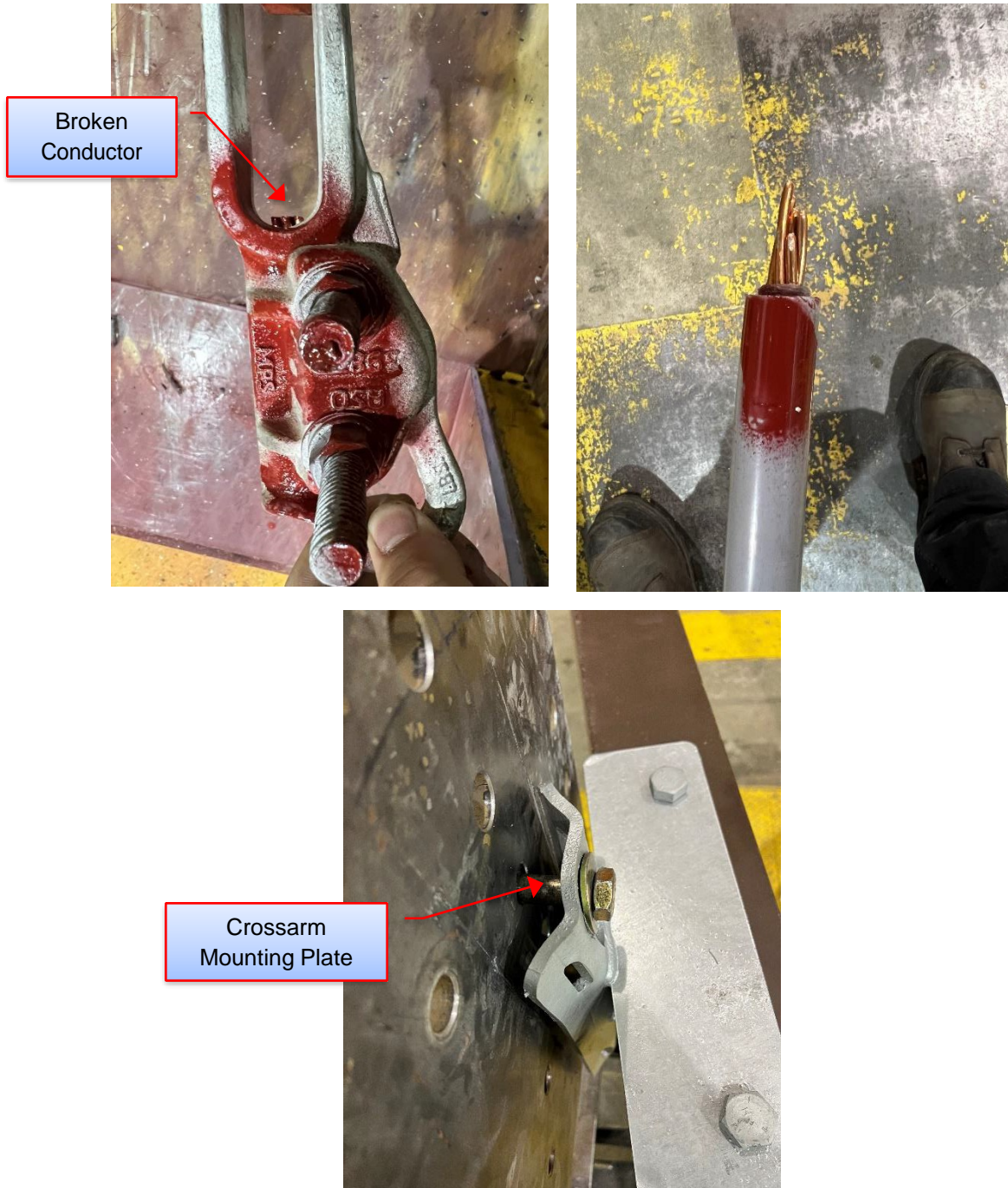

Figure 6-8: Sample 1.1 – Failure Location

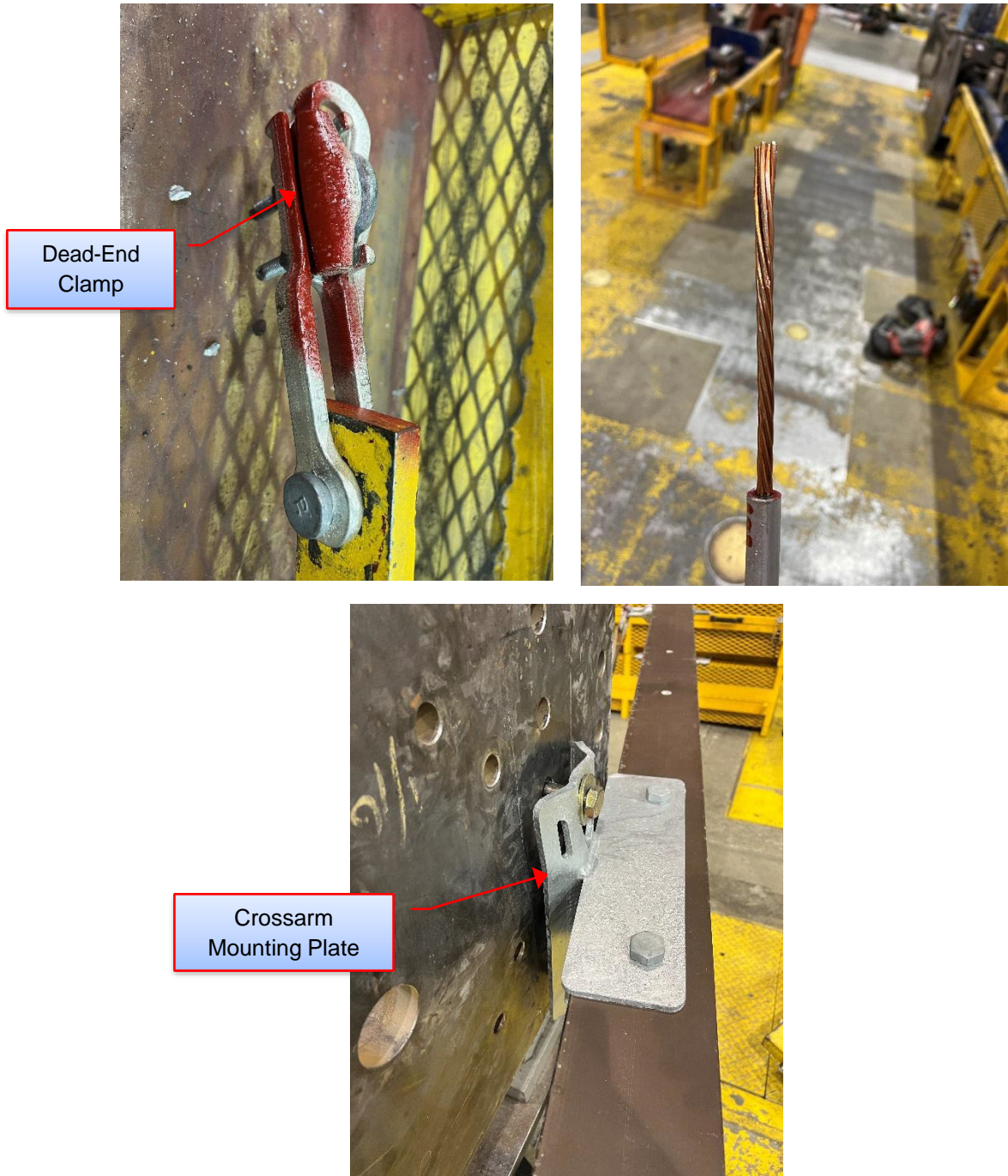

Figure 6-9: Sample 1.2 – Failure Location

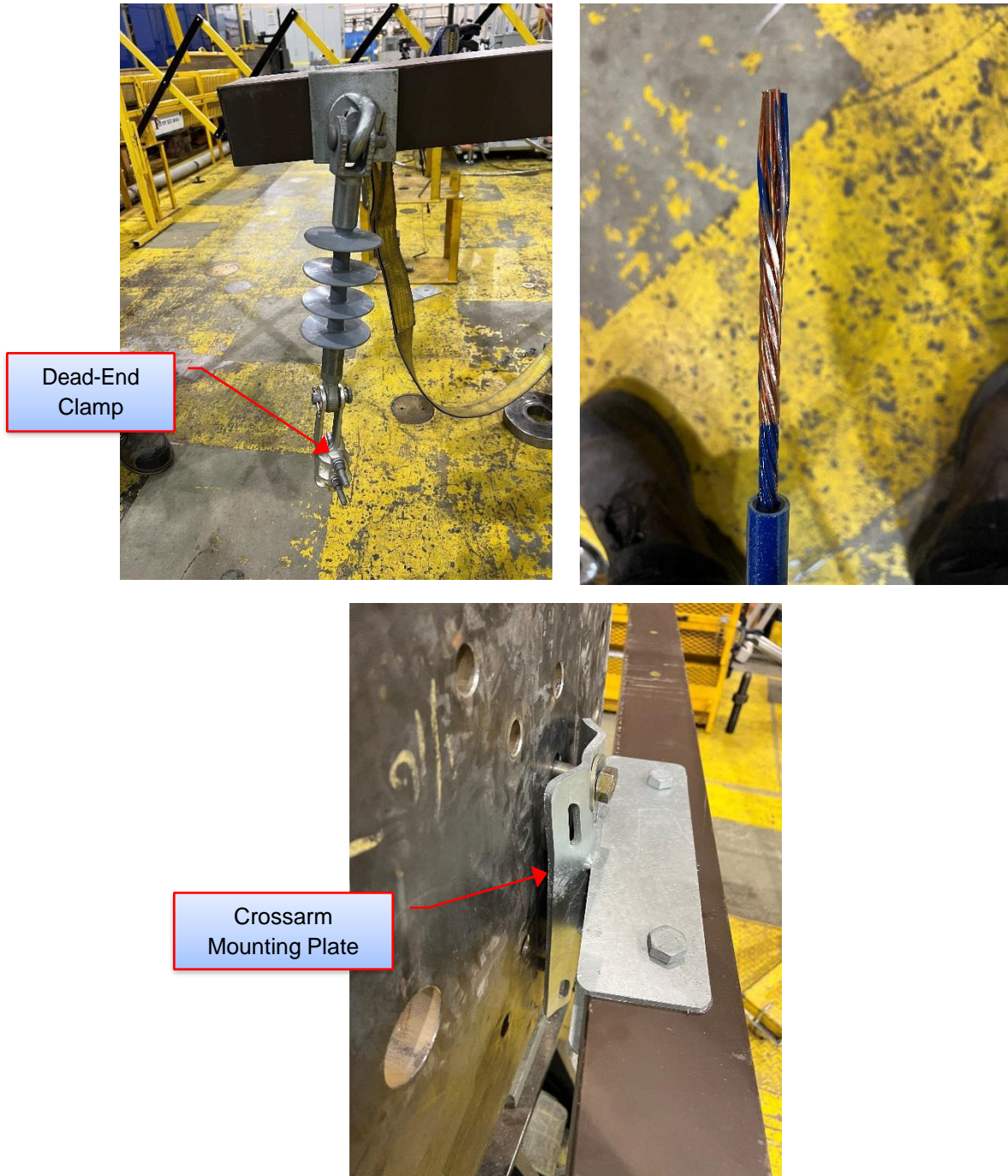

Figure 6-10: Sample 1.3 – Failure Location

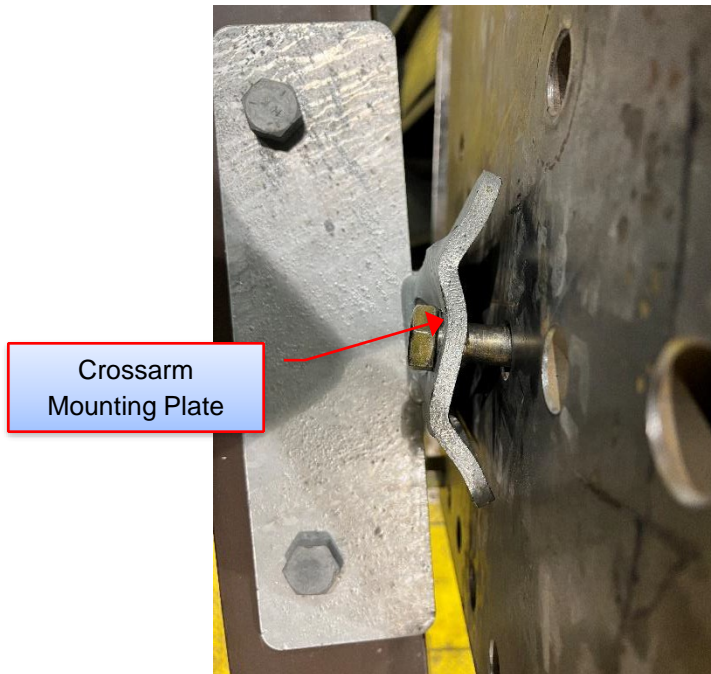

Figure 6-11: Sample 2.1 – Failure Location

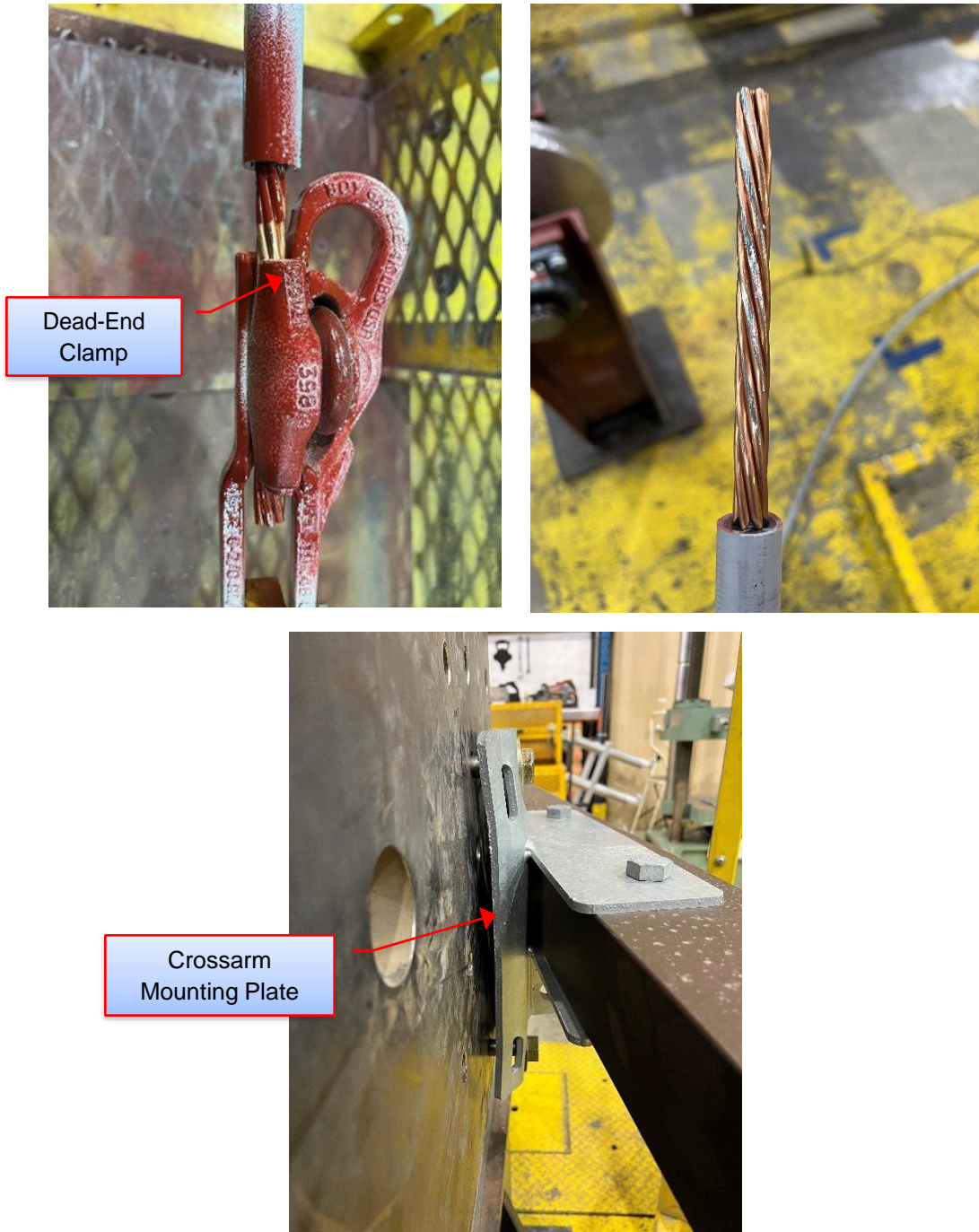

Figure 6-12: Sample 2.2 – Failure Location

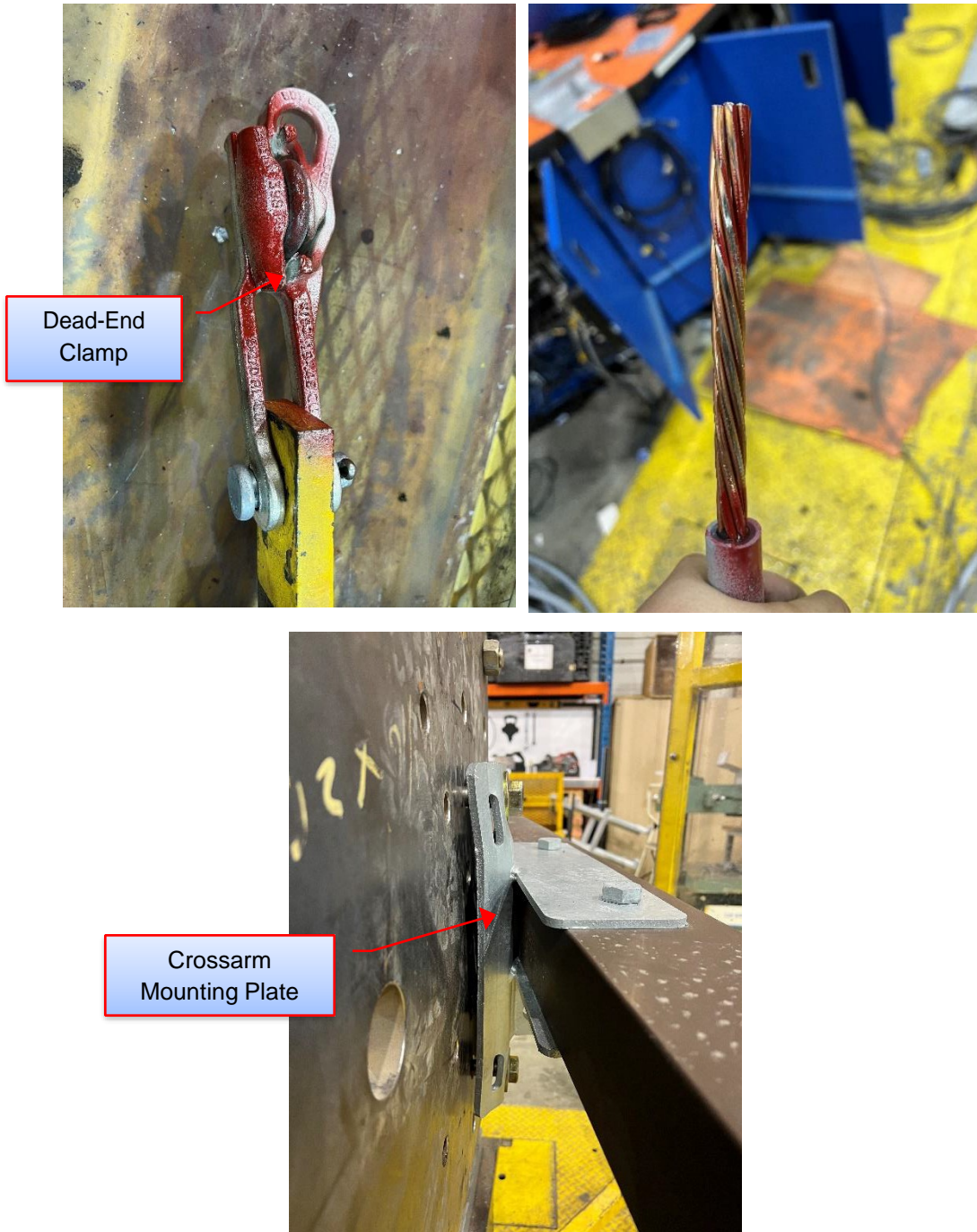

Figure 6-13: Sample 2.3 – Failure Location

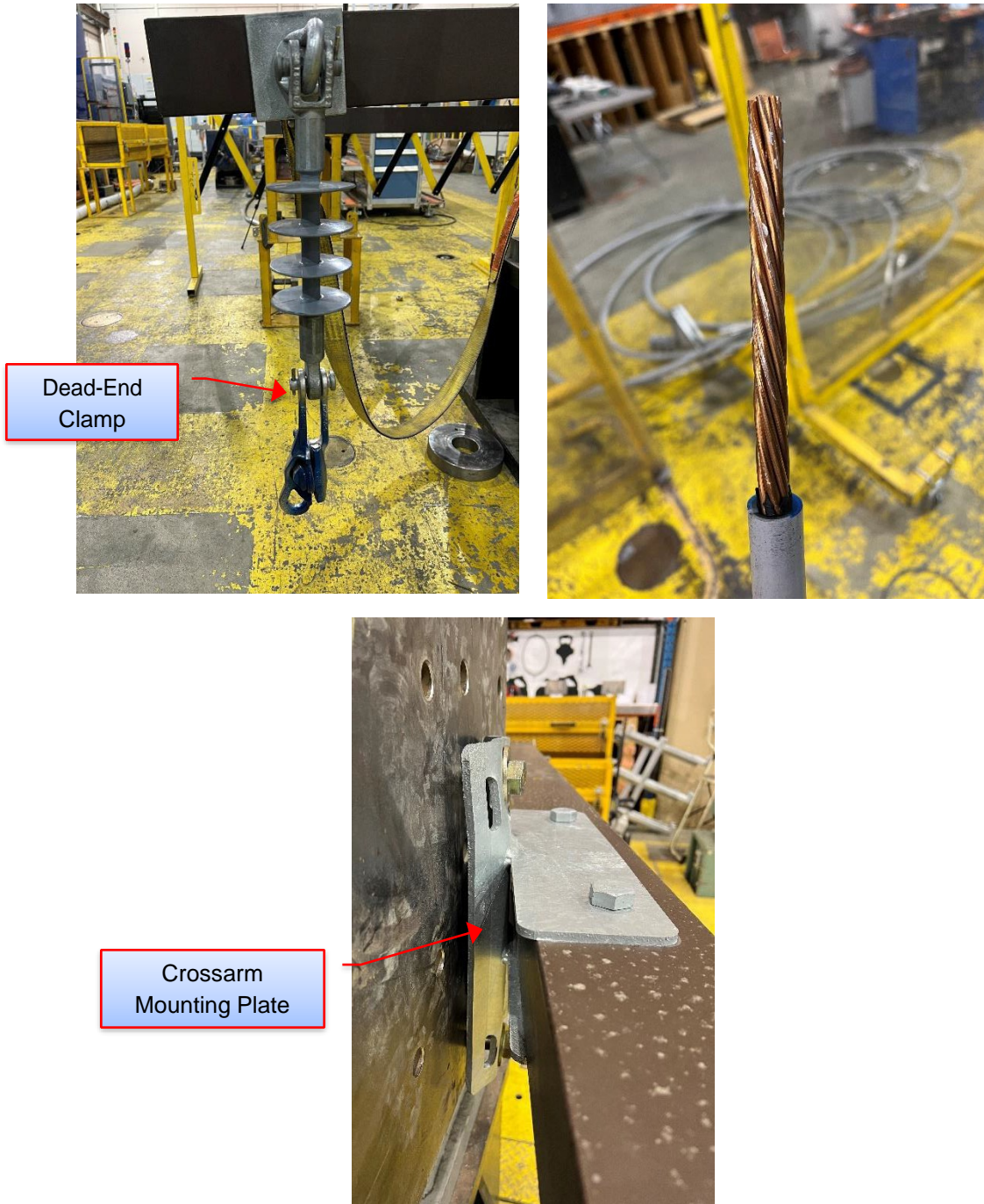

Figure 6-14: Sample 3.1 – Failure Location



Figure 6-15: Sample 3.2 – Failure Location

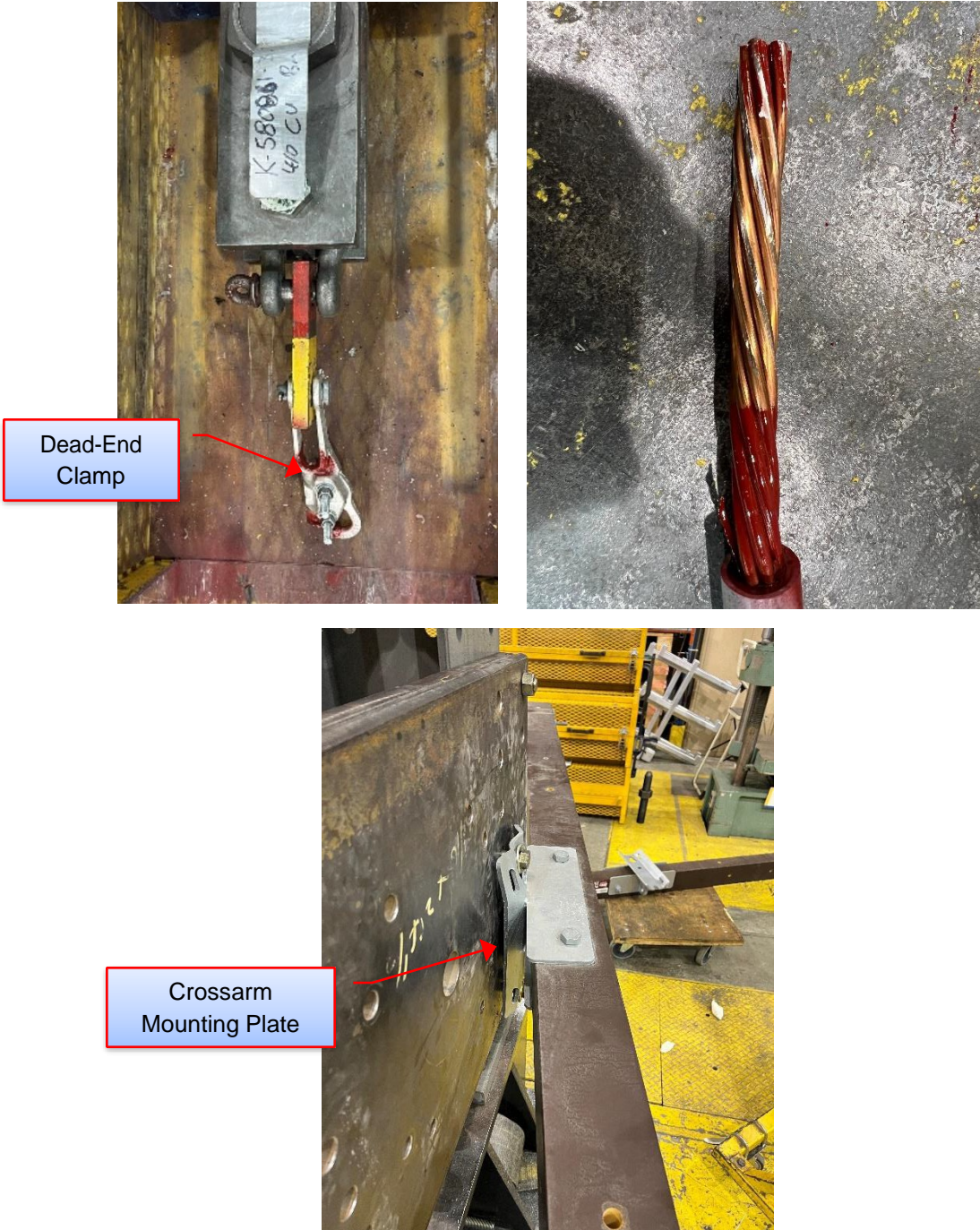

Figure 6-16: Sample 3.3 – Failure Location



Figure 6-17: Sample 4.1 – Failure Location

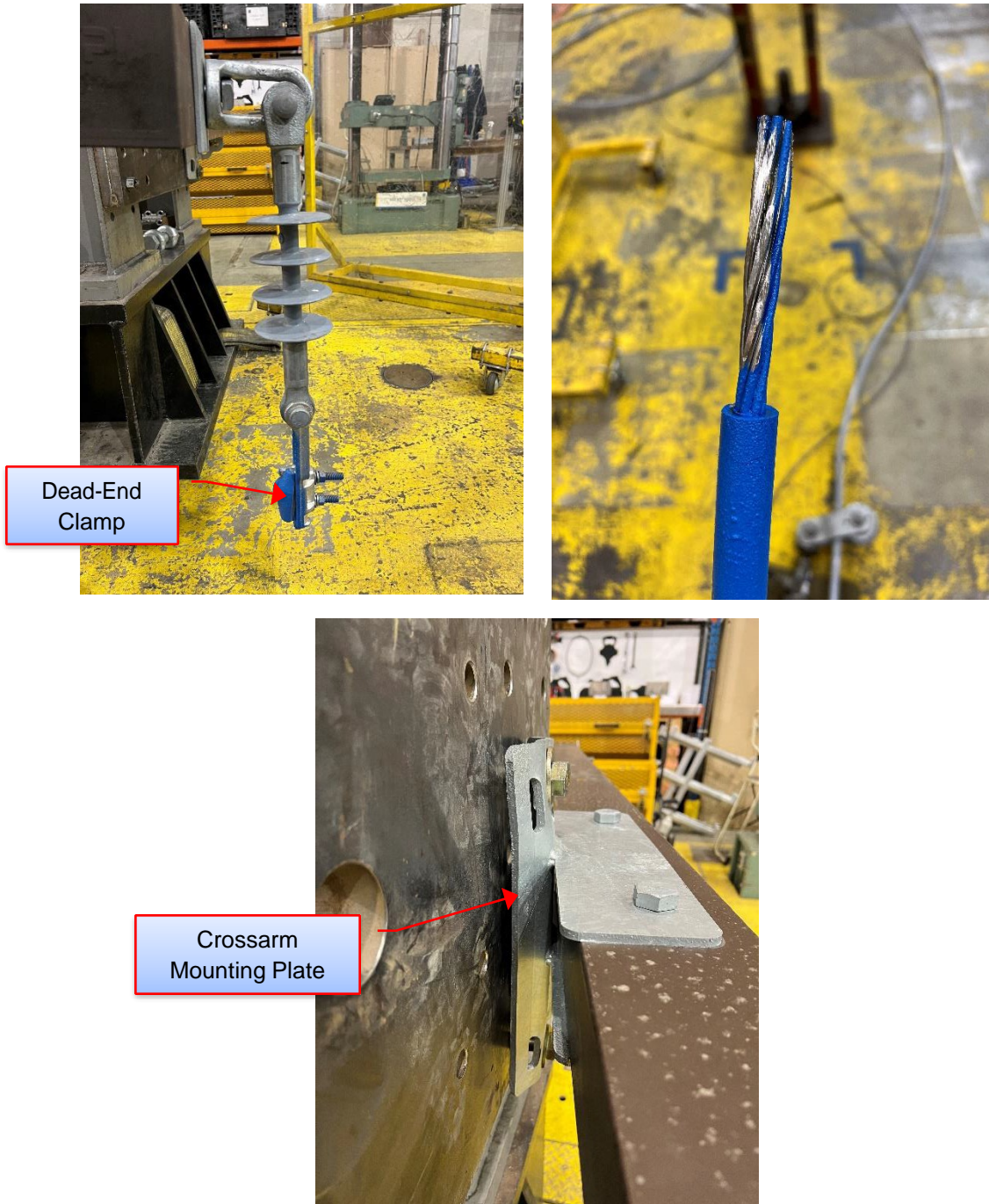

Figure 6-18: Sample 4.2 – Failure Location

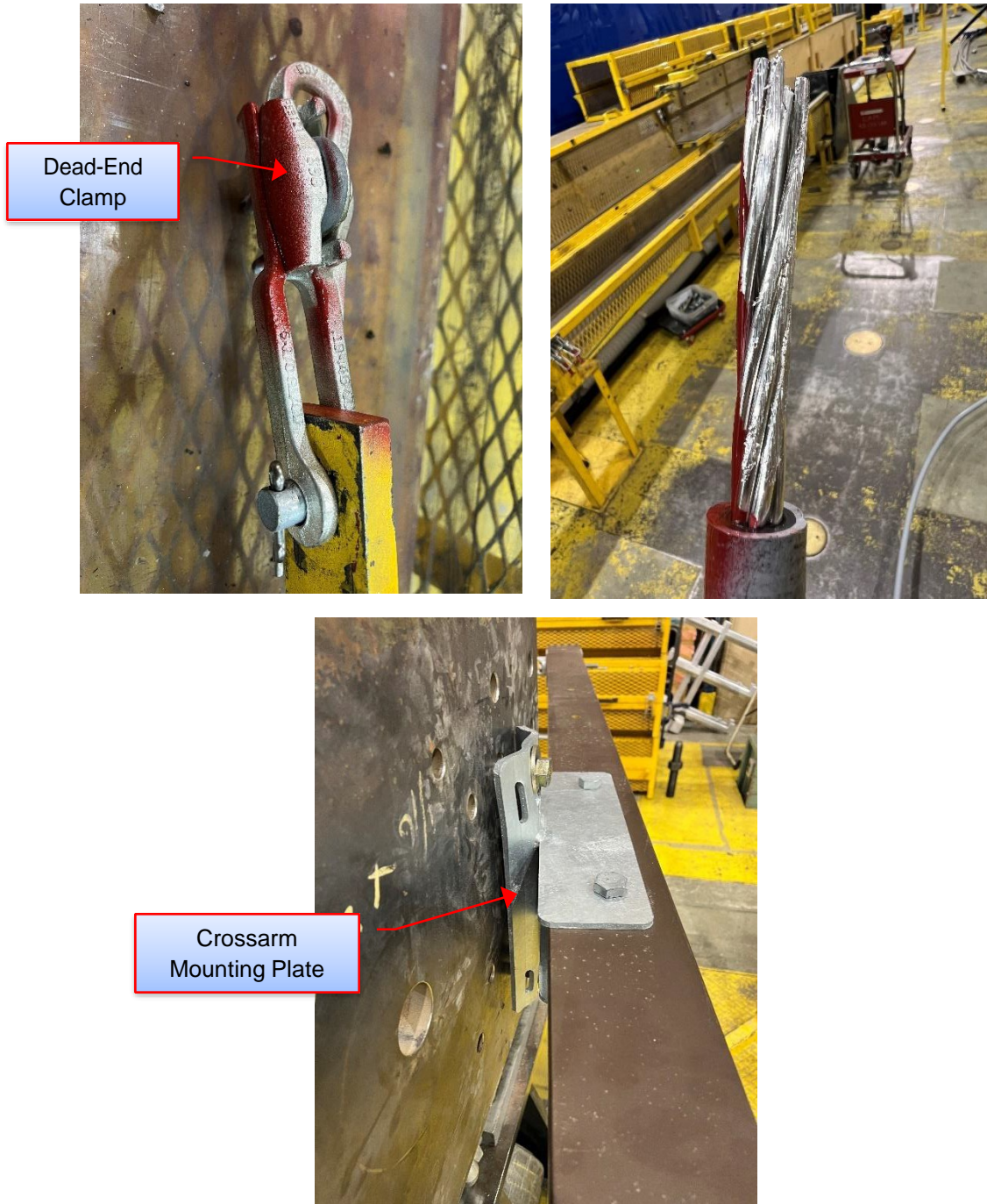

Figure 6-19: Sample 4.3 – Failure Location

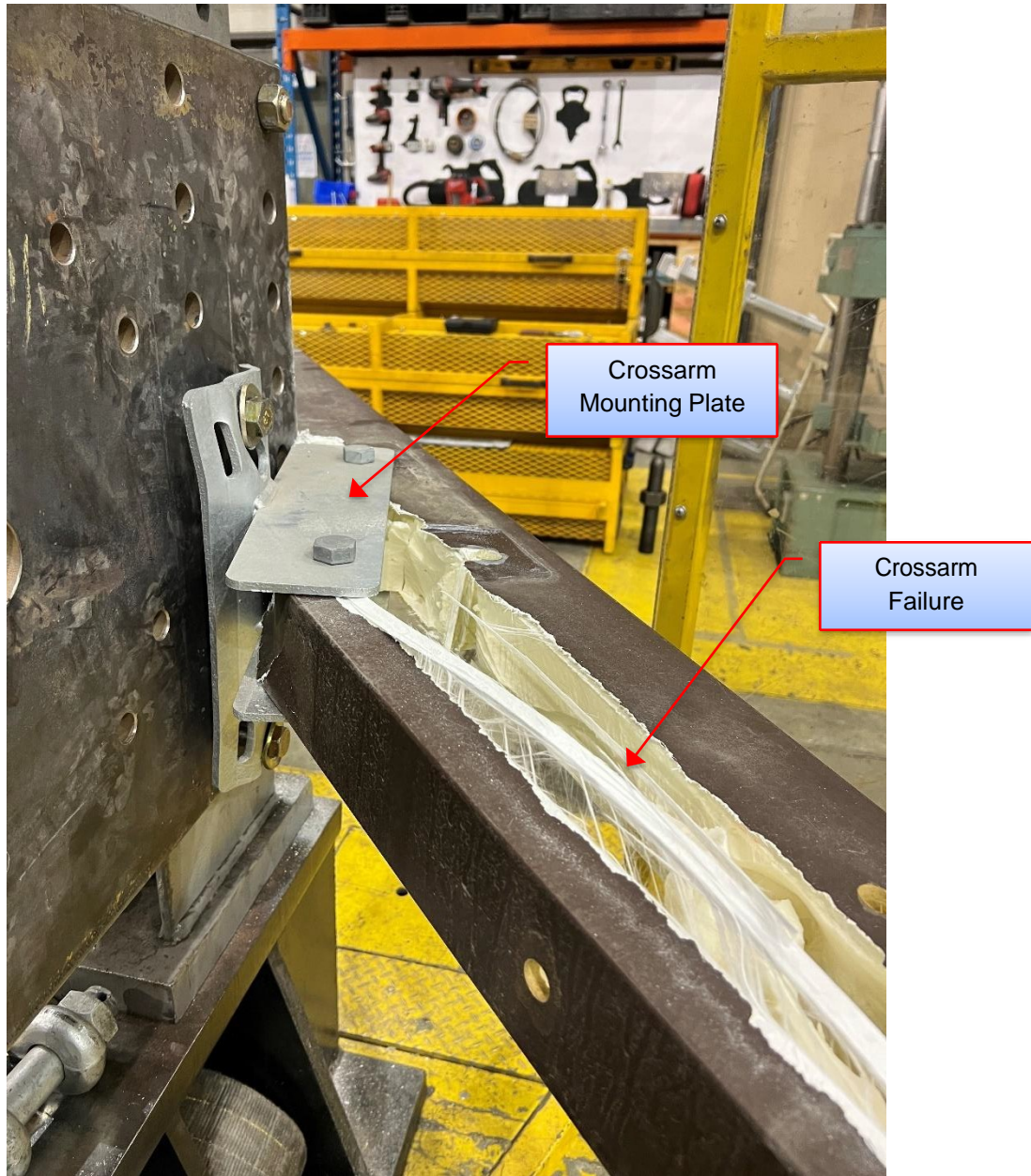

Figure 6-20: Sample 5.1 – Failure Location

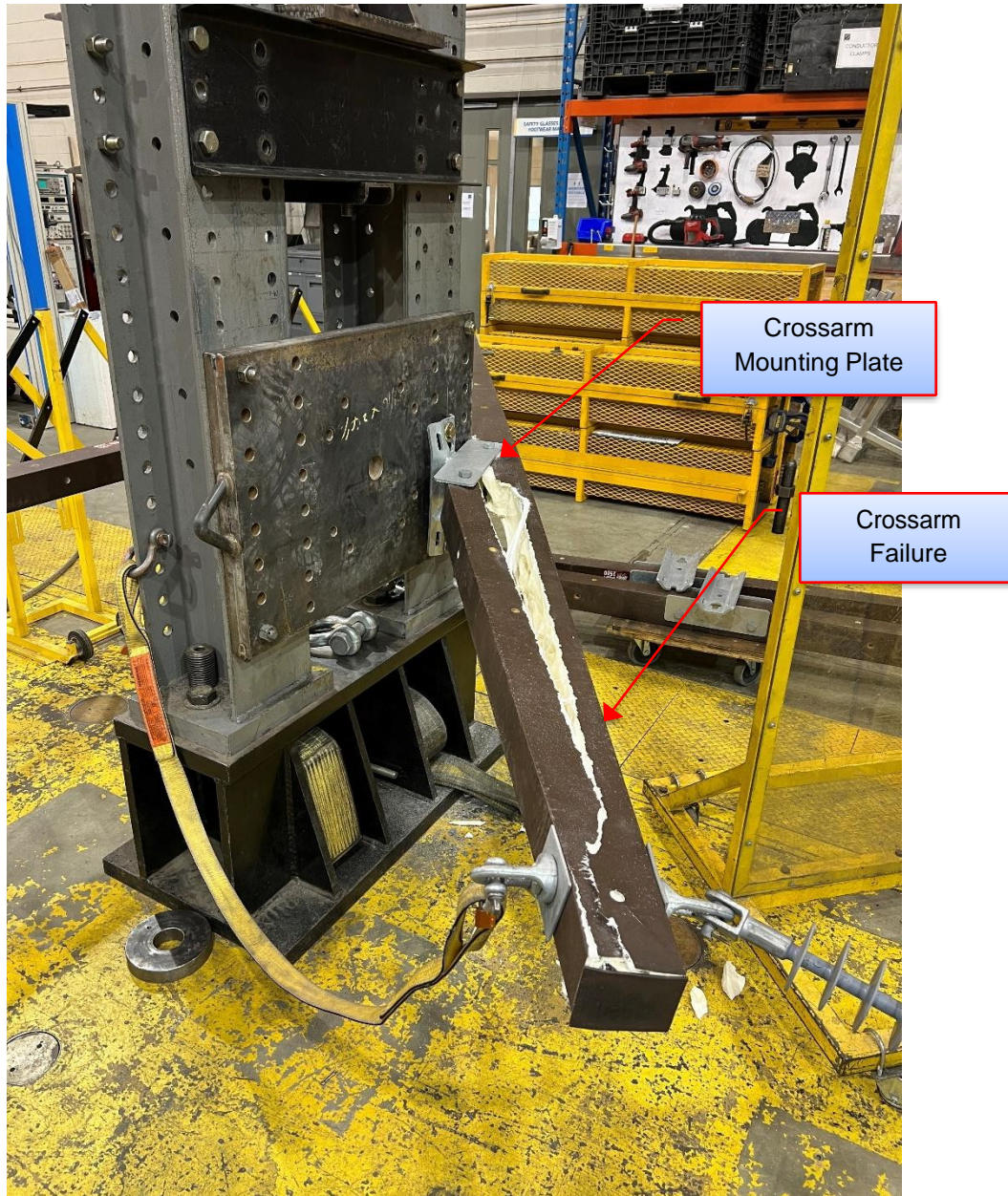

Figure 6-21: Sample 5.3 – Failure Location

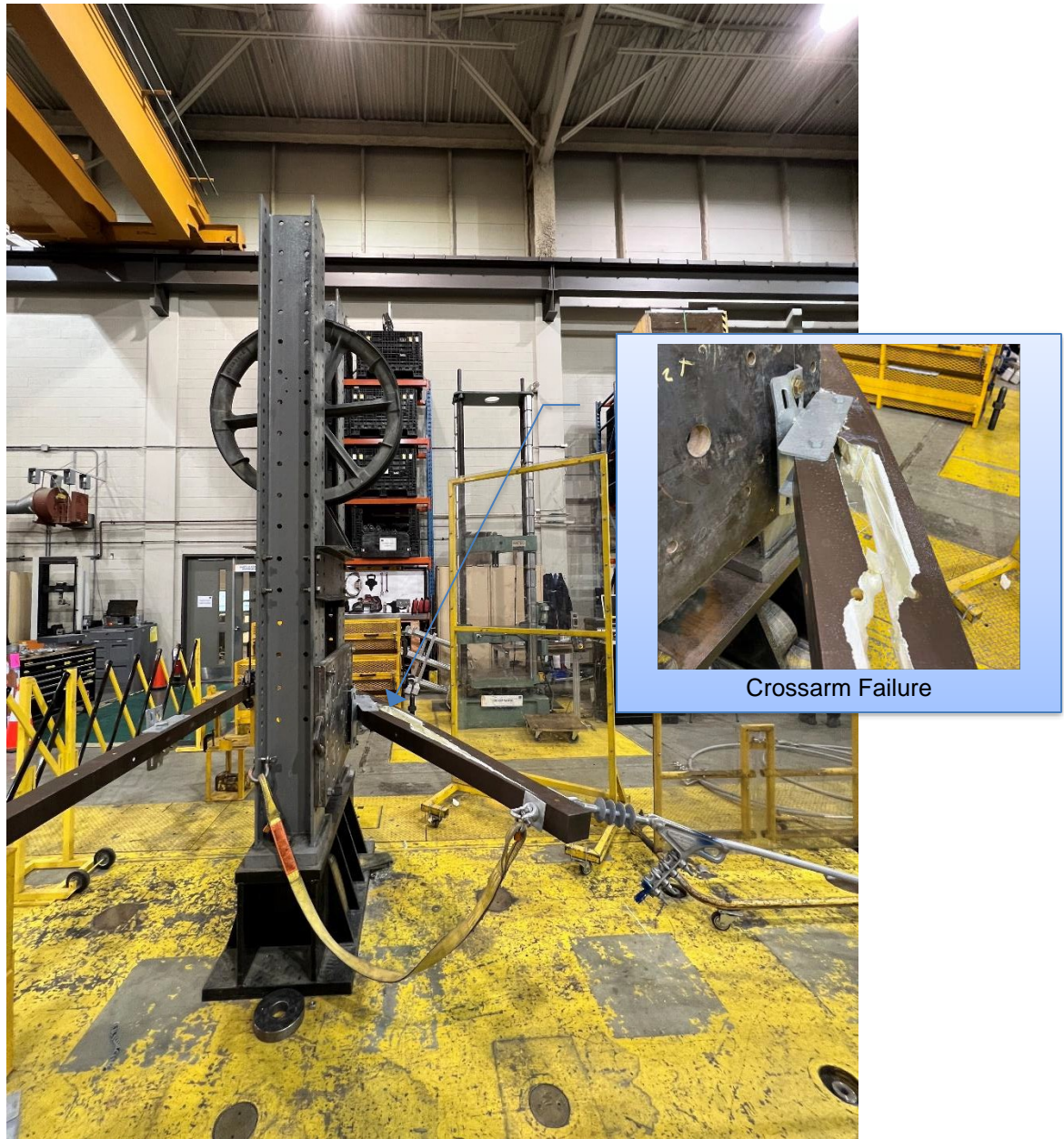

Figure 6-22: Sample 6.1 – Failure Location

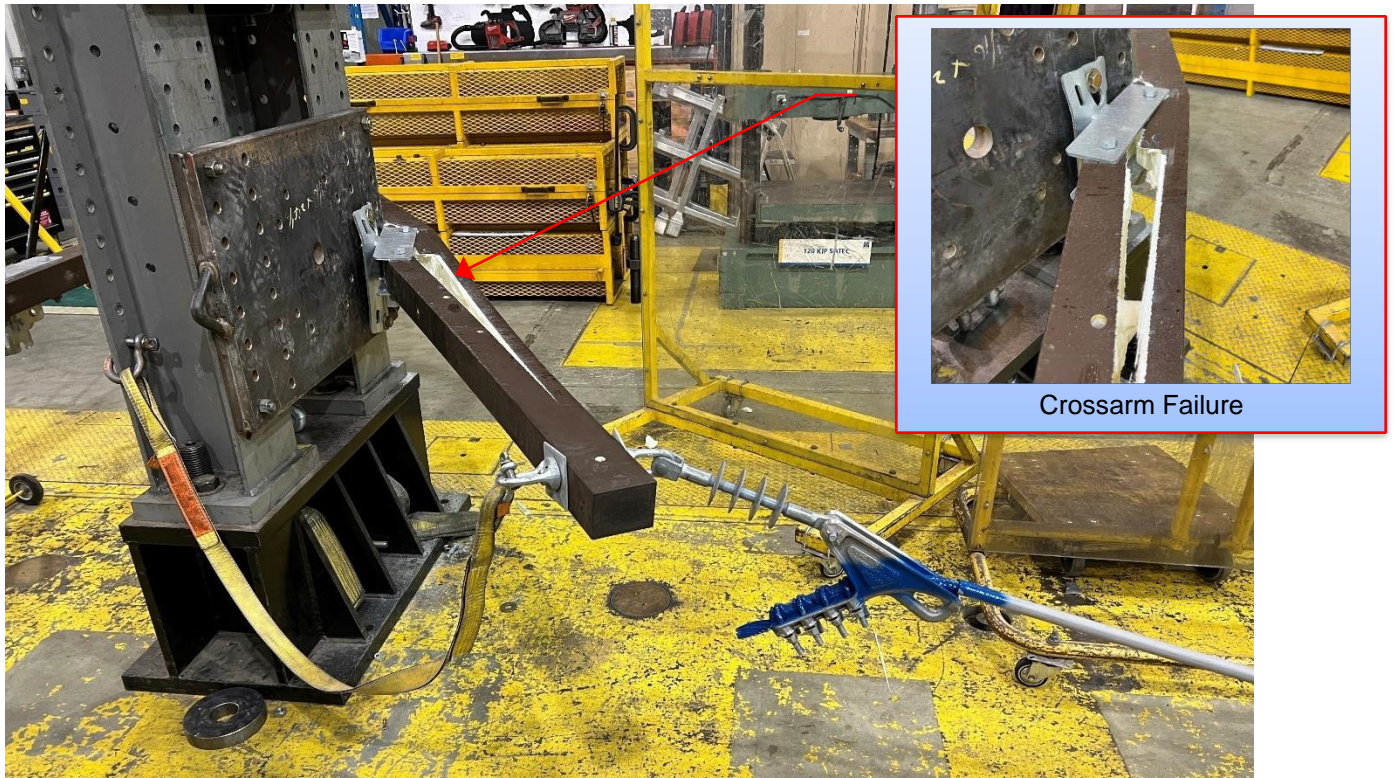

Figure 6-23: Sample 6.2 – Failure Location

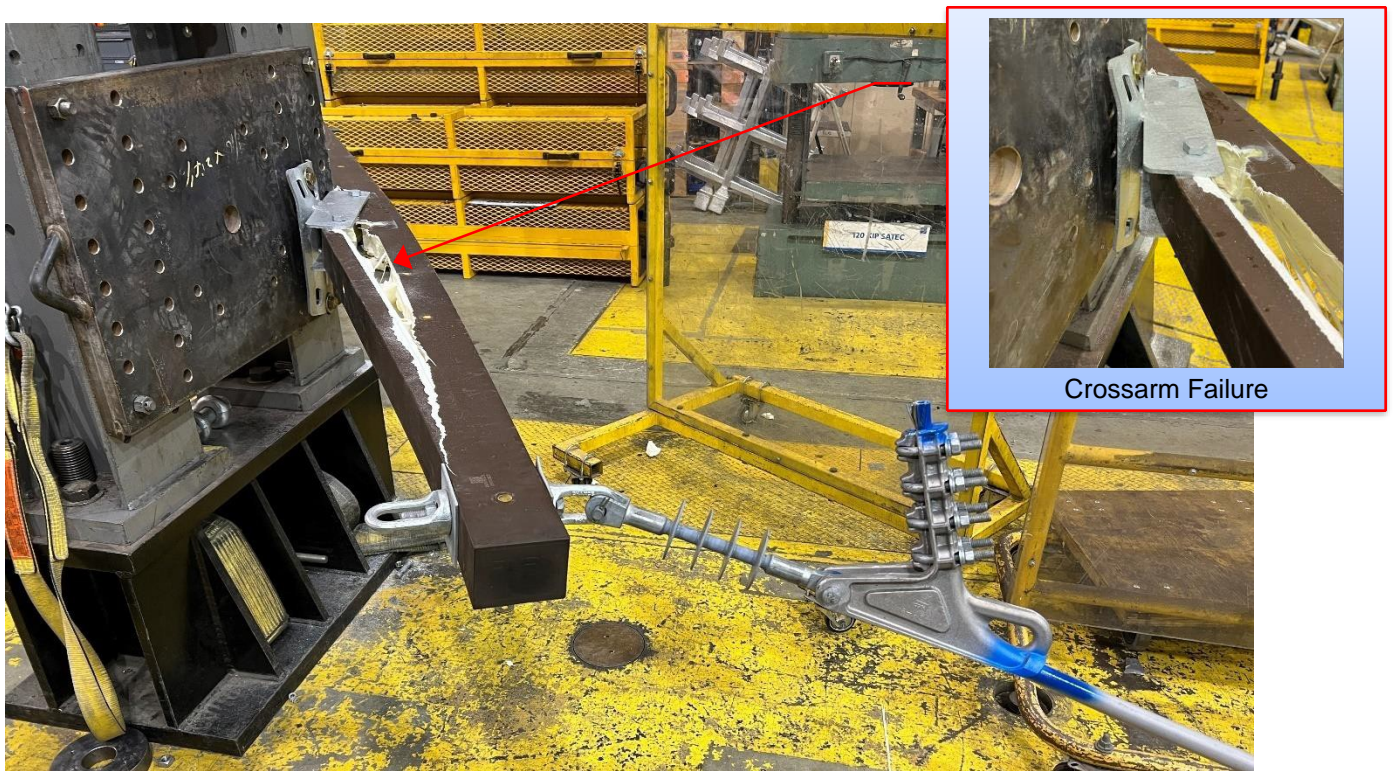

Figure 6-24: Sample 6.3 – Failure Location

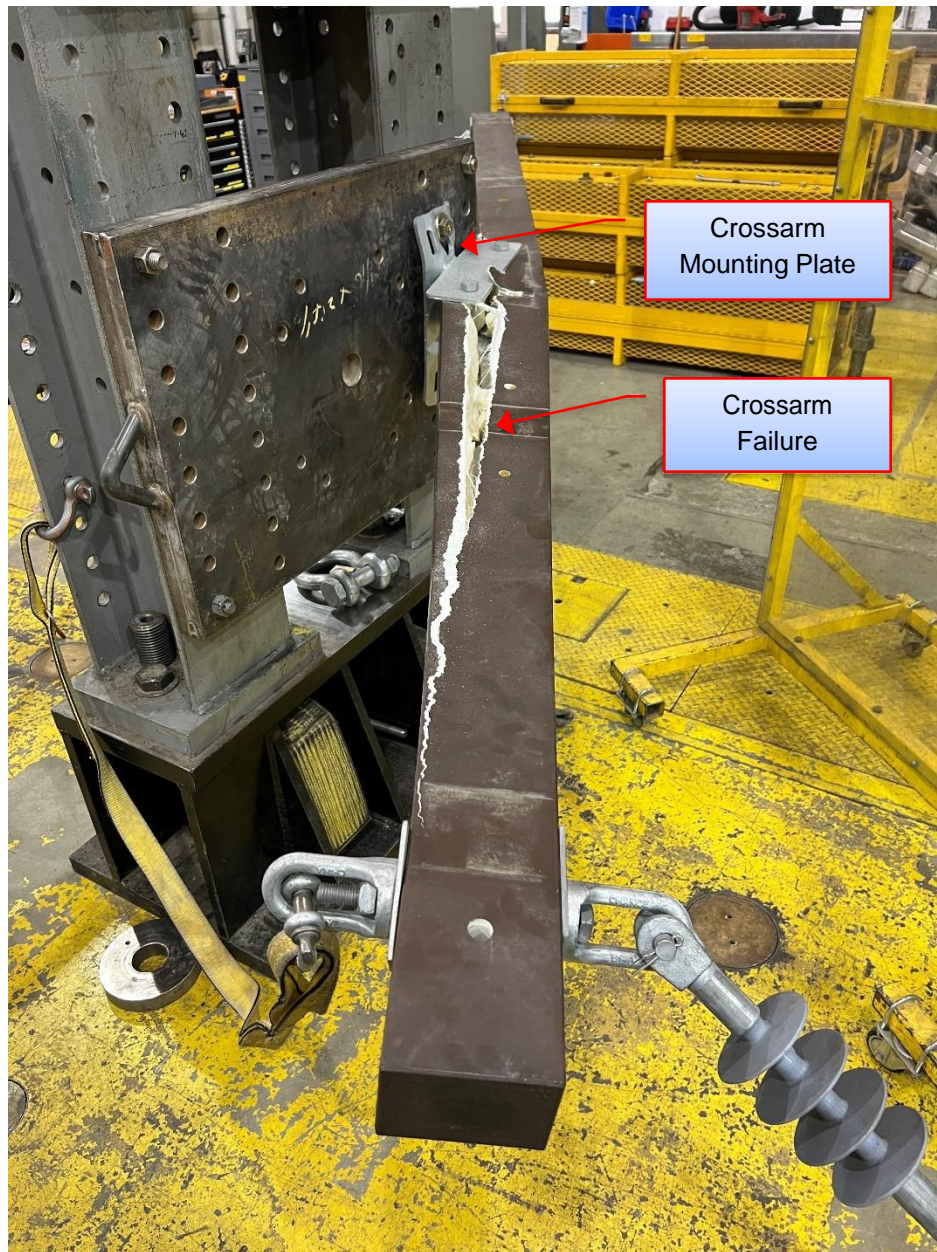

Figure 6-25: Sample 7.1 – Failure Location

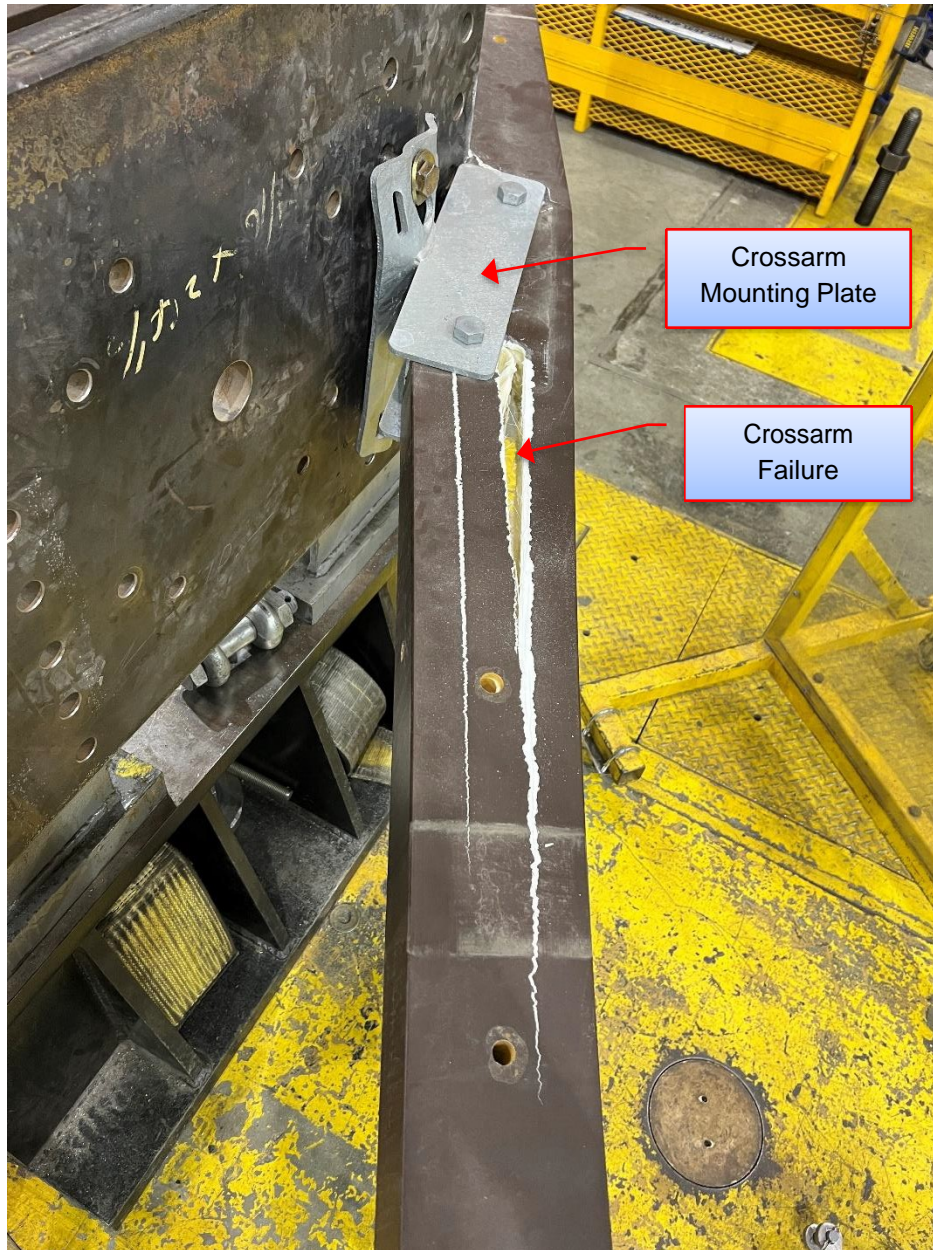

Figure 6-26: Sample 7.2 – Failure Location

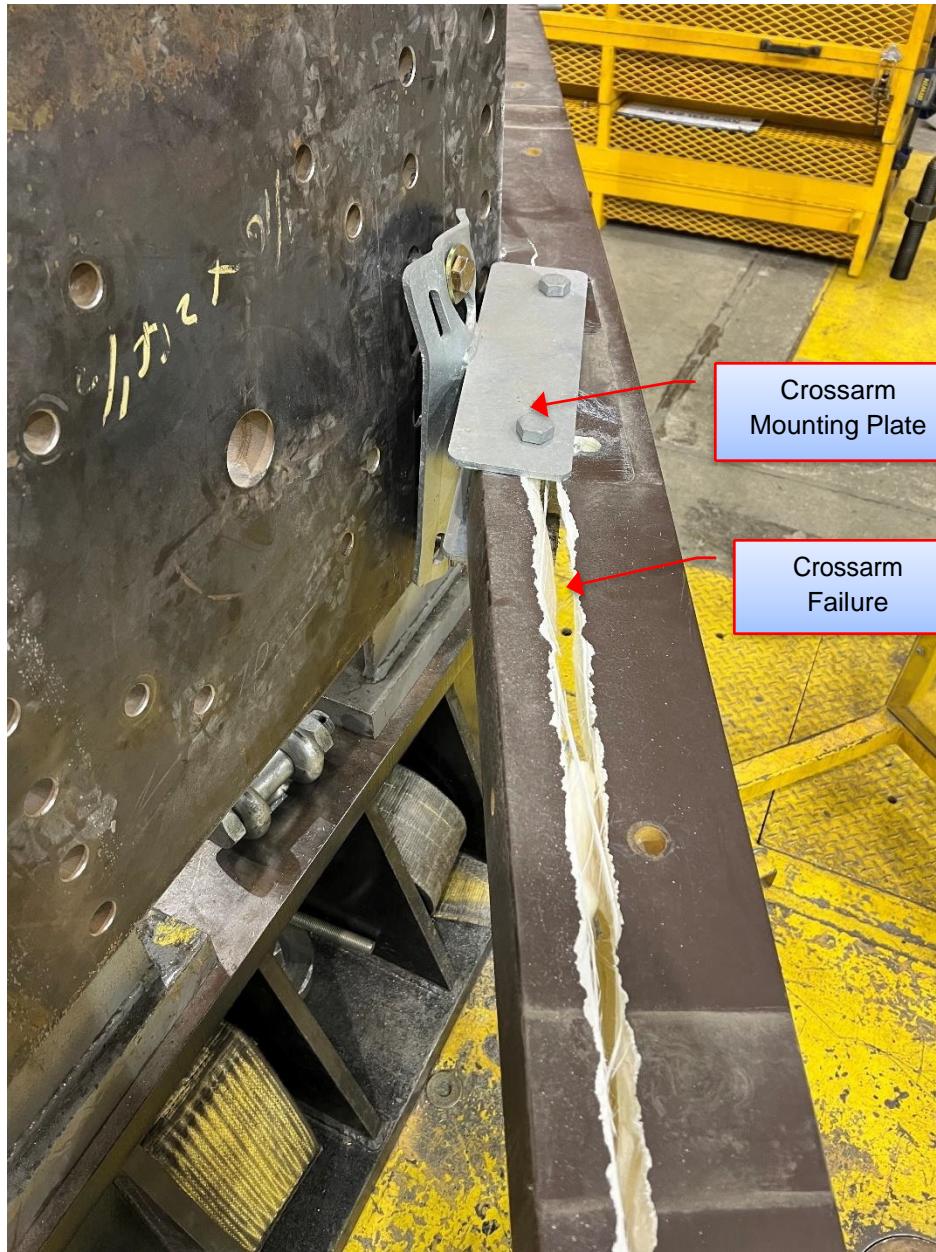

Figure 6-27: Sample 7.3 – Failure Location

7 Acceptance Criteria

There were no acceptance criteria provided by the client for this test. The objective of the Full Mock-up Test was to simulate mechanical loading in the event of a tree falling on the dead-end span of the line and evaluate its effect on components (conductor, insulator, cross arm).

8 Conclusion

The test results show that:

- For smaller size conductors (#2 AWG Cu; 2/0 AWG CU; 4/0 AWG Cu and 1/0 AWG ACSR), the typical failure occurred as a result of conductor slipping out of the dead-end clamp.
- For larger size conductors with higher RTS (336.4 kcmil and 653.9 kcmil) the typical failure point was the crossarm. The failure of the crossarm started at the bolts on the mounting plate and propagated to the insulator attachment point .
- Deformation of the mounting plate on the crossarm occurred in all instances.

[The remainder of this page is intentionally left blank.]

Appendix A Acronyms and Abbreviations

AAC	- All Aluminum Conductor
ACSR	- Aluminum Conductor Steel Reinforced
ANSI	- The American National Standards Institute
AWG	- American Wire Gauge
HDCU	- Hard Drawn Copper
DE	- Dead End
ISO	- International Organization for Standardization
RTS	- Rated Tensile Strength
XLPE	- Crosslinked Polyethylene

[The remainder of this page is intentionally left blank.]

Appendix B Test Components

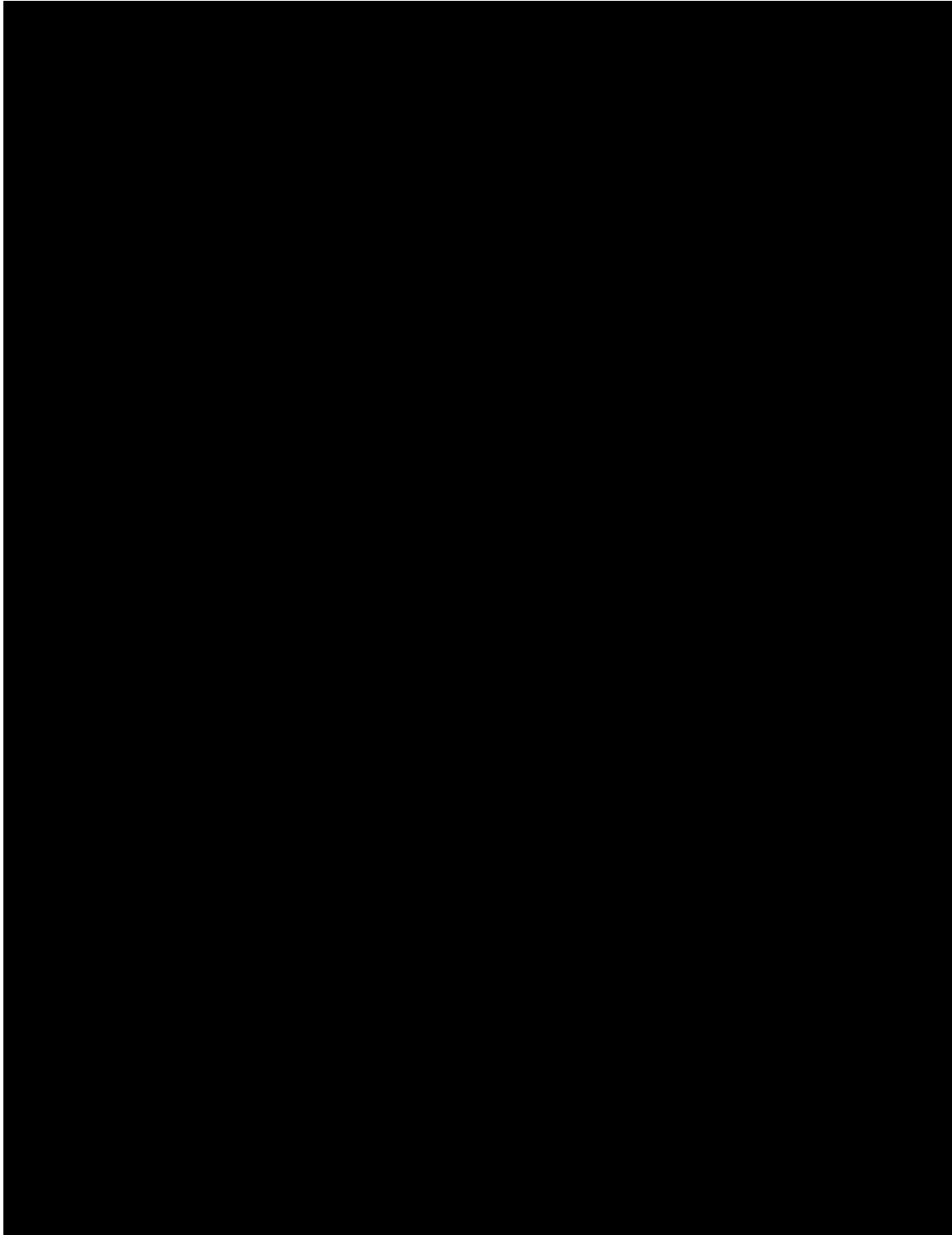

Figure D 1:  15 kV Dead-End Insulator

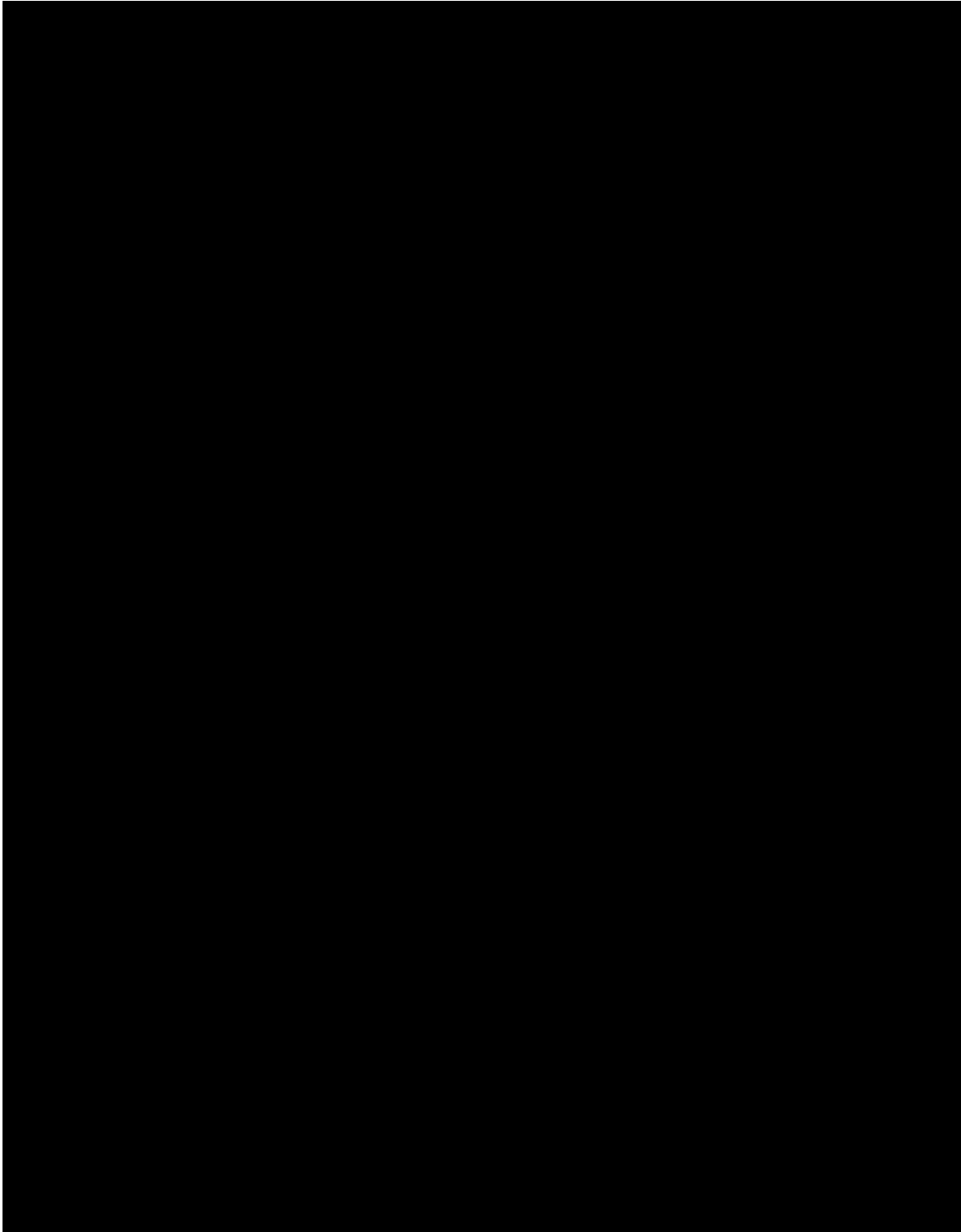

Figure D 2: [REDACTED] Dead-End Bolted Clamp [REDACTED]

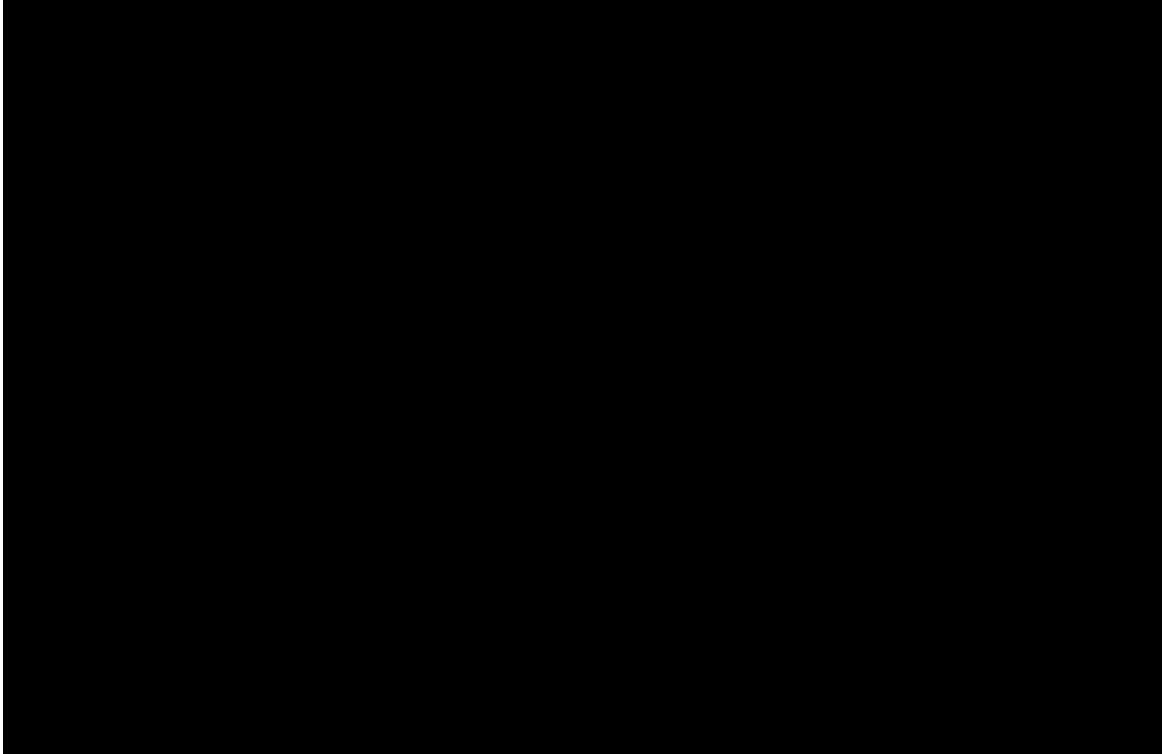

Figure D 3: [REDACTED] Dead-End Bolted Clamp [REDACTED]

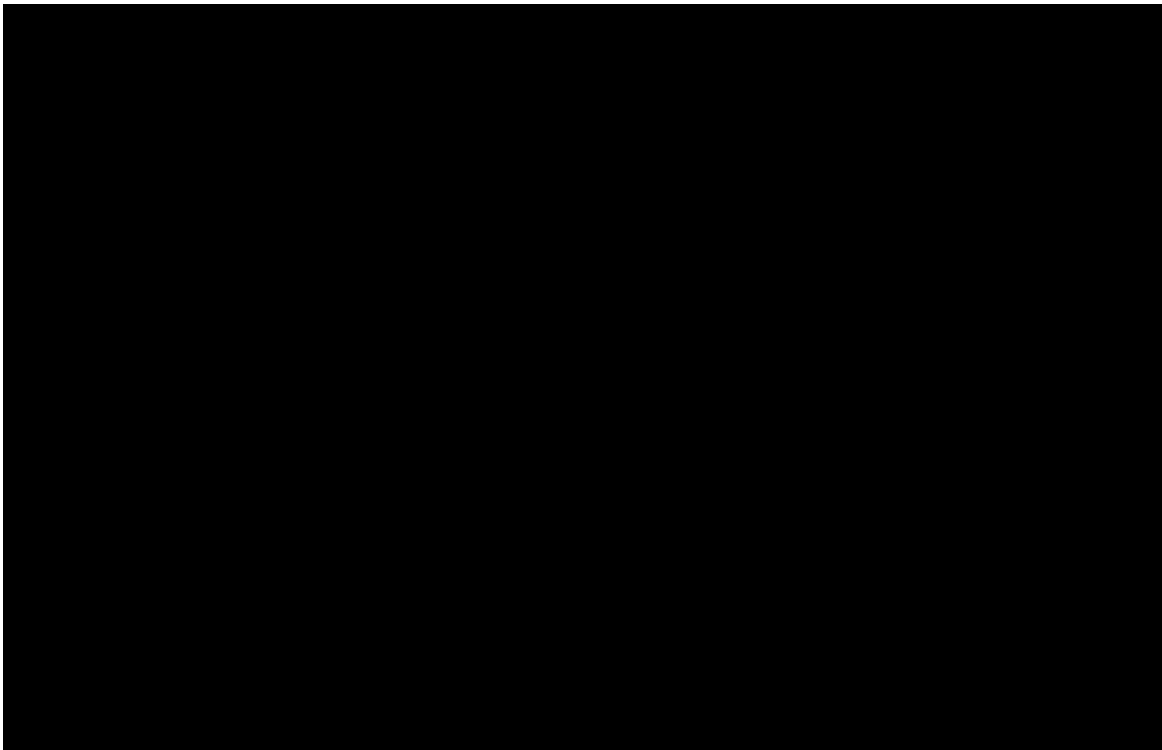

Figure D 4: [REDACTED] Dead-End Bolted Clamp [REDACTED]

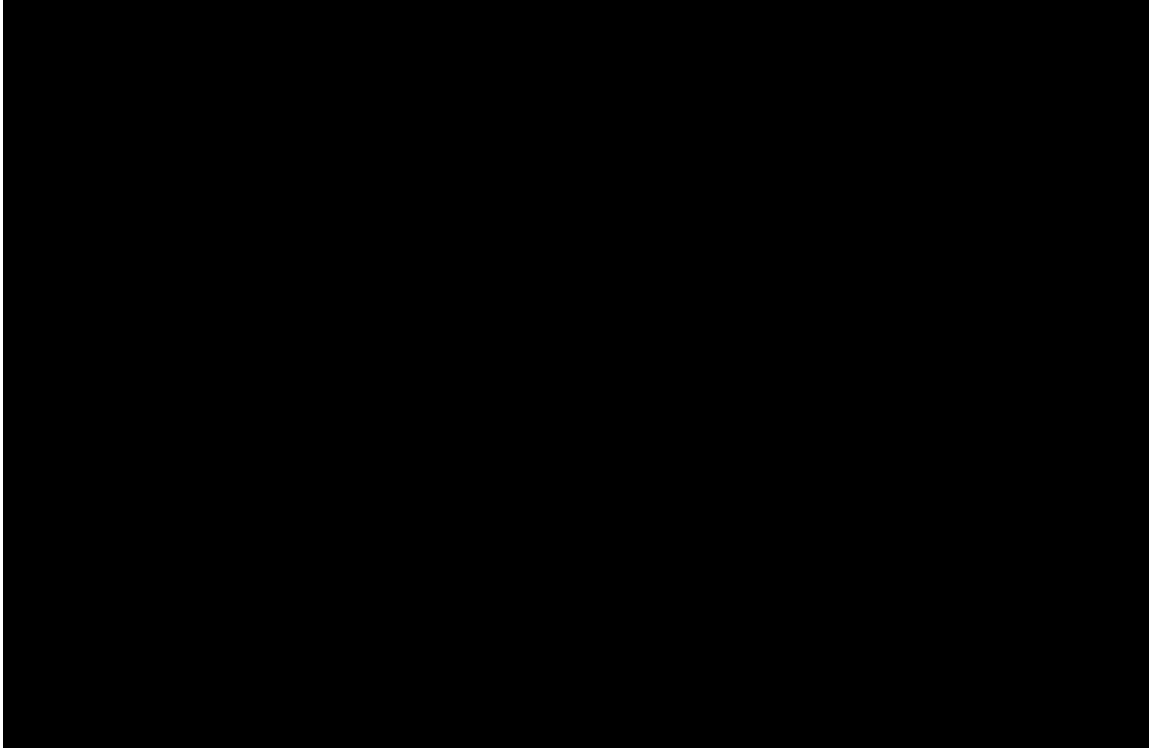

Figure D 5: [REDACTED] Dead-End Bolted Clamp [REDACTED]

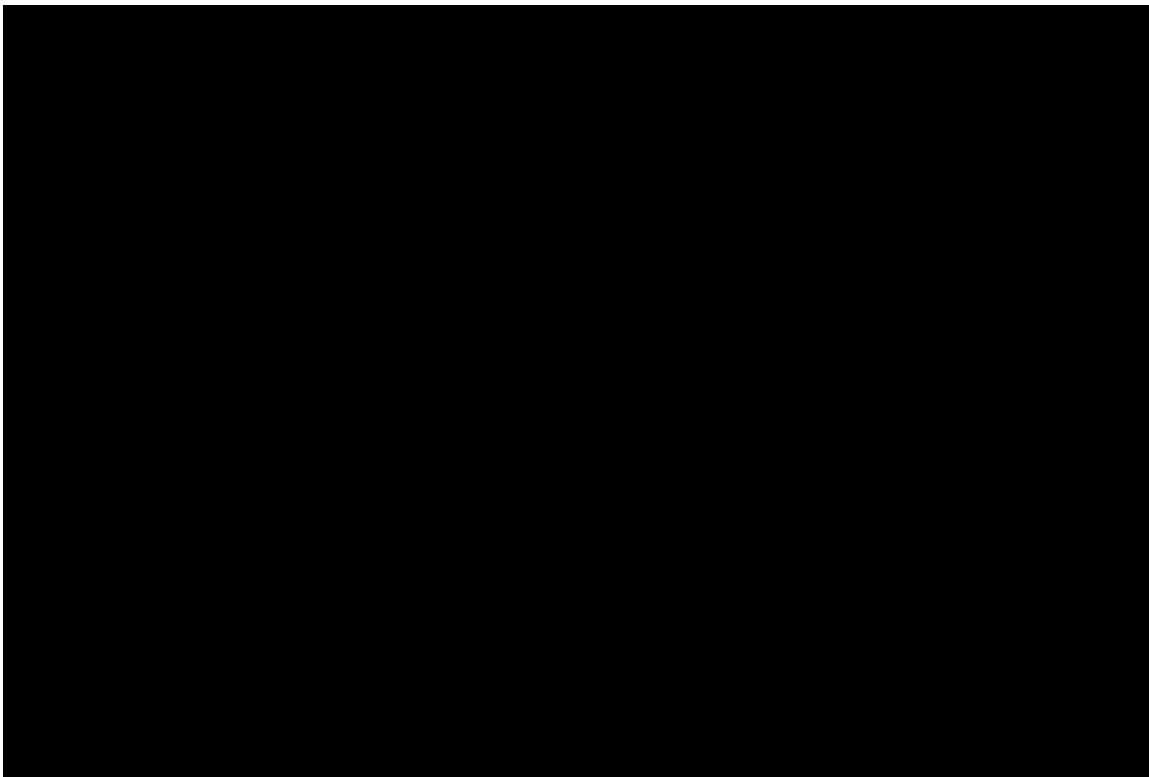

Figure E 1: [REDACTED] Deadened Composite Crossarm



Appendix C Instrument Sheet

EQUIPMENT DESCRIPTION	ASSET No.	ACCURACY CLAIMED	CALIBRATION DATE	CALIBRATION DUE DATE	TEST USE
Data Logger	KIN-01836	$\pm(0.1\% \text{ Rdg})$	May 27, 2022	May 27, 2023	Data acquisition
Load Cell/ Conditioner	KIN-01725/ KIN-01724	$\pm (1\% \text{ Rdg})$	October 26, 2021	November 26, 2022	Horizontal Load
Load Cell/ Conditioner	KIN-06678	$\pm (1\% \text{ Rdg})$	January 27, 2022	January 27, 2023	Vertical Load
Tape Measure	KIN-06890	$< 0.05\% \text{ Rdg}$	June 29, 2022	June 29, 2023	Length
Protractor	KIN-03375	$\pm(0.2^\circ)$	February 7, 2022	February 7, 2023	Angle
Torque Wrench	KIN-03249	$\pm(2\% \text{ Rdg})$	May 6, 2022	May 6, 2023	Installation Torque
Thermocouple/ Transmitter	KIN-00918/ KIN-00919	$\pm (1 \text{ }^\circ\text{C})$	October 28, 2021/ October 21, 2021	October 28, 2022/ October 21, 2022	Ambient Temperature

Appendix D Kinectrics ISO 9001 Certificate of Registration



 **CERTIFICATE OF REGISTRATION**

This is to certify that
Kinectrics Inc.
Kinectrics North America Inc., Kinectrics International Europe ApS or Kinectrics International Inc.
800 Kipling Avenue, Unit 2, Toronto, Ontario M8Z 5G5 Canada

Refer to Attachment to Certificate of Registration dated November 5, 2021 for additional certified sites
operates a
Quality Management System
which complies with the requirements of
ISO 9001:2015
for the following scope of certification
This registration covers the Quality Management System for engineering, consulting, design, testing, project management, research, software development, assessments, operations support, and analysis within our facilities, and at field sites, for customers in the electricity industry and related energy sectors; both nuclear and conventional; as well as processing of radiological and conventional laundry and manufacture, inspection, and repair of personal protection equipment.

Certificate No.:	CERT-0119296	Original Certification Date:	July 7, 1998
File No.:	006555	Certification Effective Date:	May 23, 2021
Issue Date:	November 5, 2021	Certification Expiry Date:	May 22, 2024

Frank Camasta
Global Head of Technical Services
SAI Global Assurance

Registered by:
QMI-SAI Canada Limited (SAI Global), 20 Carlson Court, Suite 200, Toronto, Ontario M9W 7Y5 Canada. This registration is subject to the SAI Global Terms and Conditions for Certification. While all due care and skill was exercised in carrying out this assessment, SAI Global accepts responsibility only for gross negligence. This certificate remains the property of SAI Global and must be returned to them upon request.
To verify that this certificate is current, please refer to the SAI Global On-Line Certification Register:
https://www.sai-global.com/en-us/assurance/auditing_and_certification/certification_register/





Appendix E Distribution

Mr. Matt Bowers, Ph.D., P.E.

Exponent
17000 Science Drive, Suite 200
Bowie, Maryland 20715
Email: mbowers@exponent.com

Mr. Genti Gorja

Kinectrics AES Inc.
800 Kipling Ave, Unit No.2
Toronto, ON
Canada M8Z 5G5

Email: genti.gorja@kinectrics.com

[The remainder of this page is intentionally left blank.]

Attachment C: Enhanced Clearance Joint Response

2023 WMP Update
Areas for Continued Improvement and Required Progress of the IOUs' 2022 WMP Update
Progression of Effectiveness of Enhanced Clearances Joint Study

Description:

The 2021 Action Statements required the large IOUs to conduct a study assessing the effectiveness of enhanced clearances. Progress has been made in the study; however, the study must continue to progress.

Required Progress:

By the submission of the 2023 WMPs, SDG&E, along with PG&E and SCE, must (1) standardize the data collection process for the cross-utility database of tree-caused risk events, (2) determine where and in what form the database will exist, (3) examine, to the best of their ability, whether the correlation between enhanced clearances and the lower number of tree-caused outage events may be attributable to other factors beyond clearances, such as the management of hazard trees and the installation of covered conductor. Energy Safety expects the large IOUs to make incremental progress and update their analyses with each WMP submission through at least 2025.

Response:

The utilities have prepared a joint response to this Area for Continued Improvement.

SDG&E, PG&E, and SCE (jointly, investor-owned utilities or IOUs) have continued collaboration on the vegetation clearance study. Bi-weekly meetings occurred throughout 2022 with attendees from the IOUs and Energy Safety attending.

The IOUs are focused on addressing the required progress of this study, which include:

- Standardize the data collection process for the cross-utility database of tree-caused risk events
- Determine where and in what form the database will exist
- Examine, to the best of our ability, whether correlation between enhanced clearances and the lower number of tree-caused outage events may be attributable to other factors beyond clearances, such as the management of hazard trees and the installation of covered conductor

In order to achieve the results of the study most effectively, the IOUs chose to hire a third-party to establish the data collection standards, create the cross-utility database, and study the relationship between enhanced vegetation clearances and tree-caused risk events. A third-party vendor to assist with the study will provide both experience in data analysis and an independent review of the data and conclusions.

To select a qualified vendor for this multi-year engagement the IOUs nominated potential bidders for the work, and SDG&E led a Request for Information (RFI) event that was sent to eight different vendors to understand their capabilities in performing this study. The RFI was distributed in February, with responses due back in early March. After reviewing and scoring the information received from the

vendors, three were then invited to participate in a Request for Proposal (RFP). The documentation for the RFP was prepared and distributed to the vendors in early June and responses were received in July. The RFP materials were scored, and negotiations began with the selected vendor in August. The completed and signed contract was completed in October and the vendor (EPRI) began attending the joint IOU meetings and beginning data collection for the study. Progress on each of the required areas is provided below:

1. Standardize the data collection process for the cross-utility database of tree-caused risk events

The EPRI research team is implementing a phased approach to the study consisting of 1) Database Evaluation, 2) Database Development, and 3) Data Analysis. The first step has been for EPRI to request a sample set of data from each of the participating IOUs. This data includes information from relevant vegetation, outage, GIS, weather, and related data sets. The data samples are currently under review and a meeting with the research team and the IOUs is planned for Q1 of 2023 to discuss the data fields. After this discussion, a larger sample of data will be requested from each of the IOUs, including relevant metadata, and including historical data. These will be pulled together into a combined database, and jointly evaluated. The EPRI team will consider how best to combine the three separate groups of data into a single database. This will begin the second phase of the study: Database Development. The database will exist on the EPRI Server. The three phases are described in more detail below.

2. Determine where and in what form the database will exist

The database will exist on the EPRI Server, and outage data will be pushed to EPRI at a time step discussed over the course of the project, likely weekly. Vegetation, weather, GIS, and other datasets will also be pushed to the database at selected, regular intervals. The outage data will include outages that are not vegetation related. EPRI will query the freeform notes to extract possible tree related outages that were coded erroneously. EPRI will examine and put the utility data into a common format and create a new database of the combined utility data. This data will be accessible for queries by the participants. If all the participants agree, the data can also be available for downloading, and can be obfuscated to the degree necessary by the providing utility prior to transfer.

3. Examine, to the best of our ability, whether correlation between enhanced clearances and the lower number of tree-caused outage events may be attributable to other factors beyond clearances, such as the management of hazard trees and the installation of covered conductor.

This will be done by first examining a selection of each IOU's databases including weather, vegetation management, GIS, Outage Management Systems (OMS), and other related databases. This review will first include a review of the datasets, the frequency of collection, the quality of the data, the confidence in the data, historical data available from each IOU, the metadata, variables, definitions, and identify a data steward from each company. Using this information from the sample selection, and a second request for larger dataset, EPRI will create a data dictionary. After reviewing the samples of each utility, and during the immersive discussions described below, EPRI will develop the joint database. The fields and coding systems in the joint database will be designed with the utilities and using the experience of the vendor in similar projects. The EPRI Data Science Platform will be able to integrate data of various formats and types, facilitating the data analysis described below.

The study intends to create the joint database across the three utilities which would be able to establish uniform data collection standards, focus on tree-caused risk events, incorporate both biotic and abiotic factors, and assess the effectiveness of enhanced clearances. Once the database is created, there is an opportunity for researchers and practitioners to gain deep insight on the causes of ignition events and the potential vegetation management options to mitigate them.

The following steps will be implemented between January 2023 and June 2024.

1) Database Evaluation:

a. First, to evaluate existing data, and recognizing that each IOU's database has some common fields and other fields that are not common across all IOUs, a sample of each database will be evaluated, and then a larger section of the data will be evaluated. This will be to review existing data and guidelines for data collection and determine if the current structures allow the key research questions for this project to be addressed. To that end, and to help ensure that the data curated can acceptably inform the questions to be answered, EPRI plans to have immersive discussions with each IOU's respective vegetation management and outage management teams to better understand what data is currently curated and to evaluate the level of quality and certainty of data contained in the database fields. The purpose of the immersive discussions is to understand the current database structures used by each utility, the method of recording data, the type of historical records available, the definitions of specific tree-pruning activities, the differences in the outage management systems, and other information that may vary from utility to utility.

b. Parallel or after the individual meetings, the research team, and SMEs from each of the three IOUs will attend a follow up workshop to be hosted by SDG&E, or one of the participating utilities. This is tentatively scheduled for February 6-7. During this meeting EPRI and the IOUs will discuss the key questions raised at the individual meetings and discuss organizing outage cause codes into common groupings to best capture the information needed to perform a meaningful study, including sharing ideas regarding additional data fields. As a team (research team and utility SMEs) the design of a consolidated database structure to be used moving forward will be created.

c. Third, once outage cause codes are determined, a survey/coding workshop will be developed describing scenarios that should be coded. This survey will be administered to all employees that input cause codes in the outage management system (OMS). While the survey will capture the initial inputs, the survey will also present the user with the desired coding based upon the decisions made in the group workshop.

2) Database Development:

a. EPRI will base the database development on previous experience with cross utility databases such as the industry wide databases for T&D asset performance, inspections, and maintenance. Before defining the final database structure, EPRI will follow a phased approach. Initially, EPRI will investigate each utility's data individually. Then, they will look at the lessons learned to assess the broader applicability. At that stage, EPRI can initiate the development of a cross utility database by designing the criteria around how the common database is set up and populated, as well as the data management lifecycle criteria.

3) Data Analysis:

a. In addition to a single-unified database structure and the data to support that structure that allows IOUs to understand every vegetation contact with the lines, there is a need to drill down to understand vegetation treatments and their effectiveness. Assuming adequate history on circuits that have data before and after enhanced clearance work was performed, EPRI would conduct statistically valid and defensible analyses on that group of circuits. The general objective of the data analysis would be to understand the effect of enhanced vegetation clearances on outage performance. The results would likely lead to other insightful analyses and comparison with other treatment approaches and to different weather conditions. Depending on the type of data received, its granularity, the temporal scale, length of time that enhanced vegetation management has been implemented in the circuits, and how many variations the utility has used, there are many different directions of analysis. For example, if the circuit characteristics and approaches are substantially different from one another (circuit to circuit or utility to utility) a self-benchmarking or baseline extrapolation might be possible if sufficient historical data is also provided. Similarly, other data analysis possibilities exist that will be determined as the scope of the data becomes available.

b. EPRI will share the results of Data Analysis in a technical memo which will include data, graphs, charts, and narrative text. This information can be used to share results with joint IOU stakeholders, including agencies, and the general public, regarding results of the data analysis and any insights regarding the potential links between enhanced vegetation clearing, outages, and ignition risk.

Separate from the joint IOU database study on enhanced clearances, each of the large IOUs have completed work to understand the effectiveness of enhanced clearances within their respective service territories. Details on these efforts are described below.

SDG&E

San Diego Gas & Electric (SDG&E) has implemented several initiatives within its Vegetation Management program to reduce power outages and mitigate the risk of wildfire. These initiatives include covered conductor, undergrounding, enhanced inspection processes, and enhanced line clearance. To assess the impact of the Enhanced Clearance Vegetation Management program, which was launched in 2019, SDG&E conducted an analysis. The goal was to understand the effectiveness of this program in reducing outages and potential wildfire.

According to the California Public Utilities Commission (CPUC) General Order 95, Rule 35, distribution voltage lines in California must have a minimum clearance of 18 inches. In the High Fire Threat District (HFTD) region of the state, the minimum clearance is 4 feet for distribution lines. For the purposes of this analysis, "enhanced clearance" refers to trees that were trimmed to a height above 11 feet. In 2019, SDG&E increased the percentage of trees managed at enhanced clearance distances (11 feet or higher) to 25% of its inventory and saw a reduction in power outages. The graph below illustrates the percentage of inventory trees that were managed at enhanced clearance distances versus not enhanced from 2006 to 2022.

Distribution of Tree Inventory Line Clearance Distance

Percentage of Trees Enhanced vs. Non Enhanced 2006-2022

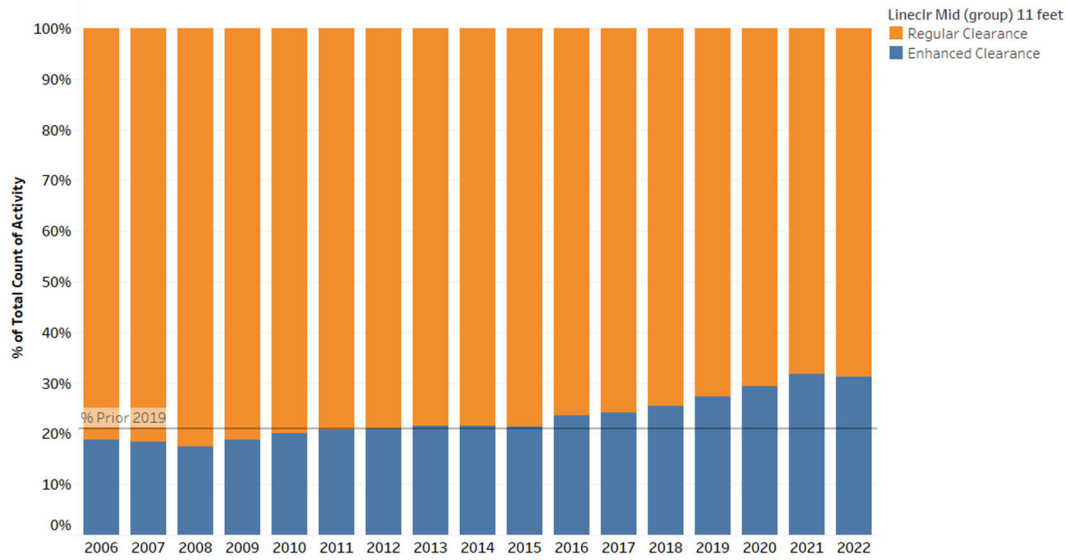

Historical Vegetation related Outage Count

Vegetation related Outages 2006-2022

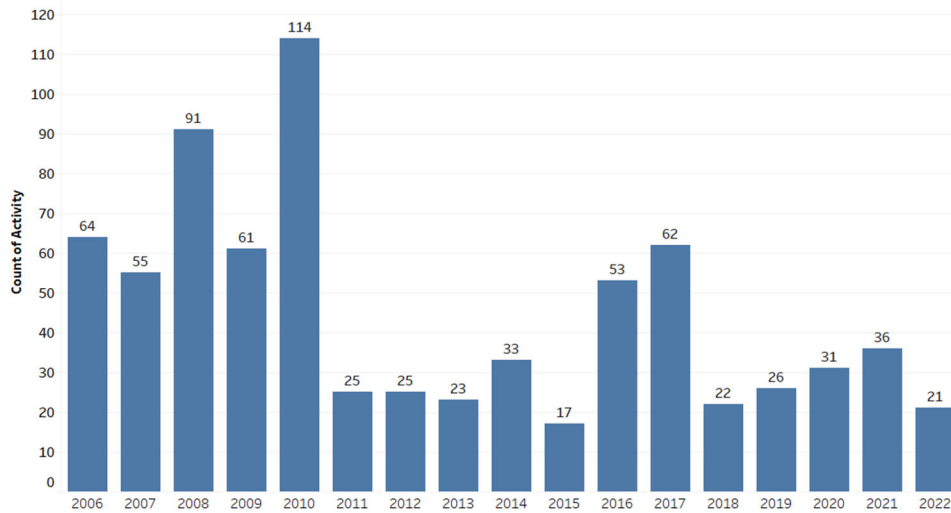

To understand its outage reduction over recent years, SDG&E analyzed historical data. When comparing the years 2019-2022 to 2014-2018, SDG&E observed approximately a 20% improvement in outages.

Year	Group	Count of FACILITYIDs	Outage Count	Outage Rate (Outage Count/Count of FACILITYIDs)	% of FACILITYIDs less or equal to 11 feet	% of FACILITYIDs greater than 11 feet	Avg % of FACILITYIDs greater than 11 feet	% Change	Average Outage Count	Outage Improvement (count)	Outage Improvement (% change)	Average Outage Rate	Outage Rate Improvement	Outage Rate Improvement (% change)
2014	Prior EVM (14-18)	393,217	33	0.008%	78.4%	21.6%								
2015	Prior EVM (14-18)	388,903	17	0.004%	78.6%	21.4%								
2016	Prior EVM (14-18)	383,351	53	0.014%	76.3%	23.7%								
2017	Prior EVM (14-18)	379,431	62	0.016%	75.8%	24.2%								
2018	Prior EVM (14-18)	381,170	22	0.006%	74.6%	25.4%	23.2%		37.4			0.010%		
2019	EVM (19-YTD 22)	377,554	26	0.007%	72.7%	27.3%								
2020	EVM (19-YTD 22)	377,919	31	0.008%	70.7%	29.3%								
2021	EVM (19-YTD 22)	384,613	36	0.009%	68.2%	31.9%								
2022	EVM (19-YTD 22)	372,472	24	0.006%	68.8%	31.2%	29.9%	6.67%	29.3	8	21.8%	0.008%	0.0020%	20.7%

To determine the contribution of the enhanced clearance initiative to the observed improvement in outages, a machine learning model (logistic regression) was employed to analyze the relationship between line clearance distance and the probability of tree-caused power outages. The logistic regression model considered various variables that may impact outage probability, and a sensitivity analysis was conducted to examine the effect of line clearance distance on outages while holding other factors constant.

SDG&E analyzed all activities from 2014 to 2022 to understand the relationship between line clearance distance and the probability of tree-caused power outages. SDG&E linked each outage event to its corresponding inspection or trim activity to determine the most recent line clearance distance before the outage occurred. The variable "outage" served as the flag variable that was predicted in the model.

The following features were included in the model:

- Species
- Line Clearance Distance
- Enhanced Clearance (yes or no)
- Tree Height
- Diameter at Breast Height (DBH)

To evaluate the performance of the model, the entire dataset was split into training and test data sets. The training set was used to build the model, and the test set was used to evaluate the model's performance on unseen data. Once the model's performance was understood, the line clearance distance was altered in the sensitivity analysis to understand its effect on the predicted probability of outages for each activity.

The sensitivity analysis reduced the line clearance distance of all activities with a line clearance distance above 11 feet (enhanced clearance level) to 11 feet. These activities were again run through the model using the same threshold value to make predictions. SDG&E assumed that the new distribution of activities would have the same performance distribution as the actual data, allowing us to determine the number of outages that were potentially prevented for these trees.

By altering the line clearance distance value, but holding other factors constant, the study was able to evaluate the impact of line clearance on tree-related outages. The results revealed that reducing line clearance from enhanced levels (>11 ft) to regular levels (11 ft) led to an increase in the number of predicted tree-caused outages. Specifically, the model predicted a reduction in tree-related outages by approximately 12% attributed to enhanced clearances.

PG&E

Pacific Gas & Electric (PG&E) launched the Enhanced Vegetation Management (EVM) program in response to changing environmental conditions and based on our best view of risk mitigation at the time. Since launching EVM in 2019, PG&E's wildfire capabilities have continued to evolve and mature; we now have solutions that provide more effective and efficient wildfire risk reduction such as Public Safety Power Shutoff (PSPS), Enhanced Powerline Safety Settings (EPSS), System Hardening and other operational mitigations. We are also evaluating additional operational mitigations, including partial

voltage detection, downed conductor detection, and breakaway connectors, each of which will further reduce the risk of catastrophic wildfires. The data below shows the 2022 non-MED (Major Event Days) Outages performance compared to the 3 Year Average and 2021 has slightly declined.

The good measure is to compare the outages reduction because ignitions are impacted due to other wildfire reduction mitigation.

Data in the table below is not Normalized for Non-MED Outages (i.e., there are more non-MED in 2022 compared to 2021)



Vegetation Outages Review

2022 VEG Outages Compared with 2021 and 3-Year Average

Year	All Outages	Non-MED Outages
2021	7520	3173
3 Year Average (2019-2021)	6567	3355
2022	3850	3524

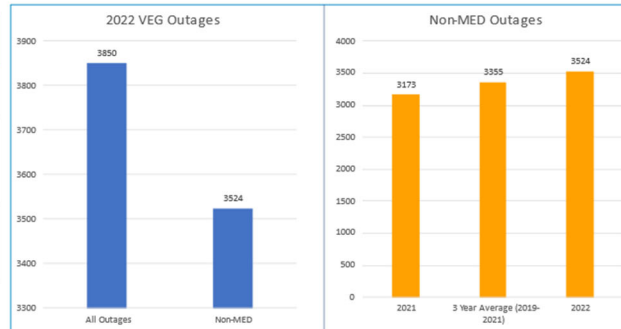

- 2022 Performance compared to the 3 Year Average and 2021 has slightly declined/slipped.
- There were fewer Major Event Days in 2022.

Internal



Dashboard Non-MED Outage Running Total

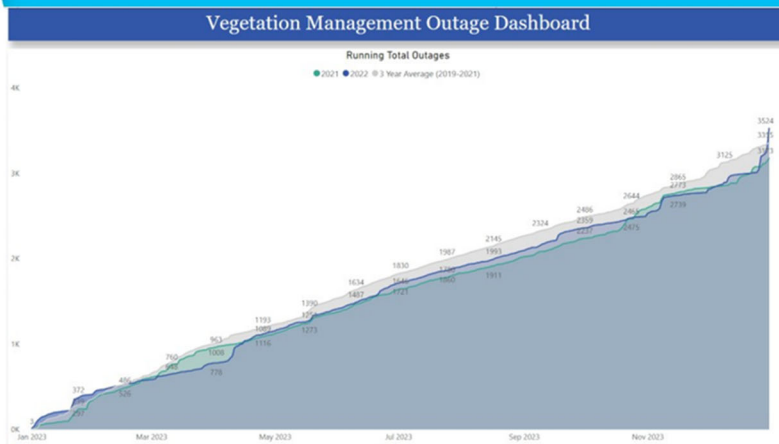



Dashboard All Outage Running Total

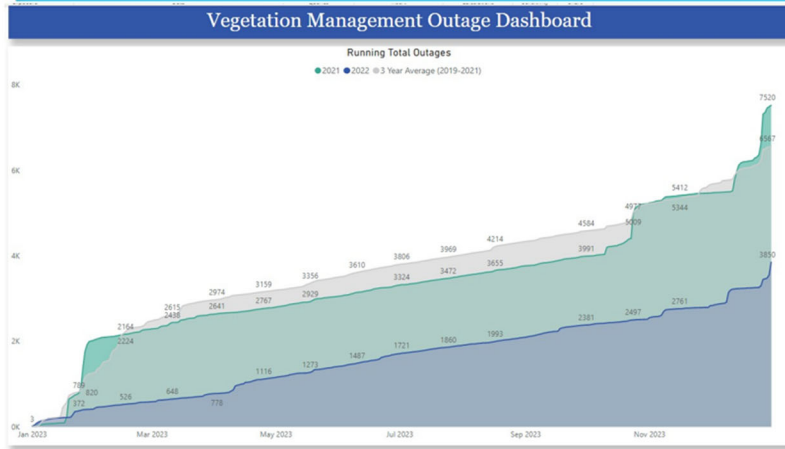

Total Vegetation Outages 2016-2022

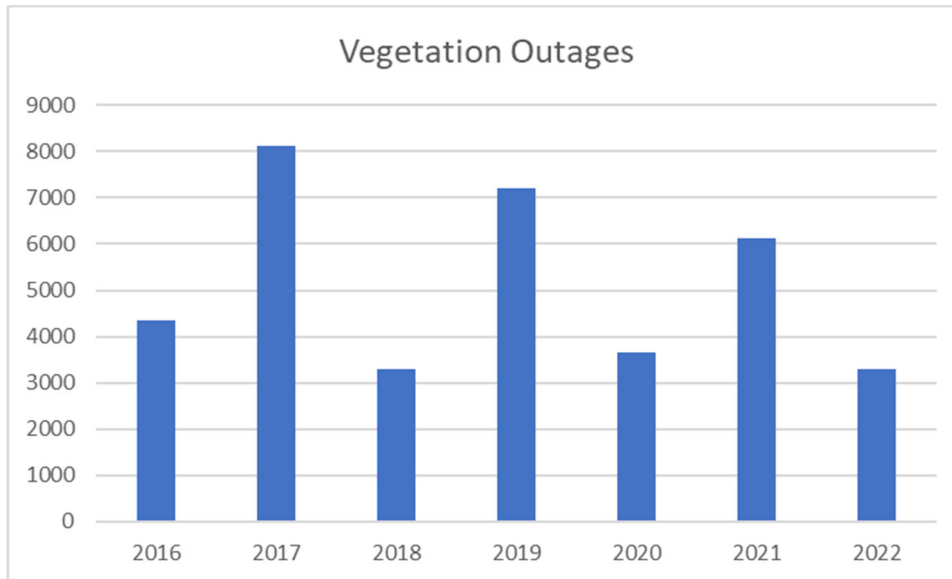

SCE

Beginning in late 2018, SCE began implementing enhanced clearance programs to achieve greater trimming distances consistent with D.17-12-024, which amended GO 95 to increase recommended clearance distances at time of trimming in HFTDs. SCE believes that tree-caused circuit interruptions (TCCI) continue to serve as an appropriate data point to use in assessing the impact of SCE's enhanced clearance programs on wildfire risk mitigation.

Outage data in Table 1 represents TCCI's on SCE's distribution system as confirmed through SCE field verification. The data shows a significant decline of 60% in the average annual number of TCCI's between the pre-enhanced clearance period of 2015 through 2019 and the post-enhanced clearance period of 2020 through 2022. In the pre-enhanced clearance period for High Fire Threat Districts, SCE experienced an annual average of approximately 148 TCCI's, while in the post-enhanced clearance period, the annual average of the number of TCCI's is currently 60, a reduction of approximately 60%.

As of Q4 2022, there were no reported events on SCE's transmission circuits.

Table 1: Average Events Pre & Post Enhanced Clearances¹

Average Events Pre and Post Enhanced Clearances	Pre-Enhanced Clearances	Post Enhanced Clearances ²	Difference
	Avg of Annual TCCIs (2015-2019)	Avg of Annual TCCIs (2020-2022)	
HFTD	148	60	-60%
Non-HFTD	289	168	-42%
All	438	228 ³	-48%

Notes: 1) SCE's TCCI data categorization in this table is grow-in, blow-in and fall-in events with six total fault type categories: Grow-In, Blow-In, Fall-In, Human Caused, No Cause/Not tree related, and Uncategorized. This data excludes Human Caused, No Cause/Not tree related, and Uncategorized recorded events. SCE has maintained data for annual outages since 2015 and for enhanced clearances since 2020.

2) While SCE began implementing enhanced clearances in 2019, "post-enhanced" is focused on 2020 to the present, in consideration of the time required to execute and advance expanded clearance work across SCE's HFTD.

3) December 2022 data is subject to change pending final verification.

Though SCE has tracked TCCIs since 2015, advancements in its work management system have allowed SCE to associate specific outage events with the specific tree(s) in its inventory since 2021. Starting in 2021, SCE's legacy outage data was updated to newer data collection standards and into Fulcrum, one of SCE's data collection tools. This additional functionality helps further SCE's insight into outage events and potentially informs future mitigation strategy.

Additionally, SCE has enhanced the functionality of its outage dashboard to facilitate a more holistic view of TCCIs across the system. These views provide insight into TCCI trending as well as factors that

may affect outage frequencies, such as at-risk species, time of year, and related weather events. Figures 1 through 3, below, show some examples of visualization available on the dashboard. The dashboard (as reflected in Figures 1 and 2) shows a year-over-year decline in TCCIs in SCE’s service area since the implementation of enhanced clearances and other wildfire mitigation initiatives. Finally, the data also indicates that SCE is experiencing flatter fluctuation of events over the year compared to prior years, with similar seasonal and storm-related spikes.

Figure 1: Time Series of TCCI Events in HFTD (2017-2019 – Pre-Enhanced Clearance)
(Grow-In, Blow-In, and Fall-In)

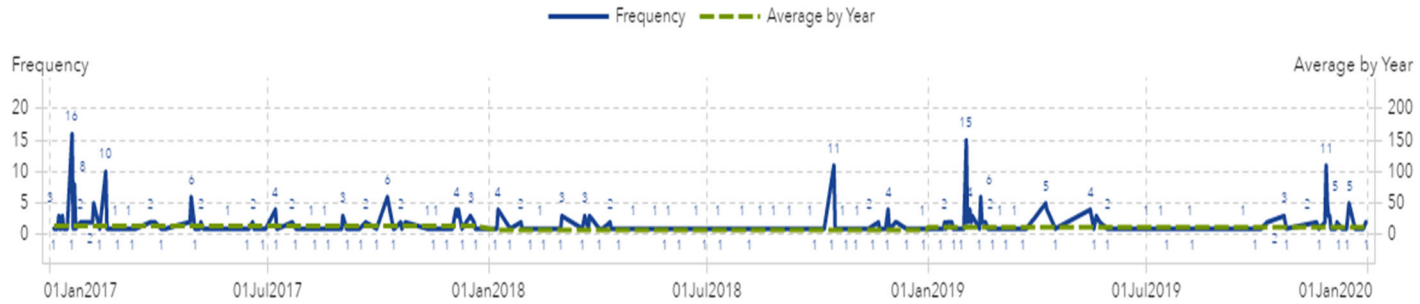

Figure 2: Time Series of TCCI Events in HFTD (2020-2022 – Post-Enhanced Clearance)
(Grow-In, Blow-In, and Fall-In)

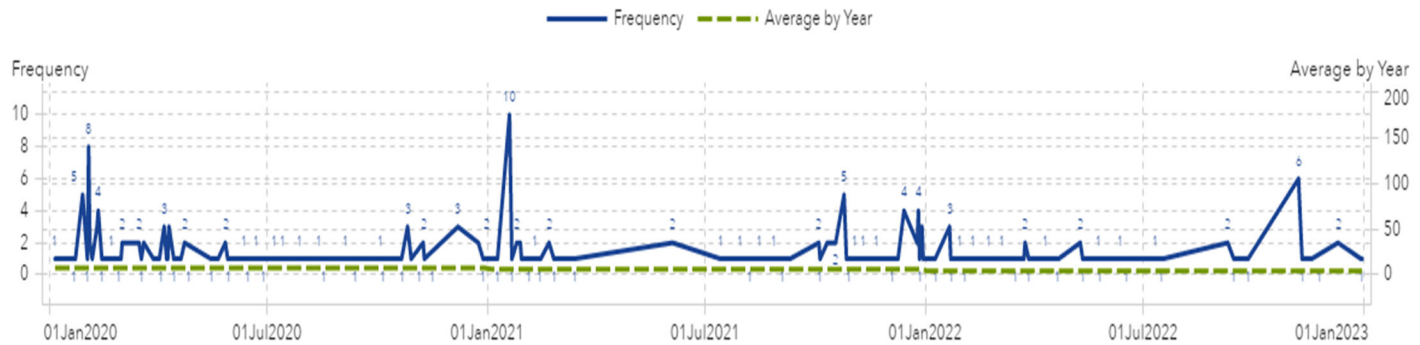
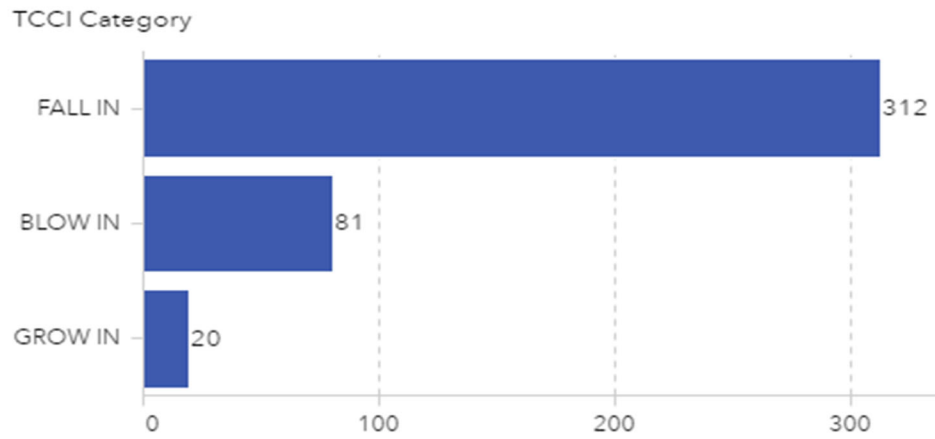

Figure 3: Count of Grow-In, Blow-In, and Fall-In TCCI's for Post-Enhanced Clearance in HFTD (2017-2019)



SCE has actively participated in this joint IOU working group and appreciates the partnership with all stakeholders involved. Over the next few years, SCE anticipates this effort will yield additional evidence of the impact enhanced clearances have on the reduction of tree-related events.

Attachment D: WMS Work Summary

Document Title:	WMS Work Summary
Author:	B. Gassman & C. Ladan
Date:	8/24/22

Summary:

While a single risk event may be anecdotal, collecting, classifying and mapping hundreds of risk-events have provided improved resolution, quantitative and qualitative intelligence, revealed statistical significance and provided SDGE with a platform and a methodology for evaluating the performance of pole clearance activities going forward.

Work Completed to date:

- Best sample study performed on data received
- Completed ignition to pole distance study
- Completed outage study
- Completed voltage study
- Analyzed effectiveness of fire size study (factors that influence fire size)
- Completed HFTD risk mapping study – 39 polygons with attributions
- Completed heat and fire event mapping study
 - Hex Risk Map ver1.0 – 72 polygons with attributions
 - Hex Risk Map ver2.0 – 3108 polygons with attributions

Preliminary Analysis:

- Reviewed available literature and data on pole brushing and the WMP program.
- Compared financial and risk metrics across all WMP initiatives to pole brushing.
- Identified useful information from data extracts to utilize in our research analysis.

Key Findings/ Takeaways:

- Identified 300 ft as best sampling distance.
- Distance study – Clearance radius of 50' will capture majority of ignitions.
- Outage Study - Ignitions associated with outage statistically likely to be closer to the pole than ignitions w/o outage
- Voltage Study – 12kV sample focus for accurate distance metrics. Determined influence voltage has on ignition profiles.
- Post 2020 Study utilized greater fire size precision to identify statistically significant relationships in the data.
- Quantified statistical significance in the finding that HFTD fires are more likely to be larger compared to Non-HFTD fires.
- Historic risk event data should be used for efficacy studies on clearance activities' performance.
- Developed geospatial model to be used with linear regression analysis techniques to identify whether pole clearance activities are influencing fire size and rates of ignition/heat events in HFTD areas.

Recommended future studies:

- Run the linear regression models to quantify the geospatial data relationships.
- Temporal analyses which compare time of clearance activities performed with time of risk event.
- Study vegetation types and rate of ignitions, potential to predict future high-risk outage prone areas.
- Research on "Bathtub Curve" indicates that premature equipment replacement program (2021 SDGE WMP, pg.288) introduces additional equipment-related ignition risk that is not currently considered in efficacy assessments.
- Monitoring the changing health conditions of the utility network infrastructure in real time, using proprietary technology which can monitor the pole equipment through the existing overhead conductors, triangulate proximity of the disturbance and direct pole clearance, repair and replacement activities would provide predictive high-risk guidance.

Document Title:	WMS Work Summary
Author:	B. Gassman & C. Ladan
Date:	8/24/22

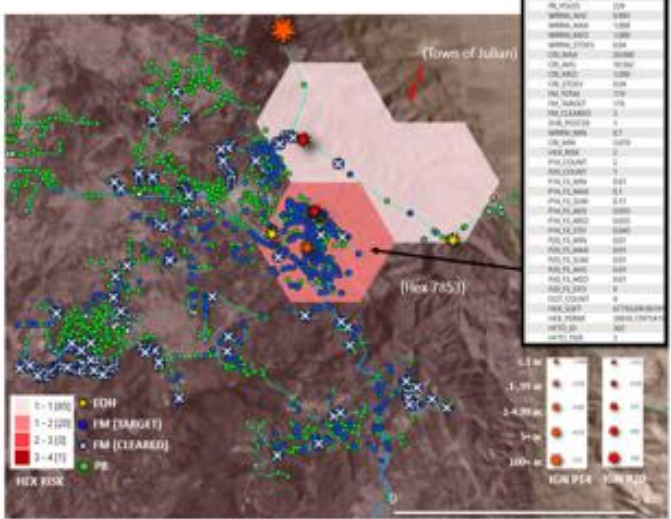
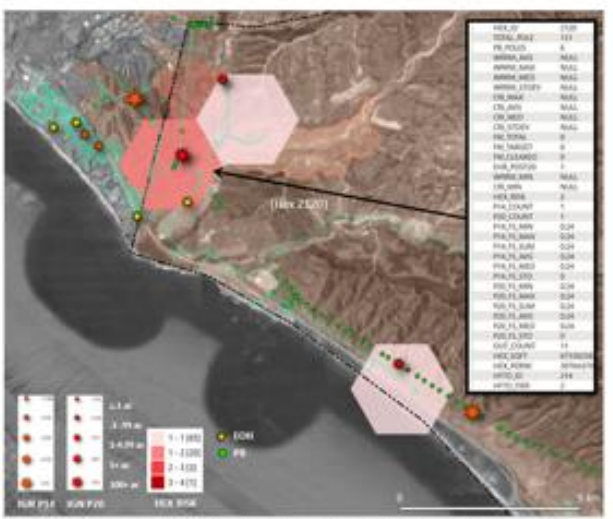
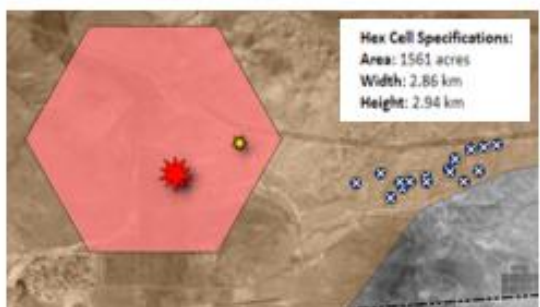
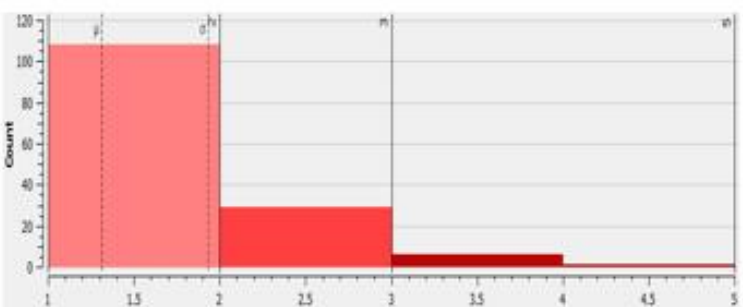
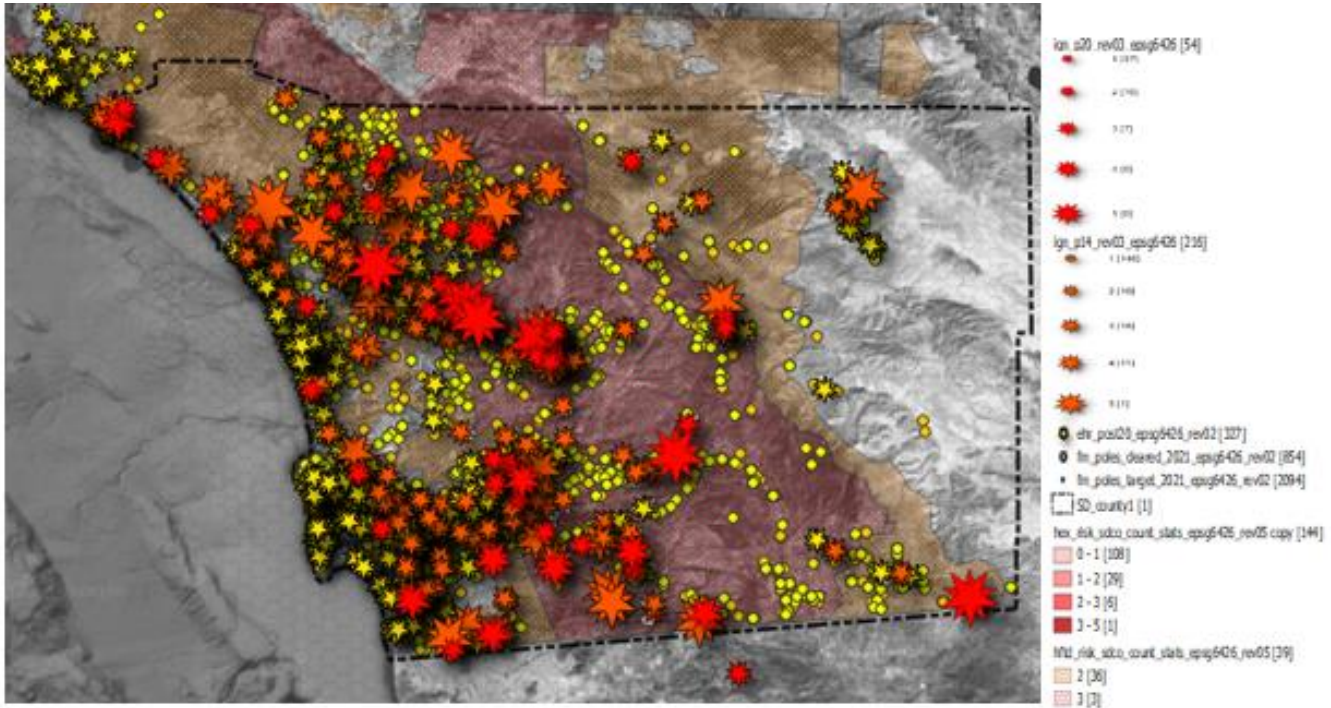

HEAT RISK CELL DISTRIBUTION - v1.0 - 4 CLASSES

HEAT RISK CELL DISTRIBUTION - v1.0 - 4 CLASSES

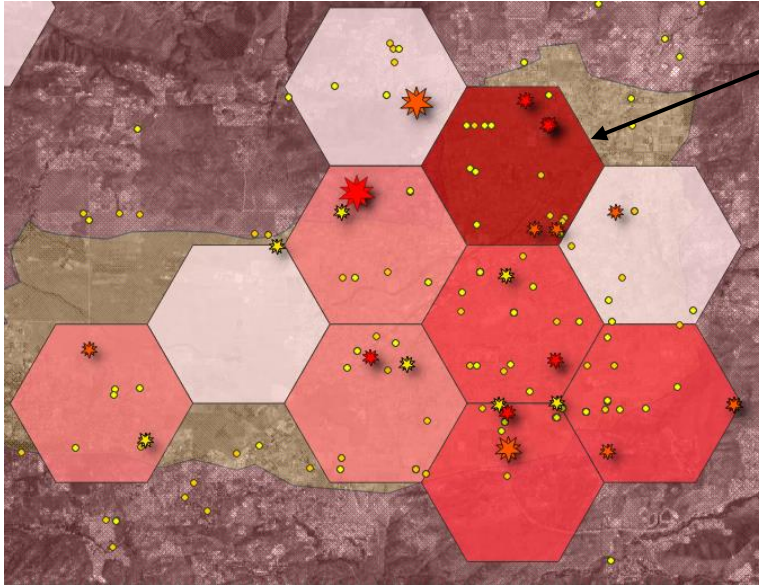

HEX_ID	3066	P14_FS_MED	0
HEX_RISK	5.0000	P14_FS_STD	0.04891
PB_POLE_N	276.00	IGN_P20_N	3
ALL_POLE_N	585	P20_FS_MIN	0
FM_TOTAL_N	0	P20_FS_MAX	0
FM_TARGET_N	0	P20_FS_SUM	0
FM_CLEAR_N	0	P20_FS_AVG	0
IGN_P14_N	5.0000	P20_FS_MED	0
IGN_P20_N	3.0000	P20_FS_STD	0
EOH_P20_N	0	WRRM_MIN	NULL
OUT_P15_N	18.000	WRRM_MAX	NULL
OUT_P20_N	9.0000	WRRM_SUM	NULL
HFTD_ID	302	WRRM_AVG	NULL
HFTD_TIER	3	WRRM_STD	NULL
P14_FS_MIN	0	CRI_MIN	NULL
P14_FS_MAX	0.1	CRI_MAX	NULL
P14_FS_SUM	0.2	CRI_AVG	NULL
P14_FS_AVG	0.04	CRI_MED	NULL
P14_FS_MED	0	CRI_STD	NULL
P14_FS_STD	0.04891	HEX_LONG_X	-116.86
IGN_P20_N	3	HEX_LAT_Y	33.0590
P20_FS_MIN	0	HEX_LEFT	-116.86
P20_FS_MAX	0	HEX_TOP	33.072
P20_FS_SUM	0	HEX_RIGHT	-116.84
P20_FS_AVG	0	HEX_BOT	33.0451
P20_FS_MED	0	HEX_AREA	677997
P20_FS_STD	0	HEX_PERIM	308181
WRRM_MIN	NULL	IGN_P15_N	5.00000
WRRM_MAX	NULL	P15_FS_MIN	0
WRRM_SUM	NULL	P15_FS_MAX	0.1
WRRM_AVG	NULL	P15_FS_SUM	0.2
WRRM_STD	NULL	P15_FS_AVG	0.04
CRI_MIN	NULL	P15_FS_MED	0
CRI_MAX	NULL	P15_FS_STD	0.04891
		HFTD_PRCNT	100.000

Highest Risk Hex cell cluster showing all risk events. Attributions for highest class 4 hex cell.

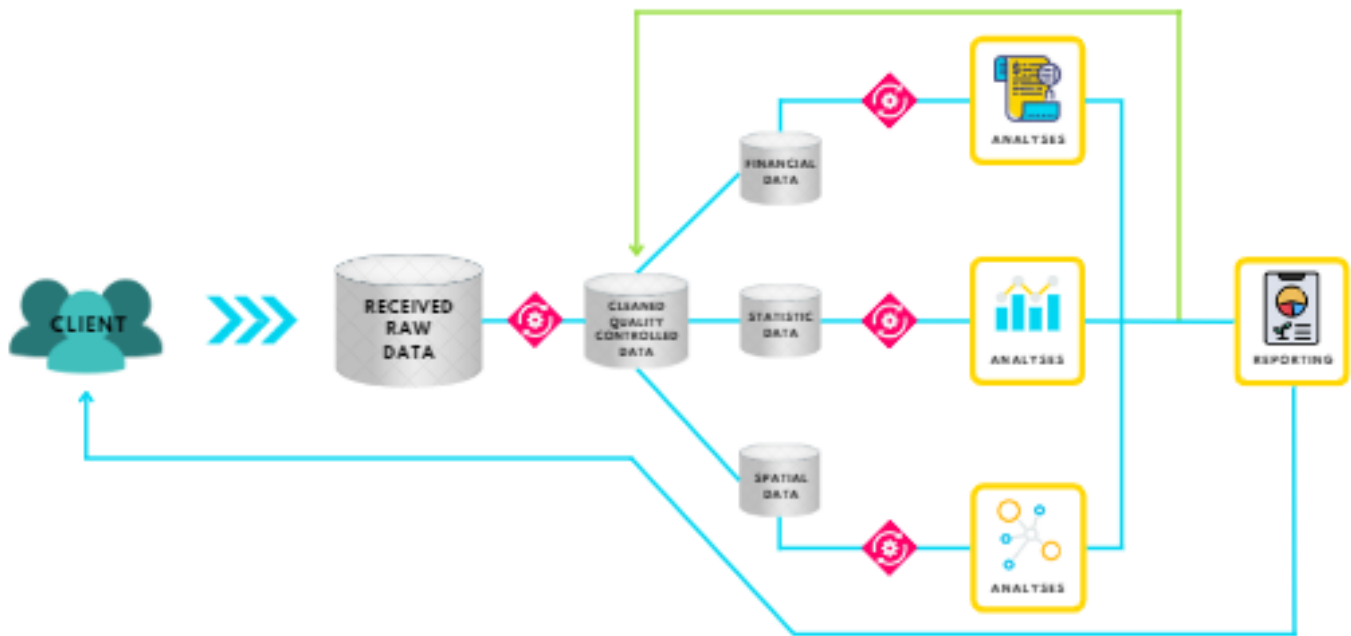

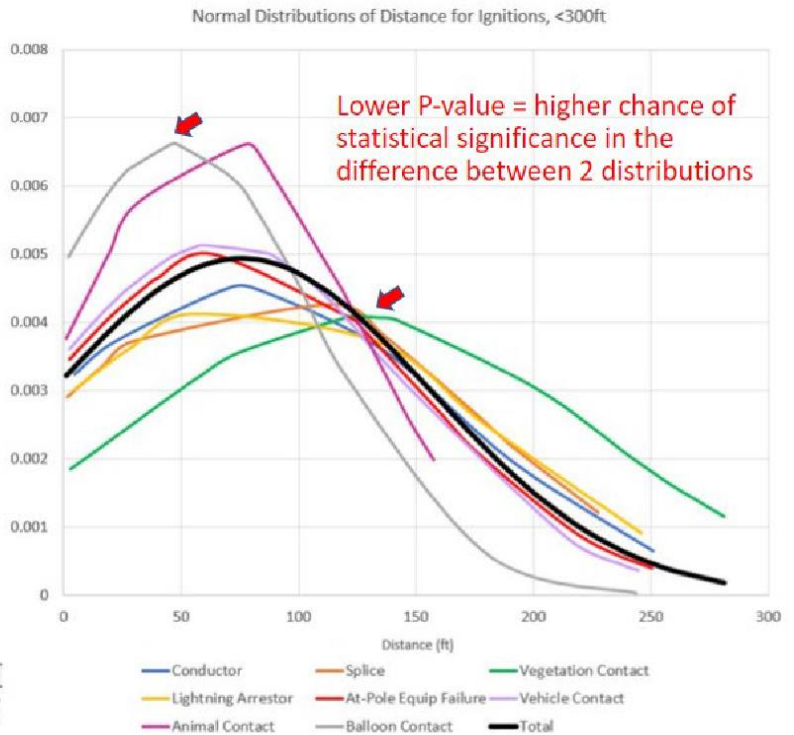
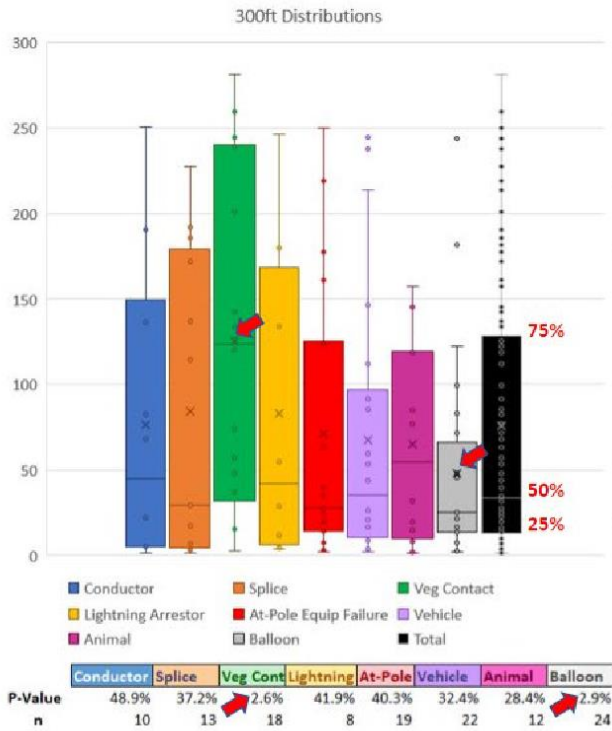

Equipment Failure Ignitions by Distance from Source Facility (to scale) – 12kV

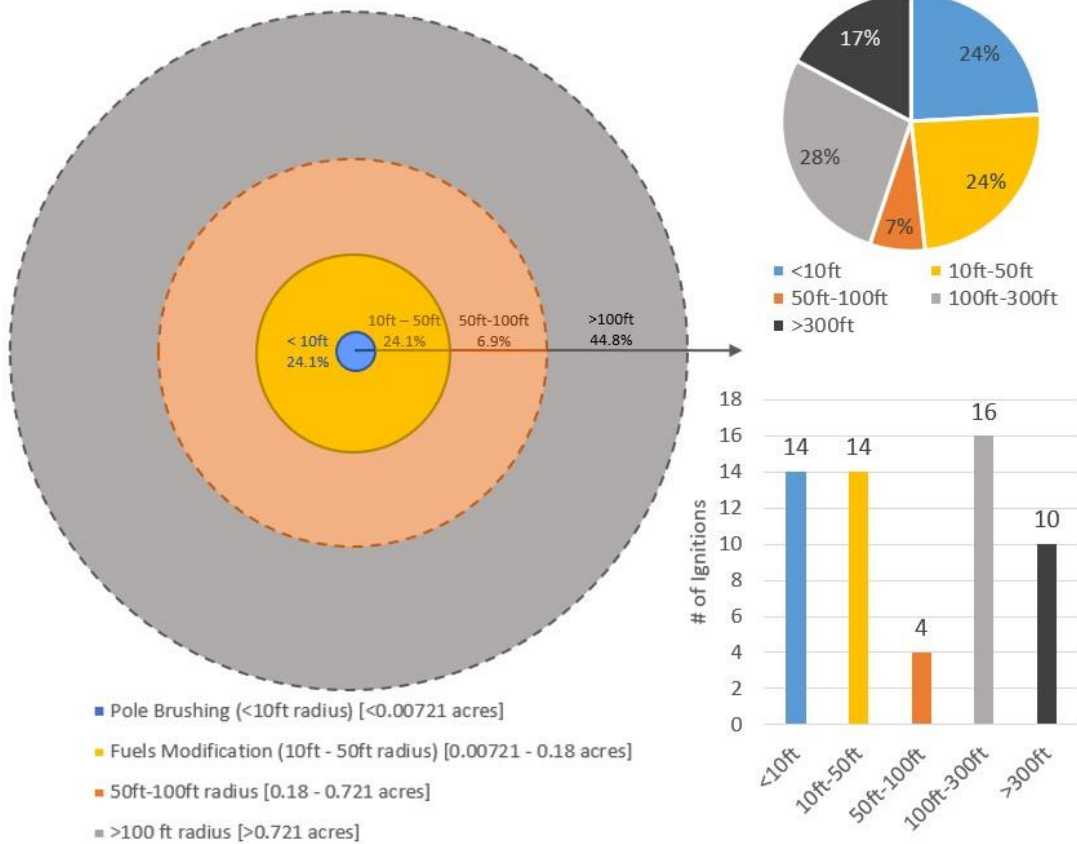

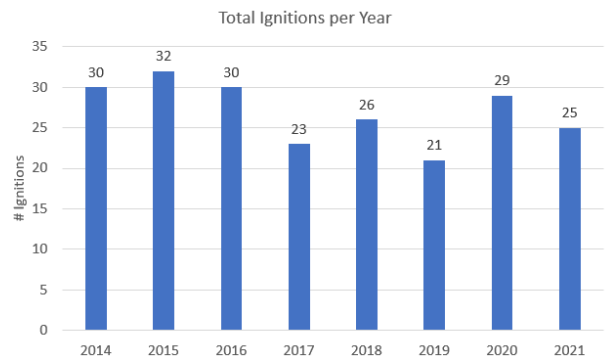
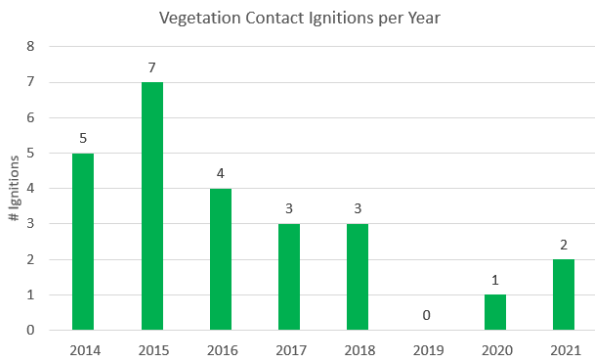
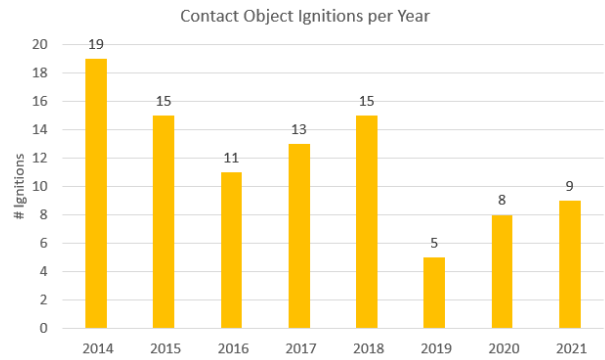
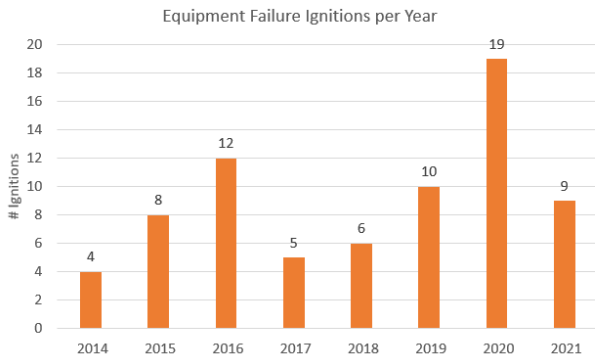

Equipment Failures per Year by Equipment Type

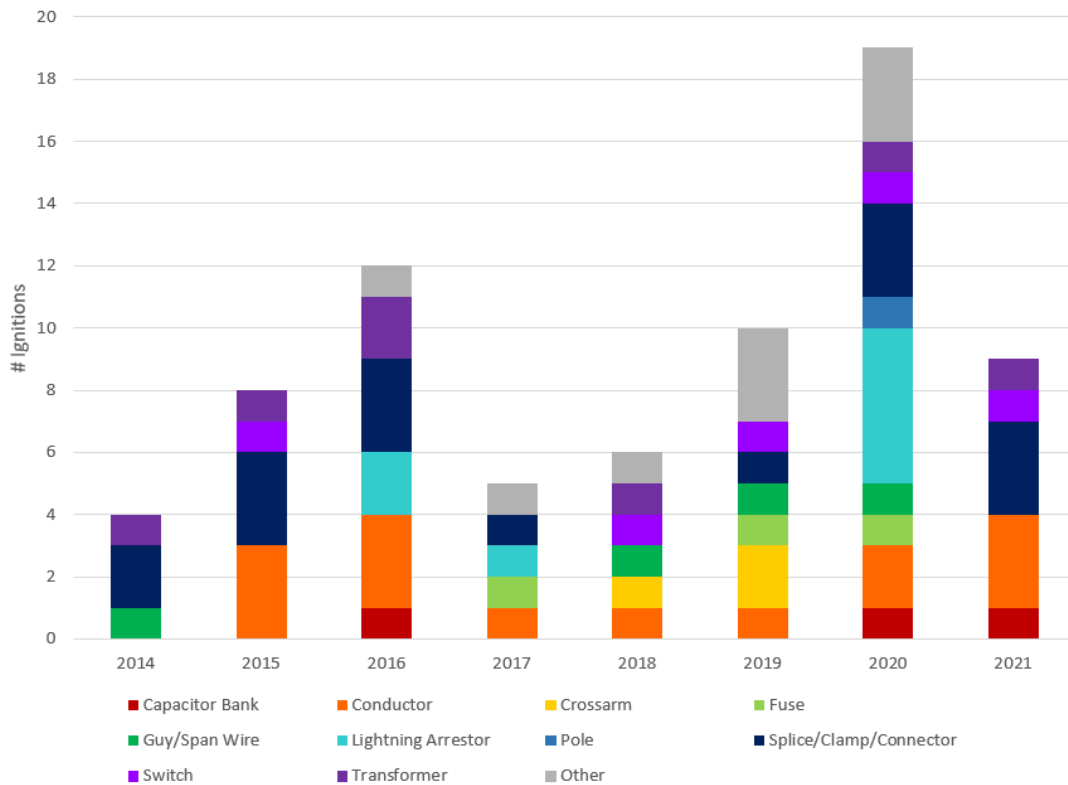

Attachment E: WiNGS-Ops Progress Report



WINGS-OPS PROGRESS REPORT

Area of Improvement SDGE-22-30 FROM OIES



Table of Contents

1	Vegetation Model	1
1.1	Progress.....	1
1.2	Successes.....	1
1.3	Issues Encountered	1
1.4	Lessons Learned	2
2	Conductor Model PoF	2
2.1	Progress.....	2
2.2	Successes.....	2
2.3	Issues Encountered	2
2.4	Lessons Learned	2
3	PSPS Model	2
3.1	Progress.....	2
3.2	Successes.....	3
3.3	Issues Encountered	3
3.4	Lessons Learned	3
4	Vehicle Contact Model.....	3
4.1	Progress.....	3
4.2	Successes.....	3
4.3	Issues Encountered	3
4.4	Lessons Learned	3
5	AWS Model Deployment.....	3
5.1	Progress.....	3
5.2	Successes.....	4
5.3	Issues Encountered	4
5.4	Lessons Learned	4
6	Visualization	4
6.1	Progress.....	4
6.2	Successes.....	4
6.3	Issues Encountered	5
6.4	Lessons Learned	5
7	Span POI Model.....	5

7.1	Progress.....	5
7.2	Successes.....	5
7.3	Issues Encountered	5
7.4	Lessons Learned	5
8	Balloon POF Model	5
8.1	Progress.....	5
8.2	Successes.....	6
8.3	Issues Encountered	6
8.4	Lessons Learned	6
9	Animal Contact Model	6
9.1	Progress.....	6
9.2	Successes.....	6
9.3	Issues Encountered	6
9.4	Lessons Learned	6

SDG&E did not experience any PSPS events in 2022. However, SDG&E continued to make improvements and enhancements to WiNGS Ops models and visualizations. The purpose of this document is to provide a high-level progress report up until September 1, 2022.

1 Vegetation Model

1.1 Progress

- Migrated machine learning pipeline to AWS Cloud Sagemaker to improve reproducibility and transparency
- Developed data pipelines for ingesting open-source Landsat and NAIP imagery for model training
- Developed methodology for acquiring and processing imagery data for assets
- Implemented log file writing when generating datasets to identify data inconsistencies
- Developed methodology for linking assets to weather station data for given historic event
- Completed initial exploratory analysis (hypothesis testing) for imagery correlation with outage data

1.2 Successes

- Gained deeper understanding of multiple data sources: tree inventory (PowerWorkz), open-source imagery, weather station data
- Developed first Tensorflow model architecture to train on imagery
- Linked wind vectors to historic outages
- Trained simple POC model (AUC ~ 0.7)

1.3 Issues Encountered

- Each dataset presented a series of challenges. For example:
 - Weather data: linking to historic events spatially and temporally
 - PowerWorkz: summarizing activity information
 - Landsat: acquiring the correct collection event
 - NAIP: acquiring the correct tile
- Imagery data presents a whole new set of challenges for data engineering and operations:
 - Processing and storing unstructured data (non-tabular)
 - New set of algorithms to process multispectral arrays
 - Storing image metadata
 - Interpolations and extrapolations with image manipulations
 - New frameworks for machine learning (Tensorflow)
 - Understanding the core information through documentation
- Internal networking restrictions for accessing data and external Python libraries
- Novel approaches image processing required
- Computational cost: scripts need to be optimized for deployment in production environments

1.4 Lessons Learned

- Teams should weigh cost associated with bringing in additional data sources and perceived advantages
- Storing and processing of unstructured data (imagery) requires a different set of tools and development of skills to work with the new tools
- Image processing is often slow and compute-intensive, and this is a limitation for building models that can be used in production. The data scientist must work with data engineers and operations to account for this limitation when building models
- Many processes that are time-intensive require more advanced development practices to be practical. Logging is particularly useful for tracking long-running processes

2 Conductor Model PoF

2.1 Progress

- Updated model with 2021 observations
- Investigated further the effect of conductor age
- Optimized model variables to predict in cloud environments

2.2 Successes

- Model created in local machine has successfully been transitioned to cloud environments
- Collaborate and benchmark model with Exponent studies (in-progress)
- Relatively short deployment-acceptance-production time of the model

2.3 Issues Encountered

- Measuring the effect of conductor ages is extremely difficult due to multicollinearity issues between independent variables

2.4 Lessons Learned

- Building models in local environments should be avoided in the future for easier transfer of information between data scientist, Machine Learning engineers, and cloud deployment.

3 PSPS Model

3.1 Progress

- Reviewed and updated main model assumptions (safety components, customer impact scaling factors, financial impact to customers)
- Developed new framework to capture PSPS impacts on Access and Functional Needs (AFN) customers
- Financial:
 - Reviewed estimates from Lawrence Berkeley National Laboratory (LBNL) analysis

- Created financial estimates dependent on PSPS duration estimates for Residential, Residential AFN, Commercial and Industrial customers.
- Safety:
 - Performed historical PSPS duration analysis for PG&E, SCE, and SG&E
 - Reviewed past nationwide widespread power outages events

3.2 Successes

- Socialized framework for AFN customers with internal stakeholders and gained acceptance
- Participated and defended model in OEIS workshops

3.3 Issues Encountered

- LBNL model limitations to capture planned outages and long duration outages

3.4 Lessons Learned

- PSPS impacts need to be investigated further
- LBNL model limitations to capture planned outages and long duration outages

4 Vehicle Contact Model

4.1 Progress

- Explored new methodology and new variables to update existing model
- Explored new variables to improve model accuracy (i.e., find distance between base of the pole and nearest road)
- Resolved environment issues when working with OSMnx Python library
- Transition existing model to cloud environment

4.2 Successes

- Working to find distance of each pole to the road
- Update and expand existing Exploratory Data Analysis (EDA) to better understand vehicle contact conditions

4.3 Issues Encountered

- Cybersecurity constrains and SSL verification errors when migrating model to cloud

4.4 Lessons Learned

- N/A

5 AWS Model Deployment

5.1 Progress

- Finalized repo strategy discussions

- Continued work on model production:
 - Acquired approval of production strategy from Change Architecture Review Board (CARB)
 - Completed data mesh POC
 - Researched model endpoints
 - Resolved requirements.txt bug for model deployments
 - Initialized work on repo continuous integration/continuous development (CI/CD) code but found some bugs; DevSecOps support pending
- Continued deeper dive into flat file sources
- Worked on pipelines for outage ignitions
- Continued work on prod deployment (cross-account)
- Worked on inference pipeline scheduling
- Coordinated with data science team on outputs needed and scheduling cadence

5.2 Successes

- Completed pipelines for outage ignitions repos
- Set up resources (pipeline, Terraform, etc.) for containers POC
- Productionized updated balloon contact model to run with new features
- Enabled Environment Variables to be passed through JSON file for future scheduling with AWS Cloud SageMaker pipelines
- Optimized model run time
- Auditability has improved with the move to stored repos and checkpointing runs

5.3 Issues Encountered

- Data loss from datatype mismatch on merged data frames impacting WiNGS Ops

5.4 Lessons Learned

- Improve team knowledge of AWS
- Additional time is needed to set up production workflows for machine learning models
- Data within AWS can be a challenge depending on the source

6 Visualization

6.1 Progress

- Kicked off Visualization team to create a new and interactive visualization platform
- Continued work on product design: persona review, key features, data needs
- Created SCADA Sectionalizing Device hierarchy diagrams
- Established priorities for data sources to be displayed in the tool
- Successfully launched Proof of Concept and gained adoption with internal users

6.2 Successes

- Centralization of multiple data sources is achieved in a single platform

- The visualization platform provides users the ability to quickly and efficiently access and interact with asset, customer, and risk data.

6.3 Issues Encountered

- Integration of multiple data sources
- Alignment between multiple data owners
- Cybersecurity constrains with Customer data

6.4 Lessons Learned

- Data integration and validation is a lengthy process

7 Span POI Model

7.1 Progress

- Conducted team meeting for high-level technical overview
- Finalizing 2022 training set
- Created virtual environment to run model on AWS
- Created new code repository
- Updated data with 2021 observations

7.2 Successes

- Presented Exploratory Data Analysis (EDA) to modeling group and received useful feedback on feature engineering
- Complete model migration to AWS Cloud Sagemaker
- Model deployment in AWS

7.3 Issues Encountered

- AWS Cloud Sagemaker Transition is complex and will take time to implement

7.4 Lessons Learned

- Work as a group with various departments and stakeholders to create model features
- Consider how the data is collected and work with data owners early in the process

8 Balloon POF Model

8.1 Progress

- Migrated model to AWS Cloud Sagemaker platform for improved reproducibility
- Piloted the use of AWS Cloud Sagemaker Feature Store as a means for storing and sharing compute-intensive model features
- Completed production deployment of model and integrated with existing inference pipeline

8.2 Successes

- Full utilization of AWS Cloud Sagemaker Platform for model development, including use of Model Building Pipelines, Feature Store, and Model Registry
- New methodologies for model development integrated with existing inference pipelines

8.3 Issues Encountered

- Inefficiencies encountered with custom runtime environments for data processing and model training; workarounds required
- Limitations discovered with AWS Cloud Sagemaker platform
- AWS Cloud Sagemaker documentation was unclear

8.4 Lessons Learned

- AWS Cloud Sagemaker is a useful Platform for robust pipelines, but is a large source of overhead for the data scientists
- Balance between robust development in the AWS Cloud Sagemaker environment and workable data science code to yields quicker results.
- AWS Cloud Sagemaker Model registry is the median between data science and operations

9 Animal Contact Model

9.1 Progress

- Script refactored for better readability and maintainability
- Script now using AWS for inputs and outputs
- Script version controlled in Azure DevOps

9.2 Successes

- Investigate Animal Contact Model update feasibility
- Convert OHSTRUCT_PRIOR on-prem database read to AWS Read
- Refactor Script
- Create animal contact ADO repo
- Inputs read from AWS
- Uploading outputs to AWS

9.3 Issues Encountered

- N/A

9.4 Lessons Learned

- Getting new data into AWS requires time and can be a slow process

Appendix E: Referenced Regulations, Codes, and Standards



APPENDIX E: REFERENCED REGULATIONS, CODES, AND STANDARDS

2023 Wildfire Mitigation Plan



Name of Regulation, Code, or Standard	Brief Description
Public Resources Code § 4292	CAL FIRE requires 10 feet of minimum clearance around the base of the pole cleared of all flammable vegetation down to bare soil and the removal of all dead tree branches within this cylinder up to the cross-arm (within the State Responsibility Area)
Public Resources Code § 4293	CAL FIRE requires 10 feet of minimum clearance around the base of the pole cleared of all flammable vegetation down to bare soil and the removal of all dead tree branches within this cylinder up to the cross-arm (within the State Responsibility Area)
Public Utilities Code § 8386	Law that, among other things, requires electric corporations to submit wildfire mitigation plans
Public Utilities Code § 768.6	Statute related to emergency and disaster preparedness plans
Resolution WSD-002	Guidance Resolution on 2020 Wildfire Mitigation Plans Pursuant to Public Utilities Code Section 8386.
Resolution WSD-005	Resolution Ratifying Action of the Wildfire Safety Division on San Diego Gas & Electric Company's 2020 Wildfire Mitigation Plan Pursuant to Public Utilities Code Section 8386.
Resolution WSD-011	Resolution implementing the requirements of Public Utilities Code Sections 8389(d)(1), (2) and (4), related to catastrophic wildfire caused by electrical corporations subject to the Commission's regulatory authority
Resolution M-4835	Orders emergency residential and non-residential customer protections for wildfire victims
R.18-10-007	Order Instituting Rulemaking to Implement Electric Utility Wildfire Mitigation Plans Pursuant to Senate Bill 901 (2018)
R.20-07-013	Order Instituting Rulemaking to Further Develop a Risk-based Decision-making Framework for Electric and Gas Utilities
D.14-02-015	CPUC Decision Adopting Regulations to Reduce the Fire Hazards Associated with Overhead Electric Utility Facilities and Aerial Communication Facilities; Requires annual reportable ignitions report
D.15-11-021	CPUC Decision on Test Year 2015 General Rate Case for Southern California Edison Company
D.16-08-018	CPUC Interim Decision Adopting the Multi-Attribute Approach (or Utility Equivalent Features) and Directing Utilities to Take Steps Toward a More Uniform Risk Management Framework
D.18-12-014	CPUC Phase 2 Decision Adopting Safety Model Assessment Proceeding Settlement Agreement with Modifications
D.19-05-042	CPUC Decision Adopting De-Energization (Public Safety Power Shutoff) Guidelines (Phase 1 Guidelines)
D.19-05-039	CPUC Decision on SDG&E's 2019 WMP Pursuant to Senate Bill 901
D.19-07-015	CPUC Decision Adopting an Emergency Disaster Relief Program for Electric, Natural Gas, Water, and Sewer Utility Customers
D.20-05-051	CPUC Decision Adopting Phase 2 Updated and Additional Guidelines for De-Energization of Electric Facilities to Mitigate Wildfire Risk
D.20-03-004	CPUC Decision on Community Awareness and Public Outreach Before, During, and After a Wildfire, and Explaining Next Steps for Other Phase 2 Issues

Name of Regulation, Code, or Standard	Brief Description
General Order 95	Overhead electric line design, construction, and maintenance requirements in order to ensure adequacy of service and safety; covers topics such as proper grounding, clearances, strength requirements, and tree trimming
General Order 128	Underground electric line design, construction, and maintenance requirements in order to ensure adequacy of service and safety; covers clearance and depths
General Order 131-D	CPUC Rules relating to the planning and construction of electric operation, transmission/power/distribution line facilities and substations located in California
General Order 165	Inspection requirements for transmission and distribution facilities in order to ensure safety and high-quality electrical service; sets maximum allowable inspection cycle lengths, scheduling and performance of corrective action, record-keeping, and reporting
General Order 166	Standards for Operation, Reliability, and Safety During Emergencies and Disasters
General Order 174	Inspection requirements for substations to promote the safety of workers, the public, and enable adequacy of service
Government Code § 8593.3	Government of the State of California, California Emergency Services Act, Accessibility to Emergency Information and Services.
NERC FAC-003-4	Federal reliability standard; establishes a minimum clearance that must be maintained at all times between trees and transmission line rights of way that include consideration for line sag and wind sway
WSD GIS Data Standards	Wildfire Safety Division Draft Geographic Information System Data Reporting Requirements and Schema for California Electrical Corporations (August 21, 2020); Sets forth requirements for WMP spatial data submissions
WSD Evaluation of SDG&E RCP	Wildfire Safety Division Evaluation of San Diego Gas & Electric Company's Remedial Compliance Plan (December 30, 2020); Assessing SDG&E's 2020 WMP Class A Deficiencies
WSD Quality Control Report on SDG&E GIS Data	Wildfire Safety Division Quality Control Report on GIS Data Submitted by San Diego Gas & Electric on September 9, 2020 (December 29, 2020); Assesses SDG&E spatial data submission
WSD Evaluation of SDG&E Initial Quarterly Report	Wildfire Safety Division Evaluation of San Diego Gas & Electric Company's First Quarterly Report (January 8, 2021); Assessing SDG&E's 2020 WMP Class B Deficiencies
OEIS Final Action Statements	Office of Energy Infrastructure Safety Final Revised Action Statement issued July 2021.
OEIS Final Guidelines	Office of Energy Infrastructure Safety Final Guidelines issued December 2021.
Title 8 CCR § 5141.1	Cal/OSHA Protection from Wildfire Smoke regulation
SDG&E G8373	SDG&E's Wildfire Smoke Protection standard

Best Practice/Award/Other	Brief Description
California Standardized Emergency Management Systems (SEMS)	Manages emergencies to coordinate across all levels of utility and governments.

Best Practice/Award/Other	Brief Description
EMAP Certification	Emergency Management Accreditation Program.
Expanded Clearances (Discretionary Activity)	Expanded clearances performed within the HFTD as an enhanced measure to mitigate the risk of outage and ignition. CPUC GO 95, Rule 35 recognizes in its post-trim clearance recommendations utilities' discretion to determine the appropriate clearance to maintain safety, compliance, and reliability. SDG&E exceeds the CPUC's 12-foot post-trim recommendation and applies enhanced clearances on targeted species that could pose a threat to the line by encroachment and/or branch/trunk failure. Expanded clearances are often required to maintain safety and prevent ignitions for at least on annual pruning cycle.
Fuels Management (Discretionary Activity)	Non-mandated, discretionary activity on poles located within the HFTD where pole brushing is already required for PRC 4292. Fuels management is an additional fire mitigation measure to thin flammable vegetation in a broader radius surrounding a pole to minimize the risk of ignition resulting from molten ejecta or pole failure. SDG&E believes this is a safe and prudent measure to further mitigate fire risk within the HFTD.
National Incident Management System (NIMS)	Incident management structure to maintain chain of command and span of control principles for crisis management.
Pole Brushing (Discretionary Activity)	Discretionary activity performed on poles located outside the State Responsibility Area and HFTD where ignition could result because of the attached equipment, proximity of flammable fuels, and topography that could propagate fire. SDG&E believes this is a safe and prudent measure to further mitigate fire risk in areas adjacent to the portions of the service territory with the highest fire threat.
Reliability One Award	Utility industry awards program that identifies top performers and best practices that promote innovation and technology advancements, and utilities that place the highest value on their customers.
Resiliency Audit	Online survey engaging HFTD customers assisting to increase overall resiliency and preparation for PSPS.
Tree Line USA Program	Program run by Arbor Day Foundation for utilities that meet specific criteria including annual worker training, tree planting, quality tree care, educational awareness, and Arbor Day celebrations. SDG&E has received the award for 20 consecutive years.
Wildfire and Climate Resilience Center (WCRC)	Best Practice for internal and external wildfire mitigation/PSPS collaboration.

Appendix F: Tables



APPENDIX F: TABLES

2023 Wildfire Mitigation Plan



Table of Contents

1	OEIS Table 8-44: State and Local Agency Collaboration(s) - Redacted	1
2	OEIS Table 8-46: High-Level Communication Protocols, Procedures, and Systems with Public Safety Partners - Redacted	2
3	OEIS Table 8-61: Collaboration in Local Wildfire Mitigation Planning	10
4	OEIS Table 9-2: Frequently De-energized Circuits.....	13

1 OEIS Table 8-44: State and Local Agency Collaboration(s) - Redacted

Name of State or Local Agency	Point of Contact and Information	Emergency Preparedness Plan Collaboration – Last Version of Plan Agency Collaborated	Emergency Preparedness Plan Collaboration – Collaborative Role	Memorandum of Agreement (MOA)?	Brief Description of MOA
2-1-1 San Diego	Community Partnership Manager <i>REDACTED</i>	Update of the CEADPP – virtual meeting – 6/2022	Wildfire/PSPS protocols feedback and review	No	n/a
2-1-1 Orange County	Program Supervisor <i>REDACTED</i>	Update of the CEADPP – virtual meeting – 6/2022	Wildfire/PSPS protocols feedback and review	No	n/a
CAL FIRE	Fire Chief <i>REDACTED</i>	Update of the CEADPP – virtual meeting – 6/2022	Wildfire/PSPS protocols feedback and review	No	n/a
County OES	Staff Duty Officer <i>REDACTED</i>	Update of the CEADPP – virtual meeting – 6/2022	Wildfire/PSPS protocols feedback and review	No	n/a
Cal OES	Emergency Manager <i>REDACTED</i>	Update of the CEADPP – virtual meeting – 6/2022	Wildfire/PSPS protocols feedback and review	No	n/a
San Diego County	Emergency Services Coordinator <i>REDACTED</i>	Update of the CEADPP – virtual meeting – 6/2022	Wildfire/PSPS protocols feedback and review	No	n/a
American Red Cross	Disaster Program Manager <i>REDACTED</i>	Update of the CEADPP – virtual meeting – 6/2022	Wildfire/PSPS protocols feedback and review	No	n/a

2 OEIS Table 8-46: High-Level Communication Protocols, Procedures, and Systems with Public Safety Partners - Redacted

Public Safety Partner Group	Name of Entity	Title	Point of Contact and Information
Law Enforcement	California Highway Patrol	Sergeant	REDACTED
Law Enforcement	Coronado Police Department	Chief of Police	REDACTED
Law Enforcement	El Cajon Police Department	Lieutenant	REDACTED
Law Enforcement	Harbor Police Department	Harbor Port Dispatch	REDACTED
Law Enforcement	Laguna Niguel Police Department	Emergency Preparedness Coordinator	REDACTED
Law Enforcement	Orange County Sheriff's Department	Emergency Preparedness Coordinator	REDACTED
Law Enforcement	San Diego County Sheriff	Emergency Planning Detail	REDACTED
Law Enforcement	San Diego Law Enforcement Coordination Center	Exercise Program Manager	REDACTED
Law Enforcement	San Diego Police Department	Dispatch Administrator	REDACTED
Law Enforcement	San Pasqual Police Department	Police	REDACTED
Public Safety	2-1-1 Orange County	Program Supervisor	REDACTED
Public Safety	2-1-1 San Diego	Community Partnership Manager	REDACTED
Public Safety	Aliso Viejo	Emergency Manager	REDACTED
Public Safety	Alvarado Hospital	Director Plant Supervisor	REDACTED
Public Safety	Barona Band of Mission Indians	Councilman	REDACTED
Public Safety	Campo Band of Kumeyaay Indians	Chairman	REDACTED
Public Safety	Carlsbad	Emergency Services Manager	REDACTED

Public Safety Partner Group	Name of Entity	Title	Point of Contact and Information
Public Safety	Chula Vista	Emergency Manager	REDACTED
Public Safety	City of Encinitas	Emergency Manager	REDACTED
Public Safety	Coronado	Emergency Management Coordinator	REDACTED
Public Safety	Dana Point	Emergency Manager	REDACTED
Public Safety	Del Mar	Fire Chief	REDACTED
Public Safety	El Cajon	Emergency Manager	REDACTED
Public Safety	Encinitas	City Clerk	REDACTED
Public Safety	Engineering and Capital Projects Department	Director and City Engineer	REDACTED
Public Safety	Escondido	Emergency Disaster Preparedness Manager	REDACTED
Public Safety	Ewiiapaayp Band of Kumeyaay Indians	Tribal Representative	REDACTED
Public Safety	Federal	Congressman	REDACTED
Public Safety	lipay Nation of Santa Ysabel	Emergency Readiness Coordinator	REDACTED
Public Safety	Imperial Beach	Community Development Dept	REDACTED
Public Safety	Inaja-Cosmit Band of Indians	Administrative Assistant	REDACTED
Public Safety	Indian Health Council Rincon	Indian Health Council (Facilities Director)	REDACTED
Public Safety	Jacumba Community Service District	Rep	REDACTED
Public Safety	Jamul Indian Village A Kumeyaay Nation	Executive Assistant	REDACTED
Public Safety	Julian Community Service District	Rep	REDACTED
Public Safety	Kaiser Permanente	Facilities Operations	REDACTED
Public Safety	La Jolla Band of Luiseño Indians	Councilman	REDACTED

Public Safety Partner Group	Name of Entity	Title	Point of Contact and Information
Public Safety	La Mesa	Emergency Manager	REDACTED
Public Safety	La Posta Band of Mission Indians	Councilman	REDACTED
Public Safety	Laguna Beach	Emergency Manager	REDACTED
Public Safety	Laguna Hills	Councilmember	REDACTED
Public Safety	Laguna Niguel	Councilmember	REDACTED
Public Safety	Lemon Grove	Emergency Manager	REDACTED
Public Safety	Los Coyotes Band of Indians	Council Member	REDACTED
Public Safety	Manzanita Band of the Kumeyaay Nation	Chairwoman	REDACTED
Public Safety	Mesa Grande Band of Mission Indians	Chairman	REDACTED
Public Safety	Mission Hospital- Laguna Beach	Facilities Manager	REDACTED
Public Safety	Mission Hospital- Mission Viejo	Manager Facilities & Engineering	REDACTED
Public Safety	Mission Viejo	Emergency Manager	REDACTED
Public Safety	National City	Emergency Manager	REDACTED
Public Safety	Naval Base Coronado	Emergency Management	REDACTED
Public Safety	Oceanside	Councilmember	REDACTED
Public Safety	Orange County Board of Supervisors	Supervisor 1st District	REDACTED
Public Safety	Pala Band of Mission Indians	Emergency Management Coordinator	REDACTED
Public Safety	Pauma Band of Mission Indians	Tribal Administrator	REDACTED
Public Safety	Pechanga Band	Emergency Services Coordinator	REDACTED
Public Safety	Port of San Diego	Emergency Manager	REDACTED

Public Safety Partner Group	Name of Entity	Title	Point of Contact and Information
Public Safety	Poway	Emergency Services	REDACTED
Public Safety	Rady Children's Hospital	Sr Director Plant Operations and Maintenance	REDACTED
Public Safety	Rancho Santa Fe Assn.	Rancho Santa Fe Association Mgr	REDACTED
Public Safety	Rancho Santa Margarita	Emergency Manager	REDACTED
Public Safety	Rincon Band of Luiseño Indians	Fire Chief	REDACTED
Public Safety	Saddleback College	Chief of Police	REDACTED
Public Safety	San Clemente	Emergency Manager	REDACTED
Public Safety	San Diego	Director of Communications	REDACTED
Public Safety	San Diego County	Emergency Services Coordinator	REDACTED
Public Safety	San Diego County Regional Airport Authority	n/a	REDACTED
Public Safety	San Juan Capistrano	Emergency Operations Center Manager - Tertiary	REDACTED
Public Safety	San Marcos	Councilmember	REDACTED
Public Safety	Santee	Fire Chief	REDACTED
Public Safety	Scripps	Engineering Operations	REDACTED
Public Safety	Sharp Healthcare	Senior Project Manager	REDACTED
Public Safety	Solana Beach	Councilmember	REDACTED
Public Safety	Southern Indian Health Council	Indian Health Council	REDACTED
Public Safety	State	Communications Director	REDACTED
Public Safety	Sycuan Band of the Kumeyaay Nation	Planning & Development Manager	REDACTED
Public Safety	Tri-City Medical Center	Safety Manager	REDACTED

Public Safety Partner Group	Name of Entity	Title	Point of Contact and Information
Public Safety	U.S. Navy	Navy EOC	REDACTED
Public Safety	VA Hospital	Assistant Chief, Engineering	REDACTED
Public Safety	Viejas Band of Kumeyaay Indians	Resource Manager Director	REDACTED
Public Safety	Vista	Emergency Manager	REDACTED
Emergency Response	American Red Cross	Disaster Program Manager	REDACTED
Emergency Response	American Red Cross of San Diego and Imperial Counties	Red Cross	REDACTED
Emergency Response	Carlsbad Fire Department	Assistant Director of Emergency Services	REDACTED
Emergency Response	CUEA	Emergency Manager	REDACTED
Emergency Response	Coronado Fire Department	Fire Marshall	REDACTED
Emergency Response	Deer Springs Fire Protection District	Chief	REDACTED
Emergency Response	Encinitas Fire Department	Management Analyst	REDACTED
Emergency Response	Escondido Police and Fire Communications	Public Safety Manager	REDACTED
Emergency Response	Heartland Fire	Chief	REDACTED
Emergency Response	Imperial Beach Fire Department	Assistant Fire Marshall	REDACTED
Emergency Response	Monte Vista Fire Dispatch Center	Dispatch Supervisor	REDACTED
Emergency Response	North County Dispatch Center	Dispatch Supervisor	REDACTED
Emergency Response	Oceanside Fire Department	Chief	REDACTED
Emergency Response	Orange County Fire Authority	Director of Communications	REDACTED
Emergency Response	Orange County OES	Office of Emergency Management	REDACTED

Public Safety Partner Group	Name of Entity	Title	Point of Contact and Information
Emergency Response	San Diego Emergency Management	Emergency Management	REDACTED
Emergency Response	San Diego County OES	Staff Duty Officer	REDACTED
Emergency Response	San Diego Fire Rescue	n/a	REDACTED
Emergency Response	San Diego Office of Emergency Services	Interim Program Manager	REDACTED
Emergency Response	San Marcos Fire Department	Division Chief	REDACTED
Emergency Response	Sycuan Tribal Government Fire Department	Fire Chief	REDACTED
Water Service Providers	California Department of Water	Principal Engineer	REDACTED
Water Service Providers	Carlsbad Water	Supervisor	REDACTED
Water Service Providers	Department of Water Resources	Risk Management	REDACTED
Water Service Providers	Descanso Community Water District	Manager	REDACTED
Water Service Providers	Lakeside Water District	Manager	REDACTED
Water Service Providers	Metropolitan Water District	Metropolitan Water District EOC	REDACTED
Water Service Providers	Olivenhain Municipal Water District	Water System Supervisor	REDACTED
Water Service Providers	Municipal Water District of Orange County	Director of Emergency Management	REDACTED
Water Service Providers	Ramona Municipal Water District	General Manager	REDACTED
Water Service Providers	Rancho Santa Teresa Water	Rep	REDACTED
Water Service Providers	Rincon Del Diablo Municipal Water District	Water System Supervisor	REDACTED
Water Service Providers	San Diego County Water Authority	Manager	REDACTED
Water Service Providers	South Coast Water District	Manager	REDACTED
Water Service Providers	South Orange County Water Authority	Manager	REDACTED

Public Safety Partner Group	Name of Entity	Title	Point of Contact and Information
Water Service Providers	Summit Estates Mutual Water	Rep	REDACTED
Water Service Providers	Sweetwater Water Authority	Supervisor	REDACTED
Waste Water Service Providers	Encina Waste Water Authority	Director of Operations	REDACTED
Waste Water Service Providers	Leucadia Wastewater Water District	Supervisor	REDACTED
Communication Service Providers	AT&T	Sr. Program Manager	REDACTED
Communication Service Providers	AT&T Wireline	Manager	REDACTED
Communication Service Providers	Charter	Manager	REDACTED
Communication Service Providers	Cox Communications	Network Operations	REDACTED
Communication Service Providers	Heartland Communications	Operations Manager	REDACTED
Communication Service Providers	T-Mobile/Sprint	Manager	REDACTED
Communication Service Providers	Verizon Wireless	Network Operations	REDACTED
Community Choice Aggregators	Clean Energy Alliance	CEO	REDACTED
Community Choice Aggregators	Orange County Power Authority	Data Analyst	REDACTED
Community Choice Aggregators	San Diego Community Power	Program Manager	REDACTED
Affected Publicly Owned Utilities	Caltrans	Caltrans Electric Supervisor	REDACTED

Public Safety Partner Group	Name of Entity	Title	Point of Contact and Information
Affected Publicly Owned Utilities	Fallbrook Public Utility District	Operations Manager	REDACTED
Affected Publicly Owned Utilities	Helix Water District	Water Treatment Plan Manager	REDACTED
Affected Publicly Owned Utilities	Los Tules Mutual Water Company	Water System Supervisor	REDACTED
Affected Publicly Owned Utilities	Moulton Niguel Water District	Moulton Niguel MWD	REDACTED
Affected Publicly Owned Utilities	Otay Water District	Supervisor	REDACTED
Affected Publicly Owned Utilities	Padre Dam Municipal Water District	Systems Operator	REDACTED
Affected Publicly Owned Utilities	Palomar Mountain Water District	Manager	REDACTED
Affected Publicly Owned Utilities	Pauma Valley Water Company	Rep	REDACTED
Affected Publicly Owned Utilities	Pine Valley Mutual Water Company	Rep	REDACTED
Affected Publicly Owned Utilities	Rancho Pauma Mutual Water Company	Rep	REDACTED
Affected Publicly Owned Utilities	San Elijo Jnt Pwr Auth	Director	REDACTED
Affected Publicly Owned Utilities	Santa Fe Irrigation District	Operations and Maintenance Manager	REDACTED
Affected Publicly Owned Utilities	Santa Margarita Water District	Water System Supervisor	REDACTED

Public Safety Partner Group	Name of Entity	Title	Point of Contact and Information
Affected Publicly Owned Utilitie	Vallecitos Water District	Water System Supervisor	REDACTED
Affected Publicly Owned Utilitie	Valley Center Municipal Water District	Water Treatment Operator	REDACTED
Affected Publicly Owned Utilitie	Vista Irrigation District	Director of Water Resources	REDACTED
Affected Publicly Owned Utilitie	West Cuca Mutual Water Company	Rep	REDACTED
Affected Publicly Owned Utilitie	Yuima Municipal Water District	Manager	REDACTED
The Commission	CPUC	Tribal Advisor	REDACTED
CalOES	California State Warning Center	n/a	REDACTED
CalOES	CalOES	Emergency Manager	REDACTED
CalOES	CalOES Office of Tribal Affairs	Tribal Affairs Coordinator	REDACTED
CAL FIRE	Cal Fire	Fire Chief	REDACTED

3 OEIS Table 8-61: Collaboration in Local Wildfire Mitigation Planning

Name of County, City, or Tribal Agency or Civil Society Group (e.g., nongovernment organization, fire safe council)	Program, Plan, or Document	Last Version of Collaboration	Level of Collaboration
211 San Diego	Wildfire Preparedness	2022 version 06/2022	Wildfire Preparedness and Resiliency Workshop
Cal OES Office of Tribal Coordination	Wildfire Preparedness	2022 version 06/2022	Wildfire Preparedness and Resiliency Workshop
CAL FIRE	Wildfire Preparedness	2022 version 06/2022	Wildfire Preparedness and Resiliency Workshop
California Governor's Office of Emergency Services	Wildfire Preparedness	2022 version 06/2022	Wildfire Preparedness and Resiliency Workshop

Name of County, City, or Tribal Agency or Civil Society Group (e.g., nongovernment organization, fire safe council)	Program, Plan, or Document	Last Version of Collaboration	Level of Collaboration
California Public Utilities Commission	Wildfire Preparedness	2022 version 06/2022	Wildfire Preparedness and Resiliency Workshop
City of San Diego	Wildfire Preparedness	2022 version 06/2022	Wildfire Preparedness and Resiliency Workshop
County of San Diego OES	Wildfire Preparedness	2022 version 06/2022	Wildfire Preparedness and Resiliency Workshop
County of San Diego	Wildfire Preparedness	2022 version 06/2022	Wildfire Preparedness and Resiliency Workshop
CPUC	Wildfire Preparedness	2022 version 06/2022	Wildfire Preparedness and Resiliency Workshop
Metropolitan Water District of Southern California	Wildfire Preparedness	2022 version 06/2022	Wildfire Preparedness and Resiliency Workshop
Port of San Diego Harbor Police	Wildfire Preparedness	2022 version 06/2022	Wildfire Preparedness and Resiliency Workshop
Rainbow Municipal Water District	Wildfire Preparedness	2022 version 06/2022	Wildfire Preparedness and Resiliency Workshop
San Diego Community Power	Wildfire Preparedness	2022 version 06/2022	Wildfire Preparedness and Resiliency Workshop
San Diego County Fire Prot. District	Wildfire Preparedness	2022 version 06/2022	Wildfire Preparedness and Resiliency Workshop
San Diego County OES	Wildfire Preparedness	2022 version 06/2022	Wildfire Preparedness and Resiliency Workshop
San Diego Sheriff's Department	Wildfire Preparedness	2022 version 06/2022	Wildfire Preparedness and Resiliency Workshop
San Diego City Council, District 1	Wildfire Preparedness and Resiliency	04/2022	Wildfire Mitigation Program Emergency Operations Center Tour
San Diego City Council, District 3	Wildfire Preparedness and Resiliency	04/2022	Wildfire Mitigation Program Emergency Operations Center Tour
San Diego City Council, District 7	Wildfire Preparedness and Resiliency	05/2022	Wildfire Mitigation Program Emergency Operations Center Tour
San Diego City Council, District 6	Wildfire Preparedness and Resiliency	05/2022	Wildfire Mitigation Program Emergency Operations Center Tour
All local government, tribal, and public safety partners invited	Wildfire Preparedness and Resiliency	06/2022	Wildfire Preparedness / Resiliency Workshop
San Diego City Council, District 5	Wildfire Preparedness and Resiliency	08/2022	Wildfire Mitigation Program Emergency Operations Center Tour

Name of County, City, or Tribal Agency or Civil Society Group (e.g., nongovernment organization, fire safe council)	Program, Plan, or Document	Last Version of Collaboration	Level of Collaboration
San Diego City Council, District 2	Wildfire Preparedness and Resiliency	09/2022	Wildfire Mitigation Program Emergency Operations Center Tour
US Assembly, District 78	Wildfire Preparedness and Resiliency	10/2022	Wildfire Mitigation Program Emergency Operations Center Tour
US Congress, District 53	Wildfire Preparedness and Resiliency	10/2022	Wildfire Mitigation Program Emergency Operations Center Tour
San Diego County, District 4	Wildfire Preparedness and Resiliency	11/2022	Wildfire Mitigation Program Emergency Operations Center Tour
US Senator Dianne Feinstein Staff	Wildfire Preparedness and Resiliency	11/2022	Wildfire Mitigation Program Emergency Operations Center Tour
Mesa Grande	Wildfire Preparedness and Resiliency	Tribal Events – 10/2022	Listening session on priorities Overview of C222 SUG Drop off resiliency items and collateral
Santa Ysabel -	Wildfire Resiliency	Tribal Events - 06/2022	Council Meeting to provide C220 Briefing Earth Fair
Jamul Indian Village	Community Outreach	Tribal Events – 09/2022	SDG&E Emergency Response Initiative, Wildfire Mitigation and PSPS Listening session on priorities Drop off resiliency items and collateral Earth Fair Event
La Posta	Wildfire Preparedness	Tribal Events – 05/2022	Listening session on priorities and presentation by Martha Q. on low-income programs Earth Fair Event Backpacks Drop off
Pala	Wildfire Resiliency	Tribal Events – 09/2022	Meet and greet/listening session
Rincon	Community Outreach	Tribal Events – 12/2022	Meet and greet/listening session Tree Planting Event
San Pasqual	Wildfire Preparedness and Resiliency	Tribal Events – 03/2022	Meet and greet/listening session
Campo	Wildfire Preparedness and Resiliency	Tribal Events – 10/2022	Campo Earth Day

Name of County, City, or Tribal Agency or Civil Society Group (e.g., nongovernment organization, fire safe council)	Program, Plan, or Document	Last Version of Collaboration	Level of Collaboration
			Meet and Greet with Council Drop off resiliency items and collateral
Southern CA Tribes	Wildfire Preparedness	Tribal Events – 11/2022	Southern CA Tribal Emergency Managers Meeting ITLTRF Resiliency Breakfast and SDGE Workshop Focus Groups

4 OEIS Table 9-2: Frequently De-energized Circuits

Entry #	Circuit ID	Name of Circuit	Dates of Outages	Number of Customers Served by Circuit	Number of Customers Affected	Measure taken, or planned to be taken, to reduce the need for and impact of future PSPS of circuit	Number of Customers Mitigated (through 2022)	Future Customer Mitigations
1	1030	n/a	Jan 28-29, 2018 Nov 12-15, 2018 Oct 10-11, 2019 Oct 24-25, 2019 Oct 30-31, 2019 Sept 9, 2020 Dec 2-4, 2020 Dec 7-9, 2020 Dec 23-24, 2020	1303	1,258 649 30 185 1,341 30 1,182 1,363 30	Strategic Undergrounding: 43.52 miles completed to date; 13.7 miles in scope to be completed by 2025; 29.3 miles in scope to be completed by 2032 PSPS Sectionalizing: 7 SCADA reclosers available for sectionalizing Backup Resiliency Programs: 185 customers have participated to date; customers will be invited to participate in 2023	SUG: 513 Sectionalizing: 405-1003 BRP: 185	SUG: 159

Entry #	Circuit ID	Name of Circuit	Dates of Outages	Number of Customers Served by Circuit	Number of Customers Affected	Measure taken, or planned to be taken, to reduce the need for and impact of future PSPS of circuit	Number of Customers Mitigated (through 2022)	Future Customer Mitigations
2	1166	n/a	Nov 12-13, 2018 Oct 24-25, 2019 Oct 30, 2019 Dec 2-4, 2020 Dec 7-8, 2020 Dec 23-24, 2020 Nov 25-26, 2021	172	268 267 327 322 60 322 113	Strategic Undergrounding: Circuit will be considered for undergrounding in 2026 PSPS Sectionalizing: 3 SCADA reclosers available for sectionalizing Backup Resiliency Programs: 40 customers have participated to date; customers will be invited to participate in 2023	Sectionalizing: 60-78 BRP: 40	n/a
3	1215	n/a	Jan 28-29, 2018 Nov 11-14, 2018 Oct 24-26, 2019 Oct 30-31, 2019 Oct 27, 2020 Dec 2-4, 2020 Dec 7-8, 2020	144	146 135 136 136 133 144 133	Strategic Undergrounding: 20.8 miles in scope to be completed by 2025; 7.5 miles to be completed by 2032 PSPS Sectionalizing: 4 SCADA reclosers available for sectionalizing Backup Resiliency Programs: 36 customers have participated to date; customers will be invited to participate in 2023	Sectionalizing: 11-63 BRP: 36	SUG: 143
4	157	n/a	Nov 12-15, 2018 Oct 24-26, 2019 Oct 30-31, 2019 Dec 2-4, 2020 Dec 7-9, 2020 Dec 23-24, 2020 Nov 25-26, 2021	1023	1,015 653 652 1,028 614 660 708	Strategic Undergrounding: 10.8 miles in scope to be completed by 2031 PSPS Sectionalizing: 7 SCADA reclosers available for sectionalizing Backup Resiliency Programs: 118 customers have participated to date; customers will be invited to participate in 2023	Sectionalizing: 312-796 BRP: 118	SUG: 94

Entry #	Circuit ID	Name of Circuit	Dates of Outages	Number of Customers Served by Circuit	Number of Customers Affected	Measure taken, or planned to be taken, to reduce the need for and impact of future PSPS of circuit	Number of Customers Mitigated (through 2022)	Future Customer Mitigations
5	214	n/a	Jan 28-29, 2018 Oct 15, 2018 Nov 12-14, 2018 Oct 24-26, 2019* Oct 30-31, 2019 Dec 2-4, 2020* Dec 7-9, 2020* Dec 24, 2020* Nov 25, 2021	882	359 360 360 755 365 883 882 883 371	Strategic Undergrounding: 57.4 miles in scope to be completed by 2025 PSPS Sectionalizing: 7 SCADA reclosers available for sectionalizing Backup Resiliency Programs: 59 customers have participated to date; customers will be invited to participate in 2023	Sectionalizing: 487-846 BRP: 59	SUG: 706
6	215	n/a	Oct 25-26, 2019 Oct 30-31, 2019 Dec 3-4, 2020 Dec 7-8, 2020 Dec 24, 2020	519	495 495 510 385 385	Strategic Undergrounding: 25.2 miles in scope to be completed by 2032 PSPS Sectionalizing: 4 SCADA reclosers available for sectionalizing Backup Resiliency Programs: 83 customers have participated to date; customers will be invited to participate in 2023	Sectionalizing: 110-418 BRP: 83	SUG: 477
7	220	n/a	Jan 29, 2018 Nov 12-15, 2018 Oct 24-26, 2019 Oct 30-31, 2019 Dec 2-4, 2020 Dec 7-9, 2020 Dec 24, 2020	328	323 325 317 318 324 324 324	Strategic Undergrounding: 9.62 miles in scope to be completed by 2025; 61.8 miles in scope to be completed by 2032 PSPS Sectionalizing: 3 SCADA reclosers available for sectionalizing Backup Resiliency Programs: 22 customers have participated to date; customers will be invited to participate in 2023	Sectionalizing: 27-135 BRP: 22	SUG: 192

Entry #	Circuit ID	Name of Circuit	Dates of Outages	Number of Customers Served by Circuit	Number of Customers Affected	Measure taken, or planned to be taken, to reduce the need for and impact of future PSPS of circuit	Number of Customers Mitigated (through 2022)	Future Customer Mitigations
8	222	n/a	Jan 28-29, 2018 Nov 12-16, 2018 Oct 24-26, 2019 Oct 30-31, 2019 Dec 2-4, 2020 Dec 7-10, 2020 Dec 23-24, 2020	1459	386 1,275 1,321 1,320 1,355 1,302 402	Strategic Undergrounding: 2.14 miles completed to date; 137 miles in scope to be completed by 2026 PSPS Sectionalizing: 7 SCADA reclosers available for sectionalizing Backup Resiliency Programs: 566 customers have participated to date; customers will be invited to participate in 2023	SUG: 0 Sectionalizing: 430-1443 BRP: 566	SUG: 1300
10	358	n/a	Jan 27-29, 2018 Nov 11-14, 2018 Oct 24-25, 2019 Oct 30-31, 2019 Dec 2-4, 2020 Dec 7-8, 2020 Dec 23-24, 2020	1153	252 186 360 360 359 247 359	Strategic Undergrounding: 3.1 miles completed to date; 7.7 miles in scope to be completed by 2025; 14.2 miles in scope to completely underground C358 by 2032 PSPS Sectionalizing: 1 SCADA recloser available for sectionalizing Backup Resiliency Programs: 48 customers have participated to date; customers will be invited to participate in 2023	SUG: 28 Sectionalizing: 0-794 BRP: 48	SUG: 538
11	441	n/a	Jan 28-29, 2018 Nov 11-14, 2018 Oct 24-26, 2019 Oct 30-31, 2019 Oct 27, 2020 Dec 2-3, 2020 Dec 7-8, 2020	112	105 92 13 103 104 104 104	Strategic Undergrounding: 13.3 miles in scope to be completed by 2025; 22.4 miles in scope to be completed by 2032 PSPS Sectionalizing: 4 SCADA reclosers available for sectionalizing Backup Resiliency Programs: 16 customers have participated to date; customers will be invited to participate in 2023	Sectionalizing: 16-80 BRP: 16	SUG: 108

Entry #	Circuit ID	Name of Circuit	Dates of Outages	Number of Customers Served by Circuit	Number of Customers Affected	Measure taken, or planned to be taken, to reduce the need for and impact of future PSPS of circuit	Number of Customers Mitigated (through 2022)	Future Customer Mitigations
12	445	n/a	Jan 28-29, 2018 Nov 11-14, 2018 Oct 10-11, 2019 Oct 24-26, 2019 Oct 30-31, 2019 Oct 27, 2020 Dec 2-4, 2020 Dec 7-9, 2020 Nov 24-26, 2021	969	352 514 344 344 344 801 967 967 960	Strategic Undergrounding: 3.47 miles completed to date; 55.4 miles in scope to be completed by 2025; 19.5 miles in scope to be completed by 2032 PSPS Sectionalizing: 7 SCADA reclosers available for sectionalizing Backup Resiliency Programs: 101 customers have participated to date; customers will be invited to participate in 2023	SUG: 16 Sectionalizing: 103-911 BRP: 101	SUG: 692
13	75	N/A	Nov 12-14, 2018 Oct 24-25, 2019 Oct 30-31, 2019 Dec 2-4, 2020 Dec 7-9, 2020 Dec 23-24, 2020	611	16 17 17 752 16 16	Strategic Undergrounding: 12.55 miles completed to date; 0.1 miles in scope to be completed by 2025 (3 miles of underbuilt overhead to be removed from service) PSPS Sectionalizing: 2 SCADA reclosers available for sectionalizing Backup Resiliency Programs: 85 customers have participated to date; customers will be invited to participate in 2023	SUG: 91 Sectionalizing: 262-489 BRP: 85	n/a
14	78	n/a	Nov 12-14, 2018 Oct 24-25, 2019 Oct 30-31, 2019 Dec 2-4, 2020 Dec 7-8, 2020 Dec 24, 2020 Nov 25, 2021	120	266 269 270 276 121 276 155	Strategic Undergrounding: 17 miles in scope to be completed by 2032 PSPS Sectionalizing: 3 SCADA reclosers available for sectionalizing Backup Resiliency Programs: 24 customers have participated to date; customers will be invited to participate in 2023	Sectionalizing: 0-90 BRP: 24	SUG: 120

Entry #	Circuit ID	Name of Circuit	Dates of Outages	Number of Customers Served by Circuit	Number of Customers Affected	Measure taken, or planned to be taken, to reduce the need for and impact of future PSPS of circuit	Number of Customers Mitigated (through 2022)	Future Customer Mitigations
15	79	n/a	Jan 27-29, 2018 Oct 15-16, 2018 Oct 19-20, 2018 Nov 11-15, 2018 Oct 10-11, 2019 Oct 24-26, 2019 Oct 29-31, 2019 Nov 17-18, 2019 Sept 8-9, 2020 Dec 2-4, 2020 Dec 7-9, 2020 Dec 23-24, 2020 Nov 24-26, 2021	889	838 20 20 852 19 870 867 19 19 879 879 18 182	Strategic Undergrounding: 3.38 miles completed to date; 13.4 miles in scope to be completed by 2027 PSPS Sectionalizing: 10 SCADA reclosers available for sectionalizing Backup Resiliency Programs: 114 customers have participated to date; customers will be invited to participate in 2023	SUG: 11 Sectionalizing: 197-800 BRP: 114	SUG: 123
16	909	n/a	Nov 12-13, 2018 Oct 30-31, 2019 Dec 2-4, 2020 Dec 7-8, 2020 Dec 23-24, 2020	423	495 496 494 362 494	Strategic Undergrounding: 35 miles in scope to completely underground C909 by 2026 PSPS Sectionalizing: 2 SCADA reclosers available for sectionalizing Backup Resiliency Programs: 43 customers have participated to date; customers will be invited to participate in 2023	Sectionalizing: 0-117 BRP: 43	SUG: 423

Appendix G: AFN Plan



APPENDIX G: AFN PLAN

2023 Wildfire Mitigation Plan



**San Diego Gas & Electric Company's 2023
Plan to Support Populations with Access and
Functional Needs During Public Safety Power
Shutoffs**

January 31, 2023



TABLE OF CONTENTS

Executive Summary	1
1 Introduction	3
1.1 Subject Matter Experts (Engage the Whole Community)	3
1.2 Purpose, Scope, Situation Overview, and Assumptions	4
1.2.1 Purpose/Background - WHY	4
1.2.2 Scope – WHO	5
1.2.3 Situational Overview	6
1.2.4 Planning Assumptions	8
1.3 Operational Priorities - WHAT	9
1.4 Plan Development	9
1.5 Plan Preparation and Review	10
1.6 Plan Implementation	10
1.7 Research and Surveys	11
1.8 Success Measures and Metrics	11
2 Concept of Operations HOW	12
2.1 Preparedness/ Readiness (Before Power Shutoff)	12
2.1.1 Emergency Operations Center	12
2.1.2 AFN Identification Outreach	14
2.1.3 AFN Support Resources	14
2.1.4 Back-Up Power	20
2.1.5 Customer Assistance Programs	22
2.1.6 PSPS Preparedness Outreach and Community Engagement	23
2.1.7 Key Outreach Segments	27
2.1.8 Advisory Councils	28
2.2 PSPS Activation (During – Emergency Operation Center Activated)	30
2.2.1 PSPS Communications	30
2.2.2 Community Resource Centers (CRCs)	33
2.3 Recovery (After – Power has been restored)	34
2.3.1 AFN Support	34
3 Information Collection, Analysis, and Dissemination	34
3.1 Customer Privacy	34
4 Authorities and References	35

4.1	Annual Report and Emergency Response Plan in Compliance with General Order 166	35
4.2	Phase 3 OIR PSPS Guidelines: AFN Plan & Quarterly Updates	35

LIST OF TABLES

Table 1: Resource Planning and Partnerships.....	17
Table 2: AFN Resources.....	20
Table 3: 2022 Battery and Generator Rebate Program	21

LIST OF FIGURES

Figure 1: Engaging the Whole Community	3
Figure 2: Joint IOU Access & Functional Needs Individuals*	7
Figure 3: Service Area Map of Customers with AFN.....	8
Figure 4: SDG&E PSPS Timeline Example.....	12
Figure 5: Example of Marketing Collateral	15

LIST OF APPENDICES

- Appendix A: Core Planning Team Participants
- Appendix B: Collaborative Council Participants
- Appendix C: AFN Q4 2022 YTD Recap
- Appendix D: Census Tract Data for Generator & Back-up Battery Programs
- Appendix E: Survey Results and Metrics

Executive Summary

During extreme weather conditions, utilities may temporarily turn off power to specific areas to protect the safety of our customers and communities, enacting a Public Safety Power Shutoff (PSPS), which continues to be a necessary tool of last resort to mitigate the risk of wildfires. To support individuals with Access and Functional Needs (AFN) during a PSPS, each of the Joint Investor-Owned Utilities (IOUs)¹ developed its respective 2023 Annual AFN PSPS Plan (“AFN Plan” or “Plan”) with assistance from regional and statewide AFN stakeholders representing a broad spectrum of expertise. In 2023, that Plan leverages Federal Emergency Management Administration’s (FEMA) Developing and Maintaining Emergency Operations Plans Comprehensive Preparedness Guide (CPG) 101 6 Step Process².

The IOUs have established a partnership and will continue to work closely with the AFN Collaborative Council³ and the AFN Core Planning Team⁴ to seek guidance and address the “Why,” “Who,” “What,” and “How” to support individuals with AFN before, during and after a PSPS to mitigate risk. The IOUs are committed to addressing the needs of individuals with AFN before, during, and after a PSPS.

The IOUs acknowledge and give sincere thanks to the AFN Collaborative Council and AFN Core Planning Team for their guidance and commitment in developing the 2023 AFN plan.

WHY

As climate conditions change, wildfires have become a year-round threat. When wildfire conditions present a safety risk to our customers and communities, electric utilities may call for a PSPS as a measure of last resort.

A PSPS, although necessary, disrupts the everyday lives of impacted individuals, including those with AFN and/or may be electricity dependent, which will be discussed further in this report. The purpose of this Plan is to mitigate the impact of PSPS on individuals with AFN.

WHO

The Joint IOU Statewide AFN Advisory Council⁵ and AFN Core Planning Team developed a definition of Electricity Dependent individuals that this Plan seeks to support. That definition remains unchanged from 2022.

Electricity Dependent Definition: Individuals who are at an increased risk of harm to their health, safety and independence during a Public Safety Power Shutoff for reasons including, but not limited to:

- Medical and Non-Medical
- Behavioral, Mental and Emotional Health
- Mobility and Movement
- Communication

The IOUs have made progress in identifying individuals with AFN across their respective service areas, collectively

¹ San Diego Gas & Electric (SDG&E), Southern California Edison (SCE), and Pacific Gas & Electric Company (PG&E).

² For details on how to develop and maintain Emergency Operations Plans, visit: [Developing and Maintaining Emergency Operations Plans Comprehensive Preparedness Guide \(fema.gov\)](#)

³ See Appendix B for members of the AFN Collaborative Council.

⁴ See Appendix A for members of the AFN Core Planning Team.

identifying approximately 3.8 million⁵ people across the state through program enrollments and enabling self-identification.

The IOUs understand that there is more work to be done and will continue these efforts to identify these individuals in 2023.

WHAT & HOW

Working alongside the AFN Collaborative Council and AFN Core Planning Team, the IOUs worked to identify the goals, objectives, and potential opportunities for enhancements in 2023, outlined in this Plan.

The overarching goal is to mitigate impacts of PSPS on individuals with AFN served by the IOUs through improved customer outreach, education, assistance programs and services.

⁵ Represents total counts of AFN designations in each IOU's database, not unique individuals or accounts.

1 Introduction

In accordance with the California Public Utilities Commission (Commission or CPUC) Decision (D.) 21-06-034 Phase 3 OIR Decision Guidelines and leveraging Federal Emergency Management Administration’s Developing and Maintaining Emergency Operations Plans Comprehensive Preparedness Guide 101 6 Step Process, the Joint IOUs worked collaboratively with the AFN Core Planning Team to implement the “Whole Community” approach to develop an overarching Joint IOU Statewide strategy to meet the diverse needs of individuals with AFN.

The IOUs’ respective comprehensive plans will reflect the geographical differences as well as the various needs of communities with AFN. The IOUs will provide the CPUC with quarterly updates regarding progress towards meeting the established objectives and the impact of their efforts to address this population before, during and after PSPS, while optimizing opportunities for consistency statewide.

1.1 Subject Matter Experts (Engage the Whole Community)

According to FEMA Step 1: Engaging the Whole Community in the Planning. Engaging in community-based planning—planning that is for the whole community and involves the whole community—is crucial to the success of any plan.

On September 14, 2022, the IOUs introduced this effort at the broader Q3 Joint IOU Statewide AFN Advisory Council meeting, invited participation, and subsequently held a kick-off meeting with Core Planning Team⁸ members on October 14, 2022. The 2023 AFN Core Planning Team is comprised of 13 organizations representing the diverse needs of the AFN community. Figure 1 below reflects the organizations who participated in the development of the 2023 AFN Plan.

Figure 1: Engaging the Whole Community

Planning Group	Participants/Stakeholders
AFN Collaborative Council (per the Phase 3 OIR PSPS Decision):	California Foundation for Independent Living Centers (CFILC)
	California Health & Human Services (CHHS)
	California Office of Emergency Services (Cal OES)
	Disability Rights California (DRC)
	Disability Rights Education & Defense Fund (DREDF)
	State Council on Developmental Disabilities (SCDD)
AFN Core Planning Team	American Red Cross
	Bear Valley Electric Service, Inc.
	California Department of Developmental Services (CDDS)
	California Foundation for Independent Living Centers (CFILC)
	Center for Accessible Technology (C4AT)
	Deaf Link, Inc.

Planning Group	Participants/Stakeholders
	Disability Action Center (DAC)
	Disability Policy Consultant
	Interface Children & Family Services 211
	Liberty Utilities
	North Los Angeles Regional Center (NLACRC)
	Redwood Coast Regional Center (RCRC)
	San Diego Regional Center (SDRC)
Joint IOUs	San Diego Gas & Electric
	Southern California Edison (SCE)
	Pacific Gas & Electric (PG&E)

As a key component to engaging the Whole Community in planning, the IOUs will continue to solicit feedback from the AFN Collaborative Council, the Joint IOU Statewide AFN Advisory Council, each utility’s respective Regional PSPS Working Groups⁹ and other regional and statewide AFN experts such as Community-Based Organizations, healthcare partners, and durable medical equipment providers.

These groups serve as a sounding board and offer insight, feedback, and input on the IOUs’ customer strategy, programs, and priorities. Regular meetings are scheduled to actively identify issues, opportunities and challenges related to the IOUs’ ability to mitigate the impacts of wildfire safety strategies, namely PSPS.

Outcomes from the planning process are outlined here and details are included in the specific IOU plans. Some of these topics include developing a “one-stop shop” statewide website, conducting outreach and education, expanding program eligibility and exploring accessible transportation.

1.2 Purpose, Scope, Situation Overview, and Assumptions

1.2.1 Purpose/Background - WHY

The Plan focuses on mitigating the impacts of PSPS for individuals with AFN. The IOUs intend to build on this Plan and strive for continuous improvement based on insights from the experts and feedback channels outlined in this plan.

Each IOU’s respective 2023 AFN Plan addresses the following:

- Who the IOUs need to communicate with
- What resources and services are needed during PSPS
- How the IOUs communicate with individuals with AFN
- How the IOUs make resources and service available to individuals with AFN

1.2.2 Scope – WHO

The Joint IOUs and the CPUC recognize the definition of AFN as defined by the California Government Code §8593.3: “individuals who have developmental disabilities, physical disabilities, chronic conditions, injuries, limited English proficiencies, who are non-English speakers, older adults, children, people living in institutional settings, or those who are low income, homeless, or transportation disadvantaged, including but not limited to, those who are dependent on public transit and those who are pregnant.”⁶

Acknowledging that the California Government code definition of AFN is broad, the CPUC authorized the IOUs to follow the FEMA 6 Step Process by engaging the Whole Community through the Joint IOU Statewide AFN Advisory Council to create a common definition of “Electricity Dependent.”

Therefore, the IOUs use this common definition to help inform new enhancements to programs and resources that are currently available.

Electricity Dependent: Individuals who are at an increased risk of harm to their health, safety and independence during a Public Safety Power Shutoff, for reasons including, but not limited to:

- Medical and Non-Medical
- Behavioral, Mental and Emotional Health
- Mobility and Movement
- Communication

Examples of Electricity Dependent include, but are not limited to:

- **Medical and Non-Medical:**
 - Respiratory equipment: oxygen, respirator, inhalation therapy, apnea monitoring, suction, machines, airway clearance, airway clearances, vests, cough assistive devices, hemodialysis
 - Nutritional equipment: gastric feed tube, specialized diet meal preparation equipment (e.g., feeding pumps, blenders)
 - Heating/cooling equipment: refrigeration, body temperature regulation
- **Behavioral, Mental, and Emotional Health:**
 - Powered equipment supporting regulation of emotional behaviors (e.g., sensory lights)
- **Mobility and Movement:**
 - Positioning equipment: Lift, mobility tracking system, power wheelchairs, in home chair lift, electric beds
- **Communication:**

⁶ D. 19-05-042.

- Augmentative communication devices (e.g., tablets, wearables, eye gaze), alert systems
- Powered equipment for hearing or vision support

1.2.3 Situational Overview

According to FEMA Step 2: Understand the Situation. Understanding the consequences of a potential incident requires gathering information about the potential AFN of residents within the community.

“Understand the Situation” continues with identifying risks and hazards. This assessment helps a planning team decide what hazards or threats merit special attention, what actions must be planned for, and what resources are likely to be needed.

The Core Planning Team in 2022 identified a key risk of PSPS that continues in 2023:

- Individuals with AFN are unable to use power for devices or equipment for health, safety and independence due to a PSPS.

During the planning process, the AFN Core Planning Team emphasized that the needs of individuals with AFN extend well beyond medical devices alone and that the risks are as diverse as the population. The IOUs recognize that the impacts of PSPS are dynamic and are committed to supporting customers before, during and after a PSPS.

1.2.3.1 AFN Population and Identification

The IOUs have made progress in identifying the Electricity Dependent individuals with AFN through program enrollments and enabling self-identification. Each IOU identifies the following customers in their respective databases as AFN:

- Customers enrolled in the following programs:
 - California Alternate Rates for Energy (CARE)
 - Family Electric Rate Assistance (FERA)
 - Medical Baseline (MBL)⁷, including Life-Support (Critical Care)
- Customers with disabilities
- Customers who receive their utility bill in an alternate format (e.g., Braille, large print)
- Customers who prefer communications in a language other than English
- Older adults
- Customers who self-certify or self-identify

Figure 2 below accounts for the number of customers identified as AFN in each utility service area, as well as those mostly likely to experience a PSPS.

⁷ Per D. 21-06-034, identification efforts include also “persons reliant on electricity to maintain necessary life functions including for durable medical equipment as assistive technology”. Id at pp. A8- A9.

Figure 2: Joint IOU Access & Functional Needs Individuals*

Joint IOU	MBL Individuals	Customers with Language Preference	Individuals Identified as AFN	Percentage of Individuals Identified as AFN based of Total Residential Customer Base**
PG&E	Total: ~273,000	Total: ~382,900	Total: ~1.7M	30%
	PSPS-Likely: ~71,200	PSPS-Likely: ~17,300	PSPS-Likely: ~311,300	27%
SDG&E	Total: ~71,000	Total: ~67,000	Total: ~423,000	33%
	PSPS-Likely: ~13,000	PSPS-Likely: ~5,000	PSPS-Likely: ~44,000	25%
SCE	Total: ~116,000	Total: ~680,000	Total: ~1.7M	37%
	PSPS-Likely: ~40,000	PSPS-Likely: ~100,000	PSPS-Likely: ~300,000	29%

* Data pulled in November 2022. “PSPS-Likely” refers to customers who are most likely to experience a PSPS given their geographic location in the HFTD

** Percentages are approximate.

In 2022, the utilities developed an AFN density map which allows them to quickly identify geographical areas that have larger populations of AFN individuals. These maps enable the utilities to strategically allocate resources by geography such as staffing a support site or Customer Resource Center for individuals who are experiencing a PSPS. See Figure 3.

Figure 3: Service Area Map of Customers with AFN

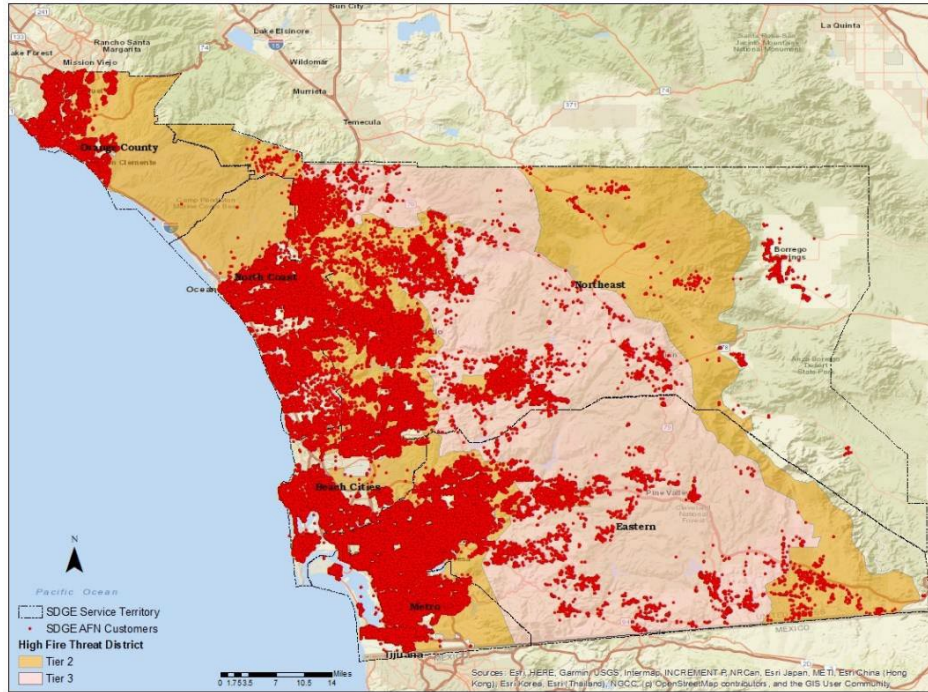

This map displays SDG&E customers with Access and Functional Needs who reside in the service territory.

In 2023, the IOUs will continue identifying Electricity Dependent individuals above and beyond those enrolled in the Medical Baseline Allowance Program, through direct outreach to customers in each respective IOUs service area.

1.2.4 Planning Assumptions

- The Joint IOUs strive for all notifications to be provided in advance of a PSPS
- Resources are available for individuals with AFN regardless of notification
- Effective support of individuals with AFN requires a Whole Community⁸ approach (e.g., utilities, CBOs, non-profits organizations, government agencies)
- PSPS may occur concurrently with unrelated emergencies (e.g., active wildfires, cyber-attacks, technological hazard incidents)
- The IOUs will continue working to create as consistent statewide response with our support services (e.g., food support, accessible transportation, Community Resource Centers, etc.) to PSPS as possible, acknowledging that there are different needs based on geographic areas
- The scope of PSPS can increase or decrease as weather conditions are monitored across the service area

⁸ The term “Whole Community” refers to the FEMA six step emergency planning process

1.3 Operational Priorities - WHAT

According to FEMA Step 3: Operational priorities – specifying what the responding organizations are to accomplish to achieve a desired end-state for the operation.

The goal of the AFN Plan is to mitigate the impacts of PSPS on individuals with AFN served by the IOUs through improved customer outreach, education, assistance programs and services.

Continued Key Objectives from 2022:

- Continue to identify individuals who are Electricity Dependent
- Implement a communication plan that reaches all AFN segments
- Continuously improve tools to make them easy to understand and navigate for individuals and external organizations to access information
- Identify new enhancements to programs and resources needed to mitigate the impacts of PSPS
- Cultivate new partnerships and expand existing partnerships with the Whole Community
- Coordinate and integrate resources with state, community, utility to minimize duplication
- Establish measurable metrics and consistent service levels
- Effectively serve and adapt to the needs of individuals with AFN before, during, and after any PSPS

Additional Key Objectives identified for 2023:

- Provide overall preparedness resources for individuals with AFN regardless of emergency type
- Increase awareness of IOU programs and services available before, during and after a PSPS
- Implement tracking and metrics for escalations, programs and services offered and utilized by conducting surveys, tabletop exercises, etc.
- Ensure customers with sensory disabilities⁹ are able to provide feedback, understand and successfully operate provided equipment

1.4 Plan Development

According to FEMA: Step 4: Plan Development Develop and Analyze Courses of Action – This step is a process of generating, comparing, and selecting possible solutions for achieving the goals and objectives identified in Step 3.

The IOUs have worked to deliver consistent services and resource offerings; however, the delivery and eligibility will likely be different by service area.

Goals recommended to meet the Key Objectives for 2023:

⁹ Individuals with hearing and/or vision disabilities

Communications/Offerings

- Enhance American Sign Language (ASL) offerings in Community Resource Centers (CRC) by exploring services to aid individuals who may be deaf or deaf/blind
- Continue communications regarding differences between wildfire safety and other outage types (i.e., Enhanced Powerline Safety Setting vs. PSPS) and respective assistance offerings (i.e., discounted vs. no-cost hotel lodging)

Resources

- Partner to identify additional options outside of paratransit agencies to aid in improved response times and other potential customer limitations
- Continue to gather information surrounding Community-Based Organizations (CBOs) resiliency offerings/community needs and ensure that partnerships are not taxing on CBOs due to resource constraints
- Continue to identify opportunities to enhance current resource allotments to programs supporting individuals with AFN

Metrics¹⁰

- Increase tracking of customer journey and escalations during PSPS event through different channels (i.e., CRCs, Disability Disaster Access and Resources (DDAR))
- Provide clarity on status of planning process by including key targets and year-to-date performance against them

AFN Self-Identification

- Pursue identification of additional individuals who may identify as AFN and make improvements to offerings to meet their needs

1.5 Plan Preparation and Review

According to FEMA Step 5: Plan Preparation, Review, and Approval – This step is a process of preparing the document and getting it ready for implementation.

Prior to finalizing the 2023 AFN Plans, the Joint IOUs provided members of the AFN Collaborative Council and AFN Core Planning Team a draft plan for their review. As a result, each of the IOUs will file their respective 2023 AFN Plans with the CPUC by January 31, detailing its programs to support individuals and communities with AFN before, during and after PSPS.

1.6 Plan Implementation

According to FEMA Step 6: Implement and Maintain the Plan – This step is the final step which is an ongoing process of training personnel to perform tasks identified in the plan, exercising, and evaluating plan effectiveness, and revising and maintaining the plan.

¹⁰ Additional information to be found in IOU AFN Quarterly Progress Reports.

Upon filing the AFN plan, each IOUs will implement new and maintain existing goals and objectives as specified in their respective Plan. Additionally, the IOUs will provide quarterly updates on progress made and report on performance through identified success measures and metrics.

1.7 Research and Surveys

In 2023, the IOUs will continue to collaborate and share best practices as they solicit feedback about PSPS resources offered to individuals with AFN through a variety of channels, including consultation with various advisory councils.

The IOUs will continue conducting listening sessions¹¹ and working groups with local governments, tribes, and critical facilities; webinars for customers and communities; wildfire and PSPS awareness studies; feedback via digital channels; PSPS Tabletop Exercises; and notification message testing.

As a result of feedback and research from CBOs, local governments and tribes who support AFN populations, the IOUs are committed to continuously reviewing the needs of individuals with AFN before, during and after PSPS to enhance support for those individuals who rely on electricity to maintain necessary life functions, including for durable medical equipment and assistive technology.

1.8 Success Measures and Metrics

In 2023, the Joint IOUs will continue to use the Key Performance Indicators (KPIs) that were developed with the AFN Core Planning Team for the 2022 AFN Plan.

These KPIs seek to measure the impacts of PSPS on individuals with AFN, awareness of support programs, and satisfaction of services offered.

Key Performance Indicators:

1. The percentage of individuals with AFN who were aware of what support and resources were available to them during a PSPS
2. The percentage of individuals with AFN who were able to use necessary medical equipment to maintain necessary life functions for the duration of any PSPS that affected them
3. The percentage of individuals who utilized mitigation services who reported they were satisfied with the level of support

While Section 1 is a high-level overview of the IOUs' shared vision, the details for each of the IOUs AFN Plans can be found in Sections 2-4. The 2022 pre- and post- season survey results can be found in the Appendix of this report.¹² The IOUs will continue benchmarking to create a consistent response across the IOU service areas where possible, recognizing that resources may not be available consistently across the state.

SAN DIEGO GAS & ELECTRIC | 2023 AFN PLAN

¹¹ Refer to Section 1.6.5 which discusses AFN working group

¹² SDG&E did not conduct a post-season survey in 2022 since it did not have any PSPS event.

2 Concept of Operations | HOW

In a PSPS, forecasts are subject to change quickly and preparation timelines must adjust quickly as well.

This Concept of Operations is separated into preparedness, before, during and after phase to account for the unique operational requirements over the course of PSPS. Figure 4 shows a general example sequence for a potential PSPS.

Figure 4: SDG&E PPS Timeline Example

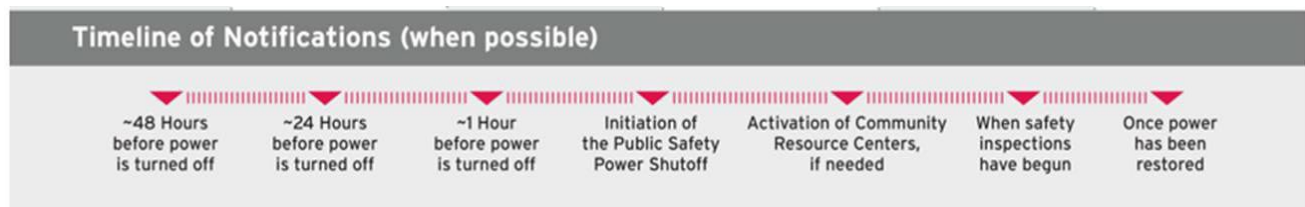

2.1 Preparedness/ Readiness (Before Power Shutoff)

2.1.1 Emergency Operations Center

Leading up to the PPS season, SDG&E Emergency Management meets with public safety partners to determine the best method of

communication and providing situational awareness during Emergency Operation Center (EOC) activations. Public safety partners are proactively informed through different forms of communication throughout the year. In 2021, impacted public safety partners were directed to the new SDG&E Public Safety Partner Portal to receive the latest situational updates. In 2022, a mobile application was added to enhance the Public Safety Partner Portal to ensure partners have the information at their disposal on their mobile devices. Impacted critical facility and infrastructure customers would have been communicated to directly by their SDG&E account executive via phone and/or email communication. These impacted critical facility and infrastructure customers would have been provided a list of their potentially impacted meters and situational updates. However, SDG&E did not have any PPS events in 2022.

Preparation Exercises & Training

SDG&E's Emergency Response team conducts extensive preparation and training in collaboration with the AFN team to prepare for PPS and supporting individuals with AFN. These include:

- Two annual PPS exercises, one tabletop & one operations-based, both of which addressed AFN concerns during a PPS with external partner participation
- Additional exercises throughout the year on various all hazards topics that addressed and included AFN concerns and response expectations
- New responders onboarded in New EOC Member Orientation course
- New responder onboarded with required participation in NIMS, SEMS, and ICS training through FEMA course 100, FEMA course 200, FEMA course 700, and California's SEMS course

- Targeted participation in SDG&E's Command and General position credentialing training, including specific responder completion of CSTI courses G-775 and G-191
- EOC responder participation in Summer Readiness Training which provided training to all responders on PSPS expectations and protocols, load curtailment expectations and protocols, general hazards EOC expectations and protocols, and seasonal weather forecasts.
- Outreach and engagement with Public Safety Partners, Community Partners and local jurisdictions, including tribes
- EOC tours for external stakeholders
- Joint planning with County OES, CalOES, CAL FIRE, emergency managers and Regional Fire Chiefs
- AFN Liaison Officer training on the process and protocols for communication and AFN CBO services
- Training on IOU programs and services to in-home workers, social service staff, CBOs, tribal orgs, CERTS etc.

EOC AFN Liaison Role

In 2022, the AFN Liaison Officer roster grew to 14 responders with a series of trainings to prepare each member of the roster to staff the AFN Liaison role in the EOC.

Specifically dedicated to supporting AFN customers during EOC activations, the AFN Liaison Officer reports directly to and advises the Officer-in-Charge (OIC) on the needs and activities in support of customers with an access or functional need.

The AFN Liaison Officer collaborates with SDG&E's AFN support partners, including 211, FACT, Salvation Army, and other CBOs, to prepare customers for a potential power outage and provide up-to-date information on PSPS operations and address the power outage related needs of customers reaching out for assistance.

Training for this position was expanded in 2022 and will continue in 2023 with a series of exercises that will continue to build the knowledge and skills needed to effectively serve customers with an AFN during an EOC activation. In addition to the general EOC training and exercises required by SDG&E's Emergency Management, position specific training on the processes and resources utilized during an EOC activation to support AFN customers were required. This additional AFN Liaison Officer training include:

- The role of an AFN Liaison Officer
- Accessible Hazard Alert System (AHAS) notification procedure
- AFN communication process and standards to AFN support and general partners
- Disability awareness and sensitivity
- Available internal and external resources

Training and exercises for both EOC operations and specific AFN Liaison Officers role has prepared this

team to effectively manage EOC procedures and community support resources to the benefit of AFN customers.

Customer Care Support

SDG&E continues to support individuals and households with AFN, including during PSPS. When customers call or visit our branch office to speak with an agent regarding AFN specific concerns, they will be directed to the appropriate resource to receive support (e.g., 211, Customer Assistance AFN EOC role,

etc.). Additionally, SDG&E's Customer Care Center representatives are trained to speak with customers experiencing challenges and if it is the customers' preference, flag them in SDG&E's system as having a self-identified disability for additional consideration of tools, programs, and services.

2.1.2 AFN Identification Outreach

SDG&E recognizes the importance of continuing to identify AFN individuals. As a result, SDG&E is committed to providing the education, resources and notifications required to maximize resiliency during PSPS. Building on Section 1.2.2 above, SDG&E has been enhancing its ability to identify individuals with AFN. There are approximately 423,000 customer accounts associated with AFN, which accounts for 33% of the residential customer class. Of the 423,000, approximately 44,000 customers reside in the HFTD.

In 2022, SDG&E began a Self-Identification campaign which allowed customers to identify if an individual in the residence is living with one or more of the following disabilities: blind/low vision, deaf/hard of hearing, disabled (cognitive, physical, developmental), or over the age of 62 years old. This campaign included direct mail and an email linking to a digital web form. SDG&E worked with the AFN Collaborative Team and stakeholders to review and align the AFN language and online content to be more inclusive, accessible and will include in language option to the online self-identification form.

Campaigns will continue in 2023 to identify electricity dependent individuals, above and beyond those enrolled in the Medical Baseline Program, through direct outreach to customers. This includes continuing to promote on social media, utilizing CBO outreach channels with the Regional PSPS Working Group and Energy Solutions Partners network. SDG&E has included the self-identification web form prominently on the AFN landing page (sdge.com/afn) to enable continued self-identification.

SDG&E will continue to partner and work with the AFN Collaborative Team to identify opportunities to enhance AFN identification.

2.1.3 AFN Support Resources

In support and preparedness of individuals who identify as AFN, SDG&E will continue to provide a comprehensive approach of programs and resources before, during and after PSPS. SDG&E is committed to seeking new opportunities to identify organizations with quick response capacity that can meet the needs of customers across the region during PSPS activations.

SDG&E will continue expanded food resource options with the San Diego Food Bank (a Community Information Exchange partner of 211 San Diego) and resiliency solutions for those impacted in the HFTD during PSPS. SDG&E will continue to leverage marketing and outreach campaigns to increase awareness

of available support solutions to individuals with AFN via web and social media.

Please see Figure 5 below of an example of marketing collateral.

Figure 5: Example of Marketing Collateral

**OUR COMMITMENT
TO SUPPORTING
ACCESSIBILITY**

SDG&E is committed to supporting all of our customers and making sure that everyone is offered equal access to information, resources and services.

We have partnered with 211 San Diego and 211 Orange County to offer helpful community resources during a Public Safety Power Shutoff (PSPS). 211 is free, confidential and available to take your call 24 hours a day, 7 days a week, in over 200 languages.

Dial 211 for help.

Orange County: 2-1-1 or 888-600-4357
San Diego County: 2-1-1 or 858-300-1211

SDGE **211** **2-1-1**
SAN DIEGO ORANGE COUNTY

211 – Centralized Resource Hub

SDG&E continues its partnership with 211 San Diego and 211 Orange County into 2023 and has continued to expand and enhance as gaps and new opportunities are identified. In addition to enhanced identification of Customer with AFN, assessment of AFN population needs, hotel stays, accessible transportation, food resources and resiliency items.

211 serves as a resource hub to connect individuals with services directly provided by partners contracted with SDG&E, as well as more than 1,000 regional CBOs who provide services. 211 provides several unique advantages in that it is available statewide 24/7 and connects individuals with local partners who have “on the ground experience” across the disability and broader AFN community.

Additionally, 211 has the ability to conduct Needs Assessments through its trained social workers and escalate needs accordingly to higher tiers of support.

In advance of PSPS, 211 will focus on outreach to at-risk customers, including

those living in each IOU’s high-fire-risk areas who are eligible for income-qualified assistance programs and rely on life-sustaining medical equipment. The focus during these periods will be to evaluate these customers’ resiliency plans, connect them with existing programs that can help them prepare for outages and to assist them in completing applications for these programs including exploring Care Coordination screening outreach efforts conducted by 211.

Accessible Transportation

SDG&E will continue its partnership with Facilitating Access to Coordinated Transportation (FACT) in 2023, which provides accessible transportation to individuals with AFN across the entire HFTD during PSPS. There are no eligibility criteria other than an individual seeking assistance. FACT is available 7 days a week from 5:30am-11pm during PSPS and has been able to facilitate all requests for transportation that have come in to 211 and SDG&E since the initiation of the partnership in 2020. In 2022, SDG&E plans to enhance marketing of this solution through targeted campaigns to individuals with AFN, broader marketing efforts as well as training and materials for CBOs.

SDG&E has partnered with FACT to develop a communication protocol during PSPS events for their paratransit agencies in the SDG&E service territory. FACT receives Emergency Operating Center (EOC) PSPS daily notifications and amplifies the information, including zip codes, to approximately ~160 paratransit service providers. SDG&E 2023 plans include identifying and partnering with agencies that are not in the FACT broker network. See 2.1.6 AFN Outreach section for additional details.

In 2023, building on its outreach and support to building managers in the HFTD, SDG&E will continue to partner with the AFN Statewide Council Partner and emergency management services on solutions for the egress from buildings with elevators.

No-Cost Hotel Stays

SDG&E will continue its partnership with The Salvation Army in 2023, which provides no-cost hotel stays to individuals with AFN during PSPS. This is also available to individuals who would not normally be considered AFN, but due to the circumstances (long duration, cold weather, living alone, etc.) request assistance. Hotel stays are arranged via The Salvation Army and 211, and do not require any payment up front or otherwise from individuals. Hotels are selected based on accessibility and proximity to customers' residence or other requested location. The Salvation Army has been able to facilitate all requests received since the initiation of the partnership in 2020. In 2023, SDG&E will continue to enhance the marketing of this solution through targeted campaigns to individuals with AFN, broader marketing efforts as well as trainings and materials for CBOs.

Additionally, SDG&E will work with The Salvation Army to explore enhanced screening for specific needs for individuals with AFN (e.g., accessibility, refrigeration).

Food Support

SDG&E has strengthened the pipeline of local food resources for seniors, individuals, and families with AFN by partnering with the San Diego Food Bank, Feeding America, Meals on Wheels and other local food partners. These valued partnerships enable the support of vulnerable, rural, and tribal communities year-round and during PSPS activations. Food support is available at many locations, including on tribal lands. Expanded San Diego Food Bank mobile food pantries ensure additional food support offerings during PSPS. As demonstrated by their support in 2021, this resource has proven to be a valuable asset and as such will continue to play an important role in supporting some of our most vulnerable customers.

Supplemental to the above referenced partnerships SDG&E will continue to offer hot meals at Community Resource Centers when needed.

Wellness Checks

In 2022, SDG&E expanded its PSPS support services by partnering with service programs to perform in-home wellness checks when requests are made through 211 during a PSPS. Additional support services can be provided through 211 as needed. These partnerships will continue into 2023.

- East County Community Emergency Response Team (CERT) Educates people about disaster preparedness for hazards that may impact their area. Provides training in basic disaster response.
- San Diego County Volunteer Sheriff Patrol: You Are Not Alone (YANA) program. A senior volunteer program designed to support seniors, people with disabilities or anyone who is otherwise homebound through weekly visits or by requests.

Resiliency Items

SDG&E will continue to distribute resiliency items at Community Resource Centers during a Public Safety Power Shutoff. These items may include portable solar cell phone charger, gift cards, solar power banks, cooler bags, 2.5-gallon water bags, bottled water, water for livestock and seasonal blankets. In 2022 SDG&E added medical device charging and in 2023, SDG&E plans to provide medical cooler bags at CRC's and to CBO's for distribution to constituents as part of their emergency preparedness efforts. Additional opportunities will be explored to provide targeted resiliency items to those most at risk of a PSPS.

SDG&E, along with the other IOUs, has workshops scheduled with the AFN Collaborative team to further identify opportunities to enhance support.

Additionally, the IOUs plan to explore a risk-based tiering of support for individuals with AFN. The utilities will continue to work with the Statewide Collaborative team to identify and operationalize appropriate tiers.

Table 1: Resource Planning and Partnerships

CBO	Counties Served	Resources
211 Partnerships	San Diego County Orange County	<ul style="list-style-type: none"> • 24/7 connection to regional support services (hotel accommodations, accessible transportation, food support, etc.) • Proactive identification of AFN residents & preparedness coordination/pre-event outreach
DeafLink	San Diego County Orange County	<ul style="list-style-type: none"> • Accessibility solution providing a link with all PSPS messaging to customers to a video of an ASL interpreter signing the message including closed captions and voice reading of the message via Accessible Hazard Alert System (AHAS) • Two ASL service agreements for translation for

CBO	Counties Served	Resources
		<p>external video calls, press conferences and other community events as requested</p> <ul style="list-style-type: none"> Secured Service Agreement to provide any SDG&E employee access to Video Remote Interpreting (VRI) via smart phone for ASL
<p>Food Bank Partnerships:</p> <ul style="list-style-type: none"> San Diego Food Bank North County Food Bank Feeding America Meals on Wheels Craft Catering Eurest Terra San Diego Bistro 	<p>San Diego County</p>	<p>San Diego Food Bank/North County Food Bank</p> <ul style="list-style-type: none"> Expanded food bank partnership to support rural/tribal/HFTD communities 5 mobile food pantries Support the services during emergencies and will standup mobile food pantries post PSPS in impacted communities Food support cards may be available for individuals and households with AFN as needed Support funding from shareholder/community relations Meals on Wheels <ul style="list-style-type: none"> Additional meal to impacted PSPS seniors per day of shutoff Support funding from shareholder/community relations <p>Feeding America</p> <ul style="list-style-type: none"> Support services during emergencies; will stand-up mobile food pantries post- PSPS in impacted communities 17 mobile food pantries Partnership with Indian Health Council Support funding from shareholder/community relations Warm Food Support Craft Catering, Eurest and Terra San Diego Bistro catering service contracted to support at local CRCs

CBO	Counties Served	Resources
		when needed
Facilitating Access to Coordination Transportation (FACT)	San Diego County & Orange County	<ul style="list-style-type: none"> • Provides accessible transportation to customers' location of choice (hotels, CRCs, etc.) • Paratransit accessible transit broker • Provides accessible transportation 5:30am-11pm
Salvation Army	San Diego and Orange County	<ul style="list-style-type: none"> • Provides no-cost hotel stays
Indian Health Councils	San Diego County - 16 Tribal Communities	<ul style="list-style-type: none"> • Provides back-up batteries to tribal members with AFN in advance of PSPS • Provides requested resiliency items (e.g., power banks, hand crank flashlight/radios, blankets, emergency backpacks and bottled water) to tribal members in advance of and during PSPS
Community Resource Centers (11 CRCs)	San Diego County - High Fire Threat Communities (HFTD) Orange County - High Fire Threat Communities (HFTD)	<ul style="list-style-type: none"> • Activated only during PSPS in communities most impacted • Resources include ice, water for live- stock, restrooms, cell phone charging, device charging, seating, light snacks, and outage updates • Providing Disability Cultural Competency Training to our CRC and Branch office staff • ADA Accessibility and Disability Integration training • Adapted the CalOES Access and Inclusion Tips for Vaccine sites for the CRC's
San Diego County's Aging and Independence Services (AIS)	San Diego County	<ul style="list-style-type: none"> • 100+ Cool Zones sites that provide service to some of the hottest areas in the San Diego region • San Diego County's Aging and Independence Services (AIS) coordinates these sites at senior centers and public buildings, including libraries in partnership with the Health and Human Services Agency (HHS) Live Well Network
San Diego County CERT	San Diego County	<ul style="list-style-type: none"> • Wellness checks

CBO	Counties Served	Resources
Deputy Sheriff's Association You Are Not Alone (YANA)	San Diego County	<ul style="list-style-type: none"> Wellness checks
Partner Relay Network (County Office of Emergency Services) In-Language	San Diego County	<p>Network of 700+ CBOs and Public Safety Partners. Languages Supported:</p> <ul style="list-style-type: none"> 200 + languages Accessible formats

Table 2: AFN Resources

AFN Resources Before, During, and After 2022 PSPS	2022 Total
Accessible Transportation Trips	NA
Over Night Hotel Stays	NA
Warm Meals Served at CRC/tribal support	NA
Generator Requests	NA
\$50 Gift Cards distributed	NA
CRCs Activated	NA

** AFN Resource offerings listed above are not by census tract.*

There were zero PSPS events in 2022 thus not requiring any pre, during or post resources. In 2023, SDG&E will continue to partner with 211 to showcase the partnership, resources and explore opportunities for enhancement.

2.1.4 Back-Up Power

SDG&E offers several battery back-up programs to enhance resiliency for individuals, many of which are targeted to individuals with AFN during PSPS activations including no-cost and low-cost options.

Portable Battery Program (Generator Grant Program)

The Generator Grant Program (GGP) provides no-cost backup batteries to customers. In 2022, eligible customers included those residing in the HFTD who have experienced one or more PSPS and are enrolled in the Medical Baseline Program or flagged in SDG&E's customer database as having a self-reported disability. The program also expanded to include a broader audience of AFN customers, specifically those that are blind/low vision, deaf/hard of hearing, and temperature sensitive. To date, approximately 4,700 customers have received batteries, with approximately 70% of the eligible population having participated. In terms of customer feedback for this program, of those participants who experienced a PSPS in 2019, 2020 or 2021, 94% reported using the battery unit during the outage,

and of those, 98% replied that the battery unit helped power devices during the PSPS.

- For 2023, the program will continue to prioritize MBL, Life Support, and qualifying AFN customers in the HFTD with a high likelihood of PSPS. SDG&E also plans to continue partnerships with Indian Health Councils to support the direct distribution of batteries to tribal communities.

The planned target for 2023 is approximately 1,000 customers. The program will also continue to deploy “emergency” backup battery deliveries to individuals with AFN who need them during PSPS events and continue targeted outreach, including tribal communities that may be harder to reach.

Generator Rebate Program (Generator Assistance Program)

SDG&E’s Generator Assistance Program offers a rebate incentive for customers to prepare with back-up power sources. The program offers a \$300 rebate to customers who reside in the HFTD and have experienced a recent PSPS-related outage. In addition, the program targets the low-income segment with an enhanced rebate of \$450 for all CARE customers. In 2022, the program increased the rebate for portable power stations to \$100, with an additional \$50 rebate for CARE customers. This rebate amounts are equivalent to a 70 – 90% discount on the average portable generator models for lower-income customers. To date, approximately 2,100 customers have received rebates from this program. The 2023 program will continue to target customers in the HFTD who have experienced previous PSPS events and provide enhanced rebates for low-income individuals including those with access and functional needs on portable generators and portable power stations.

Table 3: 2022 Battery and Generator Rebate Program

Rebates Provided to Customers in 2022	2022 Total
Generator Grant Program	932
Generator Assistance Program	140

Note: The same data will be shown by census tract in Appendix E.

Mobile Home Park Resilience Program

The Standby Power Programs (SPP) target customers and communities that will not directly benefit from other grid hardening initiatives. These targeted customers reside in the backcountry and are generally located on circuits in communities that are most prone to PSPS exposure. One sub-program within the SPP umbrella that offers potential benefits to individuals with access and functional needs is referred to as the Mobile Home Resilience Program (MHRP). This program provides a clean backup power solution to enhance community resilience within their respective mobile home park. More specifically, solar panels coupled with a battery system help keep the mobile home park clubhouse powered during a power outage. The clubhouse tends to be a central location where residents can charge phones or laptops, keep medical devices powered, seek air conditioning, or refrigerate medicine in the community refrigerator. This program has completed two installations since its inception and will continue 1-2 installations annually, with no-out of pocket expenses for the local residents.

SDG&E plans to identify mobile home park communities with an AFN population for potential inclusion in the 2023 program year.

Resiliency Surveys

In 2022, SDG&E invited more than 150,000 customers to participate in a

Personalized Preparedness Resource online survey as part of SDG&E's wildfire safety and resiliency efforts. This offering is promoted through direct customer invitations, wildfire safety fairs, and SDG&E's annual wildfire newsletter. Over

1,300 customers responded, of which 427 individuals stated a household member used a device for health, safety, or independence, and 395 requested more information about AFN. Customers who request information about AFN are directed to information on how to subscribe for additional programs and emergency notifications. The overall response themes indicate that customers are interested in more information about trimming trees for defensible spaces, ensuring homeowners' associations and mobile home park managers receive preparedness information, and education on how cell phone towers operate during outages. In 2023, SDG&E's plans to research program offerings based on customers' most mentioned requests and needs and enhance the survey to include additional preparedness resources and partner with CBOs to support survey outreach.

Community Support

In December of 2022, SDG&E continued its support of the Safe San Diego initiative by accelerating funding in support of more than 30 Community Emergency Response Teams (CERT) and 10 Tribal Emergency Response Teams that provide support for AFN populations during an emergency, disaster, and PSPS. The funding will support participation in the San Diego County CERT Mutual Aid Plan and Neighborhood Evacuation Teams through the Office of Emergency Services and FEMA program.

SDG&E also provided a grant in support of the 2023 Mobile Home Park and Community Education & Fire Safety Program. This funding will impact San Diego County residents of all ages by delivering effective fire and burn prevention programming through programs including Fire Safe Kids (grades K-6), Fire Safe Seniors (age 62+), Youth Firesetter Intervention (age 5-10), and the Scald Prevention Program which targets parents of children age 5 and younger.

The Jacobs & Cushman San Diego Food Bank and Feeding San Diego have partnered with Data Science Alliance (DSA) to create a forecast model for identifying emergency food relief needs in San Diego. DSA will overlay the two food bank organization's data with public data to determine how to meet the needs of low-income individuals and families, and AFN populations. SDG&E accelerated funding December of 2022 for this project, which will allow the food banks to better understand if there are significant correlations between factors like median income, unemployment, gas prices, and energy costs, and the needs expressed by populations of zip code areas.

2.1.5 Customer Assistance Programs

Through SDG&E's comprehensive, marketing, education, and outreach (ME&O) engagement strategy, relevant information on available programs and services is targeted to individuals with AFN to support emergency preparedness, cost savings and resiliency. These programs not only help low-income and disadvantaged communities but are also a critical way for SDG&E to reach a variety of customer demographics within the AFN population. Additionally, SDG&E will explore simplifying program sign up – (e.g., initiative to create a “one-stop” application process currently identified for California Alternate

Rates for Energy Program (CARE), Family Electric Rate Assistance Program (FERA) and Energy Savings Assistance Program (ESA).

In 2022 the Joint IOU's conducted trainings to statewide AFN service and healthcare organizations on Medical Baseline Allowance (MBL) program, PSPS preparedness to help those with AFN to learn about the services available during a PSPS, and eligibility requirements for program enrollment.

As part of the strategy for 2023, the IOUs will continue to engage with community partners and provide a coordinated one-stop marketing and education outreach program for CARE, FERA, ESA and pandemic assistance programs to streamline the efforts and share best practices.

In 2023, SDG&E will continue to expand promotion of these programs to customers identified as AFN, including the addition of programs to the statewide website, as well as explore opportunities to streamline and simplify the enrollment process.

2.1.6 PSPS Preparedness Outreach and Community Engagement

AFN Public Education & Outreach

SDG&E will produce and execute a newly refreshed AFN Public Education campaign in 2023. This campaign will also be directly connected to SDG&E's PSPS public-education efforts. The territory-wide, AFN, mass-market communications effort aims to build upon previous campaigns and increase customer awareness and education. The annual paid advertising campaign, in combination with direct communications and outreach, ensures SDG&E reaches its AFN audience broadly and promotes message consistency and resiliency across the service territory.

Outreach tactics supporting the public education campaign include, but are not limited to, community events such as open houses, wildfire safety fairs and webinars, direct outreach and communications to vulnerable populations in high-risk areas, promotional communications for support services such as generator programs and resiliency surveys, emails to customers, bill inserts, wildfire safety newsletters and wildfire-related customer notifications in accessible formats.

SDG&E's public education campaign will continue to incorporate mass market media, such as TV, print and digital, in a way that treats the message in the style of a Public Service Announcement (PSA) versus a traditional ad campaign and combine this broader outreach with more targeted efforts where available, such as high-risk areas incorporating PSPS resiliency and wildfire safety preparedness messages.

Potential Tactics being explored include:

- TV – Broadcast | New spots are being produced for a high frequency campaign during key programming. The News Billboards and Sponsorships may be complemented with longer additional segments.
- Print | Continue to target senior publications, hard-to-reach areas such as
- the HFTD and various multi-cultural, in-language and tribal publications
- Digital | Banner ads, paid search, and paid social ads possible for more targeted outreach through various digital channels and social media platforms

- Collateral | Develop enhanced printed and electronic collateral that is based on 2022 customer feedback that can be distributed through multiple diverse channels such as medical offices, CBOs, schools, tribal organizations, community events, etc. Additional communication methods will be utilized to continue to increase reach across the entire region as well as support statewide efforts with other IOUs.

Public education materials, including wildfire safety notifications, are made available in the 22 prevalent languages identified in SDG&E's service territory including print and digital collateral and the wildfire safety section of the company website (sdge.com/wildfire-safety). The website undergoes consistent review and updates to ensure it meets accessibility needs. Clear, simplified, plain and inclusive language, accessible fonts, along with diverse AFN imagery is used to communicate information in a meaningful manner.

SDG&E maintains a robust website focused specifically on wildfire preparedness and safety. Customer research indicates that this website is heavily utilized before and during high wildfire risk events. Additionally, this website links to other SDG&E general safety preparedness webpages that include safety information related to natural gas, electricity, vegetation management, generator use, emergency preparedness and power outages (sdge.com/safety).

SDG&E's overarching Wildfire Safety Public Education efforts direct customers and the public to a dedicated and regularly updated wildfire safety webpage (sdge.com/wildfire-safety). Communications tactics and materials that direct to the webpage include, but are not limited to print collateral, broadcast media, newspaper advertising, digital and in-community communications. The wildfire safety webpage serves as the company's one-stop shop for wildfire preparedness, PSPS, safety information and available resources. Power outage safety and resiliency is emphasized throughout this section of the website. Also included are updated safety tip videos and wildfire safety webinar content. Additionally, the section includes information about the extensive partnerships and systems used to ascertain fire-science data. A primary call-to-action on the wildfire-safety section of the website and company's public-education campaign materials will continue to encourage customers and the public to sign up for wildfire-related notifications and download the PSPS app, coupled with wildfire safety and PSPS preparedness, safety and resiliency tips. A dedicated landing page will continue to be updated and provide resources to assist AFN communities, particularly for PSPS (sdge.com/AFN). The page provides extensive information and resource links which include but are not limited to notification sign-up, emergency plan/kit checklists, generator safety, 211-service promotion and referral, the Medical Baseline program and application, CARE, FERA and ESA, as a representative sample of some of the information available to the viewer.

SDG&E will continue to enhance and expand tribal communications, education and outreach. Culturally appropriate communications are being expanded in 2023. New printed and online collateral for tribal communities is being developed. Additionally, a Native American marketing consultant is working with SDG&E to develop tribal content on the company's website (sdge.com) to help support public education and outreach efforts. SDG&E will continue to work with tribal communities to support their PSPS resiliency needs.

Communication and customer engagement is fundamental to ensuring wildfire preparedness and PSPS resiliency in the HFTD communities. SDG&E is dedicated to meeting customers' needs and will continue to leverage multiple channels of communication:

- Year-round wildfire safety education and communications campaign that leverages more than 20 diverse communications platforms
- Multiple webinars and wildfire safety fairs to connect customers with subject matter experts
- In-community electronic signage to share important and timely safety information during PSPS

Statewide Website for AFN Solutions

Prepare For Power Down is a Joint IOU website, created as a centralized resource for statewide CBO and agencies serving AFN communities, providing easy access to IOU information on PSPS preparedness and resources. The website offers downloads, including the 2021 Joint IOU Medical Baseline flyer in 11 languages, the Joint IOU CBO training presentations, PSPS social media graphics and utility specific PSPS support materials.

In response to the AFN Collaborative Council’s request for a Joint IOU centralized website, the IOU’s established a working group in Q1 and began identifying enhancements for the website based on the feedback received. The Joint IOU working group benchmarked with other organizations to look for both short and long-term solutions. In Q4 of 2022, the IOUs worked with the web developing vendor to refresh the website for ease of navigation and accessibility. The IOUs plan to further develop the website in 2023.

In addition, the Joint IOU working group is engaged with the Universal Application System (UAS) working group that explored an Income Qualified UAS to understand the feasibility of developing a “one-stop shop”, and how efforts made by the Joint Utilities Working Group and the Qualified UAS Working Group could be aligned. The UAS Report recommends pursuing integrations for resiliency programs that help customers mitigate the impacts of PSPS once CARE, FERA, and ESA applications are successfully integrated. The Joint Utilities Working Groups will continue to seek opportunities to work with the Qualified UAS Working Group.

Accessibility of Communications

Effective communication is important for the safety and well-being of customers of every ability and requires accessibility. Enhancing the accessibility of customer notifications is a top priority. SDG&E worked with stakeholders and experts to identify accessibility enhancement opportunities in our notifications to customers. These include:

- Implementation of an Accessible Hazard Alert System (AHAS), that provides customized on-demand accessible alerts in real time (15 min) with the same accessibility as the current pre-recorded PSPS customer notifications. This allows SDG&E to provide accessible communication during unforeseen emergencies. These notifications are also in accessible formats to be shared on social media and web platforms.
- Implementation of Video Remote Interpreting (VRI) resource and training to all CRC and Branch Office staff, allowing for complex conversations and information sharing in ASL and non-English languages. SDG&E employees may access the VRI resource by PC, tablet or Smart Phone via the Boost Lingo platform. ASL translators via video chat, or non-English translators (voice only) are available 24/7 to equally provide important information and to engage in conversations with all customers.

- Maintaining compliance with WCAG 2.1 AA guidelines via ongoing review and scoring through partnership with AudioEye for the three external SDG&E web sites (SDGE.com, MyAccount.sdge.com, and SDGEnews.com). Web development team training, help desk support and accessibility resources are available throughout the year. SDG&E will work to implement updated web accessibility guidance as it becomes available.
- Reviewing customer program application processes and forms to identify opportunities to make it more accessible and easier for customers to navigate.
- Conducting readability reviews of web content and marketing materials to make sure the information is conveyed in a simple language and easy to understand format. SDG&E is exploring training for marketing and web contact contributors in creating accessible documents.

AFN Power Panel

To better understand the needs of customers with AFN, a power panel was created in 2022. The AFN Power Panel is a year-long, monthly survey, specifically for customers with AFN to serve as customer advocates for accessibility and accommodations in relation to PSPS. Topics may include outage needs, communication channels, electric-powered device needs, and other areas of interest that help SDG&E identify and refine accommodations to better serve this population. While SDG&E deems the information from respondents as valuable to understanding customer segment, the sample size of the AFN Power Panel is currently small (n=~350), so results from these surveys are interpreted with caution.

Community Based Organization Outreach

CBOs continue to serve as a key channel and support network throughout SDG&E's service territory. These organizations are considered trusted partners in the communities they serve and provide valuable insight and engagement across various segments, including support to individuals with an AFN. Additionally, these partners amplify SDG&E's wildfire preparedness and notification messaging to hard-to-reach customers, with an emphasis on reaching those located in the HFTD.

SDG&E's Energy Solutions Partner Network, which consists of approximately 200 CBOs, is leveraged to help prepare customers, especially those who may be vulnerable, for wildfires and other emergency situations. These partners, which receive financial compensation for their year-round support, leverage critical information and notifications through a variety of outreach tactics including presentations, events, meetings, and the amplification of emergency preparedness information. SDG&E targets outreach to the diverse needs of individuals with AFN and will continue to seek opportunities to promote enrollment and awareness of support services available during a PSPS. In 2022, SDG&E added approximately 10 new partners including: 1) Backcountry Communities Thriving; 2) County of San Diego Live Well; and 3) Diabetes Research Connection.

In 2023, SDG&E will continue to strengthen existing partnerships while building new partnerships with organizations that represent the needs of customers with AFN, with an enhanced focus on the deaf and blind, disabled veterans, and non-English speaking communities. We have identified these segments as areas of growth for outreach and accessibility and through feedback from council engagement and surveys.

In 2021, SDG&E developed an enhanced compensation structure for CBOs to provide enhanced

notification support, focusing on those in the HFTD as well as individuals with an AFN. To further reach these customers and amplify preparedness and active PSPS support, SDG&E strategically identified approximately 40 CBOs within its Energy Solutions Partner network. As part of this enhanced process, these CBOs, who reach a wide range of demographics including diverse, multicultural, multilingual, senior, disadvantaged and AFN communities, received comprehensive training and materials related to emergency preparedness and wildfire safety. Prior to a PSPS, SDG&E provides notifications and updates to these organizations, who then serve as a critical channel to amplify messaging and communicate with customers who may not utilize traditional channels. This PSPS messaging is then shared through the CBO's communication channels including social media platforms such as Facebook, Twitter and Instagram. Examples of these select CBOs include 1) Access to Independence; 2) San Diego Center for the Blind; 3) Fallbrook Senior Center; 4) Julian Cuyamaca Resource Center; 5) Meals on Wheels; and 6) San Diego Oasis.

Since 2021, SDG&E continues to expand the PSPS support network of CBOs and has since increased the number to roughly 50. In 2023, SDG&E plans to continue this enhanced engagement effort while adding additional CBOs to provide this PSPS notification support.

SDG&E also provides presentations to local CBO's that may not be part of the ESP network, focusing on organizations with disabled and aging population constituents. These presentations provide educational awareness of PSPS support services, emergency preparedness, customer assistance programs and collaboration opportunities to enhance outreach efforts. Examples of organizations receiving presentations in 2022 include Live Well Rural Collaborative, Rural Healthcare Collaborative and the Council on Access and Mobility.

In 2023 SDG&E continues to award key AFN organizations with shareholder grants who provide additional PSPS preparedness. SDG&E will work with these groups to identify PSPS support service educational trainings, shared AFN and PSPS materials, and other outreach opportunities as they are identified.

SDG&E recognizes there are additional opportunities to reach customers who are disabled and aging individuals with our preparedness and support services with accessible messaging. SDG&E recently contracted with a local communications firm to advise on strategic communication channels and tactics to expand educational outreach to targeted AFN segments in 2023.

2.1.7 Key Outreach Segments

Healthcare Industry and State Agencies

SDG&E recognizes that ongoing engagement with healthcare practitioners, medical associations, managed care program providers, and durable medical equipment suppliers is a key opportunity to increase enrollment in the Medical Baseline Program and connect individuals with AFN to programs and services that help our customers prepare for a PSPS.

The Joint IOUs will continue to collaborate and partner to deliver statewide training sessions to the California's Department of Social Services In-Home Health and Supportive Services (IHSS) Program Managers, the Department of Developmental Services' Regional Center staff and the California Rural Indian Health Board (CRIHB). The Joint IOUs also produced an on-demand training video for the California Hospital Association/California Hospital Council which was shared with the Hospital

Association of San Diego & Imperial Counties. The training sessions covered:

- Emergency preparedness and planning
- PSPS Support Services through 211
- Generator and back-up battery programs
- Medical Baseline Allowance Program and Self-Identified Vulnerable Customer Program
- Other resources and offerings provided to customers before and during a PSPS (e.g., PSPS notifications sign-ups, Community Resource Centers, food support)

In 2023, the Joint IOUs will work to cultivate new partnerships to help amplify IOU PSPS outreach efforts to increase preparedness and drive enrollment in the MBL program. In addition, the utilities will continue to identify opportunities to develop comprehensive joint IOU and IOUs specific communication to promote services and resources available before, during and after a PSPS.

In 2022, SDG&E focused on enhancing awareness around the Medical Baseline Allowance Program (MBL) to reach individuals who may use durable medical equipment. SDG&E partnered with medical supply stores to make MBL program applications available to interested customers. In addition, training on MBL and PSPS support services was provided to Sharp Healthcare Caseworks and collaborations are underway with the Rural Healthcare Collaborative (Grossmont Hospital Healthcare District) on the distribution of MBL applications and PSPS support services.

SDG&E will continue developing these relationships and identify other opportunities in 2023.

Paratransit Service Engagement

SDG&E partnered with FACT, a key paratransit broker agency in SDG&E's region, to develop communication protocols during PSPS events for the paratransit service providers in the SDG&E service territory. SDG&E provided updates on PSPS activation, who amplified the notification to approximately 160 paratransit service provider's network. In 2023, SDG&E will explore paratransit agencies that may reside outside of the FACT network and look for new opportunities to utilize the agencies with accessible transportation services to reach customers with AFN.

Master Meter Outreach

In 2023 SDG&E will continue to focus on reaching non-account holders through creative direct mail and email campaigns. These campaigns educate and inform HFTD multifamily unit and manufactured home park property managers, building owners and tenants of PSPS preparedness and available support services. SDG&E will continue efforts to identify new channels and partnerships expanding customer reach and identify new areas of opportunities for education on emergency preparedness and PSPS support services including egress for buildings with elevators.

2.1.8 Advisory Councils

Wildfire Safety Community Advisory Council (WSCAC)

The Wildfire Safety Community Advisory Council (WSCAC) was established in 2019. WSCAC provides direct constructive input, feedback, recommendations, and support from community leaders to SDG&E

senior management and the Safety Committee of SDG&E's Board of Directors on how SDG&E can continue to help protect the region from wildfires. This specialized group of diverse and independent leaders from public safety, tribal government, business, nonprofit, and academic organizations in the San Diego region possess extensive experience in public safety, wildfire management, community-based services, and applied technology.

WSCAC meetings are led by SDG&E's Chief Operating Officer, Kevin Geraghty, and are attended by members of the Safety Committee of the SDG&E Management Board. At WSCAC meetings, SDG&E annually presents its Wildfire Mitigation Plan and subsequent updates for discussion, suggestions, and recommendations by WSCAC members. SDG&E also welcomes input from WSCAC members on relevant emerging community issues on wildfire safety and preparedness's meetings are organized by SDG&E's Community Relations department working with Wildfire Mitigation and Vegetation Management, Emergency Operations, Operations Communications, Fire Science and Climate Adaptation, Aviation Services, Distribution Operations, Electric System Planning & Grid Modernization, Regulatory Affairs, State Government Affairs, and other departments as necessary. The WSCAC meets at least twice a year at SDG&E facility that are part of SDG&E's wildfire management program. Those facilities may include the SDG&E Emergency Operations Center, SDG&E Mission Control, the SDG&E Risk Management Center, and the SDG&E hanger at Gillespie Field. In 2021, SDG&E began conducting quarterly WSCAC meetings.

Tribal Engagement

SDG&E has a Tribal Relations team that includes a dedicated manager to engage and coordinate with tribal leaders and continue to meet with these partners to understand their greatest challenges with PSPS. Through these collaborations, the top-of-mind challenges identified include the impacts to elders, generators, food insecurity and remoteness. Tribes are telling us they have limited resources and cannot always provide feedback. Additionally, the pandemic has limited the effectiveness of our engagement due to internet access and other issues. In response, SDG&E established support systems with Indian Health Councils to provide generators, resiliency items, information, and resources in advance of wildfire season and support with emergency food distribution during PSPS. In 2022, SDG&E surveyed tribal leaders and first responders to understand how to better support tribal communities through PSPS events. SDG&E also conducted a focus group, this group provided feedback that led to the development of small cards that can be handed out by tribal first responders when visiting tribal members that refer them to SDG&E resources, including 2-1-1. SDG&E will continue to seek feedback and survey tribal leaders to enhance support.

Building on the feedback we received from tribal leaders and first responders, in 2023, SDG&E will further establish tribal fire departments and law enforcement as a support system to provide resiliency items, information, generators, and information to reach more tribal members, particularly during PSPS because they are the most trusted and on-the-ground conducting wellness checks to the most vulnerable tribal members living on reservations. In addition, we will continue to have year-round listening sessions with tribal leaders and staff to increase our reach to tribal members living on and off the reservations.

2.2 PSPS Activation (During – Emergency Operation Center Activated)

2.2.1 PSPS Communications

Before PSPS Paid Media/Advertising

SDG&E maintains a robust Wildfire Safety Community Awareness campaign to educate customers and the general public throughout its service territory. This campaign helps the community prepare for the risk of wildfires and PSPS and encourages customers and the public to take preparedness measures such as updating their profile contact information, signing up for SDG&E notifications and downloading the PSPS app (SDG&E Alerts). Fundamental to the campaign's success is its collaborative framework – local public safety and community partnerships such as 211 San Diego, 211 Orange County, the San Diego County AFN Working Group and American Red Cross help disseminate important information to potentially impacted and vulnerable communities.

Communication efforts also focus on AFN populations and other hard-to-reach communities. A dedicated paid AFN public-education campaign is activated every year leading up to and during peak wildfire season. In 2023 the Public Education campaign is being refreshed with new visuals and creative content. The campaign informs customers and the public about available services through SDG&E's collaboration with local community-based organizations (CBOs) including 211 San Diego, 211 Orange County, FACT, and others. Key materials are produced in prevalent languages spoken in the region.

Some potential paid communications include:

- Promotion of community engagement events, emergency preparedness workshops, safety fairs and public participation meetings
- General Market TV
- Streaming TV
- General Market Radio
- Streaming Radio
- Radio Sponsorships (Traffic, News, Weather)
- Out-Of-Home (Bulletins/Posters/Transit)
- Digital (Banner Ads, Mobile Phone Ads, Online Video, Paid Search, Paid Social)
- Print Advertising
- Community newspapers in the HFTD and the service territory (Back Country, Spanish, Asian, African American, General Market)
- Educational information disseminated through a bill newsletter or special insert included in customer bills
- A series of wildfire safety and preparedness videos and new vignettes to help customers and the public prepare for wildfire and PSPS

- Distribution of an annual Wildfire Safety newsletter that is mailed to customers in the HFTD
- Promotion of weather information and system-outage status on
- SDGE.com
- Paid and organic social media messaging that includes platforms like Twitter, Facebook and Nextdoor
- Partnership with a network of over 400 non-profit and community-based organizations who share fire safety and emergency communications with their networks
- Direct promotion of customer offerings such as generator incentives, resiliency surveys and AFN resources

SDG&E will continue to solicit and utilize customer feedback to refine and improve public education messaging and tactics listed above.

Communications During PSPS

During PSPS, SDG&E uses notifications, media updates, in-community signage and situational awareness postings across social media and shares social media kits with community partners to reach a broad audience. Additionally, SDG&E activates communications to provide affected customers and the public with the latest real-time updates during a PSPS. Key communications are available in 21 prevalent languages.

During PSPS, SDG&E has a dedicated AFN liaison, who is responsible for conveying real-time updates and talking points to AFN community partners. SDG&E also uses communication platforms, including social media channels, broadcast and print media, and the SDG&E NewsCenter and website, to share enhanced support services available for individuals with AFN. SDG&E also produces and distributes a digital document that lists communities affected by a PSPS and shares it with local municipalities and agencies. This effort is intended to give additional context about PSPS events and help communities prepare.

In addition to mass media, SDG&E utilizes several communications channels geared towards individuals who may not be accountholders (e.g., visitors, mobile home park residents, caretakers, etc.) these channels include SDG&E's PSPS Mobile App (Alerts by SDG&E), roadside electronic message signs placed in strategic, highly traveled locations, tribal casino marquees and flyers posted around impacted communities.

As SDG&E had no PSPS occurrences during 2022, annual efforts to solicit feedback from customers who were affected by PSPS did not occur. The company plans to resume customer-research efforts with PSPS-affected customers at the end of the 2023 season.

PSPS Notifications

SDG&E sends PSPS notifications to all impacted individuals as soon as possible through its Enterprise Notification System (recorded voice message, email and text message). In 2022, SDG&E worked with Deaf Link to convert all notifications into American Sign Language (ASL) video, audio read-out and written transcript. SDG&E also enables address-level alerts for customers and the general public through

its Alerts by SDG&E app.

Annually SDG&E evaluates the content library of PSPS email, text and voice notifications for customers and non-accountholders. SDG&E also uses feedback solicited from and provided by customers who have been notified and affected by PSPS events to simplify notification messaging and make content more representative of the conditions being experienced. As there were no PSPS occurrences in SDG&E's territory during 2022, customer feedback was not solicited. SDG&E will be reviewing notifications in 2023 for clarity and may make refinements to make messaging clearer and more accessible. During 2022, updated PSPS notifications were translated and recorded into 21 prevalent languages spoken in the region. Every year the SDG&E public-education campaign includes messaging about signing-up for notifications prior to the start of peak fire season.

For MBL and Life Support Customers, SDG&E reviews the results of each Enterprise Notification System campaign to determine if a positive confirmation for MBL customers was received through a voice contact (landline or cell phone, based on the customer's preferred contact number). For any MBL customers that SDG&E does not reach by voice contact, a list is provided to SDG&E's Customer Contact Center, who proactively call customers that have not been contacted. If they are unsuccessful in contacting the customer, SDG&E will then send a Customer Service Field representative to the customer's service address to notify them. SDG&E trains Customer Service Field representatives on the County of San Diego's First Responder AFN Training Series to promote an empathetic and supportive approach for customers with AFN.

Accessible Media Engagement

SDG&E continues to prioritize accessibility for its websites and mobile apps. The company takes a proactive approach to meet Americans with Disabilities Act (ADA) and Web Content Accessibility Guidelines (WCAG) global web standards for accessibility.

SDG&E continues to leverage an AFN landing page (sdge.com/AFN) to allow customers to self-identify, as well as get personified resources for AFN needs. Optimized Drupal (content management system) includes accessibility features such as search engine form and presentation, color contrast and intensity, image handling and form labeling. Implementation of the AudioEye services continuously tests and remediates accessibility issues automatically and sends alerts for other potential issues. SDG&E also works with the Center for Accessible Technology (C4AT) on testing and remediation of the company's digital properties.

While executing the development, implementation and maintenance of our digital properties, SDG&E ensures that accessibility is a requirement and priority so all customers can access our information.

In 2023, SDG&E will continue to engage with local broadcast media and utilize various mediums to reach the public, including AFN communities, and Limited English Proficient residents, to provide them with wildfire safety and emergency preparedness information, PSPS awareness and PSPS education.

Per the U.S. Census Bureau, San Diego County is home to more than 3.3 million residents, approximately 1.1 million of whom are Hispanic and Latino. SDG&E's service territory also borders Baja California, México, and is home to one of the busiest land border crossings in the world. In addition to providing communications in language, SDG&E's dedicated Spanish communications manager translates wildfire safety and PSPS-related news releases, social media and other communications pieces for the public and

local Spanish broadcast media. SDG&E also continues to provide critical PSPS and wildfire safety information in all prevalent languages.

Prior to a wildfire-related event, SDG&E will engage local broadcast media, including local Spanish media and multicultural niche outlets, early and often to reach customers and notify them of impending high fire risk conditions, the potential for a PSPS, where to go for more information and available resources. Local broadcast media, including designated emergency broadcast radio, will continue to amplify SDG&E's messaging during a wildfire or high fire risk weather conditions to keep our diverse customer base and the public informed.

2.2.2 Community Resource Centers (CRCs)

As a result of community meetings held in communities in SDG&E's service area, SDG&E established a network of Community Resource Centers (CRCs) to help communities in real-time during Public Safety Power Shutoffs. Currently, SDG&E has identified 11 customer-owned facilities located within the HFTD to serve as CRCs during adverse weather events and maintains 3 mobile units for deployment. The CRC locations selected by SDG&E were identified through a rigorous process, which included input from fire and meteorological experts, as well as consideration of those areas most prone to adverse weather, as indicated by historical data.

Customers at CRCs are provided:

- Bottled water
- Light snacks
- Cell phone charging
- Seating
- Accessible Restrooms
- Ice
- Water trucks (for large animals)
- Up-to-date outage event information

CRCs will also have charging stations, seating, and accessible restrooms available on-site. SDG&E endeavors to provide cellular network services and will collaborate with the telecommunication providers who support services in CRC areas.

SDG&E has coordinated with each CRC site-facility owner on Americans with Disabilities Act (ADA) compliance and has provided additional accessibility and safety items in "AFN Go Kits". These Go Kits include items to mitigate trip hazards, communication aids, additional accessibility and directional signage, and materials to expand accessible parking and provide safe paratransit loading zones. Privacy screens are available to provide a private area for sensitive activities like administering medications, breastfeeding, a calming area for sensory disabilities and other needs.

Additionally, SDG&E has leveraged key takeaways from Cal OES's Inclusive Planning Blueprint for Addressing Access and Functional Needs at Mass Testing/Vaccination Sites. SDG&E has implemented

Video Remote Interpreting (VRI) resource and training to all CRC staff, allowing for complex conversations and information sharing in ASL and non-English languages. Each CRC will also have non-English visual translator boards for simple and casual conversations. SDG&E will ensure all CRC staff are familiar with possible reasonable accommodation requests and know to refer such requests to the EOC AFN Liaison Officer for solution support.

SDG&E established a medical device drop-off process for charging, as well as a back-up battery swap option for AFN individuals at the CRCs. More details about SDG&E's CRCs, including siting and accessibility will be outlined in its forthcoming CRC plan as required by D.20-05-051.

2.3 Recovery (After – Power has been restored)

2.3.1 AFN Support

After Action Reviews and Reports

SDG&E will continue to follow the established emergency management After Action Review (AAR) process for all events in 2023. This process includes bringing together key internal personnel that participated in the event in any way. Other AAR's are held with external partners and a joint report is then produced to combine all findings to understand our strengths, opportunities to improve and lessons learned into an AAR Improvement Plan for implementation.

Lessons Learned and Feedback

Fortunately, 2022 did not require SDG&E to implement PSPS protocols. As a result, although there were no lessons learned in 2022, SDG&E used this as an opportunity to build bench strength to the EOC roster, develop more robust strategies to support our customers, and focus on sharpening our AFN subject matter expertise. SDG&E will continue to leverage lessons learned from 2021, including closer coordination and more advanced notice to AFN support model partners and vendors. The nature of a PSPS does not lend itself to extended advance notice, however, SDG&E will notify partners and vendors when there are early indications of weather conditions that may trigger a PSPS.

Customer Surveys

A post PSPS Wildfire Survey is conducted once a year at the end of Wildfire Season. The 2022 post season survey was not conducted as there were no Public Safety Power Shutoff's or affected customers in SDG&E's territory. Results of the 2022 pre-season survey will be used to evaluate and improve communications for 2023. The company plans to resume Pre-season and Post-season research efforts during 2023.

3 Information Collection, Analysis, and Dissemination

3.1 Customer Privacy

In order to better serve our customers and individuals with AFN, SDG&E may communicate via email and mail with account holders from time to time to update their account information, especially for those with an AFN for their health and safety. Additionally, SDG&E enables customers to self-identify as having an AFN. SDG&E does not collect or store specific information other than blind/low vision, deaf/hard of hearing or general disability status.

San Diego Gas & Electric Company takes the privacy and security of personal information seriously. This Privacy Policy describes how we collect, use, and disclose personal information relating to California residents under the California Consumer Privacy Act of 2018 (“CCPA”) and can be located at sdge.com/ccpa-policy.

4 Authorities and References

4.1 Annual Report and Emergency Response Plan in Compliance with General Order 166

SDG&E updated the Company Emergency and Disaster Preparedness Plan and was approved and signed by the company CEO on 11/8/2021. All updates are in compliance with GO 166. The next formal update will be completed by 4/30/2023.

4.2 Phase 3 OIR PSPS Guidelines: AFN Plan & Quarterly Updates

Each electric investor-owned utility’s annual Access and Functional Needs plans and quarterly updates must incorporate, at minimum, the six steps outlined in the Federal Emergency Management Administration’s Comprehensive Preparedness Guide¹³:

- forming a collaborative planning team
- understanding the situation
- determining goals and objectives
- developing the plan
- plan preparation and approval
- plan implementation and maintenance

As part of forming a collaborative planning team, utility representatives at the Senior Vice President level, or with comparable decision-making power over development and implementation of the Access and Functional Needs plans, must meet at least quarterly with representatives of state agencies and community-based organizations that serve and/or advocate on behalf of persons with access and functional needs. The purpose of these meetings will be to develop, implement, and review each IOU’s annual Access and Functional Needs plans in accordance with the Comprehensive Preparedness Guide¹³.

[\(Note: Phase 3 PSPS Guidelines](#) (AFN section starts on p.106))

¹³ [ready.gov](https://www.ready.gov)

Appendix A: Core Planning Team Participants

APPENDIX A – CORE PLANNING TEAM PARTICIPANTS

Name	Organization	Title
Kelly Brown	Interface Children & Family Services 2-1-1	Community Information Officer
Tracey Singh	American Red Cross	Pacific Division Disability Integration Advisor
Tawny Re	Bear Valley Electric Service, Inc.	Customer Program Specialist
Chris Garbarini	California Department of Developmental Services (CDDS)	Senior Emergency Service Coordinator
Tamara Rodriguez	California Department of Developmental Services (CDDS)	Officer, Emergency Preparedness & Response
Dan Okenfuss	California Department of Developmental Services (CDDS)	Public Policy Manager
Dan Heller	Deaf Link, Inc.	President
Kay Chiodo	Deaf Link, Inc.	CEO
Carolyn Nava	Disability Action Center (DAC)	Executive Assistant
June Isaacson Kailes	Disability Policy Consultant	Disability Policy Consultant
Kate Marrone	Customer Care Manager	Liberty Utilities
Malorie Lanthier	North Los Angeles County Regional Center	IT Director
Fred Keplinger	Redwood Coast Regional Center	Emergency Management Coordinator
Tiffany Swan	San Diego Regional Center (SDRC)	Community Services Home and Community Based Services Specialist
Alexandra Green	The Center for Accessible Technology (C4AT)	Legal Counsel
Melissa Kasnitz	The Center for Accessible Technology (C4AT)	Legal Counsel

Appendix B: Collaborative Council Participants

APPENDIX B – COLLABORATIVE COUNCIL PARTICIPANTS

Name	Organization	Title
Paul Marconi	Bear Valley Electric Services	President & Treasurer
Roseana Portillo	Bear Valley Electric Services	Senior Policy Advisor
Sean Matlock	Bear Valley Electric Services	Emergency Resource Manager
Tawny Re	Bear Valley Electric Services	Customer Program Specialist
Robert Hand	California Foundation for Independent Living Centers (CFILC)	Interim Executive Director
Vance Taylor	California Governor’s Office of Emergency Services (Cal OES)	Chief, Office of Access and Functional Needs
Anne Kim	California Public Utilities Commission (CPUC)	Regulatory Analyst
James Cho	California Public Utilities Commission (CPUC)	Program Manager
Moustafa Abou- taleb	California Public Utilities Commission (CPUC)	Safety Policy Division
Andy Imperato	Disability Rights California (DRC)	Executive Director
Jordan Davis	Disability Rights California (DRC)	Attorney
Karen Mercado	Disability Rights California (DRC)	Senior Administrative Assistant
Susan Henderson	Disability Rights Education & Defense Fund (DREDF)	Executive Director
Chris Alario	Liberty Utilities	President, California
Edward Jackson	Liberty Utilities	President

Name	Organization	Title
Kate Marrone	Liberty Utilities	Customer Care Manager
Matthew McVee	PacifiCorp	Vice President, Regulatory Policy
Pooja Kishore	PacifiCorp	Renewable Compliance Officer
Aaron Carruthers	State Council on Developmental Disabilities (SCDD)	Executive Director
Brian Weisel	State Council on Developmental Disabilities (SCDD)	Legal Counsel

Appendix C: AFN Q4 2022 YTD Recap

**San Diego Gas & Electric Company's
Quarterly Update to 2022 Plan to Support
Populations with Access and Functional Needs
During Public Safety Power Shutoffs**

January 31, 2023



Introduction

On January 31, 2022, San Diego Gas & Electric Company (SDG&E or Company) submitted its 2022 plan regarding its planned efforts to support populations with access and functional needs (AFN) during de-energization events (2022 AFN Plan) in accordance with California Public Utilities Commission (Commission or CPUC) Decision (D.) 20-05-051 Phase 3 OIR Decision Guidelines leveraging the Federal Management Administration's (FEMA) six step Comprehensive Preparedness

Guide (CPG) process. SDG&E's 2022 AFN Plan outlined its approach for serving individuals with AFN and vulnerable customers before, during and after PSPS.

Per D.20-05-051, SDG&E provides this quarterly update regarding its progress toward meeting its 2022 AFN Plan and the impact of its efforts to address the AFN and vulnerable population during de-energization events, also known as Public Safety Power Shutoff (PSPS). This update maps to and follows the sequencing of SDG&E's 2022 AFN Plan¹ for ease of reference and builds upon the efforts described therein. Specifically, rather than repeating the activities SDG&E describes in its 2022 AFN Plan that were already taken, this update provides the incremental efforts taken since October 31, 2022.

CONCEPT OF OPERATIONS | HOW

1.1 Preparedness/ Readiness (Before Power Shutoff)

1.1.1 Emergency Operations Center

Leading up to the PSPS season, the SDG&E Emergency Management Department meets with public safety partners to determine the best method of communication and to provide situational awareness during Emergency Operation Center (EOC) activations. Public safety partners are proactively informed through different forms of communication throughout the year.

Impacted public safety partners from 2021 will be directed to the new SDG&E Public Safety Partner Portal and Portal Mobile Application to receive the latest situational updates. Impacted critical facility and infrastructure customers were communicated to directly by their SDG&E account executive via phone and/or email communication with a newly developed webpage with specific information related to their needs. These impacted critical facility and infrastructure customers were provided a list of their potentially impacted meters and situational updates.

1.1.2 Preparation Exercises & Training

SDG&E's Emergency Response team conducts extensive preparation and training in collaboration with the AFN team to prepare for PSPS and supporting individuals with AFN. These include:

- Conducted a PSPS Tabletop exercise on June 27 with over 100

attendees,

including active participation from AFN partner organizations;

- • Conducted AFN CBO support partner process walk-through with 211 SD, 211 OC, FACT and Salvation Army on June 29;
- • Virtual EOC tours for external stakeholders;
- • Joint planning with County OES, CalOES, CAL FIRE, emergency managers and Regional Fire Chiefs;
- • AFN Liaison Officer training on the process and protocols for communication and AFN CBO services;
- • Training on IOU programs and services to home workers, social service staff, CBOs, tribal orgs, and CERTS; and
- • Held PSPS webinars for Safety and Community Partners.

1.1.3 EOC AFN Liaison Role

An EOC AFN Liaison team has been confirmed and a roster has been created for the 2023 calendar year. In October, two internal review training and practice sessions for AFN Liaison Officers were held to maintain readiness for a PSPS. These practice sessions included specific position process and procedures, and role requirements as well as partner notification systems. exercise.

1.1.4 Customer Care Support

In 2022, SDG&E supported individuals and households with AFN. When customers call or visit our branch office to speak with an agent regarding AFN specific concerns, they will be directed to the appropriate resource to receive support (e.g., 211, Customer Assistance AFN EOC role, etc.). Additionally, SDG&E's Customer Care Center representatives are trained to speak with customers

experiencing challenges and if it is the customers' preference, flag them in SDG&E's system as having a self-identified disability for additional consideration of tools, programs, and services.

1.2 AFN Identification

SDG&E has continued enhancing its ability to identify Electricity Dependent individuals with AFN through defining, mapping, and enabling self-identification with the goal to mitigate the impacts of PSPS on individuals with AFN served by IOUs through improved outreach, education, assistance, programs, and services.

SDG&E has identified and flagged approximately 423,000, or roughly 33% of residential customers as AFN. Approximately 44,000 of these customers reside in the HFTD. SDG&E's Access and Functional Needs ID Types:

AFN Self-Identified CARE

FERA

Medical Baseline (MBL)

Life Support (subset of MBL) Temperature Sensitive (subset of MBL) Deaf/Hard of Hearing

Blind/Low Vision Disabled

Senior (62 +) Non English

The IOUs have made progress in identifying the Electricity Dependent individuals with AFN through defining, mapping and enabling self-identification. Each IOU identifies the following customers in their respective databases as AFN. Please see Figure 1.

Figure 1 below accounts for the number of customers identified as AFN in each utility service area, as well as those mostly likely to experience a PSPS.

Figure 1. Joint IOU Access & Functional Needs Individuals¹²

Joint IOU	MBL Individuals	Customers with Language Preference	Individuals Identified as AFN	Percentage of Individuals Identified as AFN based of Total Residential Customer Base*
PG&E	Total: ~273,000	Total: ~382,900	Total: ~1.7M	30%
	PSPS-Likely: ~71,200	PSPS-Likely: ~17,300	PSPS-Likely: ~311,300	27%
SDG&E	Total: ~71,000	Total: ~67,000	Total: ~423,000	33%
	PSPS-Likely: ~13,000	PSPS-Likely: ~5,000	PSPS-Likely: ~44,000	25%
	Total: ~116,000	Total: ~680,000	Total: ~1.7M	37%

SCE	PSPS-Likely: ~40,000	PSPS-Likely: ~100,000	PSPS-Likely: ~300,000	29%
-----	----------------------	-----------------------	-----------------------	-----

**Percentages are approximate.*

1.2.1 AFN Identification Outreach

In Q4 SDG&E continued to promote the ability to self-identify through various channels including web form and Customer Contact Center and communications campaigns, which included mail in forms to reply.

Article: SDG&E's ACCESSIBLE INFORMATION, RESOURCES AND SERVICES

SDG&E is committed to supporting its customers who have access and functional needs. Do you or does someone in your household have a disability or use an electronic medical device for health, safety, or independence? Do you prefer to receive information in a language other than English? SDG&E provides certain communications in over twenty languages including American Sign Language (ASL).

Billing statements are available in large font or Braille for those who are blind or have low vision. Depending on your needs, you may also qualify for bill discount programs at sdge.com/assistance.

Visit sdge.com/AFN to learn more about SDG&E's accessible resources, programs and services.

Social posts: SDG&E's ACCESSIBLE INFORMATION, RESOURCES AND SERVICES

SDG&E is committed to supporting its customers with various access and functional needs and making sure that everyone is offered equal access to information, resources and services. Get more information at sdge.com/AFN. #sdge #SDGEAssist

SDG&E is committed to providing all customers with accessible resources and services. To learn more, visit sdge.com/AFN. #sdge #SDGEAssist

Translated article: INFORMACIÓN, RECURSOS Y SERVICIOS ACCESIBLES DE SDG&E

SDG&E se compromete a apoyar a nuestros clientes que tienen necesidades funcionales y de acceso. ¿Usted o alguien en su hogar tiene una discapacidad o utiliza un dispositivo médico electrónico para mantener su salud, seguridad o su independencia? ¿Prefiere recibir información en español o en un idioma distinto del inglés? SDG&E proporciona mensajes e información en más de veinte idiomas,

incluido la lengua de señas americana (ASL).

Facturas están disponibles en letra grande o Braille para las personas ciegas o con baja visión. Según sus necesidades, también puede calificar para programas que ofrecen un descuento en sdge.com/asistencia.

Para obtener más información sobre los recursos, programas y servicios accesibles de SDG&E, visite sdge.com/AFN o envíe un mensaje por correo electrónico a AFNsupport@sdge.com.

Images: SDG&E's ACCESSIBLE INFORMATION, RESOURCES AND SERVICES



Estamos para servirle.



¿Usted o alguien en su hogar:

- tiene alguna discapacidad?
- usa un dispositivo médico que requiere electricidad?
- prefiere recibir información en español o en otro idioma?

Queremos saber para que podamos brindarle el mejor servicio posible. Háganos saber en sdge.com/afn.



Do you or someone in your home:

- Have a disability
- Use a medical device that requires electricity
- Prefer to receive information in a language other than English?

We want to know so we can better serve you. Let us know at sdge.com/afn.

1.3 AFN Support Resources

In 2022, SDG&E continued its robust support services for individuals with AFN. SDG&E continues to identify organizations with quick response capacity that can meet the needs of customers across the region during PSPS activations. Though there were zero PSPS events in 2022, SDG&E maintained partnerships through continuing to share key objectives of roles and responsibilities.

Centralized Resource Hub (211)

SDG&E has extended its partnership with 211 San Diego and 211 Orange County into 2022 and has continued to expand and enhance that partnership as gaps and new opportunities are identified. 211 Orange County has modeled a Community Information Exchange after 211 San Diego as best practice and is in the process of sharing the new platform with stakeholder and training organizations within the network to leverage the new centralized platform.

Accessible Transportation (FACT)

SDG&E will continue partnering with Facilitating Access to Coordinated Transportation (FACT) and extended their contract to 2023 to provide accessible transportation to any individual with AFN across the entire HFTD during PSPS. There are no eligibility criteria other than an individual seeking assistance. FACT is available 7 days a week from 5:30am-11pm during PSPS and has been able to facilitate all requests for transportation that have come in to 211 and SDG&E since the initiation of the partnership in 2020.

No-Cost Hotel Stays (Salvation Army)

SDG&E continues to partner and enhance initiatives with Salvation Army to provide no-cost hotel stays to individuals with AFN during PSPS (as referred by 211 San Diego and 211 Orange County). These hotel stays are offered to any individual with AFN and are available for the duration of PSPS events.

Food Support (San Diego Food Bank, Feeding America, Meals on Wheels) SDG&E has strengthened the pipeline of local food resources for seniors, individuals, and families with AFN by partnering with the San Diego Food Bank, Feeding America, Meals on Wheels and other local food partners to support vulnerable, rural, and tribal communities year-round and during PSPS activations. Food support and gift cards are available for 2022.

For 2022, the San Diego Food Bank and Feeding America have mobile food pantries to support communities impacted by PSPS both with a rural and tribal focus. This is an area of continuous improvement, and SDG&E will explore additional vendors to include for food support.

Resiliency Items (CERTs, Regional Center, SCDD/American Red Cross)

As part of the 2022 shareholder grants SDG&E established a new partnership with the San Diego Seniors Community Foundation who provided emergency preparedness education at 20 senior facilities reaching over 500 seniors in the development of emergency preparedness plans. SDG&E supported the efforts

with AFN, PSPS and customer assistance flyers along with copies of the County OES Emergency Preparedness Guide for Individuals with Disabilities.

SDG&E is supporting the 2023 Prepare San Diego Regional Initiative through the American Red Cross. This campaign is designed to address the needs of individuals and families to prepare for disasters by providing tips, tools, and

training, and to promote community resiliency with a focus on San Diego's most vulnerable communities.

This funding will also support disaster preparedness and safety children's education programs, including the Pillowcase Project and Prepare with Pedro. The grant will additionally support the Be Red Cross Ready and Ready Rating training programs, which provide education to individuals connected with businesses and nonprofits. SDG&E's grant will also support the

installation of 2,000+ smoke alarms and the creation of more than 1,000 fire escape plans.

Access to Independence will continue to distribute emergency preparedness backpacks containing personalized items provided to people with significant disabilities that are deemed high-risk or that may have complex needs that require more than basic equipment to remain safe in a disaster. Items may include a crank flashlight/radio, pill box, thermal blanket, light stick and emergency drinking water pouches. Through personalized assessments, additional items may be provided including solar phone charger, small cooler or fridge, braille dot stickers and a Vial of Life.

1.4 Customer Resiliency Programs and Continuous Power Solutions

1.4.1 Back-Up Power

SDG&E offers several backup battery and generator programs to enhance resiliency for individuals, many of which are targeted to individuals with AFN during PSPS activations including no-cost and low-cost options.

1.4.2 Portable Battery Program (Generator Grant Program)

The Generator Grant Program (GGP) provides no-cost backup power units to Medical Baseline (MBL) and Life Support customers in the HFTD with a high likelihood of PSPS, and has expanded to include a broader audience of customers with AFN in the following categories:

- Individuals with disabilities
- Temperature-sensitive
- AFN self-identified

To date, approximately 4,000 customers have received batteries, with ~ 70% of the eligible population participating. Based on the 2021 customer satisfaction survey for this program, 98% of respondents reported they were “very” or “extremely” satisfied with their experience, and 94% reported they now feel “very” or “extremely” prepared for a future PSPS.

SDG&E is continuing its partnership with Indian Health Councils to support the direct distribution of backup power units to tribal communities in 2022 including reserved units. The program will also continue to deploy “emergency” backup power units to individuals with AFN who need them during PSPS activation and continue targeted outreach, including tribal communities that may be harder to reach.

1.4.3 Generator Rebate Program (Generator Assistance Program)

SDG&E’s Generator Assistance Program offers a rebate incentive for customers to prepare with back-up power sources. The program offers a \$300 rebate to customers who reside in the HFTD and have experienced a recent PSPS-related outage. In addition, the program targets the low-income segment with an enhanced rebate of \$450 for all CARE customers. This enhanced rebate is equivalent to a 70– 90% discount on the average portable generator models for lower-income customers. The 2022 program targets customers in the HFTD who

have experienced previous PSPS and includes enhanced rebates for low-income individuals with AFN on portable generators and portable power stations.

1.4.4 Resiliency Surveys

Throughout 2022, SDG&E continues to focus on enhancing the resiliency survey to streamline questions, highlight informative resources, provide guidance on

backup power and general safety preparedness during a PSPS, share collateral on external partner offerings, and describe how to locate the nearest Community Resource Center. The survey launched in Q3 2022 to all residential customers in

the HTFD, and additional promotion was included on SDG&E's AFN landing page

and in other AFN outreach opportunities.

Customers who respond to AFN-related questions will receive additional valuable information about SDG&E's support services and will be reminded to complete SDG&E's AFN Self-Identification webform.

1.5 Customer Assistance Programs

1.5.1 Medical Baseline Allowance Program (MBL)

The MBL allowance program provides an additional amount of gas and electricity at the lowest rates for residential customers. Customers with a qualifying medical condition that needs space heating or air conditioning, or using qualifying medical equipment may qualify. To apply for the Medical Baseline program, the applicant must complete an application and have the qualifying medical condition or use of qualifying medical equipment certified by a licensed Medical Doctor (M.D.), Doctor of Osteopathy (D.O.), Nurse Practitioner or Physician Assistant. The medical device must be for home use only.

As of December 2022, SDG&E had approximately 69,000 customers enrolled in the Medical Baseline Allowance program. A direct-mail campaign was executed in September and communications were sent to ~11,000 current MBL participants and ~25,000 additional customers who self-identified as AFN. The campaign recipients all reside in the HTFD, and the primary messaging of these communications encouraged recipients to update their contact information and to sign up for PSPS/outage notifications. AFN materials were also provided that included information about the Medical Baseline program for any eligible customers who have not enrolled.

1.5.2 California Alternate Rates for Energy Program (CARE)

The CARE program provides a 30% or greater discount on natural gas and electricity bills to low-income residents, non-profit group living facilities, and agricultural housing facilities. Customers must meet eligibility guidelines to qualify for the CARE program.

1.5.3 Family Electric Rate Assistance Program (FERA)

The FERA program provides qualified households with an 18% discount on electric usage every month. Households of 3 or more may qualify for the FERA program.

Household size and total household income guidelines apply.

1.5.4 Energy Savings Assistance Program (ESA)

The ESA program provides no-cost weatherization services to low-income households who meet the CARE income guidelines. Services provided include attic insulation, energy efficient refrigerators, energy efficient furnaces, weather stripping, caulking, low-flow showerheads, water heater blankets, and door and building envelope repairs which reduce air infiltration.

1.5.5 Low Income Energy Assistance Program (LIHEAP)

LIHEAP is federally funded and helps low-income households with weatherization services and one-time financial assistance to help balance an eligible household's utility bill. The program is overseen by the California Department of Community Services and Development (CSD) and administered by three local nonprofit agencies in SDG&E's service territory. SDG&E customers are referred to 211 San Diego (211sandiego.org) for information.

1.5.6 Arrearage Management Plan (AMP)

CARE customers may also be eligible for the AMP, which is a 12-month payment plan that forgives 1/12 of a participant's debt after each on-time payment of the current month's bill. After twelve on-time payments of their current month's bills, the participant's debt will be fully forgiven up to a maximum of \$8,000. Enrolled participants are protected from disconnection while participating.

1.5.7 Community Support

The Fire Service Training Institute, an AFN partner, will continue to receive grant support for the 2023 San Diego LISTOS program. Launched in 2019 by California Volunteers throughout San Diego County, the program targets underserved populations and is currently offered in 13 languages.

In 2023, the San Diego Regional Fire Foundation will receive SDG&E funding for all Fire Safe Councils (FSCs) in good standing to apply for a grant for pre-fire management and safety education in their community. FSCs know the unique challenges their community faces and implement projects such as hazardous fuel reduction programs, local wildlife protection planning, and homeowner training to ensure its protection.

SDG&E will also support the Youth EMT and Fire Tech Program, which supports EMT and Fire Tech training programs and biology/science curriculum courses at Health Sciences and Middle College, Lincoln High, and Mountain Empire High.

1.6 PSPS Preparedness Outreach and Community Engagement

1.6.1 AFN Collaborative Council (See Appendix B)

SDG&E participated in the AFN Collaborative Council meeting on November 16, 2022. The meeting goal was to provide a forum for the AFN executives and Joint IOU CEOs/leadership to convene for a progress update in advance of wildfire season.

Q4 Joint IOU/Access and Functional Needs Leadership Collaborative

Council Meeting Notes/Action Items

Meeting Goal: Solicit feedback from Collaborative Council on the revamped prepareforpowerdown website and provide status update on 2023 Access and Functional Needs Planning.

Action Items

- **Joint IOUs** to work alongside vendors to implement the feedback received from Collaborative Council into 2023 planning and website
- **Keadjian** to send out invites for 2023 quarterly meetings
- **K. Sloan and A. Carruthers** to meet in advance of Q1 2023 discussion to align on meeting topics and ensure effective use of AFN Collaborative Council time
- **Joint IOUs** to provide deeper dive into AFN metrics including identifying number of individuals in need and frequently impacted customers to aid in contact process

Meeting Summary

Provided updates on:

- 2023 Access and Functional Needs Plan timeline, bi-weekly working group meetings and next steps
- Progress to-date on various Access and Functional Needs-related metrics
- Medical Baseline Program renewal process

Demonstrated Prepareforpowerdown website revamp,

including:

- Higher level of accessibility for customers with Access and Functional Needs
- Explanation of Phase 1 (current status), Phase 2 (launch of public website) and Phase 3 (enhanced marketing campaign to drive traffic)

The following suggestions and questions were provided as focus areas for the Joint IOUs to consider and address before the next meeting:

- Prepare for powerdown website revamp:
 - Suggested including data that accurately details:
 - The need for battery-operated medical or assistive technology devices
 - How many battery-operated medical or assistive technology devices are being distributed on a yearly basis
 - How distribution and access to these devices can be improved
 - Revise the language of the website to be more accessible for customers, using simple language, and include a brief description of each program
 - Clearer call to action/header on the

homepage Provide additional testing with individuals who rely on screen readers

1.6.4 Tribal Communities

Tribal Research (online survey and focus-group sessions) were employed during Q2 to gauge PSPS support needs for the region. The online survey was sent to tribal first responders who partner with SDG&E during PSPS occurrences.

Outcomes of this effort include a PSPS resource card that is in production for community members and first responders on tribal lands. The focus groups were held with 13 Tribal Leaders where they shared their thoughts around improving collaborations with SDG&E. As an outcome of this research, we hoped to create a tribal advisory group; however, we found creating a group was too much of an ask due to the limited resources. Therefore, we will continue to have year-round listening sessions and participate in existing tribal working groups.

SDG&E will enhance tribal communications to include customized, culturally sensitive messaging and imagery used for public education and

outreach. An objective is to deepen tribal engagement by partnering with tribal councils and other tribal resources to develop a customized tribal communications and public education strategy that is meaningful and culturally appropriate.

SDG&E will provide small grants to the less resourced tribes to assist with disseminating information about low-income programs. Additional follow-up with tribes to submit financial documents has not resulted in any grant awards. SDG&E is looking at increasing the grant amount and to continue following up with the tribes.

SDG&E met with Southern Indian Health Council to find additional opportunities to reach low-income tribal community members. This resulted in a plan to add an SDG&E table at their Healthy Families events in 2023.

1.6.5 PSPS Working Group

SDG&E's PSPS Working Group (PSPSWG) includes representatives from small multi-jurisdictional electric utilities; CCAs; publicly owned electric utilities; communications providers; water service providers; the CPUC; tribes; local government entities; public safety partners; and agencies that serve community members with disabilities, aging, and access and functional needs (AFN) populations.

The PSPSWG met on the following dates in 2022 with these topics of focus:

- March 23rd, 2022: Notifications for Multifamily Dwellings and Property Managers, Critical Infrastructure Partnerships, and Tribal Outreach
- June 2nd, 2022: – Community Resource Centers Plan and Feedback, Notifications, and Accessible Communications
- September 21st, 2022: Wildfire Mitigation Updates, Meteorology Outlook, Generator Grant & Assistance Program
- December 7th, 2022: 2-1-1 Duty Officer Workflow Process, 2023 AFN Plan Statewide Objectives, and 2023 Regional PSPS Working Group Planning

In the December meeting we took the opportunity to seek feedback on the 2023 AFN Plan goals and objectives.

Tentative dates for the 2023 quarterly series have been set with the first meeting to occur in early Spring 2023.

1.7 AFN Public Education & Outreach

The AFN Public Education campaign continued through Q3. In addition to utilizing mainstream communication and outreach tactics, such as TV, radio, print, social media, mailers, community partners & CBO's, the campaign enlisted targeted communications including, but not limited to:

- Streaming radio
- Wildfire safety fairs and in-community events
- In-community newsletters and newspapers,
- Local community social media pages & Nextdoor
- In-community bulletins, community stores, supermarkets, laundromats, barber shops
- Airport, train and bus depot video message monitors

- Athletic event stadium ads,
- Eldercare directories and ethnic publications.

Digital advertising and social media were also targeted to HFTD. Campaign messaging promoted assistance offerings during PSPS to customers and the

general public with a focus on AFN, including assistance offered through SDG&E's 211 partnership and promoted through diverse communication channels. The Public Education campaign will continue through the end of the year and forecasted to achieve about 26 million impressions (or number of opportunities customers and the public have to view campaign tactics).

The following direct customer communications were issued in Q3

- Multi-family facility/AFN resiliency mailing – this campaign went to property managers, owners and residents of residential multi-family facilities and focus on PSPS preparedness and available resources;
 - Mobile Home Park/AFN resiliency mailing – directed to Mobile Home Park managers and residents and focus on PSPS preparedness and available resources;
 - AFN Self-Identified/MBL mailing – direct communications about PSPS preparedness and available resources sent to Medical Baseline participants and customers who self-identified as AFN.
 - Wildfire/PSPS Resiliency Survey – to all HFTD customers;
 - Wildfire/PSPS Safety Newsletter – to all HFTD (residential) customers;
 - Wildfire Safety/PSPS bill insert;
 - Generator Assistance Program; and
 - Generator Grant Program.

Tribal communication continued in Q3. SDG&E partnered with a tribal agency to customize communications in a manner that is culturally appropriate and meaningful for tribal communities. Development of a customized tribal webpage began in Q3 and will inform on gas and electric safety, wildfire/PSPS preparedness and resources available, along with other diverse energy related information.

Educational materials including but not limited to HFTD Wildfire/PSPS newsletter, AFN resource flyer, PSPS resource card and multiple fact sheets were customized for tribal outreach. These materials will be added to the tribal webpage and printed for outreach use.

Additionally, the HFTD newsletter, AFN resource flyer, and PSPS resource card will be available in the 21 prevalent languages spoken in the region. These materials will be added to sdge.com.

Additional communication refinements include:

SDG&E's no cost PSPS mobile application (Alerts by SDG&E) is now available entirely in Spanish, including PSPS updates and alerts. Additionally, SDG&E collaborated with C4AT to build a best-in-class accessible website and mobile app, also implementing an AudioEye tool.

1.7.1 Statewide Website for AFN Solutions

Prepareforpowerdown.com is a Joint IOU website, created as a centralized

resource for statewide CBO's and agencies serving individuals with AFN, providing easy access to IOU information on PSPS preparedness and resources. The website offers downloads, including the 2021 Joint IOU Medical Baseline flyer in 11 languages, the Joint IOU CBO training presentations, PSPS social media graphics and utility specific PSPS support materials.

In response to the AFN Collaborative Council's request for a Joint IOU centralized website, the IOU's established a working group in Q1 and began identifying enhancements for PrepareforPowerdown.com based on the feedback received.

The Joint IOU working group benchmarked with other organizations to look for both short and long-term solutions. In Q4, the IOUs worked with the web developing vendor to refresh the website for ease of navigation and accessibility. The IOU's provided a review of the website to the AFN Collaborative Council in Q4. The IOUs plan to further develop the website in 2023.

In addition, the Joint IOU working group is engaged with the Universal Application System (UAS)^(OBJ) working group that explored an Income Qualified UAS to understand the feasibility of developing a "one-stop shop", and how efforts made by the Joint Utilities Working Group and the Qualified UAS Working Group could be aligned. The UAS Report^(OBJ) recommends pursuing integrations for resiliency programs that help customers mitigate the impacts of PSPS once CARE, FERA, and ESA applications are successfully integrated. The Joint Utilities Working Groups will continue to seek opportunities to work with the Qualified UAS Working Group.

SDG&E's dedicated access and functional needs landing page will continue to provide resources to assist individuals with AFN, particularly for PSPS (sdge.com/AFN). The page provides extensive information and resource links which include notification sign-up, emergency plan/kit checklists, generator safety, the Medical Baseline program and application, CARE, FERA and ESA, as a representative sample of some of the information available to the viewer.

1.7.2 Accessibility of Communications

SDG&E has prioritized accessibility for its websites and mobile apps and began internal digital accessibility training across departments that create digital customer content. SDG&E has continued its focus on document accessibility. SDG&E has also increased the imagery in communications to be inclusive of people with assistive devices and disabilities.

In Q4 SDG&E expanded the Accessible Hazard Alert System (AHAS), to unplanned, non-PSPS outage customer notifications. Messages are texted and emailed to customers that include a URL for accessibility. The URL provides the message in a video format of an ASL Interpreter

signing the message, English voice, and the transcript of the message that is screen reader and braille refresh reader accessible. Also included on the AHAS site are preparedness videos that include closed captioning and the addition of an ASL Interpreter. These customer messages also include a link to access the message in all 21 prevalent languages.

1.7.3 Community Based Organization Outreach

SDG&E continued collaboration with its network of more than 200 community-based organizations (CBOs), known as its Energy Solutions Partner Network, to connect customers with programs and solutions related to Customer Assistance, Public Safety Power Shutoff resiliency, and wildfire preparedness. These organizations represent the diversity of SDG&E's customers with the majority being small, grassroots agencies serving customers with access and functional needs, including those that are multicultural, multilingual, low income, seniors, and Limited English Proficiency (LEP) audiences in communities of concern. These CBOs receive financial compensation and resources to help educate SDG&E customers utilizing a variety of tactics, including messaging through email and social media channels, posting information on their websites, and providing booth space at events.

SDG&E's Outreach team continues to expand its reach to customers with AFN providing ongoing education on Customer Assistance, Bill Debt Relief, PSPS and emergency preparedness programs and resources. As of the end of Q4, SDG&E in partnership with its network of CBOs, hosted nearly 360 events, 90 presentations, and has shared more than 5,100 social media messages to educate customers, particularly those with AFN, on available programs and resources related to these programs. Examples of these events include the Valley Center Fire Safety Expo, hosted by Valley Center Fire Department, the Jamul Community Safety Fair, hosted by the Jamul Fire Safe Council and the North County Fire Open House, hosted by North County Fire.

SDG&E provided presentations on PSPS preparedness and other customer resources to the San Diego Center for the Blind and Deaf Community Services. A webinar was also conducted with the San Diego Regional Center and State Council on Developmental Disabilities including ASL and Spanish interpreters. SDG&E presented at the Emergency Preparedness training for constituents of the State Council on Developmental Disabilities.

SDG&E recognizes there are additional opportunities to reach disabled and aging individuals with our preparedness and support services messaging. In November of 2022, SDG&E contracted with a local communications firm to advise on strategic channels and tactics to expand educational outreach to the AFN community.

1.7.4 Participation in Community Events

To further reach and support customers with AFN in the HFTD, SDG&E hosted a series of Wildfire Safety Fairs (WSF) throughout Q2 and Q3, to disseminate PSPS, CRC, and emergency preparedness information to its customers, including customers with AFN in key communities of concern.

At these WSFs, customers were able to visit SDG&E SMEs and our participating partners including, 211, American Red Cross, CalFire, and others to learn more about ways they can better prepare themselves and their loved ones for the unexpected loss of power due to

PSPS and other emergencies. In Q3, SDG&E wrapped up the series of four WSFs in Ramona, Alpine, Julian and Valley Center, which resulted in engaging with more than 2,200 residents in some of the most impacted PSPS communities.

In addition, SDG&E is continuing this year's newly launched initiative consisting of more than 45 mini-wildfire safety fairs, focusing on reaching AFN customers and engaging CBOs within SDG&E's Energy Solutions Partner network. These mini-wildfire fairs provide an opportunity to enhance coordination efforts with Fire Safe Councils, CERT Teams, Fire Departments, and Tribal Governments with a focus on educating and preparing customers for wildfires within rural communities, particularly those with AFN. Examples of CBOs that have supported this initiative include, Warner Springs Community Resource Center, Backcountry Communities Thriving and the Southern California Tribal Chairmen's Association (SCTCA). As of Q3, SDG&E has hosted a total of 35 mini-fairs reaching more than 1,600 customers, and additional fairs will continue to take place throughout the year focusing on impacted communities, while serving as a key channel to educate and prepare some of SDG&E's hardest-to-reach customers.

1.7.5 Collaboration with Partners and State Agencies

In Q4 the Joint IOUs provided a Medical Baseline presentation to the statewide regional centers. This was an interactive discussion between the IOUs and Regional Center representatives. In 2023 the Joint IOU's will continue to look for opportunities to partner with agencies including those in the Healthcare segment. PSPS support services, Medical Baseline and resiliency programs.

1.8 PSPS Activation (During – Emergency Operation Center Activated)

1.8.1 Communications During PSPS

Primary Information Channels

During a PSPS, SDG&E leverages more than 20+ diverse communication platforms, including but not limited to, SDG&E's PSPS page (sdge.com/Ready), SDG&E's NewsCenter, PSPS mobile app (Alerts by SDGE), social media, hyper-local targeting via the social media platform of NextDoor, radio PSAs, broadcast media including the emergency broadcast radio station (KOGO), in-community & roadside signage, including flyer distribution, message amplification by CBO's and partners, and direct customer notification via call, text and email. SDG&E is laser focused on using clearer, simplified language in delivering snackable sized messages that are quickly digested by customers and the public, especially during a PSPS.

SDG&E continuously audits the Wildfire Safety and PSPS webpages to simplify website content and provide additional information about a PSPS, what to expect and resources/offering available and where they are offered. Based on customer feedback, multiple informational videos have been developed with snackable size preparedness messages. Driven by customer feedback, in Q3 an animated PSPS video was made available to explain the PSPS customer journey beginning with the decision-making process through restoration (<https://www.youtube.com/watch?v=Sn0JYGpoldw>). This new tool will be promoted during PSPS activations through diverse communication platforms to help

customers understand what a PSPS is, why it's done, how to prepare and build resiliency, and what to expect through the various phases of the event.

Shared Customer Messaging

During Q4 SDG&E continued to collaborate with the other two IOUs to develop protocols and messaging for shared customers amongst the three utilities. SDG&E shares some customers that are served by Southern California Edison's (SCE) distribution system. During a PSPS that is initiated by SCE, SDG&E will notify affected customers and will refer them to SCE's website and other communication channels for the latest real time updates including AFN support.

1.8.2 PSPS Notifications

Based on customer feedback and notification message testing with customers prior to PSPS season, in Q3, customer notifications were streamlined and modified with clearer language regarding where updated information can be found and what type of information they will find.

24/7 notifications

Going into the peak PSPS season, SDG&E will no longer observe the traditional 'courtesy hours' of 9pm to 6am. Notifications will be sent to customers 24 hours a day as needed. This allows customers to receive the latest updates and obtain information on available AFN support.

1.8.3 Accessible Media Engagement

The accessibility of SDG&E's external web sites (SDGE.com, and SDGEnews.com) has been a priority, and comply with WCAG 2.1 AA guidelines. SDG&E has partnered with AudioEye to perform ongoing review to identify and correct new accessibility concerns that emerge. This system monitors what real users are doing and which parts of our websites they are visiting. Real-time Artificial Intelligence (AI) insights are gathered and remediations are performed. These remediations included defining headings, reading order, buttons, links, search field and more.

SDG&E's web development team is provided training, help desk support and accessibility resources throughout the year. Since these websites will be updated with new programs and current information, continuous monitoring, accessibility testing, discovery, remediation, and validation helps to keep these sites accessibility up to date. Implementation of updated web accessibility guidance, as it becomes available, is part of our accessibility strategy.

1.8.4 Community Resource Centers (CRCs)

SDG&E has 11 customer-owned facilities located within the HFTD to serve as CRCs during adverse weather events and 3 mobile units.

Customers at CRCs are provided:

- Bottled water Light snacks
- Cell phone charging Seating
- Accessible Restrooms Ice

- Water trucks (for large animals)
- Up-to-date outage event information

CRCs will also have charging stations, seating, and accessible restrooms available on-site. SDG&E endeavors to provide cellular network services and will collaborate with the telecommunication providers who support services in CRC areas.

SDG&E continues to coordinate with the CRC team on access and functional needs and with each CRC site-facility owner on Americans with Disabilities Act (ADA) compliance and has provided additional accessibility and safety items in “AFN Go Kits”. These Go Kits include items to mitigate trip hazards, communication aids, additional accessibility and directional signage, and materials to expand accessible parking and provide safe paratransit loading zones. Privacy screens are available to provide a secluded area for sensitive activities like administering medications, breastfeeding, a calming area for sensory disabilities and other needs.

Additionally, SDG&E has leveraged key takeaways from Cal OES’s Inclusive Planning Blueprint for Addressing Access and Functional Needs at Mass Testing/Vaccination Sites. SDG&E has implemented Video Remote Interpreting (VRI) resource and training to all CRC staff, allowing for complex conversations and information sharing in ASL and non-English languages. Each CRC will also have non-English visual translator boards for simple and casual conversations. SDG&E will ensure all CRC staff are familiar with possible reasonable accommodation requests and know to refer such requests to the EOC AFN Liaison Officer for solution support.

New in 2022, SDG&E plans to supplement priority medical device charging with the option to drop-off and pick-up items to be charged. SDG&E has expanded its CRC staffing pool to include a dedicated team of contract resources who will respond to CRC activations, along with SDG&E staff. More details about SDG&E’s CRCs, including siting and accessibility will be outlined in its forthcoming CRC plan as required by D.20-05-051.

1.9 Recovery (After - Power has Been Restored)

1.9.1 Customer Research and Feedback

SDG&E’s Pre-Season PSPS customer survey was issued in Q3 prior to peak response season. The survey was offered in the 22 languages prevalent within the SDG&E service territory. SDG&E has been utilizing customer opinion surveys to test PSPS messaging, and communications channels customers prefer.

The data collected from the surveys will be used to make real time adjustments, where appropriate, to public education and communications strategies to ensure PSPS communications continue to provide information to be most helpful to customers during a PSPS.

AFN Power Panel. The AFN Power Panel is a year-long, monthly survey, specifically for customers with AFN to serve as customer advocates for accessibility and accommodations. Topics include outage, communication, electric-powered device needs, and other areas of

interest that help SDG&E identify and refine accommodations. The sample size of the AFN Power Panel is currently small (n=~350), so results from these surveys should be interpreted with some caution.

Key results from the November AFN Power Panel survey:

- ~ 80% of respondents correctly identified the meaning of a Public Safety Power Shutoff.
- ~ 80% of respondents would access SDG&E online or call customer service if in need of PSPS Support Services.
- Of the PSPS Support Services listed, ~30% of respondents were most familiar with Emergency Backup Power and ~25% of respondents were familiar with Community Resource Centers. Over 50% of respondents selected unfamiliar with services.
- ~50% of respondents would need emergency backup power during a PSPS while ~34% of respondents would not require any of the PSPS support services.
- Within the last 3 months ~63% of respondents checked their SDG&E account contact information for accuracy.
- ~40% of respondents have downloaded and used the Alerts by SDG&E app for Public Safety Power Shutoff information.
- ~90 of respondents does not use assistive technology (examples included screen reader, refreshable braille display or text to speck software),

SDG&E will continue to adjust from customer insights as communications and services are implemented.

The results of SDG&E's Pre-Season PSPS customer survey were issued in Q3 prior to peak response season. The sample size was 680 respondents. Though all of the solicited information pertained to PSPS a portion was dedicated to AFN communications. Some of the key results include:

AFN households are more likely than non-AFN:

- To prefer communications in Spanish (non-English speaking is a qualifier for AFN)
- To feel SDG&E is working to make their community safe, helping

them to prepare for wildfire season and trusting that the utility acts in the best interest of customers

- Signed up for Medical Baseline Program (which is another qualifier for AFN)
- Visited a CRC
- Use the CRC Language Preference resource.

As there were no PSPS occurrences in SDG&E's territory, the PSPS Post-Season survey with customers affected by PSPS was not conducted. SDG&E plans to resume annual Pre- and Post-Season PSPS surveys during Q3 and Q4 of 2023.

**Appendix D: Census Tract Data for Generator & Back-up
Battery Programs**

SDG&E Generator Grant Program (GGP)

Census Tract	AFN	Life Support	Medical Baseline	2022 Total
83.35	0	5	1	6
95.04	0	1	5	6
155.01	1	0	0	1
155.02	0	7	1	8
168.02	2	0	1	3
169.01	2	16	14	32
169.02	5	5	8	18
170.10	2	3	0	5
170.20	1	1	1	3
170.21	5	3	8	16
170.30	0	1	3	4
170.32	2	0	5	7
170.40	0	1	0	1
170.42	0	0	1	1
170.50	0	0	1	1
171.06	2	0	0	2
171.08	0	0	1	1
171.10	4	17	5	26
186.11	3	12	4	19
188.01	1	4	4	9
188.02	4	7	6	17
189.03	1	12	10	23
189.04	1	3	0	4
189.06	2	2	0	4

Census Tract	AFN	Life Support	Medical Baseline	2022 Total
190.01	5	10	10	25
190.02	2	9	5	16
191.01	1	7	1	9
191.03	1	4	3	8
191.05	8	24	14	46
191.06	11	26	14	51
191.07	0	3	5	8
200.27	2	11	13	26
201.03	12	17	9	38
203.06	2	6	4	12
203.07	0	1	0	1
204.01	1	0	1	2
204.04	1	0	0	1
207.09	1	4	2	7
207.10	0	0	1	1
208.01	6	22	15	43
208.05	4	6	10	20
208.06	3	8	5	16
208.07	3	10	12	25
208.09	5	2	3	10
208.10	1	1	2	4
208.11	5	11	11	27
209.02	5	10	3	18
209.03	6	10	2	18
209.04	11	8	13	32
210.00	0	1	0	1

Census Tract	AFN	Life Support	Medical Baseline	2022 Total
211.00	21	22	13	56
212.02	7	6	10	23
212.04	3	18	17	38
212.05	8	8	17	33
212.06	2	6	8	16
213.02	13	18	14	45
213.03	3	14	12	29
213.04	1	5	3	9
215.00	0	0	1	1
Total	192	408	332	932

SDG&E Generator Assistance Program (GAP)

Census Tract	CARE Additional Rebate	Non-CARE Rebates	2022 Total
83.35	0	1	1
95.04	0	2	2
169.01	2	3	5
169.02	1	2	3
170.20	0	1	1
170.21	1	0	1
170.32	1	0	1
170.50	1	0	1
171.06	0	1	1
171.10	3	5	8
186.11	1	1	2
188.02	1	1	2
189.03	2	1	3
190.01	1	2	3
191.01	0	1	1
191.03	0	1	1
191.05	1	6	7
191.06	1	3	4
191.07	2	0	2
200.27	3	7	10
201.03	3	2	5
203.06	0	2	2
203.07	0	1	1
207.09	0	2	2

Census Tract	CARE Additional Rebate	Non-CARE Rebates	2022 Total
208.01	1	3	4
208.05	1	1	2
208.06	2	0	2
208.07	1	2	3
208.09	1	1	2
208.10	1	0	1
208.11	0	4	4
209.03	2	4	6
209.04	0	1	1
211.00	6	1	7
212.02	2	0	2
212.04	0	4	4
212.05	4	3	7
212.06	1	3	4
213.02	4	8	12
213.03	3	2	5
213.04	0	4	4
215.00	1	0	1
Total	54	86	140

Appendix E: Survey Results and Metrics

2022 SDG&E PSPS Public Education & Communications Study

Research Results | October 2022

Prepared for:



Prepared by:



www.travisresearch.com

22-115 Pre
10/25/22

Research Design



Methodology

- Telephone and online surveys employed
- Offered in English and 22 other languages
- Field period 8/28 – 10/3
- SDG&E identified as the sponsor of the research
- Incentive (Online only)
 - Residential – Drawing for one of ten \$100 Amazon gift cards
 - Due to low participation rates, this was changed to each receiving a \$10 gift card
 - Small Business – Each receives a \$50 Amazon gift card



Sample & Quota

- SDG&E provided sample of customers (residential and small business) in High Fire Threat Districts (HFTD) and Non-HFTD (including all contact information)
- Languages, other than English, are flagged in the sample
- Total of 900 completes were targeted, but only 680 achieved
 - This was due to lower than anticipated participation rates and limited sample



Respondent Screening

- Respondents screened to ensure:
 - Current SDG&E customer
 - Age 18+
 - Adult head of household (residential)
 - Reviews utility bills or communications (business)
 - Not employed in a sensitive industry

Analytical notes: Due to an extremely small base size (n=8), the “Other Language” sub-group was not statistically analyzed and only respondent counts (not percentages) are shown. For clarity, statistical comparisons between sub-groups are only noted for this 2022 wave.



Executive Summary

Languages



- Compared to the previous wave, a smaller proportion of respondents elected to take the survey in a language other than English or Spanish.
- Spanish is the most prevalent non-English language spoken (15% spoken often), followed by several other languages (each 2% or less).
- Non-HFTD customers are more likely than HFTD to speak/prefer Spanish.
- Among those who prefer receiving their communications in Spanish, roughly a quarter indicate they are unable to understand English.
- This wave, only a few respondents (n=8) indicate they would like to receive wildfire communications in a language other than English or Spanish.

Favorability



- The majority (56%) are favorable towards SDG&E overall, statistically consistent with last wave.
- Those who prefer Spanish provide higher favorability scores than do English.
 - Spanish-language respondents (as well as Hispanics in general) tend to be more positive than are those who prefer English.
- The proportion who feel SDG&E provides reliable service has declined this wave (83% → 78%).
- Satisfaction with SDG&E wildfire safety efforts (64%) is statistically unchanged; and perceptions of the PSPS program overall have improved significantly (62% → 68%).
 - There has been an upward trend for the last two years.
- Wildfire performance ratings remain consistent, except for one attribute, “Is helping me prepare for wildfire season,” increasing from last

wave
(52% →
58%).

Executive Summary (continued)

has increased substantially (13% → 22%).



Awareness

- Awareness of wildfire communications has improved significantly this wave (58% → 70%).
 - The increase is statistically significant among English language and directional among Spanish.
- Those aware of SDG&E wildfire communications are more positive about SDG&E overall, its wildfire efforts and the PSPS program than are their unaware counterparts.
- More than half of those who prefer Spanish and are aware of SDG&E communications say they received the information in Spanish.
- The vast majority say communications came direct from SDG&E, which increased significantly this wave (with substantial jumps in direct mail and text).
 - Most consider the information useful, whether provided in English or their preferred language.
- Nearly all who used SDG&E.com as a source of information are satisfied with the website.
- Awareness of the PSPS program has increased significantly this wave (67% → 74%), reaching a new all-time high.
 - However, Caucasians are more likely than Hispanics to be aware of the program (79% vs. 67%).
- The proportion who say they learned of PSPS from a letter in the mail from SDG&E

PSPS Preparedness & Resources

- A solid majority (68%) feel they are at least somewhat prepared for a PSPS event.
 - Feeling prepared has increased significantly among those preferring English, and directionally among their Spanish-language counterparts.
- There is also a significant increase in most of the actions being taken to prepare.
 - This is driven by both English and Spanish language-preferred respondents.
- The proportion of those preferring Spanish that signed up for notifications from SDG&E has more than doubled.
 - However, they lag those who prefer English by a significant margin.
- Address level alerts, CRCs and PSPS alert language preference are the most known resources.
 - Those preferring Spanish language are more aware of CRC language preference than are their English counterparts.
- Address level alerts are also the most-used resource (14%).
- Overall, customers prefer to receive notifications by text rather than email or a phone call.



Executive Summary (continued)

5

Non-HFTD vs. HFTD



- Demographically, Non-HFTD customers are more likely than HFTD to:
 - Rent rather than own
 - Be female
 - Be Hispanic or Asian
 - Have lower income.
- Non-HFTD are more likely than HFTD to feel that SDG&E provides reliable service (84% vs. 75%).
- Ratings have improved among HFTD customers regarding the PSPS program overall and that the utility is making an effort to communicate with all customers, helping them to prepare for wildfire season.
- Awareness of wildfire communications has increased significantly among HFTD customers (63% → 79%).
 - HFTD customers are more likely than Non-HFTD to get communications direct from SDG&E and less likely to receive it through mass communications.
- HFTD customers are also more aware of the PSPS program than are Non-HFTD (77% vs. 69%).
 - HFTD are also comparatively more likely to learn about PSPS via direct mail (which has increased from the previous wave) from SDG&E.
- Non-HFTD feel more prepared this wave than last (54% → 67%).
- The number of actions taken to prepare has increased for both segments, but especially HFTD.

Executive Summary (continued)



AFN vs. Non-AFN Households

- **AFN households are more likely than Non-AFN:**
 - To prefer communications in Spanish (non-English speaking is a qualifier for AFN)
 - To feel SDG&E is working to make their community safe, helping them to prepare for wildfire season and trusting that the utility acts in the best interest of customers
 - Signed up for Medical Baseline Program (which is another qualifier for AFN)
 - Visited a CRC
 - Use the CRC Language Preference resource.
- **AFN and Non-AFN are similar in their:**
 - Favorability towards SDG&E and feel they provide reliable service
 - Awareness of wildfire communications and of PSPS
 - Satisfaction with SDG&E wildfire efforts and the PSPS program
 - Level of feeling prepared for a PSPS event
 - Awareness of SDG&E PSPS resources.



Small Business

- Only 18 small business customers completed the survey this wave, so findings should be considered directional rather than projectable to the overall segment.
- Over half (56%) are favorable towards SDG&E and 61% feel the utility provides reliable service.
- Just over half (56%) are satisfied with SDG&E wildfire efforts, with two-thirds aware of the utility's wildfire communications.
- A solid majority (72%) are aware of the PSPS program and feel they are at least somewhat prepared for an event (83%).
- Two-thirds have a positive overall opinion about the PSPS program.

Conclusions + Potential Implications

Conclusions

Potential Implications

- For this group of respondents, English and Spanish will cover 99% of preferred languages.



- Ensure all communications are offered in English and Spanish.
- Possibly include other languages on SDG&E.com.

- There is opportunity for SDG&E to improve in terms of favorability and being perceived as providing reliable service.
- Perceptions of SDG&E’s wildfire efforts also have room for improvement.
- Those aware of SDG&E wildfire communications tend to have a more positive opinion of SDG&E than do those unaware.



- Helping people prepare for wildfire season sends a message that SDG&E cares about its customers.
- Do not cut back on wildfire communications, and consider expanding to both HFTD and Non-HFTD customers.
- To be cost efficient, use direct marketing to HFTD and more mass marketing to Non-HFTD.

- Perceptions of the PSPS program continue to improve.

- This improvement is especially recognized by HFTD customers.

- **Promote the program and its benefits to all customers.**



- **Include success stories as well as potentially including customer testimonies of the program.**

- **Awareness of wildfire communications and the PSPS program continue to improve.**
 - **However, those preferring Spanish language continue to lag behind English language in terms of awareness.**



- **Keep up the good work.**
- **Make a concerted effort to increase awareness among Hispanics.**
 - **Include information helpful to renters.**

Conclusions + Potential Implications (continued)

Conclusions

- Taking action to prepare for a PSPS event is improving among all segments.
 - However, even though they are improving, Spanish language also lag English here.



Potential Implications

- Consider increasing mass communications targeted specifically to Hispanics.
 - Include the benefits of signing up for SDG&E notifications.

- Many do not know about SDG&E PSPS event resources.



- Increase promotions regarding these resources.
- Ensure lower income customers learn about these...possibly through community-based organizations.

- AFN customers appear to have similar attitudes as Non-AFN regarding SDG&E and wildfire/PSPS communications.
 - In some respects, AFN are even more positive than are their counterparts.



- When sending communications, especially regarding SDG&E PSPS event resources, continue to ensure that the message and benefits “speak” to AFN customers.



2022 SDG&E PSPS Public Education & Communications Study | Research Results