



Gary Chen
Director, Safety & Infrastructure Policy
gary.chen@sce.com

October 26, 2023

Lucy Morgans
Program Manager, Electric Safety Policy Division
Office of Energy Infrastructure Safety
715 P Street, 20th Floor
Sacramento, CA 95814

SUBJECT: Version Update to SCE's 2023-2025 Wildfire Mitigation Plan

Dear Program Manager Morgans:

Pursuant to Section 4.3 of the 2023-2025 WMP Process and Evaluation Guidelines, SCE is submitting an updated version of its 2023-2025 Wildfire Mitigation Plan.

This version reflects the following errata and corrections:

- SCE's errata submitted to OEIS on April 6, 2023
- SCE's errata submitted to OEIS on April 26, 2023
- SCE's errata submitted to OEIS on August 14, 2023
- Additional corrections requested by OEIS on September 28, 2023

SCE's WMP and associated materials, including the errata submissions noted above, are available at: <https://www.sce.com/safety/wild-fire-mitigation>.

Sincerely,

//s//

Gary Chen
Director, Safety & Infrastructure Policy
gary.chen@sce.com

2023-2025 WILDFIRE MITIGATION PLAN

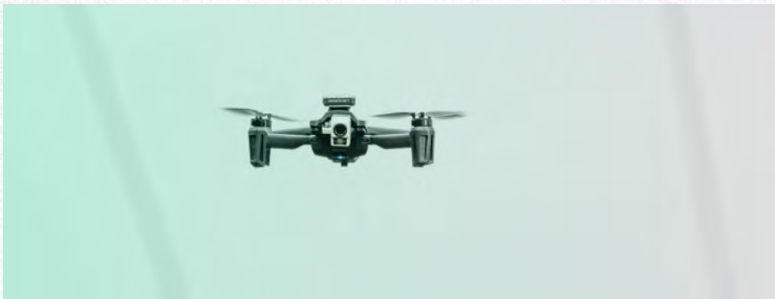

Docket: 2023 to 2025 Electrical Corporation Wildfire Mitigation Plans Docket#: 2023-2025-WMPs

October 26, 2023



Table of Contents

1	Executive Summary	1
1.1	Summary of the 2020-2022 WMP Cycle	1
1.2	Summary of the 2023-2025 Base WMP	4
1.2.1	Risk Methodology and Assessment: Advancements in Risk Modeling Capabilities Will Allow for More Robust Evaluation of Mitigations at Specific Locations of the Grid	5
1.2.2	Grid Design, Operations and Maintenance: Expanded Measures Are Expected to Further Reduce Wildfire Risk from Overhead Electric Systems	6
1.2.3	Vegetation Management and Inspections: An Improved Risk-Informed Vegetation Management Framework to Increase Efficiency and Enable Advanced Analytics	7
1.2.4	Situational Awareness and Forecasting: Additional High-Definition Wildfire Cameras, Weather Stations, Satellite Imagery and Advanced Technology Will Boost Capabilities	7
1.2.5	Emergency Preparedness: Trained Workforce Is Ready to Restore Power and Assist Customers; Aerial Suppression Resources Continue to Support Fire Agencies	7
1.2.6	Community Outreach and Engagement: Strong Partnerships Increase Outreach to Access and Functional Needs (AFN) Customer Groups	8
1.2.7	Public Safety Power Shutoff: SCE Continues Its Goal to Reduce PSPS Impacts with Urgency ..	8
1.2.8	SCE Continues to Advance Its Wildfire Capability Maturity	9
1.2.9	Conclusion	9
2	Responsible Persons	10
3	Statutory Requirements Checklist.....	13
4	Overview of WMP	20
4.1	Primary Goal.....	20
4.2	Plan Objectives	20
4.3	Proposed Expenditures.....	21
4.4	Risk-Informed Framework.....	23
4.4.1	SCE’s Risk-Informed Framework	25
4.4.2	Evolution of SCE’s Wildfire and PSPS Risk Modeling.....	26
4.4.3	Adherence to Risk-Informed Framework.....	28
5	Overview of the Service Territory	30
5.1	Service Territory	30
5.2	Electrical Infrastructure	32
5.3	Environmental Settings.....	33
5.3.1	Fire Ecology	33
5.3.2	Catastrophic Wildfire History.....	44
5.3.3	High Fire Threat Districts.....	51

5.3.4	Climate Change.....	53
5.3.5	Topography	65
5.4	Community Values at Risk.....	67
5.4.1	Urban, Rural, and Highly Rural Customers	67
5.4.2	Wildland-Urban Interfaces	69
5.4.3	Communities at Risk from Wildfire	71
5.4.4	Critical Facilities and Infrastructure at Risk from Wildfire	80
5.4.5	Environmental Compliance and Permitting	83
6	Risk Methodology and Assessment.....	89
6.1	Methodology	90
6.1.1	Overview.....	90
6.1.2	Summary of Risk Models	90
6.2	Risk Analysis Framework.....	94
6.2.1	Risk and Risk Component Identification	95
6.2.2	Risk and Risk Components Calculation	122
6.2.3	Key Assumptions and Limitations	138
6.3	Risk Scenarios	149
6.3.1	Design Basis Scenarios.....	149
6.3.2	Extreme-Event/High Uncertainty Scenarios	154
6.4	Risk Analysis Results and Presentation	158
6.4.1	Top Risk Areas Within the HFRA	158
6.4.2	Top Risk-Contributing Circuits/Segments/Spans.....	162
6.4.3	Other Key Metrics.....	164
6.5	Enterprise System for Risk Assessment.....	166
6.5.1	Database(s) Used for Storage of Its Risk Assessment Data	167
6.5.2	Documentation of Its database(s).....	168
6.5.3	Integration with Systems In Other Lines of Business	169
6.5.4	Internal Procedures for Updating the Enterprise System Including Database(s)	169
6.5.5	Any Changes to the Initiative Since the Last WMP Submission	169
6.6	Quality Assurance and Control.....	169
6.6.1	Independent Review.....	170
6.6.2	Model Controls, Design, and Review	172
6.7	Risk Assessment Improvement Plan	174
6.7.1	Overview.....	174
6.7.2	Narratives for Individual Improvements	177
6.7.3	Maturity Advancement	180
7	Wildfire Mitigation Strategy Development	181

7.1	Risk Evaluation	181
7.1.1	Approach	181
7.1.2	Key Stakeholders for Decision Making	184
7.1.3	Risk-Informed Prioritization	188
7.1.4	Mitigation Selection Process	190
7.2	Wildfire Mitigation Strategy	215
7.2.1	Overview of Mitigation Initiatives and Activities	215
7.2.2	Anticipated Risk Reduction	221
7.2.3	Interim Mitigation Initiatives	228
8	Wildfire Mitigations	230
8.1	Grid Design, Operations, and Maintenance	230
8.1.1	Overview	230
8.1.2	Grid Design and System Hardening	250
8.1.3	Asset Inspections	279
8.1.4	Equipment Maintenance and Repair	313
8.1.5	Asset Management and Inspection Enterprise System(s)	319
8.1.6	Quality Assurance and Quality Control	325
8.1.7	Open Work Orders	327
8.1.8	Grid Operations and Procedures	331
8.1.9	Workforce Planning	341
8.1.10	Maturity Advancement	373
8.2	Vegetation Management and Inspections	374
8.2.1	Overview	374
8.2.2	Vegetation Management Inspections	384
8.2.3	Vegetation and Fuels Management	407
8.2.4	Vegetation Management Enterprise System (Arbora)	426
8.2.5	Quality Assurance and Quality Control	428
8.2.6	Open Work Orders	432
8.2.7	Workforce Planning	437
8.2.8	Maturity Advancement	444
8.3	Situational Awareness and Forecasting	445
8.3.1	Overview	445
8.3.2	Environmental Monitoring Systems	453
8.3.3	Grid Monitoring Systems	467
8.3.4	Ignition Detection Systems	490
8.3.5	Weather Forecasting	499
8.3.6	Fire Potential Index	512

8.3.7	Maturity Advancement	516
8.4	Emergency Preparedness	518
8.4.1	Overview	518
8.4.2	Emergency Preparedness Plan.....	529
8.4.3	External Collaboration and Coordination	550
8.4.4	Public Emergency Communication Strategy	558
8.4.5	Preparedness and Planning for Service Restoration	564
8.4.6	Customer Support in Wildfire and PSPS Emergencies	570
8.5	Community Outreach and Engagement.....	574
8.5.1	Overview.....	574
8.5.2	Public Outreach and Education Awareness Program	583
8.5.3	Engagement with Access and Functional Needs Populations.....	601
8.5.4	Collaboration on Local Wildfire Mitigation Planning	603
8.5.5	Best Practice Sharing with Other Electrical Corporations.....	606
8.5.6	Maturity Advancement	609
9	Public Safety Power Shutoff	610
9.1	Overview	610
9.1.1	Key PSPS Statistics	610
9.1.2	Identification of Frequently De-energized Circuits	611
9.1.3	Objectives	614
9.1.4	Targets	617
9.1.5	Performance Metrics Identified by the Electrical Corporation.....	620
9.2	Protocols on PSPS.....	623
9.3	Communication Strategy for PSPS	633
9.4	Key Personnel, Qualifications, and Training for PSPS.....	633
9.5	Planning and Allocation of Resources for Service Restoration due to PSPS	633
10	Lessons Learned	635
11	Corrective Action Program	650
12	Notices of Violation and Defect	658
	Appendix A: Definitions.....	660
	Appendix B: Supporting Documentation for Risk Methodology and Assessment	689
	Appendix C: Additional Maps	722
	Appendix D: Areas for Continued Improvement	735
	SCE-22-01 Prioritized List of Wildfire Risks and Drivers.....	735
	SCE-22-02 Collaboration and Research in Best Practices in Relation to Climate Change Impacts and Wildfire Risk & Consequence Modeling	736
	SCE-22-03 Three-Year Objectives and Supporting Programs' Performance Targets.....	737

SCE-22-04 Inclusion of Community Vulnerability in Consequence Modeling	738
SCE-22-05 Fire Suppression Considerations	739
SCE-22-06 Ignition Risk Reduction	740
SCE-22-07 Wildfire Consequence Modeling Improvements.....	743
SCE-22-08 Weather Station Improvements	744
SCE-22-09 Joint Covered Conductor Lessons Learned.....	745
SCE-22-10 Covered Conductor Inspection and Maintenance.....	748
SCE-22-11 New Technologies Evaluation and Implementation.....	749
SCE-22-12 Residual Risk Reduction Associated with Covered Conductor	750
SCE-22-13 Remaining Severe Risk Areas.....	752
SCE-22-14 Evaluation of Vibration Dampers.....	754
SCE-22-15 Targets Relating to Addressing Inspection Findings	756
SCE-22-16 Increases in Equipment Related Ignitions	762
SCE-22-17 Address Secondary Conductor Issues.....	764
SCE-22-18 Progression of Joint Effectiveness of Enhanced Clearances Study.....	767
SCE-22-19 Participation in Vegetation Management Best Management Practices Scoping Meeting .	776
SCE-22-20 Protective Device Settings Sensitivity Impacts	777
SCE-22-21 Documentation of Models.....	779
SCE-22-22 Third Party Confirmation of RSE Estimates	780
SCE-22-23 RSE Estimates of Emerging Initiatives.....	781
SCE-22-24 RSE Estimates Used for Capital Allocation.....	782
SCE-22-25 Increasing PSPS Thresholds on Hardened Circuits	784
SCE-22-26 PSPS System Damage in Consequence Modeling.....	787
SCE-22-27 Lessons Learned from PSPS Implementation	788
Appendix E: Referenced Regulations, Codes, and Standards.....	791
Appendix F: Supplemental Information	797
F1: Continuation of Section 5 - Overview of Service Territory	797
F2: Continuation of Section 7 - Wildfire Mitigation Strategy Development.....	824
F3: Continuation of Section 8.4 - Emergency Preparedness.....	849
F4: Continuation of Section 8.5 – Community Outreach and Engagement.....	852
F5: Continuation of Section 9 - PSPS.....	859
F6: Acronym Dictionary.....	870
F7: Joint IOU Covered Conductor Working Report	879

1 EXECUTIVE SUMMARY

SCE is dedicated to the safety of our customers and the communities we serve. Our 2020-2022 Wildfire Mitigation Plan (WMP) was a comprehensive blueprint to address wildfire risk and Public Safety Power Shutoff (PSPS) impacts in SCE's service area and was developed with the input of our regulators, public safety partners, local governments, community groups, fellow electrical corporations, and other stakeholders. The execution of our 2020-2022 WMP helped make meaningful progress in reducing a large portion of wildfire risk and PSPS impacts on our system. Our 2023-2025 WMP builds upon our accomplishments and lessons learned from the 2020-2022 WMP to maintain the risk reduction achieved to date and is intended to further reduce the significant wildfire risk and PSPS impacts that remain. Below, SCE describes our past successes and path forward.

1.1 Summary of the 2020-2022 WMP Cycle

California has experienced extreme drought conditions during the past three years, which have — along with exceedingly low fuel moisture, high temperatures and very strong wind gusts — increased the unmitigated risk for ignition and spread of wildfires.¹ The California Department of Forestry and Fire Protection's (CAL FIRE) data indicates that nearly half of the 20 largest wildfires since 1932 have occurred in the past three years, including the single- largest fire.² In October 2021, Governor Gavin Newsom declared a drought emergency across California, stating that August 2021 was the driest and hottest August on record since the state began reporting data.³ In August 2022, Governor Newsom declared a state of emergency for an extreme heat event, where temperatures exceeded 110 degrees in some areas.⁴

SCE's 2020-2022 WMP set forth a comprehensive set of initiatives designed specifically to mitigate wildfire and PSPS risk in the face of these dire circumstances. While we were already implementing myriad wildfire mitigation initiatives in the years before 2020, over the 2020-2022 WMP period we made even more progress in hardening our system and improving our capabilities in risk and weather modeling, asset inspections, vegetation management, situational awareness and community outreach.

We achieved 136 of the 147 (~93%) annual goals in the years they were established and completed nearly all the remaining goals within the 2020-2022 WMP period, resulting in significant reductions to wildfire and PSPS risk. Table SCE 1-01 below highlights the progress made in deploying wildfire and PSPS mitigation activities in the 2020-2022 WMP timeframe.

¹ Despite the recent precipitation, much of California remains in moderate, and in some areas, severe drought conditions. The concentrated rainfall is also expected to increase brush growth which may lead to a heightened fire risk later in the year.

² https://www.fire.ca.gov/media/4jandlhh/top20_acres.pdf Nine of the 20 largest wildfires happened in 2020-2021.

³ <https://www.gov.ca.gov/2021/10/19/governor-newsom-expands-drought-emergency-statewide-urges-californians-to-redouble-water-conservation-efforts>.

⁴ <https://www.gov.ca.gov/wp-content/uploads/2022/08/8.31.22-Heat-Proclamation.pdf?emrc=78e3fc>.

Table SCE 1-01 - Summary of 2020-2022 WMP Achievements

Initiative	Achievements in 2020-2022
Covered Conductor	Installed more than 3,880 circuit miles, bringing total covered conductor miles installed to nearly 4,400, or over 44% of SCE’s HFRA
Undergrounding	Completed more than 19 miles
High Fire Risk Inspections and Remediations	Completed approximately 541,400 distribution and 73,600 transmission structure inspections in High Fire Risk Area (HFRA), including areas of concern, using an approach that now inspects transmission and distribution structures that represent up to 99% of risk each year; performed repairs and replacements
Vegetation Management	Maintained line clearances; completed hazard tree assessments on more than 1,325 circuits and performed 21,000 hazard tree mitigations — and marked the substantial completion of one full pass of SCE’s service area for conducting hazard assessments; cleared brush at the base of more than 502,400 poles
Public Safety Power Shutoff	Developed circuit-specific mitigation plans including deploying grid hardening measures on over 140 circuits, further advanced risk modeling to inform FPI thresholds, enhanced customer notification processes and developed a portfolio of customer care offerings
Weather Stations	Installed more than 1,150 weather stations, resulting in more than 1,620 weather stations installed across our HFRA; expanded artificial intelligence/machine learning (AI/ML) capabilities for improved forecasting
High-Definition Cameras	Installed 21 HD cameras, resulting in a total of more than 180 HD cameras installed across our service area since inception; this represents approximately 90% coverage of our HFRA
Sectionalizing Devices	Installed more than 80 devices, resulting in a total of more than 150 devices installed since this wildfire program’s inception, adding to SCE existing portfolio of remote sectionalization devices.
Fast-Acting, Current-Limiting Fuses	Installed/replaced fusing at more than 3,740 fuse locations, resulting in fusing installed/replaced at more than 13,700 fuse locations on the grid since program inception
Customer Resiliency Programs	Delivered more than 10,200 Critical Care Backup Batteries to medical baseline customers and introduced in-event battery loan pilot; developed targeted programs to support critical care Medical Baseline customers, Access & Functional Needs (AFN) customers and communities frequently impacted by PSPS

Because of these efforts, SCE has reduced wildfire risk significantly. SCE has used the performance of these and associated metrics to help inform the development of this 2023-2025 plan. When compared to the 2017-2018 period, the number of acres burned and structures destroyed in 2021-2022 were 92%

and 98% lower, respectively, despite continued extreme drought and wind conditions.⁵ Further, there have not been any fires associated with covered conductor caused by risk drivers that covered conductor was designed to directly address. We have also seen approximately 53% less tree-caused electrical faults⁶ and a decrease of 61% in asset conditions found from inspections that require remediation, even with updating the inspection form to include additional items and conditions to inspect for.⁷ However, a significant portion of our HFRA still remains unhardened where ignitions can endanger communities due to limited egress or where fires can spread rapidly and widely.

PSPS has proven to be an effective measure of last resort to reduce the risk of wildfires. Our post-event patrols from 2018-2022 found approximately 90 incidents of wind-related damage on lines de-energized during PSPS events that potentially could have caused ignitions. There were likely many more potential incidents prevented that could not be observed after the events (e.g., objects hitting the line and falling to the ground). And although SCE uses PSPS judiciously, we recognize the impact de-energizations have on our customers. As such, we have made substantial progress in our PSPS risk mitigation, with customer minutes of interruption (CMI), customer outages and circuit de-energizations dropping by over 70% from 2020-2022.⁸

Each year, we incorporated lessons learned from our fire investigations into our Wildfire Mitigation Plan. For example, when we learned that asset deterioration is not always fully observable from the ground, we supplemented our ground inspections with aerial inspections. As another example, analysis showed that one risk factor is long spans in between poles where wires could clash with each other. As such, we implemented our long span initiative to install components that reduce the chances of wire clash. Finally, when detailed analysis of ignition events showed an increase in fires started by secondary wires, we enhanced our inspections process to look specifically for those issues.

Each year, we also continuously improved our existing wildfire mitigation capabilities and strategy. For example, we refined our risk analysis to pay special attention to specific areas where traditional fire science did not fully capture risk, such as areas with heightened chances of fires driven by dry fuel and areas where limited egress or certain terrain conditions would exacerbate the consequences of a wildfire. Similarly, we refined our prioritization of grid hardening, asset inspections and vegetation management activities in alignment with our refined risk analysis. We also revisited and refreshed our protection device settings during elevated fire conditions to further reduce wildfire risk while balancing customer reliability impacts. As we scaled out our deployment of covered conductor, our cornerstone mitigation to buy down the most risk in the shortest amount of time, we also started to execute limited, targeted undergrounding to minimize to the extent practicable the risk of wildfire from those facilities. And to pave the way for the future of wildfire mitigations, we tested new technologies like Early Fault Detection (EFD) and Rapid Earth Fault Current Limiter (REFCL). We established innovative partnerships with local fire agencies to provide aerial suppression resources to limit consequences from ignitions. To limit the impacts of PSPS when it must be used, we upgraded our grid to minimize the number of customers affected and the length of each event and designed new programs to reduce the impacts to

⁵ Even when using a conservative three-year rolling average, there has been a 66% and 92% reduction in acres burned and structures damaged, respectively, since 2018 despite continued extreme drought and wind conditions.

⁶ Measured by three-year moving average in HFTD.

⁷ Measured as Total Defect Find Rate of Top Ignition Drivers (percentage of inspections) in 2022 as compared to 2019 (inception of program) for structures inspected every year.

⁸ Non-weather-normalized outcomes.

customers. Finally, we expanded our partnerships with local, state and federal agencies to enhance emergency preparedness, community engagement and the execution of our wildfire mitigation plan.

1.2 Summary of the 2023-2025 Base WMP

Goal: The primary goal of our WMP is to reduce the risk of wildfires associated with utility equipment and to reduce the scope, scale, frequency and impacts of PSPS events.

Objectives: To accomplish this goal, we have established three- and 10-year objectives for our 2023-2025 WMP that are summarized as follows:

- Reduce the likelihood that objects will contact power lines and lead to an ignition by hardening the majority of the overhead distribution system in our high fire risk area with either covered conductor (and other mitigations) or targeted undergrounding, developing an expanded transmission grid hardening strategy and continuing to maintain vegetation clearance distances for trees and vegetation that could potentially contact power lines.
- Reduce the likelihood that equipment will fail and lead to an ignition by continuing to perform asset inspection initiatives that inspect over 99% of wildfire risk in our HFRA each year and by deploying new technologies that can detect when issues on the system may arise.
- Prioritize the deployment of our mitigation initiatives to the areas that have the greatest potential to lead to the most consequential wildfire and PSPS impacts.
- Improve the efficiency and effectiveness of our vegetation management activities to reduce the risk of vegetation-caused ignitions.
- Improve the operational efficiency and effectiveness of our wildfire mitigation initiatives by enhancing program deployment strategies, leveraging information technology solutions and incorporating new technologies where possible.
- Continue to improve our situational awareness capabilities by enhancing weather and fire potential modeling and forecasting, which will aid PSPS decisions and wildfire mitigation deployment.
- Reduce the impacts of PSPS to customers, particularly those with Access and Functional Needs, through expanded customer offerings, communications and circuit-specific strategies to minimize the need for PSPS altogether.
- Maintain a comprehensive, all-hazards planning and preparedness program to: provide effective emergency response; safely and expeditiously restore service during and after a major event; and communicate effectively with customers, stakeholders and agency partners.
- Deploy new technologies and updated protection device settings to improve wildfire mitigation effectiveness while balancing reliability impacts to customers.

Framework: This WMP represents the continuous refinement, expansion and improvement in our wildfire and PSPS mitigation efforts. While many of the foundational initiatives SCE deployed over the

2020-2022 period continue into this WMP cycle, we are incorporating improvements and lessons learned into our 2023-2025 plan. Importantly, we'll continue to execute on our Integrated Wildfire Mitigation Strategy (IWMS), which further aligns grid hardening, inspections and vegetation management activities. This will reduce the risk of catastrophic wildfire by targeting locations that have historically experienced a high frequency of fires and have limited road availability for quick evacuation, are expected to experience wind and fuel conditions that exceed PSPS thresholds even after covered conductor deployment and where fire spread can be rapid and large.⁹ IWMS stratifies our HFRA based on potential customer and community impacts into three tranches of risk areas: (1) Severe Risk Areas, which represent locations with the highest risks; (2) High Consequence Areas; and (3) Other HFRA, which represent areas of lower relative risk than the first two tranches.

Based on IWMS and detailed engineering reviews, we will continue to deploy covered conductor to expeditiously reduce risk across HFRA while also increasing the scope of targeted undergrounding of overhead distribution facilities in the Severe Risk Areas. In Severe Risk Areas, factors such as limited egress, terrain or fuel can create conditions that are difficult for most mitigations, except for undergrounding, to address without leaving a substantial amount of residual public safety risk. Therefore, SCE believes that undergrounding should be the primary mitigation deployed in these areas, where feasible.

In concert with continuing to harden the grid, SCE will achieve the objectives identified above by deploying a suite of complementary mitigations to achieve the greatest risk reduction most expediently while balancing affordability and reliability impacts. This suite of mitigations will include enhancements to our successful asset inspections and maintenance, vegetation management, situational awareness and customer-focused initiatives, as well as new technologies and mitigation strategies to address the residual risk drivers and consequences that have not yet been sufficiently addressed. Our 2023-2025 WMP includes 40 activities with program targets that underscore our commitment to reduce the risk of wildfires and support our communities. We highlight some of the key activities for each wildfire mitigation category below.

1.2.1 Risk Methodology and Assessment: Advancements in Risk Modeling Capabilities Will Allow for More Robust Evaluation of Mitigations at Specific Locations of the Grid

SCE's risk-informed approach is granular, data-driven and uses a multifactor risk assessment framework that informs what mitigations are implemented where and how deployment is prioritized. This level of targeted risk analysis and mitigation selection helps drive efficient allocation of resources to mitigate risk effectively. We also evaluate operational considerations such as planning, permitting and execution lead times, resource constraints, work management efficiencies, risk-reduction potential of mitigations on targeted risk drivers and regulatory compliance requirements to determine the type and volume of work to undertake.

Over the 2023-2025 period, we will update our risk models with improved machine learning (ML) models, weather and fuels information, forward-looking climate scenarios, risk reduction from completed grid hardening projects and lessons learned in collaboration with Energy Safety, stakeholders

⁹ SCE targets locations where fires can grow to 300 acres in eight hours. Our analysis shows that fires of that size have the potential to grow to 10,000 acres, twice the threshold defined by Energy Safety for a catastrophic fire.

and utilities through the risk-modeling working groups. SCE will further evaluate incorporating other quantitative factors such as potential acres burned, locations with egress concerns and/or locations subject to frequent high wind and dry fuel conditions into our risk modeling. We will also incorporate the judgment of experts from areas such as fire science, risk management and system design to consider additional qualitative factors not fully captured by ignition modeling alone such as features of the terrain and direction of the wind that could influence the spread of a fire. All these factors and models are used to determine the portfolio of wildfire mitigation work to execute each year, including the type, volume and prioritization of mitigations.

1.2.2 Grid Design, Operations and Maintenance: Expanded Measures Are Expected to Further Reduce Wildfire Risk from Overhead Electric Systems

SCE has continued to refine its grid hardening approach through its IWMS, which guides our mitigation selection and deployment strategy. A key component of this approach is a segment-by-segment risk analysis of the remaining unmitigated overhead distribution lines in HFRA, with the results used to prioritize mitigation deployment across our HFRA.

SCE plans to install more than 2,850 additional circuit miles of covered conductor over this WMP period. By the end of 2025, we expect to have replaced more than 7,200 circuit miles, or approximately 75%, of distribution primary overhead conductors in HFRA with covered conductor. Covered conductor deployment is prioritized, not only by wildfire risk, but also by the probability of PSPS de-energizations for historically impacted circuits.

In Severe Risk Areas where covered conductor has not yet been deployed, SCE is undergrounding 100 miles of lines from 2023-2025 to address the high risk presented by limited egress, extreme potential consequences and other factors.

Furthermore, in this WMP period SCE will perform additional review and analysis of potential incremental mitigations to address remaining wildfire risk on the transmission system.

SCE will also be implementing, more widely, REFCL and EFD technologies, especially in locations where covered conductor has already been deployed to further reduce the risk of ignitions. REFCL helps detect and reduce energy release from a certain common class of faults while EFD facilitates locating abnormalities so that faults can be prevented proactively.

SCE also uses sensitive protection settings for over 900 circuits during elevated fire conditions for a quicker reduction in fault energy and thus lowering of ignition risk. We will upgrade relay hardware to expand the number of circuits with these protection settings. We will also continue refining our approach to balance the wildfire risk reduction benefits and potential customer outage impacts.

SCE will continue High Fire Risk Informed (HFRI) inspections and remediations in HFRA that go beyond minimum compliance requirements in scope, frequency and approach. Asset conditions and location-specific fire risks can often change between multiyear compliance intervals. Higher- frequency inspections are helping identify potential ignition risks every cycle, underscoring our program's efficacy. Detailed ground and aerial inspections are conducted to obtain 360-degree views of overhead structures and equipment. In 2023, SCE will inspect the portion of transmission and distribution structures that

comprise approximately 99% of risk. To further target risk reduction, we will also continue to perform additional inspections of assets in areas where observed risk factors associated with prevailing weather and fire conditions, such as dry fuel buildup and high winds, reach established criteria.

1.2.3 Vegetation Management and Inspections: An Improved Risk-Informed Vegetation Management Framework to Increase Efficiency and Enable Advanced Analytics

We continue to reduce the risks of vegetation contact with energized equipment by maintaining the required or recommended distance between trees and our lines, remediating trees that can fall into lines, removing dead or dying trees and clearing vegetation from around our poles. We are transitioning to an improved risk-informed inspection framework to better inform planning and prioritization of work for routine line clearing and hazard tree programs. This will allow resources to inspect vegetation grow-in risk and imminent fall-in risk at the same time to increase risk reduction and operational efficiencies. We have also implemented new software that will advance our operational and resource efficiency by streamlining scheduling and processing of the large volume of work and facilitating advanced analytics. Over this WMP period, we will also evaluate remote sensing technologies such as LiDAR and satellite imagery to assist with vegetation inspections.

1.2.4 Situational Awareness and Forecasting: Additional High-Definition Wildfire Cameras, Weather Stations, Satellite Imagery and Advanced Technology Will Boost Capabilities

SCE has made substantial progress in developing robust situational awareness and forecasting capabilities. In this WMP cycle, we will continue to advance our fire spread modeling, weather modeling and situational awareness capabilities to better predict fire weather and increase our ability to respond before and after fire and PSPS events. These advancements will allow us to more precisely target PSPS de-energization events, thereby minimizing the impact to customers while still addressing dangerous fire-threat conditions. We will deploy an additional 150 weather stations over the 2023-2025 period that will provide more granular weather data to inform our situational awareness and forecasting of potentially dangerous winds and elevated fire potential. We will also deploy additional high-definition wildfire cameras to monitor ignitions and fire progress in areas with limited coverage to expand visibility from approximately 90% today to expand coverage.

1.2.5 Emergency Preparedness: Trained Workforce Is Ready to Restore Power and Assist Customers; Aerial Suppression Resources Continue to Support Fire Agencies

SCE remains prepared to serve our customers and help them face emergencies that disrupt their electrical service. Our protocols and efforts include increased community engagement on how to prepare for such disruptions. In the event of a major emergency, we have a dedicated customer support team to assist impacted customers via customer communications before, during and after events and enhanced customer care programs. We also have a dedicated and trained Incident Management Team (IMT) to manage the emergency response. Our highly qualified workforce is trained on protocols to restore power safely and quickly after events. And after each event, we have a process in place to learn and improve on our response.

Finally, in 2023, we are expanding our partnership with fire agencies in our service area by maintaining a quick reaction force (QRF) of aerial firefighting resources year-round. These include helitankers, a reconnaissance aircraft and equipment to bolster firefighting capabilities to reduce a fire's consequence, provide service resilience to our customers and protect electrical infrastructure during fires. SCE will continue to reevaluate its funding agreement with Los Angeles, Orange and Ventura fire agencies annually.

1.2.6 Community Outreach and Engagement: Strong Partnerships Increase Outreach to Access and Functional Needs (AFN) Customer Groups

We are continuing to work closely with our customers, local and tribal government agencies, fire agencies, community-based organizations (CBOs) and other utilities for emergency planning, incident management and outreach. Over this WMP period, we will continue to focus much of our engagement efforts on vulnerable communities and communities heavily impacted by PSPS and will evaluate and refine our stakeholder coordination and customer outreach approaches based on feedback received from these stakeholders. We will also partner with telecommunications providers to help minimize the potential for service disruption to communities impacted by PSPS. In addition, we are actively collaborating with state, national and global utilities, industry groups and research organizations to benchmark and share best practices and information.

1.2.7 Public Safety Power Shutoff: SCE Continues Its Goal to Reduce PSPS Impacts with Urgency

PSPS is a necessary mitigation to protect public safety under extreme conditions. Though the frequency and scope of PSPS events are lessening as we execute our WMP activities, PSPS remains available as a tool of last resort when dry fuel levels and windspeeds pose significant threat of fire spread in case of any ignition. However, we recognize the impact that such events can have on our customers and communities. Keeping the lights on, and everything else electricity powers, is in our DNA, and we do not take lightly any decision to proactively de-energize portions of the grid. We have taken to heart the lessons from past PSPS events, and the feedback received from customers, cities, regulators, legislators and other partners, and we are working persistently to make several modifications to the process.

Our highly trained PSPS IMT plans and executes protocols designed to maximize a de-energization event's effectiveness while reducing the impact to customers by removing specific circuit-segments from scope through sectionalizing where possible and facilitating the swift and safe restoration of power.

Over 2023-2025, SCE will continue targeted grid hardening to reduce impacts to customers who have historically experienced PSPS and continue improvements to send timely external communication notifications. We are implementing end-to-end automation solutions to streamline PSPS event management and improve accuracy and speed of customer and public safety partner notifications.

We will also continue to make available temporary backup generators to select customers, not only during PSPS events, but also during maintenance outages required to implement our WMP. We will

expand on successful customer program offerings, with a special focus on AFN customers who rely on a medical device or assistive technology for independence, health or safety during a PSPS de-energization. We will continue to refine our grid protocols and customer-notifications processes to address specific concerns and feedback from county partners. We are also collaborating with heavily impacted communities for education, outreach and critical infrastructure planning support to help other entities providing critical services to be more resilient.

1.2.8 SCE Continues to Advance Its Wildfire Capability Maturity

As described above, SCE has and will continue to make progress in developing our wildfire mitigation capabilities. We continue to support the refinement and utilization of a wildfire mitigation capability maturity model to measure this progress. This will also help us identify and share best practices and continually improve to combat the risk of utility-caused wildfires. However, we note that this year's model survey is completely different from the previous three years, and thus the scores from this year cannot be compared to prior year scores. Further, due to this year's maturity model utilizing questions that are not always relevant to utility operations, some expectations that are operationally impractical, and a minimum scoring methodology, our scores do not accurately capture our actual and expected maturity levels, especially regarding our actual and expected progress in reducing wildfire risks. We have made significant advancements since 2018 in executing our wildfire mitigation plans and are observing the benefits as described above. The scope included in this WMP will further reduce the remaining risks that can potentially have significant consequences for our customers and communities.

1.2.9 Conclusion

SCE has implemented critical mitigations to protect our customers and communities from the threat of wildfires. At the same time, SCE is aware that there are still areas for improvement and more work that needs to be done. Our 2023-2025 WMP builds upon our significant progress made and lessons learned regarding wildfire mitigation since 2018. This plan demonstrates the significant increase in maturity of our wildfire mitigation program over the past four years and provides an integrated risk-informed approach to continue to reduce the remaining wildfire risk and PSPS impacts in our service area. Finally, our wildfire mitigation efforts will add resiliency to the electric system as we navigate a changing climate and a move toward increased electrification in the economy.

We appreciate the opportunity to provide our 2023-2025 WMP for Energy Safety's consideration and look forward to continuing our work with state and federal policymakers, local and tribal government officials, public safety partners, community-based organizations and other stakeholders to help build a safer and more resilient California.

2 RESPONSIBLE PERSONS

The electrical corporation must list those responsible for executing the WMP, including:

- Executive-level owner with overall responsibility
- Program owners with responsibility for each of the main components of the plan
- As applicable, general ownership for questions related to or activities described in the WMP

Titles, credentials, and components of responsible person(s) must be released publicly. Electrical corporations can reference the WMP Process and Evaluation Guidelines and California Code of Regulations Title 14 section 29200 for the submission process of any confidential information.

Jill Anderson, Executive Vice President of Operations at SCE, has overall responsibility for this Wildfire Mitigation Plan. The table below details the program owners with responsibility for each of the main components of the plan. Questions related to activities described in this plan can be submitted to SCE through the following email address: wildfires@sce.com.

Table SCE 2-01 – Responsible Persons

Section	Title	Program Owner
1	Executive Summary	Rajdeep Roy, Director, Wildfire Safety
2	Responsible Persons	Jill C. Anderson, Executive VP, Operations
3	Statutory Requirement Checklist	Gary Chen, Director, Safety & Infrastructure Policy
4	Overview of WMP	Rajdeep Roy, Director, Wildfire Safety
5	Overview of the Service Territory	Don Daigler, Managing Director, Business Resiliency (Weather and Climate components) Robert LeMoine, Director, Enterprise Risk Management & Public Safety (Risk-Related components)
6	Risk Methodology and Assessment	Robert LeMoine, Director, Enterprise Risk Management & Public Safety
7	Wildfire Mitigation Strategy Development	Rajdeep Roy, Director, Wildfire Safety
8	Wildfire Mitigations	Rajdeep Roy, Director, Wildfire Safety
8.1	Grid Design, Operations, and Maintenance	Ray Fugere, Principal Manager, Wildfire Mitigation Strategy
8.2	Vegetation Management and Inspection	Terry Ohanian, Director, Vegetation and Land Management

Section	Title	Program Owner
8.3	Situational Awareness and Forecasting	Don Daigler, Managing Director, Business Resiliency
8.4	Emergency Preparedness	Don Daigler, Managing Director, Business Resiliency
8.5	Community Outreach and Engagement	Larry Chung, Vice President, Local and Public Affairs (Local and Public Affairs components) Katie Sloan, Vice President, Customer Programs & Services (All other components)
9	Public Safety Power Shutoff	Don Daigler, Managing Director, Business Resiliency
10	Lessons Learned	Rajdeep Roy, Director, Wildfire Safety
11	Corrective Action Program	Ray Fugere, Principal Manager, Wildfire Mitigation Strategy
12	Notices of Violation and Defect	Denise Harris, Principal Manager, Regulatory Affairs and Compliance
Appendix B: Supporting Documentation for Risk Methodology and Assessment	Risk Model Supporting Documentation	Robert LeMoine, Director, Enterprise Risk Management & Public Safety
Appendix C: Additional Maps	Additional Maps	Robert LeMoine, Director, Enterprise Risk Management & Public Safety (Risk-Related components) Don Daigler, Managing Director, Business Resiliency (Weather and Climate components)
Appendix D: Areas for Continued Improvement	Areas for Continued Improvement	Rajdeep Roy, Director, Wildfire Safety
Appendix E: Referenced Regulations, Codes, and Standards	Referenced Regulations, Codes, Standards	Gary Chen, Director, Safety & Infrastructure Policy

Section	Title	Program Owner
Appendix F: Supplemental Information	Supplemental Information	Rajdeep Roy, Director, Wildfire Safety

3 STATUTORY REQUIREMENTS CHECKLIST

This section provides a checklist of the statutory requirements for a WMP as detailed in Public Utilities Code section 8386(c). By completing the checklist, the electrical corporation affirms that its WMP addresses each requirement.

For each statutory requirement, the checklist must include a reference and hyperlink to the relevant section and page number in the WMP. Where multiple WMP sections provide the information for a specific requirement, the electrical corporation must provide references and hyperlinks to all relevant sections. Unique references must be separated by semicolons, and each must include a brief summary of the contents of the referenced section (e.g., Section 5, pp. 30–32 [workforce]; Section 7, p. 43 [mutual assistance]).

SCE provides a checklist of the statutory requirements for its WMP in Table 3-1 below.

Table 3-1 - Statutory Requirements Checklist

PUC Section 8386	Description	WMP Section/ Page
(c)(1)	An accounting of the responsibilities of persons responsible for executing the plan	Section 2 (Responsible Persons), pp. 10-12
(c)(2)	The objectives of the WMP	Section 1 (Executive Summary), pp. 4 Section 4 (Overview of WMP), pp. 20-21 Section 7 (Wildfire Mitigation Strategy Development), Table 7-3, pp. 219-220
(c)(3)	A description of the preventive strategies and programs to be adopted by the electrical corporation to minimize the risk of its electrical lines and equipment causing catastrophic wildfires, including consideration of dynamic climate change risks	Section 5.3.4.2 Climate Change Phenomena and Trends (5.3.4.2 Climate Change Phenomena and Trends), pp. 56-66; Section 6.2.1 (Risk and Risk Component Identification), pp. 95-122; Section 6.3.2 (Extreme-Event/High Uncertainty Scenarios), pp. 154-157; Section 7.2.1, pp. 215-220 (Overview of Mitigation Initiatives and Activities); Section 8.1.2 (Grid Design and System Hardening), pp. 250-342; Section 8.2 (Vegetation Management and Inspections), pp. 374-438; Section 8.3 (Situational Awareness and Forecasting), pp. 445-520; Section 9 (Public Safety Power Shutoff (PSPS)), pp. 610-636

PUC Section 8386	Description	WMP Section/ Page
(c)(4)	A description of the metrics the electrical corporation plans to use to evaluate the plan’s performance and the assumptions that underlie the use of those metrics	<p>Targets:</p> <p>Section 8.1 (Grid Design, Operations, and Maintenance), pp.237-244; Section 8.2 (Vegetation Management and Inspections), pp. 377-383; Section 8.3 (Situational Awareness and Forecasting), pp. 448-452; Section 8.4 (Emergency Preparedness), pp. 522-528; Section 8.5 (Community Outreach and Engagement), pp. 578-582; Section 9 (Public Safety Power Shutoff (PSPS)), pp. 617-621</p> <p>Performance Metrics:</p> <p>Section 8.1 (Grid Design, Operations, and Maintenance), pp. 246-248; Section 8.2 (Vegetation Management and Inspections), pp. 382-386; Section 8.3 (Situational Awareness and Forecasting), pp. 451-454; Section 8.4 (Emergency Preparedness), pp. 527-531; Section 8.5 (Community Outreach and Engagement), pp. 581-584; Section 9 (Public Safety Power Shutoff (PSPS)), pp. 620-624</p>
(c)(5)	A discussion of how the application of previously identified metrics to previous plan performances has informed the plan	Section 1 (Executive Summary), pp. 1-4; Section 4 (Overview of WMP), pp. 23-29; Section 10 (Lessons Learned), pp. 635-640 Section 11 (Corrective Action Plan), pp. 650-659
(c)(6)	A description of the electric corporation’s protocols] for disabling reclosers and deenergizing portions of the electrical distribution system that consider the associated impacts on public safety. As part of these protocols, each electrical corporation shall include protocols related to mitigating the public safety impacts of disabling reclosers and deenergizing portions of the electrical distribution system that consider the impacts on all of the aspects listed in PU Code 8386[(c)(6)(A)-(D)].	Section 8.3.3 (Grid Monitoring Systems– Existing Systems, Technologies, and Procedures), pp. 467-480; Section 9.2 (Protocols on PSPS), pp. 623-635

PUC Section 8386	Description	WMP Section/ Page
(c)(7)	A description of the appropriate and feasible procedures for notifying a customer who may be impacted by the deenergizing of electrical lines, including procedures for those customers receiving a medical baseline allowance as described in paragraph (6). The procedures shall direct notification to all public safety offices, critical first responders, health care facilities, and operators of telecommunications infrastructure with premises within the footprint of potential de-energization for a given event. [The procedures shall comply with any orders of the commission regarding notifications of deenergization events.]	Section 8.5.2 (Public Outreach and Education Awareness Program), pp 583-602; Section 8.5.3 (Engagement with Access and Functional Needs Populations), pp. 601-606; Section 9.2 (Protocols on PSPS), pp. 613-624
(c)(8)	Identification of circuits that have frequently been deenergized pursuant to a deenergization event to mitigate the risk of wildfire and the measures taken, or planned to be taken, by the electrical corporation to reduce the need for, and impact of, future deenergization of those circuits, including, but not limited to, the estimated annual decline in circuit deenergization and deenergization impact on customers, and replacing, hardening, or undergrounding any portion of the circuit or of upstream transmission or distribution lines	Section 9.1.2 (PSPS - Identification of Frequently De-energized Circuits), pp. 611-616; Appendix F: Supplemental Information (F5: Continuation of Section 9 - PSPS) pp. 859-871
(c)(9)	Plans for vegetation management	Section 8.2 (Vegetation Management and Inspections), pp. 374-446
(c)(10)	Protocols for the PSPS of the electrical corporation's transmission infrastructure, etc.	Section 8.4 (Emergency Preparedness), pp. 518-576; Section 9 (Public Safety Power Shutoff), pp. 623-635
(c)(11)	A description of the electrical corporation's protocols for the deenergization of the electrical	Section 8.4 (Emergency Preparedness), pp. 518-576; Section 9 (Public Safety Power Shutoff), pp. 623-635

PUC Section 8386	Description	WMP Section/ Page
	<p>corporation’s transmission infrastructure, for instances when the deenergization may impact customers who, or entities that, are dependent upon the infrastructure. The protocols shall comply with any order of the commission regarding deenergization events.</p>	
(c)(12)	<p>A list that identifies, describes, and prioritizes all wildfire risks, and drivers for those risks, throughout the electrical corporation’s service territory, including all relevant wildfire risk and risk mitigation information that is part of the Safety Model Assessment Proceeding [(A.15-05-002, et al.)] and the Risk Assessment Mitigation Phase filings. [The list shall include, but not be limited to, both of the following: (A) Risk and risk drivers associated with design, construction, operations, and maintenance of the electrical corporation’s equipment and facilities and (B) Particular risks and risk drivers associated with topographic and climatological risk factors throughout the different parts of the electrical corporation’s service territory.</p>	<p>Section 6 (Risk Methodology and Assessment), pp. 89-180; Section 7 (Wildfire Mitigation Strategy Development), pp. 181-229; Appendix F: Supplemental Information (F2: Continuation of Section 7 Wildfire Mitigation Strategy Development) pp. 824-850</p>
(c)(13)	<p>A description of how the plan accounts for the wildfire risk identified in the electrical corporation’s Risk Assessment Mitigation Phase filing</p>	<p>Section 6 (Risk Methodology and Assessment), pp. 89-180; Section 7 (Wildfire Mitigation Strategy Development), pp. 181-229</p>
(c)(14)	<p>A description of the actions the electrical corporation will take to ensure its system will achieve the highest level of safety, reliability, and resiliency, and to ensure that its system is prepared for a major event, including hardening and modernizing its infrastructure with improved engineering, system design, standards,</p>	<p>Section 7 (Wildfire Mitigation Strategy Development), pp. 181-229; Section 8.1.2 (Grid Design, Operations, and Maintenance), pp. 250-277; Section 8.1.3 (Asset Inspections), pp. 279-313; Section 8.1.4 (Equipment, Maintenance and Repair), pp. 313-319; Section 8.4 (Emergency Preparedness), pp. 518-576</p>

PUC Section 8386	Description	WMP Section/ Page
	equipment, and facilities, such as undergrounding, insulation of distribution wires, and pole replacement	
(c)(15)	A description of where and how the electrical corporation considered undergrounding electrical distribution lines within those areas of its service territory identified to have the highest wildfire risk in a commission fire threat map	Section 8.1.2.2 (Undergrounding of Electric Lines and/or Equipment), pp. 256-257
(c)(16)	A showing that the electrical corporation has an adequately sized and trained workforce to promptly restore service after a major event, taking into account employees of other utilities pursuant to mutual aid agreements and employees of entities that have entered into contracts with the electrical corporation	Section 8.4 (Emergency Preparedness), pp. 539-548, 552-557, 558-560; Section 8.1.9 (Workforce Planning), pp. 341-374
(c)(17)	An identification of any geographic area in the electrical corporation's service territory that is a higher wildfire threat than is currently identified in a commission fire threat map, and where the commission must consider expanding the high fire threat district based on new information or changes in the environment	Section 5.3.3 High Fire Threat Districts, pp. 51-53; Section 6.4.1.2 (Proposed Updates to the HFTD), pp. 159-162.
(c)(18)	A methodology for identifying and presenting enterprise-wide safety risk and wildfire-related risk that is consistent with the methodology used by other electrical corporations unless the commission determines otherwise	Section 4.4.1 (SCE's Risk-Informed Framework), pp. 23-29; Section 6 (Risk Methodology and Assessment), pp. 89-180 Section 7 (Wildfire Mitigation Strategy Development), pp. 181-229
(c)(19)	A description of how the plan is consistent with the electrical corporation's disaster and emergency preparedness plan prepared pursuant	Section 8.4 (Emergency Preparedness), pp 518-576; Section 8.4.3 (External Collaboration and Coordination), pp. 550-559; Section 8.4.5 (Preparedness and

PUC Section 8386	Description	WMP Section/ Page
	to Section 768.6, including [both of the following: (A) Plans to prepare for, and to restore service after, a wildfire, including workforce mobilization and prepositioning equipment and employees and (B) Plans for community outreach and public awareness before, during, and after a wildfire, including language notification in English, Spanish, and the top three primary languages used in the state other than English or Spanish, as determined by the commission based on the United States Census data.]	Planning for Service Restoration), pp. 564-571; Section 8.5.2 (Public Outreach and Education Awareness Program), pp. 583-602
(c)(20)	A statement of how the electrical corporation will restore service after a wildfire	Section 8.4.5.1 (Overview of Service Restoration Plan), pp. 564-568
(c)(21)	Protocols for compliance with requirements adopted by the commission regarding activities to support customers during and after a wildfire, outage reporting, support for low-income customers, billing adjustments, deposit waivers, extended payment plans, suspension of disconnection and nonpayment fees, repair processing and timing, access to electrical corporation representatives, and emergency communications	Section 8.4.6 (Customer Support in Wildfire and PSPS Emergencies), pp. 570-576
(c)(22)	A description of the processes and procedures the electrical corporation will use to do the following: (A) Monitor and audit the implementation of the plan. (B) Identify any deficiencies in the plan or the plan's implementation and correct those deficiencies. (C) Monitor and audit the effectiveness of electrical line and equipment inspections, including inspections performed by contractors,	Section 8.1.6 (Quality Assurance and Quality Control) pp. 325-327; Section 8.2.5 (Vegetation Management) pp. 428-434 ; Section 11 (Corrective Action Program) pp. 650-659

PUC Section 8386	Description	WMP Section/ Page
	carried out under the plan and other applicable statutes and commission rules.	

4 OVERVIEW OF WMP

4.1 Primary Goal

Each electrical corporation must state the primary goal of its WMP. At a minimum, the electrical corporation must affirm its compliance with California Public Utilities Code section 8386(a):

Each electrical corporation shall construct, maintain, and operate its electrical lines and equipment in a manner that will minimize the risk of catastrophic wildfire posed by those electrical lines and equipment.

In accordance with Section 8386(a) of the California Public Utilities Code, SCE constructs, maintains, and operates its electrical lines and equipment in a manner that will minimize the risk of catastrophic wildfire posed by those electrical lines and equipment. SCE's WMP represents a holistic approach to continue to maintain this compliance, while also balancing customer affordability, reliability, and the impacts to customers from the deployment of wildfire risk mitigation activities, including PSPS. Further, SCE's wildfire mitigation portfolio also considers the impacts associated with fires that may not be categorized as catastrophic but still can present serious impacts to our customers and communities.

4.2 Plan Objectives

In this section, the electrical corporation must summarize its plan objectives over the 2023- 2025 WMP cycle. Plan objectives are determined by the portfolio of mitigation initiatives proposed in the WMP.

The primary objective of our 2023-2025 WMP is to reduce the risk of wildfires associated with utility equipment and to reduce the scope, scale, frequency, and impacts of PSPS events. Our 2023-2025 WMP includes 40 mitigation initiatives designed to help achieve this objective. SCE will strive to meet or exceed our projected targets for these initiatives over this three-year period.¹⁰

SCE has established 3- and 10-year objectives for each WMP initiative category. Table SCE 7-03 provides an aggregated list of these objectives grouped by each WMP initiative category. Further detail on each objective is provided within Sections 8 and 9 for each respective WMP category.¹¹ In Section 1, SCE summarized these plan objectives as follows:

- Reduce the likelihood that objects will contact power lines and lead to an ignition by hardening most of the overhead distribution system in our high fire risk area with either covered conductor or targeted undergrounding, developing an expanded transmission grid hardening strategy, and continuing to maintain vegetation clearance distances for trees and vegetation that could potentially contact power lines.
- Reduce the likelihood that equipment will fail and lead to an ignition, by continuing to perform asset inspection initiatives that inspect over 99% of wildfire risk in our HFRA each year and by deploying new technologies that can detect when issues on the system may arise.

¹⁰ Annual targets for these initiatives can be found in the respective Targets tables contained in Sections 8 and 9, and within Table 1 of SCE's Quarterly Data Report – Wildfire Mitigation Data Tables.

¹¹ See Table 8-1 and Table 8-02(Grid Design, Operations, and Maintenance objectives), Table 8-12 and Table 8-13 (Vegetation Management and Inspections objectives), Table 8-21and Table 8-22 (Situational Awareness and Forecasting objectives), Table 8-33 and Table 8-34 (Emergency Preparedness objectives), Table 8-53 and Table 8-54 (Community Outreach and Engagement objectives), and Table 9-3 and Table 9-4 (PSPS objectives).

- Prioritize the deployment of our mitigation initiatives to the areas that have the greatest potential to lead to the most consequential wildfire and PSPS impacts.
- Improve the efficiency and effectiveness of our vegetation management activities to reduce the risk of vegetation-caused ignitions.
- Improve the operational efficiency and effectiveness of our wildfire mitigation initiatives by enhancing program deployment strategies, leveraging information technology solutions, and incorporating new technologies where possible.
- Continue to improve our situational awareness capabilities by enhancing weather and fire potential modeling and forecasting, which will aid PSPS decisions and wildfire mitigation deployment.
- Reduce the impacts of PSPS to customers, particularly those with Access and Functional Needs, through expanded customer offerings, communications, and circuit-specific strategies to minimize the need for PSPS altogether.
- Maintain a comprehensive, all-hazards planning and preparedness program to: provide effective emergency response; safely and expeditiously restore service during and after a major event; and communicate effectively with customers, stakeholders, and agency partners.
- Deploy new technologies and updated protection device settings to improve wildfire mitigation effectiveness while balancing reliability impacts to customers.

4.3 Proposed Expenditures

Each electrical corporation must summarize its projected expenditures in thousands of U.S. dollars per year for the next three-year WMP cycle, as well as the planned and actual expenditures from the previous three-year WMP cycle (e.g., 2020–2022), in both tabular and graph form.

Table 4-1 provides an example of the minimum acceptable level of information summarizing an electrical corporation’s WMP expenditures. The financials represented in the summary table equal the aggregate spending listed in the financial tables of the QDR (see the Energy Safety Data Guidelines). Energy Safety’s WMP evaluation, including approval or denial, must not be construed as approval of, or agreement with, costs listed in the WMP.

Table 4-1 and Figure SCE 4-01 provide a summary of expenditures for SCE’s 2020-2022 and 2023-2025 WMP cycles.

Table 4-1 - Summary of WMP Expenditures¹²

Year	Spend (thousands \$USD)
2020	Planned (as reported in 2020 WMP update) = \$1,308,269 Actual = \$1,356,923 $\pm\Delta$ = \$48,654
2021	Planned (as reported in 2021 WMP Update) = \$1,629,377 Actual = \$1,642,980 $\pm\Delta$ = \$13,603
2022	Planned (as reported in 2022 WMP Update) = \$1,619,252 Actual = \$1,599,912 $\pm\Delta$ = \$19,340
2023	Planned = \$1,869,997
2024	Planned = \$1,887,446
2025	Planned = \$2,006,300

Figure SCE 4-01 - Graph of WMP Expenditures



¹² The summary of WMP Expenditures reflects direct capital and O&M costs for wildfire activities which correspond to the HFTD spend as shown in Table 11 of the QDR. The dollars are nominal.

4.4 Risk-Informed Framework

The electrical corporation must adopt a risk-informed approach to developing its WMP. The purposes of adopting this approach are as follows:

- To develop a WMP that achieves an optimal level of life safety, property protection, and environmental protection, while also being in balance with other performance objectives (e.g., reliability and affordability)
- To integrate risk modeling outcomes with a range of other performance objectives, methods, and subject matter expertise to inform decision-making processes and the spatiotemporal prioritization of mitigations
- To target mitigation efforts that prioritize the highest-risk equipment, wildfire environmental settings, and assets-at-risk (e.g., people, communities, critical infrastructure), while still satisfying other performance objectives defined by the California Public Utilities Commission (CPUC) (e.g., reliability and affordability)
- To provide a decision-making process that is clear and transparent to internal and external stakeholders, including clear evaluation criteria and visual aids (such as flow charts or decision trees)

The risk-informed approach adopted by the electrical corporation must, at a minimum, incorporate several key components, described below. In addition, the evaluation and management of risk must include consideration of a broad range of performance objectives (e.g., life safety, property protection, reduction of social vulnerability, reliability, resiliency, affordability, health, environmental protection, public perception, etc.), integrate cross-disciplinary expertise, and engage various stakeholder groups as part of the decision-making process.

The risk-informed approach must have seven minimum components, as described in Table 4-2.

Table 4-2 - Risk-Informed Approach Components

Risk-Informed Approach Component	Brief Description
1. Goals and plan objectives	The first step in the risk-informed approach is to identify the primary goal(s) and plan objectives of the electrical corporation’s WMP. These goals and objectives are electrical corporation-specific and must be defined and described in Sections 4.1 and 4.2.
2. Scope of application (i.e., electrical corporation service territory)	The second step is to define the physical characteristics of the system in terms of its major elements: electrical corporation service territory characteristics, electrical infrastructure, wildfire environmental settings, and various assets-at-risk (e.g., communities and people, property, critical infrastructure, cultural/historical resources, environmental services). Knowledge and understanding of how individual system elements interface are essential to this step. Sections 5–5.4 provide instructions on what electrical corporations must present regarding physical traits, environmental characteristics, and potential assets at risk in their service territory.

Risk-Informed Approach Component	Brief Description
3. Hazard identification	<i>The third step is to identify hazards and determine their likelihoods. Section 6.2.1 provides instructions on hazard identification.</i>
4. Risk scenario identification	<i>The fourth step, based on the context and desired values, is to develop risk scenarios that could lead to an undesirable event. Risk scenario techniques that may be employed include event tree analysis, fault tree analysis, preliminary hazard analysis, and failure modes and effects analysis. Section 6.3 provides instructions on risk scenario identification.</i>
5. Risk analysis (i.e., likelihood and consequences)	<i>The fifth step is to evaluate the likelihood and consequences of the identified risk scenarios to understand the potential impact on the desired goal(s) and plan objectives. The consequences are based on an array of risk components that are fundamental to overall utility risk, wildfire risk, and PSPS risk given the electrical corporation’s scope of application and portfolio of wildfire mitigation initiatives. Section 6.2.2 provides instructions on risk analysis.</i>
6. Risk presentation	<i>The sixth step is to consider how the risk analysis is presented to the various stakeholders involved. Section 6.4 provides instructions on risk presentation.</i>
7. Risk evaluation	<i>After the risk analysis is complete, hazards can be resolved by either assuming the risk associated with the hazards or eliminating or controlling the hazards. Risk evaluation includes identification of criteria and procedures for identifying critical risk both spatially and temporally. Risk evaluation must also include, as a minimum, evaluating the seriousness, manageability, urgency, and growth potential of the wildfire hazard/risk. Risk evaluation should be used to determine whether the individual hazard/risk should be mitigated. Risk evaluation and risk-informed decision making should be done using a consensus approach involving a range of key stakeholder groups. Section 7 provides instructions for risk evaluation or risk-informed decision making.</i>
8. Risk mitigation and management	<i>In the final step, the electrical corporation must identify which risk management strategies are appropriate given practical constraints such as limited resources, costs, and time. The electrical corporation must indicate the high-level risk management approach, as determined in Step 7. The electrical corporation must identify risk mitigation initiatives (or a portfolio of initiatives) and prioritize their spatial and temporal implementation. This step includes consideration of what risk mitigation strategies are appropriate and most effectively meet the intent of the WMP goal(s) and plan objectives, while still in balance with other performance objectives. It also includes the procedures and strategies to develop, review, and execute schedules for implementation of mitigation initiatives and activities (as well as interim mitigation initiatives). Section 8</i>

Risk-Informed Approach Component	Brief Description
	<i>provides instructions for reporting on initiatives to mitigate identified risks.</i>

4.4.1 SCE’s Risk-Informed Framework

SCE’s risk-informed planning framework is anchored in SCE’s Enterprise Risk Management (ERM) process. ERM annually identifies and evaluates the key risks that SCE and its customers face, with a focus on safety, such as wildfire risk. SCE uses a multi-step process that includes both a top-down and bottoms-up approach, as described below.

- Top-down review of enterprise-level risks: This effort assesses the breadth of activities ongoing at SCE, in California, and in the utility industry to identify key risks. It includes a review of utility benchmarking, industry trends and research, public policy efforts, legislative activities, CPUC, Energy Safety and other regulatory proceedings, major SCE initiatives, and critical business functions. The team also compiles and assesses feedback on current and emerging enterprise-level risks through company-wide surveys and direct discussions with SCE leadership.
- Bottom-up review of SCE’s Enterprise Risk Register: SCE’s ERM function maintains an enterprise risk register that captures and assesses risks from across the enterprise, based on interviews and feedback from working groups throughout the organization, including from engineering analyses and field observations.¹³ New risks are also identified based on benchmarking and emerging trends in the industry.
- Consolidation and aggregation: SCE aggregates the risks identified through the above processes to evaluate which risks have potential major safety consequences, including consolidation of duplicate and similar risks.
- Review and refinement with senior leadership: Through leadership review and assessment, further refinements are made as appropriate.

SCE’s risk-informed approach builds upon past practices, lessons learned, and stakeholder input. In our 2021¹⁴ and 2022 WMP Updates,¹⁵ SCE detailed our risk-informed decision-making process to select and deploy SCE initiatives that mitigate wildfire and PSPS risks. We included a diagram that illustrates SCE’s approach to risk-informed decision-making when assessing and selecting wildfire and PSPS mitigations

¹³ For example, SCE’s Fire Investigation Preliminary Analysis (FIPA) and Repair Order Review processes provide cause analysis and engineering reviews of risk events on the system. These are detailed in SCE’s Corrective Action Program in Section 11.

¹⁴ This was initially provided as part of response with regard to Critical Issue SCE-02 in SCE’s Revised 2021 WMP Update, which can be retrieved from SCE’s WMP webpage (<https://www.sce.com/safety/wild-fire-mitigation>). Within the document, please refer to SCE’s response to Critical Issue SCE-02. In its Final Action Statement, OEIS found that SCE’s response for Critical Issue SCE-02 “adequately addressed all parts of this critical issue” and that SCE’s work product “brings clarity to the decision-making process by illustrating factors such as ‘risk reduced’ and ‘RSE’ are weighted more heavily than ‘operational feasibility’ and ‘compliance requirement.’” (See OEIS Final Action Statement, pp. 87, 89).

¹⁵ See Section 7.1.2 of SCE’s 2022 WMP Update.

and prioritizing deployment for selected activities.

Broadly speaking, the process includes four major stages: First, we evaluate or reassess, and then prioritize, wildfire and PSPS risks. Second, we identify the various mitigation alternatives for mitigating the risk. Third, we evaluate the mitigations and then select the appropriate mitigation(s) from the alternatives using decision-making factors. Fourth, we prioritize, scope and deploy the chosen mitigation(s). We then continue to monitor deployments in light of relevant conditions or circumstances, and we strive to improve through lessons learned, data analysis, performance reviews, and feedback from our customers, regulators, and other stakeholders. SCE provides further detail on this process in Section 7.

Application of this process for each wildfire mitigation activity may vary depending on the unique characteristics of the mitigation activities. While specific processes and steps continue to evolve as we build out our asset management capabilities, the planning framework generally captures the key elements of the process. With each WMP cycle, SCE's overall risk-informed decision-making process is maturing in the level of quantitative analysis performed, granularity of analysis, and consistent application across the enterprise.

In this WMP, SCE details its Integrated Wildfire Mitigation Strategy Risk Framework (IWMS Risk Framework or IWMS), which further aligns our wildfire mitigation activities in a risk-informed framework. IWMS reduces the risk of catastrophic wildfire by targeting locations that have historically experienced a high frequency of fires and have limited road availability for quick evacuation, are expected to experience wind and fuel conditions that exceed PSPS thresholds even after covered conductor deployment, and where fire spread can be rapid and large. Section 6 and Section 7 detail how SCE has built upon the foundational risk modeling advancements made in the past five years, to include these new risk factors and to prioritize mitigations to those areas that present the most consequential risk.

SCE's IWMS Risk Framework is granular, data-driven, and uses a multi-factor risk assessment approach that combines quantitative risk analysis with expert human judgment to inform how mitigations are identified, evaluated, prioritized, and implemented. This level of targeted risk analysis and mitigation selection helps drive efficient allocation of resources to mitigate risk in an effective manner. As part of this framework, we evaluate operational considerations such as planning, permitting and execution lead times, resource constraints, work management efficiencies, risk-reduction potential of mitigations on targeted risk drivers, and regulatory compliance requirements to determine the type and volume of work to undertake.

4.4.2 Evolution of SCE's Wildfire and PSPS Risk Modeling

A risk-informed framework has been a cornerstone in the development and execution of our WMPs and has matured over time. This framework is rooted in an evolving set of risk modeling capabilities which inform our evaluation of risk and selection of mitigations. Figure SCE 4-02 traces the key advancements in our wildfire and PSPS risk modeling over the past few years.

Figure SCE 4-02 - Evolution of SCE's Wildfire (and PSPS) Risk Modeling¹⁶

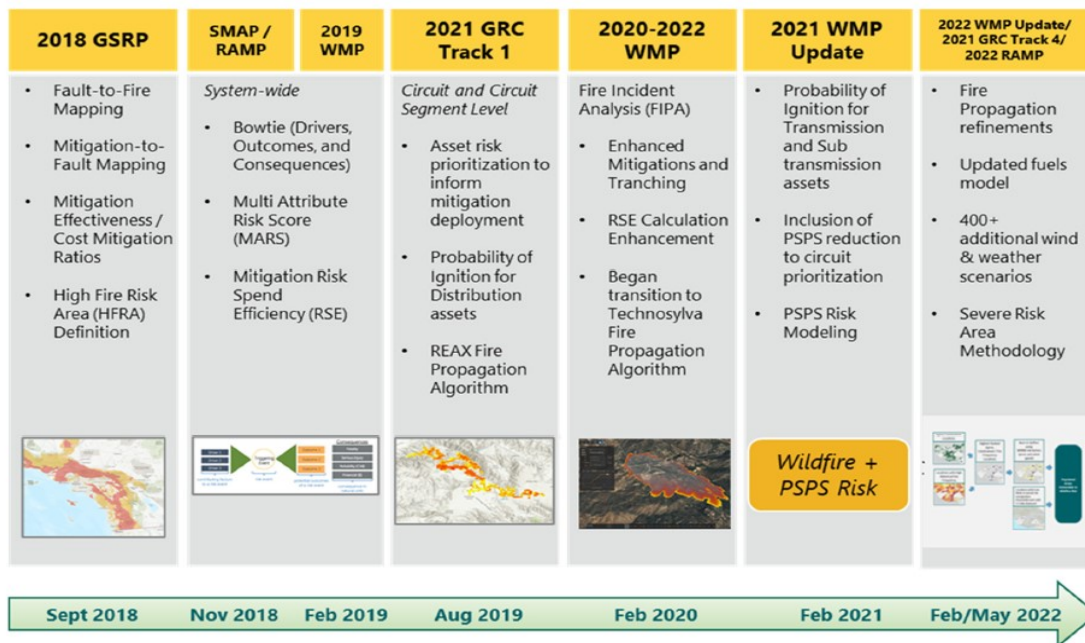

In 2018, we used a multi-step process to develop our Risk Assessment Mitigation Phase (RAMP) report, which contained nine top safety risks, including wildfire. SCE developed a Multi-Attribute Risk Score (MARS) framework (SCE's version of a Multi Attribute Value Function (MAVF)) to quantify our enterprise-level risks and evaluate mitigation options).

SCE's MARS framework aligns with the methodology approved in the California Public Utilities Commission's (CPUC) Safety Model and Assessment Proceeding (S-MAP). This analysis informed SCE's 2018 Grid Safety and Resiliency Plan (GSRP), which presented an initial set of wildfire mitigations to address the growing threat of wildfires, and 2019 WMP. In parallel, we developed the Wildfire Risk Model (WRM) which was used to determine probability and consequence of ignitions at the asset level. SCE used this granular risk analysis to risk rank circuit segments and prioritize mitigation installations, in conjunction with other operational considerations (e.g., permitting and resource constraints). The results of these analyses were included in SCE's Test Year 2021 GRC and 2020 WMP.

In 2020, SCE achieved several key milestones in enhancing our wildfire risk analytics. We developed asset-specific POI models for transmission and sub-transmission assets to add to our previously built distribution asset models. SCE also transitioned to a new fire consequence modeling tool developed by Technosylva. We developed a method to translate the risk scores produced by our Probability of Ignition (POI) and consequence models into unitless risk scores using the MARS framework at the structure (pole or tower) level. SCE also developed a PSPS risk calculation to more comprehensively account for PSPS risk reduction benefits, as well as risks associated with use of PSPS for individual circuit segments.

In 2021, SCE updated its asset-specific POI model by using the latest asset and weather data and algorithms. At the same time, SCE updated the Technosylva fire consequence model by including

¹⁶ GSRP: Grid Safety and Resiliency Plan; SMAP: Safety Model and Assessment Proceeding; RAMP: Risk Assessment Mitigation Phase .

additional historical weather scenarios and most up-to-date fuel conditions including recent burn scars to better capture the potential fire consequences. In 2021 and through 2022, SCE also participated in several Energy Safety-led joint utility workshops to further inform how individual utilities perform risk modeling. SCE details its risk modeling capabilities and further advancements made in Section 6.

4.4.3 Adherence to Risk-Informed Framework

SCE’s risk-informed planning framework is aligned with the eight-step risk-informed framework defined in the guidelines. SCE addresses each component of that framework and describes our approach for each in this WMP. Table SCE 4-01 summarizes where further detail on each component can be found in this WMP.

Table SCE 4-01 - Risk-Informed Framework

Risk-Informed Approach Component	Pertinent Section(s) of SCE’s 2023-2025 WMP
1. Goals and plan objectives	Sections 4.1 and 4.2, where SCE identifies primary goal(s) and plan objectives of its WMP.
2. Scope of application	Sections 5– 5.4, where SCE defines the physical characteristics of its system in terms of its major elements: service territory characteristics, electrical infrastructure, wildfire environmental settings, and various assets at risk (e.g., communities and people, property, critical infrastructure, cultural/historical resources, environmental services).
3. Hazard identification	Section 6.2, where SCE identifies hazards and determines their likelihoods.
4. Risk scenario identification	Section 6.3, where SCE describes the risk scenarios used in its analysis.
5. Risk analysis	Section 6.2 and 6.3, where SCE calculates the likelihood and consequences under the identified risk scenarios to develop a risk-informed basis for its approach to the WMP goal and objectives.
6. Risk presentation	Section 6.4, where SCE presents the results of the risk analysis.
7. Risk evaluation	Section 7, where SCE evaluates the identified risk and details its risk-informed decision-making framework.

Risk-Informed Approach Component	Pertinent Section(s) of SCE’s 2023-2025 WMP
8. Risk mitigation and management	<p>Sections 7, 8, 9, where SCE identifies which risk management strategies are appropriate given practical constraints such as limited resources, costs, and time. SCE also identifies risk mitigation initiatives (and a portfolio of initiatives) and prioritizes their spatial and temporal implementation. This includes consideration of which risk mitigation strategies are appropriate and most effectively meet the intent of the WMP goal and plan objectives, while still balancing other performance objectives.</p>

5 OVERVIEW OF THE SERVICE TERRITORY

In this section of the WMP, the electrical corporation must provide a high-level overview of its service territory and key characteristics of its electrical infrastructure. This information is intended to provide the reader with an understanding of the physical and technical scope of the electrical corporation's WMP. Sections 5.1 - 5.4 below provide detailed instructions.

5.1 Service Territory

The electrical corporation must provide a high-level description of its service territory, addressing the following components:¹⁷

- *Area served (in square miles)*
- *Number of customers served*

The electrical corporation must provide a geospatial map that shows its service territory (polygons) and distribution of customers served (raster or polygons). This map should appear in the main body of the report.

Table 5-1 provides a template for presenting the required high-level service territory statistics.

Southern California Edison (SCE) is one of the nation's largest electric utilities. It serves approximately 15.6¹⁸ million people (5.2 million customer accounts) across 193 cities¹⁹ and 16 counties.¹⁹ SCE's service area spans approximately 52,000 square miles of central, coastal, and Southern California.

SCE provides high level statistics for its service area in Table 5-1 below.

Table 5-1 - Service Territory High-Level Statistics

Characteristic	Value
Area served (sq. mi.) ²⁰	52,256 Square Miles
Number of customers served ¹⁹	5.2 Million Customer Accounts

Further, Figure SCE 5-01 shows SCE's service area (polygons), distribution of customers served (raster or polygons), and county and city administrative boundaries (polygons or polylines).

¹⁷ Annual information included in this section must align with Table 7 of the QDR.

¹⁸ Data as of 12/13/22 and assuming 3 per household and 5.2 million customer account (household), therefore, 5.2 million customer * 3 per household = 15.6 million customers served.

¹⁹ Data as of 12/13/22.

²⁰ Data as of 12/16/22.

Figure SCE 5-01 - SCE Service Area²¹

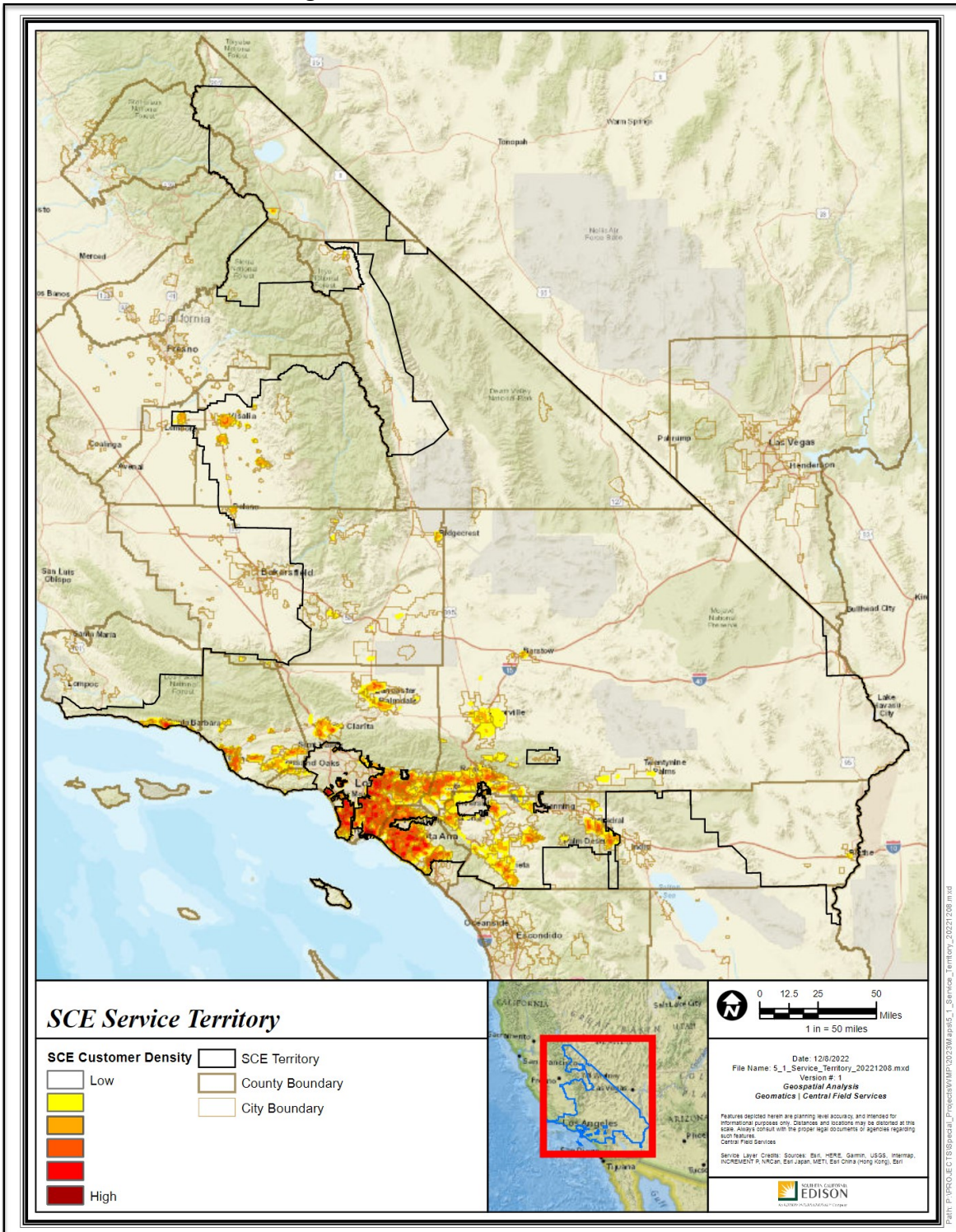

²¹ Map as of 12/8/22. SCE has provided a spatial data for SCE service territory. Please see <https://www.sce.com/safety/wild-fire-mitigation>.

5.2 Electrical Infrastructure

The electrical corporation must provide a high-level description of its infrastructure, including all power generation facilities, transmission lines and associated equipment, distribution lines and associated equipment, substations, and any other major equipment.²²

Table 5-2 provides a template for presenting the required information.

SCE transmits and distributes electricity across 186 transmission and 634 distribution substations. SCE maintains more than 82,000 circuit miles of overhead and underground for distribution and transmission lines. SCE produces approximately 9 million²³ MWh of power annually at 74 generation facilities, predominantly from the Big Creek Hydroelectric Project and Mountainview Generating Station. Approximately 13,925 circuit miles of SCE’s transmission and distribution of overhead conductor are in High Fire Risk Areas (HFRA).

SCE provides an overview of key electrical equipment for its service area in Table 5-2 below. The metrics provided in Table 5-2 are based on SCE HFRA.

Table 5-2 - Overview of Key Electrical Equipment

Type of Equipment	HFRA	Non-HFRA	Total
Substations (#) ²⁴	131	689	820
Power generation facilities (#) ²⁵	38	36	74
Overhead transmission lines (circuit miles) ²⁶	4,366	7,957	12,323
Overhead distribution lines (circuit miles) ²⁷	9,559	28,709	38,268
Hardened overhead distribution lines (circuit miles) ²⁸	3,810	183	3,993
Hardened overhead transmission lines (circuit miles) ²⁸	0	0	0
Underground transmission and distribution lines (circuit miles) ²⁷	7,233	24,255	31,488
Distribution transformers (#) ²⁹	81,132	373,028	454,160

²² Annual information included in this section must align with Table 7 of the QDR.

²³ Data as of 2/26/21. Data source is CAISO meters at the generation facilities.

²⁴ Data as of 10/28/22. The type of substation includes distribution and transmission.

²⁵ Data as of 10/28/22. The type of generation includes solar sites, gas sites, hydro sites, fuel cells and battery storage.

²⁶ Data as of 12/16/22. The overhead Transmission circuit miles include bulk and sub transmission.

²⁷ Data as of 12/16/22.

²⁸ Data as of 12/16/22. For purposes of this chart, “hardened overhead distribution and transmission lines” are considered to be circuit miles of covered conductor installed, either through WCCP or other programs (e.g., storm), as well as overhead miles undergrounded through SCE’s targeted undergrounding program. Covered conductor being evaluated for feasibility on Transmission lines. As of now, it is not yet approved for use.

²⁹ Data as of 1/31/2023. The data includes only overhead transformers.

Type of Equipment	HFRA	Non-HFRA	Total
Reclosers (#) ³⁰	878	1,829	2,707
Poles (#) ³¹	300,880	1,039,025	1,339,905
Towers (#) ³²	10,199	16,820	27,019
Microgrids (#) ³³	0	0	0

5.3 Environmental Settings

The electrical corporation must provide a high-level overview of the wildfire environmental settings within its service territory.

In Section 5.3, SCE describes the environmental settings associated with fire regimes throughout its service territory. In Section 5.3.1, SCE provides an overview of the fire ecology for each of its Fire Climate Zones (FCZ)s including a description of the prevailing vegetation types in each location. In Section 5.3.2, SCE describes catastrophic fires (as defined by Energy Safety) where an investigating agency opined that utility equipment was likely involved or was reported to the CPUC by SCE that utility equipment was potentially involved. Section 5.3.3 and Section 5.3.1, depicts SCE’s High Fire Threat District (HFTD), which the CPUC has determined to have elevated or extreme risk of wildfires. Finally, Section 5.3.4 and lays the foundation for prevailing and future climatic conditions, as well as topographic features in each location in Section 5.3.5.

5.3.1 Fire Ecology

The electrical corporation must provide a brief narrative describing the fire ecology or ecologies across its service territory. This includes a brief description of how ecological features, such as the following, influence the propensity of the electrical corporation’s service territory to experience wildfires: generalized climate and weather conditions, ecological regions and associated vegetation types, and fire return intervals.

The electrical corporation must provide tabulated statistics of the vegetative coverage across its service territory. The tabulated data must include a breakdown of the vegetation types, total acres per type, and percentage of service territory per type. The electrical corporation must identify the vegetative database used to characterize the vegetation (e.g., CALVEG). Table 5-3 provide an example of the minimum level of content and detail required.

Fire ecology varies greatly across SCE’s service territory. The diversity of microclimates, topographic features, and vegetation types produce unique fire ecologies (“pyromes”) in each of SCE’s Fire Climate Zones (FCZ).

³⁰ Data as of 1/31/2023. The data includes only overhead reclosers.

³¹ Data as of 1/31/2023. Poles include Distribution, Transmission and Combo.

³² Data as of 1/31/2023.

³³ Currently, there are no operating front of the meter microgrids, but there are multiple projects in development.

SCE designated FCZs for operational analysis of the fire ecology of SCE’s service territory. These FCZs represent areas of homogenous climate, wind, vegetation, and topography, all of which play a significant role in the initiation, spread, and intensity of wildfires.

SCE has calibrated its Fire Potential Index (FPI) metrics to the historical presence of significant wind driven fires in each climate zone. A more detailed discussion of this calibration can be found in Section 6.4.3.

In this section, SCE presents the data associated for each prompt based on its FCZ designation. For reference, see FCZ map in Figure SCE 5-02 below.

Figure SCE 5-02 - SCE Fire Climate Zones³⁴

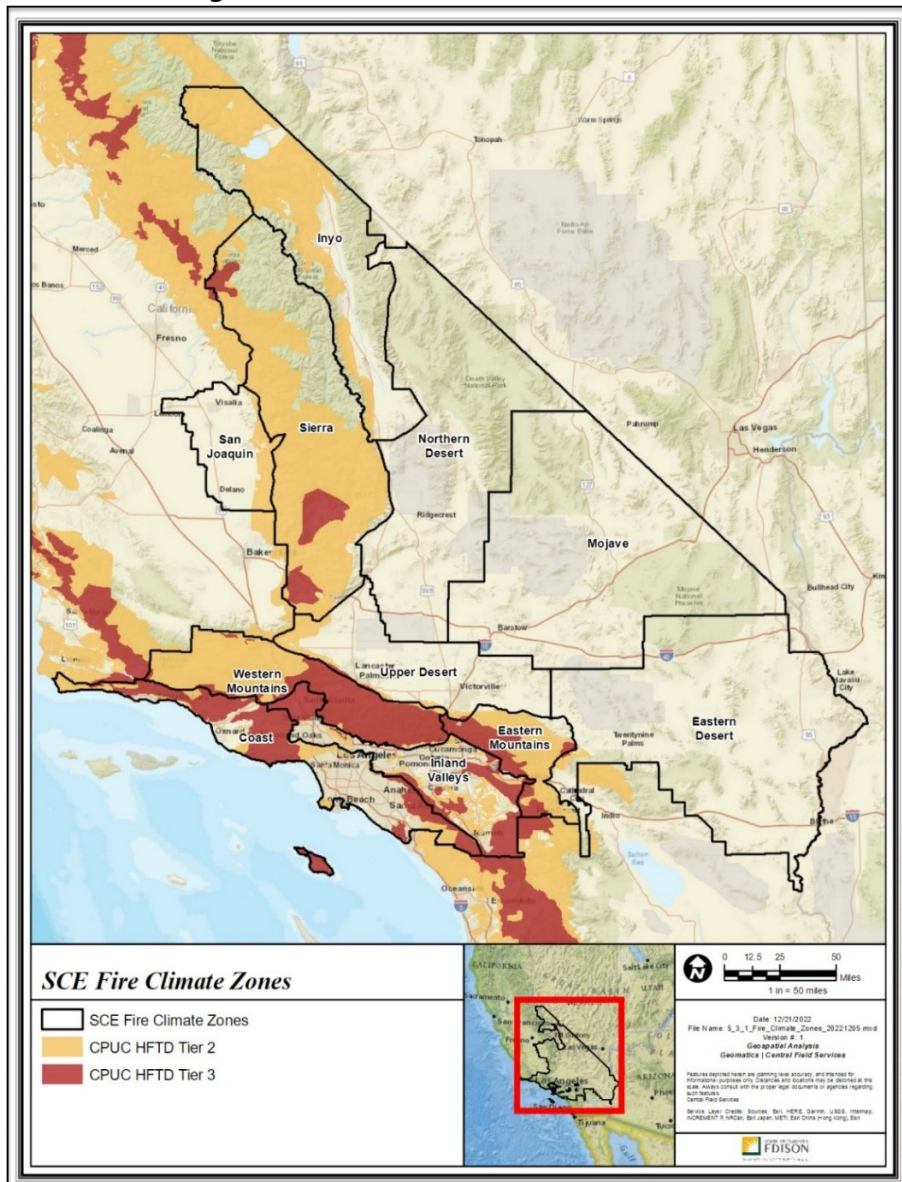

³⁴ Map as of 12/05/2022 and data source is from CPUC's Fire Threat Maps and Fire-Safety Rulemaking <https://www.cpuc.ca.gov/industries-and-topics/wildfires/fire-threat-maps-and-fire-safety-rulemaking>

- Fire Climate Zone 1 is located along the Southern California Coast from Ventura Santa Barbara

County south through Orange County.

- Temperatures in the region approach 100 degrees or more in the late spring and occasionally reach 100 degrees in the early fall, but annual average temperatures are around 70 degrees. This zone is strongly influenced by a layer of moist marine air and year-round mild temperatures. Moderate sea breezes are common through most of the year. Precipitation varies from 15 inches along the coastal plain to over 30 inches in the mountain areas.
- Change in average summer temperatures for this region are projected to increase by 3-5 degrees and a slight decrease in summer fuel moisture by the 2050s based on a Representative Concentration Pathway (RCP) 8.5 high emissions scenarios.³⁵
- Sundowner winds tend to increase in frequency across the Santa Ynez Mountain range in Santa Barbara County during the late spring and early summer months. Santa Ana winds periodically impact a much larger portion of this zone, particularly the Santa Monica Mountain range from October to May. These winds can result in periods of extreme fire weather if they occur coincident with dry fuels.
- Vegetation in the region consists primarily of grasses, coastal chaparral, and isolated timber.
- Wildfires in this region, though infrequent, can result in significant safety and financial consequences.
- Fire Climate Zone 2 is between mountain ranges from Santa Clarita, San Fernando, and San Gabriel Valleys and east to the Inland Empire.
- Sea breeze influences generally moderate summer heat in all portions of Zone 2, but on summer days when the sea breeze is weaker, temperatures often exceed 100 degrees. Winters are generally mild in this zone with daytime temperatures typically averaging around 60-70 degrees. Precipitation in this region ranges from 15-20 inches with locally higher amounts on the coastal slopes.
- Change in average summer temperatures for this region are projected to increase by 3-5 degrees and a slight decrease in summer fuel moisture by the 2050s based on RCP 8.5 high emissions scenarios.
- Moderate sea breezes are common in the western part of the zone, while Santa Ana winds are common on the mountain passes of the Angeles and San Bernardino National Forest, the Inland Empire, and the San Fernando and Santa Clarita Valleys.
- Vegetation in the region consists primary of grasses, coastal chaparral, and isolated timber.

³⁵ Pierce, D. W., J. F. Kalansky, and D. R. Cayan, (Scripps Institution of Oceanography). 2018. Climate, Drought, and Sea Level Rise Scenarios for the Fourth California Climate Assessment. California's Fourth Climate Change Assessment, California Energy Commission. Publication Number: CNRA-CEC-2018-006.

- Wildfires in this region are generally driven by dry fuels during the summer and Santa Ana wind driven fires in the fall, or winter, if precipitation is scarce. Wind driven fires in this region can consume vegetation over a large area in a short period of time with the potential for significant safety and financial consequences.
- Fire Climate Zone 3 is comprised of the complex topography (e.g., steep mountains and passes) of the Angeles and Los Padres National Forests north of the Santa Clarita, San Fernando, and San Gabriel Valleys terminating at the Cajon Pass.
- Temperatures in this zone vary drastically daily and seasonally due to both the elevation and seasonal solar angle across the east-west mountain range. Between 4,500- and 7,000-foot elevation, average highs can range from the 80s to low 90s in the summer and are generally in the 40s to low 50s in the winter. Average precipitation is between 15 to 30 inches and up to 45 inches at higher elevations along the windward slopes
- Change in average summer temperatures for this region are projected to increase by 3-5 degrees and a slight decrease in summer fuel moisture by the 2050s based on RCP 8.5 high emissions scenarios.
- Storm systems in the winter produce a mixture of rain and snow with snow common at higher elevations. Breezy conditions are common in this area. Santa Ana conditions and winter storms can each bring wind gusts in excess of 70 mph.
- Vegetation in this region is a mixture of grassland, chaparral, and small amounts of desert sagebrush.
- Fuel driven wildfires in this region are common in the summer months. A small percentage of fires in this location have been induced by lightning in the late summer. When wind driven fires occur in this region, they usually occur in the fall and are difficult to suppress given the complex topography.
- Fire Climate Zone 4 is comprised of the complex topography (e.g., steep mountains and passes) of the San Bernardino and San Jacinto Mountains and the adjacent desert areas east of the Cajon Pass.
- Temperatures vary considerably across this zone both daily and seasonally due to the elevation. Highs are generally in the 80-90s in the summer and 40-50s in the winter. Strong winter storm systems often produce rain and snow at higher elevations. Average precipitation is between 15 to 30 inches and up to 45 inches at higher elevations along the windward slopes.
- Change in average summer temperatures for this region are projected to increase by 3-5 degrees and a slight decrease in summer fuel moisture by the 2050s based on RCP 8.5 high emissions scenarios.
- Breezy wind conditions are common in this area with some of the strongest and most frequent winds occurring in the Banning Pass. During times of strong onshore flow and during Santa Ana

wind conditions, gusts can exceed 60 mph.

- Vegetation in this zone include a wide variety of desert sagebrush, timber, coastal chapparal, and grasslands.
- Wildfires in the region are primarily fuel driven and occur during the summer months. A small percentage of fires in this location are induced by lightning in the late summer. When wind driven fires occur in this region, they usually occur in the fall.
- Fire Climate Zone 5 is located east of the Banning pass. It is primarily comprised of flat desert land with few major geographic features.
- Summer high temperatures in this region are generally in the 100-110 range but can exceed 115 degrees. Winter temperatures average in the 60s. This zone is dry and typically only receives 5 to 10 inches of precipitation a year, with a significant portion of the annual precipitation occurring during the summer monsoons.
- Change in average summer temperatures for this region are projected to increase by 3-5 degrees and a slight decrease in summer fuel moisture by the 2050s based on RCP 8.5 high emissions scenarios.
- This area is subject to mild to moderate Santa Ana winds, though much of the geostrophic energy is dispersed over the broad plains. The strongest winds in this region occur along the Colorado River and near the Banning Pass.
- Vegetation in this zone is comprised of sparse desert sagebrush.
- Although this area experiences hot, dry, and sometimes windy conditions during the summer months, large fires in this region are infrequent given the sparsity of vegetation. Wildfires that do occur in this region generally occur along major transportation corridors during the summer months due to hot and dry conditions, as well as dry lightning during monsoons.
- Fire Climate Zone 6 is in the flat, high desert plain, including the base of the north slopes of the Angeles and San Bernardino Forests east of Tehachapi.
- Summer high temperatures in the region regularly reach 100 and occasionally exceed 110 degrees. Winter high temperatures typical range from the mid-50s to around 60 degrees. This region is a major rain shadow and averages only 5 to 10 inches of precipitation a year, with higher amounts along the Antelope Valley. Light snow can occur in some instances in this area.
- Change in average summer temperatures for this region are projected to increase by 3-5 degrees and a slight decrease in summer fuel moisture by the 2050s based on RCP 8.5 high emissions scenarios.
- This region is extremely windy, with southwest to northwest winds of 15-30 mph during the afternoon and evenings in the spring and summer. During pacific storms, during the late fall, winter, and early spring, wind gusts can easily exceed 60 mph.
- Vegetation in this region is mostly desert sagebrush with grassland, chaparral and timber along

the foothills.

- Wildfires in this region are wind driven and relatively small (e.g., 100-300 acres), though larger fires are frequent in the foothills around Antelope Valley.
- Fire Climate Zone 7 is in the eastern high desert region along the California-Nevada border. This area includes the Mojave Preserve and the Mesquite Wilderness Area and is comprised of large, broad valleys with mountains at the higher elevation.
- Temperatures in this area are generally 100-110 degrees but can occasionally exceed 115. Winter temperatures are mostly in the 60s. This region is dry (less than 10 inches) but is impacted by monsoonal conditions with summer thunderstorms and occasional light snow in the winter.
- Change in average summer temperatures for this region are projected to increase by 3-5 degrees and a slight decrease in summer fuel moisture by the 2050s based on RCP 8.5 high emissions scenarios.
- This is a windy region, though the broad plains tend to dissipate the geostrophic energy associated with winter and spring wind conditions.
- Vegetation in this region is primarily desert sagebrush with small patches of grassland and isolated timber at higher elevations.
- Wildfires in this region occur primarily in the summer due to persistent hot and dry conditions. Fires ignited by dry lightning related to monsoonal activities can be common in the area, though these fires tend to be contained to local areas due to the lack of widespread vegetation.
- Fire Climate Zone 8 is comprised of broad flat desert regions, such as Death Valley, which is below sea level, as well as the Panamint Range with elevations exceeding ten thousand feet.
- Temperatures are generally in the 105-115 range, but can exceed 120 in Death Valley, Winter temperatures are mostly in the 60-70 range. Though the region is dry (less than 10 inches annually), it can become humid during summer monsoonal conditions. Precipitation is slightly higher along the Panamint Range and some snow can occur in this area in the winter along the higher peaks.
- Change in average summer temperatures for this region are projected to increase by 3-5 degrees and a slight decrease in summer fuel moisture by the 2050s based on RCP 8.5 high emissions scenarios.
- This region is extremely windy throughout the year, with the strongest winds in the winter and spring.

- Desert sagebrush is the most common vegetation in the region, with scattered timber at higher elevations.
- Wildfires in this region occur primarily in the summer due to the prevailing hot and dry conditions. Fires ignited by dry lightning related to monsoonal activities can be quite common in the area. Although fire weather conditions are quite common in this region, due to the lack of vegetation wildfires tend to be infrequent.
- Fire Climate Zone 9 consists of the Eastern Sierras to the east and the White Mountains to the east with the Owens Valley oriented north-south in between.
- Annual average temperatures in this region can range from 30-40s in the mountain slopes to 70-80s in the valley regions. Summertime high temperatures average around 100 degrees in the Owens Valley. Most of the region is in a rain shadow and therefore generally dry, though the northwest portion of the region can receive 30-50" of precipitation, mostly in the form of snow.
- Change in average summer temperatures for this region are projected to increase by 3-5 degrees and a slight decrease in fuel moisture by the 2050s based on RCP 8.5 high emissions scenarios.
- This region can experience strong westerly down sloping winds, along the eastern slopes of the Sierras, which can reach into the Owens Valley. Typical winds are strong southerly winds during the day and light northerly winds at night. During the winter, strong northerly "Mono" winds can occur.
- This zone contains a desert sagebrush with areas of mixed timber and interspersed grasslands.
- Wildfires in this region can occur at any time of the year but are most frequent during the summer and fall. Large fires are infrequent, but most fires are wind driven and confined to the valley areas where sagebrush is more prevalent.
- Fire Climate Zone 10 is comprised of complex terrain, including the Sierra and Sequoia National Forests.
- Summer high temperatures range from the mid-70s to low 90s, with milder temperatures at higher elevations. Winter high temperatures can vary from the 30s at higher elevations to 60s in the southern valleys. Precipitation averages from 25-50 inches for a large portion of the northern part of the region where terrain is most complex. The southern portion of the region receives much less precipitation, ranging from 10-25 inches.

- Change in average summer temperatures for this region are projected to increase by 3-5 degrees and a slight decrease in fuel moisture by the 2050s based on RCP 8.5 high emissions scenarios.
- This is a windy area with southerly winds ranging from 15-25 mph during most afternoons in the summer. Winds can be much stronger from the west and northwest associated with storm systems the later fall, winter, and early spring.
- Vegetation in this region is mostly timber with some areas of mixed chaparral grassland and interspersed desert sage.
- Most of the wildfires in this region occurs during the summer months. Fuel driven fires are most frequent, but occasional, wind driven fires can occur in the far southern portion near Lake Isabella. This region experiences lightning ignitions more often than any other region in SCE's service territory.
- Fire Climate Zone 11 is comprised on the San Joaquin Valley inclusive of the agricultural communities. The eastern portion of this zone include the western foothills of the Sierra Mountain range.
- This region is often hot and dry in the summer with daily highs in the 90s to 100s. Winter temperatures vary from 40s-50s in the higher elevations and 50-60s in the San Joaquin Valley. The zone receives 5-10 inches of precipitation in the western portion of the zone while the eastern slopes receive an average of 20-25 inches.
- Change in average summer temperatures for this region are projected to increase by 3-5 degrees and a slight decrease in fuel moisture by the 2050s based on RCP 8.5 high emissions scenarios.
- This is one of the least windy portions of SCE's service territory with southwest to northwest winds reaching 5-15 mph most days in the summer.
- The dominant vegetation in this region is agricultural land, with grassland, chaparral and mixed timber on the eastern slopes.
- Wildfires in this region are primarily fuel driven and mainly occur along the eastern slopes of the Sierra foothills.

Figure SCE 5-03 below shows the vegetative coverage (raster or polygon) across SCE's service territory. The source data for this map is publicly available from the North American Wildland Fuels Database and the spatial data can be downloaded at <https://fuels.mtri.org/map>. Further, SCE provides tabulated statistics of the vegetative coverage across its service territory in Table 5-3 below.

Figure SCE 5-03 - Vegetative Coverage across SCE's Service Territory³⁶

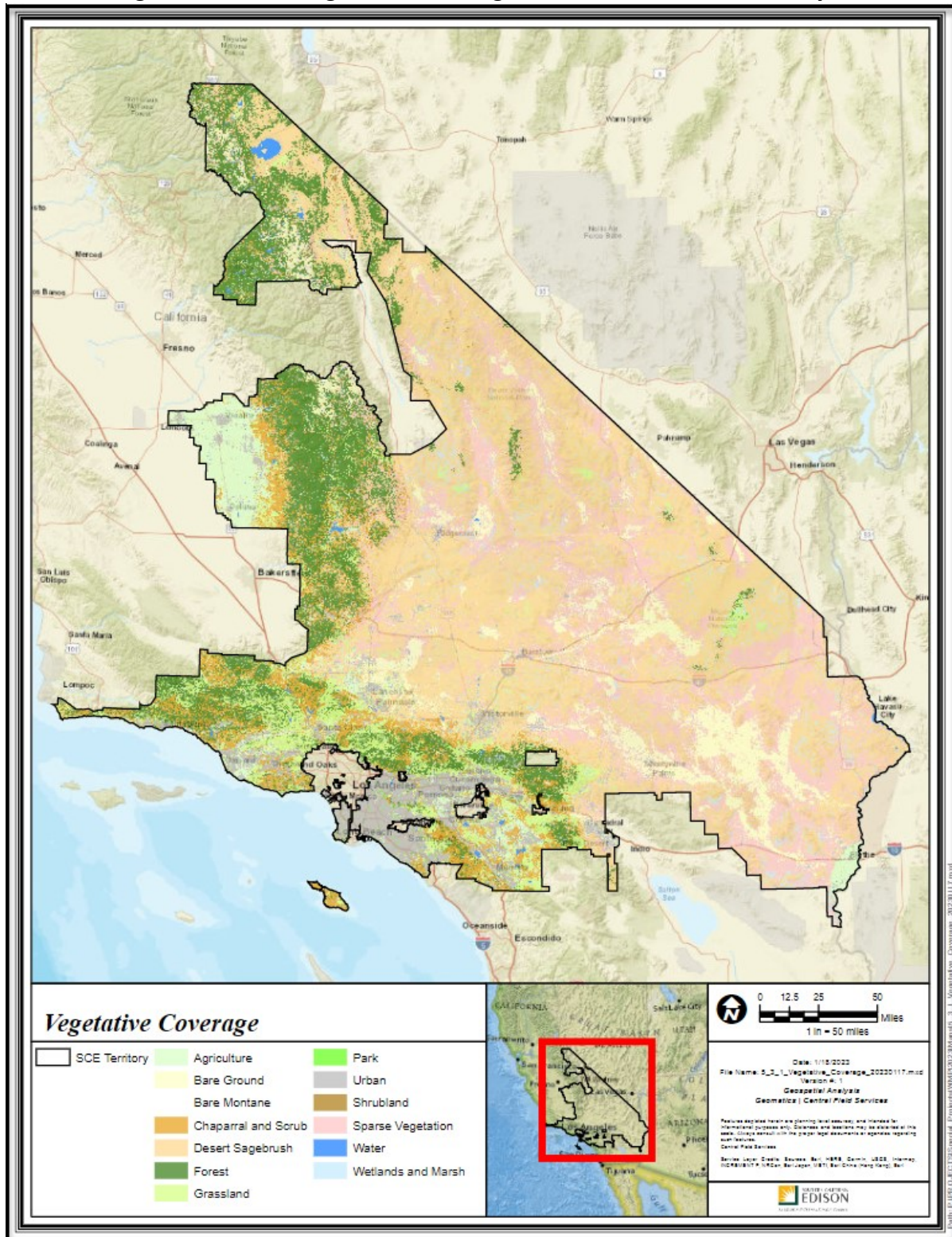

³⁶ Data as of 11/10/2022 and data source is from North American Wildland Fuels Database. Michigan Tech Research Institute, United States Forest Service, and University of Washington. <https://fuels.mtri.org/map>

Table 5-3 - Existing Vegetation Types in the SCE Service Territory³⁷

Vegetation Type	Acres	Percentage of Service Territory
Creosote Bush Desert Scrub	6,249,404.31	18.69%
Sparse Vegetation	6,161,530.43	18.43%
Desert Scrub	4,471,176.06	13.37%
Bare Ground	2,579,281.66	7.71%
Chaparral	1,689,368.73	5.05%
Road	1,396,404.65	4.18%
Agriculture	1,241,608.87	3.71%
Grassland	1,131,963.50	3.39%
Western Herbaceous Wetland	918,398.04	2.75%
Big Sagebrush Shrubland and Steppe	789,642.36	2.36%
Introduced Annual Grassland	682,499.64	2.04%
Western Oak Woodland and Savanna	675,722.80	2.02%
Pinyon-Juniper Woodland	557,240.62	1.67%
Urban	515,845.62	1.54%
Conifer-Oak Forest and Woodland	468,209.30	1.40%
Salt Desert Scrub	451,061.27	1.35%

³⁷ Data as of 11/10/2022 and data source is from North American Wildland Fuels Database. Michigan Tech Research Institute, United States Forest Service, and University of Washington. <https://fuels.mtri.org/map>

Vegetation Type	Acres	Percentage of Service Territory
Ponderosa Pine Forest, Woodland and Savanna	426,642.37	1.28%
California Mixed Evergreen Forest and Woodland	426,139.62	1.27%
Douglas-fir-Grand Fir-White Fir Forest and Woodland	385,593.53	1.15%
Red Fir Forest and Woodland	359,842.73	1.08%
Douglas-fir-Ponderosa Pine-Lodgepole Pine Forest and Woodland	358,598.82	1.07%
Pacific Coastal Scrub	305,700.20	0.91%
Low Sagebrush Shrubland and Steppe	251,406.54	0.75%
Subalpine Woodland and Parkland	175,277.86	0.52%
Water	148,975.90	0.45%
Alpine Dwarf-Shrubland, Fell-field and Meadow	145,743.68	0.44%
Lodgepole Pine Forest and Woodland	130,419.54	0.39%
Mountain Mahogany Woodland and Shrubland	84,634.48	0.25%
Introduced Annual and Biennial Forbland	75,029.51	0.22%
Park	44,754.20	0.13%
Aspen Forest, Woodland, and Parkland	41,762.06	0.12%
Limber Pine Woodland	31,111.78	0.09%
Greasewood Shrubland	23,020.42	0.07%
Introduced Riparian Vegetation	11,090.47	0.03%

Vegetation Type	Acres	Percentage of Service Territory
Aspen-Mixed Conifer Forest and Woodland	6,939.70	0.02%
Dry Tundra	5,889.99	0.02%
Mountain Hemlock Forest and Woodland	5,755.78	0.02%
Introduced Perennial Grassland and Forbland	4,533.04	0.01%
Glacier	3,971.28	0.01%
Mine	2,814.16	0.01%
Pacific Coastal Marsh	1,303.01	0.00%
Blackbrush Shrubland	908.38	0.00%
Juniper Woodland and Savanna	434.81	0.00%
Deciduous Shrubland	38.47	0.00%
Mesquite Woodland and Scrub	12.70	0.00%
Redwood Forest and Woodland	1.17	0.00%
Total	33,437,704.06	100.00%

5.3.2 Catastrophic Wildfire History

The electrical corporation must provide a brief narrative summarizing its wildfire history for the past 20 years (2002-2022) as recorded by the electrical corporation, CAL FIRE, or another authoritative sources. For this section, wildfire history must be limited to electrical corporation ignited catastrophic fires (i.e., fires that caused at least one death, damaged over 500 structures, or burned over 5,000 acres). This includes catastrophic wildfire ignitions reported to the CPUC that may be attributable to facilities or equipment owned by the electrical corporation and where the cause of the ignition is still under investigation.³⁸ Electrical corporations must clearly denote those ignitions as still under investigation. In

³⁸ CPUC emergency reporting instructions: <https://www.cpuc.ca.gov/regulatory-services/safety/emergency-reporting>.

addition, the electrical corporation must provide catastrophic wildfire statistics in tabular form, including the following key metrics:

- *Ignition date*
- *Fire name*
- *Official cause (if known)*
- *Size (acres)*
- *Number of fatalities*
- *Number of structures damaged*
- *Estimated financial loss (U.S. dollars)*

Table 5-4 provides an example of the content and level of detail required for the tabulated historical catastrophic utility-related wildfire statistics.³⁹ The electrical corporation must provide an authoritative government source (e.g., CPUC, CAL FIRE, U.S. Forest Service, or local fire authority) for its reporting of wildfire history data and loss/damage estimates, to the extent this information is available.

SCE provides the requested information in Table 5-4 below. For purposes of this table, SCE has listed wildfires which meet the definition of “catastrophic” as provided by Energy Safety, and where an investigating agency opined that SCE utility infrastructure was the likely cause or SCE reported to the CPUC as potentially involving utility infrastructure but where the cause is still under investigation. For those listed which are still under investigation, an official cause has not been provided. The information provided below should not be construed as an admission of any wrongdoing or liability by SCE. SCE further notes that the damages metrics provided may be tracked by other agencies and thus, SCE does not guarantee the accuracy of such information. Additionally, in many instances the cause of wildfires are still under investigation and even where an Authority Having Jurisdiction (AHJ) has issued a report on the cause, SCE may dispute the conclusions of such report.

³⁹ Annual information included in this section must align with Table 2 of the QDR.

Table 5-4 - Catastrophic Electrical Corporation Wildfires

Ignition Date⁴⁰	Fire Name⁴⁰	Official Cause⁴¹	Fire Size (Acres)⁴⁰	# of Fatalities⁴⁰	# of Structures Destroyed and Damaged⁴⁰	Financial Loss (US\$)⁴²
10/20/2007	RANCH	USFS opined fire caused by SCE equipment	> 58,000	0	9 Structures Damaged or Destroyed	Data not available
11/14/2008	SAYRE	USFS opined fire caused by SCE equipment	11,262	0	604 Structures Destroyed / 147 Structures Damaged	Data not available
02/06/2015	ROUND	CAL FIRE opined fire caused by SCE equipment	7,000	0	43 Structures Destroyed / 5 Structures Damaged	Data not available
08/18/2016	REY	USFS opined fire caused by SCE equipment	32,606	0	5 Structures Destroyed	Data not available
12/04/2017	THOMAS/ KOENIGSTEIN	CAL FIRE & VCFD opined that fires caused by SCE equipment	281,893	2	1,060 Structures Destroyed / 274 Structures Damaged	Data not available
12/05/2017	CREEK	USFS opined that fire caused by LADWP equipment	15,619	0	123 Structures Destroyed / 81 Structures Damaged	Data not available
12/05/2017	RYE	CAL FIRE opined fire caused by SCE equipment	6,049	0	6 Structures Destroyed / 3 Structures Damaged	Data not available

⁴⁰ Wildfire history data is derived from various sources including SCE incident reports and related communications, CAL FIRE (<https://www.fire.ca.gov/stats-events/>), and U.S Forest Service (<https://nap.nwcg.gov/NAP/>).

⁴¹ Where an Official Cause is stated, the source of the Official Cause was obtained from the identified agency's Fire Investigation Cause and Origin Report.

⁴² In some instances, an agency may provide data related to one component of financial loss such as costs associated with suppression efforts, however, SCE is not aware of an authoritative government source that provides all-inclusive data regarding financial loss.

Ignition Date ⁴⁰	Fire Name ⁴⁰	Official Cause ⁴¹	Fire Size (Acres) ⁴⁰	# of Fatalities ⁴⁰	# of Structures Destroyed and Damaged ⁴⁰	Financial Loss (US\$) ⁴²
11/08/2018	WOOLSEY	CAL FIRE opined fire caused by SCE equipment and unidentified communication line	96,949	3	1,643 Structures Destroyed / 364 Structures Damaged	Data not available
10/10/2019	SADDLE RIDGE	Los Angeles City Fire Dept opined that the cause of the fire is undetermined	8,799	1	24 Structures Destroyed / 91 Structures Damaged	Data not available
09/06/2020	BOBCAT	No official cause. Under investigation	115,997	0	169 Structures Destroyed / 47 Structures Damaged	Data not available
10/26/2020	SILVERADO	No official cause. Under investigation	12,466	0	5 Structures Destroyed / 11 Structures Damaged	Data not available
09/05/2022	FAIRVIEW	No official cause. Under investigation	28,307	2	36 Structures Destroyed / 8 Structures Damaged	Data not available

SCE identifies the following wildfires which meet the definition of “catastrophic” over the past 20 years wherein SCE, CAL FIRE, or another authoritative source opined that the fire was likely ignited by electrical equipment, or the cause of the fire is still under investigation. The information provided below should not be construed as an admission of any wrongdoing or liability by SCE.

- i The **Ranch Fire** ignited on 10/20/2007 wherein the United States Department of Agriculture (USDA) United States Forest Services (USFS) opined that during extreme Santa Ana Wind conditions, a preform attached to a bell-type insulator on a distribution circuit broke, causing the insulator to pull away from the steel tower and suspending it while still attached to the tap line. The winds caused the conductor to swing back and forth allowing the bell insulator to make contact with a section of the tower and ignited the fire.

- ii The **Sayre Fire** ignited on 11/14/2008 wherein the USDA (USFS) opined that phase-to-phase conductor contact during windy conditions ignited the fire. However, SCE disputed this opinion insofar as human activity, including the possibility of an intentionally lit fire, could not be ruled out as a cause of the ignition.
- iii The **Round Fire** ignited on 2/6/2015 wherein CAL FIRE opined that a decayed tree fell into an overhead line and ignited the fire.
- iv The **Rey Fire** ignited on 8/18/2016 wherein the USDA (USFS) opined that a large portion of an oak tree split and landed on underbuilt communication lines which pulled down the poles causing an electric line to separate and ignited the fire.
- v The **Thomas Fire/Koenigstein Fire** ignited on 12/4/2017 wherein CAL FIRE and Ventura County Fire Department opined that the Thomas Fire ignited from phase-to-phase conductor contact in a wind event and the Koenigstein Fire ignited from downed energized conductor during the same wind event. These fires are still under investigation by SCE and in active litigation.
- vi The **Rye Fire** ignited on 12/5/2017 wherein CAL FIRE opined that a strand-vise device which connected a transmission down-guy to the guy anchor failed, causing the guy wire to whip through the air and make contact with a jumper on an underbuilt distribution circuit and ignited the fire.
- vii The **Creek Fire** ignited on 12/5/2017 wherein the USDA (USFS) opined that powerlines on an LADWP-owned transmission circuit ignited the fire. This fire is still under investigation by SCE and in active litigation.
- viii The **Woolsey Fire** ignited on 11/8/2018 wherein CAL FIRE opined that a slack transmission down-guy made contact in high winds with a jumper on an underbuilt distribution circuit energizing distribution guy wires and energizing SCE and unidentified communications lines resulting in two ignition sites. This fire is still under investigation by SCE and in active litigation.
- ix The **Saddle Ridge Fire** ignited on 10/10/2019 wherein Los Angeles City Fire Department opined that the cause of the fire was undetermined. This fire is still under investigation by SCE and in active litigation.
- x The **Bobcat Fire** ignited on 9/6/2020 wherein the cause is still under investigation by SCE and the USDA (USFS).
- xi The **Silverado Fire** ignited on 10/26/2020 wherein the cause is still under investigation by SCE and the Orange County Fire Authority.
- xii The **Fairview Fire** ignited on 9/5/2022 wherein the cause of the fire is still under investigation by SCE and CAL FIRE.

[Related Requirement from Section 10]:

In addition to the above potential sources of lessons learned, the electric corporation must detail lessons learned from any and each catastrophic wildfire ignited by its facilities or equipment in the past 20 years, as listed in Section 5.3.2. The electric corporation must also detail specific mitigation measures implemented as a result of these lessons learned and demonstrate how the mitigation measures are being integrated into the electric corporation's wildfire mitigation strategy.

As discussed in Section 11, SCE has a formal process to investigate ignitions of all sizes (catastrophic and non-catastrophic) and SCE uses this process to evaluate risk events. This can lead to changes to SCE's inspection practices, vegetation management practices, modifications to SCE's engineering standards, or the introduction of new mitigation strategies. Section 11 provides further detail on SCE's risk event evaluation process and how that effort can translate into these changes.

In terms of lessons learned and resulting mitigations from these evaluations, SCE provides a few examples below. For example, SCE had seen an increase in ignitions associated with secondary conductors, and as a result, SCE modified its inspection form with new questions to capture and remediate these issues. In another example, a small fire (<1 acre) occurred in 2019 associated with SCE equipment, due to degradation occurring at the top of a crossarm. In response to this evaluation, SCE began inspecting transmission and distribution structures both from the ground and aerially, to develop a 360-degree inspection of the structure. This has served as the basis for SCE's asset inspection programs which are detailed in Section 8.

Several wildfires are still under investigation. There are some for which SCE filed an Electrical Safety Incident Report in an abundance of caution, even though SCE affirmatively disputes that its equipment was associated with ignition based on current information. Once these ongoing investigations are complete SCE will evaluate opportunities to incorporate any lessons learned into its construction and maintenance practices or future mitigation strategies. Separately, SCE is in the process of implementing system enhancements to strengthen SCE's electric system, support community engagement activities, and make investments in safety studies, pursuant to an agreement between SCE and the CPUC's Safety Enforcement Division, as adopted by the CPUC in Resolution SED-5 and SED-5A.⁴³ Further information can be found through the CPUC's website.⁴⁴

The electrical corporation must also provide a map or set of maps illustrating the catastrophic wildfires. One representative map must appear in the main body of the WMP, with supplemental or detailed maps provided in Appendix C as needed. The maps must include the following:

- *Fire perimeters*
- *Legend and text labeling each fire perimeter*
- *County lines*

Figure 5-1 below maps the catastrophic wildfires identified in Table 5-4 above. An additional 12 maps reflecting individual catastrophic wildfire are provided in Appendix C: Additional Maps.

⁴³ RESOLUTION SED-5 APPROVING ADMINISTRATIVE CONSENT ORDER AND AGREEMENT OF THE SAFETY AND ENFORCEMENT DIVISION AND SOUTHERN CALIFORNIA EDISON COMPANY (U338-E) REGARDING THE 2017/2018 SOUTHERN CALIFORNIA FIRES PURSUANT TO RESOLUTION M-4846.

⁴⁴ <https://www.cpuc.ca.gov/regulatory-services/enforcement-and-citations>

Figure 5-1 - Catastrophic Wildfire History Map ⁴⁵



⁴⁵ Map as of 1/5/2023 and data source is from CalFire Fire and Resource Assessment Program (FRAP) GIS Database. <https://frap.fire.ca.gov/mapping/gis-data/>

5.3.3 High Fire Threat Districts

The electrical corporation must provide a brief narrative identifying the CPUC-defined HFTD across its territory. The electrical corporation must also provide a map of its service territory overlaid with the HFTD. The map must be accompanied by tabulated statistics on the CPUC- defined HFTD including the following minimum information:

- *Total area of the electrical corporation’s service territory in the HFTD (sq. mi.)*
- *The electrical corporation’s service territory in the HFTD as a percentage of its total service territory (%)*

For the HFTD map, the HFTD layer(s) (raster or polygon) must cover the electrical corporation’s service territory and the HFTD layer must match the latest boundaries as published by the CPUC. Table 5-5 provides an example of the content and level of detail required.

SCE’s High Fire Risk Areas generally follow the historical wildfire patterns described in the previous section. Approximately one third of SCE’s service territory is comprised of areas designated as either elevated or extreme by the Commission’s High Fire Threat District (HFTD). In response to 2007 wildfires, the Commission adopted Decisions (D) 12-01-032 and D.14-01-010 in Rulemaking 08-11-005 to develop statewide fire hazard maps that depict the locations with environmental conditions in which there is potential for the ignition and spread of utility involved ignition events. These HFTD maps identify locations for enhanced mitigation activities such as inspections and vegetation management adopted in Decision 17-12-024. Decision 15-05-006 modified the HFTD boundaries within SCE’s service territory to include areas that were not previously designated.

Figure SCE 5-04 below shows HFTD (raster or polygon) in SCE’s service area. The source data for this map is publicly available from the CPUC website, and the spatial data can be downloaded at <https://www.cpuc.ca.gov/industries-and-topics/wildfires/fire-threat-maps-and-fire-safety-rulemaking>. Further, SCE provides HFTD statistics for its service area in Table 5-5 below.

Figure SCE 5-05 - HFTD For SCE Territory⁴⁶

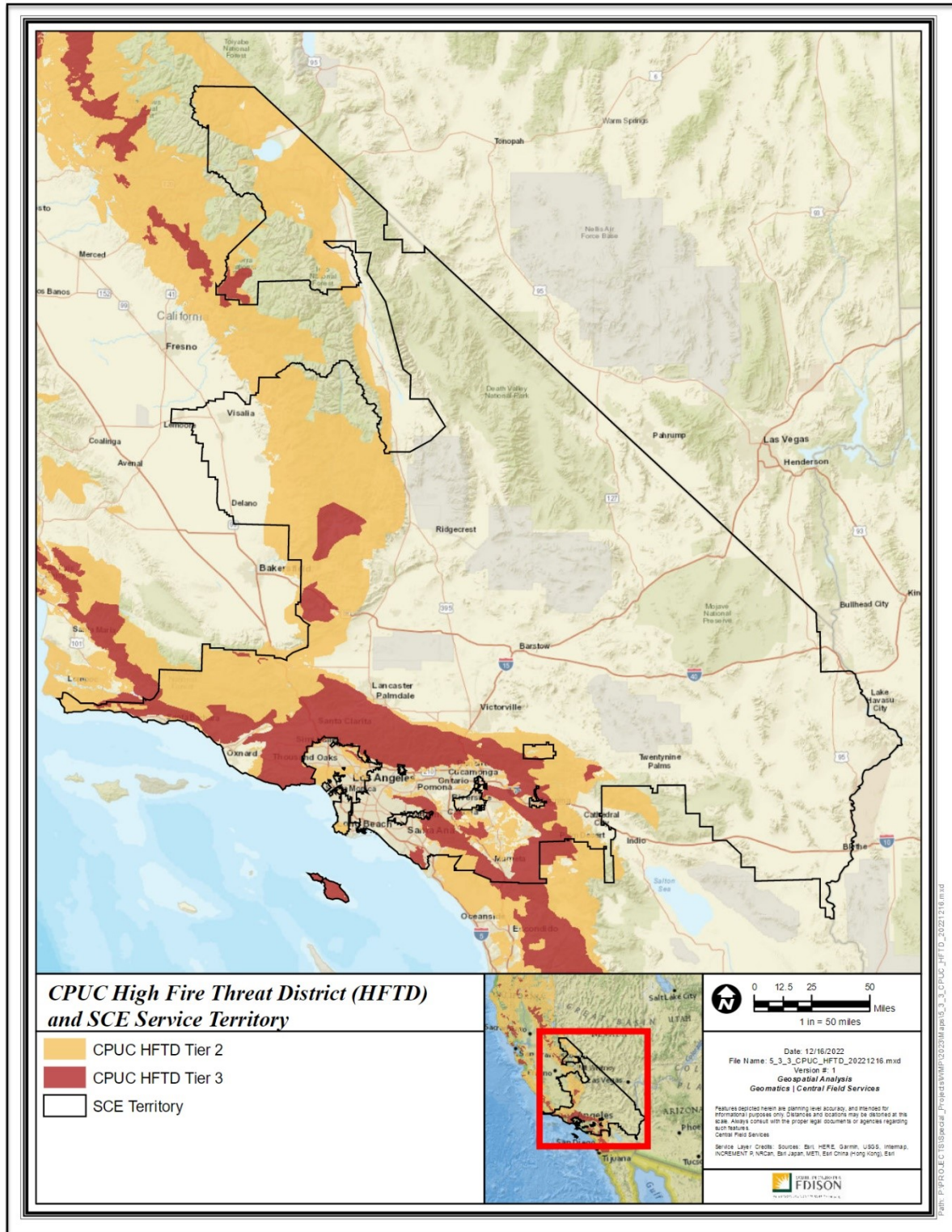

⁴⁶ Map as of 11/3/22 and data source is from CPUC's Fire Threat Maps and Fire-Safety Rulemaking <https://www.cpuc.ca.gov/industries-and-topics/wildfires/fire-threat-maps-and-fire-safety-rulemaking>

Table 5-5 - CPUC’s HFTD Statistics⁴⁷

High Fire Threat District	Total Area of Individual District (sq. mi.)	% of Total Service Territory
Non-HFTD	38,065	73%
Tier 2	9,544	18%
Tier 3	4,662	9%
Total	52,270	100%

5.3.4 Climate Change

It is critical for the electrical corporation to understand general climate conditions and how climate change impacts the frequency and the intensity of extreme weather events and the vegetation that fuels fires.

The risk of significant⁴⁸ wildfire events continue to grow due to a range of changing climatic conditions that foster the initiation, spread, and intensity of wildfires. These developments, in turn, have the potential to increase associated wildfire consequences (e.g., average acres burned, facilities impacted). Extreme multi-year droughts (i.e., increased temperatures and decreased precipitation) continue to lead to increases in dead vegetation, while increases in the frequency and/or magnitude of wind events can compound any resulting fires. Projections by Westerling (2018) point to a future defined by intensifying and, at times, expanding areas of elevated wildfire risk, strongly driven by changes to underlying climate conditions.

5.3.4.1 General Climate Conditions

The electrical corporation must provide an overview of the general weather conditions and climate across its service territory in the past 30- to 40-year period.⁴⁹ The narrative must include, at a minimum, the following:

- *Average temperatures throughout the year*
- *Extreme temperatures that may occur and when and where they may occur*
- *Precipitation throughout the year*

The electrical corporation must also provide a graph of the average precipitation and maximum and minimum temperatures for each distinct climatic region of its service territory. At a minimum, it must provide one graph in the main body of the report. Figure 5-2 provides an example of the climate/weather graph.

⁴⁷ Data as of 12/14/22.

⁴⁸ In its 2022 Risk Assessment and Mitigation Phase (RAMP) filing, SCE defines “significant” fires as: Significant Fires are simulated fires that, at 8 hours after ignition, burned more than 10,000 acres or had at least one fatality or had at least 50 structures impacted.

⁴⁹ Annual information included in this section must align with Table 4 of the QDR.

Yearly average maximum and minimum temperatures peak in August with minimum values occurring in December and January for all fire climate zones. Average maximum temperatures in the summer range from near 100 in the deserts to around 80 near the coast. Annual precipitation amounts are greatest in the mountains with most of the annual precipitation occurring between November and April. Seasonal drought conditions occur during the summer months, but monsoon moisture in July and August can provide some relief in the mountains and deserts most years.

Below is the analysis on the Annual Mean Climatology (Temperature and Precipitation) for the 11 Fire Climate Zones (FCZ).

Average maximum temperatures for this zone peak in the low 80s in August while dropping to near 60 degrees in December and January. Average minimum temperatures range from the upper 40s in the winter to the lower 60s in the summer. Precipitation is highest from December through March with only trace amounts occurring during the summer.

Average maximum temperatures for this zone peak in the lower 90s in August while dropping to the lower 60s in December and January. Average minimum temperatures range from the upper 40s in the winter to the upper 60s in summer. Precipitation is highest from December through March with only trace amounts occurring during the summer.

Average maximum temperatures for this zone peak in the lower 80s in August while dropping to near 50 in December and January. Average minimum temperatures range from near 40 in the winter to the mid-60s in summer. Precipitation is highest from December through March with only trace amounts occurring during the summer.

Average maximum temperatures for this zone peak in the lower 80s in August while dropping to the upper 40s in December and January. Average minimum temperatures range from the upper 30s in the winter to the mid-60s in summer. Precipitation is highest from December through March with minimal amounts occurring in the summer.

Average maximum temperatures for this zone peak around 100 in July and August while dropping to near 60 in December and January. Average minimum temperatures range from the mid-40s in the winter to the upper 70s in summer. Precipitation amounts are low throughout the year but are highest from December through February.

Average maximum temperatures for this zone peak in the mid-90s in July and August while dropping to the mid-50s in December and January. Average minimum temperatures range from near 40 in the winter to near 70 in summer. Precipitation amounts are low throughout the year but are highest from December through March.

Average maximum temperatures for this zone peak in the upper 90s in July and August while dropping to the mid-50s in December and January. Average minimum temperatures range from near 40 in the winter to the mid-70s in summer. Precipitation amounts are low throughout the year but are highest from December through February.

Average maximum temperatures for this zone peak in the mid-90s in July and August while dropping to the low 50s in December and January. Average minimum temperatures range from near 40 in the winter to the low 70s in summer. Precipitation amounts are low throughout the year but are highest in January and February.

Average maximum temperatures for this zone peak in the upper 70s in July and August while dropping to the upper 40s in December and January. Average minimum temperatures range from the upper 20s in the winter to near 60 in summer. Precipitation is highest from November through March with lower amounts occurring during the summer.

Average maximum temperatures for this zone peak in the mid-70s in July and August while dropping to the near 40 in December and January. Average minimum temperatures range from near 30 in the winter to near 60 in summer. Precipitation is highest from November through March with lower amounts occurring during the summer.

Average maximum temperatures for this zone peak in the upper 90s in July and August while dropping to the upper 50s in December and January. Average minimum temperatures range from the mid-40s in the winter to the upper 60s in summer. Precipitation is highest from December through March with lower amounts occurring during the summer.

SCE provides graphs of temperature and precipitation for these 11 fire climate zones. Figure 5-2 provides the temperature and precipitation from 1980 to 2021 for fire climate zone 1. Figures for the remaining 10 fire climate zones are provided in Appendix F: Supplemental Information. Data source is from SCE's 40-year internal dataset which was generated by third party vendor, Atmospheric Data Solutions (ADS) by downscaling the Climate Forecast System Reanalysis (CFSR) data which comes from the National Center for Atmospheric Research (NCAR).

Figure 5-2 - Annual Mean Climatology for SCE Service Territory (Fire Climate 1-Coast)⁵⁰

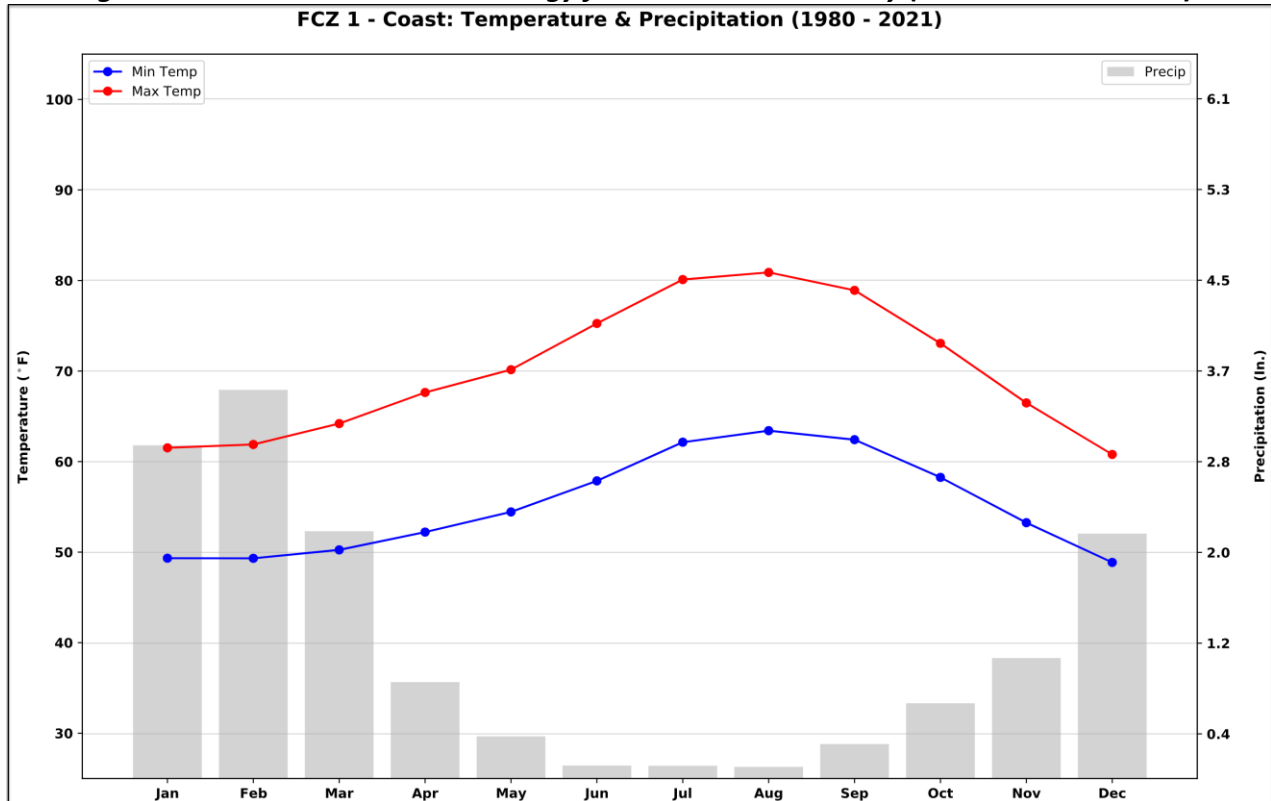

5.3.4.2 Climate Change Phenomena and Trends

The electrical corporation must provide a brief discussion of the local impacts of anticipated climate change phenomena and trends across its service territory. In addition, the electrical corporation must provide graphs/charts illustrating:

- Mean annual temperature (Figure 5-3)
- Mean annual precipitation (Figure 5-4)
- Projected changes in minimum and maximum daily temperatures (Figure 5-5)

The electrical corporation must also indicate the increase in extreme fire danger days (historic 95th-percentile conditions) due to climate change, considering (at a minimum) the combination of warmer temperatures, drier vegetation, and changes in high-wind events (e.g., Santa Ana winds, Diablo winds, Sundowners) for both winter/spring and summer/fall periods throughout the electrical corporation service territory. Figure 5-6 provides an example of the required information on projections of extreme fire dangers.

The electrical corporation must cite all source(s) used to write and illustrate this section.

Mean annual temperatures since 1980 have been steadily increasing across the SCE service area since the early to mid-1990s, while mean annual precipitation has slowly decreased over the last four decades. In addition, there have been periods of severe drought across portions of the SCE service territory since 2000. Data source is from SCE’s 40-year internal dataset which was generated by third party vendor, Atmospheric Data Solutions (ADS), by downscaling the Climate Forecast System Reanalysis (CFSR) data from the National

⁵⁰ Figure as of 10/26/2022 and data source is from <https://psl.noaa.gov/data/gridded/data.narr.html>.

Center for Atmospheric Research (NCAR). The data was downscaled to a 2-km horizontal resolution at an hourly temporal resolution going back to 1980.

Figure 5-3 below shows annual temperature and Figure 5-4 below shows annual precipitation for SCE's service area.

Figure 5-3 - Mean Annual Temperature for SCE Service Territory, 1980s–2021⁵¹

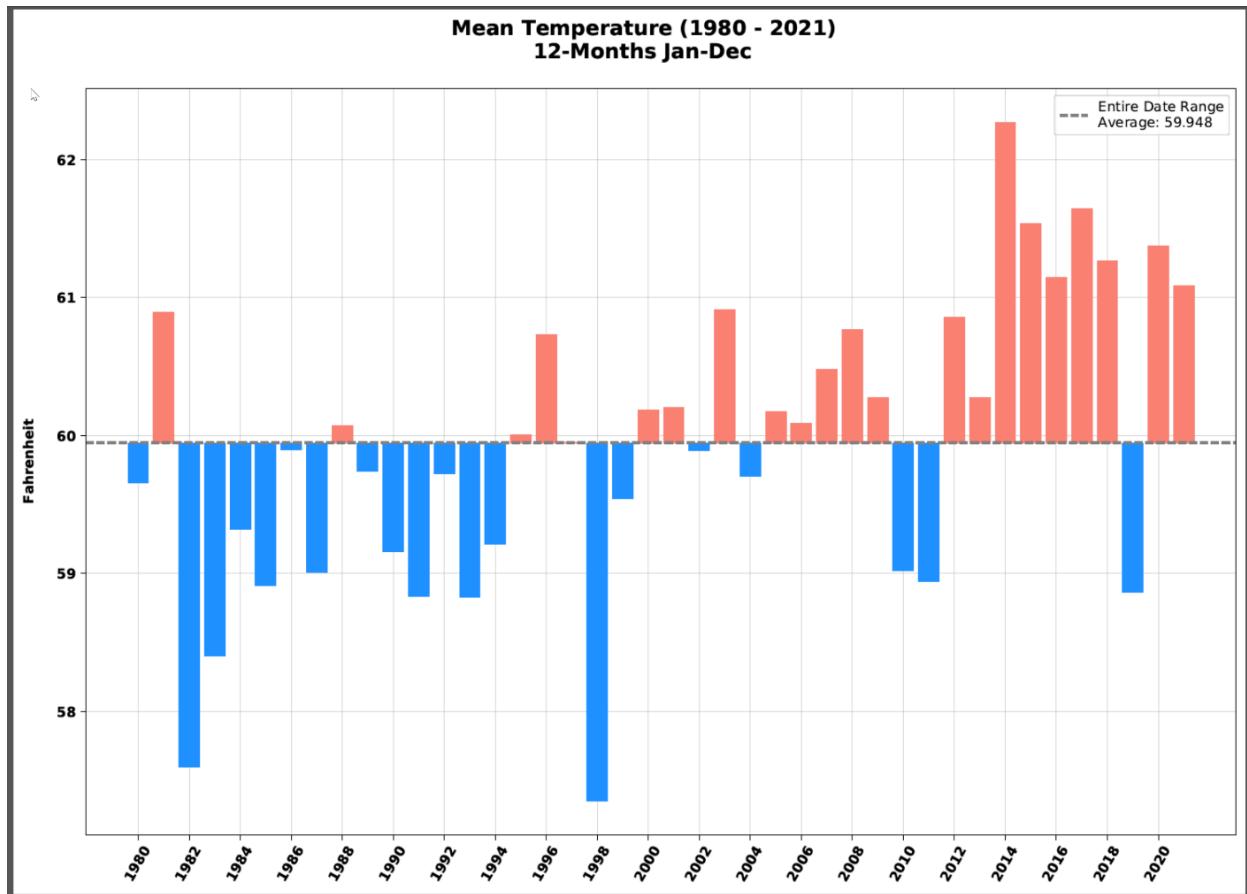

⁵¹ Figure as of 11/15/2022 and data source is from <https://psl.noaa.gov/data/gridded/data.narr.html>.

Figure 5-4 - Mean Annual Precipitation for SCE Service Territory, 1980s–2021⁵²

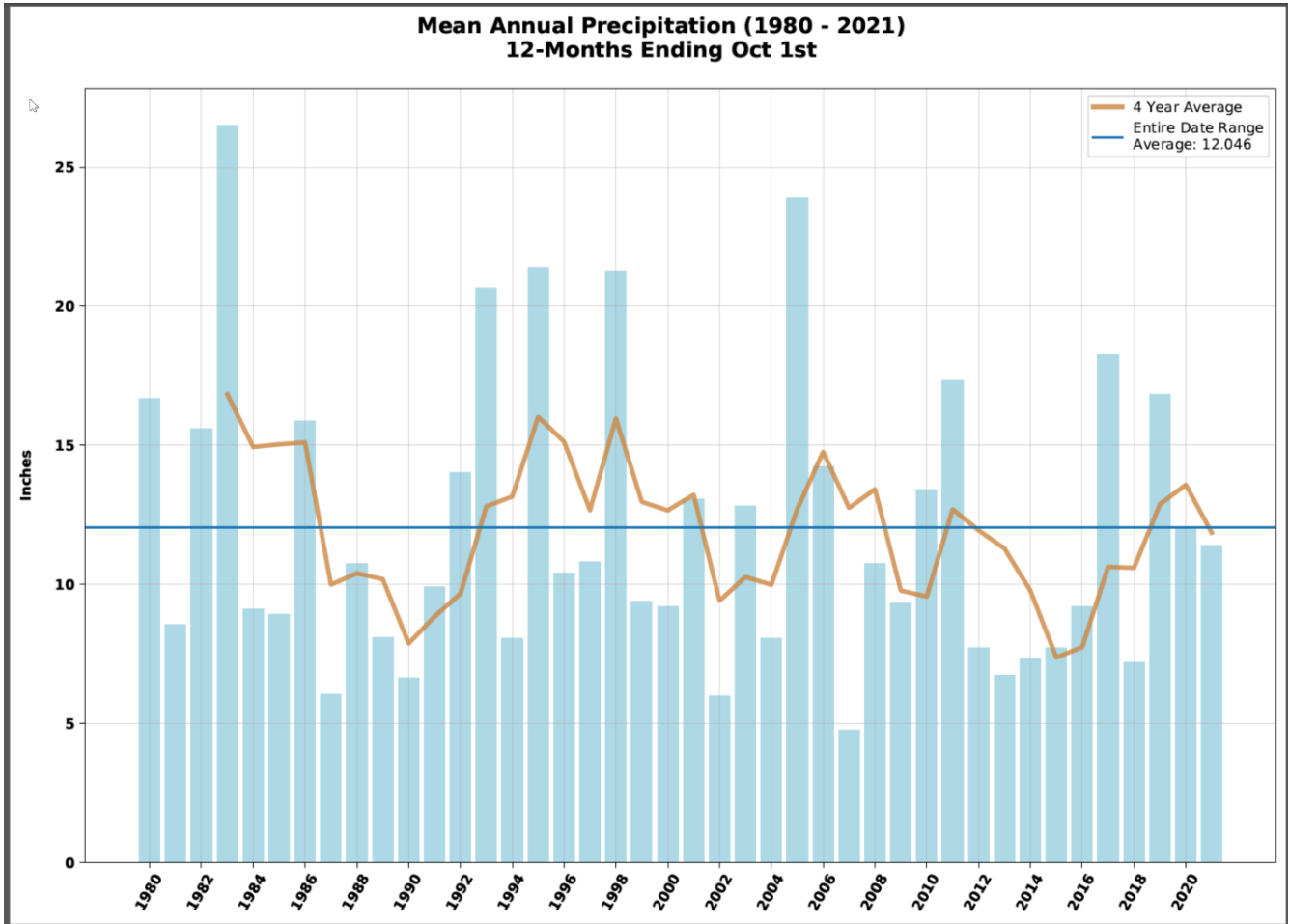

⁵² Figure as of 11/15/2022 and data source is from <https://psl.noaa.gov/data/gridded/data.narr.html>.

Figure 5-5 presents average daily maximum and minimum temperature values observed and projected for fire climate zone 1 using data from California’s 4th Climate Change Assessment. An additional 10 figures reflecting this information are provided in Appendix F: Supplemental Information. These daily average maximum and minimum values are calculated as 365-day rolling averages. Fire Climate Zones are defined as regions in which SCE observes similar climatic conditions related to fire weather conditions.

Figure 5-5 - Projected Change in Maximum Temperature (Daytime Highs) and Minimum Temperature (Nighttime lows) Through 2100 for the Service Territory (FCZ 1 – Coast)⁵³

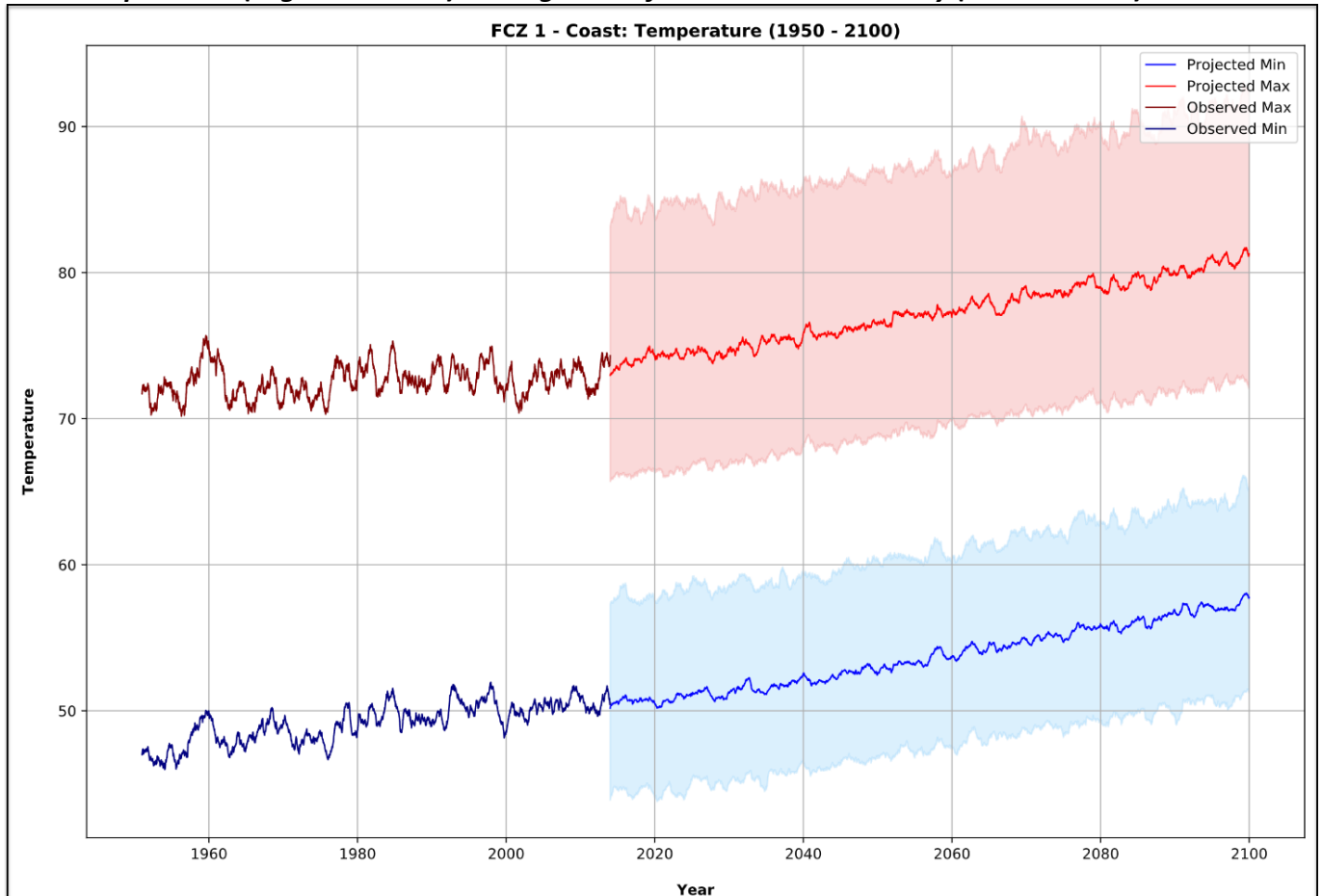

Below is analysis on the maximum and minimum for the 11 Fire Climate Zones (FCZ).

Fire Climate Zones 1 (Coast) and 2 (Inland Valleys)

Observed maximum temperatures change little through the observed period while an upward trend is noticeable among the minimum temperature observations. Both maximum and minimum temperatures are projected to trend upward across this zone through the end of the century.

Fire Climate Zones 3 (Western Mountains), 4 (Eastern Mountains), 5 (Eastern Mountains), 6 (Upper Desert), and 8 (Northern Desert)

Observed maximum temperatures change little through the observed period while a slight upward trend is

⁵³ Figure as of 11/4/2022 and data source is from Cal-Adapt <https://cal-adapt.org/>

noticeable among the minimum temperature observations. Both maximum and minimum temperatures are projected to trend upward across this zone through the end of the century.

Fire Climate Zone 9 (Inyo)

Observed maximum temperatures show a slight upward trend through the observed period while little change was noted among the minimum temperature observations. Both maximum and minimum temperatures are projected to trend upward across this zone through the end of the century.

Fire Climate Zones 7 (Mojave), 10 (Sierra), and 11 (San Joaquin)

Observed maximum and minimum temperatures change little through the observed period, but both are projected to trend upward across this zone through the end of the century.

Projection of Extreme Fire Dangers

Extreme fire weather day frequency is expected to increase across all SCE counties during most seasons and fuel moisture is expected to generally decrease. The largest increases in extreme fire weather days are forecast for Inyo and Mono County during the summer months. Data source is from climatetoolbox.org.⁵⁴ below shows the historical and projection of fuel moisture for Fresno County and data for the remaining fifteen counties are provided in Appendix F: Supplemental Information.

⁵⁴ climatetoolbox.org does not allow SCE to apply Fire Climate Zones into the analysis, and therefore SCE has to switch to using counties.

Figure 5-6 - Projected Changes in Average Fuel Moisture and Average Number of Days of Extreme Fire Danger for Winter/Spring and Summer/Fall Periods for SCE Service Territory Based on Global Climate Model Outputs (Fresno County)⁵⁵

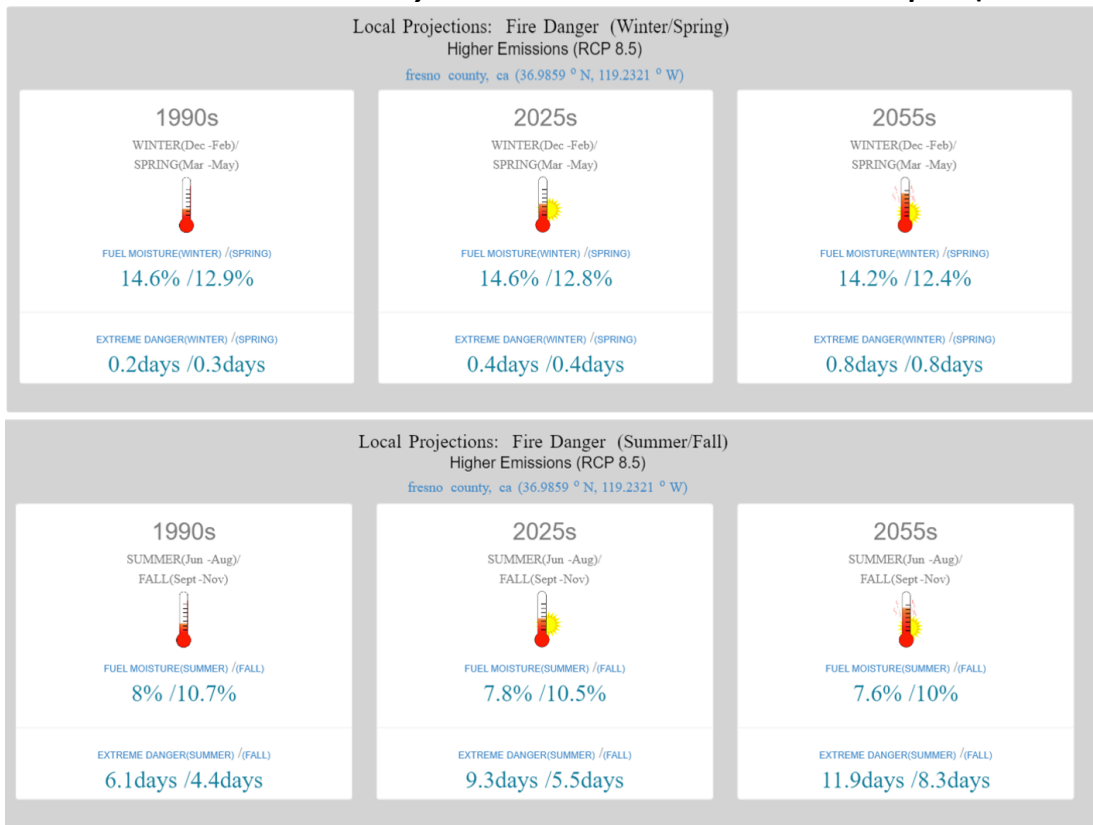

Below is the analysis on the fire moisture and fire danger observations and projects for the 16 counties.

For summer and fall, little or no change has occurred in fuel moisture since the 1990s, nor is it expected to through 2055. However, the number of fire danger days has increased since the 1990s and will continue to do so through the middle part of the century. For winter and spring, little or no change has occurred in fuel moisture since the 1990s, nor is any significant change expected through 2055. However, a slight increase in the number of fire danger days is projected through mid-century.

For all four seasons, little change is noted in both fuel moisture and the number of fire danger days except for the spring where a slight increase in fire danger days is expected through mid-century.

For summer and fall, fuel moisture values have changed little since the 1990s and are not expected to change significantly through the mid-century period. Meanwhile, the number of fire danger days has been increasing since the 1990s and will continue to increase through 2055. For winter and spring, little or no

⁵⁵ Figure as of 11/4/2022 and data source is from <https://climatetoolbox.org>

change has occurred in both fuel moisture or the number of fire danger days since the 1990s, nor are they expected to through 2055.

For summer and fall, fuel moisture values have changed little since the 1990s and are not expected to change significantly through the mid-century period. Meanwhile, the number of fire danger days has been increasing since the 1990s and will continue to increase through 2055. For winter and spring, little or no change has occurred in both fuel moisture or the number of fire danger days since the 1990s, nor are they expected to through 2055.

During the winter, little change in both fuel moisture and fire danger days is noted through the entire time period. Fuel moisture changes little in the spring but the number of fire danger days increases slightly by mid-century. In the summer, fuel moisture changes little, but there is a notable increase in the number of fire danger days through mid-century. In the fall, fuel moisture changes little through the period, and while the number of fire danger days shows no change from the 1990s to 2025, an increase is expected by the middle of the century.

For summer and fall, little or no change has occurred in fuel moisture since the 1990s, nor is it expected to through 2055. However, the number of fire danger days has increased slightly since the 1990s and will continue to do so through the middle part of the century. For winter and spring, fuel moisture values have changed little since the 1990s and are not expected to change significantly through the mid-century period. Meanwhile, the number of fire danger days has been increasing since the 1990s and will continue to increase through 2055.

While fuel moisture changes little across all four seasons from the 1990s through mid-century, the number of fire danger days increases through mid-century during the summer and fall, with little change or a very slight increase during the winter and spring.

While fuel moisture values during the summer and fall are expected to decrease very slightly through 2055, the number of fire danger days is expected to increase sharply through this same time period. For winter and spring, little or no change has occurred in both fuel moisture or the number of fire danger days since the 1990s, nor are they expected to through 2055.

For summer, little or no change has occurred in both fuel moisture or the number of fire danger days since the 1990s, nor are they expected to through 2055. For winter, little change in fuel moisture has occurred since the 1990s, but it is expected to decrease by mid-century. Meanwhile, little change was noted in the number of fire danger days from the 1990s to 2055. For spring and fall, fuel moisture changes little through the period while the number of fire danger days steadily increases through the period.

For all four seasons, fuel moisture values have changed little since the 1990s and are not expected to change significantly through the mid-century period. Meanwhile, the number of fire danger days has been increasing since the 1990s and will continue to increase through 2055.

For the summer and winter, little or no change has occurred in fuel moisture since the 1990s, nor is it expected to through 2055. However, while little change was noted in the number of fire danger days from the 1990s, a slight increase is expected to occur by 2055. For the spring and fall, fuel moisture changes little through the period while the number of fire danger days increases slightly through the period.

For the fall and winter, little or no change has occurred in both fuel moisture or the number of fire danger days since the 1990s, nor are they expected to through 2055. For the spring and summer, fuel moisture changes little through the period while the number of fire danger days steadily increases through the period.

While fuel moisture changes little across all four seasons from the 1990s through mid-century, the number of fire danger days increases during the fall and winter, with little change during the spring and summer.

For summer and fall, little or no change has occurred in fuel moisture since the 1990s, nor is it expected to through 2055. However, the number of fire danger days has increased slightly since the 1990s and will continue to do so through the middle part of the century. For winter and spring, little or no change has occurred in both fuel moisture or the number of fire danger days since the 1990s, nor are they expected to through 2055.

For summer and fall, fuel moisture has changed little since the 1990s, but is expected to lower through 2055, while the number of fire danger days will steadily increase through the middle part of the century. For winter and spring, little or no change has occurred in both fuel moisture or the number of fire danger days since the 1990s, with little change expected through 2055.

For all four seasons, fuel moisture changes little through the period however, in the fall and the winter, the number of fire danger days increases through 2055 with little change noted otherwise.

5.3.5 Topography

The electrical corporation must provide an overview and brief description of the various topographic conditions across its service territory.

SCE's service territory contains several prominent mountain topographic regions, several of which play a significant role in spatial patterns of fuel and wind driven wildfires activity.

The Sierra Nevada Mountains run north south through the northern portion of SCE's service territory. This mountain range is predominately impacted by winds running parallel to the mountain slopes and is bounded by the San Joaquin Valley to the west.

East of the Sierra Nevada mountains, the upper high desert regions include Owens Valley, which are bounded by the White mountains.

Basin and Range topography, including Death Valley and the Mojave Desert, dominate the high desert regions south of Owens Valley.

Several other mountain ranges traverse SCE's service territory from east to west. These mountain ranges are the (from east to west) Santa Ynez Mountains, Santa Monica Mountains, San Gabriel Mountains, and San Bernardino Mountains. The San Jacinto Mountains taper southeast from the San Bernardino Mountains, dividing the Colorado Desert from the low desert of the Inland Empire.

The spaces between these mountains form passes such as the Tejon, Acton, Cajon, and Banning Passes, which are the locations in which Santa Ana wind driven fire events are prominent in SCE's service territory.

Additionally, some of the coastal mountain ranges, namely the San Ynez and Santa Monica mountains are features which play a major role in the formation of Sundowner winds. Finally, the Peninsular Ranges which separate the Inland Empire from the urbanized coastal plain of Los Angeles and Orange Counties. These mountains are also subject to stronger fuel and wind driven fire events.

Figure SCE 5-06 below shows the illustration of the topography of SCE service territory. The source data for this map is available through ArcMap, ArcGIS Pro, and ArcGIS Online products in form of a base map.

Figure SCE 5-06 - Topography of SCE Service Territory⁵⁶

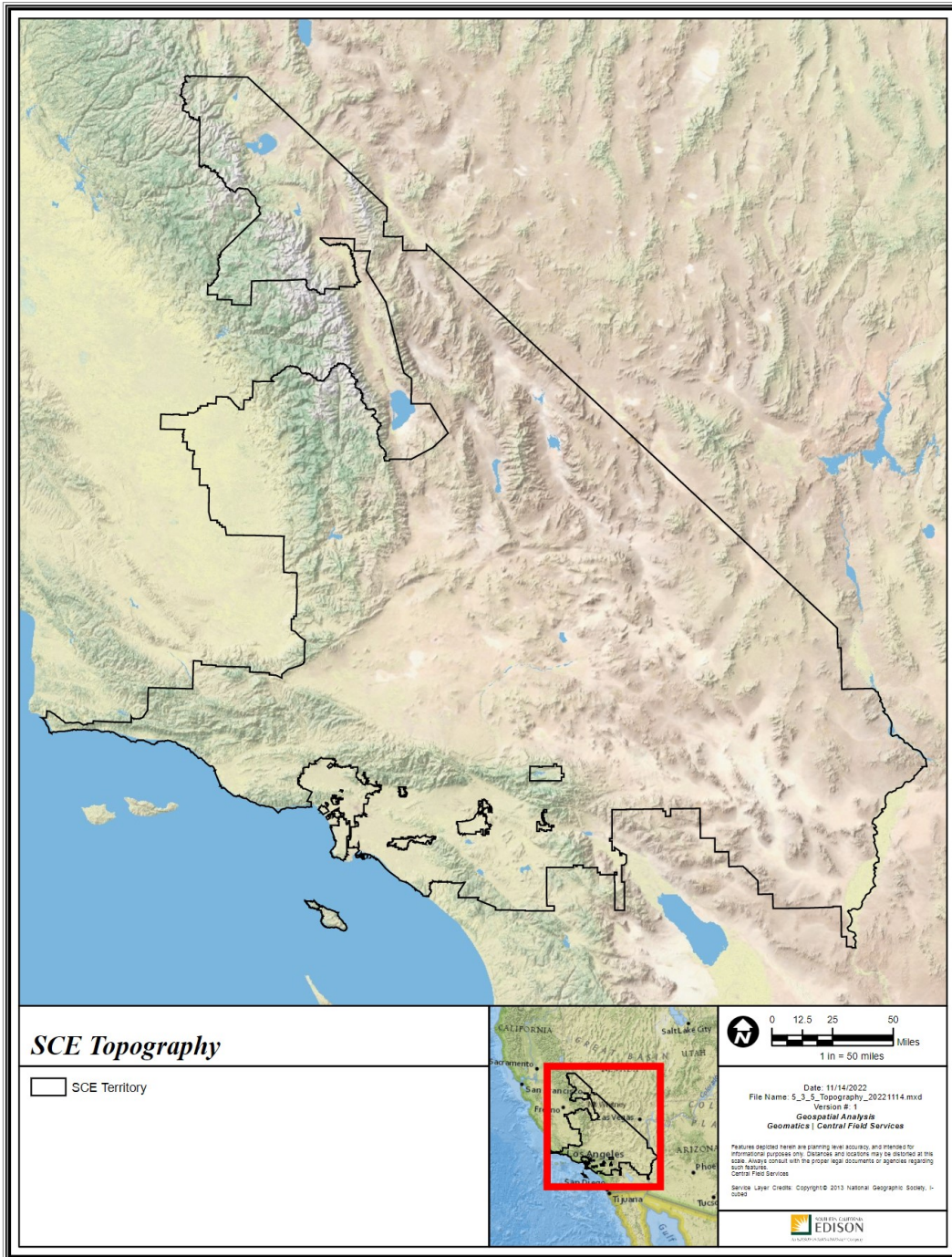

⁵⁶ Map is as of 12/5/2022 and data source is from ESRI base map (USA Topo Map).

5.4 Community Values at Risk

In this section of the WMP, the electrical corporation must identify the community values at risk across its service territory. Sections 5.4.1–5.4.5 provide detailed instructions.⁵⁷

5.4.1 Urban, Rural, and Highly Rural Customers

The electrical corporation must provide a brief narrative describing the distribution of urban, rural, and highly rural areas and customers across its service territory. Refer to Appendix A for definitions.

SCE serves approximately 5.2 million customers, approximately 87% (4.5 million) of which are located in urban areas; 11.6% (0.6 million) in rural areas, and 0.7% (0.04 million) in highly rural areas. Urbanized areas include the North Coast (Ventura and Santa Barbara Counties); the Los Angeles Basin, Orange County, and the Inland Empire (Western San Bernardino and Riverside Counties). Rural and Highly Rural Populations are dispersed across wide swaths of the High Desert and High Sierras, including parts of Tulare, Kern, Mono, Inyo, and the Eastern parts of San Bernardino and Riverside Counties.

Figure SCE 5-06 below shows the urban, rural, and highly rural customer distributions (raster or polygon) across SCE service territory. The source data for this map is publicly available from the United States Census Bureau and the spatial data can be downloaded at <https://www.census.gov/geographies/mapping-files/time-series/geo/tiger-geodatabase-file.2020.html>.

⁵⁷ Annual information included in these sections must align with Table 7 of the QDR.

5.4.2 Wildland-Urban Interfaces

The electrical corporation must provide a brief narrative describing the wildland-urban interfaces (WUIs) across its service territory. Refer to Appendix A for definitions.

The Wildland Urban Interfaces (WUIs) are areas of urbanized developments adjacent to wildland vegetation. Since the late 1970s, the spatial patterns of housing development in most of the United States, and more prominently in Southern California, have largely been characterized by the housing development in these locations. Roughly one-third of SCE customers reside in WUI locations. The primary locations of the WUI in SCE's service territory include the areas adjacent to the urban periphery of the Santa Barbara, Los Angeles, Orange, San Bernardino, and Riverside counties.

New WUI areas are created as new housing development occurs in, or near, wildland vegetation, or when wildland grows near vegetation. However, as development continues into the WUI, additional populations are exposed to potential wildfires.

WUI locations can be classified into two broad categories - WUI interface (WUI) and WUI intermix (WUIx). The WUI Interface is characterized by a clear delineation between the built environment and wildland vegetation. A suburban neighborhood immediately adjacent to wild grasses and shrubs, such as those located south of the Angeles National Forest is a prime example of the WUI Interface. Conversely, in WUI intermix locations, there is not a clear delineation between the urbanized (built) and wildland (unbuilt) environment. WUIx locations are characterized by rural or highly rural structures interspersed with wildland vegetation. Examples of WUIx locations include the rural communities in the San Bernardino National Forest.

Table SCE 5-01 provides the total area of SCE service territory and number of customers and circuit miles in WUIs.⁵⁹ Further, Figure SCE 5-07 below shows the distribution of WUIs (raster or polygon) and overhead transmission and distribution circuit miles across SCE service territory. The source data for this map is publicly available from the University of Wisconsin-Madison (Silvis Lab) and the spatial data can be downloaded at <http://silvis.forest.wisc.edu/data/wui-change-2020/>.

Table SCE 5-01 - Number of SCE Customers and Circuit Miles in Wildland Urban Interface (WUI)

Wildland-Urban Interfaces (WUIs)	SCE Customers	SCE Circuit Miles
Non-WUIs	3,438,975	54,453
WUIs	1,755,161	27,877
Total	5,194,136	82,330

⁵⁹ The metrics provided include all transmission and primary distribution circuits, including overhead and underground.

Figure SCE 5-08 - Distribution of Wildland Urban Interface (WUI) across SCE Service Territory⁶⁰

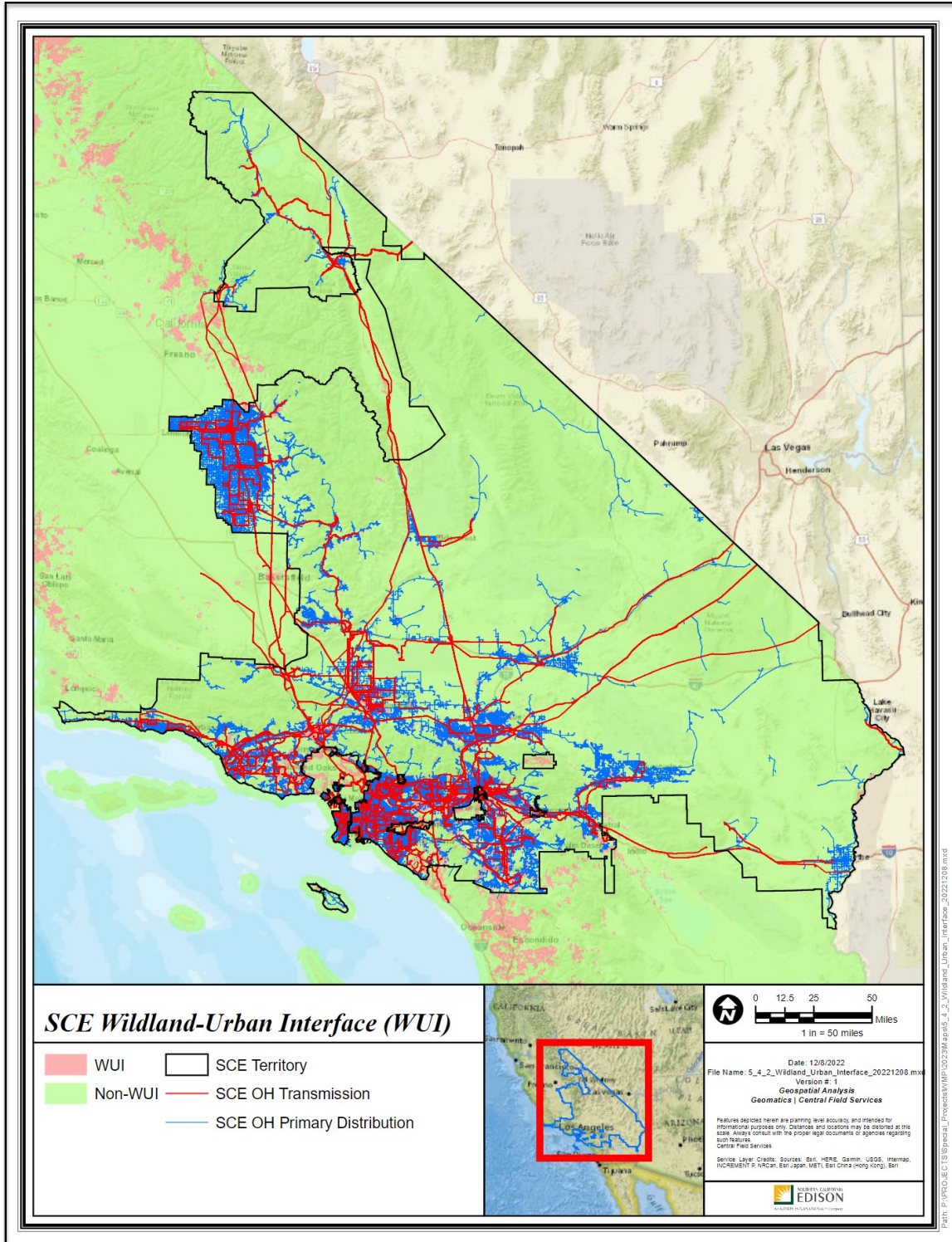

⁶⁰ Map as of 12/8/22 and data source is from University of Wisconsin-Madison (Silvis Lab) - 2020 <http://silvis.forest.wisc.edu/data/wui-change-2020/>.

5.4.3 Communities at Risk from Wildfire

In this section of the WMP, an electrical corporation must provide a high-level overview of communities at risk from wildfire as defined by the electrical corporation (e.g., within the HFTD and HFRA). This includes an overview of individuals at risk, AFN customers, social vulnerability, and communities vulnerable because of single access/egress conditions within its service territory. Detailed instructions are provided below.

5.4.3.1 Individuals at Risk from Wildfire

The electrical corporation must provide a brief narrative (one to two paragraphs) describing the total number of people and distribution of people at risk from wildfire across its service territory.

1. Communities At Risk

Communities at Risk (CARs) are those communities designated by the California Department of Forestry and Fire Prevention (CalFire) that are within, or adjacent, to Wildland Urban Interface (WUI). SCE provides electric service in 193 cities and communities throughout Southern California, the majority of which have been wholly or partially designated as a Community at Risk (CAR). SCE notes that, in many cases, only a portion of these communities intersect with the Commission designated High Fire Threat District (HFTD).

To be considered as a CAR, individual communities must submit an application outlining risk factors specific to their community. These factors include known local fire behavior potential, terrain complexity, and population egress challenges. Once a community is designated as a CAR, they are prioritized for state and federally funded fuel treatments projects. Figure SCE 5-09 below shows the distribution of communities at risk from wildfire across SCE service territory. The source data for this map is publicly available from the CAL FIRE and the spatial data can be downloaded at <https://osfm.fire.ca.gov/divisions/community-wildfire-preparedness-and-mitigation/fire-plan/communities-at-risk/>.

Figure SCE 5-09 - Distribution of Communities across SCE Service Territory⁶¹

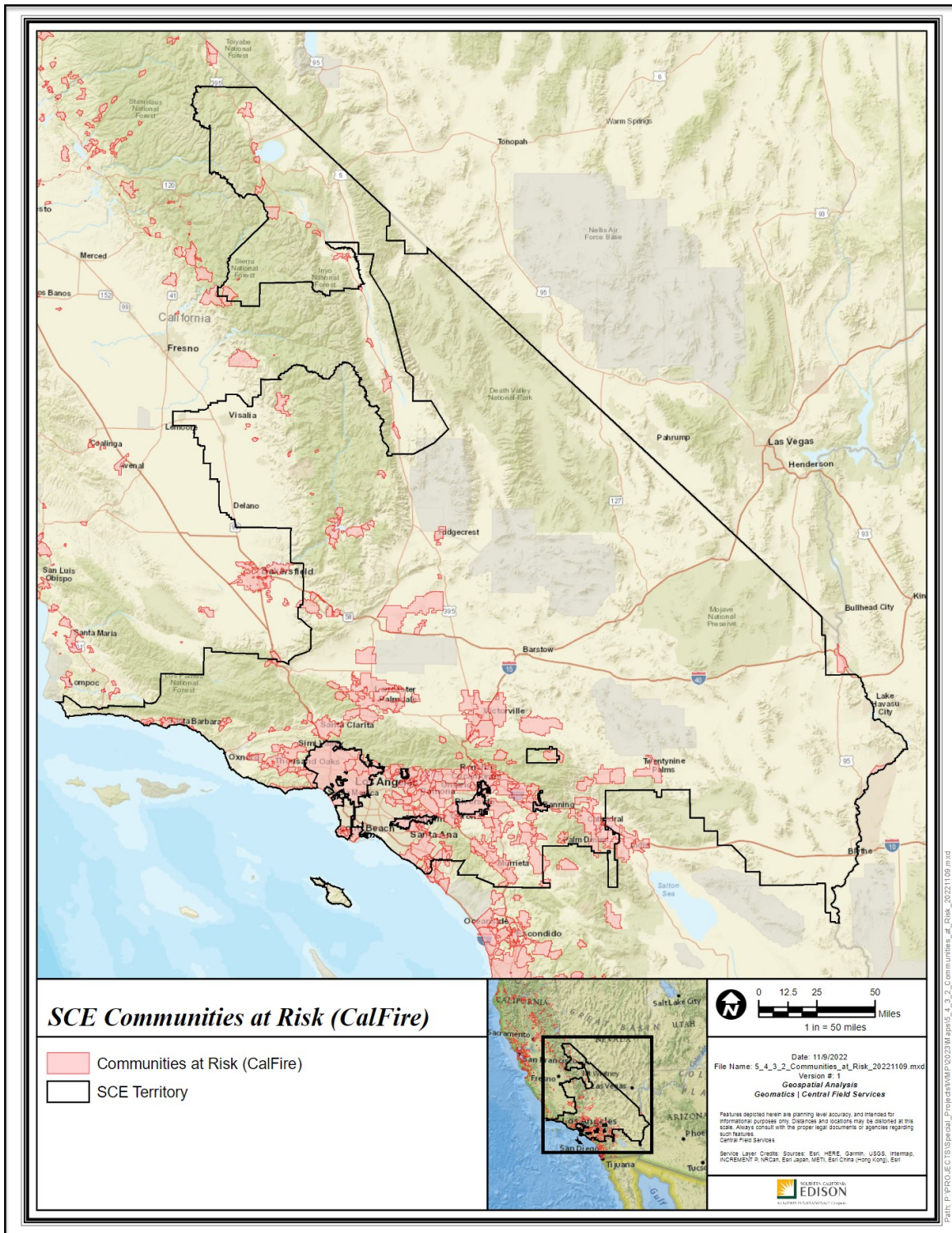

⁶¹ Map as of 12/8/22 and data source is from CalFire (<https://osfm.fire.ca.gov/divisions/community-wildfire-preparedness-and-mitigation/fire-plan/communities-at-risk/>).

2. Individuals At Risk

SCE provides service to over approximately 15 million customers through 5.2 million customer accounts. SCE's service area includes densely populated portions of Los Angeles and Orange counties not otherwise served by municipal electric utilities.⁶² As stated in the previous section, roughly one third of these customers reside in the WUI. Figure SCE 5-10 below shows the distribution of individuals at risk from wildfire across SCE service territory. The source data for this map is publicly available from the United States Census Bureau and the spatial data can be downloaded at <https://www.census.gov/geographies/mapping-files/time-series/geo/tiger-geodatabase-file.2020.html>.

3. Access and Functional Needs

SCE leverages internal customer enrollment data from customer programs and services and demographic designations SCE has on record that match the definition of an Access and Function Needs (AFN) customer. See Section 8.5.3 for additional details on AFN data tracked in our systems.⁶³ In SCE's service territory, the majority of AFN customers are located in more urbanized/non-WUI locations. Figure SCE 5-11 below shows the distribution of AFN at risk from wildfire across SCE service territory.

⁶² Source: 2020 U.S. Census <https://mtgis-portal.geo.census.gov/arcgis/apps/MapSeries/index.html?appid=2566121a73de463995ed2b2fd7ff6eb7>

⁶³ SCE performed an analysis to identify the percentage of the SCE customer base that meets the definition of AFN per Government Code 8593.3(f)(1). Based on data gathered from SCE's internal systems and programs, SCE estimates that approximately 32% of its customer accounts would identify with at least one AFN category. SCE actively identifies customers as AFN that directly interface with SCE's customer programs and services. SCE launched an AFN Self-Identification pilot in 2022 to help us further identify customers and household members with access and functional needs, above and beyond customers enrolled in the Medical Baseline Allowance Program. See Section 8.5.3 for additional details.

Figure SCE 5-10 - Distribution of Individuals across SCE Service Territory⁶⁴

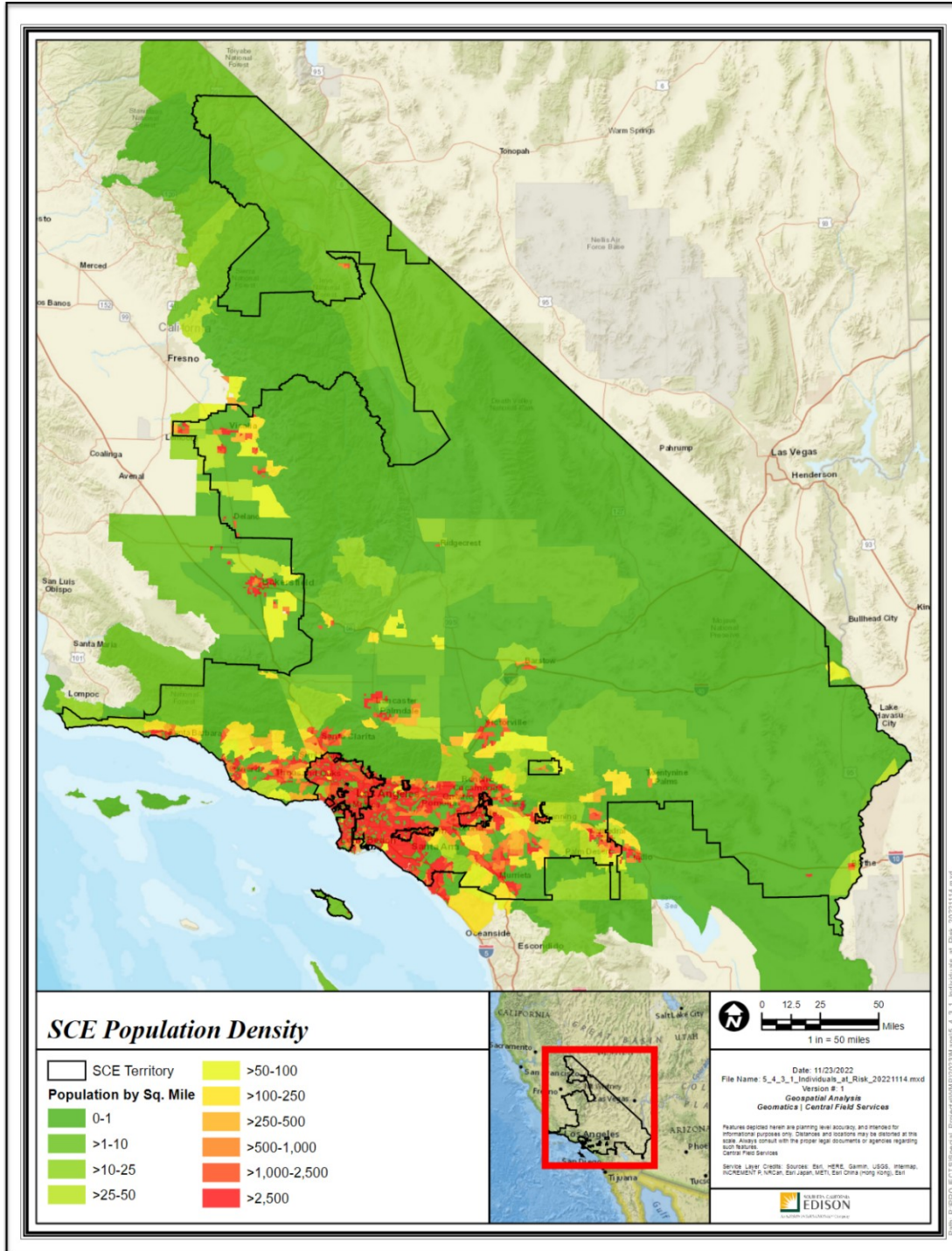

⁶⁴ Map as of 12/8/22 and data source is from data source is from 2020 Census Tract (<https://www.census.gov/geographies/mapping-files/time-series/geo/tiger-geodatabase-file.2020.html>)

Figure SCE 5-11 - Distribution of AFN across SCE Service Territory⁶⁵

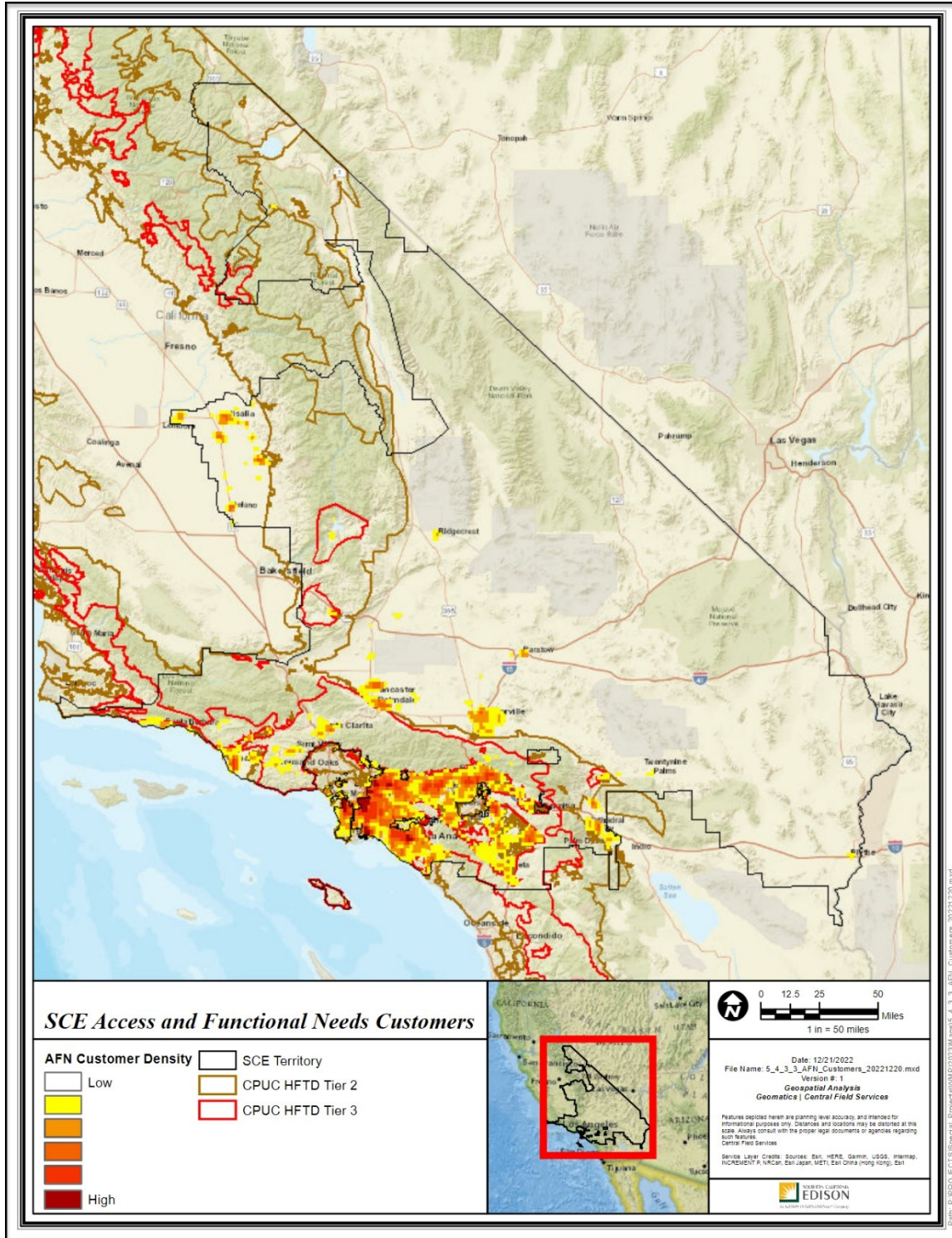

⁶⁵ Map as of 12/8/22. SCE has provided a spatial data for AFN in SCE service territory. Please see <https://www.sce.com/safety/wild-fire-mitigation>.

5.4.3.2 Social Vulnerability and Exposure to Electrical Corporation Wildfire Risk

The electrical corporation must provide a brief narrative describing the intersection of social vulnerability and community exposure to electrical corporation wildfire risk across its service territory. This intersection is defined as census tracts that 1) exceed the 70th percentile according to the Social Vulnerability Index (SVI) or have a median household income of less than 80 percent of the state median, and 2) exceed the 85th percentile in wildfire consequence risk according to the electrical corporation's risk assessment(s).⁶⁶

For SVI, the electrical corporation must use the most up-to-date version of Centers for Disease Control and Prevention/Agency for Toxic Substances and Disease Registry's Social Vulnerability Index dataset (Year = 2018;43F⁶⁷ Geography = California; Geography Type = Census Tracts).⁶⁸

In addition, the electrical corporation must provide a single geospatial map showing its service territory (polygon) overlaid with the distribution of the SVI and exposure intersection and urban and major roadways. Any additional maps needed to provide clarity and detail should be included in Appendix C.

Based on the census tract level geography used in by Centers for Disease Control (CDC) Social Vulnerability Index (SVI), the majority of the socially vulnerable populations in SCE's service territory are located outside of High Fire Threat Districts (HFTD). Census tract-based geographies are inherently biased toward urbanized areas with higher population density. Therefore, the granularity of spatial data using this geography is not particularly useful in more rural locations, which are prevalent in SCE's High Fire Threat District (HFTD). For this reason, SCE has developed a circuit-based view of social vulnerability. This Access and Functional Needs (AFN)/Non-Residential Critical Infrastructure (NRCI) multiplier methodology is described in additional detail in Section 6.4.

Figure SCE 5-12 below shows the distribution of the SVI and exposure intersection and urban and major roadways across SCE service territory. The source data for this map is publicly available from the Center for Disease Control and Prevention, and the spatial data can be downloaded at https://www.atsdr.cdc.gov/placeandhealth/svi/data_documentation_download.html.

⁶⁶ These criteria are derived from Cal OES Recovery Division, Hazard Mitigation Assistance Branch's Multiple Hazards and Social Vulnerability Analysis, dated January 18, 2022: <https://www.caloes.ca.gov/wp-content/uploads/Recovery/Documents/Socially-Vulnerable-and-High-Hazard-Risk-Community-Criteria-Methodology.pdf> & <https://calema.maps.arcgis.com/apps/dashboards/3c78aea361be4ea8a21b22b30e613d6e>

⁶⁷ As of the publishing of these Guidelines, 2018 was the most recent version of the dataset. Electrical corporations must use the most up-to-date version of the dataset.

⁶⁸ Centers for Disease Control and Prevention / Agency for Toxic Substances and Disease Registry Social Vulnerability Index Data and Documentation Download (https://www.atsdr.cdc.gov/placeandhealth/svi/data_documentation_download.html, accessed Oct. 11, 2022).

Figure SCE 5-12 - Distribution of the SVI and Exposure Intersection and Urban and Major Roadways across SCE Service Territory⁶⁹

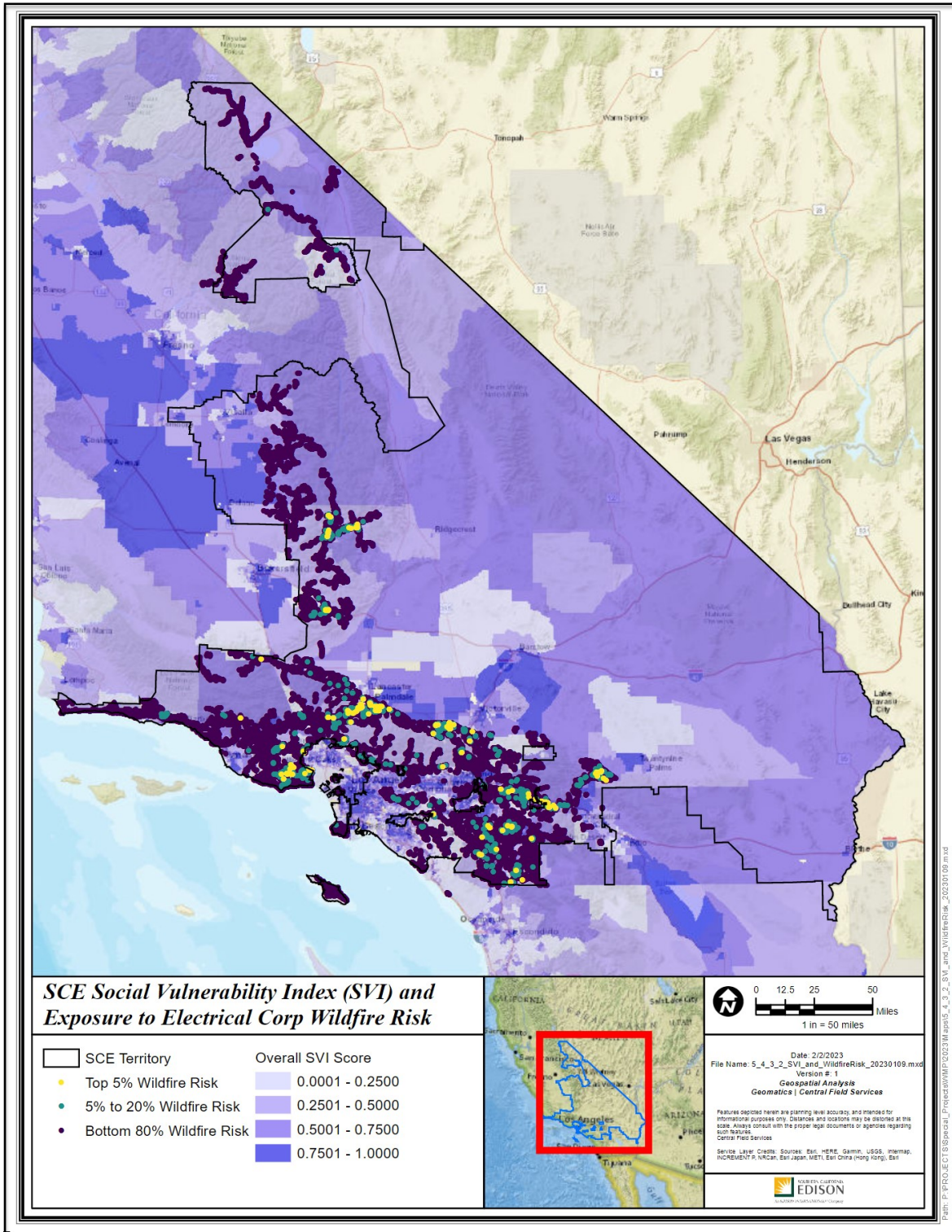

⁶⁹ Map as of 01/09/23. SVI data is from Center for Disease Control and Prevention

Sub-Divisions with Limited Egress or No Secondary Egress

The electrical corporation must provide a brief narrative overview (one to two paragraphs) describing subdivisions with limited egress or no secondary egress, per CAL FIRE data,⁷⁰ across the electrical corporation's service territory.

AB 2911 (2018) amended the California Public Resource Code 4290.5 that requires CalFire to identify subdivisions with greater than 30 housing units located in the State Responsibility Area (SRA) or a Very High Fire Hazard Severity Zones (VHFSZ) without a secondary means of population egress. Given that this bill only passed a few years ago, many of the neighborhoods in SCE's service territory have not been assessed under this program. Only select portions of Los Angeles, Orange, and Kern counties have complete assessments made available to the public. SCE has developed an alternate methodology to assess population egress with high fire frequency through its Severe Risk Areas (SRA) methodology, which is described in more detail in Section 6. As these AB2911 assessments progress, SCE will continue to review new locations to help ensure any newly identified locations are incorporated into its overall egress methodology.

Figure SCE 5-13 below shows the map of Communities Vulnerable due to Access/Egress Constraints (Polygon) across SCE Service Territory base on CAL FIRE data. The source data for this map is publicly available from the CAL FIRE and the spatial data can be downloaded at <https://calfire-forestry.maps.arcgis.com/apps/webappviewer/index.html?id=a045e9e9c01c4dd7abdf14ad30646eaf>.

⁷⁰ Board of Forestry and Fire Protection Subdivision Review Program (<https://bof.fire.ca.gov/projects-and-programs/subdivision-review-program/>, accessed Oct. 11, 2022).

Figure SCE 5-13 - Communities Vulnerable due to Access/Egress Constraints (Polygon) and Major Roadways (Polygon) across SCE Service Territory⁷¹

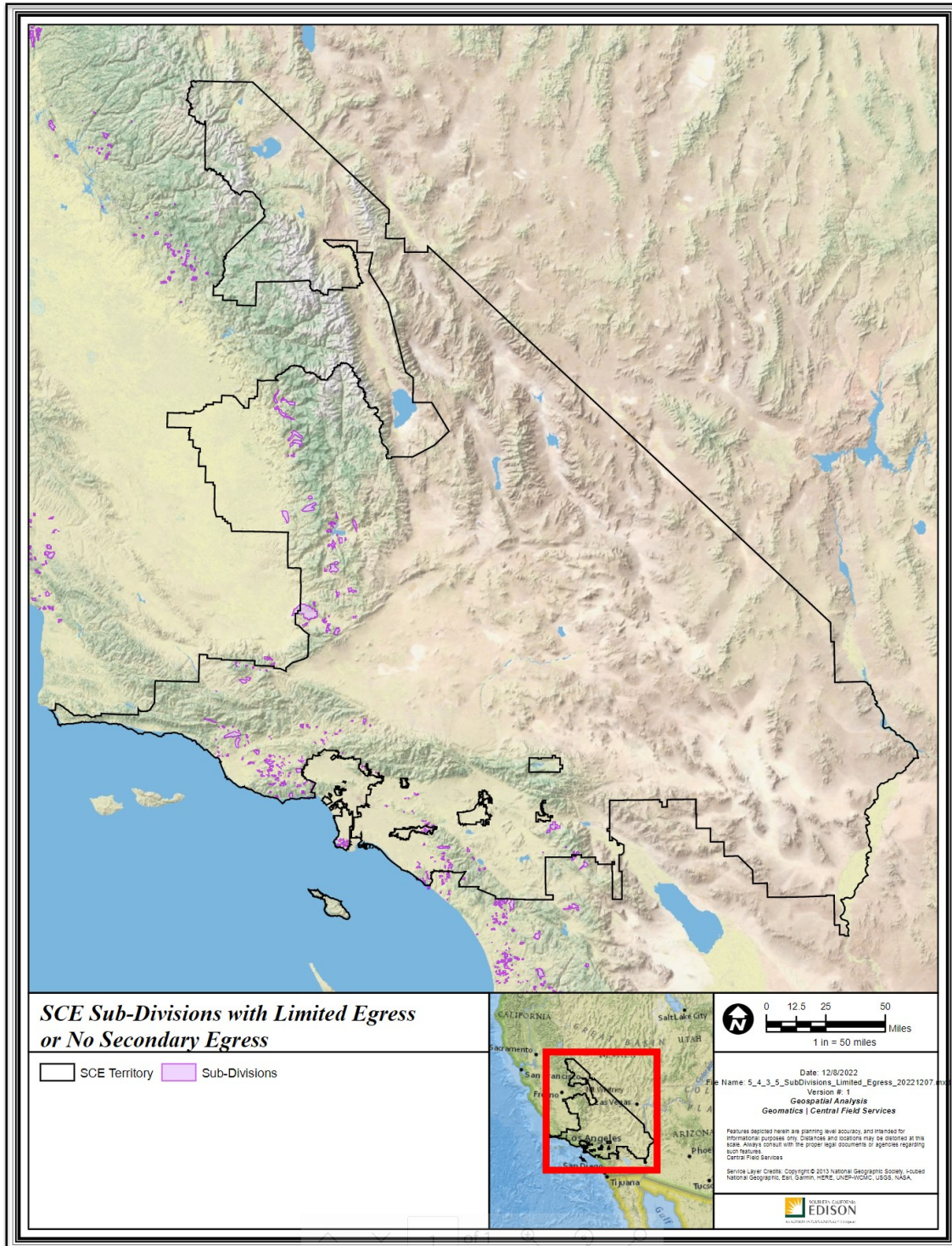

⁷¹ Map as of 12/8/22 and data source is from CAL FIRE (<https://calfire-forestry.maps.arcgis.com/apps/webappviewer/index.html?id=a045e9e9c01c4dd7abdf14ad30646eaf>)

⁷² Data as of 12/9/22.

5.4.4 Critical Facilities and Infrastructure at Risk from Wildfire

The electrical corporation must provide a brief narrative describing the distribution of critical facilities and infrastructure located in the HFTD/HFRA across its service territory. Critical facilities and infrastructure are defined in Appendix A.

Facilities and infrastructure deemed to be critical are those that perform essential functions to public safety. Some examples include, but are not limited to, police facilities, emergency operation centers (EOCs), fire stations, schools, shelters, telecommunications towers, and numerous other essential facilities. These facilities may require additional assistance and advanced planning to help ensure resiliency and continuity during de-energization events. SCE offers assistance to those facilities with advanced planning efforts toward their functional resiliency during de-energization and re-energization. SCE identifies Critical facilities and Infrastructure customers by utilizing the CPUC's adopted list and the North American Industry Classification System (NAICS) process. NAICS allows us to verify the sectors identified by the CPUC. SCE then verifies customer data against the NAICS.

SCE has approximately 21,000 Critical Facilities in its HFRA. The County of Los Angeles has approximately 6,000 facilities with Riverside and San Bernardino Counties having approximately 4,000 and 3,000 facilities, respectively.

Figure SCE 5-14 shows the distribution of critical facilities and infrastructure by county, and Figure SCE 5-15 shows the distribution of critical facilities and infrastructure by type. Further, Figure SCE 5-15 below shows the critical facilities (point data) and critical infrastructure (points and/or lines, as appropriate) across SCE service territory (polygon).

Figure SCE 5-14 - Distribution of Critical Facilities and Infrastructures across SCE HFRA Territory By Counties⁷²

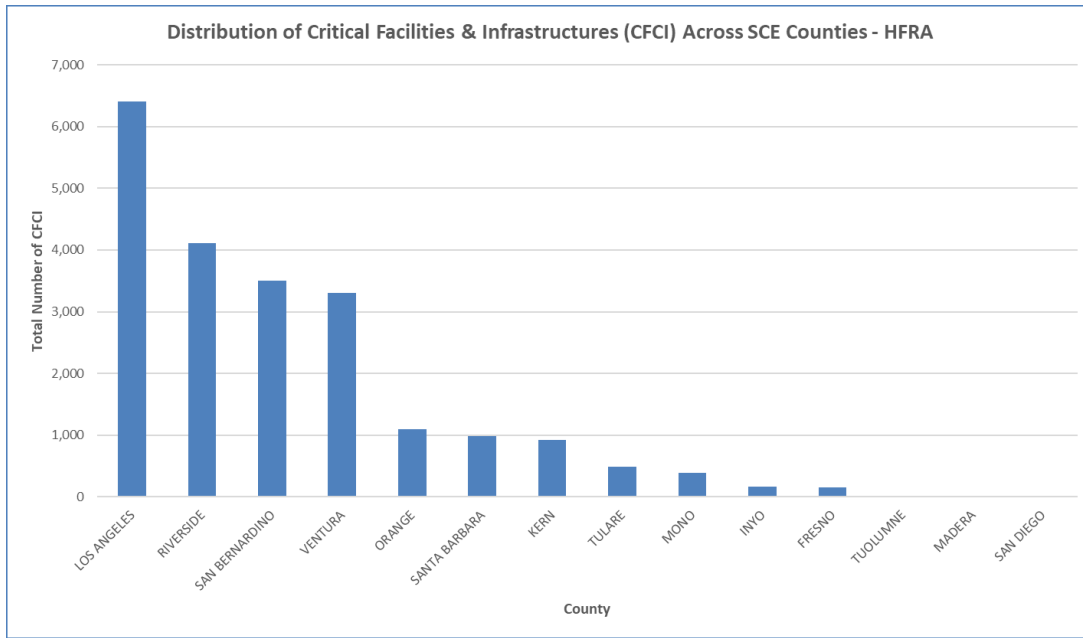
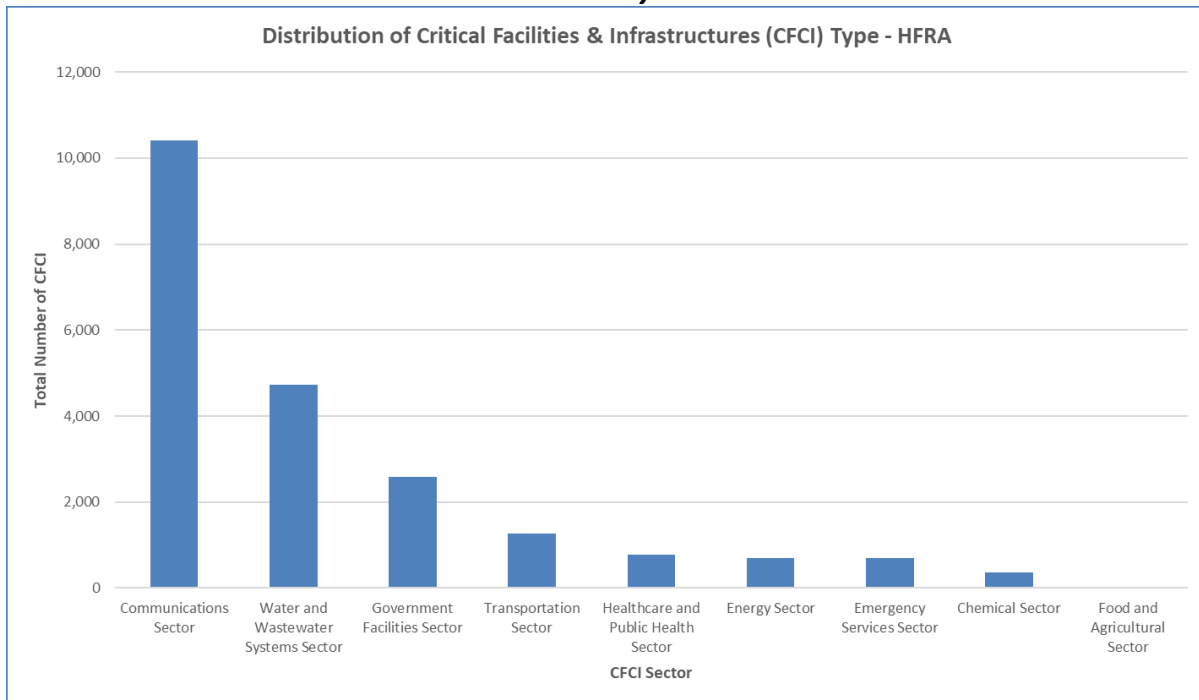
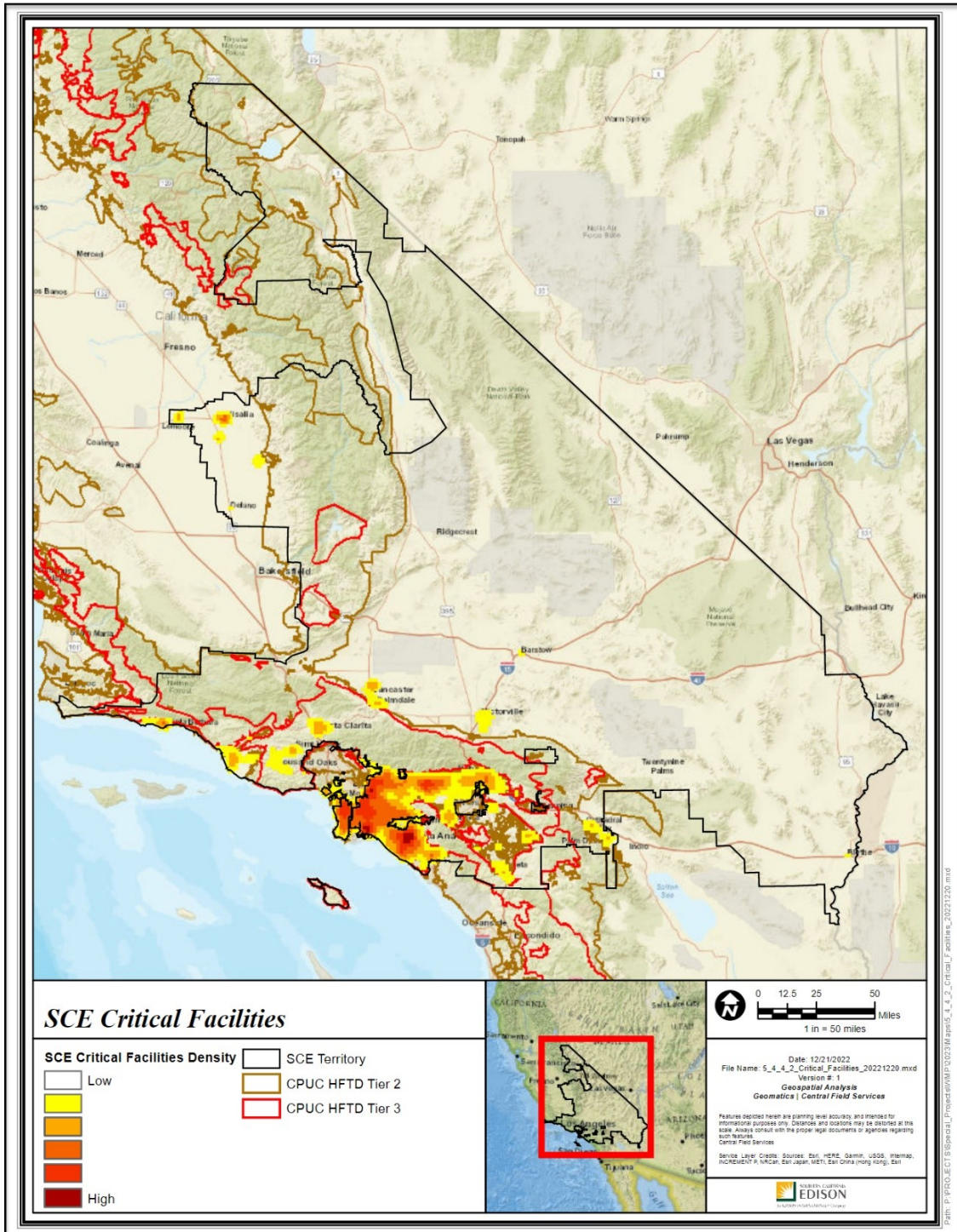

Figure SCE 5-15 Distribution of Critical Facilities and Infrastructures Type across SCE HFRA Territory⁷²



⁷² Data as of 12/9/22.

Figure SCE 5-16 - Distribution of Critical Facilities and Infrastructures Across SCE Service Territory⁷³



⁷³ Map as of 12/8/22. SCE has provided a spatial data for SCE Critical Facilities. Please see <https://www.sce.com/safety/wild-fire-mitigation>.

5.4.5 Environmental Compliance and Permitting

In this section, the electrical corporation must provide a summary of how it ensures its compliance with applicable environmental laws, regulations, and permitting related to the implementation of its WMP. This overview must include:

- *A description of the procedures/processes to ensure compliance with relevant environmental laws, regulations, and permitting requirements before and during WMP implementation. The process or procedure should include when consultation with permittees occurs (i.e., at what stage of planning and/or implementation of activities described in the WMP)*
- *Roadblocks the electrical corporation has encountered related to environmental laws, regulations, and permitting related to implementation of its WMP and how the electrical corporation has addressed, is addressing, or plans to address the roadblocks.*
- *Any notable changes to its environmental compliance and permitting procedures and processes since the last WMP submission and a brief explanation as to why those changes were made. Include any planned improvements or updates to the initiative and the timeline for implementation.*

The electrical corporation must also provide a table (Table 5-6 provides an example) of potentially relevant state and federal agencies that may be responsible for discretionary approval of activities described in WMPs and the relevant environmental laws, regulations, and permitting requirements. If this table extends past two pages, provide the required information in an appendix.

Wildfire Environmental Compliance and Permitting Summary

SCE is committed to preserving and protecting the environment and implementing sustainable business practices for the benefit of the customers and communities we serve. SCE complies with applicable local, state, and federal environmental laws and regulations.

SCE Environmental Compliance Procedures and Processes

SCE's Environmental Services Department (ESD) evaluates work activities associated with the WMP to identify the potential for impacts to agency regulated environmental resources (regulated environmental resources) (i.e., archaeological, cultural, biological species, wetlands and waterways, etc.) and any existing agency permit conditions that may be applicable.

The environmental review process is initiated after the work activity has been identified and the scoping for performing the work activity has been completed. After receiving the planned work activity, ESD performs a multi-tiered evaluation, beginning with desktop screening that uses project location information to determine whether the project intersects with known regulated environmental resources identified in publicly available agency databases or past environmental survey data gathered by SCE. If there are no intersects with known regulated environmental resources, the operations team receives approval to proceed with scheduling and implementation following standard environmental requirements designed to ensure work is performed in a way that protects the environment and ensures compliance.

Crews are responsible for reviewing and understanding the requirements prior to implementation, and if they encounter any unforeseen conditions, they are instructed to call for support. If there are intersects with existing agency permits or known regulated environmental resources, the project is further analyzed by ESD to determine the need for environmental impact avoidance/minimization measures and agency review, permitting, and approval. If the project requires agency permitting or review and approval, ESD gathers the required information to initiate such consultation.

After agency review and approval or permitting is complete, ESD sends agency environmental requirements to the operations team for scheduling and execution of the work. Environmental requirements may include pre-activity environmental surveys and/or environmental monitoring during implementation. In these cases, the operations team coordinates with ESD to schedule qualified personnel to perform environmental surveys and monitoring.

SCE also has processes to inspect projects that are on-hold pending environmental or agency review and approval. For example, if an equipment inspection identifies a Priority 1 (P1 - emergency condition), SCE will remediate the P1 condition pursuant to GO95 and will notify the appropriate agency and file any after-the-fact permits that may be necessary.

Roadblocks

Activities to address wildfire risk often occur in locations that require additional environmental review, protection, or permitting. For example, the work can occur in environmentally sensitive areas and on lands administered by State and Federal agencies, requiring coordination with such agencies. Environmental permitting and approval of work in these areas can present significant challenges to the timely execution of work. Reasons for these challenges vary by each agency's rules and available resources. However, some frequently encountered issues include:

- Environmental regulations that do not provide clear guidance on permitting processes and criteria for approval, resulting in different interpretations of a regulation within an agency (e.g., between differing regions, and/or between the regions and headquarters) and delays and/or denials of discretionary permits.
- Agency staffing, resources, and funding shortages to support and prioritize utility permits.
- Long agency processing times given their required administrative/regulatory processes (e.g., 18 months to obtain a temporary right-of-way permit).

Actions to Address Challenges

SCE is continuing to enhance its agency-specific strategies to address permitting challenges. SCE anticipates that the development of broader, long-term permits, streamlined permit processes, and exemption pathways that allow for low environmental risk, high volume utility wildfire and compliance work to proceed in a more efficient manner will be key elements in most agency-specific strategies. In the near-term, when significant issues arise, SCE escalates those issues with the agency and attempts to resolve them as soon as possible. Below, SCE has identified how we are working (or plan to work) in partnership with some key agencies to address permitting.

Forest Service Master Special Use Permit (MSUP)

The Forest Service MSUP continues to be an important tool to facilitate SCE's work. SCE is now focusing on how to improve the efficient use of this permit, including addressing greater consistency in agency execution, expanding the scope of the permitted activities, and obtaining approvals within expected timeframes. SCE is working with agencies to add staff at key forests and at the regional level, through cost recovery agreements, to provide dedicated staff to support review and approval of projects. This should reduce delays due to staffing shortages. SCE is increasing its external engagement with agency leadership to share priorities, signal upcoming changes, discuss concerns and solutions, and gain consensus for a path forward. For example, SCE flagged to the agency's senior leadership that fuel management remains a key challenge and the agency is now working with multiple stakeholders to address this key issue.

Bureau of Land Management (BLM)

SCE worked with the California State Office to obtain a 5-year Instruction Memorandum, which allows utilities to carry-out wildfire mitigation work without waiting for approval (though after-the-fact reporting requirements apply). This has significantly decreased agency permitting time pending the issuance of an Operations and Maintenance Plan, which is currently under development. Specifically, SCE has been working with the BLM in the Bakersfield Office on a pilot for an Operations and Maintenance Plan that can be rolled out more broadly within the agency once completed in 2023. SCE also is increasing its external engagement with agency leadership to share priorities, signal upcoming changes, discuss concerns and solutions, and gain consensus for a path forward.

California Department of Fish and Wildlife (CDFW)

SCE and CDFW share the goals of reducing wildfire risks by completing grid resiliency projects, decreasing turnaround time for permits, protecting California's natural resources, and minimizing the impact of our projects on fish and wildlife. SCE is considering several possible tools and actions that could help and we look forward to continuing our work with CDFW to realize these mutual goals.

Some possible actions include: (1) increasing our portfolio of permits to include broader, long-term permits, additional incidental take permits covering all activities with impact within covered species' habitats and more streamlined permit processes, (2) increasing agency staffing and training to support permit development and more efficient permit processing, and (3) increasing agency leadership participation and input, including through formal agency guidance, definition of key terms and standardization of processes.

As with the Forest Service and BLM, SCE is increasing its engagement with CDFW agency leadership, and will share ideas regarding possible solutions to facilitate processes for both agency and utility staff, while supporting the core mission of the agency.

As mentioned above, across these key agencies, we will continue to evaluate our own internal processes and seek feedback from agencies to help ensure smoother transactions from SCE's part as well.

Notable Changes, Including Planned Improvements

SCE is exploring ways to optimize the work management processes to implement WMP activities outside of seasonal limited operating periods (LOPS) associated with environmental resources (i.e., threatened or endangered species).

SCE has recently obtained incidental take permits for Yosemite Toad and Arroyo Toad and is currently finalizing permits for Pacific Fisher, San Bernardino Kangaroo Rat, and Santa Catalina Island Fox, which will provide greater operational flexibility in key regions. SCE is also applying for a Master Streambed Alteration Agreement for work in CDFW jurisdictional waters (estimated permit approval in 2024).

Relevant Federal Environment Laws, Regulations, and Permitting Requirements

SCE obtains environmental permits and approvals from governmental agencies to comply with environmental laws and regulations. Table 5-6 and Table 5-7 below provide the relevant state and federal environmental laws, regulations and permitting requirements for implementing the WMP.

Table 5-6 - Relevant State Environmental Laws, Regulations, and Permitting Requirements for Implementing the WMP

Environmental Law, Regulation, or Permit	Responsible Permittee/Agency
California Environmental Quality Act (CEQA)	Various: State and local agencies, i.e., California Public Utilities Commission, California Department of Fish and Wildlife, Los Angeles Department of Regional Planning, etc.
Assembly Bill 52 (AB52): California Public Resources Code 21080.3.2	Various: State and local agencies, i.e., California Public Utilities Commission, California Department of Fish and Wildlife, Los Angeles Department of Regional Planning, etc.
California Endangered Species Act (CESA)	California Department of Fish and Wildlife
California Fish and Game Code § 3800 [makes it unlawful to take any nongame bird (i.e., bird that is naturally occurring in California that is not a gamebird, migratory game bird, or fully protected bird)]	California Department of Fish and Wildlife

Environmental Law, Regulation, or Permit	Responsible Permittee/Agency
Native Plant Protection Act	California Department of Fish and Wildlife
California Desert Native Plants Act	California Department of Agriculture, local agencies
Lake or Streambed Alteration (LSA) California Fish and Game Code §§ 5650 - 5652 (prohibit the deposition, passage of, or disposal of deleterious materials into the waters of the state, or within 150 feet of the highwater mark of waters of the state)	California Department of Fish and Wildlife
Air Resources California Health and Safety Code §§ 39000-44474 Portable Equipment Registration Program (PERP) and Portable Engine Airborne Toxic Control Measure	California Air Resources Board and various local air agencies
California Porter-Cologne Water Quality Control Act	California State Water Quality Control Board including multiple Regional Water Quality Control Boards
California Coastal Act	California Coastal Commission including delegation of Local Coastal Programs (LCPs) to cities and counties
Various Encroachment Permits	CA Dept. of Transportation, CA Dept. Water Resources

Table 5-7 - Relevant Federal Environmental Laws, Regulations, and Permitting Requirements for Implementing the WMP

Environmental Law, Regulation, or Permit	Responsible Permittee/Agency
National Environmental Policy Act (NEPA)	Various: Federal Land Management Agencies, i.e., Bureau of Land Management, National Park Service, USFS, etc.
Federal Endangered Species Act of 1973(ESA)	United States Fish and Wildlife Service
Migratory Bird Treaty Act (MBTA)	United States Fish and Wildlife Service

Environmental Law, Regulation, or Permit	Responsible Permittee/Agency
Bald and Golden Eagle Protection Act (BGEPA)	United States Fish and Wildlife Service
Marine Mammal Protection Act (MMPA)	United States Fish and Wildlife Service
National Historic Preservation Act (NHPA)	Advisory Council on Historic Preservation/State Historic Preservation Office/Federal Lead agencies
Archaeological Resources Protection Act (ARPA)	Various: Federal Land Management Agencies, i.e., Bureau of Land Management, National Park Service, USFS, etc.
Native American Graves Repatriation Protection Act (NAGRPA)	Various: Federal Land Management Agencies, i.e., Bureau of Land Management, National Park Service, USFS, etc.
Antiquities Act of 1906	Various: Federal Land Management Agencies, i.e., Bureau of Land Management, National Park Service, USFS, etc.
Paleontological Resources Preservation Act (PRPA)	Various: U.S. Department of the Interior, i.e., Bureau of Land Management, National Park Service, U.S. Fish and Wildlife Service, U.S. Bureau of Reclamation, etc.
Federal Clean Water Act (CWA)	Environmental Protection Agency, Army Corps of Engineers
Federal Coastal Zone Management Act	Bureau of Ocean Energy Management

6 RISK METHODOLOGY AND ASSESSMENT

In this section of the WMP, the electrical corporation must provide an overview of its risk methodology, key input data and assumptions, risk analysis, and risk presentation (i.e., the results of its assessment). This information is intended to provide the reader with a technical understanding of the foundation for the electrical corporation's wildfire mitigation strategy for its Base WMP. Sections 6.1–6.7 below provide detailed instructions.

For the 2023-2025 Base WMP, the electrical corporation does not need to have performed each calculation and analysis indicated in sections 6.2, 6.3, and 6.6. If the electrical corporation is not performing a certain calculation or analysis, it must describe why it does not perform the calculation or analysis, its current alternative to the calculation or analysis (if applicable), and any plans to incorporate those calculations or analyses into its risk methodology and assessment.

In this section, SCE describes its approach to define and analyze wildfire and PSPS risk. These risk assessments inform mitigation strategy, prioritization, selection, and scoping as described in Section 7.

In Section 6.1, SCE provides a summary of the two risk planning frameworks it uses as part of its Integrated Wildfire Mitigation Strategy (IWMS): 1) the Multi-Attribute Risk Score Framework (MARS Framework or MARS), which is used to calculate overall Wildfire and PSPS risk and risk reduction from mitigation activities, and 2) the IWMS Risk Framework, which categorizes SCE's high fire risk area into three risk tranches and is used to inform mitigation selection and scoping.

In Section 6.2, SCE explains its approach to the 17 risk components defined by the WMP guidelines. In the limited cases in which SCE uses a risk component differently than as defined by the WMP guidelines, SCE explains its reasoning.

In Section 6.3, SCE explains its approach to the risk scenarios defined by the WMP guidelines. In the limited cases in which SCE does not use a risk scenario as defined by the WMP guidelines, or uses it differently, SCE explains its reasoning.

In Section 6.4, SCE presents a summary of wildfire and PSPS risk across its service territory, including the highest risk locations and circuits. SCE also describes the HFTD review process with the CPUC and provides details on metrics as requested by the WMP guidelines.

In Section 6.5 and Section 6.6, SCE describes the mechanisms by which SCE accesses, stores, and controls wildfire and PSPS risk related information. This section also summarizes the associated quality control/quality assurance processes for risk data and risk analyses.

In Section 6.7, SCE provides its risk improvement plan, which is informed by internal assessments along with feedback from stakeholders and regulatory agencies.

SCE also notes that additional documentation on risk components and models can be found in Summary Documentation .

6.1 Methodology

In this section, the electrical corporation must present an overview of its risk calculation approach. This includes one or more graphics showing the calculation process, a concise narrative explaining key elements of the approach, and definitions of different risks and risk components.

6.1.1 Overview

The electrical corporation must provide a brief narrative describing its methodology for quantifying its overall utility risk of wildfires and PSPS. This methodology will help inform the development of its wildfire mitigation strategy (see Section 7). The electrical corporation must describe the methodology and underlying intent of this risk assessment in no more than five pages, inclusive of all narratives, bullet point lists, and any graphics.

SCE uses two risk planning frameworks:

The MARS Framework is used to calculate overall utility risk from both wildfire and PSPS. The MARS Framework converts PSPS risk (PSPS Likelihood and PSPS Consequence) and Wildfire risk (Probability of Ignition and Wildfire Consequence) into a unitless risk score based on the principles in the S-MAP Settlement. The MARS Framework allows SCE to define and evaluate overall utility risk, and to compare mitigations and alternatives to each ignition driver and sub-driver on the basis of risk reduction and cost effectiveness.

The IWMS Risk Framework defines three risk tranches within SCE's HFRA based on potential consequences should an ignition occur at a specific utility asset location. This analysis includes elements such as potential egress constraints and Communities of Elevated Fire Concern (CEFC). The IWMS Risk Framework is anchored on wildfire consequence should an ignition occur and does not adjust consequences based on the probability of ignition. SCE takes this approach because probability of ignition changes over time due to many variables such as age, loading, etc. Furthermore, in some locations the consequences of an ignition that leads to a wildfire may be so extreme that it is prudent to mitigate ignition risk regardless of probability.

After mitigations have been evaluated and selected under the MARS Framework, SCE uses this preferred list of mitigations in combination with the IWMS Risk Framework as a key input to determine the location, scale, scope, and frequency for each mitigation based on the three tranches of forecasted wildfire consequence severity. The IWMS Risk Framework supports SCE's strategy to deploy mitigations commensurate with the level of consequence from a safety, financial, and reliability perspective within each location of its high fire risk area.

In Section 6.2.1, SCE further explains these two frameworks, and provides two diagrams that are intended to illustrate how each framework uses the individual risk components defined by the WMP guidelines. Each diagram should be considered as unique to its respective framework.

6.1.2 Summary of Risk Models

In this section, the electrical corporation must summarize the calculation approach for each risk and risk component identified in Section 6.2.1. This documentation is intended to provide a quick summary of the models used. The electrical corporation must provide the following information:

- **Identification (ID):** Unique shorthand identifier for the risk or risk component.
- **Risk component:** Unique full identifier for the risk or risk component.
- **Design scenario(s):** Reference to design scenarios evaluated with the model to calculate the risk or risk component. These must be defined in Section 6.3.
- **Key inputs:** List of key inputs used to evaluate the risk or risk component. These can be in summary form (e.g., the electrical corporation may list “equipment properties” rather than listing out equipment age, maintenance history, etc.).
- **Sources of inputs:** List of sources for each input parameter. These must include data sources (such as LANDFIRE) and modeling results (such as wind predictions) as relevant to the calculation of the risk or risk component. If the inputs come from multiple sources, each source should be on a new line.
- **Key outputs:** List of outputs calculated for the risk or risk component.
- **Units:** List of the units associated with the key outputs.

Table 6-1 provides a template for the required information. The electrical corporation must provide a summary of each model in Appendix B.

Table 6-1 - SCE’s Summary of Risk Models

ID ⁷⁴	Risk Component	Design Scenario(s)	Key Inputs	Source of Inputs (Data and/or Models)	Key Outputs	Units
R1	Overall Utility Risk	WL1, WL2, WC2, VC1, VC3	Combination of Ignition Risk (R2) and PSPS Risk (R3)	See descriptions for individual risk components	Overall wildfire and PSPS risk	MARS units
R2	Ignition Risk	Same as R1	Product of Ignition Likelihood (IRC1) and Wildfire Consequence (IRC3)	See descriptions for individual risk components	Wildfire risk per asset	MARS units
R3	PSPS Risk	Same as R1	Product of PSPS Likelihood (IRC4) and PSPS Consequence (IRC5)	See descriptions for individual risk components	PSPS risk per circuit	MARS units
IRC1	Ignition Likelihood	Same as R1	Combination of Equipment Ignition Likelihood (FRC1),	POI Model	Ignition likelihood per asset	annualized ignition probability

⁷⁴ Naming convention is based on Section 6.2.1 of the WMP Technical Guidelines: R = risk; IRC = intermediate risk component; FRC = fundamental risk component.

ID ⁷⁴	Risk Component	Design Scenario(s)	Key Inputs	Source of Inputs (Data and/or Models)	Key Outputs	Units
			Contact from Vegetation Ignition (FRC2), and Contact by Object Ignition Likelihood (FRC3)			per asset
IRC2	Wildfire Likelihood	N/A ⁷⁵	N/A	N/A	N/A	N/A
IRC3	Wildfire Consequence	Same as R1	assets, historical climatology, population, fuels, topography, buildings, wildfire vulnerability	Technosylva/Wildfire Consequence Model	Wildfire consequence for each ignition simulation in natural units (acres, buildings, population)	wildfire consequence in either natural units or MARS units
RC4	PSPS Likelihood	Same as R1	Weather and wind data, PSPS post-event reports, current de-energization criteria, existing mitigations	Weather Research and Forecasting (WRF); mitigation deployment	PSPS likelihood per circuit	PSPS likelihood per circuit
IRC5	PSPS Consequence	Same as R1	Number of customers on a circuit, Safety and Financial proxy factors	Customer database, internal claims data (financial proxy) and historical widespread outage data	PSPS consequence in natural units converted to MARS units per circuit	PSPS consequence in MARS units per circuit
FRC1	Equipment Ignition Likelihood	Same as R1	assets, outage database, historical faults/ignitions, pole loading, historical weather, wire down database, work/repair orders	SAP EAM, SAS, GE Small World/Map 3D	Ignition Likelihood	annualized ignition probability of ignition

⁷⁵ Please see Section 6.2 for SCE's approach to risk components marked as "N/A".

ID ⁷⁴	Risk Component	Design Scenario(s)	Key Inputs	Source of Inputs (Data and/or Models)	Key Outputs	Units
FRC2	Contact from Vegetation Ignition Likelihood	Same as R1	assets, outage database, historical faults/ignitions, pole loading, historical weather, wire down database, work/repair orders	SAP EAM, SAS, GE Small World/Map 3D	Ignition Likelihood	annualized ignition probability of ignition
FRC3	Contact by Object Ignition Likelihood	Same as R1	assets, outage database, historical faults/ignitions, pole loading, historical weather, wire down database, work/repair orders	SAP EAM, SAS, GE Small World/Map 3D	Ignition Likelihood	annualized ignition probability of ignition
FRC4	Burn Probability	N/A	N/A	N/A	N/A	N/A
FRC5	Wildfire Hazard Intensity	N/A	N/A	N/A	N/A	N/A
FRC6	Wildfire Exposure Potential	N/A	N/A	N/A	N/A	N/A
FRC7	Wildfire Vulnerability ⁷⁶	Same as R1	Access and Functional Needs (AFN) and Non-Residential Critical Infrastructure (NRCI) customers	Customer database and surveys	AFN and NRCI multipliers on each circuit	unitless multiplier between 1 and 2
FRC8	PSPS Exposure Potential	N/A	N/A	N/A	N/A	N/A
FRC9	PSPS Vulnerability	Same as R1	Access and Functional Needs (AFN) and Non-Residential Critical Infrastructure (NRCI) customers	Customer database and surveys	AFN and NRCI multipliers on each circuit	unitless multiplier between 1 and 2

⁷⁶ For the sake of simplicity, SCE has limited the entry for Wildfire Vulnerability in the table above to how the risk component is used in the MARS Framework. Under its IWMS Risk Framework, SCE considers additional elements of vulnerability such as egress constraints and Communities of Elevated Fire Concern. This approach is described in detail in Section 6.2.1.

6.2 Risk Analysis Framework

In this section of the WMP, the electrical corporation must provide a high-level overview of its risk analysis framework. This includes a summary of key modeling assumptions, input data, and modeling tools used.

At a minimum, the electrical corporation must evaluate the impact of the following factors on the quantification of risk:

- **Equipment / Assets** (e.g., type, age, inspection, maintenance procedures, etc.)
- **Topography** (e.g., elevation, slope, aspect, etc.)
- **Weather** (at a minimum this must include statistically extreme conditions based on weather history and seasonal weather)
- **Vegetation** (e.g., type/class/species/fuel model, canopy height/base height/cover, growth rates, moisture content, inspection, clearance procedures, etc.)
- **Climate change** (e.g., long-term changes in seasonal weather; statistical extreme weather; impact of change on vegetation species, growth, moisture, etc.) at a minimum, this must include adaptations of historical weather data to current and forecasting future climate
- **Social vulnerability** (e.g., AFN, socioeconomic factors, etc.)
- **Physical vulnerability** (e.g., people, structures, critical facilities/infrastructure, etc.)
- **Coping capacities** (e.g., limited access/egress, etc.)

SCE provides its key modeling assumptions in Section 6.2.3 (Key Assumptions and Limitations).

The factors listed above (e.g., Equipment/Assets, Topography, etc.) are summarized below in Table SCE 6-01.

Table SCE 6-01 - Risk Quantification Factors

	MARS Framework ⁷⁷	IWMS Risk Framework ⁷⁸
Equipment/Assets	Included in Wildfire POI component	Evaluated during the Review & Revise stage of the IWMS Risk Framework
Topography	Included in Wildfire Consequence Component	Included in Wildfire Consequence Component and in Severe Risk Area Methodology ⁷⁹
Weather	Included in POI and Wildfire Components	Included in Wildfire Consequence Component and in Severe Risk Area Methodology
Vegetation	Included in Wildfire Consequence Component	Included in Wildfire Consequence Component and in Severe Risk Area Methodology
Climate change	Not currently factored ⁸⁰	Not currently factored
Social vulnerability	Included in Wildfire and PSPS Consequence Components	Not directly factored
Physical vulnerability	Included in Wildfire and PSPS Consequence Components	Included in Severe Risk Area Methodology
Coping capacities	Not directly factored	Included in Severe Risk Area Methodology

6.2.1 Risk and Risk Component Identification

In this section, the electrical corporation must provide a brief narrative and one or more simple graphics describing the framework that defines its overall utility risk. At a minimum, the electrical corporation must define its overall utility risk as the comprehensive risk due to both wildfire and PSPS events across its service territory. This includes several likelihood and consequence risk components that are aggregated based on the framework shown in Figure 6-1 below. The following paragraphs define each risk component.

⁷⁷ The MARS Framework was initially described in Section 6.1.1 and is further described in Section 6.2.1.

⁷⁸ The IWMS Risk Framework was initially described in Section 6.1.1 and is further described in Section 6.2.1.

⁷⁹ See Section 6.2.1 for additional details.

⁸⁰ See Section 6.3 for additional details regarding ongoing work to develop forward looking climate change scenarios.

Figure 6-1 - Composition of Overall Utility Risk

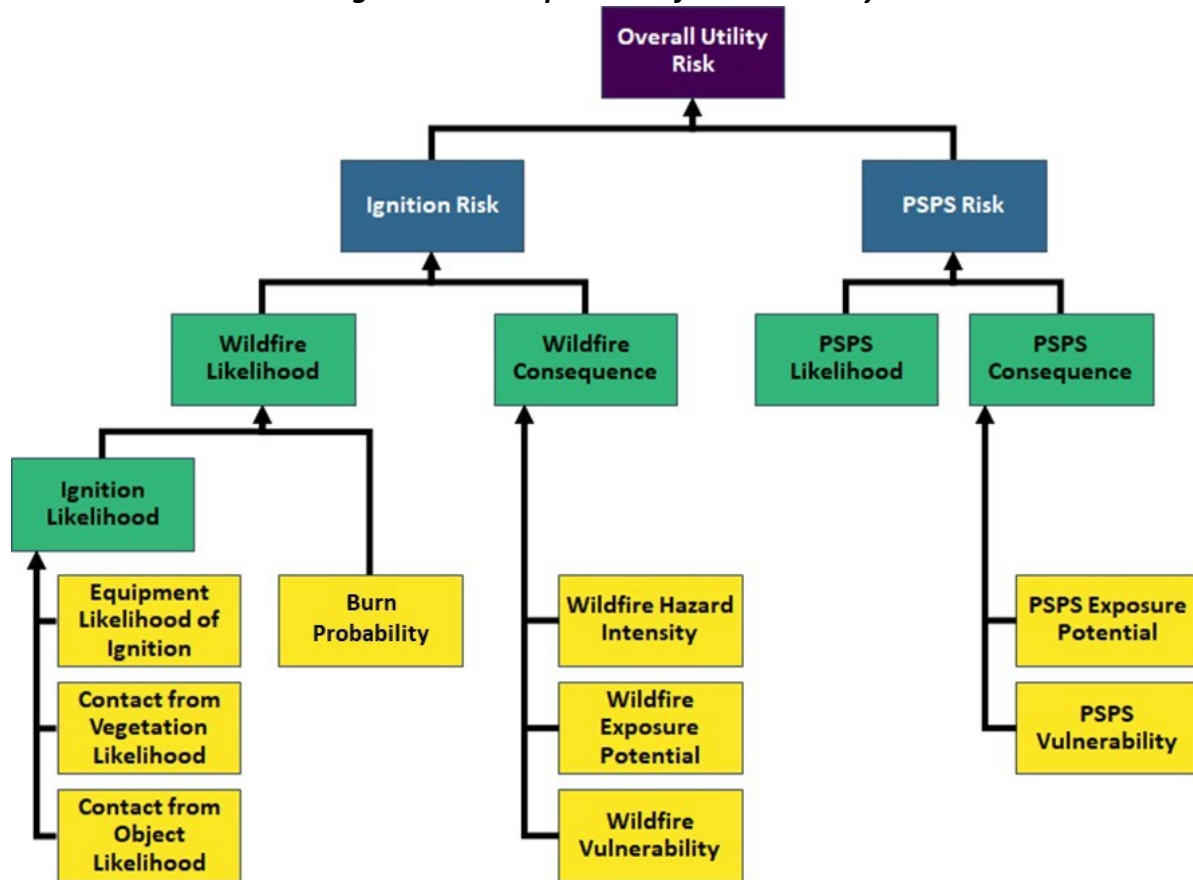

[SCE Note: This diagram (i.e., Figure 6-1) is found in Energy Safety’s Technical Guidelines (p. 37). SCE’s diagrams are found later in this section].

While the overall utility risk framework and associated risk components identified in Section 6.2 are the minimum requirements for determining overall utility risk, the electrical corporation may elect to include additional risk components as needed to better define risk for its service territory. Where the electrical corporation identifies additional terms as part of its risk framework, it must define those terms. The electrical corporation must include a schematic demonstrating its adopted risk framework (similar to Figure 6-1), including any components beyond minimum requirements.

As shown in Figure 6-1 overall utility risk is broken down into two individual hazard risks:

- **Ignition risk:** The total expected annualized impacts from ignitions at a specific location. This considers the likelihood that an ignition will occur, the likelihood the ignition will transition into a wildfire, and the potential consequences—considering hazard intensity, exposure potential, and vulnerability—the wildfire will have for each community it reaches
- **PSPS risk:** The total expected annualized impacts from PSPS at a specific location. This considers two factors: (1) the likelihood a PSPS will be required due to environmental conditions exceeding

design conditions, and (2) the potential consequences of the PSPS for each affected community, considering exposure potential and vulnerability

The individual hazard risks are further broken down into 14 risk components. These risk components are split into two categories, intermediate and fundamental. Fundamental risk components are the smallest components of risk that the electrical corporation must determine as part of its risk analysis.

Intermediate risk components are the likelihood and consequence related to each hazard. Each fundamental or intermediate risk component provides valuable insight in an electrical corporation's wildfire and PSPS risk calculations.

There are a minimum of five intermediate risk components:

- **Ignition likelihood:** *The total anticipated annualized number of ignitions resulting from electrical corporation-owned assets at each location in the electrical corporation's service territory. This considers probabilistic weather conditions, type and age of equipment, and potential contact of vegetation and other objects with electrical corporation assets. This should include the use of any method used to reduce the likelihood of ignition. For example, the use of protective equipment and device settings to reduce the likelihood of an ignition upon an initiating event.*
- **Wildfire likelihood:** *The total anticipated annualized number of fires reaching each spatial location resulting from utility-related ignitions at each location in the electrical corporation service territory. This considers the ignition likelihood and the likelihood that an ignition will transition into a wildfire based on the probabilistic weather conditions in the area.*
- **Wildfire consequence:** *The total anticipated adverse effects from a wildfire on each community it reaches. This considers the wildfire hazard intensity, the wildfire exposure potential, and the inherent wildfire vulnerabilities of communities at risk (see definitions in the following list).*
- **PSPS likelihood:** *The likelihood of an electrical corporation requiring a PSPS given a probabilistic set of environmental conditions.*
- **PSPS consequence:** *The total anticipated adverse effects from a PSPS for a community. This considers the PSPS exposure potential and inherent PSPS vulnerabilities of communities at risk (see definitions in the following list).*

There are a minimum of nine fundamental risk components:

- **Equipment ignition likelihood:** *The likelihood that electrical corporation-owned equipment will cause an ignition either through normal operation (such as arcing) or through failure.*
- **Contact from vegetation ignition likelihood:** *The likelihood that vegetation will contact electrical corporation-owned equipment and result in an ignition.*
- **Contact by object ignition likelihood:** *The likelihood that a non-vegetative object (such as a balloon or vehicle) will contact electrical corporation-owned equipment and result in an ignition.*
- **Burn probability:** *The likelihood that a wildfire with a nearby but unknown ignition point will burn a specific location within the service territory based on a probabilistic set of weather profiles, vegetation, and topography.*

- **Wildfire hazard intensity:** *The potential intensity of a wildfire at a specific location within the service territory given a probabilistic set of weather profiles, vegetation, and topography.*
- **Wildfire exposure potential:** *The potential physical, social, or economic impact of wildfire on people, property, critical infrastructure, livelihoods, health, environmental services, local economies, cultural/historical resources, and other high-value assets. These may include direct or indirect impacts, as well as short- and long-term impacts.*
- **Wildfire vulnerability:** *The susceptibility of people or a community to adverse effects of a wildfire, including all characteristics that influence their capacity to anticipate, cope with, resist, and recover from the adverse effects of a wildfire (e.g., access and functional needs customers, Social Vulnerability Index, age of structures, firefighting capacities).*
- **PSPS exposure potential:** *The potential physical, social, or economic impact of a PSPS event on people, property, critical infrastructure, livelihoods, health, local economies, and other high-value assets.*
- **Vulnerability of community to PSPS (PSPS vulnerability):** *The susceptibility of people or a community to adverse effects of a PSPS event, including all characteristics that influence their capacity to anticipate, cope with, resist, and recover from the adverse effects of a PSPS event (e.g., high AFN population, poor energy resiliency, low socioeconomics).*

The electrical corporation must adopt these definitions in this section of the WMP. If the electrical corporation considers additional intermediate and fundamental risk components, it must define those components in this section as well.

6.2.1.1 MARS Framework

SCE uses its Multi-Attribute Risk Score Framework (MARS Framework or MARS) to quantify Wildfire and PSPS risk. This framework was used in SCE’s recent 2022 Risk Assessment and Mitigation Phase (RAMP) application, filed in May 2022, and aligns with the methodology adopted in the CPUC’s Safety Model Assessment Proceeding (SMAP).⁸¹

The diagram below shows how the risk components are used in the MARS Framework. The colors match how Energy Safety has presented the risk components in Figure 6-1.

Risk components and calculation methodologies are further described Section 6.2.1, Section 6.2.2, and Appendix B: Supporting Documentation for Risk Methodology and Assessment.

⁸¹ Please see D.18-12-014 at <https://www.publicadvocates.cpuc.ca.gov/general.aspx?id=3345>)

Figure SCE 6-01 - SCE's MARS Framework

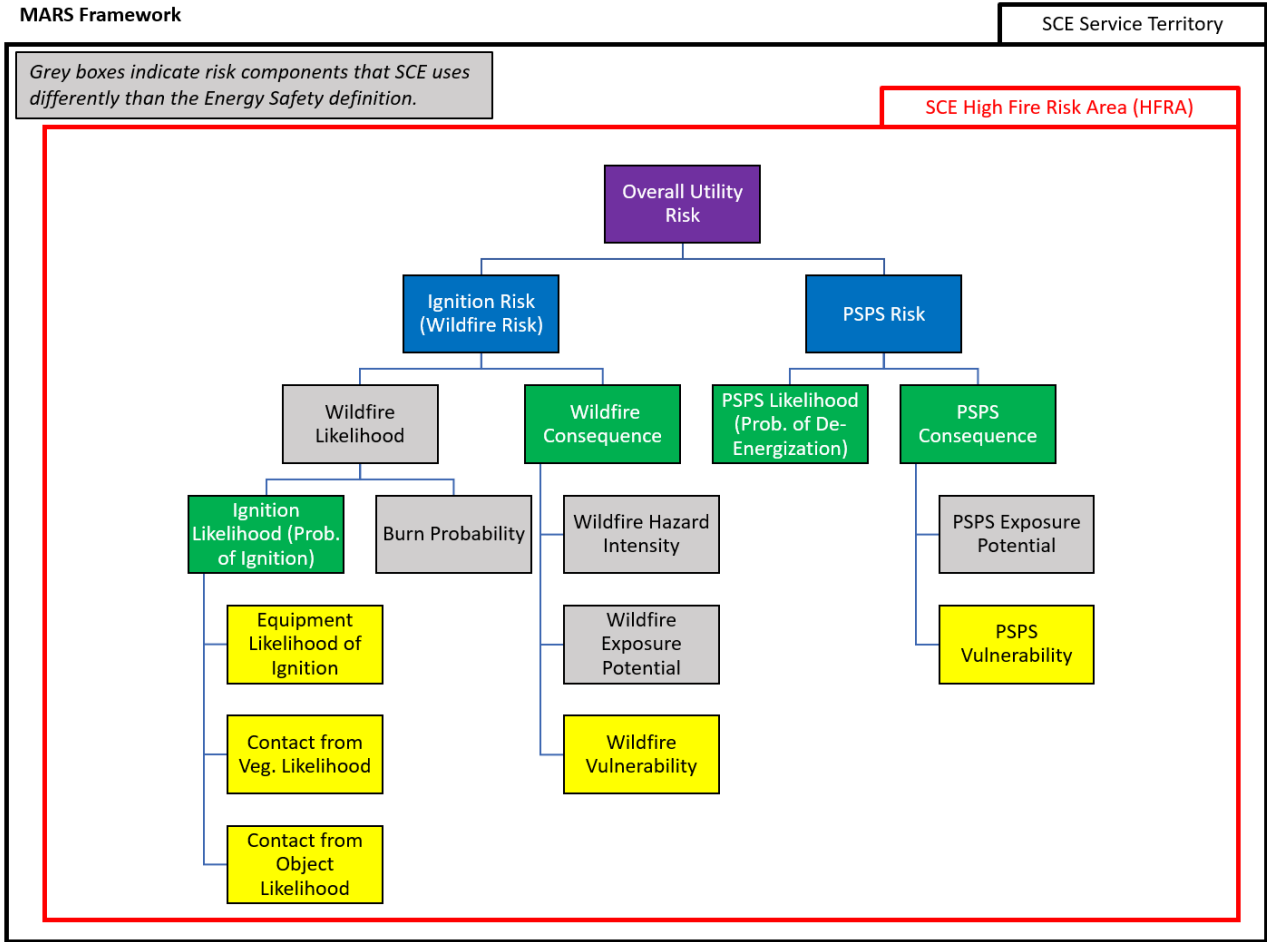

The MARS framework is constructed by using a risk bowtie methodology, as shown below.

Figure SCE 6-02 - Illustrative Risk Bowtie



The left side of the risk bowtie describes ignition drivers and sub drivers as well as the associated probability of those events. The center of the bowtie describes the risk event itself.

In the case of wildfire ignition risk, the risk event is an ignition associated with SCE overhead electrical equipment in SCE’s HFRA. In the case of PSPS, the risk event is a de-energization event during fire weather conditions when current de-energization thresholds are exceeded.

The right side of the bowtie describes the resulting deterministic consequences due to an ignition (in the case of wildfire ignition risk) or a proactive de-energization event (in the case of PSPS risk). These natural units for safety, reliability, and financial consequences are converted to a unitless multi attribute risk score (MARS) through SCE's Multi Attribute Value Function (MAVF). This conversion process is described in additional detail in Section 6.2.2.

To calculate baseline wildfire risk, SCE first estimates a probability of ignition (POI) for each individual ignition driver (e.g., equipment/facility failure (EFF), contact from object (CFO)) and sub-driver (e.g., EFF: conductor failure or CFO: vegetation) for individual distribution and transmission assets. Separately, SCE performs match-drop wildfire simulations along each of these asset locations to estimate consequences in natural units (e.g., acres burned, buildings impacted, population impacted) associated with an ignition emanating from those assets at their specific geographic locations. SCE then combines the POI and the consequences at the asset level to estimate a baseline wildfire risk score.

To calculate a baseline PSPS risk, SCE first estimates the baseline probability of de-energization (POD) of each circuit using a 10-year historical back-cast of weather, wind, fuel dryness conditions using the current Fire Potential Index (FPI), and fuel de-energization thresholds. The consequences of de-energization are derived by estimating the associated frequency and duration of those events and multiplying them by the resulting consequences in natural units (e.g., Customer Minutes of Interruption (CMI)). SCE then combines the POD and the consequences at the circuit level, along with the MARS framework, to estimate a baseline risk score for PSPS.

The key assumptions used to derive pre- and post-mitigation POI and POD include historical ignitions, ignition drivers, historical de-energization events, wind, weather, fuel conditions, mitigation effectiveness assumptions, and fuels or high wind conditions in proximity to SCE overhead distribution and transmission assets in HFRA.

The key assumptions used to estimate wildfire consequences are based on a catalog of 444 historical wind and weather scenarios representing high fire weather conditions. These fire weather scenarios include the 41 weather scenarios originally used by the CPUC to designate HFTD, as well as 403 additional scenarios added by SCE representing both wind-driven and fuel-driven wildfire (dry fuels, but low or no wind) conditions. SCE uses the maximum consequence value (e.g., acres max) across each of these scenarios based on eight-hour simulated wildfire progression without fire suppression at each location to represent the consequence value at each of those individual locations.

The wildfire simulations are conducted for a standard eight-hour unsuppressed burn period to provide a comparable consequence estimate across all locations. If fire simulations were to extend beyond eight hours, or suppression impacts were included (e.g., response timing and complexity), the level of uncertainty associated with the model output can increase to the point where the simulation would not be meaningful.

Therefore, at this time, SCE does not extend the simulation duration beyond 8 hours and does not directly include a probabilistic assessment of suppression based on historical suppression data, as there are inherent risks associated with over-representing the availability of suppression resources. SCE recognizes these are points of interest with stakeholders and looks forward to continuing to engage with Energy Safety and stakeholders through applicable forums and working groups.

The key input data used for wildfire consequence estimates are fuel models based on LandFire 2016, with the addition of 19 custom fuel models. SCE updates its fuel model annually. A fuel regrowth algorithm is used to “grow up” fuels in locations with large historical fire scars (greater than 5,000 acres) to project fuel growth out to 2030. Climate change influenced forecast weather conditions are not included at this time. However, as discussed in Energy Safety’s risk modeling workshops, SCE is developing a climate change scenario by simulating additional fuel dryness in 2030 fuels for evaluation purposes. See Section 6.3.2 for additional discussion.

SCE also utilizes Access and Functional Need (AFN) and Non-Residential Critical Infrastructure (NRCI) information for each location to account for the relative baseline and post-mitigated risk associated with wildfire and PSPS in vulnerable locations. SCE has considered other census tract-based sources of data such as CalEnviroscreen, Centers for Disease Control (CDC), Social Vulnerability Index (SVI), and the Federal Emergency Management Agency (FEMA) National Risk Index (NRI) data. SCE has determined that these data sources currently lack the granularity required to scale the information down to correspond to other risk data SCE uses at the asset or location level.

The key input data for wildfire POI and PSPS POD estimates are SCE’s overhead asset location data, weather and wind data from Atmospheric Data Solutions (ADS) and SCE weather stations, SCE’s Outage Database and Reliability Metric (ODRM) system, PSPS event data, SCE’s Fire Incident Preliminary Analysis (FIPA) process, vegetation data, and historical de-energization criteria.

In addition to the fuel and weather assumptions described above, SCE uses granular Microsoft building data and the latest available data from U.S. Department of Homeland Security (LandScan 2018) population data to represent individual building footprints and 90m centroid population density, respectively. These data are used to derive associated natural unit consequence impacts from wildfire simulations.

The modeling tools SCE employs are a series of machine learning algorithms (e.g., random forest, gradient boosting) to derive and calibrate POI estimates for each wildfire risk driver. SCE also uses Technosylva Wildfire Analyst to perform match drop simulations to derive wildfire consequences and python-based algorithms to derive both POD and PSPS consequences.

6.2.1.2 IWMS Risk Framework

SCE’s IWMS Risk Framework is used to define three risk tranches within SCE’s HFRA. These three risk tranches are key elements of how SCE selects, prioritizes, and scopes wildfire and PSPS mitigations.

The figure below shows how the risk components are used in the IWMS Risk Framework. The colors match how Energy Safety has presented the risk components in Figure 6-1.

Risk components and calculation methodologies are further described in Section 6.2.1, Section 6.2.2, and Appendix B: Supporting Documentation for Risk Methodology and Assessment.

Figure SCE 6-03 - SCE's IWMS Risk Framework

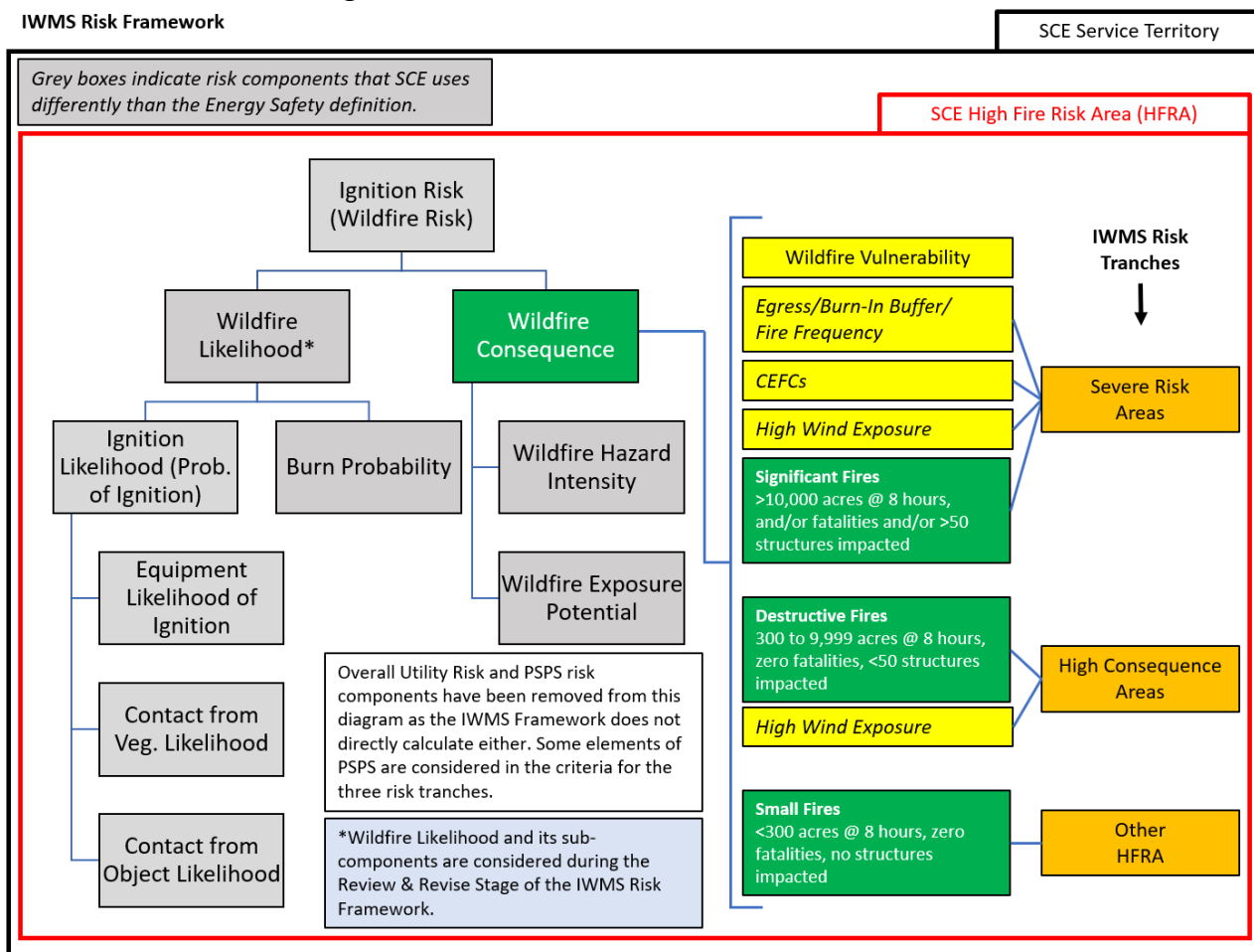

SCE started using the IWMS Risk Framework to prioritize mitigation selection and scope for grid hardening activities, inspection programs, and vegetation management activities in 2022. Due to the long lead time for planning and construction for covered conductor and undergrounding, the earliest that mitigations scoped with the IWMS Risk Framework will be placed in-service is 2023.

In early 2022, SCE reviewed in-flight covered conductor scope for 2022 and 2023 that was still in earlier stages for alignment to the IWMS Risk Framework. Based on those reviews, SCE made decisions to either continue the mitigation as-is, target for higher risk mitigation activity, or stop scope completely.

SCE also evaluated the alignment of IWMS with the High-Fire Risk Informed (HFRI) detailed inspection scope strategy and has prioritized structures in Severe Risk Areas and High Consequence Areas to be inspected more frequently starting with 2023 inspections.

Similar alignment was also assessed in 2022 for vegetation management program strategy, such as with the Heavy Tree Mitigation Program (HTMP), where the risk methodology utilized assigned vegetation grids that had higher proportions in Severe Risk Areas to be placed on annual inspection cycles.

The risk assessment portion of the IWMS Risk Framework features two major stages (Initial Risk Categorization and then Review & Revision) which are described below.

Stage 1: Initial Risk Categorization

The first stage of IWMS uses quantitative risk analysis that incorporates several factors to deliver an initial output that categorizes all of SCE's HFRA circuit segments into risk tranches defined as Severe Risk Areas, High Consequence Areas, and Other HFRA.

- Severe Risk Areas (SRA) are locations that are characterized by elevated population risk factors such as heightened egress risk, significant wildfire risk, and/or heightened risk of high wind events.
- High Consequence Areas (HCA) are segments where simulated fires exceed 300 acres in eight hours and do not have the same level of population risk as the Severe Risk Areas. These circuit segments are sited in locations where wildfire can propagate over a relatively short period of time.
- Other HFRA encompasses locations within HFRA that do not meet either of the previous criteria.

A detailed description of these three risk tranches, including all factors used, is provided below.

Severe Risk Areas

The CPUC has already defined⁸² all areas in HFTD as inherently being at elevated or extreme risk of wildfire. SCE has determined a subset of those regions are "Severe Risk Areas" as they have attributes that further elevate the risk levels to populations residing, working in, or visiting these locations.

SCE uses the following four criteria to determine Severe Risk Areas:

1. Population egress constraints, high fire frequency, and burn-in buffer into egress locations.
2. Significant fire consequence – Acres burned consequence greater than 10,000 over an 8-hour unsuppressed model simulation.
3. High winds – Locations, which if fully covered with covered conductor, would still be subject to high PSPS likelihood.
4. Communities of Elevated Fire Concern (CEFCs) – Smaller geographic areas where terrain, construction, and other factors could lead to smaller, fast-moving fires threatening populated locations under benign (normal) weather conditions.

SCE notes that a circuit mile may meet multiple SRA criteria.

⁸² CPUC Decision 17-12-024, Decision Adopting Regulations to Enhance Fire Safety in the High Fire-Threat District, 12/21/2017.

SRA Criteria #1: Egress Constraints, High Fire Frequency & Burn-In Buffer

This criteria includes five steps:

1. Divide SCE's HFRA into equally sized polygons.
2. Identify egress-constrained locations.
3. Determine locations that have experienced high fire frequency historically.
4. Overlay the egress-constrained locations with historical high fire frequency locations to determine Fire Risk Egress Constrained Areas.
5. Add a burn-in buffer to Fire Risk Egress Constrained Areas.

Figure SCE 6-04 - Polygon Assignment

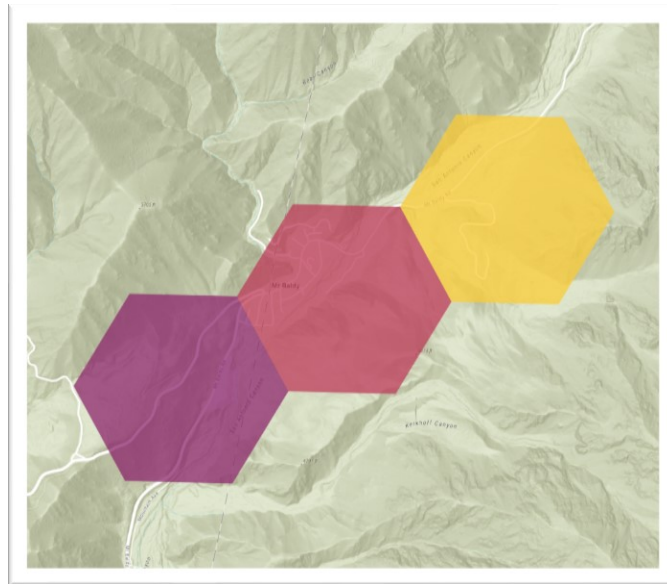

SCE divided its service area into hexagons approximately 214 acres in size. SCE used hexagons because the distance from the center of a hexagon to all adjacent hexagons is the same distance (1,000 meters) and it enabled SCE to compare variables across similar-sized polygons.

Figure SCE 6-05 - Identify Egress-Constrained Areas

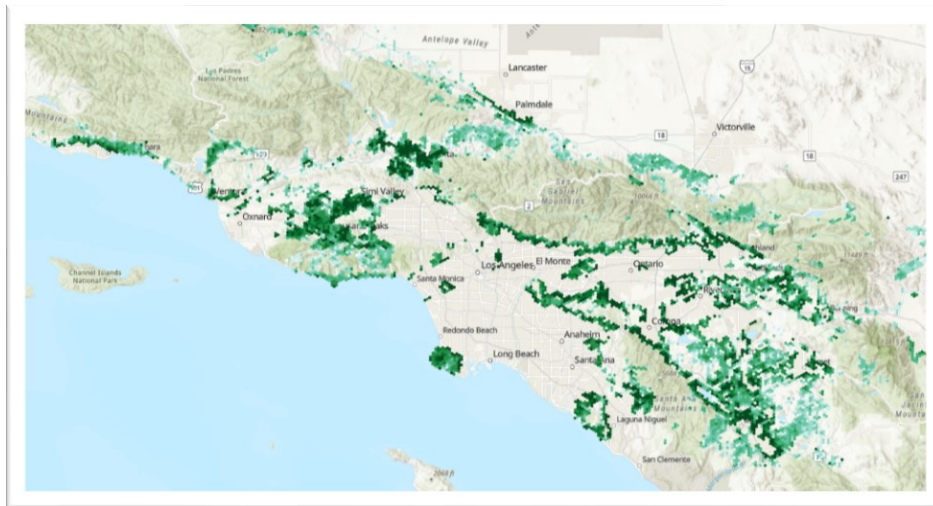

SCE determined which hexagons in its HFRA have substantial road availability concerns using a ratio of roads to population in each hexagon. A lower score indicates 0.5 or fewer miles of roads available per person in a given hexagon, creating a potential egress concern should everyone in the polygon need to evacuate the area simultaneously.

Figure SCE 6-06 - Identify Areas with a High Frequency of Fires

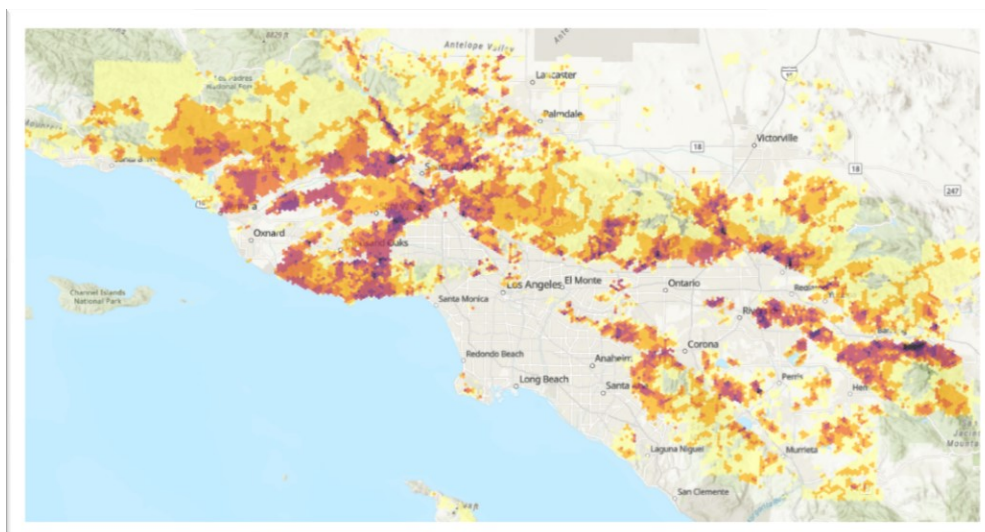

SCE determined which hexagons in its HFRA that have a high frequency of historical fires, using fire scars, from 1970 to 2020.⁸³ A higher score indicates a higher likelihood that a given hexagon will burn, meaning fires either originated from or travel into these hexagons.

Figure SCE 6-07 - Overlay Areas with a High Frequency of Fires with Egress-Constrained Areas

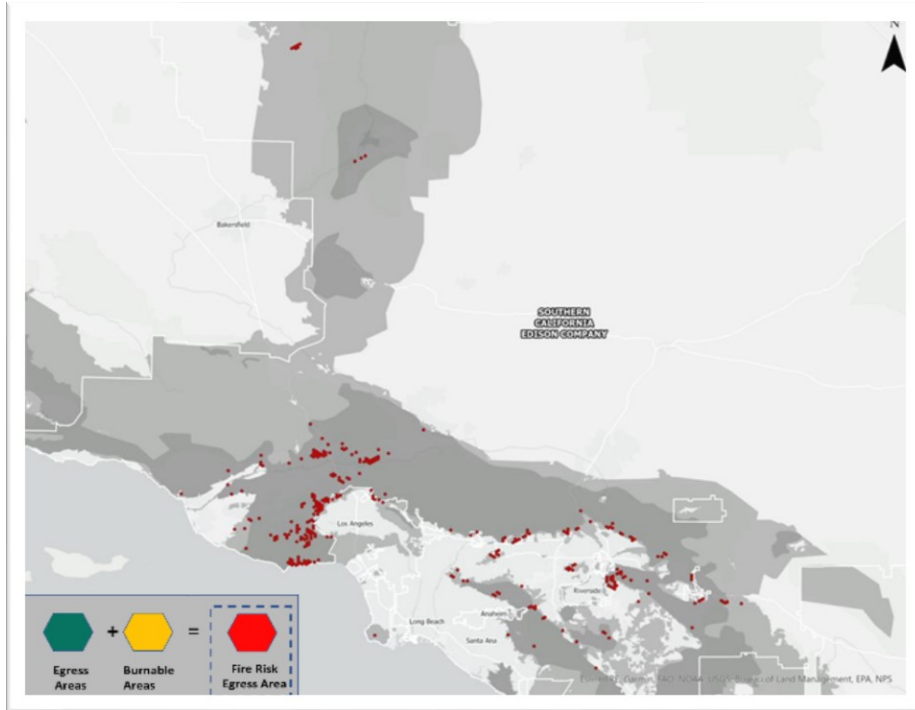

SCE then overlaid the egress-constrained areas with regions that have a high historical fire frequency. SCE flagged hexagons with both limited road availability and a high burn frequency as potential Fire Risk Egress Constrained Areas.

Figure SCE 6-08 - Delineate Burn in Buffer



Next, utilizing Technosylva ignition simulation data, SCE determined which of SCE’s overhead structures could result in fires burning into Fire Risk Egress Constrained Areas. SCE performed a calculation to identify which structures could potentially result in a fire trapping the public.

Below are the steps to calculate the “Burn in Buffer”.

⁸³ Data from CalFire FRAP database.

1. Identify all structures within 25 miles of a Fire Risk Egress Constrained Area.
2. Calculate the time needed for the population to exit the polygon using population size, travel speed, and distance to safety.
3. Considering terrain and other factors, calculate the distance the fire could travel from each SCE distribution overhead structure within 25 miles, in the time needed to evacuate the Fire Risk Egress Constrained Area.
4. Flag the structure as a potential burn in buffer structure if the fire originating there could enter the Fire Risk Egress Constrained Area.
5. Assess identified locations to determine if the fire will actually burn into a Fire Risk Egress Constrained Area, when accounting for wind direction, topography, and physical barriers (e.g., lakes).

SRA Criteria #2: Significant Fire Consequence

Figure SCE 6-09 - Identify Areas with Exceptionally High Technosylva Consequence Scores

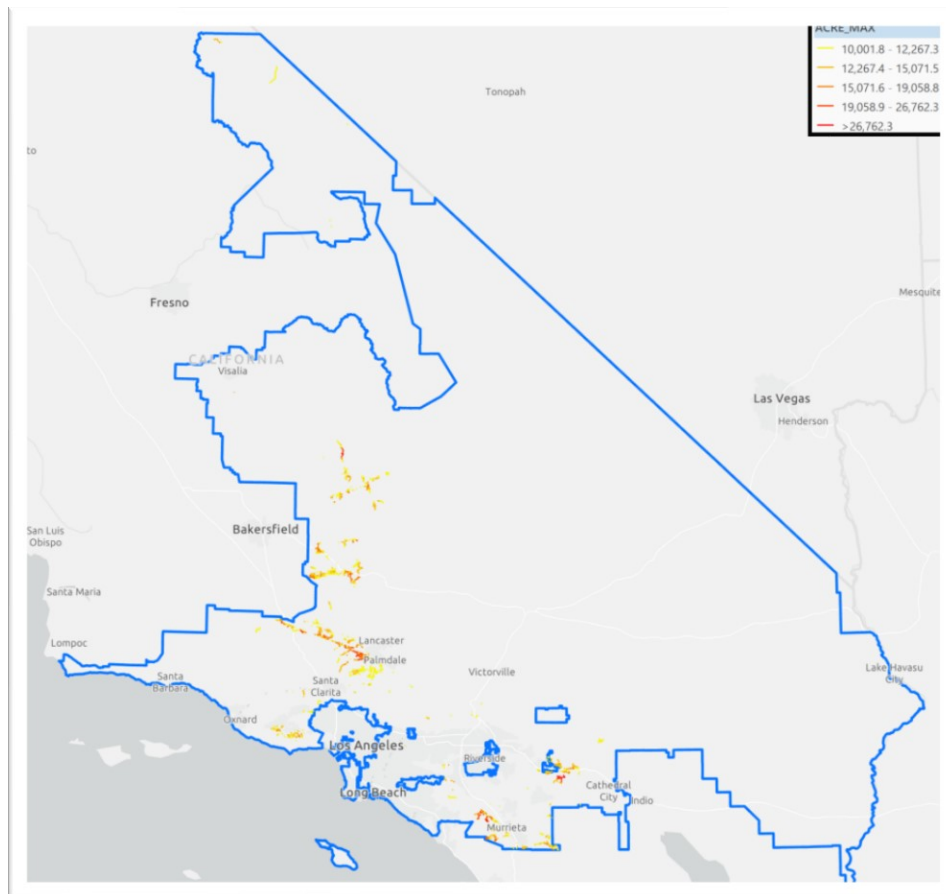

SCE identified segments in its HFRA that have an exceptionally high Technosylva consequence scores in acres burned at 8 hours based on Technosylva ignition simulations. SCE used the threshold of 10,000 acres or greater burned in the first 8 hours. Fires that burn over 10,000 acres in the first 8 hours on average burn over 100,000 acres. SCE provides further explanation for this threshold below.

SRA Criteria #3: High Wind Locations

SCE examined historical wind data from 2017 to determine which areas have experienced high sustained wind speeds above 40 mph and wind gusts above 58 mph (current PSPS de-energization threshold for fully covered isolatable conductor segments).⁸⁴ Even if fully covered, these isolated conductor segments would likely experience some level of PSPS de-energization.

Figure SCE 6-10 - Identify Areas with Extremely High Wind Speeds

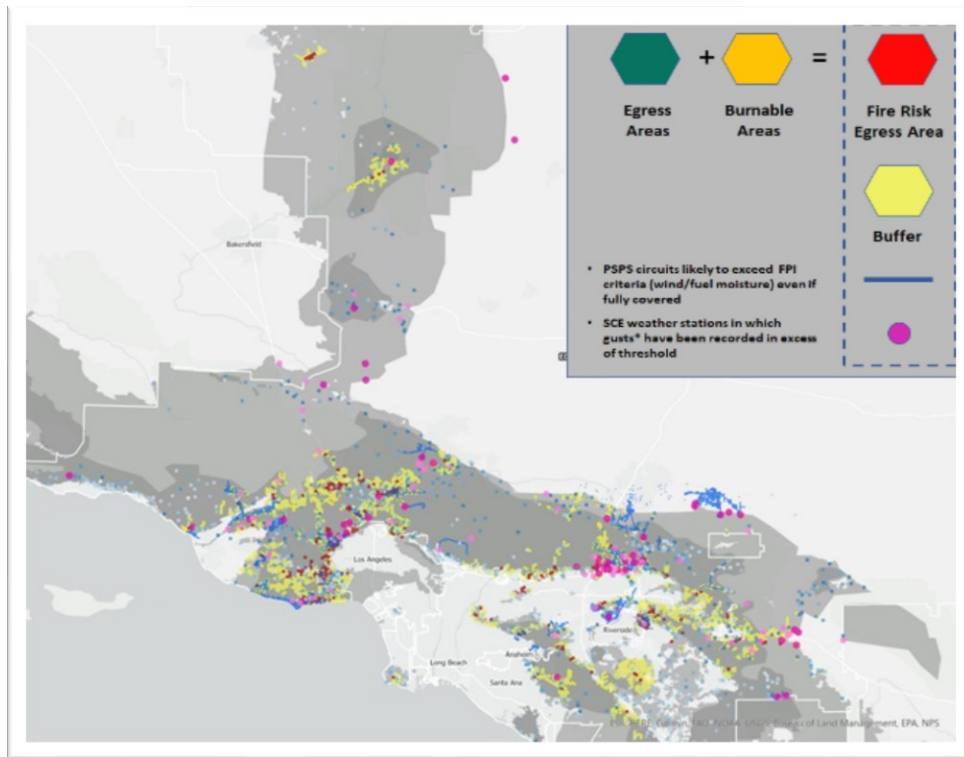

⁸⁴ This may change as SCE modifies thresholds based on further analyses and data over time.

SRA Criteria #4: Communities of Elevated Fire Concern (CEFC)

Figure SCE 6-11 - Communities of Elevated Fire Concern



*Caption for Subdivisions on multiple hilltops surrounded by dense vegetation. Figure SCE 6-11
Fires that start in canyon will burn rapidly uphill towards populated areas. Last major fire in this
area was in 2008.*

SCE identified Communities of Elevated Fire Concern (CEFCs). CEFCs are smaller geographic areas where terrain and other factors could lead to smaller, fast-moving fires threatening populated locations under benign (normal) weather conditions. Examples of these types of communities are those on the edge of a hill, where if an ignition were to occur downhill from that community, the ignition could immediately impact those population centers, even under low to no wind conditions.

High Consequence Areas

SCE uses the following three criteria to determine High Consequence Areas:

1. Not identified in meeting Severe Risk Area criteria.
2. Destructive fire consequence – Acres burned consequence between 300 and 10,000 after an 8-hour unsuppressed model simulation.
3. Locations subject to PSPS events due to high winds in which covered conductor has not been fully deployed.

Destructive Fire Consequence

SCE has also identified additional locations where a wildfire can propagate over large areas (between 300 and 10,000 acres) in a relatively short period of time and/or have the potential to be frequently impacted by PSPS. SCE has categorized these as “High Consequence Areas.”

SCE determined an ignition that can become a 300-acre-or-greater sized fire within the first eight hours has a high probability of eventually becoming very large, thereby posing significant risks to life, health and property. SCE provides further explanation for this threshold below.

High Winds

SCE also conducts an analysis each year that identified circuits that have experienced or are expected to experience high customer minutes of interruption from PSPS de-energizations due to high wind speeds absent appropriate grid hardening. SCE has included those circuits that meet the criteria described above but were not already identified as Severe Risk Areas.

300 Acres Burned Threshold

SCE selected the 300 acres burned and 10,000 acres burned thresholds at 8-hours as the lower and upper limits for High Consequence Areas based on the following analysis.

As indicated in Table SCE 6-02, number of acres burned is a reasonable and reliable correlated proxy for buildings destroyed:

Table SCE 6-02 - 2015-2019 Fire Size and Buildings Destroyed

Final Fire Size (Acres)	Average Buildings Destroyed
300-1k	~2
1k-5k	~7
5k-10k	~15
10k-50k	~200
50k+	~1,250

A fire of 10,000 acres or more destroys approximately 200 buildings, on average.

As indicated in Figure SCE 6-12 below, of the fires that had burned between 300 and 999 acres after 8 hours, 33% eventually burned more than 10,000 acres. In contrast, fires that burned less than 300 acres after 8 hours are much less likely to eventually burn more than 10,000 acres. Of the fires that burned less than 300 acres, only 10% eventually burned more than 10,000 acres. Based on this analysis, SCE selected 300 acres as the lower threshold for modeled fire consequence for High Consequence Areas.

Figure SCE 6-12 - Fire Size at 8 Hours Relative to Final Fire Size

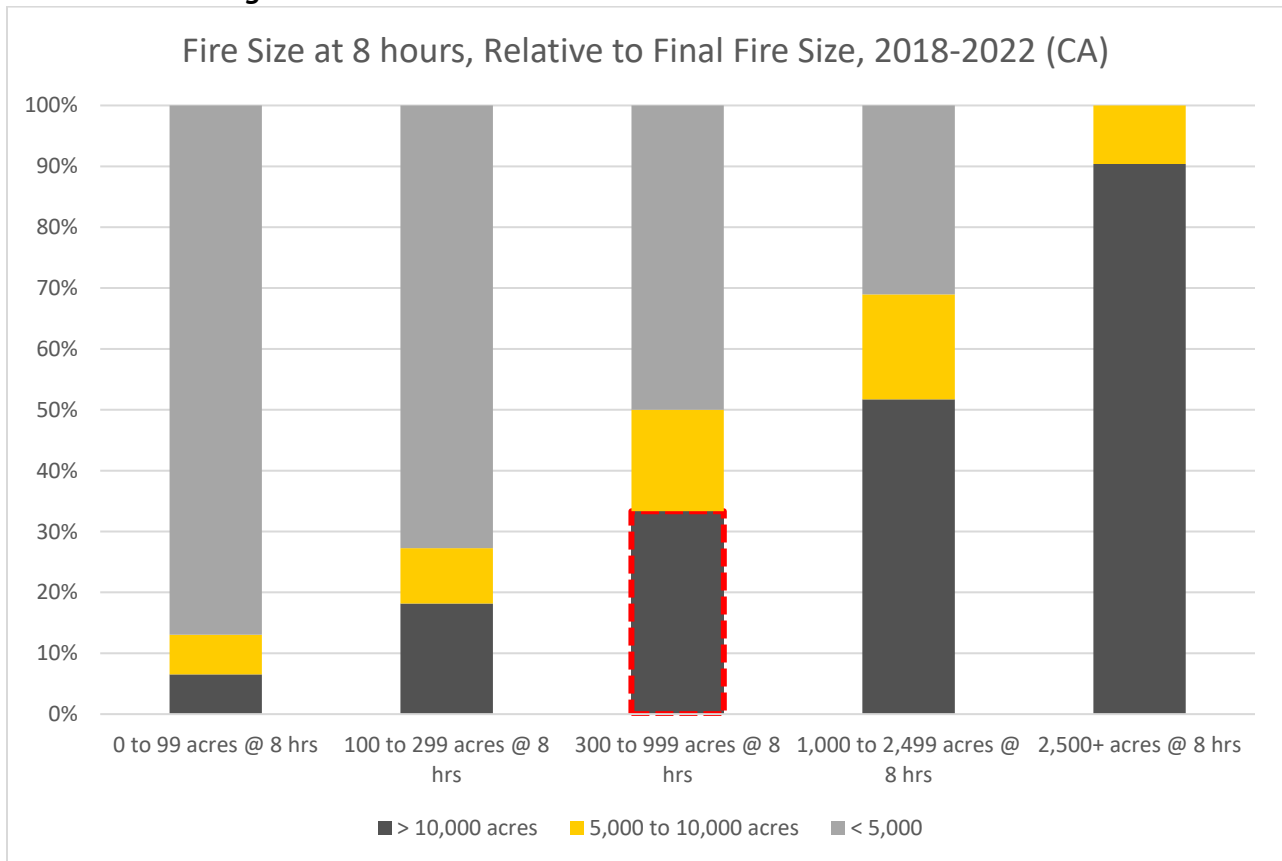

Other HFRA

SCE defines “Other HFRA” as areas that are located in SCE’s HFRA that are neither Severe Risk nor High Consequence but are identified by the Commission as areas of “extreme” and “elevated” wildfire risk in the current CPUC Fire Threat Map (See Section 5.3.3 High Fire Threat Districts).

These locations are still subject to regulatory and compliance requirements for enhanced mitigation activity, such as increased inspections and/or vegetation management.

Summary of IWMS Risk Tranches

Table SCE 6-03 summarizes the risk characteristics of each risk tranche.

Table SCE 6-03 - IWMS Risk Framework Risk Tranches (Mutually Exclusive)

Severe Risk Area Criteria
<ul style="list-style-type: none">○ Population egress, high fire frequency location, and burn-in buffer into egress locations.○ Significant fire consequence – Acres burned consequence greater than 10,000 over an 8-hour unsuppressed model simulation.○ High winds – Locations, which if fully covered with covered conductor, would still be subject to high PSPS likelihood.○ Communities of Elevated Fire Concern (CEFCs) – smaller geographic areas where terrain and other factors could lead to smaller, fast-moving fires threatening populated locations under benign (normal) weather conditions.
High Consequence Area Criteria
<ul style="list-style-type: none">○ Not identified in meeting Severe Risk Area criteria.○ Destructive fire consequence – Acres burned consequence between 300 and 10,000 over an 8-hour unsuppressed model simulation.○ Locations subject to PSPS events in which covered conductor has not been fully deployed.
Other HFRA Criteria
<ul style="list-style-type: none">○ Not identified in meeting Severe Risk Area or High Consequence criteria.○ Small fire consequence - Acres burned consequence less than 300 over an 8-hour unsuppressed model simulation.

The following map illustrates the locations of the Severe Risk, High Consequence, and Other HFRA areas.

Figure SCE 6-13 - IWMS Risk Tranche Designations⁸⁵

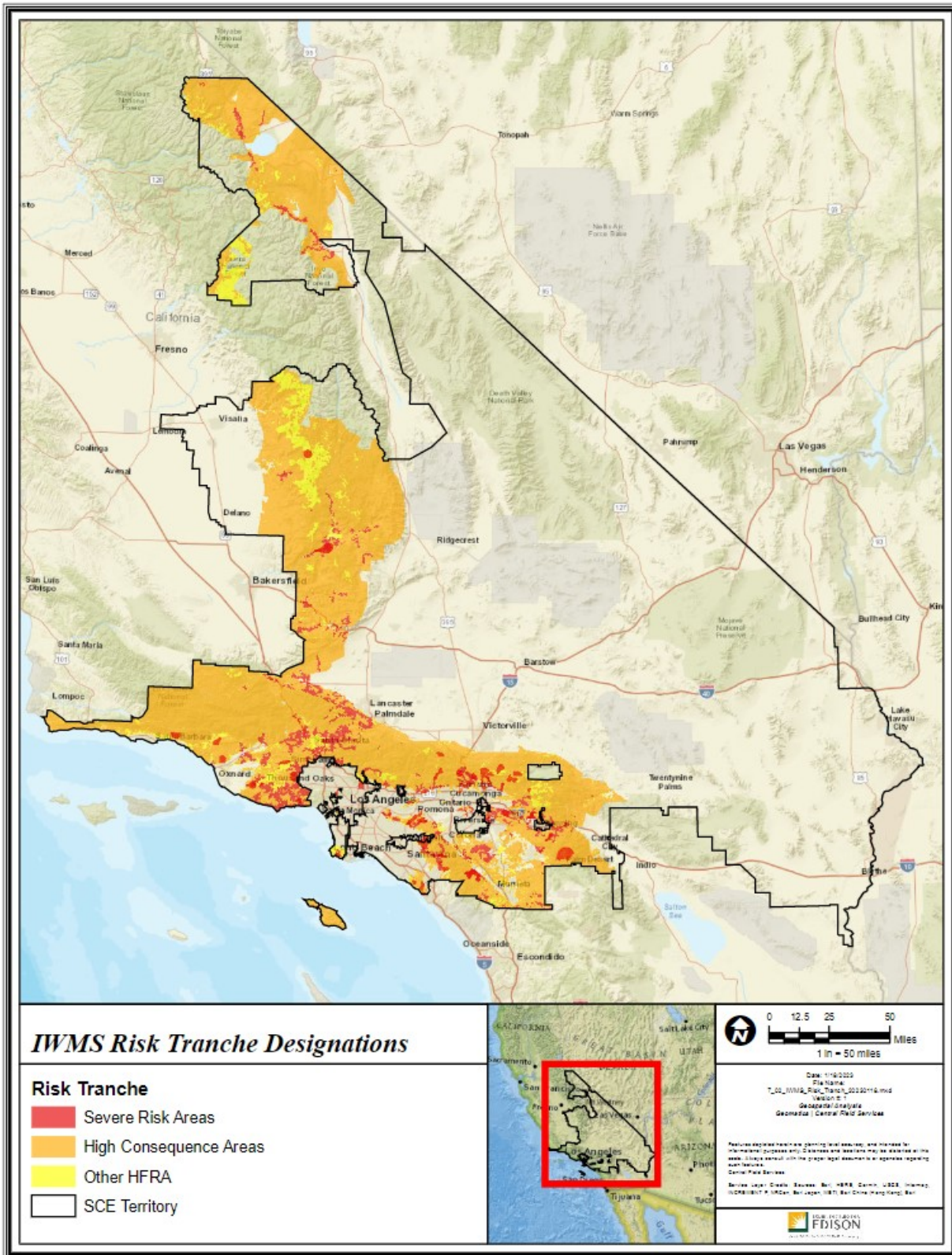

⁸⁵ Map as of 01/18/2023

Table SCE 6-04 - Circuit Miles Per IWMS Risk Tranche⁸⁶

IWMS Risk Tranche	Approximate Circuit Miles
Severe Risk Areas	2,950
High Consequence Areas	4,400
Other HFRA	2,250
Total	9,600

Stage 2: Review & Revise

With exception of CEFC identification, the first stage of IWMS is automated and reliant upon the completeness, granularity, and accuracy of data sources. While valuable as a directional starting point, human judgment is needed to evaluate the results of the risk analysis.

Accordingly, SCE performs further due diligence by reviewing the output using SCE’s inspection photos, geographic information system (GIS), and Google Maps or Street Views with subject matter experts such as engineers and fire science specialists. These deep dives allow SCE’s employees to virtually “walk the line” to determine whether a segment is appropriately categorized.

This stage of the IWMS is time-consuming and labor intensive, as SCE personnel review hundreds of circuit miles of overhead distribution lines. SCE has already started scoping mitigations for areas that have undergone Review & Revise and expects to complete this stage for all HFRA by the second quarter of 2023.

During these reviews, SCE looks for the presence of risk drivers, including but not limited to, heavy trees, long span, local fuel regime, prevailing wind direction and intensity, topography (slope and terrain complexity), local fire ecology, local road accessibility, and existing mitigations (e.g., covered conductor). SCE then makes the determination to either keep the designation as prescribed by the model or recommend an alternate designation as appropriate.

Figure SCE 6-14 below shows an example of a 100% match between the initial output (left picture) and detailed SME review (right picture). This location was identified a Severe Risk Area due to the exceptionally high Technosylva wildfire consequence. A fire starting in this location has the potential to grow larger than 10,000 acres in size in the first eight hours.

SME review confirmed the location of the overhead lines in relation to the dry, heavy vegetation in the area, topography, and potential winds could lead to a fire of this size.

Figure SCE 6-15 shows one of many Google Maps screenshots of the location that SMEs reviewed, confirming the designation as a Severe Risk Area.⁸⁷

⁸⁶ Note that the review of unhardened miles for each area/tranche is in progress. Therefore, the total miles provided in the table are not finalized and are subject to change.

⁸⁷ Figure SCE 6-15 is a screenshot of the location marked with the teal circle in SCE 6-14.

Figure SCE 6-14 - Example of 100% Match of Risk Model and SME Review



Figure SCE 6-15 - Photo of Location Confirms Severe Risk Area Designation

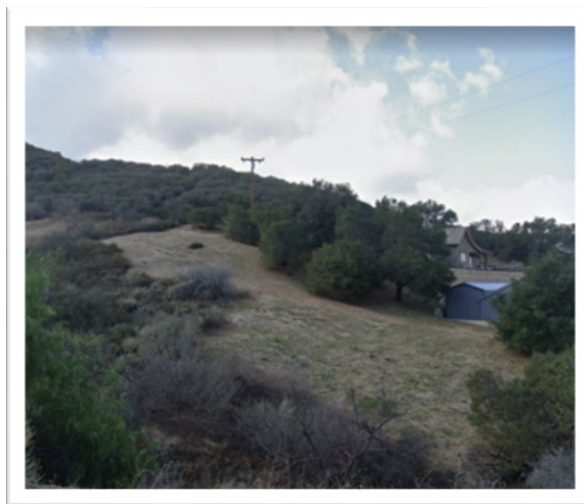

Figure SCE 6-16 below shows an example of a deviation between the initial output (left picture) and detailed SME review (right picture). The initial output flagged these circuit segments as Severe Risk Areas because they fit the criteria of egress constrained and burn-in buffer.

However, during SME review, it became apparent that the overhead lines mainly run over dirt, roads and light brush and relatively fewer structures in the area would be threatened by a wildfire. The recommendation from the detailed SME review for this location was to convert the designation to High Consequence.

Figure SCE 6-17 shows one of many Google Maps screenshots of the location that SMEs reviewed, confirming the need to convert the designation from Severe Risk Area to High Consequence Area.⁸⁸

Figure SCE 6-16 - Example of a Deviation Between Risk Model and SME Review

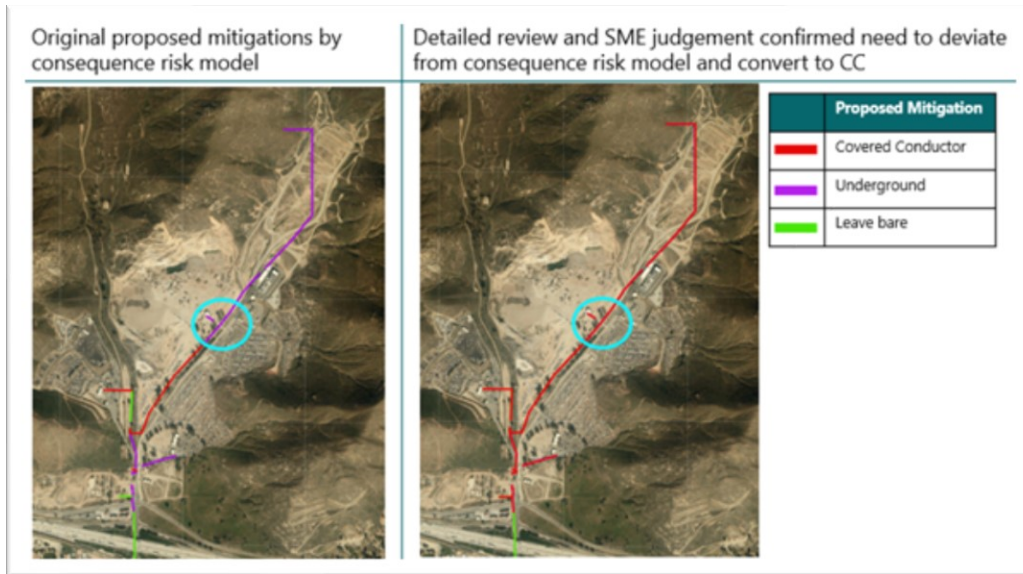

Figure SCE 6-17 - Photo of Location Confirms Need to Convert Designation from Severe Risk to High Consequence



Based on the results of the IWMS Review and Revise stage, SCE selects the appropriate mitigation(s) to deploy to each area. SCE details this aspect of the IWMS in Section 7.1.4.

⁸⁸ Figure SCE 6-17 is a screenshot of the location marked with a teal circle in Figure SCE 6-16.

Individual Hazard Risks

R2: Ignition Risk

Ignition risk: The total expected annualized impacts from ignitions at a specific location. This considers the likelihood that an ignition will occur, the likelihood the ignition will transition into a wildfire, and the potential consequences—considering hazard intensity, exposure potential, and vulnerability—the wildfire will have for each community it reaches

SCE considers Ignition Risk as synonymous with Wildfire Risk, which is the product of Ignition Likelihood (IRC1) and Wildfire Consequence (IRC3). SCE calculates Wildfire Risk at the individual asset level. Overall Wildfire Risk is the sum of the individual asset risks over the entire HFRA.

R3: PSPS Risk

PSPS risk: The total expected annualized impacts from PSPS at a specific location. This considers two factors: (1) the likelihood a PSPS will be required due to environmental conditions exceeding design conditions, and (2) the potential consequences of the PSPS for each affected community, considering exposure potential and vulnerability

SCE's overall PSPS risk is the product of Product of PSPS Likelihood (IRC4) and PSPS Consequence (IRC5). SCE calculates PSPS Risk at the circuit level. Overall PSPS risk is the sum of the circuit level risk in HFRA.

SCE calculates PSPS Risk in the MARS Framework. In the IWMS Risk Framework, locations that experience frequent de-energizations and/or potential for PSPS events even when locations are fully covered are considered for mitigation. Please see the description of both frameworks earlier in this section and in Section 6.1.1 for the basis behind this approach.

Intermediate Risk Components

IRC1: Ignition Likelihood

Ignition likelihood: The total anticipated annualized number of ignitions resulting from electrical corporation-owned assets at each location in the electrical corporation's service territory. This considers probabilistic weather conditions, type and age of equipment, and potential contact of vegetation and other objects with electrical corporation assets. This should include the use of any method used to reduce the likelihood of ignition. For example, the use of protective equipment and device settings to reduce the likelihood of an ignition upon an initiating event.

SCE considers Ignition Likelihood to be synonymous with Probability of Ignition (POI). The pre-mitigated POI for every asset is a probabilistic assessment of Ignition Likelihood prior to mitigation deployment. The POI of each asset is further adjusted to account for system hardening activities (e.g., covered conductor) that have taken place.

POI is the sum of the ignition component probabilities at that location (i.e., Equipment Ignition Likelihood (FRC1), Contact from Vegetation Ignition (FRC2), and Contact by Object Ignition Likelihood (FRC3). POI is used to assess overall utility wildfire risk at a given locations.

Please also see the description below regarding Wildfire Likelihood and how SCE considers Wildfire Likelihood sub-components during the Review & Revise stage of the IWMS Risk Framework.

IRC2: Wildfire Likelihood

Wildfire likelihood: The total anticipated annualized number of fires reaching each spatial location resulting from utility-related ignitions at each location in the electrical corporation service territory. This considers the ignition likelihood and the likelihood that an ignition will transition into a wildfire based on the probabilistic weather conditions in the area.

SCE does not differentiate between Ignition Likelihood and Wildfire Likelihood. As described above in the discussion of Ignition Likelihood and earlier in Section 6.1.1, SCE models potential fire behavior and spread from individual utility asset locations.

During the Review & Revise stage of the IWMS Risk Framework, SCE's risk management, fire science, and engineering experts consider Wildfire Likelihood sub-components such as equipment failure likelihood, contact from vegetation likelihood, and contact from other likelihood in determining potential mitigation selection and deployment. SCE notes that not all sub-components may be applicable in each location.

IRC3: Wildfire Consequence

Wildfire consequence: The total anticipated adverse effects from a wildfire on each community it reaches. This considers the wildfire hazard intensity, the wildfire exposure potential, and the inherent wildfire vulnerabilities of communities at risk (see definitions in the following list).

SCE estimates Wildfire Consequences (e.g., acres burned, structures impacted, population impacted) and their associated safety and financial impacts for a given set of deterministic match drop simulations for all overhead assets in SCE's HFRA across 444 weather scenarios using a 2030 fuel projection.

Wildfire Consequence is used, in conjunction with Wildfire Vulnerability, to assess the impact of potential consequences associated with an ignition event in proximity to overhead assets.

In the IWMS Risk Framework, SCE categorizes simulated wildfires based on three definitions:

Significant Fires are simulated fires that, at 8 hours after ignition, burned more than 10,000 acres or had at least one fatality or had at least 50 structures impacted.

Destructive Fires are simulated fires that, at 8 hours after ignition, burned between 300 acres and 10,000 acres with zero fatalities and/or had fewer than 50 structures impacted.

Small Fires are simulated fires that, at 8 hours after ignition, burned less than 300 acres with zero fatalities and no structures impacted.

These three categories inform the risk tranches that SCE uses to determine mitigation selection, prioritization, and scope deployment. Please see the description of the IWMS methodology earlier in Section 6.2.1 for additional factors considered such as egress and burn-in buffer.

IRC4: PSPS Likelihood

PSPS likelihood: The likelihood of an electrical corporation requiring a PSPS given a probabilistic set of environmental conditions.

SCE considers PSPS Likelihood as synonymous with Probability of De-energization (POD).

The pre-mitigated POD for every asset is based on a deterministic back cast of historical wind and fuel moisture conditions at each location within SCE's HFRA. POD is used to assess PSPS risk at a for each circuit.

SCE calculates PSPS Likelihood in the MARS Framework. In the IWMS Risk Framework, locations that experience frequent de-energizations and/or potential for PSPS events even when locations are fully covered are considered for mitigation. Please see the description of both frameworks earlier in this section and in Section 6.1.1 for the basis behind this approach.

IRC5: PSPS Consequence

PSPS consequence: The total anticipated adverse effects from a PSPS for a community. This considers the PSPS exposure potential and inherent PSPS vulnerabilities of communities at risk (see definitions in the following list).

SCE estimates PSPS Consequences based on an assessment of natural unit consequences (e.g., customer minutes of interruption (CMI)) and associated safety and financial impacts for a given proactive de-energization event.

PSPS Consequence is used, in conjunction with PSPS Vulnerability, to assess the impact of potential consequences associated with a de-energization event in proximity to overhead assets.

SCE calculates PSPS Consequence in the MARS Framework. In the IWMS Risk Framework, locations that experience frequent de-energizations and/or potential for PSPS events even when locations are fully covered are considered for mitigation. Please see the description of both frameworks earlier in this section and in Section 6.1.1 for the basis behind this approach.

Fundamental Risk Components

FRC1: Equipment Ignition Likelihood

Equipment ignition likelihood: The likelihood that electrical corporation-owned equipment will cause an ignition either through normal operation (such as arcing) or through failure.

Equipment Ignition Likelihood, also referred to as Equipment/Facility Failure Probability of Ignition (EFF POI), is the probability associated with equipment causing a fault or arcing event that leads to ignition at a given location.

The pre-mitigated EFF POI for every asset is a probabilistic assessment of ignition likelihood prior to mitigation deployment.

EFF POI is the sum of the ignition component sub models (e.g., conductor POI, transformer POI, switch POI, etc.) probabilities at a given location.

Please also see the description above regarding Wildfire Likelihood and how SCE considers Wildfire Likelihood sub-components during the Review & Revise stage of the IWMS Risk Framework.

FRC2: Contact from Vegetation Ignition Likelihood

Contact from vegetation ignition likelihood: The likelihood that vegetation will contact electrical corporation-owned equipment and result in an ignition.

Contact from Vegetation Ignition Likelihood, also referred to as Contact from Foreign Object - Vegetation Probability of Ignition (CFO-Veg POI), is the probability associated with vegetation coming in contact with utility equipment and causing a fault or arcing event that leads to ignition at a given location.

The pre-mitigated CFO-Veg. POI for every asset is a probabilistic assessment of ignition likelihood prior to mitigation deployment.

Please also see the description above regarding Wildfire Likelihood and how SCE considers Wildfire Likelihood sub-components during the Review & Revise stage of the IWMS Risk Framework.

FRC3: Contact by Object Ignition Likelihood

Contact by object ignition likelihood: The likelihood that a non-vegetative object (such as a balloon or vehicle) will contact electrical corporation-owned equipment and result in an ignition.

Contact from Object Ignition Likelihood, also referred to as Contact from Foreign Object Probability of Ignition (CFO POI), is the probability associated with objects other than vegetation (e.g., vehicles, balloon, animals, other, unknown, etc.) coming in contact with utility equipment and causing a fault or arcing event that leads to an ignition at a given location.

The pre-mitigated CFO POI for every asset is a probabilistic assessment of ignition likelihood prior to mitigation deployment.

Please also see the description above regarding Wildfire Likelihood and how SCE considers Wildfire Likelihood sub-components during the Review & Revise stage of the IWMS Risk Framework.

FRC4: Burn Probability

Burn probability: The likelihood that a wildfire with a nearby but unknown ignition point will burn a specific location within the service territory based on a probabilistic set of weather profiles, vegetation, and topography.

SCE assumes a continuous Burn Probability throughout all of its HFRA. SCE uses a deterministic, rather than probabilistic, modeling approach that identifies the maximum consequences from a range of weather scenarios to represent wildfire consequences for individual locations. The underlying premise of SCE's wildfire consequence model is that fuels are receptive enough to an ignition event to result in a Significant, Destructive, or Small fire (see definitions above in Wildfire Consequence) under the modeled 444 deterministic weather scenarios.

This modeling approach removes the need to separately determine burn probability to assess the relative receptiveness of vegetation to ignition events, given that fuels are already assumed to be fully

cured and highly receptive. Fuel data is updated regularly to reflect updated burn probability based on the current vegetation state across SCE's service territory.

As an additional data point, SCE has compared its wildfire consequence simulations to burn probability analysis performed by the U.S. Forest Service (USFS). See Section 6.4.1.2 for additional information.

FRC5: Wildfire Hazard Intensity

Wildfire hazard intensity: The potential intensity of a wildfire at a specific location within the service territory given a probabilistic set of weather profiles, vegetation, and topography.

Although SCE does not utilize wildfire hazard intensity metrics such as flame length (FL) or rate of spread (RoS) in the MARS or IWMS frameworks, SCE's Technosylva wildfire consequence estimates contain corresponding wildfire hazard intensity metrics.

SCE considers wildfire hazard intensity metrics such as flame length and rate of spread during its HFTD boundary review to model locations that require further analysis. Please see Section 6.4.1.2.

FRC6: Wildfire Exposure Potential

Wildfire exposure potential: The potential physical, social, or economic impact of wildfire on people, property, critical infrastructure, livelihoods, health, environmental services, local economies, cultural/historical resources, and other high-value assets. These may include direct or indirect impacts, as well as short- and long-term impacts.

SCE does not have a separate risk component for Wildfire Exposure Potential, as SCE considers all locations within its HFRA are subject to extreme or elevated wildfire exposure potential. Please see Section 6.4.1.2.

FRC7: Wildfire Vulnerability

Wildfire vulnerability: The susceptibility of people or a community to adverse effects of a wildfire, including all characteristics that influence their capacity to anticipate, cope with, resist, and recover from the adverse effects of a wildfire (e.g., access and functional needs customers, Social Vulnerability Index, age of structures, firefighting capacities).

Wildfire vulnerability in MARS is considered through a relative ranking of circuits based on the composite scoring of Access and Functional Needs (AFN) and Nonresidential Critical Infrastructure (NRCI) customers in comparison to other circuits in its HFRA.

The resulting AFN/NRCI Index is used in conjunction with SCE'S MAVF to amplify the safety component of the wildfire consequence score for a given location.

Wildfire vulnerability in IWMS is incorporated based on the consideration of locational risk factors including known Communities of Elevated Fire Concern (CEFCs), locations with high fire frequency and population egress, as well as locations which could trapped populations in identified egress locations (i.e., "Burn in Buffer"). Please see the explanation of the IWMS Risk Framework in earlier in this section.

FRC8: PSPS Exposure Potential

PSPS exposure potential: The potential physical, social, or economic impact of a PSPS event on people, property, critical infrastructure, livelihoods, health, local economies, and other high-value assets.

SCE does not have a separate risk component for PSPS Exposure Potential, as SCE considers all locations within its HFRA (and interconnected circuit segments that may be outside HFRA) as subject to PSPS exposure potential.

FRC9: PSPS Vulnerability

Vulnerability of community to PSPS (PSPS vulnerability): The susceptibility of people or a community to adverse effects of a PSPS event, including all characteristics that influence their capacity to anticipate, cope with, resist, and recover from the adverse effects of a PSPS event (e.g., high AFN population, poor energy resiliency, low socioeconomics).

Please see the discussion above regarding how Wildfire vulnerability is determined under the MARS Framework; SCE uses the same approach for PSPS vulnerability.

SCE calculates PSPS Vulnerability in the MARS Framework. In the IWMS Risk Framework, locations that experience frequent de-energizations and/or potential for PSPS events even when locations are fully covered are considered for mitigation. Please see the description of both frameworks earlier in this section and in Section 6.1.1 for the basis behind this approach.

6.2.2 Risk and Risk Components Calculation

The electrical corporation must calculate each risk and risk component defined in Section 6.2.1. Appendix B, "Calculation of Risk and Risk Components," provides additional requirements on these calculations. These are the minimum requirements and are intended to establish the baseline evaluation and reporting of all electrical corporations. If the electrical corporation identifies other key factors as important, it must report them in the WMP in a similar format.

The electrical corporation must provide schematics illustrating the calculation of each risk and risk component as necessary to demonstrate the logical flow from input data to outputs, including separate items for any intermediate calculations.

Figure 6-2 provides an example of a calculation schematic for the equipment likelihood of ignition.

Figure 6-2 - Example of a Calculation Schematic

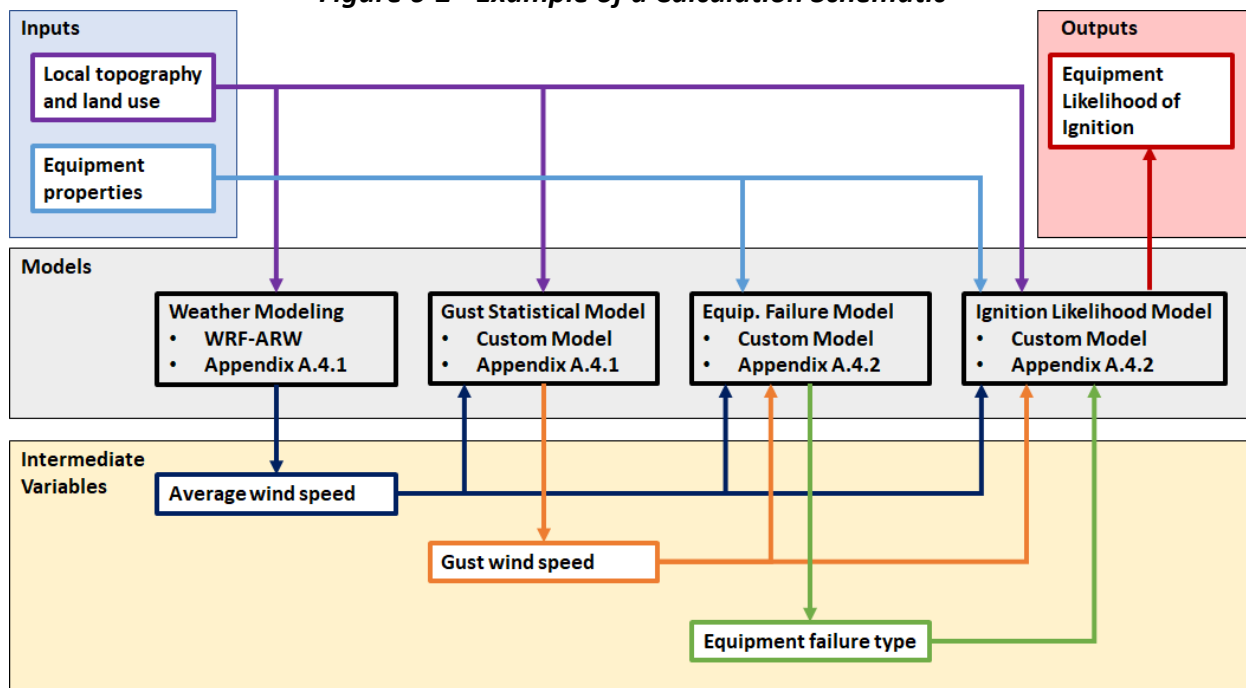

The electrical corporation must summarize any differences between its calculation of these risk components and the requirements of these Guidelines. These differences may include any of the following:

- **Additional input parameters** beyond the minimum requirements for a specific risk component
- **Calculations of additional outputs** beyond the minimum requirements for a specific risk component
- **Calculations of additional risk components** defined by the electrical corporation in Section 6.2.1

The process used to combine risk components must be summarized for each relevant risk component. This process must align with applicable CPUC decisions regarding the inclusion of Risk Assessment and Mitigation Phase (RAMP) filings. If scaling factors (such as multi-attribute value functions [MAVFs] or representative cost) are used in this combination, the electrical corporation must present a table with all relevant information needed to understand this procedure. The electrical corporation must organize this discussion into the following two subsections focusing on likelihood and consequence.

Diagrams for Risk Components

SCE has developed calculation schematics and input/output diagrams for each risk component, except for the five components that SCE does not calculate directly or are addressed through other risk components (i.e., Wildfire Likelihood, Burn Probability, Wildfire Hazard Intensity, Wildfire Exposure Potential, and PSPS Exposure Potential).

The diagrams are provided in Appendix B: Supporting Documentation for Risk Methodology and Assessment, as well as the additional information for each risk component required by Appendix B: Supporting Documentation for Risk Methodology and Assessment. The diagrams are provided in Appendix B: Supporting Documentation for Risk Methodology and Assessment, as well as the additional information for each risk component required by Appendix B: Supporting Documentation for Risk Methodology and Assessment.

6.2.2.1 Likelihood

The electrical corporation must discuss how it calculates the likelihood that its equipment (through normal operations or failure) will result in a catastrophic wildfire and the resulting likelihood of issuing a PSPS. The risk components discussed in this section must include at least the following:

- *Ignition likelihood*
 - *Equipment failure likelihood of ignition*
 - *Contact from vegetation likelihood of ignition*
 - *Contact from object likelihood of ignition*
- *Burn probability*
- *PSPS likelihood*

IRC1: Ignition Likelihood

As noted in the previous section, SCE considers Ignition Likelihood to be synonymous with Probability of Ignition (POI). The pre-mitigated POI for every asset is a probabilistic assessment of ignition likelihood prior to mitigation deployment.

Figure SCE - 6-18 Probability of Ignition

$$*Probability of Ignition = POI_{EFF} + POI_{CFOVe}g + POI_{CFO} - Other*$$

The conditional POI associated with EFF and CFO probabilities are based on the sum of individual component probabilities of individual subcomponent models (e.g., EFF-conductor, CFO-vegetation, etc.). These subcomponent models utilize machine learning (ML) algorithms to assess the relevance of ignition drivers relevant to that subcomponent type. For instance, each EFF related subcomponent model uses historical asset outage data, current asset condition (e.g., age, voltage, inspection results, etc.), and relevant environmental attributes (e.g., historical wind, asset loading, number of customers, temperature, relative humidity etc.).

Figure SCE 6-19 - Schematic for Individual SCE Probability of Ignition Subcomponent Models

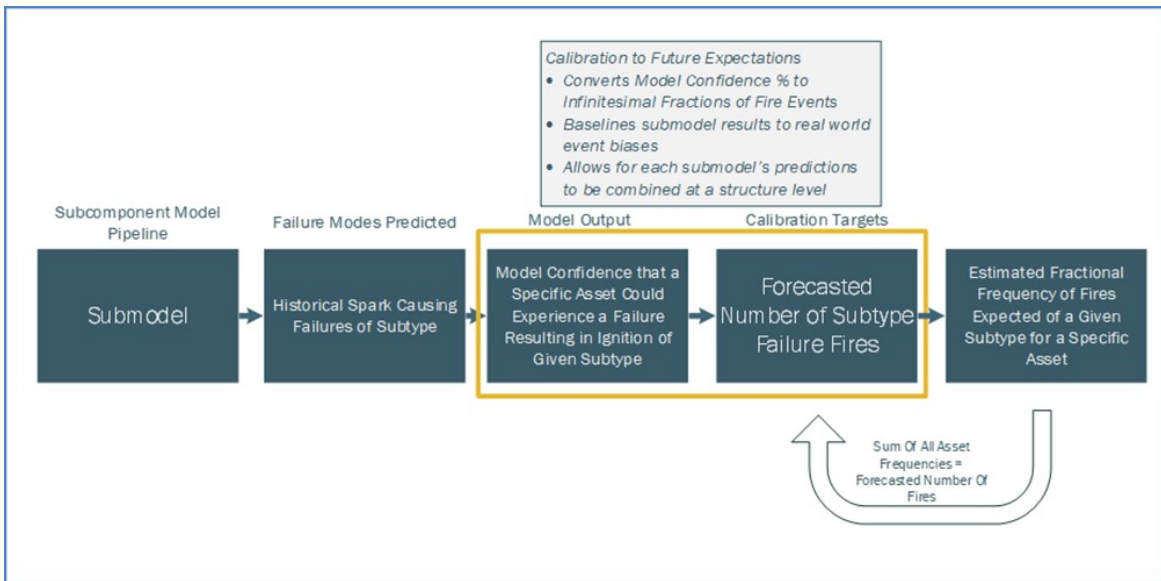

SCE performs data synthesis and quality checks on each of these individual subcomponent models. These models are tested and updated using new observed failures and new inspection, remediation, or replacement information.

Figure SCE 6-20 - Schematic for SCE Probability of Ignition Model

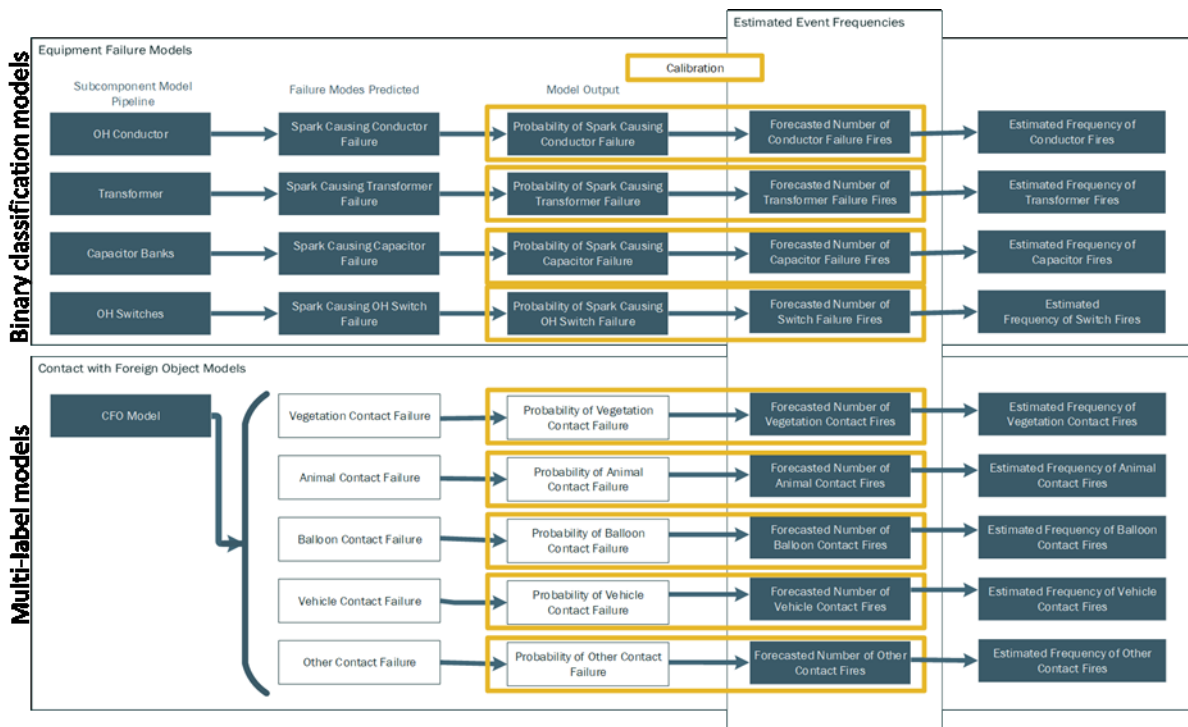

These statistical models are created with the assumption that a given set of explanatory data is what contributes to a failure or non-failure outcome. With this, machine learning models use historical environmental, physical, and electrical variables paired with their actual records of failures to derive statistical insights. The historical data used to derive subcomponent POIs are divided into a training set, a testing set randomly stratified from the same time period as the training set, and a validation set of data held out from a year the model has never seen.

The training set is used to train the model by finding patterns in how independent variables led to dependent variables or outcomes and is the only data that affects the decision thresholds within a model. The test set is not used to train the model, but to measure model accuracy by comparing model predictions to actual outcomes.

The validation set is also not used to train the model. These data are used to measure the accuracy of the model by determining if the model degrades over time. See

Figure SCE 6-21 and Figure SCE 6-22, below.

Figure SCE 6-21 - Schematic of POI Subcomponent Model Calculation

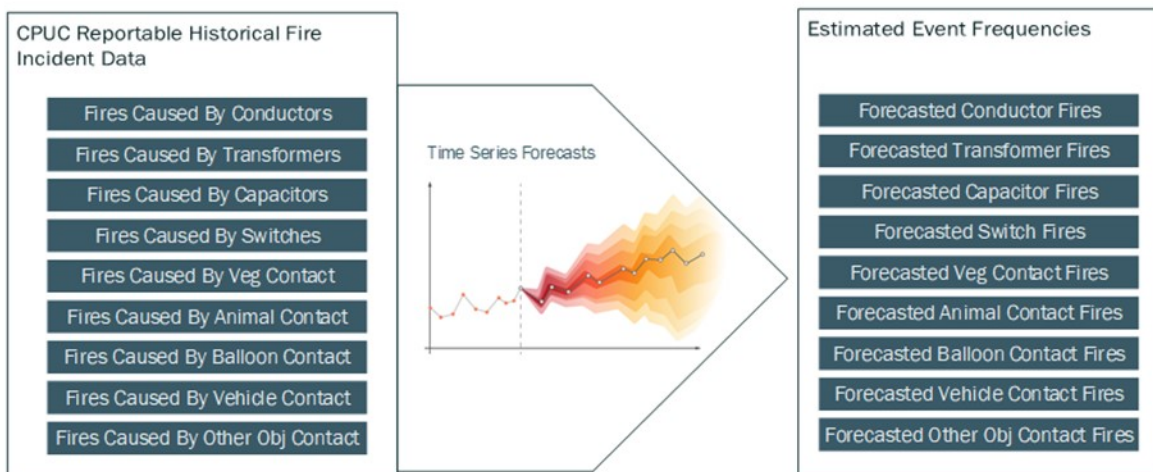
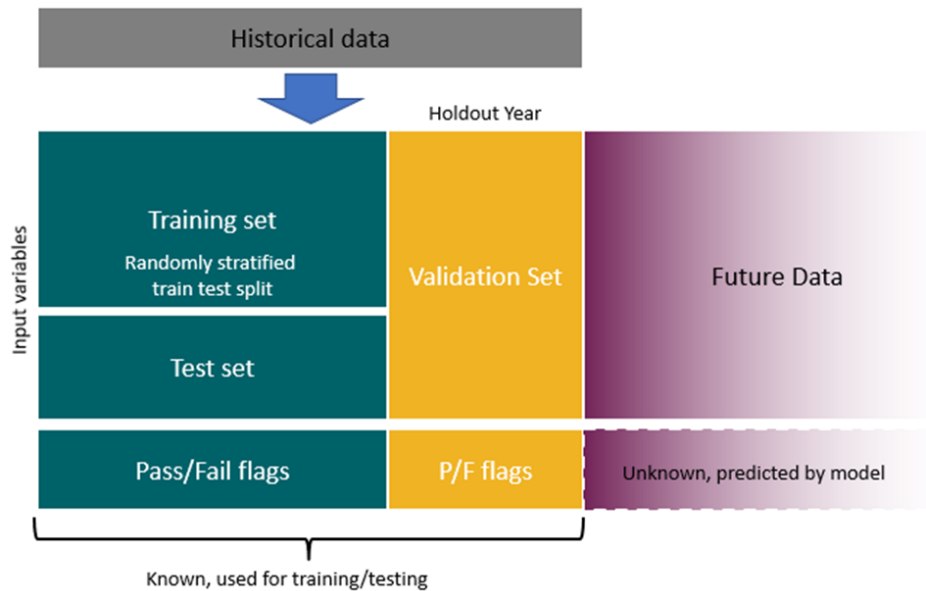

Figure SCE 6-22 - Schematic of POI Subcomponent Testing, Training, and Validation



Subcomponent and overall model performance is measured by the statistical significance of model and subcomponent model predictions between the training set and testing set, as well as the training data set and the validation data set. Known historical failures are withheld from model training and the model is “tested” to see if it can predict them. How often the model accurately predicts an ignition event is quantifiable and provides confidence in its future predictions. SCE utilizes two widely accepted methods of quantifying model performance - the Confusion Matrix and the Receiver Operating Characteristic (ROC).

The Confusion Matrix (see Figure SCE 6-23, below) is a metric structure that organizes the predictions of a predictive model into buckets based on whether the predictions are correct. They are used to compare correct and incorrect predictions of the algorithm based on a set of known outcome data (e.g., test set) to determine how often the model predicted failures and non-failures correctly (true positive and true negative rates, respectively), as well as the occurrences when the model predicted incorrectly (false positive and false negative, respectively).

Assuming the convention that a positive prediction is an ignition prediction, and conversely a negative prediction is a non-ignition prediction, a true positive prediction is when the model predicts that an ignition is likely to occur which agrees with what happened. A true negative result occurs when the model correctly predicts that no ignition event occurred in the test set period. A false positive result occurs when the model predicts that an ignition may occur but in the test set, it did not. A false negative result occurs when the model predicts an ignition is unlikely, but the test data shows it did.

The diagonal elements denote how often the model was correct, and the off-diagonal elements measure how often the model is incorrect. The true positive rate is also known as the model “sensitivity” or “recall,” the false positive rate is also known as “type 1 error,” and the false negative is also known as “type 2 error.” The machine learning models calculate probabilities, which are a continuum of values from 0-100%. These confusion matrices are made by picking a decision threshold (often 50%) where, if the probability is greater than this threshold, the event is said to be likely to occur

and vice versa. It is important to note this matrix results in a relative and comparative ranking of model performance.

Figure SCE 6-23 - Schematic of POI Validation Confusion Matrix

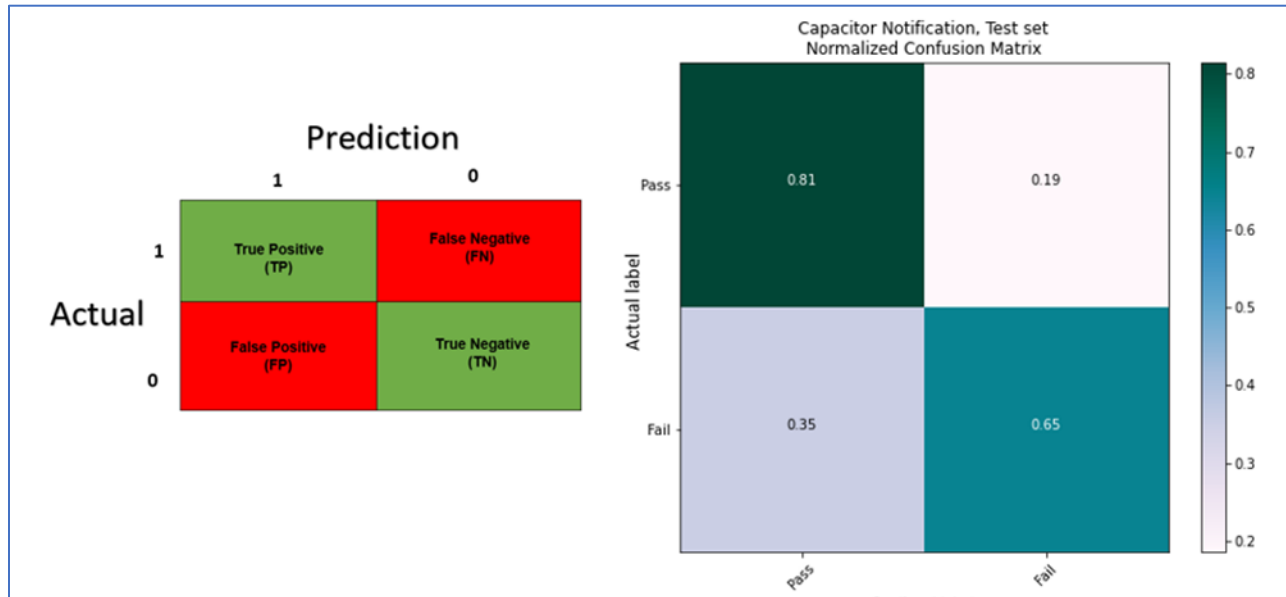

In addition to the Confusion Matrix, SCE uses the ROC curve to measure accuracy of each subcomponent model, as the overall model behaves based on different probability thresholds, as represented by the solid blue line in Figure SCE 6-24. As mentioned, the confusion matrix is sensitive to the decision threshold and there is often a tradeoff in discriminating true failures at the expense of increasing the false failure rate. A way to summarize the ROC curve into a single metric is by taking the integral of the true positive rate with respect to the false positive rate or calculating the Area Under the Curve (AUC). If the model were to perfectly classify the train, test, and validation data, the AUC would result in a score of 1.0 (100%) “true positive” result. If the model were to randomly select “true positive” results 50% of the time, the AUC would result in a score of 0.5 (50%), which is no better than a random guess or colloquially a “coin toss”, as represented by the dotted red line in Figure SCE 6-24.

Figure SCE 6-24 - Schematic of POI ROC Curve

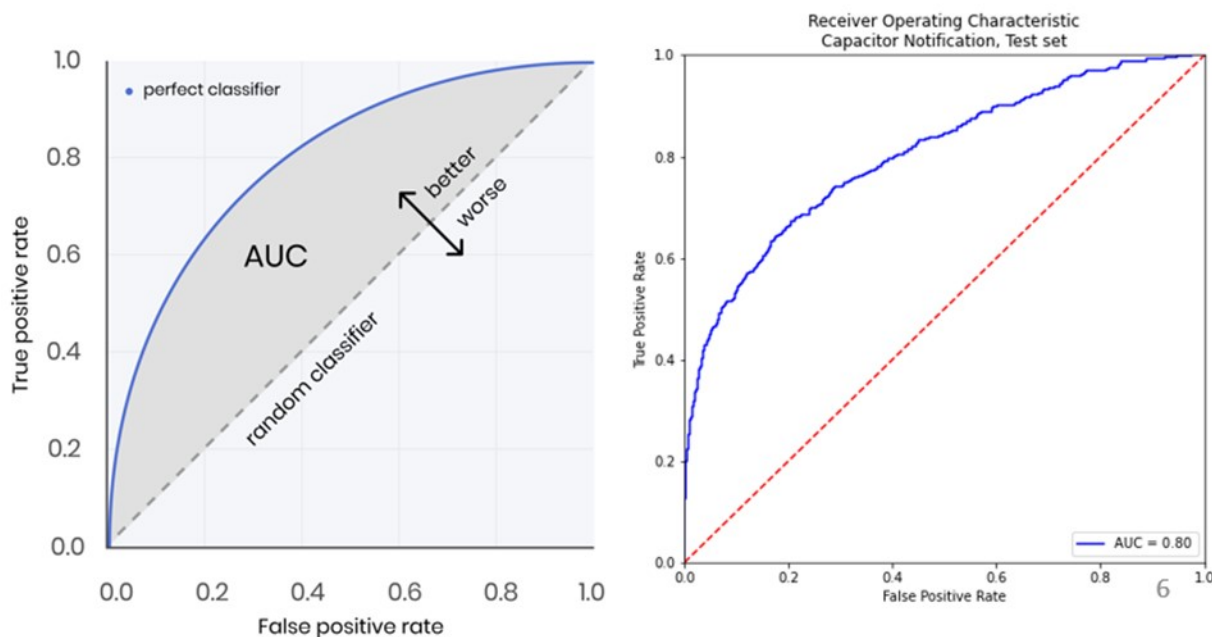

IRC2: Wildfire Likelihood

SCE does not differentiate between Ignition Likelihood and Wildfire Likelihood. As described above in the discussion of Ignition Likelihood and earlier in Section 6.1.1, SCE models potential fire behavior and spread from individual utility asset locations.

FRC1: Equipment Failure Likelihood of Ignition

EFF POI (synonymous with Equipment Failure Likelihood of Ignition) is the sum of the EFF ignition component sub models (e.g., conductor POI, switch POI, transformer POI, etc.) probabilities at a given location.

EFF POI utilizes similar algorithms and model performance metrics as described above regarding Ignition Likelihood.

FRC2: Contact from Vegetation Likelihood of Ignition

CFO – Veg. POI utilizes similar algorithms and model performance metrics as described above regarding Ignition Likelihood.

FRC3: Contact from Object Likelihood of Ignition

Contact from Object Ignition POI (e.g., vehicles, balloon, animals, other, unknown, etc.) utilizes similar algorithms and model performance metrics as described above regarding Ignition Likelihood.

FRC4: Burn Probability

Please see Section 6.2.1 for how SCE considers this risk component.

IRC4: PSPS Likelihood

To estimate PSPS Likelihood (also referred to by SCE as POD), SCE derived a 10-year historical climatology of PSPS weather conditions along distribution circuits. This historical climatology was used to determine the extent by which recent years experienced de-energization conditions at above- or below-average frequency, and to what degree mitigations reduce de-energization frequency.

SCE used a gridded historical dataset available at a two-kilometer by two-kilometer spatial resolution over the entire SCE territory to derive this historical climatology. The gridded dataset provided consistent data coverage and a sufficient period of length to derive the average number of hours each circuit would have exceeded PSPS de-energization criteria in the modeled data using specific thresholds. This information was used to derive the historical exceedance of circuit de-energization conditions based on unhardened de-energization thresholds.

SCE then adjusted these de-energization thresholds to simulate a fully hardened forecast exceedance post mitigation deployment. The resulting estimate provided a pre-and post-POD based on the number of hours each circuit might exceed PSPS conditions once hardened, assuming average future conditions are similar to historical climatological conditions.

SCE notes the historical climatology is driven by observed historical atmospheric conditions. Terrain and meteorological resolution are constrained to the same computational limitations. The ability to represent complex terrain is limited, as is representation of small-scale weather features that play important factors in determining local wind speeds. Additionally, climate change literature does not definitely point to a likely increase or decrease in potential future high wind conditions.

6.2.2.2 Consequence

The electrical corporation must discuss how it calculates the consequences of a fire originating from its equipment and the consequence of implementing a PSPS event. The risk components discussed in this section must include at least the following:

- *Wildfire consequence*
- *Wildfire hazard intensity*
- *Wildfire exposure potential*
- *Wildfire vulnerability*
- *PSPS consequence*
- *PSPS exposure potential*
- *PSPS vulnerability*

IRC3: Wildfire Consequence

SCE utilizes Technosylva-based wildfire modeling tools to assess wildfire consequences based on deterministic match-drop simulations at utility asset location (see Figure SCE 6-25) for a consistent unsuppressed 8 hour burn period. The use of deterministic match drop simulations allows SCE to isolate ignitions associated with wildfire simulations along utility assets and assign the resulting natural unit consequences back to those assets.

The use of a consistent unsuppressed 8 hour burn period allows for direct comparison of the resulting consequences. An eight hour burn period is used to represent the first burn period of which there is certainty in the fuel, wind, and weather conditions at the time of the initial ignition. As evident by CPUC analysis⁸⁹ of utility 2019 PSPS events, there is inherent uncertainty in the fuel, wind, weather, as well as suppression, evacuation, and other community response variables beyond the initial burn period.

Figure SCE 6-25 - Example of Ignition Points (Black Dots) in Proximity to Utility Assets (Gray Lines)

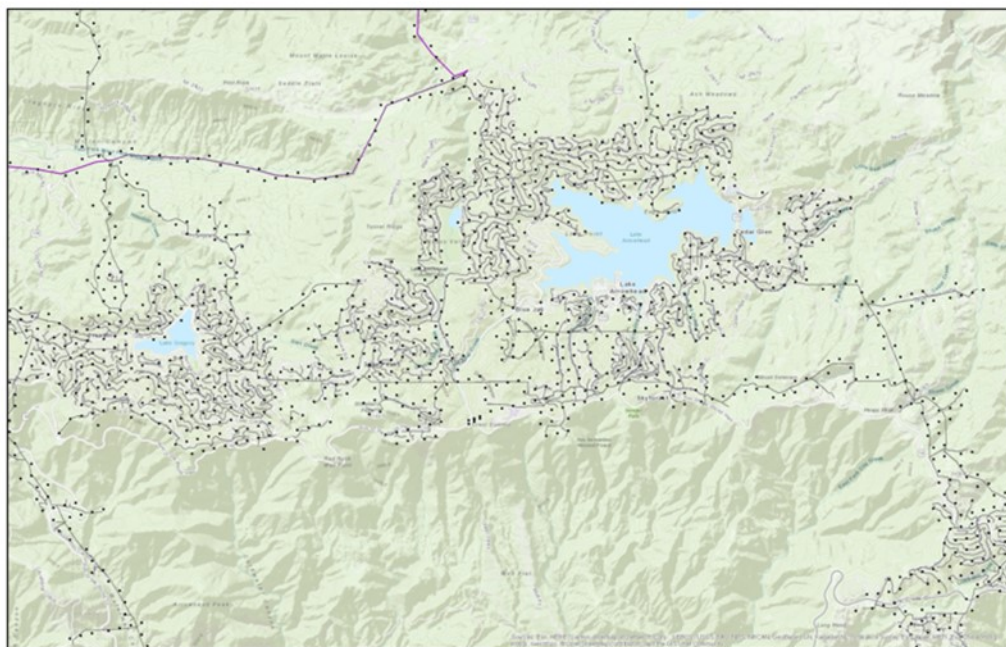

SCE uses the maximum model consequence across the 444 modeled weather scenarios simulated along each of the 29 million match drop simulation ignition points. These 444 modeled weather scenarios reflect the 41 weather scenarios used by the CPUC in the development of the utility HFTD map, as well as 403 additional weather scenarios reflective of dry fuel conditions with or without the presence of significant wind (i.e., fuel-driven fires). For longer-term planning purposes, SCE utilizes a 2030 fuel layer reflecting likely fuel regrowth patterns in fire scars greater than 5,000 acres.

⁸⁹ <https://www.cpuc.ca.gov/consumer-support/pmps/technosylva-2019-pmps-event-wildfire-risk-analysis-reports>

SCE assigns the resulting maximum natural unit consequences (e.g., acres, building, and population) across the 444 simulated weather scenarios to the asset in proximity to those match drop simulation using zonal statistics. The resulting natural unit acres and building consequences are translated into financial values (e.g., suppression and restoration costs per acre, and building replacement value). Natural unit population consequences (e.g., fatalities and serious injuries) are translated into a safety index (e.g., one serious injury equals one quarter of a fatality). SCE also assumes eight hours of customer interruption along the circuit in which the ignition propagated. The resulting reliability values – the product of eight hours of interruption and the number of customers on a given circuit – are used as a conservative estimate of the potential reliability impacts of a resulting wildfire. See Figure SCE 6-26.

Figure SCE 6-26 - Schematic of SCE Wildfire Consequence Modeling (8 hours, unsuppressed)

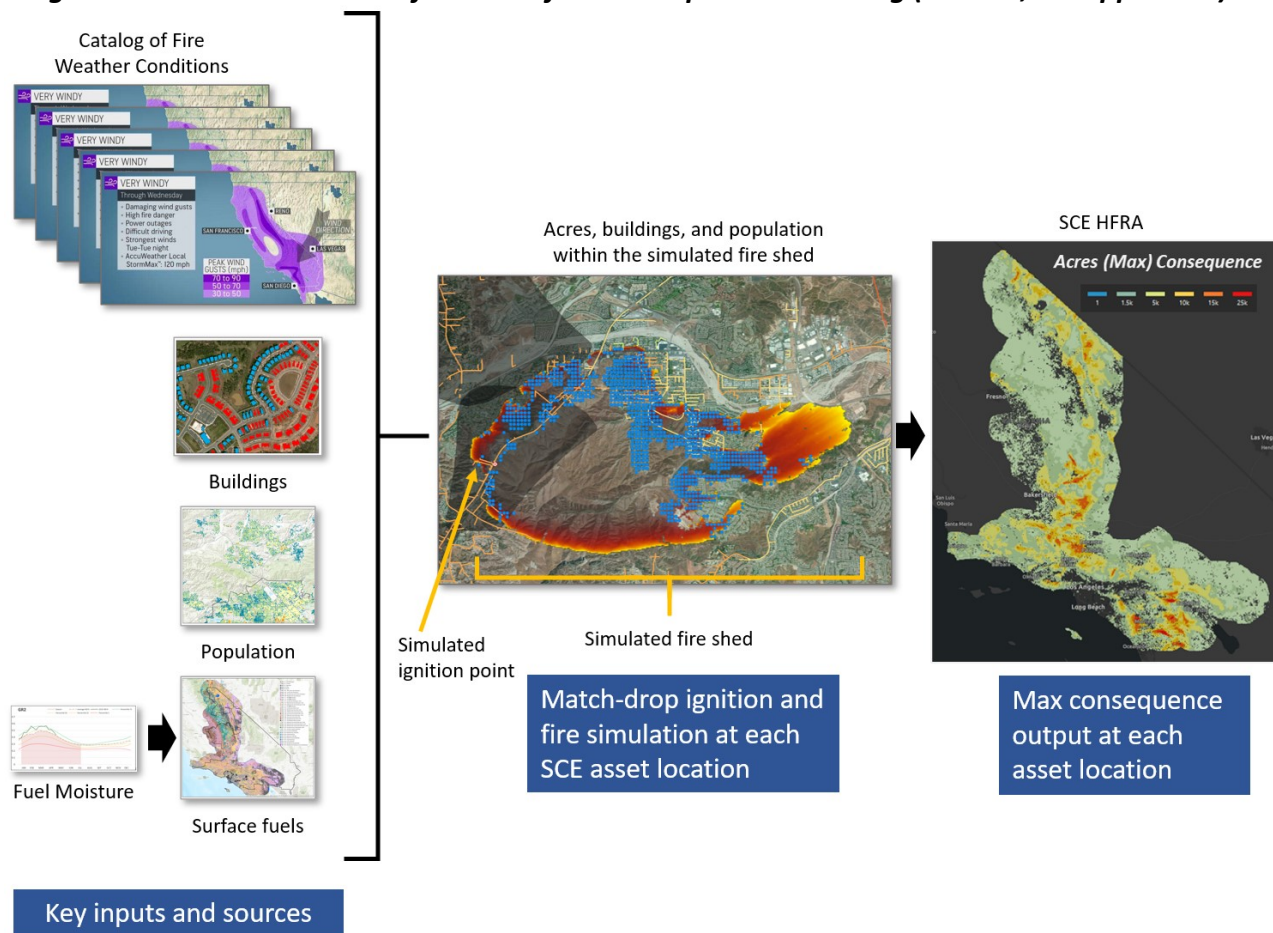

Below SCE provides additional information about how consequences are translated into a MARS score.

Safety Consequences: SCE defines serious injuries and fatalities as those associated with both members of the public and firefighters injured during a wildfire event based on known reported information. To estimate Safety Consequence associated with individual wildfire simulations, SCE uses a ratio of 256 structures impacted to one fatality, and a ratio of 107 structures impacted to one serious injury. These ratios are based on recent historical wildfires in SCE’s service territory. These safety consequences are then combined into a Safety Index in which one serious injury is equal in value to one quarter fatality.

$$Safety\ Index = (1 \times Fatalities + \frac{1}{4} \times Serious\ Injuries) \times Wildfire\ Vulnerability$$

Reliability Consequences: SCE assumes an eight-hour service interruption for each customer account on the circuit from which that ignition occurred. SCE understands these numbers may be a conservative

estimate given that fire sheds may impact multiple circuits during an actual wildfire event. These impacts are represented by the number of customer minutes of service interruptions (CMI).

$$Reliability = Customers \times (8\ hours \times 60\ minutes)$$

Financial Consequences: SCE uses average cost information representing costs associated with damage to physical structures, as well as firefighting suppression costs and land restoration costs for each individual wildfire simulation. To model socio-economic equity across SCE’s service territory, SCE uses a system-wide average estimated cost of \$940,337 per structure impacted.⁹⁰ SCE understands these numbers may be a conservative estimate given that insured losses may exceed actual structure values for each wildfire event. SCE also uses a per-acre fire-fighting suppression cost figure of \$876; and a per acres land restoration cost of \$1,460.⁹¹

$$Financial = (\#\ of\ Structures) \times (\$940,337) + (\#\ of\ Acres) \times (\$876) + (\#\ of\ Acres) \times (\$1,460)$$

Overall MARS Risk Score

In Table SCE 6-05, SCE summarizes the associated attributes, units, weights, ranges and scaling functions to convert natural units of consequences (e.g., CMI, dollars, safety) into a unit-less risk score. These components were based on the principles set forth in the S-MAP Settlement and presented in SCE’s 2022 RAMP filing.

Table SCE 6-05 - MARS Conversion Table

Attribute	Units	Weight	Range	Scaling Factor
Safety	Index	50%	0 - 100	Linear
Reliability	Customer Minutes of Interruption (CMI)	25%	0 - 2 Billion	Linear
Financial	Dollars	25%	0 - 5 Billion	Linear

⁹⁰ Estimated average structure value is based on the RMS industry exposure database (IED) for SCE’s service area.

⁹¹ Suppression costs are based on a five-year average of California’s reported wildfire suppression costs from 2016-2020.

Figure SCE 6-27 provides a step-by-step illustrative example using the weights, ranges and scaling functions to transform consequences (in this example Financial) into a unitless risk score. The same methodology would be used for the safety and reliability consequences.

Figure SCE 6-27 - MARS Conversion Steps

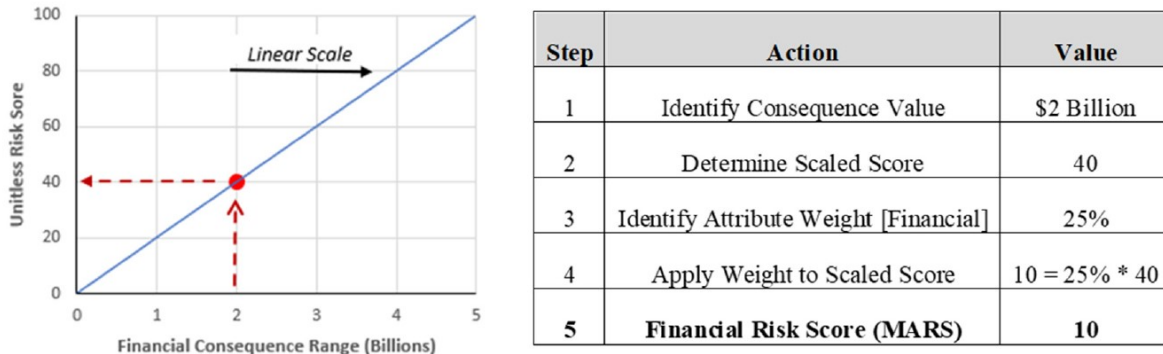

SCE’s Use of a Deterministic Approach & Evaluating Wildfire Consequence Results

Given that future weather conditions are not known, match drop simulations (i.e., deterministic) using maximum observed fire weather conditions more appropriately reflect the relative wildfire risk associated with ignitions in proximity to utility assets than probabilistic methods that are based on a range of weather conditions.

Probabilistic methods rely on past historical information to project forward wildfire trends based on an analysis of several partially isolatable variables leading to wildfire ignition (e.g., the susceptibility of fuels to wildfire ignition) and post-ignition decision making (e.g., wildfire suppression decision making and resourcing). These probabilistic methods typically do not properly reflect upward or downward trends in climate change or changes in the amount of availability suppression resources.

While empirical estimations regarding the impact of the dynamic risks of climate change and/or suppression can be added to probabilistic models, it is difficult to discern the relative contribution of each of these variables on the overall model as their impacts would likely vary by location. It is also not clear to what extent probabilistic models would produce a superior result over deterministic models (see Leuenberger et. al 2018).⁹²

In the IWMS Risk Framework, SCE categorizes simulated wildfires based on three definitions:

Significant Fires are simulated fires that, at 8 hours after ignition, burned more than 10,000 acres or had at least one fatality or had at least 50 structures impacted.

Destructive Fires are simulated fires that, at 8 hours after ignition, burned between 300 acres and 10,000 acres with zero fatalities and/or had fewer than 50 structures impacted.

⁹² “Wildfire susceptibility mapping: Deterministic vs. stochastic approaches”, *Environmental Modelling & Software*, Volume 101, March 2018, Pages 194-203.

<https://www.sciencedirect.com/science/article/abs/pii/S1364815217303316?via%3Dihub>

Small Fires are simulated fires that, at 8 hours after ignition, burned less than 300 acres with zero fatalities and no structures impacted.

Please see the description of the IWMS methodology in Section 6.2.1 for additional discussion of how these results are used to inform the three risk tranches within IWMS.

FRC5: Wildfire Hazard Intensity

Please see Section 6.2.1 for how SCE considers this risk component.

FRC6: Wildfire Exposure Potential

Please see Section 6.2.1 for how SCE considers this risk component.

FRC7: Wildfire Vulnerability

SCE has developed a multiplier to represent the vulnerability of customers to a wildfire or PSPS event. The purpose of this multiplier is to amplify the safety index based on the relative ranking of those circuits compared to other circuits in HFRA based on the total AFN and NRCI customers on those circuits.

AFN customers include those customers which are subject one or more of the following criteria: Critical Care, disabled, Medical Baseline, Low Income, limited English, pregnant, children. NRCI customers include those customers in the Healthcare and Public Health, Water and Wastewater Systems, Emergency Services, Communication, Transportation, Government Facilities, or Energy sectors.

An AFN multiplier value of "2" represents the highest AFN score compared to other circuits in the HFRA; an AFN multiplier value of "1" represents a circuit with an AFN score of zero. Similarly, a circuit with an NRCI multiplier value of "2" represents the highest NRCI score compared to all of the other circuits in HFRA; an NRCI score of "1" represents a circuit with a NRCI score of zero.

In the case of Wildfire Vulnerability, this multiplier represents the relative level of support that an individual or entity would need in the case of a wildfire event.

$$AFN_{CircuitMultiplier} = 1 + \frac{AFN\ Score_{Circuit}}{AFN\ Score\ Max}$$

$$NRCI_{CircuitMultiplier} = 1 + \frac{NRCI\ Score_{Circuit}}{NRCI\ Score\ Max}$$

$$Wildfire\ Vulnerability\ Circuit = AFN\ CircuitMultiplier \times NRCI\ CircuitMultiplier$$

Wildfire vulnerability in IWMS is incorporated based on the consideration of locational risk factors including known Communities of Elevated Fire Concern (CEFCs), locations with high fire frequency and population egress, as well as locations in which an ignition could cause a wildfire which could spread to and trap populations in identified egress locations (i.e., “Burn in Buffer”). Please see the description of the IWMS Risk Framework in section 6.2.1.

IRC5: PSPS Consequence

SCE estimates PSPS Consequences associated with a proactive de-energization event by using the number of customers impacted along with the potential frequency and duration of those events to estimate potential safety, reliability, and financial impacts.

Safety Consequences: SCE multiplies the total customers in scope by three to estimate the total population impacted. The resulting total population impacted is then multiplied by a safety conversion factor, based epidemiological data from the 2003 Northeast Blackout event as a data point⁹³, to estimate the number of fatalities. These safety consequences are combined into a Safety Index in which one serious injury is equal in value to one quarter fatality. SCE adjusts the Safety Index by the applicable PSPS Vulnerability multiplier for the circuit in scope.

$$\text{Safety Index} = (\text{Population} \times \text{Safety Conversion Factor}) \times \text{PSPS Vulnerability}$$

Reliability Consequences: SCE assumes an 8-hour service interruption for each customer account on the circuit in scope for that event. SCE understands these numbers may be a conservative estimate given that SCE attempts to minimize the number of customers in scope for a given PSPS event. These impacts represent the number of customer minutes of service interruptions (CMI).

$$\text{Reliability} = \text{Customers} \times (8 \text{ hours} \times 60 \text{ minutes})$$

Financial Consequences: SCE uses the number of customers to estimate the potential financial impact. SCE uses \$250 per customer service account, per de-energization event, to approximate potential financial losses, recognizing that some customers may experience no financial impact, while other customer losses may exceed \$250⁹⁴.

$$\text{Financial} = \text{Customers} \times \$250 \text{ per event}$$

⁹³ That blackout lasted for 48 hours, impacted 50 million people, and was recorded to have 100 fatalities, which converts to 4.2 x 10-8 fatalities / people-hrs. Other data points include the 2011 Southwest blackout and the 2019 PPS events in SCE service area, though no fatalities were attributed to those events.

⁹⁴ This is not an acknowledgment that any given customer has or will incur losses in this amount, and SCE reserves the right to argue otherwise in litigation and other claim resolution contexts, as well as in CPUC regulatory proceedings. This estimate is based on a number of factors including SCE internal Value of Service (VoS) studies, claims information, as well as benchmarking with other utilities.

Overall MARS Risk Score

SCE uses the same weights, ranges, scaling functions as described above in the explanation of Wildfire Consequence.

FRC8: PSPS Exposure Potential

Please see section 6.2.1 for how SCE considers this risk component.

FRC9: PSPS Vulnerability

Please see the discussion above regarding how Wildfire vulnerability is determined under the MARS Framework; SCE uses the same approach for PSPS vulnerability.

$$PSPS\ Vulnerability\ Circuit = AFN\ CircuitMultiplier \times NRCI\ CircuitMultiplier$$

6.2.2.3 Risk

The electrical corporation must discuss how it calculates each risk and the resulting overall utility risk defined in section 6.2.1. The discussion in this section must include at least the following:

- Ignition risk
- PSPS risk
- Overall utility risk

R2: Ignition Risk

Ignition Risk (synonymous with Wildfire Risk) is calculated as the product of the sum of all Ignition Likelihood components and Wildfire Consequence for each asset in SCE's HTFD. The safety score for each segment is the product of the safety subcomponent of Wildfire Consequence and Wildfire Vulnerability.

$$Ignition\ Risk = Ignition\ Likelihood \times Wildfire\ Consequence$$

R3: PSPS Risk

PSPS risk is calculated as the product of PSPS Likelihood (synonymous with Probability of De-energization (POD)) and PSPS Consequence for each asset in SCE's HTFD.

$$PSPS\ Risk = PSPS\ Likelihood \times PSPS\ Consequence$$

R1: Overall Utility Risk

Overall Utility Risk is calculated as the sum of Ignition Risk and PSPS Risk for each asset in SCE's HTFD.

$$\text{Overall Utility Risk} = \text{Ignition Risk} + \text{PSPS Risk}$$

6.2.3 Key Assumptions and Limitations

Because the individual elements of risk assessment are interdependent, the interfaces between the various risk models and mitigation initiatives must be internally consistent. In this section of the WMP, the electrical corporation must discuss key assumptions, limitations, and data standards for the individual elements of its risk assessment. This must include the following:

- **Key modeling assumptions** made specific to each model to represent the physical world and to simplify calculations
- **Data standards**, which must be consistently defined (e.g., weather model predictions at a 30-ft [10-m] height must be converted to the correct height for fire behavior predictions, such as mid-flame wind speeds)
- **Consistency of assumptions and limitations** in each interconnected model, which must be traced from start to finish, with any discrepancies between models discussed
- **Stability of assumptions in the program**, including historical and projected changes

More mature programs regularly monitor and evaluate the scope and validity of modeling assumptions. Monitoring and evaluation categories may include:

- **Adaptation of weather history** to current and forecasted climate conditions
- **Availability of suppression resources** including type, number of resources, and ease of access to incident location
- **Height of wind driving fire spread / wind adjustment factor calculation**
- **General equipment failure rates / wind speed functional dependence for unknown components**
- **General vegetation contact rates / wind speed functional dependence for unknown species**
- **Height of electrical equipment in the service territory**
- **Stability of the atmosphere** and resulting calculation of near-surface winds
- **Vegetative fuels** and fuel models including adaptations based on fuel management activities by other Public Safety Partners
- **Combination of risk components / weighting of attributes** in alignment with most recent decision issued by the CPUC for inclusion in RAMP filings
- **Wind load capacity for electrical equipment in the service territory**

- *Number, extent, and type of community assets at risk in the service territory*
- *Proxies for estimating impact on customers and communities in the service territory*
- *Extent, distribution, and characteristics of vulnerable populations in the service territory*

The electrical corporation must document each assumption in Table 6-2. The electrical corporation must summarize detailed assumptions made within models in accordance with the model documentation requirements in Appendix B.

Key Modeling Assumptions

Please see Table 6-2, where SCE provides its key modeling assumptions and approach for the attributes listed above. SCE uses its own historical data, research, and studies relevant to wildfire risk assessment as well as those required in other applicable regulatory forums. SCE looks forward to additional discussion regarding the applicability of these modeling components in forthcoming OEIS risk modeling working groups. Please see Appendix B: Supporting Documentation for Risk Methodology and Assessment for additional information on key modeling assumptions.

Data Standards

The data standards that SCE adopts in its risk modeling is based on the granularity of available data (e.g., segment or functional location level). Where appropriate, SCE has provided the data standard it uses for the key modeling assumption for the attributes listed. Please see Appendix B: Supporting Documentation for Risk Methodology and Assessment for additional information on data standards.

Consistency of Assumptions and Limitations

SCE has provided its assumptions and the limitations it sees in those assumptions in Table 6-2. SCE's key modeling assumptions are used consistently across its risk models. Additional technical information can be found in Appendix B: Supporting Documentation for Risk Methodology and Assessment.

Stability of Assumptions in the program

As provided in Table 6-2, SCE understands there are limitations of these assumptions and consistently updates these assumptions (e.g., fuels, weather scenarios, drivers, etc.) for its risk modeling as necessary and/or as data is available.

Table 6-2 - Risk Modeling Assumptions and Limitations

	Assumption	Justification	Limitation	Applicable Models
Adaptation of Weather History	SCE leverages 2009-2020 weather data generated from its weather research and forecasting (WRF) to identify weather variables associated with fire incidents (see Section 8.3.5).	SCE uses machine learning algorithms to associate applicable weather variables from the WRF model at the time of fault/ignition events.	SCE’s WRF has a limited spatial granularity of 2KM x 2KM. These historical weather data may not be reflective of future weather conditions.	POI
	SCE uses 444 weather days from SCE’s historical climatology as described above.	These weather days represent fire weather conditions in each of SCE’s Fire Climate Zones (FCZs).	In order to increase accuracy and meet the underlying 30m cell size resolution of the fuels data, 2 KM x 2 KM weather data is interpolated spatially using a bilinear interpolation scheme. These historical data may not be reflective of future fire weather conditions.	Wildfire Consequence

	Assumption	Justification	Limitation	Applicable Models
Availability of Suppression Resources	SCE does not account for historical or future fire suppression.	The use of a consistent unsuppressed 8-hour burn period across all fire simulations allows for comparable benchmarking of the resulting consequences across assets	There is inherent uncertainty in agent-based activities, such as fire suppression. The overlapping jurisdiction, availability, and coordination of resourcing decisions as well as the timeliness of those decision-making processes based on the ignition detection time make it challenging to model. SCE also notes that in many cases, fire agencies must respond to multiple concurrent fire events, adding additional complexity to wildfire suppression decision-making. Calibration of historical fires alone does not reflect these decision-making processes. In lieu of artificially	Wildfire Consequence

	Assumption	Justification	Limitation	Applicable Models
			adjusting consequences based on fire suppression, SCE has chosen to not to bias these simulations.	
Height of Wind Driving Fire Spread	Fire simulations require wind speed at midflame to compute surface fire spread and at 20ft to compute crown fire characteristics. To convert the initial 10m wind speeds from WRF to 20ft, we use a wind adjustment factor (WAF) from Andrews (2012).	The model is based on the work of Albini and Baughman (1979) and Baughman and Albini (1980), using some assumptions made by Finney (1998).	The sheltered WAF assumes that the wind speed is approximately constant with height below the top of a uniform forest canopy. Sheltered WAF is based on the fraction of crown space occupied by tree crowns.	Wildfire Consequence
General Equipment Failure Rates	SCE bases its equipment failure rates on its predictive models for Equipment/Facility Failure) EFF) subcomponents using 2015-2020+ equipment failure data for its modelled assets.	SCE uses machine learning algorithms to develop predictive models for equipment failure that are validated and tested for accuracy for inclusion in our probabilistic assessment for risk calculations.	SCE uses historical data which may not be an indicator of future equipment failure rates.	POI

	Assumption	Justification	Limitation	Applicable Models
General Vegetation Contact Rates	SCE bases its vegetation contact rates on its predictive model for Contact from Foreign Object (CFO) subcomponent using 2015-2020+ CFO outages for vegetation sub drivers.	SCE uses machine learning algorithms to develop predictive models for vegetation contact that are validated and tested for accuracy for inclusion in our probabilistic assessment for risk calculations.	SCE uses historical data which may not be an indicator of future vegetation contact rates.	POI
Height of Electrical Equipment in the Service Territory	SCE uses current asset condition attributes (e.g., age, voltage, manufacturer, height of pole, etc.) as variables utilizes in the machine learning algorithms. The height of electrical equipment is governed by the applicable regulations in GO 95.	SCE’s machine learning models use historical environmental , physical, and electrical variables paired with their actual records of failures to derive statistical insights.	Height of equipment is based on pole height of associated asset and may not reflect actual installation height.	POI
Stability of the Atmosphere	Atmospheric instability, as it related to wildfire propagation after initial ignition, is not considered in	The wildfire propagation model is a surface model is not directly coupled with	The intent of the model is to capture the fire propagation at the time of the ignition event	Wildfire Consequence

	Assumption	Justification	Limitation	Applicable Models
	the model.	the atmosphere. It assumes that the heat flux generated by the wildfire will not modify local atmospheric conditions and thus create additional fuel moisture dryness (e.g., pre-heating) in any way.	through an 8-hour simulated burn period. The resulting wildfire is assumed to be fully developed with fire acceleration, flashover, or decay not being considered.	
Vegetation Fuels	SCE uses the Live/Dead Fuel Moisture Data from the 444 worst weather days developed by its weather forecasting. These variables include Dead moisture content, (1hr, 10hr, 100hr, 1000hr) herbaceous moisture content, and live woody moisture content. (See Section 8.3.5).	Dead fuel moisture is calculated using the Nelson model which is widely used among fire agencies nationwide. Live fuel moisture is calculated using a machine learning approach that was in part developed by SCE.	Modeling fuel moisture is affected by the same limitations that are common in numerical modeling. In addition to the biases and other forecast errors associated with parameters such as temperature, atmospheric moisture, soil moisture, evaporation rates, etc., needed to calculate fuel moisture, uncertainties within the physical processes of	Wildfire Consequence

	Assumption	Justification	Limitation	Applicable Models
			vegetation phenology compound the errors associated with vegetation moisture outputs	
Vegetation Fuels	<p>Fuels are based on the LandFire 2016 Fuel model (Scott & Burgan 2005) canopy and surface fuel models, including an additional 19 custom fuel models.</p> <p>Additional WUI and Non-Forested Land Use are based on customized fuel models representing fire propagation in those locations. (Technosylva, 2020).</p>	The majority of fire propagation models utilize Scott and Burgan models	<p>These fuel models are static and only represent a snapshot in time at a 30m x 30m resolution. Given limitations in the spatial and temporal granularity of this information (e.g., changes in suburban development between the time the data was captured to present day), this data may not accurately represent details in land/vegetation types at the time of the ignition.</p>	Wildfire Consequence
Combination of Risk Components /Weighting of Attributes	The natural unit consequences resulting from wildfire simulations are translated into	SCE developed its MAVF based on the principles as set forth in the S-MAP	The attributes are based on observable data and may not reflect other qualitative	Wildfire Consequence

	Assumption	Justification	Limitation	Applicable Models
	safety, reliability and consequence scores based on SCE MAVF framework.	settlement. Appendix B provides further discussion and justification for each of the components. SCE is an active participant in the CPUC’s Risk Informed Decision-Making Framework Proceeding (“Risk OIR”) ⁹⁵ which governs modifications to this risk assessment process.	factors such as egress or customer satisfaction; factors which may not lend themselves to this type of framework. They may also not reflect of associated risk tolerance standards as set forth in other Commission and/or Legislative guidance.	
Wind Load Capacity for Electrical Equipment	SCE assumes the wind load capacity for its electrical equipment is, at minimum, aligned with applicable GO 95 requirements.	SCE is required to maintain the system based on applicable CPUC operating practices.	Equipment failure can occur in both high wind and low/no wind conditions and can be the result of difficult to predict factors, such as animal and vehicles contact.	POI
Number, extent, and type of community	Not Applicable	Communities at Risk are not spatially granular	Not Applicable, see comment at left.	Wildfire Consequence

⁹⁵ R.20-07-013. CPUC Order Instituting Rulemaking to Further Develop a Risk-Based Decision-Making Framework for Electric and Gas Utilities.

	Assumption	Justification	Limitation	Applicable Models
assets at risk		<p>enough to adequately represent wildfire risk. For example, the City of Los Angeles is considered a Community at Risk (CAR), though the vast majority of the city is not exposed to wildland fires.</p> <p>Please also see Section 5.4.</p>		
Proxies for estimating impact on customers and communities	SCE assumes only direct impacts to customers.	SCE uses a ratio of 256 structures impacted to one fatality, and a ratio of 107 structures impacted to one serious injury to determine its safety impact.	These estimates are based on recent historical fire information in Southern California and only include reported data. They do not include any potential indirect or unreported impacts.	Wildfire Consequence
Extent, distribution, and characteristics of vulnerable populations	SCE utilizes an AFN/NRCI multiplier on the safety attribute of MAVF.	The AFN/NRCI multiplier is a relative ranking of vulnerability by populations served on individual	AFN/NRCI weights each population set (AFN customers/NRCI customers) equally and does not	Wildfire Consequence

	Assumption	Justification	Limitation	Applicable Models
		circuits.	differentiate between customer class. Additionally, SCE does not account for customer self-generation capabilities.	

6.3 Risk Scenarios

In this section of the WMP, the electrical corporation must provide a high-level overview of the scenarios to be used in its risk analysis in Section 6.2 These must include at least the following:

- **Design basis scenarios** that will inform the electrical corporation's long-term wildfire mitigation initiatives and planning
- **Extreme-event scenarios** that may inform the electrical corporation's decisions to provide added safety margin and robustness

The risk scenarios described in Sections 6.3.1 and 6.3.2 below are the minimum scenarios the electrical corporation must assess in its wildfire and PSPS risk analysis. The electrical corporation must also describe and justify any additional scenarios it evaluates.

Each scenario must consider:

- **Local relevance:** *Heterogeneous conditions (e.g., assets, equipment, topography, vegetation, weather) that vary over the landscape of the electrical corporation's service territory at a level sufficiently granular to permit understanding of the risk at a specific location or for a specific circuit segment. For example, statistical wind loads must be calculated based on wind gusts considering the impact of nearby topographic and environmental features, such as hills, canyons, and valleys*
- **Statistical relevance:** *Percentiles used in risk scenario selection must consider the statistical history of occurrence and must be designed to describe a reasonable return interval / probability of occurrence. For example, designing to a wind load with a 10,000- year return interval may not be desirable as most conductors in the service territory would be expected to fail (i.e., the scenario does not help discern which areas are at elevated risk)*

Overview

SCE uses a design basis scenario in its MARS and IWMS Risk Frameworks that reflects wind loading conditions, weather conditions, and vegetation conditions. As described further below, SCE's approach incorporates elements of five of the design scenarios defined by OEIS for the risk assessment analysis that informs mitigation prioritization and selection.

SCE has also developed a scenario called Climate 2030 that represents an Extreme-Event/High Uncertainty scenario. This scenario is not currently used and is still under evaluation. It is intended to help SCE assess if climate change, as well as any resulting changes in wildfire consequence, may influence our existing grid hardening strategy.

SCE provides further detail on both its design basis and extreme event scenarios in the sections immediately following.

6.3.1 Design Basis Scenarios

Fundamental to any risk assessment is the selection of one or more relevant design basis scenarios (design scenarios). These scenarios will inform long-term mitigation initiatives and planning. In this section, the electrical corporation must identify the design scenarios it has prioritized from a comprehensive set of possible scenarios. The scenarios identified must be based on the unique wildfire and PSPS risk characteristics of the electrical corporation's service territory and achieve the primary goal and stated plan objectives of its WMP. At a minimum, the following design scenarios representing

statistically relevant weather and vegetative conditions must be considered throughout the service territory.

For wind loading on electrical equipment, the electrical corporation must use at least four statistically relevant design conditions. It must calculate wind loading based on locally relevant 3-second wind gusts over a 30-year wind speed history during fire season in its service territory. The conditions are the following:

- **Wind Load Condition 1: Baseline:** The baseline wind load condition the electrical corporation use in design, construction, and maintenance relative to GO 95, Rule 31.1.
- **Wind Load Condition 2: Very High:** 95th-percentile wind gusts based on maximum daily values over the 30-year history. This corresponds to a probability of exceedance of 5 percent on an annual basis (i.e., 20-year return interval) and is intended to capture annual high winds observed in the region (e.g., Santa Ana winds).
- **Wind Load Condition 3: Extreme:** Wind gusts with a probability of exceedance of 5 percent over the three-year WMP cycle (i.e., 60-year return interval).
- **Wind Load Condition 4: Credible Worst Case:** Wind gusts with a probability of exceedance of 1 percent over the three-year WMP cycle (i.e., 300-year return interval).

The data and/or models the electrical corporation uses to establish locally relevant wind gusts for these design conditions must be documented in accordance with the weather analysis requirements described in Appendix B.

For weather conditions used in calculating fire behavior, the electrical corporation must use probabilistic scenarios based on a 30-year history of fire weather. This approach must consider a range of wind speeds, directions, and fuel moistures that are representative of historic conditions. In addition, the electrical corporation must discuss how this weather history is adapted to align with current and forecasted climate conditions. The electrical corporation must consider the following two conditions:

- **Weather Condition 1: Anticipated Conditions:** The statistical weather analysis is limited to fire seasons expected to be the most relevant to the next three years of the WMP cycle.
- **Weather Condition 2: Long-Term Conditions:** The statistical weather analysis is representative of fire seasons covering the full 30-year history.

The electrical corporation must state how it defines “fire weather” and “fire season” for the calculations of these probabilistic scenarios.

One possible approach to the statistical weather analysis for fire behavior is Monte- Carlo simulation of synthetic fire seasons in accordance with approaches presented by the United States Forest Service^{96 97}. However, the electrical corporation must justify the selection of locally relevant data for use in this approach (i.e., Remote Automated Weather Systems data or historic weather reanalysis must be locally

⁹⁶ M. A. Finney, I. C. Grenfell, C. W. McHugh, R. C. Seli, D. Trethewey, R. D. Stratton, and S. Brittain, 2011, “A Method for Ensemble Wildland Fire Simulation,” *Environmental Modeling & Assessment* 16, no. 2: 153–167.

⁹⁷ M. A. Finney, C. W. McHugh, I. C. Grenfell, K. L. Riley, and K. C. Short, 2011, “A Simulation of Probabilistic Wildfire Risk Components for the Continental United States,” *Stochastic Environmental Research and Risk Assessment* 25: 973–1000.

relevant). The data and/or models the electrical corporation uses to establish locally relevant weather data for these designs must be documented in accordance with the weather analysis requirements described in Appendix B: Supporting Documentation for Risk Methodology and Assessment.

For vegetative conditions not including short-term moisture content, the electrical corporation must use design scenarios including the current and forecasted vegetative type and coverage. The conditions it must consider include the following:

- **Vegetation Condition 1: Existing Fuel Load:** The wildfire hazard must be evaluated with the existing fuel load within the service territory, including existing burn scars and fuel treatments that reduce the near-term fire hazard.
- **Vegetation Condition 2: Short-Term Forecasted Fuel Load:** The wildfire hazard must be evaluated considering the changes in expected fuel load over the three-year Base WMP cycle (2023-2025). At a minimum, this must include regrowth of previously burned and treated areas.
- **Vegetation Condition 3: Long-Term Extreme Fuel Load:** The wildfire hazard must be evaluated considering the long-term potential changes in fuels throughout the service territory. This must include, at a minimum, regrowth of previously burned and treated areas and changes in predominant fuel types.

The data and/or models the electrical corporation uses to establish locally relevant fuel loads for these designs must be documented in accordance with the vegetation requirements described in Appendix B: Supporting Documentation for Risk Methodology and Assessment.

The electrical corporation must provide a brief narrative on the design basis scenarios used in its risk analysis. If the electrical corporation includes additional design scenarios, it must describe these scenarios and their purpose in the analysis. In addition, the electrical corporation must provide a table summarizing the following information:

- Identification of each design basis scenario (e.g., Scenario 1, Scenario 2)
- Components of each scenario (e.g., Weather Condition 1, Vegetation Condition 1)
- Purpose of each scenario

Table 6-3 provides an example.

Overview: Design Basis Scenarios

SCE utilizes a design scenario that most closely reflects Wind Loading Condition 1, Wind Loading Condition 2, Weather Condition 2, Vegetation Condition 1, and Vegetation Condition 3 for mitigation planning purposes in its MARS and IWMS Risk Frameworks.

Table 6-3 - Summary of Design Basis Scenarios

Scenario ID	Design Scenarios (Components)	Purpose
WL1	Wind Loading Condition 1	Used in the MARS and IWMS Risk Frameworks.
WL2	Wind Loading Condition 2	
WC2	Weather Condition 2	
VC1	Vegetation Condition 1	
VC3	Vegetation Condition 3	

SCE notes that it uses scenarios that reflect Wind Loading Condition 2, Weather Condition 1, and Vegetation Condition 1 for the purpose of evaluating potential PSPS de-energization decisions. See Section 9.2 for additional detail.

WL1: Baseline

The baseline wind load condition the electrical corporation use in design, construction, and maintenance relative to GO 95, Rule 31.1.

SCE uses a combination of Wind Loading Condition 1 and Wind Loading Condition 2 in its design scenarios.

Following the 2011 San Gabriel Valley windstorm, SCE was directed by the CPUC to conduct a pole loading study to assess the likely wind conditions to comply with the relevant sections of ASCE/SEI 7-10 “Minimum Design Loads for Buildings and Other Structures” and California General Order (GO) 95 “Overhead Electric Line Construction.”⁹⁸ These weather and wind conditions reflect the same 41 fire weather scenarios used in the construction of the CPUC HFTD maps.

The result of this study was a composite wind loading map for peak wind speeds, both with and without consideration of relative humidity and temperature, for wind velocities at 20-foot elevations (3 second gusts) based on a 50-year return interval (i.e., a 2% chance of occurrence per year). SCE uses this information in its design scenario.

WL2: Very High

95th-percentile wind gusts based on maximum daily values over the 30-year history. This corresponds to a probability of exceedance of 5 percent on an annual basis (i.e., 20-year return interval) and is intended to capture annual high winds observed in the region (e.g., Santa Ana winds).

⁹⁸ See I.14-03-004. Order Instituting Investigation on the Commission’s Own Motion into the Operations and Practices of Southern California Edison Company Regarding the Acacia Avenue Triple Electrocution Incident in San Bernardino County and the Windstorm of 2011.

See above regarding Wind Load Condition 1. SCE's approach addresses the conditions outlined in WL2.

SCE notes that it uses scenarios that reflect Wind Loading Condition 2 for the purpose of evaluating potential PSPS de-energization decisions. See Section 9.2 for additional detail.

WL3: Extreme

Wind gusts with a probability of exceedance of 5 percent over the three-year WMP cycle (i.e., 60-year return interval).

SCE does not utilize Wind Loading Condition 3 because the composite wind loading map for peak wind speeds developed following the 2011 San Gabriel Windstorms represent reasonable weather scenarios for the design, construction, and maintenance of SCE's equipment, as prescribed by GO 95. SCE currently does not see the utility of the WL3 scenario and thus SCE does not anticipate developing or utilizing this design scenario.

WL4: Credible Worst Case

Wind gusts with a probability of exceedance of 1 percent over the three-year WMP cycle (i.e., 300-year return interval).

SCE does not utilize Wind Loading Condition 4 because the composite wind loading map for peak wind speeds developed in 2011 already represents credible weather scenarios as prescribed by GO 95. Because of this, SCE does not anticipate utilizing this design scenario.

WC1: Anticipated Conditions

The statistical weather analysis is limited to fire seasons expected to be the most relevant to the next three years of the WMP cycle.

SCE does not use a short-term forward-looking weather scenario in its MARS and IWMS Risk Frameworks, as short-term weather trends (e.g., three years) are highly variable and contain a significant amount of uncertainty. Additionally, short term weather trends are generally not representative of the ensemble average of longer term (e.g., 10-30 year) climatological conditions. Because of this, SCE does not anticipate utilizing this design scenario.

SCE notes that it uses scenarios that reflect Weather Condition 1 for the purpose of evaluating potential PSPS de-energization decisions. See Section 9.2 for additional detail.

WC2: Long-Term Conditions

The statistical weather analysis is representative of fire seasons covering the full 30-year history.

SCE utilizes the deterministic maximum consequence values resulting from 444 historical weather scenarios reflecting fire weather conditions for SCE's service territory across 20 years of weather history developed by ADS and calibrated to SCE's service territory. These weather scenarios include the 41 weather scenarios used in the creation of the CPUCs HFTD maps, as well as additional locally relevant fuel and wind driven fire weather scenarios. These weather scenarios generally correspond to the definition for WC2.

At this point in time SCE does not plan to extend the weather history data set from 20 to 30 years, however we plan to add fire weather data to the existing data set over time.

VC1: Existing Fuel Load

The wildfire hazard must be evaluated with the existing fuel load within the service territory, including existing burn scars and fuel treatments that reduce the near-term fire hazard.

During the Review & Revise stage of the IWMS Risk Framework, SCE's team of SMEs considers existing fuels through photographs in its analysis. SCE's POI models also use elements of existing fuel load, specifically tree inventory. Vegetation type, density, location information, and burn scars are also considered in the fire simulations used to determine Wildfire Consequence.

Further, SCE's approach to asset inspections and vegetation management considers other shorter-term conditions (e.g., existing fuel conditions) for Areas of Concern (AOCs). See Sections 8.1.3.1, 8.1.3.2, 8.2.2.4, 8.2.1.3, and 8.2.3.8 for details.

SCE also notes that it uses scenarios that reflect Vegetation Condition 1 for the purpose of evaluating potential PSPS de-energization decisions. See Section 9.2 for additional detail.

VC2: Short-Term Forecasted Fuel Load

The wildfire hazard must be evaluated considering the changes in expected fuel load over the three-year Base WMP cycle (2023-2025). At a minimum, this must include regrowth of previously burned and treated areas.

SCE does not use Vegetation Condition 2, as a short-term horizon (i.e., the 2023-2025 WMP period) is typically not informative for mitigation prioritization and scoping. As noted above, SCE uses existing fuel load, and as described below, SCE uses long-term fuel load conditions for mitigation planning purposes.

VC3: Long-Term Extreme Fuel Load

The wildfire hazard must be evaluated considering the long-term potential changes in fuels throughout the service territory. This must include, at a minimum, regrowth of previously burned and treated areas and changes in predominant fuel types.

SCE uses a 2030 fuel layer which aligns with Vegetation Condition 3. The 2030 fuel layer reflects likely fuel conditions in the year 2030. While SCE does not believe these fuel conditions are extreme, per se, SCE does believe this fuel loading is reflective of long-term potential fuel regrowth in major fire scars (e.g., greater than 5,000 acres.).

6.3.2 Extreme-Event/High Uncertainty Scenarios

In this section, the electrical corporation must identify extreme-event/high-uncertainty scenarios that it considers in its risk analysis. These generally include the following types of scenarios:

- *Longer-term scenarios with higher uncertainty (e.g., climate change impacts, population migrations, extended drought)*
- *Multi-hazard scenarios (e.g., ignition from another source during a PSPS)*
- *High-consequence but low-likelihood ("Black Swan") events (e.g., acts of terrorism, 10,000-year weather)*

While the primary risk analysis is intended to be based on the design scenarios discussed in Section 6.3.1, the potential for high consequences from extreme events may provide additional insight into the mitigation prioritization described in Wildfire Mitigation Strategy Development Section 7.

The electrical corporation must provide a brief narrative on the extreme-event scenarios used in its risk analysis. The electrical corporation must describe these scenarios and their purpose in the analysis. In addition, the electrical corporation must provide a table summarizing the following information:

- Identification of each extreme-event risk scenario (e.g., Scenario 1, Scenario 2)
- Components of each scenario (e.g., Weather Condition 1, Vegetation Condition 1)
- Purpose of the scenario

Table 6-4 provides a summary of the extreme-event scenario used by SCE for this purpose.

Overview: Extreme Event Scenarios

SCE has a single extreme event scenario (i.e., “Climate 2030”) which is identified in Table 6-4 below and is described further immediately following the table. SCE also provides a diagram for the Climate 2030 scenario, which is discussed within the context of “Longer-Term Scenarios with Higher Uncertainty.”

Per the WMP Guidelines, SCE also discusses its approach to “Multi-Hazard Scenarios” and “High-Consequence But Low-Likelihood Events”. For reasons described below, at this time SCE does not have wildfire-specific scenarios in either of these two categories, and as such does not have related diagrams.

Table 6-4 - Summary of Extreme-Event Scenarios

Scenario ID	Extreme-Event Scenario/Components	Purpose
Climate 2030	Assess how climate change by 2030 could impact live and dead fuel moisture conditions.	Assess if climate change, as well as any resulting changes in wildfire consequence, may influence our existing grid hardening strategy.

Longer-Term Scenarios with Higher Uncertainty

Longer-term scenarios with higher uncertainty (e.g., climate change impacts, population migrations, extended drought)

SCE has developed, and in the process of performing the analysis, to assess how climate change by 2030 could impact live and dead fuel moisture conditions, which, in turn, may influence the spatial patterns of future wildfire (ignition) consequences.

Figure SCE 6-28 - Schematic for SCE Climate Change (2030) Methodology

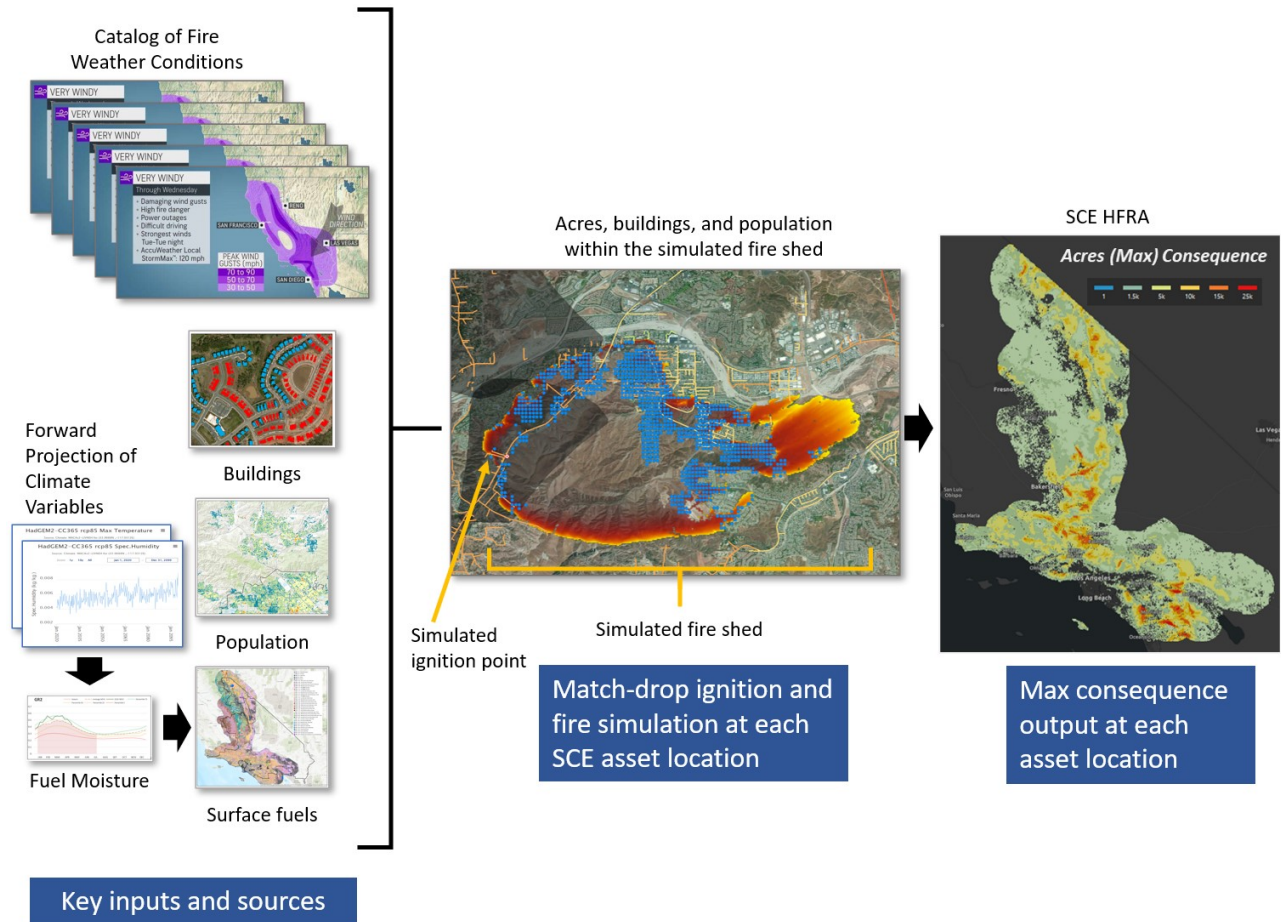

The methodology aligns to the prescribed data sources outlined in the CPUC’s Climate Change Proceeding (R.18-04-019),⁹⁹ including 10 priority CIMP5 Global Climate Models, which are the minimum prescribed by the CPUC in that proceeding. These are also the same data sources used in SCE’s 2022 Climate Adaptation and Vulnerability Assessment (CAVA) report.

SCE’s climate change methodology utilizes a different downscaling technique (e.g., Localized Constructed Analogs (LOCA)) and Global Climate Model (GCM) selection than that identified in the WMP guidelines. SCE has shared its methodology in Energy Safety wildfire risk modeling workshops. Additionally, SCE has participated in related Energy Safety sponsored workshops, specifically on how to better integrate academic feedback into climate change modeling.

Multi-Hazard Scenarios

Multi-hazard scenarios (e.g., ignition from another source during a PSPS)

SCE acknowledges that consideration of multi-hazard scenarios is appropriate from the perspective of enterprise risk management, emergency preparedness, and disaster planning. However, at this time SCE does not consider multi-hazard scenarios as an element of its wildfire and PSPS risk analysis.

Modeling such multi-hazard scenarios introduces a wide range of hypothetical possibilities that introduces significant uncertainty, can be speculative in nature, and do not provide a sufficient level of

⁹⁹ See <https://www.cpuc.ca.gov/industries-and-topics/electrical-energy/climate-change>

confidence on which to invest the significant financial resources that are needed for wildfire and PSPS mitigations.

For multi-hazard scenarios, as mentioned in Section 8.4.2, SCE maintains and updates an All Hazards plan and maintains an Incident Management Team (IMT) structure that serve as planning and response tools for these types of complex events.

SCE will evaluate whether multi-hazard scenario analysis may be beneficial for wildfire mitigation planning.

High-Consequence/Low-Likelihood Events

High-consequence but low-likelihood (“Black Swan”) events (e.g., acts of terrorism, 10,000-year weather)

SCE’s wildfire consequence modeling is currently based on 444 weather scenarios that include extreme scenarios representing a 1 in 50 year level of frequency. Furthermore, for the reasons described above in the response to multi-hazard scenarios, these types of scenarios can be an appropriate discussion for a utility’s enterprise risk function but SCE does not consider “black swan” events such as 10,000 year weather or acts of terrorism as directly relevant to standard programmatic wildfire mitigation development and scoping.

SCE also notes the above comments about its all-hazards plan and IMT capabilities, which are intended to address scenarios such as extreme weather or hostile actions. Furthermore, SCE discussed both cyber and physical security in its 2022 RAMP filing (chapters 7 and 11, respectively).

6.4 Risk Analysis Results and Presentation

In this section of the WMP, the electrical corporation must present a high-level overview of the risks calculated using the approaches discussed in Section 6.2 for the scenarios discussed in Section 6.3.

The risk presentation must include the following:

- *Summary of electrical corporation-identified high fire risk areas in the service territory*
- *Geospatial map of the top risk areas within the High Fire Risk Area (HFRA) (i.e., areas that the electrical corporation has deemed at high risk from wildfire independent of HFTD designation)*
- *Narrative discussion of proposed updates to the HFTD*
- *Tabular summary of top risk-contributing circuits across the service territory*
- *Tabular summary of key metrics across the service territory*

The following subsections expand on the requirements for each of these.

6.4.1 Top Risk Areas Within the HFRA

In this section, the electrical corporation must identify top risk areas within its self-identified HFRA, compare these areas to the CPUC's current HFTD, and discuss how it plans to submit its proposed changes to the CPUC for review.

6.4.1.1 Geospatial Maps of Top-Risk Areas within the HFRA

The electrical corporation must evaluate the outputs from its risk modeling to identify top risk areas within its HFRA (independent of where they fall with respect to the HFTD). The electrical corporation must provide geospatial maps of these areas.

The maps must fulfill the following requirements:

- **Risk levels:** *Levels must be selected to show at least three distinct levels, with the values based on the following:*
 - *Top 5 percent of overall utility risk values in the HFRA*
 - *Top 5 to 20 percent of overall utility risk values in the HFRA*
 - *Bottom 80 percent of overall utility risk values in the HFRA*
- **Colormap:** *The colormap of the risk levels must meet accessibility requirements (recommended colormap is Viridis)*
- **County lines:** *The map must include county lines as a geospatial reference*
- **HFTD tiers:** *The map must show a comparison with existing HFTD Tiers 2 and 3 regions.*

Figure SCE 6-29 shows the top-risk areas within HFTD.

Figure SCE 6-29 - Geospatial Maps of Top-Risk Areas within the HFTD¹⁰⁰

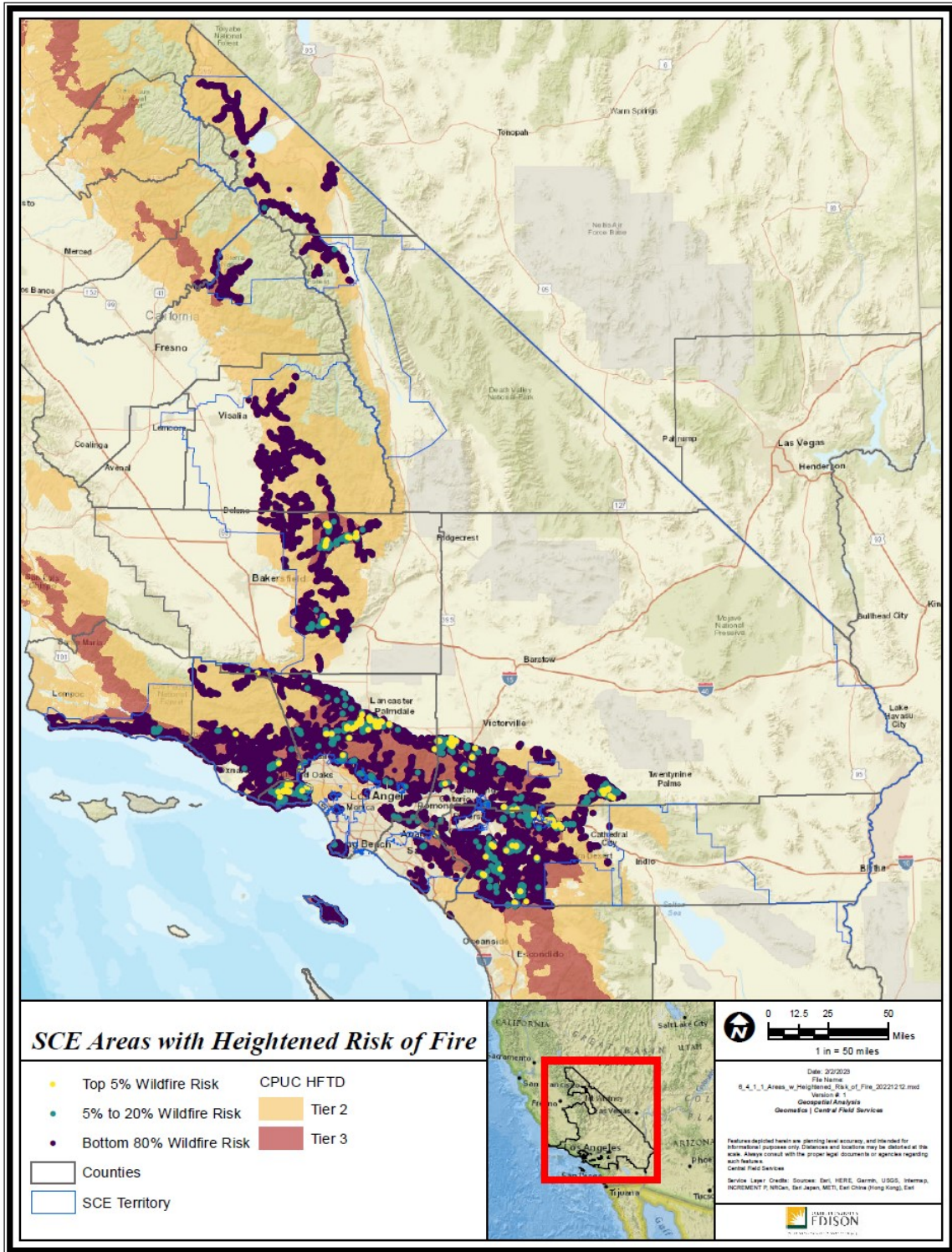

6.4.1.2 Proposed Updates to the HFTD

In this section, the electrical corporation must discuss the differences between the electrical corporation-identified top-risk areas within the HFRA and the existing CPUC-approved HFTD. The electrical

¹⁰⁰ Risk data as of 1/1/23 calculated with the MARS Framework.

corporation must identify areas that its risk analysis indicates are at a higher risk than indicated in the current HFTD. The electrical corporation must also describe its process for submitting proposed changes to the HFTD to the CPUC, if such changes are desired; the electrical corporation need not conclude that the HFTD should be modified. Any proposed changes to the HFTD must be mapped in accordance with the requirements in the previous sub- section.

In 2019, SCE's Petition for Modification (PFM) to the CPUC resulted in a final decision D.20-12-030 (issued 12/21/2020) in Rulemaking 15.05.006 which formally adopted the remaining less than 1% of our non-CPUC HFRA into their Tier 2 and Tier 3 areas. At the time of this filing, all of SCE's HFRA¹⁰¹ is now consistent with the CPUC HFTD maps. SCE will continue to review the HFTD boundaries each year per the AB 1054 requirements.

SCE has developed advanced analytical techniques using satellite image change detection and other processes to broadly detect and characterize changes in land use and land cover. These technical advances are utilized by a team of subject matter experts in fire science, enterprise risk management, grid operations, vegetation management, and fire management to consider potential removals or additions to HFRA.

- The primary inputs to SCE's HFRA Boundary Assessment process are outlined at a high level below.
- LandFire 2016 updated with additional classifiers from Technosylva to better represent urban fuel, as well as a projection of fuel growth in major fire scars from previous fire seasons with a fuel regrowth projection to 2030.
- Wildland-Urban Interface (WUI) information from Silvis Labs, which may be further augmented with information from CAL FIRE.
- Historical wildfires from CAL FIRE's Fire Resource Assessment Program (FRAP); U.S. Forest Service Wildfire Burn Probability layer; and SCE internal wildfire consequence simulations, including wildfire hazard intensity metrics (e.g., flame length).

SCE's HFRA Boundary Assessment process is outlined at a high level below.

- Condense land use land cover information to identify locations with moderate to highly burnable fuels based on fuel loading conditions (e.g., grass, grass-shrubs, timber, and slash-blowdown).
- Identify locations with highly urbanized landcover with the assistance of WUI information from Silvis Labs to represent the boundary where highly combustible landcover meets urban landcover (e.g., WUI Interface/Intermix).
- Where overhead assets are present along this WUI boundary, create/add a 600-ft buffer from that interface into urbanized landcover. The 600-foot buffer is used as a conservative measure to address possible ignition fusing and facility failure which may occur along the immediate WUI boundary and could result in a small fire that may, under certain conditions, ignite more

¹⁰¹ SCE uses a 200-foot buffer extended from the HFTD to account for possible internal mapping discrepancies of assets.

abundant and contiguous fuels nearby. As part of this new boundary assessment methodology, SCE does not prescribe a buffer along the WUI interface boundary when only underground assets are present.

- SCE also uses historical wildfire information from (e.g., CAL FIRE’s FRAP data), as well as the U.S. Forest Service (USFS) Wildfire Burn Probability (FRC4) and SCE internal wildfire consequence modeling, including Wildfire Hazard Intensity (FRC5) metrics (e.g., flame length) to assess Wildfire Exposure (see Section 6.2.1).
- SCE pressure tests all recommended locations with internal teams and experts in fire science, wildfire operations, emergency and grid operations, risk management, vegetation management, and others.

Once SCE has completed its analysis and obtained agreement of CAL FIRE, SCE will begin the process to seek approval by the CPUC to modify the HFTD, which is described in general terms below.

1. SCE submits a Petition for Modification (PFM) to the CPUC that includes:
 - a. Details and reason for change for all polygons recommended.
 - b. ArcGIS file/layer with recommended polygon changes.
 - c. High-level analysis focused on possible customer impacts.
2. CPUC reviews the PFM and requests additional information and/or provides approval, rejection, or adjustments to the recommended modifications.
3. SCE will review the CPUC feedback and finalize the PFM to the agreed upon modifications.
4. CPUC will review the final PFM and provide SCE approval of the final modifications.

After SCE receives the CPUC approval, SCE will begin implementation of mapping changes, operational updates, enterprise system updates, and communications to affected stakeholders.

While SCE does not currently plan to propose boundary changes, SCE evaluates its boundary on a regular basis and looks forward to working with stakeholders and agencies including Energy Safety, the CPUC, and CAL FIRE, to formalize any new proposed modifications.

Additionally, SCE continues to collaborate with neighboring Investor-Owned Utilities (IOUs) to share best practices, including remote sensing techniques. If SCE deems it appropriate, we may enact mitigation activities in these identified locations, while those proposed modifications are under review through the CPUC process. SCE notes that it has consulted with CAL FIRE several times and has received positive feedback on our approach.

Applicable fire-safety regulations adopted in R.08-11-005 that rely on the HFTD maps include:

- GO 95, Rule 18A, which requires electric utilities to place a high priority on the correction of significant fire hazards.
- GO 95, Rules 31.2, 80.1A, and 90.1B, which set the minimum frequency for inspections of aerial communication facilities located in close proximity to power lines.

- GO 95, Rule 35, Table 1, Case 14, which requires increased radial clearances between bare-line conductors and vegetation in high fire-threat areas of Southern California.
- GO 95, Appendix E, which authorizes increased time-of-trim clearances between bare-line conductors and vegetation.
- GO 165, Appendix A, Table 1, which requires more frequent patrol inspections of overhead powerline facilities.
- GO 166, Standard 1.E., which requires each electric utility to develop and submit a plan to reduce the risk of fire ignitions by overhead facilities in high fire-threat areas during extreme fire-weather events.

6.4.2 Top Risk-Contributing Circuits/Segments/Spans

The electrical corporation must provide a summary table showing the highest-risk circuits, segments, or spans¹⁰² within its service territory. The table should include the following information about each circuit:

- **Circuit, Segment, or Span ID:** *Unique identifier for the circuit, segment, or span*
- **Overall utility risk scores:** *Numerical value for each risk*
- **Top risk contributors:** *The risk components that lead to the high risk on the circuit*

The electrical corporation must rank its circuits, segments, or spans by circuit-mile-weighted overall utility risk score and identify each circuit, segment, or span that significantly contributes to risk. A circuit/segment/span significantly contributes to risk if it:

1. *Individually contributes more than 1 percent of the total overall utility risk; or*
2. *Is in the top 5 percent of highest risk circuits/segments/spans when all circuits/segments/spans are ranked individually from highest to lowest risk.*

The electrical corporation must include each circuit, segment, or span that significantly contributes to risk in the table below.¹⁰³

¹⁰² For the section, the electrical corporation may use either circuits, segments, or spans, whichever is more appropriate considering the granularity of its risk model(s).

¹⁰³ This table is a summary of information provided in the QDR. As such, information included in this table must align with the QDR.

Table 6-5 - Summary of Top-Risk Circuits¹⁰⁴

Risk Ranking	Circuits	Overall Utility Risk Score	Ignition Risk Score	PSPS Risk Score	Top Risk Contributors
1	PELONA	0.1325	0.1325	0.0000	CFO Other, EFF
2	LASKER	0.1063	0.1063	0.0000	CFO Other, EFF
3	CRAWFORD	0.0999	0.0996	0.0003	EFF, CFO Other
4	LOTTO	0.0996	0.0996	0.0000	EFF, CFO Other
5	RAYBURN	0.0932	0.0932	0.0000	EFF, CFO Other
6	SHOVEL	0.0918	0.0918	0.0000	EFF, CFO Other
7	STORES	0.0902	0.0902	0.0000	EFF, CFO Other
8	BIANCO	0.0788	0.0786	0.0002	CFO VEG, EFF
9	BLACKFOOT	0.0785	0.0785	0.0000	CFO Other, EFF
10	PINEWOOD	0.0770	0.0769	0.0001	EFF, CFO Other
11	PASCAL	0.0756	0.0756	0.0000	EFF, CFO Other
12	ROMERO	0.0745	0.0745	0.0000	CFO Other, EFF
13	PURCHASE	0.0728	0.0728	0.0000	EFF, CFO Other
14	LIMITED	0.0688	0.0688	0.0000	EFF, CFO Other
15	SCHMIDT	0.0688	0.0687	0.0000	EFF, CFO Other
16	RHODA	0.0667	0.0667	0.0000	CFO Other, EFF
17	KENO	0.0638	0.0637	0.0001	EFF, CFO Other
18	QUINBY	0.0620	0.0620	0.0000	CFO Other, EFF
19	MULHOLLAND	0.0618	0.0618	0.0000	EFF, CFO Other
20	TONTO	0.0590	0.0581	0.0009	CFO Other, EFF
21	DINELY	0.0586	0.0586	0.0000	EFF, CFO Other
22	WAITE	0.0580	0.0580	0.0000	EFF, CFO Other
23	POPPET FLATS	0.0568	0.0568	0.0000	EFF, CFO Other
24	ROTEC	0.0568	0.0568	0.0000	EFF, CFO Other
25	IDA	0.0539	0.0539	0.0000	EFF, CFO Other

¹⁰⁴ Risk scores as of 1/1/2023 calculated via the MARS Framework. Values for Overall Utility Risk Score, Ignition Risk Score, and PSPS Risk Score represent average MARS value per circuit mile within HFRA. Top Risk Contributors indicates the top two risk drivers (listed in order).

Risk Ranking	Circuits	Overall Utility Risk Score	Ignition Risk Score	PSPS Risk Score	Top Risk Contributors
26	PERRIS	0.0528	0.0528	0.0000	EFF, CFO Other
27	ERSKINE	0.0517	0.0517	0.0000	EFF, CFO Other
28	BODKIN	0.0508	0.0507	0.0000	EFF, CFO Other
29	ACROBAT	0.0502	0.0502	0.0001	CFO Other, EFF
30	DOLORES	0.0493	0.0493	0.0000	EFF, CFO Other
31	CHUMASH	0.0492	0.0491	0.0000	CFO Other, CFO VEG
32	TUDOR	0.0491	0.0491	0.0000	EFF, CFO Other
33	AMETHYST	0.0491	0.0489	0.0002	EFF, CFO Other
34	KUFFEL	0.0490	0.0490	0.0000	EFF, CFO Other
35	PHEASANT	0.0488	0.0488	0.0000	EFF, CFO Other
36	BURNT MOUNTAIN	0.0475	0.0474	0.0000	EFF, CFO Other
37	PIONEERTOWN	0.0468	0.0468	0.0000	EFF, CFO Other
38	SILVA	0.0468	0.0442	0.0026	CFO Other, PSPS
39	PICONI	0.0468	0.0468	0.0000	CFO Other, EFF
40	GAMBLER	0.0464	0.0464	0.0000	EFF, CFO Other
41	TRIUNFO	0.0458	0.0458	0.0000	EFF, CFO Other
42	PARCO	0.0458	0.0451	0.0007	EFF, CFO Other
43	STONEMAN	0.0458	0.0458	0.0000	EFF, CFO Other
44	MUSTANG	0.0452	0.0451	0.0000	EFF, CFO Other
45	DICE	0.0450	0.0450	0.0000	EFF, CFO Other
46	LA GRANDE	0.0449	0.0448	0.0001	CFO Other, EFF
47	LUISENO	0.0447	0.0447	0.0000	EFF, CFO Other
48	MUTUAL	0.0444	0.0441	0.0003	CFO Other, EFF

Note: Once populated, if this table is longer than two pages, the electrical corporation must append the table.

6.4.3 Other Key Metrics

The electrical corporation must calculate, track, and present on several other key metrics of risk across its service territory. These include, but are not limited to the frequency of:

- **High Fire Potential Index (FPI):** The electrical corporation must specify whether it calculates its own FPI or uses an external source, such as the United States Geological Survey.
- **Red Flag Warning (RFW)**
- **High Wind Warning (HWW)**

For each metric, the frequency of its occurrence within each HFTD tier and the HFRA must be reported in the table below. The metric must be reported in number of overhead circuit mile (OCM) days of occurrence normalized by circuit miles within that area type. For example, consider an electrical corporation with 1,000 OCM in HFTD Tier 3. If 100 of these OCM are under a RFW for one day, and 10 of those OCM are under a RFW for an additional day, then the average RFW-OCM per OCM would be:

$$\frac{RFW_OCM}{OCM} = \frac{(100 \times 1 + 10 \times 1)}{1000} = 0.1$$

This metric represents the average RFW-OCM experienced by an OCM within the electrical corporation’s service territory within HFTD Tier 3. If the metric is continuous (such as FPI), the report should include a note stating the threshold used to select high values. Table 6-6 provides a template for reporting the required information.

SCE provides the required information in Table 6-6 below.

Table 6-6 - Summary of Key Metrics by Statistical Frequency

Metric	Non-HFTD	HFTD Tier 2	HFTD Tier 3	Non-HFRA	HFRA
FPI-OCM/ OCM	0.21	7.99	2.66	0.21	4.91
RFW-OCM/ OCM	0.41	0.63	1.73	0.41	1.27
HWW-OCM/ OCM	1.57	2.71	4.29	1.57	3.62

Below SCE provides an explanation of how it calculated these values.

High Fire Potential Index (FPI)

The electrical corporation must specify whether it calculates its own FPI or uses an external source, such as the United States Geological Survey.¹⁰⁵

¹⁰⁵ United States Geological Survey Fire Danger Map and Data Products Web Page (accessed Oct. 27, 2022): <https://firedanger.cr.usgs.gov/viewer/index.html>.

SCE calculates its Fire Potential Index (FPI) by using weather and fuel (vegetation) conditions which include sustained wind speed, dew point depression (dryness of the air), the state of green-up or curing of the annual grasses, live fuel moisture, and dead fuel moisture. The FPI also considers fuel loading, which is the amount of vegetation on the ground. Calculations were based on circuit-level forecast data of FPI for 2022. For additional detail on SCE's FPI calculation, please see Section 8.3.6.

Red Flag Warning (RFW)

Red Flag Warning (RFW) circuit-mile days are based on all overhead (OH) distribution and transmission circuits that traverse through National Weather Service (NWS) Fire Weather Zones (FWZ) from the historical database of RFW events from the NWS in the Iowa State University archive of NWS watch/warnings.

The OH lengths of distribution and transmission circuits are calculated within each FWZ polygon (the FWZ is divided geospatially into over approximately 1,000 polygons) and are then multiplied by the number of days (or fraction of days) that a particular polygon had an RFW in effect.

The annual circuit mile days are calculated by summing all circuit mile days for all FWZ that occurred within the calendar year. To determine if a circuit mile is under an RFW warning, SCE intersects the OH distribution and transmission circuits with the RFW FWZ polygons to define circuits or portions of circuits within RFW.

High Wind Warning (HWW)

High Wind Warning (HWW) circuit-mile days are based on all OH distribution and transmission circuits that traverse through the NWS Wind Weather Zone (WWZ) from the NWS and a historical database of HWW events from the NWS in the Iowa State University archive of NWS watch/warnings.

The OH lengths of distribution and transmission circuits are calculated within each WWZ polygon (the WWZ is divided geospatially into approximately 200 polygons) and are then multiplied by the number of days (or fraction of days) that a particular polygon had an HWW in effect. The annual circuit mile days are calculated by totaling all circuit mile days for all WWZ that occurred within the calendar year.

To determine if a circuit mile is under an HWW warning, SCE intersects the OH distribution and transmission circuits with the HWW WWZ polygons to define circuits/portions of circuits within HWW.

6.5 Enterprise System for Risk Assessment

In this section, the electrical corporation must provide an overview of inputs to, operation of, and support for a centralized wildfire and PSPS risk assessment enterprise system. This overview must include discussion of:

- *The electrical corporation's database(s) used for storage of risk assessment data.*
- *The electrical corporation's internal documentation of its database(s).*
- *Integration with systems in other lines of business.*
- *The internal procedures for updating the enterprise system including database(s).*
- *Any changes to the initiative since the last WMP submission and a brief explanation as to why those changes were made. Include any planned improvements or updates to the initiative and the timeline for implementation.*

Overview

SCE provides an overview of its enterprise databases in the sections below.

In Section 6.5.1, SCE provides a description of the three primary enterprise databases for input data in its risk models: SAP, SAS, and GE Smallworld (GESW)/Map 3D.

In Section 6.5.2, SCE describes the various documentation it maintains of the systems. Documentation may vary depending on the use of the system.

In Section 6.5.3, SCE explains that SAP, SAS, and GESW/Map 3D are enterprise-wide databases that are used across SCE and integrated with other lines of businesses.

In Section 6.5.4, SCE discusses its procedures for updating its enterprise databases, which aligns SCE needs along with availability and software provider recommendations.

In Section 6.5.5, SCE provides an overview of major changes to its enterprise systems since its last WMP submission.

6.5.1 Database(s) Used for Storage of Its Risk Assessment Data

SCE uses three primary enterprise databases for input data in its risk models:

- SAP Enterprise Asset Management (SAP EAM)
- SAS
- GE Smallworld (GESW)/Map 3D

These databases are used across the enterprise for various system reporting and analytics, in support of both wildfire and non-wildfire activities. Further detail is provided below.

SAP Enterprise Asset Management (SAP EAM)

SAP EAM maintains information about SCE's physical assets, such as Functional Location (FLOC), equipment type, age, manufacturer, and other characteristics utilized in predictive models and other analytical assessments.

SAS

Various dataset and databases are stored and maintained in SAS to enable enterprise usage of data via structured tables and data queries allowing for advanced analytics and visualizations.

SAS datasets and databases include:

- The Wire Down Database (WDD) reports and tracks wire-down events based on wire-down calls and repair orders across the entire SCE service area.
- The Outage Data Reporting Management System (ODRMS) reports information regarding unplanned outages that affect a single line transformer or more on SCE's grid.

SCE stores its machine learning algorithms, including POI information, within SAS and secure GitHub platforms SharePoint Sites.

In addition, SCE's asset risk model prediction results, as well as some Technosylva consequence information, are housed in SAS tables.

GESW/Map 3D

MAP 3D maintains geographically accurate digital mapping of physical assets at structure locations. GESW is a geo-schematically accurate database that maps the connectivity of linear assets, specifically between structures with equipment to another structure with equipment (i.e., segment data).

Additional Information

Other databases provide input data, such as weather and wind data from SCE weather services (see Section 8.3.5.5), ignition events from the Fire Incident Preliminary Analysis (FIPA) database (See Section 11) and vegetation management information from SCE's Arbora platform (see Section 8.2.4).

SCE is in the process of developing a scalable, cloud-based, and geospatially enabled centralized repository for wildfire information. The Wildfire Safety Data Mart and Portal (WiSDM) is intended to consolidate and harmonize information from disparate datasets into a single common platform. Please see Section 8.1.5 for further information, including changes to the WiSDM system since the 2022 WMP, why those changes were made, and SCE's plans and timelines for the next phase of this enterprise system.

Finally, please see Section 8.1.5 for discussion of databases and enterprise systems related to asset inspections management.

6.5.2 Documentation of Its database(s)

SAP EAM, SAS, and GESW/Map 3D are enterprise-wide systems that are used across SCE. Depending on the use of the systems, operational units may develop and maintain documentation and procedures for their specific use of these systems.

SCE also keeps system documentation of these databases. Below is a description of the documentation SCE maintains for the systems discussed.

SAP EAM

SCE maintains operational procedures for SAP EAM, which also includes the scope of this database. In addition, SCE maintains a system source guide, the functional design specifications, technical design specification, and landscape diagram of SAP EAM.

SAS

SCE maintains an internal job aids and runbooks, that are updated monthly to capture changes to the database. In addition, SCE manages internal documentation of any hot fixes, upgrades, or any patches for the SAS platform.

GESW/Map 3D

SCE also maintains a run book for GESW/Map 3D. In addition, SCE maintains documentation of patches applied, release history, record of upgrades and fixes applied to the database.

SCE also maintains procedures on how asset data is inputted into and revised in SAP EAM, SAS and GESW/Map 3D.

6.5.3 Integration with Systems In Other Lines of Business

As indicated above, the databases SCE uses for input data in its risk models is used across SCE for various wildfire and non-wildfire purposes and integrated with other applications based on data needs and work activity needs. For example, SAP EAM is integrated with asset work orders and customer service applications. In addition, Map3D receives structure and FLOC data from SAP that is updated daily, and receives data for conductors, circuits and multiple device types from GESW.

6.5.4 Internal Procedures for Updating the Enterprise System Including Database(s)

The databases SCE uses for its risk models are used across the enterprise for various purposes, both wildfire and non-wildfire. System updates typically based on SCE needs along with availability and software provider recommendations.

SCE maintains internal procedures on how asset data within SAP EAM, SAS, GESW/Map 3D are updated. Asset data is updated when a change is made to the electrical infrastructure system or when a discrepancy is found between the field and SCE's databases.

6.5.5 Any Changes to the Initiative Since the Last WMP Submission

SCE continues to use the three primary enterprise databases for input data in its risk models. Since SCE's last WMP submission, SCE has updated SAS from v7.1 to v8.3. SAS v8.3 was redesigned to include a modern and flexible user interface that provides a more flexible space to write programs, build process flows, as well as access and browse data.

Since the last WMP submission, SCE has enhanced its POI model to include FIPA ignitions into its calibration process. Previously, SCE only used CPUC reportable ignitions as part of its calibration of probability of ignitions to forecast ignition frequencies. Including FIPA ignitions, which captures ignitions beyond just CPUC reportable ignitions, along with separating between primary and secondary ignitions, allows for more granular forecasts and application of POI to specific ignition events.

For changes related to the databases and systems associated with inspections, vegetation management, weather services, and the WiSDM portal, please see Sections 8.1.5, 8.2.4, 8.3.5.5, and 8.1.5 respectively.

6.6 Quality Assurance and Control

The electrical corporation must document the procedures it uses to confirm that the data collected and processed for its risk assessment are accurate and comprehensive. This includes but is not limited to model, sensor, inspection, and risk event data used as part of the electrical corporation's WMP program. In this section of the WMP, the electrical corporation must describe the following:

- **Independent review:** Role of independent third-party review in the data and model quality assurance
- **Model controls, design, and review:** Overview of the quality controls in place on electrical corporation risk models and sub-models

6.6.1 Independent Review

The electrical corporation must report on its procedures for independent review of data collected (e.g., through sensors or inspections) and generated (e.g., through risk models and software) to support decision making. In this section of the WMP, the electrical corporation must provide the following:

- **Independent reviews:** *The electrical corporation’s procedures for conducting independent reviews of data collection and risk models.*
- **Additional review triggers:** *The electrical corporation’s internal procedures to identify when a third-party review is required beyond the routinely scheduled reviews.*
- **Results, recommendations, and disposition:** *The results and recommendations from the electrical corporation’s most recent independent review of its data collection and risk models. This includes the electrical corporation’s disposition of each comment.*
- **Routine review schedule:** *The electrical corporation’s routine review schedule.*

The electrical corporation must enter each accepted recommendation from independent review into its action tracking system for resolution (assignment of responsibility, development of technical plan, schedule for development and deployment, etc.) in accordance with the requirements discussed in Section 11.

Independent Reviews

In 2022, SCE engaged a third-party independent evaluator to review its RSE development process for the 2023 WMP and the accuracy of its RSE. In addition, SCE engaged a third-party consultant to review its existing technical documentation of its risk models and develop standardized templates for technical and process documentation of its risk models. Please see Appendix D: Areas for Continued Improvement for further details (Areas for Continued Improvement # SCE-22-22 Third Party Confirmation of RSE Estimates).

Although SCE does not currently conduct external third-party independent reviews of data collected and risk models, SCE has an internal review process for its collected data and risk models.

Data Collection Review Activities

SCE has an extensive inspection program that is described in Section 8.1.3. Results from these inspections are validated and integrated into SCE’s risk models in several ways. If the inspection identifies a discrepancy between what is observed in the field and what is recorded in SCE’s databases (primarily SAP), SCE will update the information. Repairs and remediations that result from inspections are also integrated into SCE’s asset database, and depending on the nature of the data, may be used in calculations such as POI. SCE’s QA/QC programs, described in Section 8.1.6, provide assurance on the quality of the inspections themselves.

As discussed in Section 11, SCE analyzes ignitions through its Fire Investigation Preliminary Assessment (FIPA) program. Data and results from these analyses are used as both a data source for modeling and for trend analyses. The FIPA process supports data quality standards through applying consistent methodology and classifications to improve SCE’s ability to use ignition data for wildfire risk analysis.

Data Input Review Activities

To prepare and organize its data for its risk models, SCE uses a combination of automated and manual checks of its data. SCE uses automated scripts to validate that unique data are not duplicative, data does not have nonstandard values, and checks for excessive null values. SCE also performs manual validation of the data set by comparing the current data set to previous data sets to check for discrepancies, using a Sankey diagram¹⁰⁶ to display the data flows, and appending data from alternative sources if data is missing.

Validation of Risk Models for Transmission Assets

In 2022, SCE began developing a more formalized validation process of its risk models for transmission using field input. The validation compared assets that SCE risk model identified as risky against assets identified as risky by the Transmission Senior Patrolman. Any variance between the two assessments were further analyzed for the cause of the difference in result and update its data or risk model as needed.

Another avenue to facilitate risk model validation is included in the Transmission survey that is completed during the high-fire risk informed (HFRI) detailed inspection. SCE includes a set of questions to allow the inspector to provide information if they support or disagree with the riskiness of the asset being inspected. This feedback is available to SCE to review and assess if an update to the risk models are needed. Starting in 2023, SCE will include a similar set of risk assessment questions in the Distribution HFRI detailed inspection survey form to allow the inspectors to provide feedback.

Asset Risk Governance Working Team

SCE's Asset Risk Governance Working Team (ARGWT) provides oversight on risk identification, quantification, and mitigation of risk models. As issues requiring asset risk management arise, the working team identifies helps to organize an initiative team which may include subject matter experts from across SCE.

The ARGWT working team is responsible for evaluating issues related to asset risks. This team is expected to study issues, considering all stakeholders internal and external, and to make recommendations to the sponsor team. The recommendations of the working team consider the specific safety, reliability, and financial impacts of each risk model as appropriate to the relevant risk.

Additional Review Triggers

SCE's internal Enterprise Risk Management team provides oversight responsibility for risk modeling more broadly. ERM is responsible for ensuring the ARGWT is providing recommendations to the sponsor team that are consistent and defensible, while using risk-based analysis where appropriate and practical.

ERM, along with SCE's Audit Service Department (ASD), provides recommendations to the ARGWT as to when additional third-party review is warranted. These recommendations may be based on the technical complexity of the subject matter or at the request of SCE management or other external stakeholders. Generally, given that the intent of these third-party reviews is to foster model improvement, the results of these reviews are kept confidential until their recommendations can be

¹⁰⁶ A Sankey diagram is a visualization tool that shows how data or variables flow between sources or databases.

reviewed and implemented.

Results, Recommendations, and Disposition

SCE discusses the results and recommendations of the third-party independent evaluator's review of its RSE results in ACI SCE-22-22 Third Party Confirmation of RSE Estimates in Appendix D: Areas for Continued Improvement.

After SCE's third-party consultant reviewed its technical documentation for its risk models, the third-party consultant provided feedback on compliance with OEIS guidelines and new standardized documentation templates in alignment with OEIS guidelines, which includes model specification, sensitivity testing, benchmarking and data and input quality. These templates are used to support detailed documentation in Appendix B: Supporting Documentation for Risk Methodology and Assessment. Going forward, SCE will use these documentation templates for its risk models, including modelling, validation, and processes.

Routine Review Schedule

SCE currently does not have a routine third-party review schedule. SCE plans to develop criteria for an external third-party review of the Wildfire models. See Section 6.7.2.3 for additional details.

6.6.2 Model Controls, Design, and Review

An electrical corporation's risk modeling approaches are complex, with several layers of interaction between models and sub-models. If these models are designed as a single unit, it can be difficult to evaluate the propagation of small changes in assumptions or inputs through the models. The requirements in this section are designed to facilitate the review of models by the stakeholders and Energy Safety, and to allow for more comprehensive retrospective analysis of failures in the system.

The electrical corporations must report on its risk modeling software's model controls, design, and review in the following areas:

- **Modularization:** *The electrical corporation must report on the degree to which its software architecture is sufficiently modular to track and control changes and enhancements over time. At a minimum, the electrical corporation must report if it has separate modules to evaluate each of the following:*
 - *Weather analysis*
 - *Fire behavior analysis*
 - *Seasonal vegetation analysis*
 - *Equipment failure*
 - *Exposure and vulnerability analysis*
- **Reanalysis:** *The electrical corporation must describe its capability to provide the results of its risk model based on the operational version of the software (including code and data) on a specific historic day.*

- **Version control:** *The electrical corporation must report on how it conforms to industry standard practices in version controlling its risk model and sub-models. At a minimum, the electrical corporation is expected to report on:*
 - *Models and software version controls aligned with industry standard programs, procedures, and protocols*
 - *Version control of model input data, including geospatial data layers*
 - *Procedures for updating technical, verification, and validation documentation.*

Modularization

SCE’s models are designed to be modular so that SCE can track and change inputs within the model. Table SCE 6-05 provides a summary of which models contain separate modules for the attributes identified.

Table SCE 6-05 - Risk Models Containing Separate Modules

	Probability of Ignition	Wildfire Consequence (Technosylva)
Weather Analysis	No. Weather variables are not contained in a separate module for this model. Weather variables are attributes within the machine learning model.	Yes. Weather scenarios is modular in this model.
Fire Behavior Analysis	Not applicable, this model does not analyze or consider this element.	Yes. Fire Behavior Analysis is modular in this model.
Seasonal Vegetation Analysis	No. Vegetation variables are not contained in a separate module, they are attributes within the model.	Yes. Vegetation (i.e., fuel and fuel moisture) is modular in this model.
Equipment Failure	No. Equipment variables are not contained in a separate module for this model. They are attributes within the machine learning model.	Not applicable, this model does not analyze or consider this element.
Exposure and Vulnerability Analysis	Not applicable, this model does not analyze or consider this element.	Yes. HFRA (exposure) and AFN/NRCI (vulnerability) are separate components of this model

Reanalysis

SCE updates its risk analysis annually and can provide previous yearly scenario runs as needed. Iterations of the risk model are reanalyzed with each refresh of the likelihood or consequence models as data becomes available. Outputs of these models are archived by date but are not intended to produce POI risk estimates for a specific historic date. The Wildfire Consequence model and IWMS analysis is limited to the 444 weather scenarios within the current model.

Version Control

Table SCE 6-06 - Version Control

Models and software version controls aligned with industry standard programs, procedures, and protocols	
Probability of Ignition	Yes. SCE maintains documentation and model information changes as new assets and features are updated in the model. Code commentary is updated as versions are changed.
Wildfire Consequence	Yes. SCE's vendor maintains documentation and model information consistent with Energy Safety's guidelines.
Version control of model input data, including geospatial data layers	
Probability of Ignition	Yes. SCE reassesses and maintains POI models on an annual basis.
Wildfire Consequence	Yes. SCE reassesses and maintains wildfire consequence models on an annual basis.
Procedures for updating technical, verification, and validation documentation	
Probability of Ignition	SCE maintains documentation detailing changes, enhancements, and improvements made to our POI model. SCE is in the process of updating its documentation and is evaluating various standards to utilize to further refine and standardize our documentation.
Wildfire Consequence	Yes. SCE's vendor maintains this information consistent with industry standard practice.

6.7 Risk Assessment Improvement Plan

A key objective of the WMP review process is to drive year-over-year continuous improvement. In this section, the electrical corporation must provide a high-level overview of its plan to improve both programmatic and technical aspects of its risk assessment in at least four key areas:

- **Risk assessment methodology:** Wildfire and PSPS risk assessment methodology and its documentation, including both quantitative and qualitative approaches
- **Design basis:** Justification of design basis scenarios used to evaluate the risk and its documentation
- **Risk presentation:** Presentation of risk to stakeholders, including dashboards and statistical assessments
- **Risk event tracking:** Tracking and reconstruction of risk events and integration of lessons learned

6.7.1 Overview

SCE discusses how its risk assessment improvement plan will address the four key areas below. SCE provides further details of its risk improvement plan in Section 6.7.2.

Risk Assessment Methodology

SCE has three planned improvements for SCE's risk assessment methodology. SCE plans to further improve its Wildfire Consequence model, POI model, and establish an independent review program for its wildfire risk assessment models.

Design Basis

SCE plans to evaluate potential improvements and approaches to wind scenario modeling based on updated weather data which would be used in the engineering and design of SCE’s infrastructure. See Section 6.7.2.4 for SCE’s discussion of this planned improvement.

Risk Presentation

SCE plans to increase automation for its process to validate risk assessment data and to develop data visualization dashboard of model outputs so that SCE can further improve its QC methods. This will also include further documentation of datasets and sources. See Section 6.7.2.5 for SCE’s discussion of this planned improvement.

Risk Event Tracking

SCE plans to use planned improvements to its FIPA database to improve its risk calculations by reflecting a larger range of historical events in forecasts. See Section 6.7.2.6 for SCE’s discussion of this planned improvement.

The overview must consist of the following information, in tabulated format:

- **Key area:** *One of the four key areas identified above*
- **Title of proposed improvement:** *Brief heading or subject of the improvement*
- **Type of improvement:** *Technical or programmatic*
- **Anticipated benefit:** *Summary of anticipated benefit and any other impacts of the proposed improvement*
- **Timeframe and key milestones:** *Total timeframe for undertaking the proposed improvement and any key milestones*

Table 6-7 provides an example of the minimum acceptable level of information.

Table 6-7 - Utility Risk Assessment Improvement Plan

Key Risk Assessment Area	Problem Statement	Proposed Improvement	Type of Improvement (technical and/or programmatic)	Expected Value Add/Anticipated Benefit	Timeframe and Key Milestones
Risk Assessment Methodology	SCE seeks continuous improvement in the Wildfire Consequence model.	Transition from version 6.0 to 7.1 risk model	Technical	Updated fuel layer; updated fire propagation algorithm in timber fuel types; updated ignition point spacing.	SCE will incorporate changes in mid-2023.
Risk Assessment Methodology	SCE does not have a predictive model specific to secondary conductor.	Develop and evaluate an additional predictive model for secondary conductor to have more granular data	Technical	Increased granularity in outage and ignition calibration for primary versus secondary	Q2 2023 to evaluate applicability of Secondary Model to mitigation strategies to address secondary ignition subdrivers in POI model.

Key Risk Assessment Area	Problem Statement	Proposed Improvement	Type of Improvement (technical and/or programmatic)	Expected Value Add/Anticipated Benefit	Timeframe and Key Milestones
		for equipment related failures for secondary conductor that contribute to POI subdrivers.		conductor will improve model prediction and more accurately apply mitigations and risk calculations.	
Risk Assessment Methodology	SCE does not currently have an established independent review program.	Develop a strategy and roadmap to develop a systematic approach for an independent external third-party review.	Technical and Programmatic	Improve confidence in methods and alignment with industry practice.	End of 2023: SCE will develop criteria for an external third-party review of the Wildfire models and initiate a Request for Proposal (RFP) to hire an appropriate party for the validation. End of 2024: Wildfire models validated by an external third-party.
Design Basis	SCE will evaluate potential improvements and approaches to wind scenario modeling based on updated wind data.	Wind data will be used to update pole loading specifications. These pole loading data will be used to inform design scenarios.	Technical	Potential to improve wind modeling and associated downstream design scenarios to up to date information.	Anticipate Q4 2023 to update weather data, and Q4 2025 to process information with selected vendor.
Risk Presentation	Increase automation in QC processes for data used in risk analysis.	To advance its QC methods for data used in risk modelling, SCE's data engineers will streamline data, automate QC processes and develop data visualization dashboards.	Technical	Automated QC'd datasets may enable future automation of model refreshes, and technical documentation of datasets and sources	SCE will incorporate data visualization dashboards of model outputs in Q4 2023. Detailed technical documentation of SCEs risk models will be completed by Q4 2023.
Risk Event Tracking	SCE seeks to use a larger data set of ignitions to further increase robustness of ignition likelihood calculations.	In 2022, SCE began calibrating its ignition frequency forecast with all SCE identified ignitions tracked in its FIPA database, as opposed to just CPUC reportable ignitions. SCE is planning FIPA database improvements in 2023 to improve data collection and	Technical and Programmatic	As SCE's FIPA database becomes more robust, SCE anticipates the distribution of ignition likelihoods will improve in its risk calculations by reflecting a larger number of historical events.	Q1 2023 to transition input data from existing process to incorporating detailed ignition data from the FIPA database.

Key Risk Assessment Area	Problem Statement	Proposed Improvement	Type of Improvement (technical and/or programmatic)	Expected Value Add/Anticipated Benefit	Timeframe and Key Milestones
		processes for root cause analysis.			

6.7.2 Narratives for Individual Improvements

In addition, the electrical corporation must provide a concise narrative of its proposed improvement plan (maximum of five pages per improvement) summarizing:

- **Problem statement:** Description of the current state of the problem to be addressed
- **Planned improvement:** Discussion of the planned improvement, including any new/novel strategies to be developed and the timeline for their completion
- **Anticipated benefit:** Detailed description of the anticipated benefit and any other impacts of the proposed improvement
- **Region prioritization (where relevant):** Reference to risk-informed analysis (e.g., local validation of weather forecasts in the HFTD) demonstrating that high-risk areas are being prioritized for continued improvement
- Supporting documentation (as necessary)

6.7.2.1 Transition SCE's Wildfire Consequence Model from version 6.0 to 7.1

Problem statement: SCE seeks continuous improvement in the Wildfire Consequence model by refreshing underlying assumptions and enhancing modeling techniques.

Planned improvement: A significant improvement of this refreshed model is the expansion of the fuel layer from only including fuels in HFRA, plus a 20-mile buffer, to including fuels across SCE's service territory, plus a small buffer into adjoining jurisdictions. Other minor improvements in this model refresh include improved algorithms to better represent wildfire propagation in timber fuel locations, and better aligned ignition points locations in proximity to overhead utility electrical assets.

Anticipated benefit: 1) Expanding the fuel layer will allow SCE to perform ignition simulations for the entirety of the service territory. This enhancement will assist with HTFD boundary assessment, as well as other anticipated follow-on studies. 2) Fire propagation enhancements will better represent the first burning period associated with timber fuel types. 3) Improving the spacing of ignition points will improve the granularity of ignition simulation events with respect to locations of complex topography.

Region prioritization: SCE's HFRA.

6.7.2.2 Asset Specific Predictive Models

Problem statement: SCE does not have a predictive model specific to secondary conductor.

Planned improvement: In 2023, SCE will develop and evaluate an additional predictive model for secondary conductor to more accurately identify equipment related failures for secondary conductor that contribute to POI sub-drivers. This will differentiate between primary and secondary conductor failures (both EFF and CFO).

Anticipated benefit: Increased granularity in outage and ignition calibration for primary versus secondary conductor will improve model prediction (separate models for primary vs secondary) and risk calculations.

Region prioritization: SCE's HFRA.

6.7.2.3 Third-Party Independent Review Strategy and Roadmap

Problem statement: SCE does not currently have an established independent third-party review program.

Planned improvement: In 2023, SCE will establish a set of criteria to determine when an external third-party validation is needed and required. After establishing the governance process, SCE will issue an RFP before the end of 2023 to facilitate the selection of the appropriate party to conduct the validation. The wildfire risk models will be validated by the end of 2024.

Anticipated benefit: SCE recognizes that an external review of wildfire risk models will provide additional confidence to external stakeholders on the fidelity and methods deployed in SCE's wildfire risk models. SCE will also consider and incorporate feedback from the external third-party review into its future Wildfire risk modeling roadmap.

Region prioritization: SCE's HFRA.

6.7.2.4 Potential Improvement to Wind Modeling and Associated Scenarios

Problem statement: SCE will evaluate potential improvements and approaches to wind scenario modeling based on updated weather data.

Planned improvement: SCE currently owns a gridded wind and weather historical dataset covering the SCE territory spanning approximately the last 40 years. Since the development of this dataset, SCE has deployed machine learning forecast capabilities to remove biases in gridded wind and weather data leveraging SCE's growing weather station network. This improvement will apply the same machine learning correction techniques to the gridded historical wind and weather data, which will result in more accurate characterization of wind and weather design scenarios.

Anticipated benefit: Weather data will be used to in the analysis of a refreshed pole loading study. This study will inform SCE's design scenarios used in the SCE wildfire modeling.

Region prioritization: SCE's HFRA.

6.7.2.5 Data Validation Methods and Develop Data Visualization Dashboards

Problem statement: In SCE's predictive models, SCE uses data from various sources. To validate the data, SCE QC's the data prior to integrating it into the predictive model.

Planned improvement: By the end of 2023, SCE will develop dashboards for visualization of model outputs and establish procedures for automation of datasets for future integration into automated predictive models.

Anticipated benefit: Streamlining data sources, automating methods to validate data sets and developing data visualization dashboards will enhance SCE modeling capabilities. These enhancements may enable SCE to automate model refreshes more frequently.

In addition, the planned improvements will enable SCE to develop more detailed technical documentation in alignment with OEIS Guidelines for its data sources by establishing defined data marts and data dictionaries associated to the data sources for easier reference and documentation.

Region prioritization: SCE's HFRA.

6.7.2.6 Enhanced Machine Learning Algorithms Application for POI Forecasts

Problem statement: SCE plans to improve its application of the POI model by using FIPA database improvements to enhance distribution of POI for risk calculations.

Planned improvement: SCE's FIPA database tracks the trends of ignitions and ignition drivers. Prior to 2022, SCE calibrated its probability of ignition using CPUC reportable ignitions. In 2022, SCE updated its ignition frequency calculation to use all SCE identified ignitions tracked in its FIPA database, along with separating between primary and secondary ignitions, which allows for more granular forecasts and application of POI to specific ignition events.

Please see Section 11 for further discussion of the FIPA database and planned improvements.

Anticipated benefit: SCE anticipates that the FIPA database planned improvements will improve the distribution of ignition likelihoods in its risk calculations by more reflecting a more extensive record of historical events in its future forecasts.

Region prioritization: SCE's HFRA.

6.7.3 Maturity Advancement

SCE continually seeks alignment with government and industry organizations and practices and continues to look for opportunities to improve risk assessment maturity over time.

The activities discussed in this section could lead to Risk Assessment and Mitigation maturity advancements. Below is a summary of broader anticipated maturity improvements over the WMP period that supplement the objectives outlined at the beginning of Sections 8 and 9.

Table SCE 6-07 - Risk Assessment Maturity Improvements

Capability Name	Projected Maturity Improvements
Statistical Weather, Climate, and Wildfire Modeling	Improvements include evaluating new model inputs and beginning to evaluate impacts of climate change on vegetative species.
Calculation of Wildfire and PSPS Hazard and Exposure to Societal Values	Improvements include new outputs in wildfire and PSPS models.
Calculation of Community Vulnerability to Wildfire and PSPS	Improvements include maintaining version control of community vulnerability to wildfire and PSPS models and new model inputs.
Risk-informed Wildfire Mitigation Strategy	Collaboration with external stakeholders on planned risk reduction efforts.
Calculation of Risk and Combination of Risk Components	Improvements include further documentation of risk models, maintaining version control of models and further developing processes for third-party review.

7 WILDFIRE MITIGATION STRATEGY DEVELOPMENT

In this section of the WMP, the electrical corporation must provide a high-level overview of its risk evaluation and process for deciding on a portfolio of mitigation initiatives to achieve maximum feasible¹⁰⁷ risk reduction and that meet the goal(s) and plan objectives stated in Sections 4.1–4.2, and wildfire mitigation strategy for 2023–2025. Sections 6.1 and 6.2 below provide detailed instructions.

7.1 Risk Evaluation

7.1.1 Approach

In this section of the WMP, the electrical corporation must provide a brief narrative of its risk evaluation approach, based on the risk analysis outcomes presented in Section 6, to help inform the development of a wildfire mitigation strategy that meets the goal(s) and plan objectives stated in Sections 4.1– 4.2.

The electrical corporation must describe the risk evaluation approach in a maximum of two pages, inclusive of all narratives, bullet point lists, and any graphics.

IWMS is SCE’s holistic approach to developing portfolios of effective and complementary mitigations and deploying them in a manner that focuses on the areas of greatest risk. IWMS incorporates additional factors not currently present in the MARS Framework (e.g., egress limitations, SME judgment), which help augment SCE’s analysis of risk impacts from these factors at local levels. By following its IWMS, SCE has a more complete depiction of the full impacts of a wildfire in certain locations and thus can better prioritize and scope mitigations to areas where ignitions can have the greatest impact.

The first stage (Initial Risk Categorization) of IWMS is to categorize all of SCE’s overhead distribution circuit segments in HFRA into one of three tranches utilizing various data sources and fire science: Severe Risk Area, High Consequence Area, and Other HFRA.

The next stage (Review and Revise) involves a team of SMEs from SCE’s Wildfire Safety, Fire Science, Enterprise Risk Management, and Engineering groups reviewing, refining, and revising the initial output from the previous step using inspection photographs, satellite imagery, maps, and other data sources to consider local conditions and features that may alter the initial designation.

After each overhead distribution circuit segment has a risk tranche designation, SCE assigns to it the corresponding portfolio of mitigations. For each risk tranche, SCE has determined a portfolio of complementary mitigations appropriate for its risk level. In Severe Risk Areas, the threat to lives and property is elevated to such an extent that SCE has determined that for public safety reasons it is prudent to not just significantly reduce ignition risk expeditiously but minimize it in the long term to the extent practicable. In High Consequence Areas, SCE’s strategy focuses on mitigating the majority of significant ignition risk drivers. In Other HFRA, SCE will replace retired or damaged bare wires with covered conductor and continue mitigations that have relatively low incremental costs or are dictated by compliance requirements or local conditions. Transmission in SCE’s HFRA receives its own separate set of mitigations, and as discussed in Section 8.1.2.12.1, will be evaluated further to determine the potential additional mitigations. During the Review and Revise stage, the team of SMEs will make

¹⁰⁷ “Maximum feasible” means, in accordance with Public Utilities Code section 326(a)(2), capable of being accomplished in a successful manner within a reasonable period of time, taking into account economic, environmental, legal, social, and technological factors.

individualized adjustments to portfolios for specific segments if local conditions favor doing so.

Mitigations for each portfolio are selected based on a variety of factors, including effectiveness, risk drivers they mitigate, cost, and time to deploy. SCE uses the MARS Framework to help it compare mitigations and alternatives to each ignition driver and sub-driver on the basis of risk reduction and cost effectiveness.

Some mitigations are deployed only where certain conditions exist, such as tree attachment removals or LSI remediations. Other mitigations, such as undergrounding, require a separate feasibility review, which is conducted by a team of planners and engineers. This feasibility review considers issues impacting constructability, such as local terrain and accessibility. If a mitigation is found to be infeasible, the Review and Revise team will recommend an alternative mitigation taking into account local conditions.

Once segments are assigned a portfolio of mitigations, the deployment of each individual mitigation is prioritized using a combination of risk and operational factors. Generally, mitigations do not have to be prioritized against each other, as they utilize different resources (e.g., hardening uses different resources than inspections, which use different resources than vegetation management) or have different timelines that can run in parallel (e.g., TUG and CC projects have long timelines and SCE can deploy other projects concurrently, such as fast-acting fuses or FC-capable hardware).¹⁰⁸

Once mitigations are deployed, SCE uses the MARS framework to calculate and quantify remaining overall utility risk from both wildfire and PSPS.

Through the IWMS, SCE identifies the varying levels of wildfire and PSPS risk in its HFRA and then deploys complementary and cost-effective portfolios of mitigations that are prioritized in a risk-informed manner. Please see Figure SCE 7-01 for more information on IWMS.

¹⁰⁸ SCE started using IWMS to prioritize mitigation selection and scope beginning 2021. Due to the long lead time for planning and construction, mitigations scoped with IWMS will generally not be in service until 2023 or later; targeted undergrounding scoped using IWMS will generally not be in service until 2024. However, as noted in Section 6.2.1, SCE performed a review of inflight scope to align to the IWMS as much as possible and practical.

Figure SCE 7-01 - IWMS Schematic

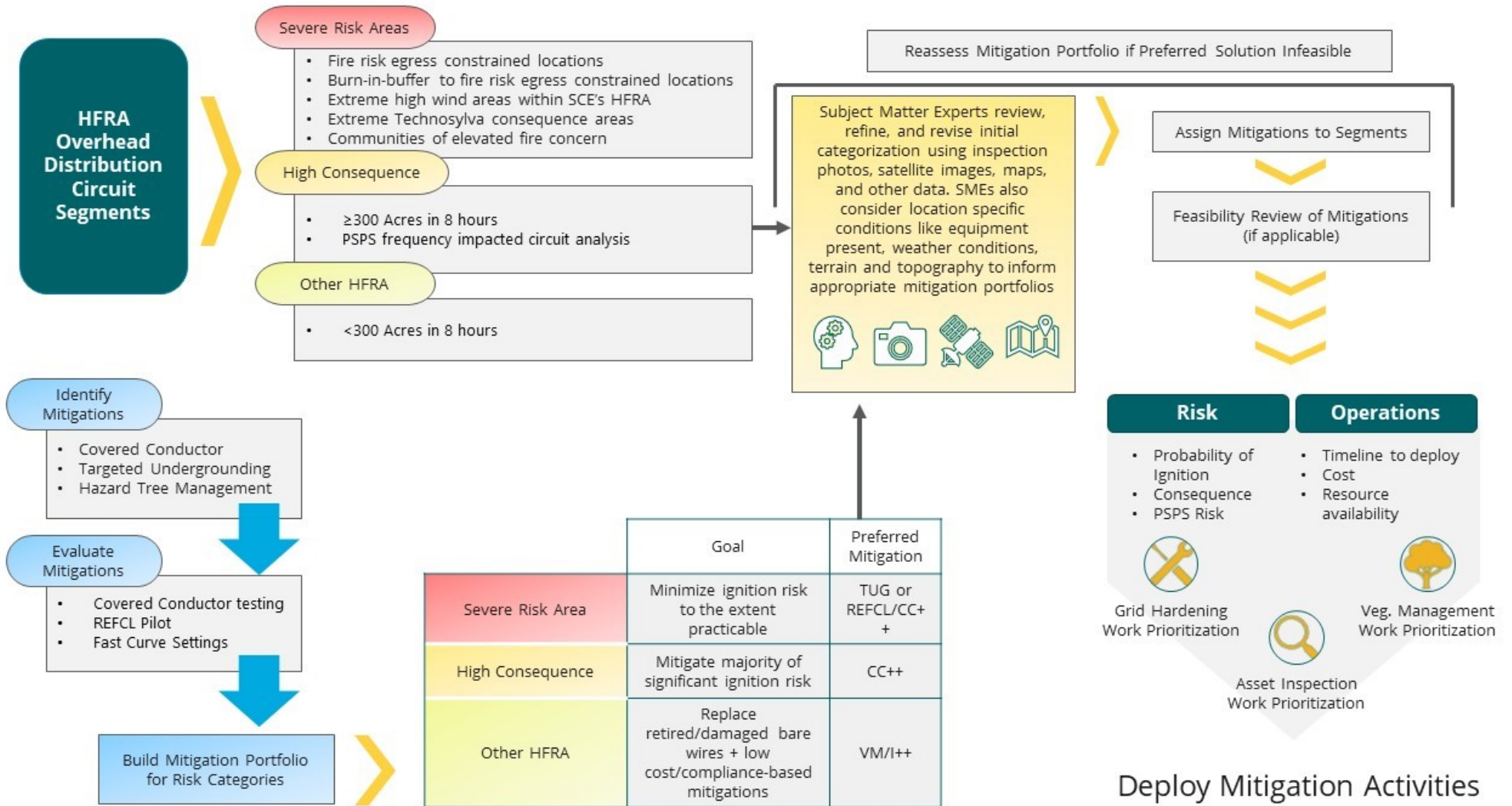

7.1.2 Key Stakeholders for Decision Making

In this section, the electrical corporation must identify all key stakeholder groups that are part of the decision-making process for developing and prioritizing mitigation initiatives. Table 7-1. Example of Stakeholder Roles and Responsibilities in the Decision-Making Process provides an example of the required information. At a minimum, the electrical corporation must do the following:

- Identify each key stakeholder group (e.g., electrical corporation executive leadership, the public, state/county public safety partners)
- Identify the decision-making role of each stakeholder group (e.g., decision maker, consulted, informed)
- Identify method of engagement (e.g., meeting, workshop, written comments)

The electrical corporation must also describe how it communicates decisions to the identified key stakeholders.

Table 7-1 summarizes the various stakeholders that SCE meets with to gather feedback and to communicate wildfire and PSPS decisions.

Table 7-1 - Stakeholder Roles and Responsibilities in the Decision-Making Process

Stakeholder	Stakeholder Point of Contact	Electrical Corporation Point of Contact	Stakeholder Role	Engagement Methods
SCE Executive Leadership	Director of Wildfire Safety	Director of Wildfire Safety	<ul style="list-style-type: none"> • Provides guidance and decision making on wildfire mitigation near and long-term planning • Informed on wildfire mitigation execution status • Informed and provides guidance on strategy/risk prioritization methodologies 	Weekly Internal Meetings

Stakeholder	Stakeholder Point of Contact	Electrical Corporation Point of Contact	Stakeholder Role	Engagement Methods
Office of Energy Infrastructure Safety (OEIS or Energy Safety)	OEIS Deputy Director, Director of OEIS	Managing Director, Regulatory Relations	<ul style="list-style-type: none"> • Defines WMP requirements • Participates and provides guidance in working groups • Reviews wildfire mitigation plan submissions and provides feedback, areas for continuous improvement, and issues approval or denial of plan 	<ul style="list-style-type: none"> • Weekly meetings following submission of WMP • Biweekly participation in working groups • Written comments • Ad hoc meetings
California Public Utilities Commission (CPUC)	CPUC Staff	Managing Director, Regulatory Relations	<ul style="list-style-type: none"> • Approves WMP requirements; provides guidance and review of CPUC-mandated risk analysis used to inform wildfire and PSPS mitigations; authorizes cost recovery for wildfire and PSPS mitigations in consideration of risk reduction, cost efficiency, affordability, and other factors. 	<ul style="list-style-type: none"> • Ad hoc meetings • Comments, workshop, CPUC rulings and decisions
Local Governments (including city councils, county boards and tribal governments)	Various local representatives	Director, Local Public Affairs	<ul style="list-style-type: none"> • Provides feedback on implementation of SCE's wildfire initiatives • Informed on SCE's strategy as 	Ad hoc meetings

Stakeholder	Stakeholder Point of Contact	Electrical Corporation Point of Contact	Stakeholder Role	Engagement Methods
			presented in WMP	
Local Fire Agencies (includes Cal FIRE)	Various Southern California Fire Chiefs	Managing Director, Regulatory Relations Managing Director, Business Resiliency	<ul style="list-style-type: none"> Provides guidance on wildfire mitigations including Fire Suppression Informed on SCE's strategy as presented in WMP 	Ad hoc meetings
Cal OES	Assistant Director of Response Operations	Managing Director, Regulatory Relations	<ul style="list-style-type: none"> Provides statewide guidance on wildfire mitigations including PSPS Participates on the board of the AFN Council 	Ad hoc meetings
Access and Function Needs (AFN) Advisory Council	Various	VP Customer Programs and Services	Raises awareness of the needs of our AFN populations and to collaborate on initiatives that will advance communications, resources and support for AFN populations, all aimed at PSPS impact mitigation	Monthly meetings (or more frequent as necessary)
Public Advocates Office and other stakeholders	Various	Various	Participates in Energy Safety-led working groups and provides input.	Pursuant to working group schedules.

Stakeholder	Stakeholder Point of Contact	Electrical Corporation Point of Contact	Stakeholder Role	Engagement Methods
Wildfire Safety Advisory Board	Board Members	Various	Advises OEIS on requirements for WMPs, holds workshops, provides comments on advisory opinions.	Comments, public meetings.

SCE executive leadership is actively involved in directing all aspects of the WMP process. After SCE’s program leads, in conjunction with its Wildfire Strategy and Enterprise Risk Management teams, select mitigations and decide on scope for each one pursuant to the processes described below in Sections 7.1.3 and 7.1.4, they engage with their executive leadership to review and approve their decisions. Then SCE’s executive leadership reviews the decisions with the program leads and the Wildfire Strategy team and then either approves or recommends changes.

SCE executive leadership is also regularly briefed on WMP status, including progress of meeting the mitigation goals set in the WMP. SCE’s executive team provides guidance and decisions on near- and long-term wildfire and PSPS mitigation strategies, risk analyses, planning activities, resource allocation, and compliance matters. On a monthly basis there is a mandatory report out on the progress of the various wildfire and PSPS mitigations presented in the WMP to senior executives. As new strategy/risk prioritization methodologies are introduced they are also brought forward and reviewed by SCE’s senior executives at standing weekly and biweekly wildfire mitigation forums.

Internal wildfire safety meetings are held weekly at a minimum, and more frequently as needed to advance strategic wildfire mitigation and PSPS planning and execution.

SCE meets routinely with key stakeholders to gather feedback and to communicate decisions related to important wildfire-related information, such as short- and long-term wildfire and PSPS mitigation plans as discussed in the WMP filings. SCE engages with various governmental regulatory agencies, including Energy Safety and the California Public Utilities Commission (CPUC).

SCE adheres to guidelines established by Energy Safety in developing the WMP. After the WMP is filed, SCE responds to discovery requests issued by Energy Safety and other Stakeholders. SCE also participates in regular joint-utility working groups meetings mandated by Energy Safety on topics such as risk modeling, grid hardening, and vegetation management.

SCE engages with the CPUC on matters pertaining to wildfire and PSPS policies, cost recovery, and other areas within the CPUC’s jurisdiction. The CPUC reviews SCE’s requests to recover the costs to implement our WMP and provides funding authorization based on those reviews. The CPUC will also review these requests to ensure adherence with CPUC policies and practices required through various wildfire, risk, and PSPS-related proceedings managed by the CPUC. SCE will hold meetings with the CPUC, largely on an ad hoc basis, with a representative from SCE’s Regulatory Affairs department and requisite SMEs.

SCE meets with local governments including city councils, county boards and tribal governments to share strategic decisions made that will impact the local area, and to gather feedback on SCE’s wildfire programs

and community needs to understand what is working well and to identify areas of improvement to incorporate into wildfire planning. For example, SCE endeavors to minimize the impacts of outages required to perform wildfire mitigation and other construction work by working with local governments and communities to alleviate outage impacts. SCE also engages with local and state agencies, large commercial and industrial customers, and representatives from critical infrastructure facilities to highlight SCE’s wildfire mitigation priorities and PSPS-related work.

Additionally, SCE participates in the AFN Advisory Council, which meets at least monthly to explore wildfire and PSPS risk mitigation strategies, policies, and procedures specific to Access and Functional Needs (AFN) customers. SCE will also relay specific details related to programs or initiatives targeted to further assist AFN customers.¹⁰⁹

7.1.3 Risk-Informed Prioritization

In making decisions risk mitigation, the electrical corporation must identify and evaluate where it can make investments and take actions to reduce its overall utility risk. The electrical corporation must develop a prioritization list based on overall utility risk.

In this section, the electrical corporation must:

- *Describe how it selects areas of its service territory at risk from wildfire for potential mitigation initiatives, including, at a minimum, the following:*
 - *Geographic scale used in prioritization (i.e., regional, circuit, circuit segment, span, asset)*
 - *Statistical approach used to select prioritized areas (e.g., areas in top 20 percent for risk, areas in top 20 percent for consequences)*
 - *Feasibility constraints (e.g., limitations on data resolution, jurisdictional considerations, accessibility)*

Present a list that identifies, describes, and prioritizes areas of its service territory at risk from wildfire for potential mitigation initiatives based solely on overall utility risk, including the associated risk drivers.

Geographic Scale and Statistical Approach: SCE’s definition and selection of areas for prioritization is not defined from the perspective of a “top X” percentage of risk. As described in detail in Section 6.2.1, the IWMS Risk Framework consists of two stages where SCE selects prioritized areas:

Initial Risk Categorization: SCE divides its HFRA into equal-sized polygons about 214 acres in area and then uses several factors such as egress, burn history, and other environmental factors (e.g., high wind locations) to categorize circuit segments within its HFRA into three distinct risk tranches: Severe Risk Areas, High Consequence Areas, and Other HFRA (see Table SCE 7-01 below).

Table SCE 7-01 - IWMS Framework Risk Tranches (Mutually Exclusive)

Severe Risk Area Criteria
<ul style="list-style-type: none"> ○ Population egress, high fire frequency location, and burn-in buffer into egress locations. ○ Significant fire consequence – Acres burned consequence greater than 10,000 over an 8-hour unsuppressed model simulation. ○ High winds – Locations, which if fully covered with covered conductor, would still be subject to high PSPS likelihood.

¹⁰⁹ Engagement with AFN populations is discussed in more detail Section 8.5.3.

<ul style="list-style-type: none"> ○ Communities of Elevated Fire Concern (CEFCs) – smaller geographic areas where terrain and other factors could lead to smaller, fast-moving fires threatening populated locations under benign (normal) weather conditions.
High Consequence Area Criteria
<ul style="list-style-type: none"> ○ Not identified in meeting Severe Risk Area criteria. ○ Destructive fire consequence – Acres burned consequence between 300 and 10,000 over an 8-hour unsuppressed model simulation. ○ Locations subject to PSPS events in which covered conductor has not been fully deployed.
Other HFRA Criteria
<ul style="list-style-type: none"> ○ Not identified in meeting Severe Risk Area or High Consequence criteria. ○ Small fire consequence - Acres burned consequence less than 300 over an 8-hour unsuppressed model simulation.

Review and Revision: A team of SMEs reviews, refines, and revises the output of the Initial Risk Categorization, by reviewing unhardened circuit segments with additional tools such as inspection photos and maps to determine if local conditions change the initial categorization. This process is ongoing and expected to be complete in Q1 2024.

List of Prioritized Areas: Below is SCE’s list that identifies, describes, and prioritizes areas of its service territory at risk from wildfire for potential mitigation initiatives based solely on overall utility risk, including the associated risk drivers.

Table 7-2 - List of Prioritized Areas in SCE’s Service Area Based on Overall Utility Risk

Priority	Area/ Tranche	Description ¹¹⁰	Overall Utility Risk ¹¹¹	Associated Risk Drivers
1	Severe Risk Areas	Locations with egress challenges, areas that fires have historically propagated towards (burn-in buffer), CEFCs, areas with extreme high winds, and segments with extreme Technosylva consequence (i.e., greater than 10,000 acres in eight hours with simulated wildfire ignition consequence). ~1,520 of ~2,950 total miles already hardened*	52.41 (0.018 risk per HFRA mile)	<ul style="list-style-type: none"> ● EFF ● CFO Other ● CFO Veg
2	High Consequence Areas	Segments not identified as a Severe Risk Areas are and in which simulated wildfire ignitions resulted in a wildfire consequence of 300-acres-or greater	64.86 (0.015 risk per HFRA mile)	<ul style="list-style-type: none"> ● EFF ● CFO Other ● CFO Veg

¹¹⁰ Hardened miles as of 12/31/2022 for all risk tranches. SCE may revise this data to reflect adjustments based on comparing completed work orders to mapping data, and also pending completion of SCE’s Review & Revise stage of IWMS.

¹¹¹ MARS units as of January 2023. Reflects mitigations and hardening in place.

Priority	Area/ Tranche	Description ¹¹⁰	Overall Utility Risk ¹¹¹	Associated Risk Drivers
		in eight hours, as well as those circuits which have the potential to be frequently impacted by PSPS events. ~2,285 of ~4,400 total miles already hardened*		
3	Other HFRA	Encompasses SCE overhead distribution lines that are located in HFRA but that are neither High Consequence Areas nor Severe Risk Areas. ~605 of ~2,250 total miles already hardened*	6.03 (0.003 risk per HFRA mile)	<ul style="list-style-type: none"> • EFF • CFO Other • CFO Veg

* “Hardened miles” refer to the miles of bare overhead lines replaced with covered conductor or underground cable and the associated infrastructure to complete those installation (i.e., FR pole as part of covered conductor installation). In some cases, alternatives such as REFCL, aerial bundled cable, or spacer cable are utilized.

Feasibility Review: After a part of SCE’s system is assigned a mitigation, it undergoes a feasibility review. The extent of the review depends on the mitigation, some mitigations require more intensive reviews than others. For example, replacing a vertical switch may not require more than one person to determine feasibility. On the other hand, a group of planners and engineers review TUG scope for feasibility, as there are multiple situations (terrain, ROWs over private property, customer meter locations, etc.) that can influence a TUG project. Further, when planning and scheduling work, SCE considers issues such as engineering and crew resource availability (both internal and external), permitting, logistical viability of potential mitigations, operational needs, local grid configurations, potential for customer outage fatigue, work bundling and other factors.

7.1.4 Mitigation Selection Process

After the electrical corporation creates a list of top-risk contributing circuits/segments/spans (Section 6.4.2) and prioritized areas based on overall utility risk (Section 7.1.3), the electrical corporation must then identify potential mitigation strategies. It must also evaluate the benefits and drawbacks of each strategy at different scales of application (e.g., circuit, circuit segment, system-wide). In this section of the WMP, the electrical corporation must provide the basis for its decisions regarding which mitigation initiatives to pursue. It must also document how it develops, evaluates, and selects mitigation initiatives.

The electrical corporation should consider appropriate mitigation initiatives depending on the local conditions and setting and the risk components that create the high-risk conditions. There may be a wide variety of potential mitigation initiatives, such as:

- *Engineering changes to grid design*
- *Discretionary inspection and/or maintenance of existing assets*
- *Vegetation clearances beyond minimum regulatory requirements*

- *Alternative operational policies, practices, and procedures*
- *Improved emergency planning and coordination*

The electrical corporation may also mitigate risk by combining multiple mitigation initiatives.

The electrical corporation is expected to use its procedures discussed in Section 7 to:

- *Develop potential mitigation initiative approaches to address each risk*
- *Characterize the potential mitigation initiatives to provide decision makers with information required to support decision making (e.g., costs, material availability), including an assessment of uncertainties*
- *Document the results*

The electrical corporation must develop a proposed schedule for implementing each mitigation initiative and proposed metrics to monitor implementation and effectiveness of the mitigation initiative. The following subsections provide specific requirements.¹¹²

As part of IWMS, SCE’s designs portfolios of mitigations that complement each other and mitigate multiple risk drivers. This process begins with the mitigation intake process, where SCE uses MARS to evaluate effectiveness and alternatives to each perspective mitigation. Then SCE considers mitigations from a holistic approach, develop complementary activities that address risk drivers based on risk analysis, historical ignition trends or findings, and expert review. SCE also considers cost effectiveness, how quickly the mitigations can be deployed, and mitigation deployment feasibility based on terrain. After SCE understands the relative effectiveness of each mitigation as well as the drivers it addresses, SCE designs portfolios of mitigations for each area of its system commensurate with its assigned risk tranche.

7.1.4.1 Identifying and Evaluating Mitigation Initiatives

The electrical corporation must describe how it identifies and evaluates options for mitigating wildfire and PSPS risk at various analytical scales. The current guidelines governing this process are derived from the Risk-Based Decision-Making Framework established in the Safety Model and Assessment Proceeding (S-MAP).¹¹³ The S-MAP is currently being updated in CPUC proceeding R. 20-07-013.¹¹⁴ In due course, the electrical corporation’s risk mitigation identification procedure must align with results from this proceeding.¹¹⁵ The electrical corporation must describe the following:

¹¹² Annual information included in this section must align with Tables 11 and 12 of the QDR.

¹¹³ 2018 Safety Model Assessment Proceeding (2018 S-MAP), adopted in D.18-12-014 (see S-MAP, step 3, rows 15–25): <https://docs.cpuc.ca.gov/PublishedDocs/Published/G000/M250/K281/250281848.pdf>

¹¹⁴ See the Rulemaking 20-07-013 (Order Instituting Rulemaking to Further Develop a Risk-Based Decision-Making Framework for Electric and Gas Utilities) Proceeding Docket (accessed Oct. 27, 2022): https://apps.cpuc.ca.gov/apex/f?p=401:56:0::NO:RP,57,RIR:P5_PROCEEDING_SELECT:R2007013. Also see the Risk Assessment Mitigation Phase (RAMP) proceeding (accessed Oct. 27, 2022): <https://www.cpuc.ca.gov/about-cpuc/divisions/safety-policy-division/risk-assessment-and-safety-analytics/risk-assessment-mitigation-phase>.

¹¹⁵ Electrical corporations are not required to incorporate changes made as a result of proceeding R. 20-07-013 in the 2023-2025 WMPs submitted in 2023.

- *The procedures for identifying and evaluating mitigation initiatives (comparable to 2018 S-MAP Settlement Agreement, row 26), including the use of risk buy-down estimates (e.g., risk-spend efficiency) and evaluating the benefits and drawbacks of mitigations*
- *To the extent possible, multiple potential locally relevant mitigation initiatives to address local wildfire risk drivers (see 2018 S-MAP Settlement Agreement, row 29)*
- *The approach the electrical corporation uses to characterize uncertainties and how the electrical corporation's evaluation and decision-making process incorporates these uncertainties (see 2018 S-MAP Settlement Agreement, rows 29 and 30)*
- *Two or more potential mitigation initiatives for each risk driver included in the list of prioritized areas (Table 7-2 in Section 7.1.3), including the following information:*
 - *The initiatives and activities*
 - *Expected risk reduction and impact on individual risk components*
 - *Estimated implementation costs*
 - *Relevant uncertainties*
 - *Implementation schedule*
- *How the electrical corporation uses multi-attribute value functions (MAVFs) and/or other specific risk factors (as identified in 2018 S-MAP or subsequent relevant CPUC Decisions) in evaluating different mitigations*

Below, SCE provides a detailed flowchart of our risk-informed decision-making process as generally used to select and evaluate SCE initiatives that mitigate wildfire and PSPS risks. The flowchart illustrates SCE's general approach to risk-informed decision-making when assessing and selecting wildfire and PSPS mitigations. We also provide a detailed narrative explanation of various entries in, and aspects of, the flowchart. For ease of reading and reference, we provide a "zoom in" of the particular portion of the flowchart when we are explaining it in narrative form.

Broadly speaking, the process can be broken down into three major stages, as outlined in the flowchart: First, we evaluate or reassess, and then prioritize, wildfire and PSPS risks. Second, we identify the choice of mitigations to address the risk. In other words, we pinpoint the various mitigation alternatives. Third, we evaluate the mitigations and then select the appropriate one(s) from amongst the alternatives, using decision-making factors.

Application of this process for each wildfire mitigation activity may vary, because SCE is continually in the process of improving how risk-informed decision-making is utilized across the enterprise. Applicability may also vary depending on the unique characteristics of the mitigation activities. While specific processes and steps continue to evolve as we build out our asset management capabilities, the flowchart generally captures the key elements of the process. With each cycle, SCE's overall risk-informed decision-making process generally is maturing in the level of quantitative analysis performed, granularity of analysis, and consistent application across the enterprise.

Figure SCE 7-02 - List of Prioritized Areas in SCE's Service Area Based on Overall Utility Risk

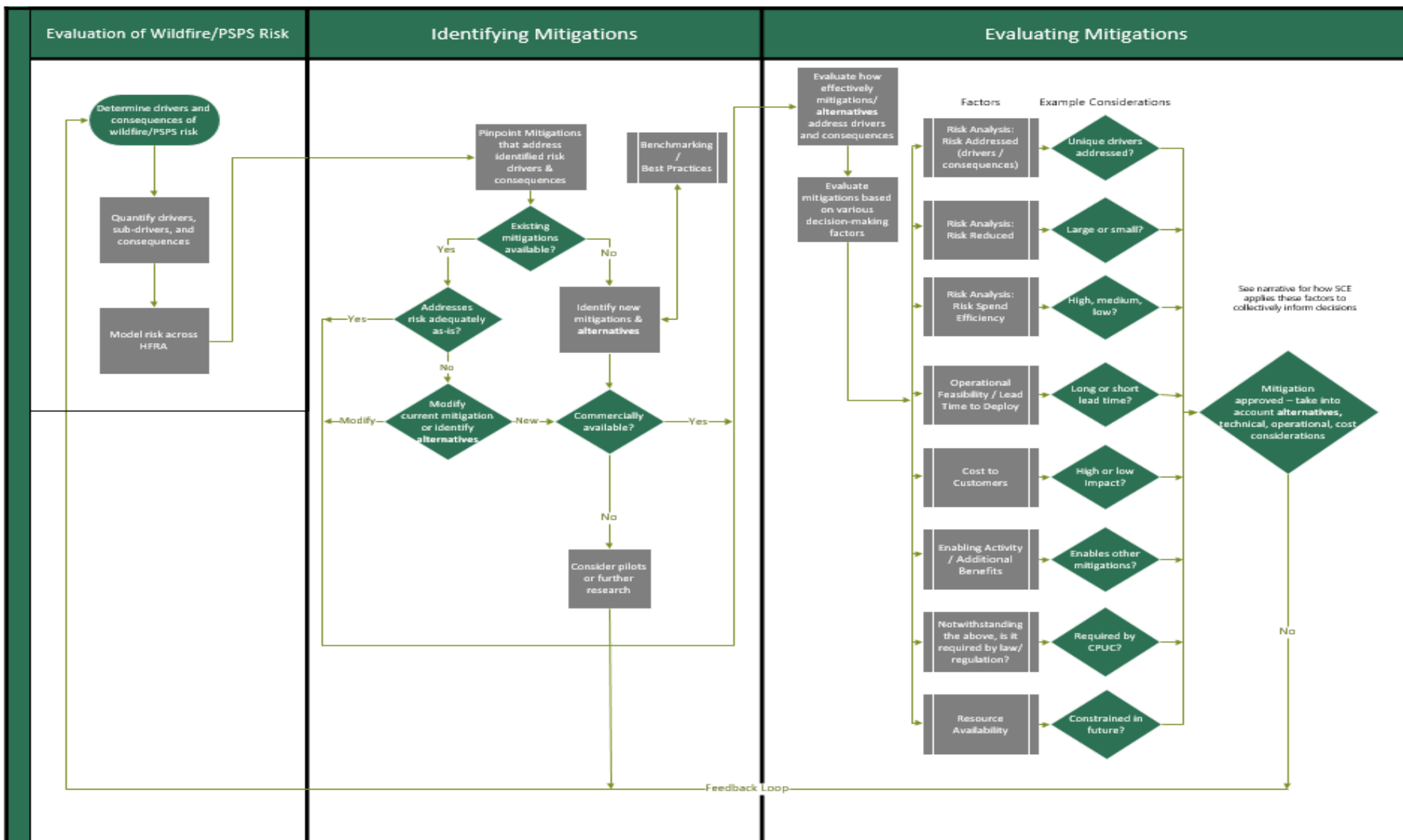
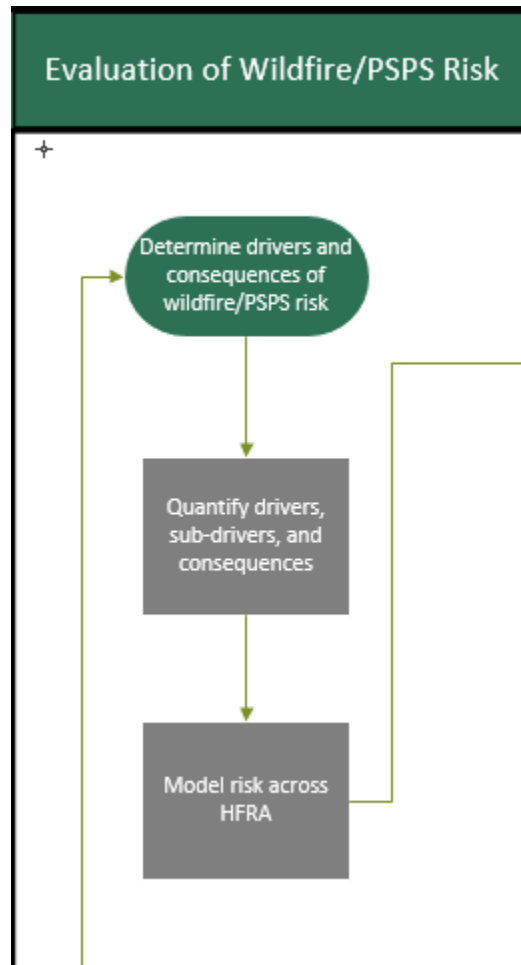

Figure SCE 7-03 - Evaluation of Wildfire and PSPS Risk (excerpt from full version in Figure SCE 7-02):



The selection of wildfire and PSPS risk mitigations starts with evaluating or reassessing the particular issue at hand, and the risks that underpin the issue. SCE has invested considerable resources to build its capabilities for identifying the drivers and consequences of wildfire and PSPS risk and examining how that risk is distributed across SCE’s High Fire Risk Area (HFRA). This is discussed in further detail in Section 6.2.1, but is summarized here for context. The general steps embedded in SCE’s process for identifying and evaluating wildfire risk are as follows:

- Determining drivers (and sub-drivers) and consequences of wildfire risk;
- Quantifying drivers, sub-drivers, consequences, and overall risk as appropriate; and
- Modeling this risk across SCE’s HFRA.

Determine drivers (and sub-drivers) and consequences of wildfire risk

As we discussed in detail in Section 6, SCE applies the risk bowtie approach to enable us to consistently and systematically identify threats and characterize sources of risk.

Quantify drivers, sub-drivers, consequences, and overall risk as appropriate

SCE estimates risk reduction and calculate RSEs in order to help make decisions about wildfire/PSPS mitigation activities and to inform the prioritization of deploying mitigations.

The triggering event at the center of the wildfire bowtie is an ignition in SCE's HFRA. On the left-hand side of the bowtie, historical ignition and fault analysis determined that potential ignitions are primarily driven by equipment failure, contact from objects (such as vegetation or mylar balloons), and wire-to-wire contact (during periods of high winds). SCE leverages machine learning models to estimate the probability of ignition by driver for a given set of assets in HFRA.

The consequences of these ignition events are estimated on the right-hand side of the bowtie, using the Technosylva consequence model (starting in late 2020). The model estimates the potential spread of a fire over a given time, as well as the corresponding impact of a fire in natural units - structures, acres, and population.

The risk bowtie for PSPS risk evaluates the drivers and probabilities of PSPS activations. Here, SCE uses data points such as the historical back-cast of wind and weather conditions in conjunction with PSPS de-energization protocols to estimate the annual frequency and duration of de-energization events. The consequences of these PSPS events are estimated on the right-hand side of the bowtie, based on the potential safety, reliability, and financial impacts to customers.

Model this risk across SCE's HFRA

Wildfire and PSPS consequences are then translated into MARS units to compare the relative risk of wildfire ignitions/PSPS events across SCE HFRA locations. The output of individual models and/or the entirety of the model output can be used to inform risk-related decision-making.

Figure SCE 7-04 - Identifying Mitigations (excerpt from full version in Figure SCE 7-02)

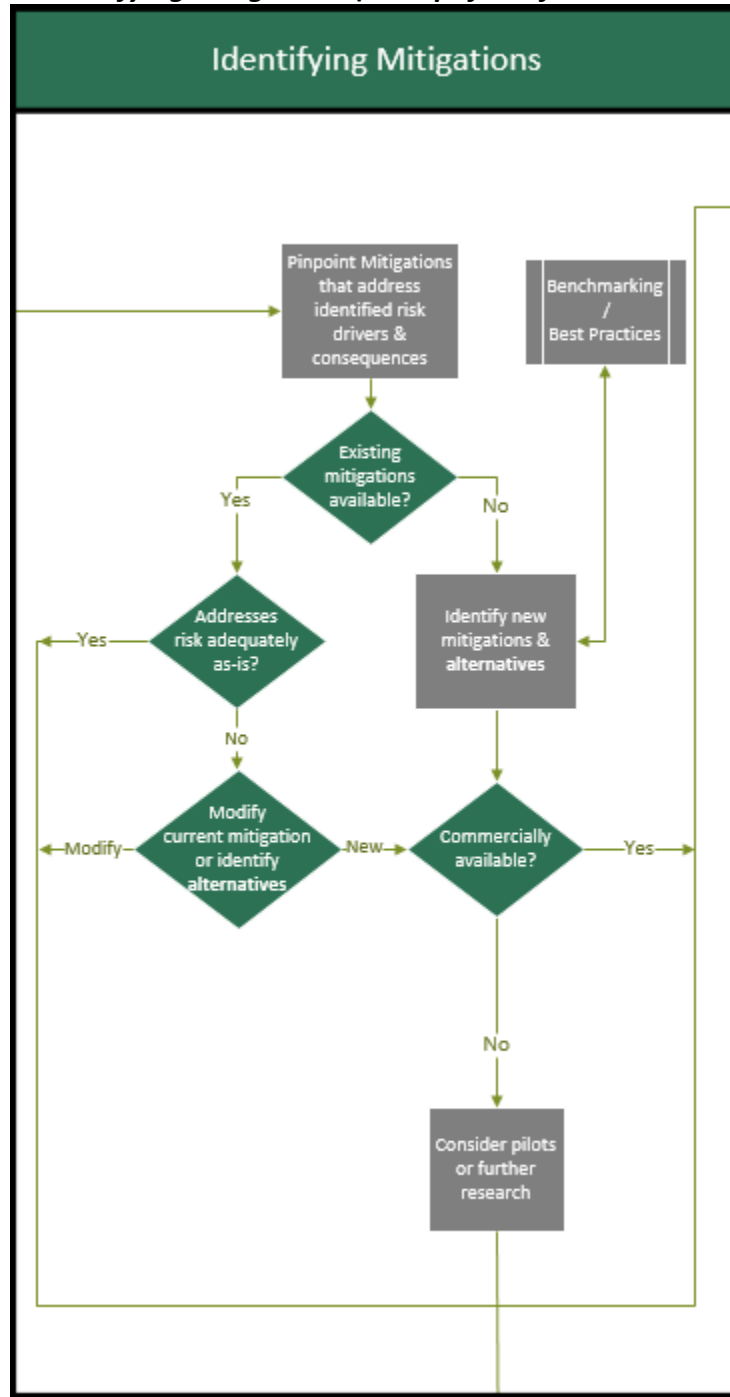

The second step in the process is to identify candidate initiatives to mitigate wildfire/PSPS risk. Here, we focus on potential options to reduce the risks that we evaluated or reassessed, and then prioritized, in the first step. These potential options come in the form of existing, modified, or new initiatives. Mitigation options reduce either the frequency, consequence, or both, of wildfire and/or PSPS risk, resulting in overall risk reduction and fall into one of four general categories, as described below:

- Existing mitigations that already help to reduce risk

In some cases, the work that SCE performs to maintain and upgrade its overhead systems in HFRA already provides certain risk reduction benefits. In such cases, these activities would be identified for continued implementation as prudent for purposes of reducing wildfire risk. One example is line clearance activities to reduce the probability of faults or ignitions from vegetation making contact with energized equipment.

- Existing mitigations that, when modified, can further reduce risk

In other cases, existing mitigation activities may support wildfire risk reduction, but if appropriately modified, could provide even greater risk reduction benefits. This modification can take several forms:

1. The scope of the activity could be modified. An example is expanding the scope of assets and asset conditions that are evaluated as part of an inspection program.
2. The scale of the activity could be increased to cover a wider area of SCE's HFRA.
3. The frequency of an activity could be modified. An example would be to increase how frequently critical or higher-risk assets or areas are inspected.
4. New technology could be incorporated to make the activity more effective or efficient at identifying and mitigating risk. As an example, incorporating Artificial Intelligence/Machine Learning models to help detect asset defects and identify hazards as part of the Aerial Inspection processes could result in decreased time for problem identification, with increased confidence in risk/issue detection.

- New mitigations that are commercially ready to deploy to reduce risk

SCE also identifies new risk mitigation options. These new options can be identified through, among other actions, benchmarking with other utilities; studying and adopting emergent best practices; obtaining guidance from engineering and technical industry committees; studying emerging technology demonstrations; and assessing pilot studies that produce successful or otherwise useful results. SCE's portfolio of wildfire mitigation initiatives has benefitted greatly from identifying and adding new initiatives that were not previously deployed in SCE's service area. Our covered conductor program is an example of one such mitigation.

- New mitigations that should be piloted and further evaluated for potential future deployment

In some cases, concepts emerge that have promising wildfire or PSPS risk reduction benefits but have not yet been fully studied or evaluated through a reliable pilot or demonstration. Since these options are not commercially ready to be deployed on SCE's system, SCE will typically engage in further

consideration of these options through a pilot project, demonstration effort, or smaller-scale field testing or pilot deployment. Technological maturity is an important criterion when we are identifying and assessing mitigations.

Figure SCE 7-05 - Evaluating Mitigations (excerpt from full version in Figure SCE 7-02)

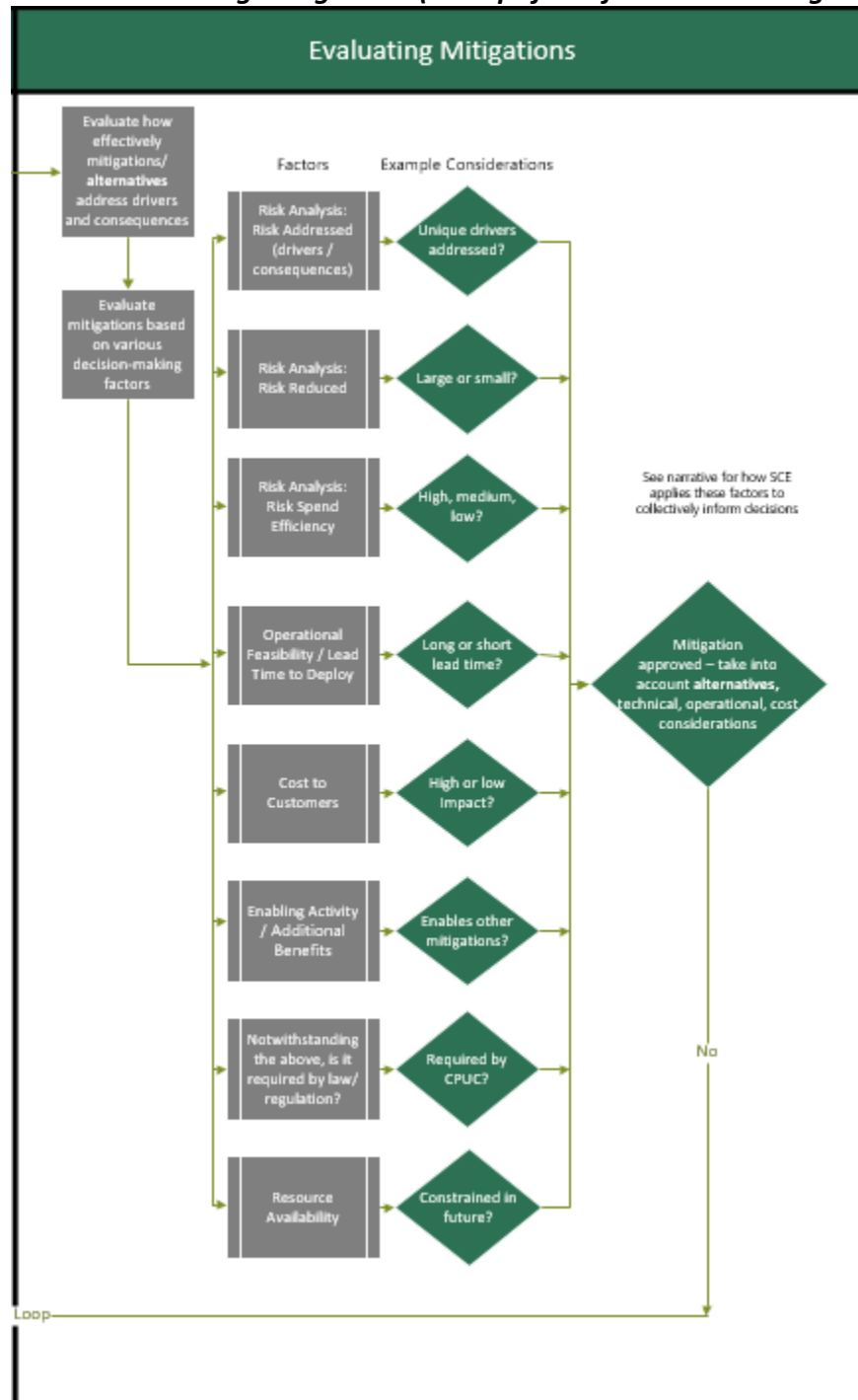

After we have identified our options for possible selection, those options must then be prudently evaluated. This usually starts with an estimation of how effective each option can be in reducing the various wildfire and/or PSPS risk drivers and consequences. This analysis is performed by subject matter experts, who utilize engineering data, historical performance data, benchmarking information, research studies, results from demonstrations or field tests, and other sources of information.

SCE is focused on efficiently reducing wildfire and PSPS risk as quickly as reasonably possible, prioritizing

mitigations to areas of our system that present the highest risk and doing so in a manner that appropriately minimizes customer cost and service impacts. Therefore, the selection of wildfire initiatives must necessarily consider several factors in the decision-making process. Such factors include the risk profile for HFRA in SCE’s service area, the risk profile of assets that have the potential to cause ignitions, how each activity impacts the frequency and/or impact of wildfires, the potential speed of deployment, costs, RSE scores, resource constraints, material or technology availability and other factors that may relate to a given initiative.

Figure SCE 7-06 provides additional details concerning the key factors shown in the flowchart above that are commonly considered as part of SCE’s decision-making process when selecting wildfire mitigation initiatives. The figure also illustrates how SCE generally evaluates each factor when making decisions.

Figure SCE 7-06 - Decision-Making Factors Considered

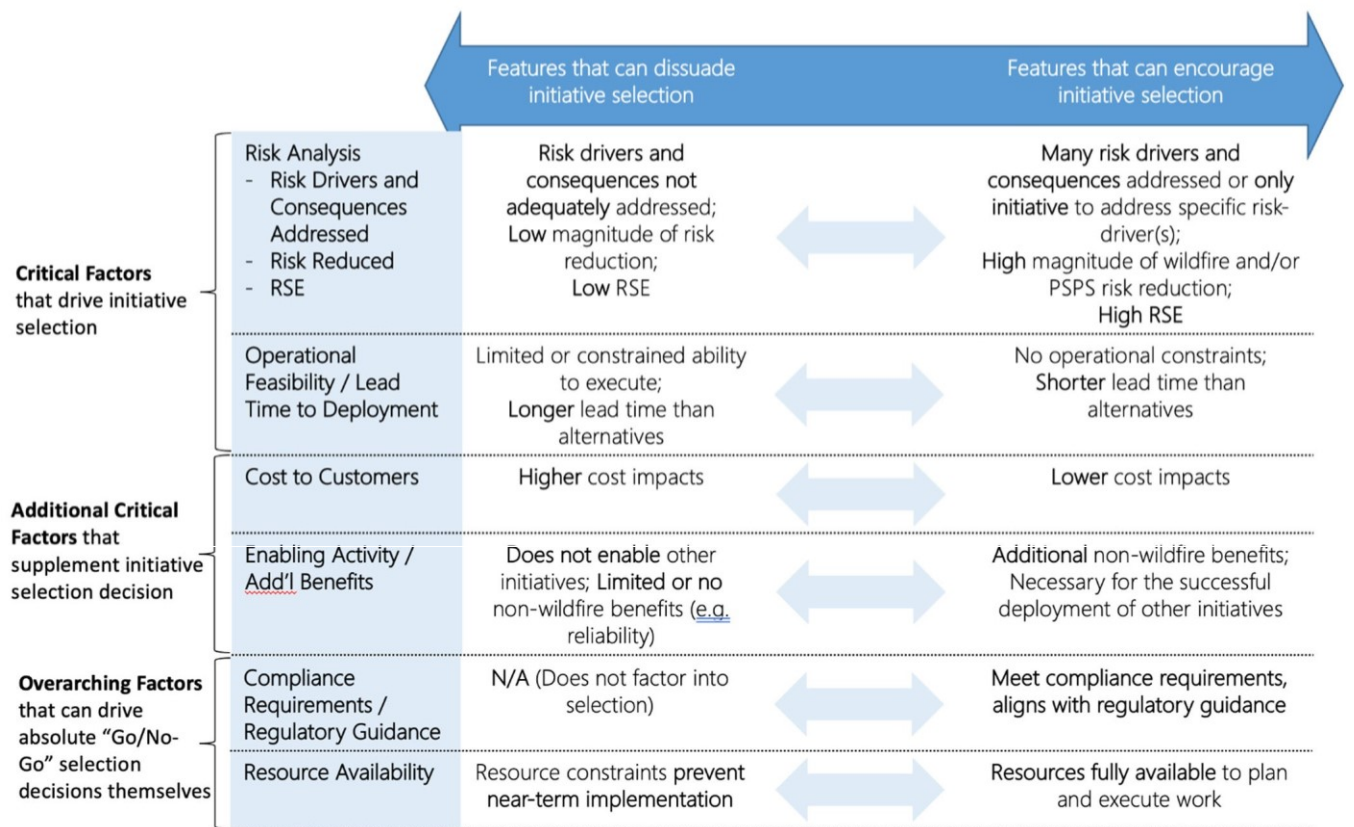

SCE carefully considers each factor both individually and in the aggregate in order to make sound and informed decisions. A given factor may not have a uniform level of importance or impact in all situations. As an example, if an initiative is required pursuant to a regulation, standard, code, or other authority, then meeting and adhering to compliance requirements would naturally be a decisive factor in SCE’s ultimate determination. Similarly, if an initiative is under consideration but SCE would be unable to sufficiently staff it with requisite resources, then the “Resource Availability” factor will more heavily influence our decision-making because it may be infeasible to execute the initiative in a timely manner. The influence of resource constraints in assessing a particular potential mitigation can be very different if the resource constraints would simply lead to a short delay in building out the mitigation, versus if the resource constraints could lead

to a material inability to complete the mitigation in an acceptable time frame, or fully complete it at all.

Below, SCE describes each decision-making factor in greater detail.

- **Risk Analysis/Factors:** Risk is a primary consideration when selecting mitigation initiatives. Decisions incorporate one or more of the following risk factors:
- **Risk Drivers and Consequences Addressed:** There are many drivers to wildfire risk. It is necessary to have a portfolio of initiatives that collectively and sufficiently addresses the breadth of risk drivers. In some cases, an initiative such as covered conductor will address numerous risk drivers. In other cases, initiatives may more narrowly – but importantly – address one risk driver that none of the other initiatives address. For example, SCE’s Vertical Switches initiative (SH-15) was included in SCE’s WMP to address a very specific potential risk driver associated with a specific switch configuration in HFRA that was previously not addressed in our wildfire mitigation plan. In some cases, a mitigation initiative addresses a key driver that is already addressed to some degree by other initiatives, but the configuration is beneficial because the multiple initiatives work together to address the driver better than any single mitigation initiative. For example, though covered conductor addresses vegetation making contact with wires, line clearance and HTMP activities are also necessary to reduce heavy branches or trees from falling into lines that covered conductor may not be able to withstand. Moreover, vegetation management activities can be deployed more rapidly than covered conductor installation, and therefore can help reduce risk across HFRA in advance of covered conductor being installed. Finally, initiatives are also considered based on their ability to mitigate risk consequences. As an example, SCE deploys Community Resource Centers (CRCs) to enable the charging of portable mobile devices and distribute water and snacks. CRCs also provide access to air-conditioned facilities and restrooms, among other services, during a PSPS event. The CRCs do not prevent PSPS events. Instead, they help alleviate the consequences of a PSPS event.
- **Risk Reduction:** SCE aims to expeditiously reduce as much risk as possible in terms of our electrical lines and equipment being involved in an ignition that can lead to a wildfire. As SCE evaluates wildfire initiatives, the magnitude of risk reduction is a central consideration, with a preference toward those initiatives that can provide higher risk reduction.

Table SCE 7-02 shows the relative effectiveness of wildfire mitigation programs for wildfire risk drivers and PSPS. In the table, a solid white ball indicates no effectiveness (0%) at the driver level, while a solid black ball indicates the highest degree of effectiveness (>75%) at the driver level. The Harvey Balls are based on the weighted average effectiveness values of each ignition subdriver applicable to the driver category and are biased against historical recorded ignition drivers. For example, a mitigation can be effective against an ignition driver, but because there have been zero historical ignitions related to that particular ignition driver, its weighted effectiveness is zero.

Note that the Contact from Object driver was split into two categories: “Contact from Object – Vegetation” which represents effectiveness against vegetation contact and “Contact from Object – Other” which represents effectiveness against the animal contact, balloon contact, vehicle contact, and other.

PSPS effectiveness is categorized as High, Medium, or Low, which are defined as follows:

- High Effectiveness: Will result in a significant reduction or complete elimination of PSPS
- Medium Effectiveness: Will result in a moderate reduction of PSPS

- Low Effectiveness: Will result in a limited reduction of PSPS

Table SCE 7-02 - Mitigation Effectiveness

Tracking ID	Activity	Contact from Object - Veg.	Contact from Object - Other	Wire-to-wire contact	Equipment Failure	Other	PSPS
SH-1*	Covered Conductor	●	●	●	●	●	Medium
SH-2	Undergrounding Overhead Conductor	●	●	●	●	●	High
SH-4	Branch Line Protection Strategy	○	○	○	○	○	N/A
SH-5	Remote Controlled Automatic Reclosers Settings Update	○	○	○	○	○	Low
SH-6	Circuit Breaker Relay Hardware for Fast Curve	○	○	○	○	○	N/A
SH-8	Transmission Open Phase Detection	○	○	○	○	○	N/A
SH-10	Tree Attachment Remediation	○	○	○	○	○	N/A
SH-14	Long Span Initiative (LSI)	○	○	○	○	○	N/A
SH-15	Vertical Switches	N/A	N/A	N/A	○	N/A	N/A
SH-16**	Vibration Damper Retrofit	●	●	●	●	○	N/A
SH-17, SH-18	Rapid Earth Fault Current Limiters (REFCL) - Ground Fault Neutralizer	○	○	N/A	○	○	N/A
SA-11	Early Fault Detection	○	○	○	○	○	N/A
IN-1.1	Distribution High Fire Risk-Informed Inspections & Remediations	○	○	N/A	○	○	N/A
IN-1.2a	Transmission Ground Inspections	○	○	N/A	○	○	N/A
IN-1.2b	Transmission Aerial Inspections	○	○	N/A	○	○	N/A
IN-3	Infrared of Distribution electrical lines & equipment	N/A	N/A	N/A	○	○	N/A
IN-5	Generation Inspections	N/A	N/A	N/A	N/A	N/A	N/A
VM-1	Hazard Tree Mitigation Program	●	N/A	N/A	N/A	N/A	N/A
VM-2	Structure Brushing	N/A	N/A	N/A	○	N/A	N/A
VM-3	Expanded Clearances for Legacy Facilities	○	N/A	N/A	○	N/A	N/A
VM-4	Dead and Dying Tree Removal	●	N/A	N/A	N/A	N/A	N/A
VM-7	Distribution Line Clearances	○	N/A	N/A	N/A	N/A	N/A
VM-8	Transmission Line Clearances	○	N/A	N/A	N/A	N/A	N/A
IN-4	Infrared of Transmission electrical lines & equipment	N/A	N/A	N/A	○	N/A	N/A
IN-9	Trans Conductor & Splice (Spans with LineVue)	N/A	N/A	N/A	○	N/A	N/A

* Combines the effectiveness of covered conductor and FR Poles
 ** Vibration dampers help maintain the useful life of covered conductor and therefore mirrors the covered conductor effectiveness

Legend		
	○	0% effectiveness at driver level
	○	0% to 25% effectiveness at driver level
	○	25% to 50% effectiveness at driver level
	○	50% to 75% effectiveness at driver level
	○	75% to 100% effectiveness at driver level
	N/A	Driver is not applicable for mitigation

- **Risk Mitigation Effectiveness Uncertainty:** To the extent possible, SCE bases its assessment of mitigations’ risk reduction effectiveness on quantitative data. However, sometimes quantitative data is either unavailable, due to the relative newness of an initiative, or only available in a small size. In such situations, SCE will rely on SME judgment and supplement with quantitative data as it becomes available. SCE takes into account the certainty of an initiative’s effectiveness as it determines whether or not to deploy it and, if so, the magnitude of the deployment. Table SCE 7-03 below displays the sources of SCE’s estimates of initiatives’ risk mitigation effectiveness.

Table SCE 7-03 - Mitigation Effectiveness Sources

Tracking ID	Mitigation	Estimate Source
SH-1	Covered Conductor	Bayesian or other formal analysis incorporating industry data with internal data
SH-2	Undergrounding Overhead Conductor	Bayesian or other formal analysis incorporating industry data with internal data
SH-4	Branch Line Protection Strategy	Limited internal data
SH-5	Remote Controlled Automatic Reclosers Settings Update	Multiple SMEs
SH-6	Circuit Breaker Relay Hardware for Fast Curve	Internal data
SH-8	Transmission Open Phase Detection	Multiple SMEs
SH-10	Tree Attachments Remediation	Multiple SMEs
SH-14	Long Span Initiative (LSI)	Multiple SMEs
SH-15	Vertical Switches	Multiple SMEs
SH-16	Vibration Damper Retrofit	Multiple SMEs
SH-17	Rapid Earth Fault Current Limiters (REFCL) - Ground Fault Neutralizer	Bayesian or other formal analysis incorporating industry data with internal data
SH-18	REFCL (Grounding Conversion)	Bayesian or other formal analysis incorporating industry data with internal data
SA-11	Early Fault Detection	Limited internal data
IN-1.1	Distribution High Fire Risk-Informed Inspections & Remediations	Internal data
IN-1.2	Transmission Risk-Informed Inspections and Remediations	Internal data
IN-3	Infrared of Distribution electrical lines & equipment	Limited internal data
IN-4	Infrared of Transmission electrical lines & equipment	Limited internal data
IN-5	Generation High Risk Informed Inspections & Remediations	Limited internal data
IN-9	Transmission Conductor & Splice	Multiple SMEs
VM-1	Hazard Tree Mitigation Program	Internal data
VM-2	Structure Brushing	Internal data
VM-3	Expanded Clearances for Legacy Facilities	Limited internal data
VM-4	Dead and Dying Tree Removal	Internal data
VM-7	Distribution Line Clearances	Internal data
VM-8	Transmission Line Clearances	Limited internal data

Risk Spend Efficiency (RSE): SCE developed its MAVF based on the six principles as set forth in the S-MAP Settlement.¹¹⁶ The MAVF is a framework to combine different consequences (e.g., safety, reliability and

¹¹⁶ See S-MAP Settlement Agreement, pp. A-5 – A-6.

financial) into a generic unitless risk score, MARS, so that risks and mitigation alternatives can be compared on a uniform scale. SCE uses MARS, as appropriate, to establish baseline risk and to develop RSEs, given that MARS itself has no visible standalone value. RSEs help SCE evaluate the relative cost-effectiveness of potential initiatives; this in turn provides insight concerning prudently allocating resources, funding, and efforts to efficiently mitigate wildfire risk.

That said, it would not be in the best interest of our customers or the communities we serve if SCE were to carry out a comprehensive wildfire risk mitigation plan based solely on RSEs. An RSE does not take into account certain operational realities, such as resource constraints, compliance issues, or service disruptions. Relying solely on RSEs could lead to significant parts of the system and potentially significant risk issues being left unaddressed. Indeed, the Commission’s Safety and Enforcement Division (SED) noted that focusing solely on RSEs in selecting mitigations could be “suboptimal from an aggregate risk portfolio standpoint.”¹¹⁷ SED acknowledged that “mitigations are usually selected based on the highest risk spend efficiency score unless there may be some identified resource constraints, compliance constraints, or operational constraints that may favor another candidate measure with a lower RSE.”¹¹⁸ SCE agrees with this characterization. An initiative with a relatively higher RSE is generally favorable to one with a relatively lower RSE. However, when an initiative has a relatively lower RSE, it could still be selected if, for example, it is easier to deploy quickly (e.g., critical care battery backup program to medical baseline customers affected by PSPS), addresses a particular risk driver that other mitigations do not (e.g., C-hook replacement and aerial inspections), or reduces overall risk even if it costs more (e.g., targeted undergrounding).

Operational Feasibility / Lead Time to Deployment: An important feature of the selection process is obtaining an early understanding of the feasibility of implementing an initiative, and the time required to plan, design and ultimately deploy the initiative. Since SCE is focused on reducing wildfire risk as quickly as reasonably possible, our preference leans toward initiatives that can be deployed more quickly in order to protect public safety. However, SCE carefully considers certain initiatives that may have longer lead times but that are necessary to provide substantial long-term risk reduction. SCE provides deployment times for its portfolios in Table SCE 7-07 in Section 7.1.4.2.

Cost to Customers: While the primary focus of our WMP is to reduce wildfire and PSPS risk at an appropriately urgent pace for the safety of our customers, cost is a factor in the decision-making process. In addition to RSEs that assess the risk reduction benefits of each initiative against its costs, the total cost associated with any initiative also needs to be considered to account for customer affordability and funding constraints. SCE notes that implementation costs for selected mitigations as a whole are provided in

Table 4-1 in Section 4, at the portfolio level in Table SCE 7-06 in Section 7.1.4.2 and at the individual level in Table 11 of the QDR.

Enabling Activity / Technology / Additional Benefits: Initiatives can be selected that do not directly reduce wildfire or PSPS risk, but rather *enable* other initiatives to reduce risk, or to do so more efficiently. In our decision-making process, SCE will also consider indirect but worthwhile benefits that initiatives may provide. Such indirect benefits may include improved system reliability, faster service restoration, improved communications with customers, etc. While valuable, these secondary benefits may be less influential in the wildfire risk reduction decision-making process compared to the other factors.

¹¹⁷ California Public Utilities Commission, Risk and Safety Aspects of Risk Assessment and Mitigation Phase Report of Pacific Gas and Electric Company, Investigation 17-11-003 (March 30, 2018), page 18.

¹¹⁸ Id.

Compliance Requirement / Regulatory Guidance: In most circumstances, activities necessary to comply with local, state, or federal laws or regulations will be selected irrespective of other factors. In other words, compliance needs may weigh in favor of selecting the initiative even if other factors seem to weigh against selecting the initiative, particularly if the initiative represents the only prudent or feasible way to comply with the applicable law(s) or regulations(s). In addition, SCE takes into account Commission or other regulatory guidance and decisions when we are selecting wildfire mitigation activities and scope.

Resource Availability: With increasing work to maintain and operate the grid while upgrading it to mitigate safety and resiliency risks, there are increasing constraints associated with specialized resources such as planners, designers, engineers, field crews, etc. The scope of such resource constraints can be internal, across the state, and even nationwide at times. If requisite resources are not available, the potential initiative could be temporarily deferred or de-scoped.

7.1.4.2 Mitigation Initiative Prioritization

After identifying and characterizing the mitigation options, the electrical corporation must analyze the options to determine which will reduce risk the most, given limitations and constraints (e.g., resources available for mitigation initiatives). To the greatest extent practicable, the electrical corporation must make these determinations using its existing framework of project prioritization. The electrical corporation must strive to optimize its resources for maximum risk reduction.

The electrical corporation should seek the best integrated portfolio of mitigation initiatives to meet its performance objectives. Objectives may be based on quantified risk assessment results (see Section 6) or other values prioritized by the electrical corporation or broader stakeholder groups (e.g., environmental protection, public perception, resilience, cost). At a minimum, the electrical corporation must do the following:

- *Evaluate its potential mitigation initiatives. This evaluation will yield a prioritized list of initiatives. The objective is for the electrical corporation to identify the preferable initiatives for specific geographical areas. (Comparable to 2018 S-MAP Settlement Agreement, rows 12, 26, and 29.)*
- *Identify the best mitigation initiatives for all geographical areas to create a portfolio of projects expected to provide maximal benefits within known limitations and constraints. (Comparable to 2018 S-MAP Settlement Agreement, rows 12, 26, and 29.)*
- *Explain how the electrical corporation is optimizing its resources to maximize risk reduction. Describe how the proposed initiatives are an efficient use of electrical corporation resources and focus on achieving the greatest risk reduction with the most efficient use of funds and workforce resources.*

This process is expected to be iterative due to the competing nature of performance objectives and their complex interrelationships.

The electrical corporation must describe how it prioritizes mitigation initiatives to reduce both wildfire and PSPS risk. This discussion must include the following:

- *A high-level schematic showing the procedures and evaluation criteria used to evaluate potential mitigation initiatives. At a minimum, the schematic must demonstrate the roles of quantitative risk assessment, resource allocation, evaluation of other performance objectives (e.g., cost, timing) identified by the electrical corporation, and subject matter expert (SME) judgment. Where specific*

local factors, which vary across the service territory, are considered in the decision-making process (e.g., the primary risk driver in a region is legacy equipment), they must be indicated in the schematic. The detail must be sufficiently specific to understand why those local conditions are part of the decision process (i.e., there should not be simply one box in the schematic that is labeled “local conditions,” which is then connected to the rest of the process).

- Summary description (no more than five pages) of the procedures and evaluation criteria for prioritizing mitigation initiatives, including the three minimum requirements listed above in this section.

Evaluate Mitigations

SCE’s process for evaluating mitigations is described in detail in Section 7.1.4.1. High level schematics are provided as Figure SCE 7-01 and Figure SCE 7-02. High level schematics are provided as Figure SCE 7-01 and Figure SCE 7-02.

Optimized Mitigation Portfolios

After the initiatives are identified and evaluated pursuant to the process described above (SCE’s evaluation process, criteria and high-level schematic are presented in Section 7.1.4.1), SCE designs portfolios of mitigations tailored to each of the three risk tranches.

Table SCE 7-04 - Preferred Mitigation Portfolio per Risk Tranche

Risk Tranche	Preferred Mitigation Portfolio
Severe Risk Areas	TUG or REFCL/CC++
High Consequence Areas	CC++
Other HFRA	VM/I++
Transmission ¹¹⁹	TVM/I

Severe Risk Areas

For Severe Risk Area locations, the threat to lives and property is elevated to such an extent that SCE has determined that for public safety reasons it is prudent to not just significantly reduce ignition risk expeditiously but minimize it in the long term to the extent practicable. Therefore, undergrounding is preferred unless covered conductor has already been installed or specific terrain or local issues require alternatives such as covered conductor with supplementary mitigations.

For example, mountainous regions with winding rights-of-way and rocky soil may not be conducive to undergrounding. In those situations, SCE would examine alternatives such as covered conductor paired with REFCL. On the other hand, undergrounding may be more feasible in flat areas with silty clay soil, making that the preferred option. Accordingly, Severe Risk Areas are assigned either the portfolio known as TUG or REFCL/CC++.

Due to the potential impacts that a wildfire would have in these areas, when designing REFCL/CC++, SCE looked to mitigate all risk drivers to the extent reasonably possible. This necessarily means some cost-

¹¹⁹ SCE’s transmission lines also traverse severe risk areas, high consequence areas, and Other HFRA’s.

efficient redundancy, which is desirable since no mitigation matches undergrounding on its own. Thus REFCL/CC++ includes covered conductor, fast curve, vegetation management, and fusing to address contact from object; REFCL, asset inspections, and covered conductor to address equipment failure; and covered conductor to address wire to wire contact.

As all options have implementation times of multiple months, up to as much as four years or more, SCE will continue to use initiatives such as Fast Curve (FC) settings, asset inspections on the most frequent basis, and, as a tool of last resort, PSPS to mitigate the risk of ignitions while the selected initiative is designed, permitted, and constructed.

High Consequence Areas

For High Consequence Area locations, SCE’s strategy focuses on mitigating the majority of significant ignition risk drivers. SCE has selected CC++ for most of the High Consequence Areas that are still unmitigated, as it addresses all significant ignition risk drivers associated with overhead conductor, reduces more risk per dollar spent, and is faster and easier to deploy.

Other HFRA

For areas classified at Other HFRA, SCE will harden overhead distribution circuits over time, as it replaces retired or damaged bare wires with covered conductor pursuant to its standards in HFRA. SCE will continue wildfire mitigation initiatives such as asset inspections, Fast Curve settings, and vegetation management that have relatively low incremental costs or are dictated by compliance requirements or local conditions. Additionally, the deployment of technology like EFD may provide some monitoring benefit on these unmitigated aging assets (e.g., detect issues on the electric line before failure). Accordingly, Other HFRA are assigned the VM/I++ portfolio of mitigations.

Although SCE is not currently targeting proactive hardening of these lines (with the exception of where it may be operationally efficient to do so), SCE periodically re-evaluates risks in these locations based on climate change impacts, refined risk methodologies and modeling, and/or more accurate information.

Transmission

Similar to SCE’s overhead distribution lines, SCE’s overhead transmission lines traverse Severe Risk Areas, High Consequence Areas and Other HFRA. However, due to taller structures and greater space between phases, SCE’s transmission lines generally have a lower risk of ignition than its overhead distribution lines and thus have its own portfolio of mitigations assigned to it, TVM/I. SCE will perform additional review and analysis of possible mitigations for transmission lines in 2023 beyond what is currently included in the TVM/I portfolio. This is further described in Section 8.1.2.12.1.

Table SCE 7-05 below summarizes the components of each portfolio and potential alternatives for each mitigation.

Table SCE 7-05 - Mitigation Portfolios

Mitigation	Portfolio Including Mitigation
Covered Conductor	CC++, REFCL/CC++
Undergrounding Overhead Conductor	TUG
Branch Line Protection Strategy	TUG, CC++, REFCL/CC++, VM/I++
Remote Controlled Automatic Reclosers Settings Update	TUG, CC++, REFCL/CC++, VM/I++
Circuit Breaker Relay Hardware for Fast Curve	TUG, CC++, REFCL/CC++, VM/I++

Mitigation	Portfolio Including Mitigation
Transmission Open Phase Detection	TVM/I
Tree Attachments Remediation	Deployed to address specific known issue
Long Span Initiative (LSI)	Deployed to address specific known issue
Vertical Switches	Deployed to address specific known issue
Vibration Damper Retrofit	Deployed to address specific known issue
Rapid Earth Fault Current Limiters (REFCL) - Ground Fault Neutralizer	REFCL/CC++
REFCL (Grounding Conversion)	REFCL/CC++
Early Fault Detection	CC++, REFCL/CC++, VM/I++
Distribution High Fire Risk-Informed Inspections & Remediations	TUG, CC++, REFCL/CC++, VM/I++
Transmission Risk-Informed Inspections & Remediations	TVM/I
Infrared of Distribution electrical lines & equipment	TUG, CC++, REFCL/CC++, VM/I++
Infrared of Transmission electrical lines & equipment	TVM/I
Generation High Risk Informed Inspections & Remediations	Legacy facilities only
Transmission Conductor & Splice	TVM/I
Hazard Tree Mitigation Program	TUG, CC++, REFCL/CC++, VM/I++
Structure Brushing	TUG, CC++, REFCL/CC++
Expanded Clearances for Legacy Facilities	Legacy facilities only
Dead and Dying Tree Removal	TUG, CC++, REFCL/CC++, VM/I++
Distribution Line Clearances	TUG, CC++, REFCL/CC++, VM/I++
Transmission Line Clearances	TVM/I

Table SCE 7-06 below summarizes the relative effectiveness of each portfolio across risk drivers.

Table SCE 7-06 - Efficacy of Mitigation Portfolios

Attribute	Underground	CC/REFCL++	CC++	VM/I++
Approximate Average lifetime cost/mile ¹²⁰	\$2.9M-\$4.5M+ ¹²¹	\$1.1M-\$2.3M	\$1.1M-\$1.3M	\$0.35-\$0.45M ¹²²
Deployment Speed ¹²³	25-48+ months	18-36+ months	16-24+months	Annual
Phase-to-phase incandescent particle ignition ¹²⁴ mitigation	High	High	High	Low

¹²⁰ Cost estimates associated with the “++” and VM/I++ portfolio are lifetime O&M costs and excludes Capital costs.

¹²¹ Based on current analysis, SCE estimates that a small population of underground miles may fall below this range.

¹²² Estimate of lifetime cost of the VM/I++ portfolio in Other HFRAs

¹²³ Typical deployment timelines based on historical installations and projected costs. Actual timelines can vary further due to local conditions.

¹²⁴ Examples include conductor to conductor contact, balloon coming between two phase wires.

Attribute	Underground	CC/REFCL++	CC++	VM/I++
Phase-to-ground incandescent particle ignition ¹²⁵ mitigation	High	High	High	Medium
Distribution Wire-down ignition mitigation	High	High	High	Low
Equipment Failure mitigation	High	High	Medium	Medium

Adjustments to Portfolios

As described in Section 6.2.1, the Review and Revise stage consists of the team of SMEs reviewing unhardened segments and local conditions to determine if the segments were appropriately categorized during the Initial Risk Categorization stage. SCE leverages this evaluation process to make individualized adjustments to mitigation portfolios for specific segments if local conditions make an alternative mitigation more appropriate. For example, if a long line of overhead conductor runs through a Severe Risk Area and serves what appears to be relatively small load, the team may recommend a Remote Grid option be evaluated in lieu of undergrounding. Or if the overhead line passes through a region filled with heavy trees and the terrain appears difficult to underground, the team may recommend the evaluation of spacer cable or the combination of covered conductor and REFCL. Further if during a feasibility review, if the mitigation is considered infeasible in a specific location due to local conditions, the Review and Revise team will recommend an alternative mitigation.

7.1.4.3 Mitigation Initiative Scheduling

The electrical corporation must report on its schedule for implementing its portfolio of mitigation initiatives. The electrical corporation must describe its preliminary schedules for each initiative and its iterative processes for modifying mitigation initiatives (Section 7.1.4.1).

Mitigation initiatives may require several years to implement. For example, relocating transmission or distribution capabilities from overhead to underground may require substantial time and resources. Since mitigation initiatives are undertaken in high-risk regions, the electrical corporation may need interim mitigation initiatives to mitigate risk while working to implement long-term strategies. Some examples of interim mitigation initiatives include more frequent inspections, fire detection and monitoring activities, and PSPS usage. If the electrical corporation's mitigation initiative requires substantial time to implement, the electrical corporation must identify and deploy interim mitigation initiatives as described in Section 6.3.1.

In its WMP submission, the electrical corporation must provide a summary description of the procedures it uses in developing and deploying mitigation initiatives. This discussion must include the following:

- *How the electrical corporation schedules mitigation initiatives.*
- *How the electrical corporation evaluates whether an interim mitigation initiative is needed and, if so, how an interim mitigation initiative is selected (see Section 7.2.3)*
- *How the electrical corporation monitors its progress toward its targets within known limitations and constraints. This should include descriptions of mechanisms for detecting when an initiative is off track and for bringing it back on track.*

¹²⁵ Examples include tree to conductor contact, animal contact between phase wires and pole.

- *How the electrical corporation measures the effectiveness of mitigation initiatives (e.g., tracking the number of protective equipment and device settings de-energizations that had the potential to ignite a wildfire due to observed damage/contact prior to re-energization). The mitigation sections of these Guidelines (Sections 8) include specific requirements for each mitigation initiative.*

Initiative Implementation Process and Schedule

While SCE's risk models continue to evolve, a guiding principle in scheduling mitigation initiatives is to prioritize work to reduce wildfire risk as expeditiously and efficiently as possible.

The following describes SCE's approach to mitigation scheduling by major mitigation category:

Grid Hardening activities are scheduled and scoped on a multi-year basis due to the long lead times to perform advanced planning tasks such as engineering, sourcing, permitting, municipal coordination, and resource allocation.

Inspections are scheduled on a risk-informed annual basis as described in Sections 8.1.3.1 and 8.1.3.2. At a minimum, SCE performs inspections on a cadence that meets or exceeds CPUC requirements with the riskiest areas getting the most frequent inspections.

Vegetation Management activities are also scheduled on a risk-informed basis as described in Sections 8.2.2.3 and 8.2.3.4. SCE performs vegetation management activities that meet or exceed CPUC requirements.

Activities related to **Situational Awareness, Emergency Preparedness, and Community Outreach and Engagement** are typically performed on an ongoing basis, with some seasonal variation, and are not scheduled in the same sense as hardening, inspection, and vegetation management activities. Please see Sections 8.3, 8.4, and 8.5 (respectively) for further detail.

Generally, SCE implements its wildfire mitigations through a process that consists of four phases: Initiate, Planning, Scheduling and Execute. The phases are defined below:

- Initiate is the process of developing the scope based on risk data.
- Planning involves engineering and design as well as initiating early permit application requirements
- Scheduling involves performing standard permitting and easement processes, environmental clearance processes, and verifying other permits. Additionally, during this phase materials are acquired, work is scheduled, and circuit maps finalized.
- Execution involves the construction and deployment of the activity.

For the initiate phase, initial selection and scoping is based on areas of highest risk, as defined by the three risk tranches in the IWMS Framework. SCE addresses those circuit-segments and circuits which present the greatest risk. However, SCE will often bundle work related to multiple and/or contiguous circuit-segments together to achieve operational efficiencies. For example, the risk associated with each circuit may not be uniform along its length. In other words, the risk can vary within a circuit, especially if that circuit traverses various parts of HFRA and is exposed to varying topography and vegetation that can influence fire propagation and consequence.

In some cases, it may be operationally efficient and prudent to remediate relatively lower risk segments of a circuit at the same time relatively higher risk segments of the same circuit are addressed, instead of sending

multiple crews out at multiple different times, requiring the development of separate work scope packages. Bundling work can also reduce community and environmental impacts by working in a location once versus sending crews to the same area multiple times.

The planning phase is next, once scope is selected. During this phase, a project manager is assigned to oversee the work and design resources are assigned to initiate the work order, design the project, map the circuit miles, procure the materials, and initiate obtaining permits. On average, this process takes six to nine months for WCCP and nine to fifteen months for TUG, assuming there are no completing resources for planning and no delays in environmental/agency approvals. Relatively higher risk segments might be remediated after other segments if it is more difficult to design or procure permits for them.

Scheduling begins with SCE’s regional districts when the work is fully designed, permitted (including obtainment of easements), and cleared of environmental constraints. Scheduling is where materials are acquired, permits are verified, work is scheduled, and circuit maps are revised if found inconsistent with what is shown in the database. Design resources and project management teams also collaborate with customers, local government and state agencies to provide project details to obtain necessary easements prior to the start of construction. Scheduling can take between six to nine months for WCCP and nine to fifteen months for TUG.

In the execution phase, construction will proceed with necessary environmental monitoring if required. There are many factors that may affect the construction timeline including, for example, the size of the project, location of the project, terrain, environmental restrictions, weather (e.g., rain/snow, RFW days, etc.), resource availability and ensuring adherence to city requirements.

Every project will have unique factors that impact project timelines. For example, in many cases Qualified Electrical Workers (QEWs) are required to perform the electrical construction work. SCE uses a combination of SCE and external contractor crews to perform this work. The determination of which to utilize is based on crew availability, work priorities, location, and other factors.

Sample timelines for implementation of SCE’s mitigation initiatives, assuming favorable conditions and no significant delay due to permitting or other reasons, are shown below in Table SCE 7-07. For inspection and vegetation management activities, the sample timelines are shown for the remediation portion of the work, as opposed to the inspection.

Table SCE 7-07 - Project Timelines for Wildfire Mitigations

Tracking ID	Mitigation	Initiate	Planning	Schedule	Execute	Total
SH-1	Covered Conductor	2-3 months	6-9 months	6-9 months	2-3 months	16 - 24 months
SH-2	Undergrounding Overhead Conductor	2-3 months	9-15 months	9-15 months	5-15 months	25 - 48 months
SH-4	Branch Line Protection Strategy ¹²⁶	1-2 months	3-4 months	10-11 months	10-11 months	14-17 months
SH-5	Remote Controlled Automatic Reclosers Settings Update ¹²⁷	1-3 months	1-3 months	1-2 months	1-4 months	4 - 12 months

¹²⁶ The schedule phase and execute phase for Branch Line Protection Strategy overlap

¹²⁷ Combines installation of Remote Controlled Automatic Reclosers (RAR) and RAR settings update

Tracking ID	Mitigation	Initiate	Planning	Schedule	Execute	Total
SH-6	Circuit Breaker Relay Hardware for Fast Curve	2-3 months	1-2 months	1-2 months	12-24 months	16-31 months
SH-8	Transmission Open Phase Detection	1-2 months	3-6 months	2-4 months	3-6 months	9 - 18 months
SH-10	Tree Attachments Remediation	2-3 months	6-8 months	9-10 months	12-14 months	26 - 35 months
SH-14	Long Span Initiative (LSI)	2-3 months	1-9 months	1-3 months	1-6 months	5 - 21 months
SH-15	Vertical Switches	Completed	1-2 months	1-2 months	1-2 months	3-6 months
SH-16	Vibration Damper Retrofit ¹²⁸	1-2 months	3-4 months	10-11 months	10-11 months	14 - 17 months
SH-17	Rapid Earth Fault Current Limiters (REFCL) - Ground Fault Neutralizer	2-3 months	12-72 months	4-9 months	6-12 months	24 - 96 months
SH-18	REFCL (Grounding Conversion)	2-3 months	4-18 months	2-4 months	2-4 months	10 - 29 months
SA-11	Early Fault Detection	1-2 months	3-6 months	2-4 months	3-6 months	9 - 18 months
IN-1.1	Distribution High Fire Risk-Informed Remediations	1day	5 – 11 months	1 month	1day	6 –12 months
IN-1.2	Transmission Risk-Informed Remediations	1day	5 – 11 months	1 month	1day	6 –12 months
IN-3	Distribution Infrared Remediations	1day	5 – 11 months	1 month	1day	6 –12 months
IN-4	Transmission Infrared Remediations	1day	5 – 11 months	1 month	1day	6 –12 months
IN-5	Generation High Risk Informed Inspections & Remediations	4-6 months	2-3 months	1-2 months	12 months	19 - 23 months
IN-9	Transmission Conductor & Splice Remediations	1day	5 – 11 months	1 month	1day	6 –12 months
VM-1	Hazard Tree Mitigation Program	1 day	1-2 months	1-2 month	1 day	2-4 months
VM-2	Structure Brushing Remediations	<1 day	<1 day	<1 day	<1 day	1 day
VM-3	Expanded Clearances for Legacy Facilities	1 day	1-2 months	1 month	1 week	2-3 months

¹²⁸ The schedule phase and execute phase for Vibration Damper Retrofit overlap

Tracking ID	Mitigation	Initiate	Planning	Schedule	Execute	Total
VM-4	Dead and Dying Tree Removal	1 day	1-2 months	1-2 month	1 day	2-4 months
VM-7	Distribution Line Clearances	1 day	1-2 months	1 month	1 day	2-3 months
VM-8	Transmission Line Clearances	1 day	1-2 months	1 month	1 day	2-3 months

Interim Strategy Development

Please see Section 7.2.3 Interim Mitigation Initiatives for the explanation of interim strategy development.

Project Management Controls/Target Tracking

On an annual basis, SCE's performance management organization works with the strategy and execution teams to develop internal monthly and/or quarterly project plans for all WMP activities and targets.

The project plans are used in conjunction with other lagging and leading indicators to measure the monthly performance of the WMP activities in achieving their targets, as well as to proactively identify issues throughout the year that may affect an activity's performance. Key performance insights are consolidated into a performance dashboard and presented and discussed on a monthly basis with SCE executives and key leaders. The purpose of the dashboard is to:

- Clearly communicate WMP activities
- Monitor progress toward monthly / annual goals
- Measure delivery of key objectives
- Develop corrective action plans when activities fall behind plan

Performance issues are immediately raised within the respective execution teams, including identification of the key drivers / issues and a plan for resolution and recovery.

Performance highlights are also summarized and provided monthly to OEIS with a monthly report-out on activities that are behind-plan or at-risk of meeting their year-end targets.

On a quarterly basis, SCE further summarizes progress toward meeting its WMP commitments through development and delivery of the following deliverables to Energy Safety:

- Quarterly Notification Letter
- Quarterly Data Report - Geographic Information System (GIS) Data
- Quarterly Data Report – Wildfire Mitigation Data Tables

On an annual basis, SCE submits an Annual Report of Compliance (ARC) that details SCE's performance against its WMP, including a review of the wildfire mitigation initiatives implemented and an accounting of whether SCE met its performance targets, whether spending on any of those initiatives did not reach anticipated levels, and whether SCE followed its QA/QC processes.

SCE closely monitors the financial impacts of its wildfire mitigation portfolio on a regular basis, including through the following mechanisms described below.

Recording and reporting of actual spend: Costs incurred for WMP activities record to specific wildfire-related internal accounting codes. This allows SCE to properly track recorded costs against the WMP forecast.

Sarbanes-Oxley (SOX) controls: On a monthly basis, SCE’s Finance organization performs SOX control testing on distribution inspection and remediation work orders to help ensure proper accounting. The Finance organization also performs SOX control testing on selected mitigations such as vegetation management, aerial inspections, wildfire remediations, and covered conductor expenditures to help ensure current monthly goods and services received and work performed are properly accrued and accounted for.

Performance Reviews and Year-End Projections: On a monthly basis, SCE’s Finance organization partners with execution organizations to refresh assumptions for year-end financial projections for each activity. Throughout the course of the year, various factors may impact the achievement of year-end financial forecasts, including resource costs, work delays or acceleration, etc. SCE reviews variance analyses for work performed to-date, understands changes to cost-pers, and evaluates impacts to year-end financial projections. Any material updates to activity financial projections are approved through internal governance.

Mitigation Initiative Effectiveness

How the electrical corporation measures the effectiveness of mitigation initiatives (e.g., tracking the number of protective equipment and device settings de-energizations that had the potential to ignite a wildfire due to observed damage/contact prior to re-energization). The mitigation sections of these Guidelines (Sections 8) include specific requirements for each mitigation initiative.

Please see in the Performance Metrics tables in Sections 8.1, 8.2, 8.3, 8, Community Outreach and Engagement and 9 for Performance Metrics that SCE has selected for each WMP category. Additional performance metrics are provided in SCE’s Wildfire Mitigation Data Tables. SCE will use these metrics, along with other data such as field observations and ignition investigations, to help inform its annual evaluation and calculation of mitigation initiatives’ effectiveness against risk drivers, as discussed in Section 7.1.4.1.

SCE also considers learnings from observed risk events as potentially relevant to evaluating mitigation effectiveness. This discussion can be found in Section 10 (Lessons Learned) and Section 11 (Corrective Action Program). These types of learnings may provide insight that SCE uses to adjust or change its approach.

As SCE has stated in prior regulatory filings,¹²⁹ risk outcomes and events will vary from year to year based on factors such as weather, system conditions, and other variables. SCE actively monitors risk events and performance metrics, but also understands that a complete understanding of mitigation effectiveness takes several years of observed field data to account for short-term and annual variations inherent in any real-world deployment.

SCE may also use formal studies and analysis to understand mitigation effectiveness. For example, as

¹²⁹ See, e.g., SCE’s 2022 WMP – Chapter 6.3; November 28, 2022 SCE Opening Comments on Draft Annual Report on Compliance for Southern California Edison’s 2020 Wildfire Mitigation Plan; November 22, 2021 SCE Comments on Draft Resolution M-4860 and Related Attachments.

described in SCE's Covered Conductor Compendium,¹³⁰ SCE performed benchmarking with other utilities around the world, reviewed literature for best practices, and worked with research institutions and suppliers to perform testing on the effectiveness of covered conductor.

Additionally, SCE also recently worked with other California IOUs to commission Exponent, an independent third party, to review potential failure modes of overhead lines, both bare and covered, and performed additional testing to understand the effectiveness of covered conductor. This additional independent testing on covered conductor effectiveness evaluated phase-to-phase contact and simulated wire-down testing. "CCs were 100% effective at preventing arcing and ignition in tested scenarios at rated voltages. This is consistent with documented field experience as reported in Exponent's Phase I report."¹³¹

¹³⁰ SCE's Covered Conductor Compendium is available at <https://www.sce.com/safety/wild-fire-mitigation>

¹³¹ See "Joint IOU Covered Conductor Testing Cumulative Report 12-22-22_Redacted", Exponent, pg. vi this document is also available at <https://www.sce.com/safety/wild-fire-mitigation>

7.2 Wildfire Mitigation Strategy

Each electrical corporation must provide an overview of its proposed wildfire mitigation strategies based on the evaluation process identified in Section 7.1.

7.2.1 Overview of Mitigation Initiatives and Activities

The electrical corporation must provide a high-level summary of the portfolio of mitigation initiatives across its service territory. In addition, the electrical corporation must describe its reasoning for the proposed portfolio of mitigation initiatives and why it did not select other potential mitigation initiatives.

Additionally, for each mitigation initiative category, the electrical corporation must provide the following:

- *A high-level overview of the selected mitigation initiatives*
- *An implementation plan, including its schedule and how progress will be monitored*
- *How the need for any interim mitigation initiatives was determined and how interim mitigation initiatives were selected (see Section 7.2.3)*

Overview

Please see Section 7.1.4, in particular, Table SCE 7-02, Table SCE 7-03, Table SCE 7-04, Table SCE 7-05, Table SCE 7-06 and Table SCE 7-07, for a high-level summary of SCE's portfolio of mitigation initiatives. SCE employs a combination of complementary activities in the categories of grid hardening, asset inspections, vegetation management, grid operations and situational awareness that are developed and targeted to address local wildfire and PSPS conditions. These activities are further complemented by Emergency Preparedness and Community Outreach and Engagement activities.

For an explanation of SCE's mitigation selection process, including choices when multiple options may be available, please see Section 7.1.4.1. SCE's IWMS, which guides mitigation prioritization and selection (e.g., should a given area receive undergrounding, covered conductor, more frequent inspections, etc.), is described in Section 7.1.4.2. The three risk tranches defined by the IWMS Risk Framework are primarily used to determine prioritization and selecting mitigations for grid hardening, vegetation management, and asset inspection activities.

Implementation Plan

Please see Table SCE 7-08, which provides a category level overview, information on the implementation plan for each category, and interim mitigation strategies. The table below contains information at a summary level; see Sections 8.1 through Community Outreach and Engagement for more detail on the various mitigation initiatives for each category in SCE's wildfire mitigation portfolio.

Section 7.2.3 Interim Mitigation Initiatives provides additional detail on interim mitigation initiatives that accompany this plan to address near-term risks while longer-lead time initiatives are implemented.

Please also see Table 7-2, which SCE has populated based on the template provided in the Final Guidelines. SCE has interpreted this requirement as a table that lists the 3- and 10-year objectives by initiative category.

Table SCE 7-08 - Proposed Wildfire Mitigation Portfolio Category Overview

Initiative Category	Overview	Implementation Plan	Interim Initiative Selection
<p>Grid Design, Operations, and Maintenance (System Hardening)</p> <p>Sections 8.1.2, 8.1.8</p>	<p>Mitigation initiatives in this category are implemented to maintain, strengthen, and upgrade electrical equipment and infrastructure to reduce the risk of fire ignitions in the HFRA.</p> <p>Key initiatives include Covered Conductor (SH-1), Targeted Undergrounding (SH-2), REFCL (SH-17 and SH-18), and Circuit Breaker Relay Hardware for Fast Curve (SH-6).</p>	<p>SCE’s grid hardening initiatives follow the Initiate, Plan, Schedule and Execute approach as described in 7.1.4.3. Initiatives have various timelines for them to be installed in the field (e.g., WCCP takes ~16-24 months to implement).</p>	<p>SCE determines the interim mitigation(s) by the proposed long-term mitigation strategy (covered conductor or Targeted Undergrounding) that will be deployed using SCE's IWMS. Areas that will be undergrounded will have interim mitigations deployed such as asset inspections (at the most frequent interval), vegetation management, and fast curve settings, that are complementary to covered conductor while the segment is waiting to be undergrounded. See Section 7.2.3 Interim Mitigation Initiatives for more details.</p>
<p>Grid Design, Operations, and Maintenance (Asset Inspections)</p> <p>Section 8–8.1.7</p>	<p>Mitigation initiatives in this category are aimed at inspecting assets in HFRA and remediating identified issues in a timely manner.</p> <p>Key initiatives include Distribution and Transmission High Fire Risk-Informed (HFRI) Inspections & Remediations (IN-1.1 and IN-1.2)</p>	<p>SCE conducts detailed inspections of each structure within HFRA at least once every three years. All structures in areas identified as ‘Severe Risk Area’ will be inspected annually at minimum.</p>	<p>Due to their repeated and cyclical nature, inspection initiatives generally don’t require interim initiatives. Inspections may be used as interim mitigations for other initiatives.</p>
<p>Grid Design, Operations, and Maintenance (Operations)</p> <p>Section 8.1.8</p>	<p>The settings covered by this category are aimed at reducing the risk of wildfires during periods of elevated fire conditions. Key settings include Fast Curve and blocking automatic reclosers.</p>	<p>Implementation time to activate settings during periods of elevated fire threats is very brief where the equipment is capable of those settings.</p>	<p>Due to the short timeframe to activate settings on equipment, protective settings generally don’t require interim initiatives. Protective settings may be used as interim mitigations for other initiatives.</p>

Initiative Category	Overview	Implementation Plan	Interim Initiative Selection
Vegetation Management and Inspection Section 8.2	<p>Mitigation initiatives in this category are aimed at preventing risks to public safety and system reliability by managing vegetation in proximity to SCE’s electric facilities.</p> <p>Key initiatives include Hazard Tree Management Program (VM-1), Structure Brushing (VM-2), Dead and Dying Tree Removal (VM-4), Distribution Line Clearances (VM-7) and Transmission Line Clearances (VM-8).</p>	<p>Vegetation HTMP inspections are risk prioritized. Grids in the highest risk category follow an annual inspection cycle, while less risky grids follow a three-year inspection cycle. Routine line clearing is performed annually, or more often as needed.</p>	<p>Due to their repeated and cyclical nature, vegetation management initiatives generally don’t require interim initiatives. They may be used as interim mitigations for other initiatives.</p>
Situational Awareness and Forecasting Section 8.3	<p>Mitigation initiatives in this category are aimed at improving SCE’s weather and fuels modeling and enhancing SCE’s visibility of conditions on the system via enhanced monitoring.</p> <p>Key initiatives include Weather Stations (SA-1), Weather and Fuels Modeling System (SA-3) and HD Cameras (SA-10).</p>	<p>SCE prioritizes weather station installations on HFRA circuits that are most likely to exceed PSPS wind thresholds. All distribution circuits that met or exceeded PSPS wind thresholds in the past five years have at least one weather station installed.</p> <p>SCE partners with UCSD to install HD cameras in locations where its Fire Science Team, Fire Management Team, IMT and/or fire agencies provide insight for rural areas needing views to assist in confirming the start of a fire.</p>	<p>Due to the relatively short implementation time of these initiatives, SCE generally does not have interim initiatives. As they’re being installed, SCE relies upon previously installed units. For example, while new HD cameras are being installed, SCE relies upon HD cameras already in place.</p>
Emergency Preparedness Section 8.4	<p>Mitigation initiatives in this category are aimed at preparing SCE’s response teams for hazards that potentially impact SCE’s service area, including service restoration and supporting customers and</p>	<p>Aerial suppression resources can be deployed after the onset of a fire to help reduce the area burned and number of structures damaged or destroyed.</p>	<p>Due to their relatively short implementation time and cyclical nature, SCE generally does not have interim initiatives for initiatives in this category.</p>

Initiative Category	Overview	Implementation Plan	Interim Initiative Selection
	<p>communities during PSPS events.</p> <p>Key initiatives include Adequate and trained workforce for service restoration SCE Emergency Responder Training (DEP-2) Aerial Suppression (DEP-5), and Critical Care Backup Battery Program (PSPS-2).</p>	<p>During PSPS events, SCE uses Community Resource Centers and Community Crew Vehicles to provide support to customers in areas most likely to experience shutoffs.</p>	
<p>Community Outreach and Engagement Section 8.5</p>	<p>Mitigation initiatives in this category are aimed at engaging customers, the community and other stakeholder groups on information about PSPS, emergency preparedness, and SCE’s wildfire mitigation plan efforts.</p> <p>Key initiatives include Community Meetings (DEP-1.2) and Customer Research and Education (DEP-4)</p>	<p>SCE will implement a customer-centric, integrated communications strategy to deliver consistent and cohesive messaging across traditional and digital channels to increase wildfire/PSPS customer education and preparedness.</p>	<p>Due to their relatively short implementation time and cyclical nature, SCE generally does not have interim initiatives for initiatives in this category.</p>

Table 7-3 - List and Description of Electrical Corporation-Specific WMP Mitigation Initiatives for 3-year and 10-year Outlooks

WMP Category	Within 3 Years	Within 10 Years	Location in WMP
Grid design, Operations, and Maintenance	<ul style="list-style-type: none"> • Continue to perform targeted grid hardening to minimize impact on customers by reducing the scope and frequency of PSPS • Continue to prioritize grid hardening deployment based on the IWMS Risk Framework • Continue to deploy protection system mitigations and also refine circuit protection strategies to further reduce wildfire risk while balancing system reliability • Continue evaluation of emerging technologies to determine if any should be added to the grid hardening wildfire mitigation portfolio • Perform assessments of transmission hardening options and develop potential pilots/programs (contingent upon results of assessments) • Evaluate and update the inspection form regarding distribution and transmission high fire risk-informed (HFRI) inspections to reduce time required for data capture while still capturing critical information and incorporating lessons learned of potential failure modes • Continue to align scope selection of inspection programs with the IWMS Risk Framework • Develop and implement risk-prioritized remediations to reduce backlog of asset notifications 	<ul style="list-style-type: none"> • Complete all proactive wildfire mitigation grid hardening • Obtain and implement more programmatic permitting that allows more streamlined execution of grid hardening work • Scale any new successful emergent technologies to supplement existing foundational grid hardening mitigations • If feasible and applicable, implement programs/pilots resulting from integrated transmission hardening strategy development and analysis • Integrate AI/ML analytical tools into inspection image data analysis to identify assets and defects • Integrate new technological tools into data collection for asset inspections (e.g., LiDAR) to identify defects (e.g., clearance issues) that need remediation • Maintain backlog at minimum levels and with as little fire risk as possible 	Section 8.1
Vegetation Management	<ul style="list-style-type: none"> • Complete Joint-IOU Effectiveness of Enhanced Clearances Study • Deploy centralized inspection strategy and transition to circuits from grids • Develop and implement a risk-informed process to minimize backlog • Make substantial progress on evaluating remote sensing technology for vegetation inspections 	<ul style="list-style-type: none"> • Replace a majority of ground inspection for vegetation line clearing in HFRA with remote sensing technology (e.g., LiDAR, satellite), subject to the evolution and effectiveness of the technology • Create and implement predictive growth model to facilitate "auto prescription" to reduce the frequency of manual or remote inspection in HFRA • Optimize vegetation inspection cycles/prescriptions based on risk factors (e.g., species, wind) for more granular locations • Obtain and implement programmatic permits to facilitate timely vegetation management work execution 	Section 8.2
Situational Awareness and Forecasting	<ul style="list-style-type: none"> • Increased data collection (through additional weather station deployment, explore increased collection intervals, and additional SCE HD camera deployment) to expand situational awareness of real-time conditions and refine weather models • Expand data analysis supporting wildfire mitigation efforts, advance fire potential forecasting further, and improve modeling efforts as it relates to fire science • Increase ability to detect issues (e.g., damage and degradation) on the electric grid prior to risk events occurring • Review emerging technologies to improve weather situational awareness and forecasting capabilities for potential evaluation or adoption • Continue to increase situational awareness and improve the accuracy of weather forecasting to help optimize the scope of PSPS events 	<ul style="list-style-type: none"> • Incorporate climate modeling (e.g., impacts of climate change) into medium- and long-term weather and fire potential forecasts • Continue to incorporate technologies and pilots into grid monitoring 	Section 8.3

WMP Category	Within 3 Years	Within 10 Years	Location in WMP
Emergency Preparedness	<ul style="list-style-type: none"> • Maintain a comprehensive all-hazards planning and preparedness program to provide effective emergency response and to safely and expeditiously restore service during and after a major event • Provide effective and accurate communications to the public before, during and immediately following major outages and emergencies 	<ul style="list-style-type: none"> • Refined emergency planning and preparedness practices and programs to support customers before, during, and following emergency events • Ongoing implementation of lessons learned and findings from After Action Reports (AARs) and other external sources to continuously improve emergency response capabilities 	Section 8.4
Community Outreach and Engagement	<ul style="list-style-type: none"> • Actively collaborating with stakeholder networks and partnerships to better understand customer, community and stakeholder specific needs and develop tailored solutions, including AFN • Meet at least quarterly to provide updates on PSPS enhancement efforts and solicit input for improvement areas in how SCE approaches PSPS overall and provides a forum for stakeholders to propose ways to improve all aspects of PSPS 	<ul style="list-style-type: none"> • Refine stakeholder engagement capabilities through tailored approaches for outreach, engagement and information exchange with customers, communities, and stakeholders • Continue to look for ways to expand engagement with agencies outside of CA, including supporting IWRMC's efforts to expand utility membership base and appoint leaders to its Executive Steering Group 	Section 8.5
PSPS	<ul style="list-style-type: none"> • Re-evaluate existing PSPS windspeed thresholds using engineering-based analysis that considers, among other factors, the effectiveness of covered conductor. • Perform additional grid sectionalization and automation, paired with weather stations, to reduce the scope of PSPS events • Evaluate emerging technology for potential incorporation into PSPS protocols • Continue to increase situational awareness and improve precision of weather forecasting to help optimize the scope of PSPS events 	<ul style="list-style-type: none"> • Sufficiently harden HFRA circuits to reduce potential PSPS impacts by up to 90%¹³² • Incorporate successful emerging technologies into PSPS protocols to optimize scale, scope and frequency of PSPS 	Section 9

¹³² This analysis assumes an average PSPS threshold of 31mph sustained winds or 46mph wind gusts for bare, non-hardened circuits, and compares the average exceedance of that control point versus an average threshold of 40mph sustained winds or 58mph wind gusts for circuits with full covered conductor. Based on historical wind speed and FPI, the average circuit across SCE's service territory breaches the approximated hardened threshold about 90% less.

7.2.2 Anticipated Risk Reduction

In this section, the electrical corporation must present an overview of the expected risk reduction of its wildfire mitigation activities.

The electrical corporation must provide:

- Projected overall risk reduction
- Projected risk reduction on highest-risk circuits over the three-year WMP cycle

7.2.2.1 Projected Overall Risk Reduction

In this section, the electrical corporation must provide a figure showing the overall utility risk in its service territory as a function of time, assuming the electrical corporation meets the planned timeline for implementing the mitigations. The figure is expected to cover at least 10 years. If the electrical corporation proposes risk reduction strategies for a duration longer than ten years, this figure must show that corresponding time frame. Figure 7-1. is an example of a graph showing the long-term projected changes in overall risk.

As part of IWMS, SCE uses MARS to help quantify risk at a particular point of time and then to demonstrate risk reduction. Please see Figure 7-1, where SCE has projected overall risk in HFRA for the years of 2023 through 2028 (represented by the blue dots), which covers the current WMP cycle and the forecast period in SCE’s 2025 General Rate Case. SCE has assumed a steady state risk level for the years of 2029 through 2032 (represented by the red dots), as SCE has not currently planned or scoped incremental mitigations after 2028, other than the replacement of retired overhead bare distribution wire with covered conductor pursuant to SCE’s design standards in HFRA.

Figure 7-1 - Projected Overall HFRA Risk

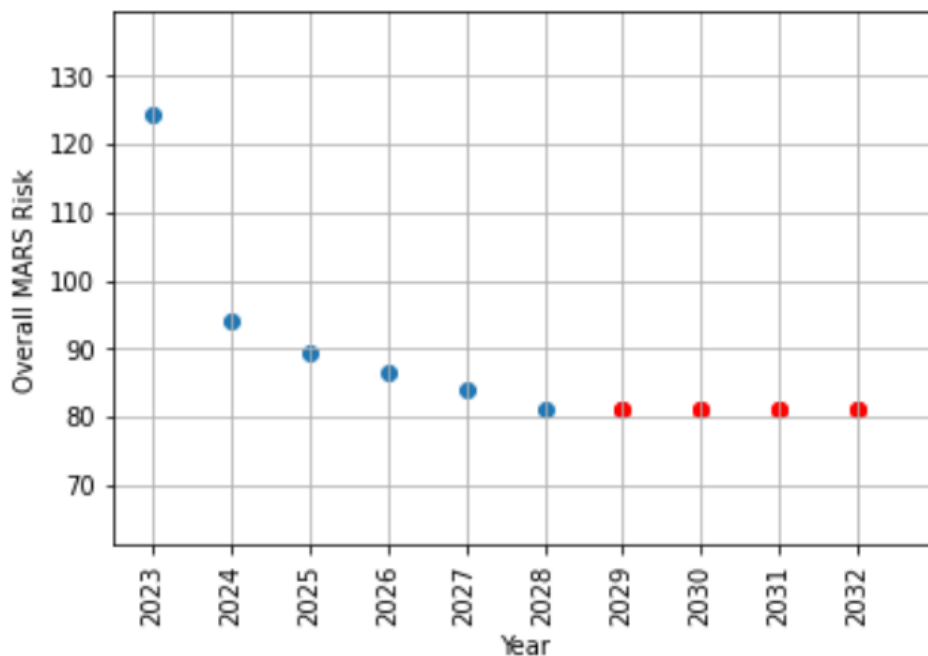

7.2.2.2 Risk Impact of Mitigation Initiatives

The electrical corporation must calculate the expected “x% risk impact” of each of its mitigation initiative activity targets for each year from 2023–2025. The expected x% risk impact is the expected percentage risk reduction on the last day of each year compared to the first day of that same year. For example: For protective devices and sensitivity settings, the risk on Jan. 1, 2024 = 2.59×10^{-1} After meeting its planned initiative activity targets for protective devices and sensitivity settings, the risk on Jan. 1, 2024 = 1.29×10^{-1} The expected x% risk impact for the protective devices and sensitivity settings initiative in 2024 is:

$$\frac{\text{risk before} - \text{risk after}}{\text{risk before}} \times 100$$
$$\frac{2.59 \times 10^{-1} - 1.29 \times 10^{-1}}{2.59 \times 10^{-1}} \times 100 = 50\%$$

The expected “x% risk impact” numbers must be reported for each planned mitigation initiative activities in the specific mitigation initiative sections of Section 8 (see example tables in Section 8).

7.2.2.3 Projected Risk Reduction on Highest-Risk Circuits Over the Three- Year WMP Cycle

The objective of the service territory risk reduction summary is to provide an integrated view of wildfire risk reduction across the electrical corporation’s service territory. The electrical corporation must provide the following information:

- Tabular summary of number risk reduction for each high-risk circuit, showing risk levels before and after the implementation of mitigation initiatives. This must include the same circuits, segments, or span IDs presented in Section 6.4.2. The table must include the following information for each circuit
 - **Circuit, Segment, or Span ID:** Unique identifier for the circuit, segment, or span.
 - If there are multiple initiatives per ID, each must be listed separately, using an extender to provide a unique identifier
 - **Overall Utility Risk:** Numerical value for the overall utility risk before and after each mitigation initiative.
 - **Mitigation initiatives by implementation year:** Mitigation initiatives the electrical corporation plans to apply to the circuit in each year of the WMP cycle.

Table 7-4 provides an example of a summary of risk reduction for top-risk circuits.

Table 7-4 shows the same circuits presented in Section 6.4.2, using MARS to rank them by overall utility risk in HFRA. To be clear, the existing risk as of January 1, 2023 takes into account covered conductor that was installed prior to 2023. Residual risk may remain high according to MARS for some circuits even after covered conductor is installed due to high potential consequence in those areas. SCE provides a more detailed description of the top-risk circuits below.

Table 7-4 - Summary of Risk Reduction for Top-Risk Circuits

<i>Circuit</i>	<i>Jan. 1, 2023 Overall utility risk</i>	<i>Jan. 1, 2023 – Dec. 31, 2023 Mitigation Initiatives</i>	<i>Jan. 1, 2024 Overall utility risk</i>	<i>Jan. 1, 2024 – Dec. 31, 2024 Mitigation Initiatives</i>	<i>Jan. 1, 2025 Overall utility risk</i>	<i>Jan. 1, 2025 – Dec. 31, 2025 Mitigation Initiatives</i>	<i>Jan. 1, 2026 Overall utility risk</i>
SHOVEL	3.3369	Covered Conductor, REFCL, Branch Line Fuses Risk-Informed Inspections and Remediations and Vegetation Management	1.2043	Risk-Informed Inspections and Remediations and Vegetation Management	1.2042	Covered Conductor, Vibration Damper, Risk-Informed Inspections and Remediations and Vegetation Management	1.1929
KENO	2.6917	Covered Conductor, REFCL, Branch Line Fuses Risk-Informed Inspections and Remediations and Vegetation Management	0.8053	Risk-Informed Inspections and Remediations and Vegetation Management	0.8053	Risk-Informed Inspections and Remediations and Vegetation Management	0.8020
PIONEERTOWN	2.6574	Covered Conductor, Branch Line Fuses, Risk-Informed Inspections and Remediations and Vegetation Management	2.2198	Risk-Informed Inspections and Remediations and Vegetation Management	2.2198	Covered Conductor, Risk-Informed Inspections and Remediations and Vegetation Management	2.1544
ERSKINE	2.6531	Covered Conductor, Branch Line Fuses, Risk-Informed Inspections and Remediations and Vegetation Management	1.4525	Long Span Initiative, Risk-Informed Inspections and Remediations and Vegetation Management	1.4503	Long Span Initiative, Risk-Informed Inspections and Remediations and Vegetation Management	1.4500
GAMBLER	2.3818	Covered Conductor, REFCL, Branch Line Fuses Risk-Informed Inspections and Remediations and Vegetation Management	0.6075	Risk-Informed Inspections and Remediations and Vegetation Management	0.6075	Risk-Informed Inspections and Remediations and Vegetation Management	0.6071
LASKER	2.0455	Covered Conductor, Branch Line Fuses, Risk-Informed Inspections and Remediations and Vegetation Management	0.9112	Risk-Informed Inspections and Remediations and Vegetation Management	0.9112	Risk-Informed Inspections and Remediations and Vegetation Management	0.9078
MUSTANG	2.0347	Covered Conductor, Branch Line Fuses, Vertical Switches Risk-Informed Inspections and Remediations and Vegetation Management	1.1127	Covered Conductor, Risk-Informed Inspections and Remediations and Vegetation Management	1.0281	Risk-Informed Inspections and Remediations and Vegetation Management	1.0214
STORES	1.5872	Covered Conductor, Branch Line Fuses, Risk-Informed Inspections and Remediations and Vegetation Management	1.5752	Risk-Informed Inspections and Remediations and Vegetation Management	1.5752	Covered Conductor, Risk-Informed Inspections and Remediations and Vegetation Management	1.5686
POPPET FLATS	1.4363	Covered Conductor, Branch Line Fuses, Risk-Informed Inspections and Remediations and Vegetation Management	1.1715	Long Span Initiative, Risk-Informed Inspections and Remediations and Vegetation Management	1.1689	Risk-Informed Inspections and Remediations and Vegetation Management	1.1678

<i>Circuit</i>	<i>Jan. 1, 2023 Overall utility risk</i>	<i>Jan. 1, 2023 – Dec. 31, 2023 Mitigation Initiatives</i>	<i>Jan. 1, 2024 Overall utility risk</i>	<i>Jan. 1, 2024 – Dec. 31, 2024 Mitigation Initiatives</i>	<i>Jan. 1, 2025 Overall utility risk</i>	<i>Jan. 1, 2025 – Dec. 31, 2025 Mitigation Initiatives</i>	<i>Jan. 1, 2026 Overall utility risk</i>
STONEMAN	1.1219	Covered Conductor, Branch Line Fuses, Long Span Initiative, Risk-Informed Inspections and Remediations and Vegetation Management	0.5823	Vibration Damper, Long Span Initiative, Risk-Informed Inspections and Remediations and Vegetation Management	0.5822	REFCL, Risk-Informed Inspections and Remediations and Vegetation Management	0.2981
MULHOLLAND	1.1129	Covered Conductor, Undergrounding, Branch Line Fuses, Long Span Initiative, Risk-Informed Inspections and Remediations and Vegetation Management	0.6732	Undergrounding, Vibration Damper, Long Span Initiative Risk-Informed Inspections and Remediations and Vegetation Management	0.5433	Covered Conductor, Long Span Initiative, Risk-Informed Inspections and Remediations and Vegetation Management	0.5433
SCHMIDT	1.0296	Covered Conductor, Undergrounding, Branch Line Fuses, Risk-Informed Inspections and Remediations and Vegetation Management	0.6651	Undergrounding, Risk-Informed Inspections and Remediations and Vegetation Management	0.6609	Risk-Informed Inspections and Remediations and Vegetation Management	0.6609
RAYBURN	0.9666	Covered Conductor, Branch Line Fuses, Risk-Informed Inspections and Remediations and Vegetation Management	0.4636	Risk-Informed Inspections and Remediations and Vegetation Management	0.4636	REFCL, Risk-Informed Inspections and Remediations and Vegetation Management	0.2398
PICONI	0.8079	Covered Conductor, Branch Line Fuses, Risk-Informed Inspections and Remediations and Vegetation Management	0.3524	Risk-Informed Inspections and Remediations and Vegetation Management	0.3524	Vibration Damper, Risk-Informed Inspections and Remediations and Vegetation Management	0.3432
PASCAL	0.7527	Covered Conductor, Branch Line Fuses, Risk-Informed Inspections and Remediations and Vegetation Management	0.3579	Risk-Informed Inspections and Remediations and Vegetation Management	0.3579	Risk-Informed Inspections and Remediations and Vegetation Management	0.3579
BURNT MOUNTAIN	0.6542	Branch Line Fuses, Risk-Informed Inspections and Remediations and Vegetation Management	0.6503	Covered Conductor, Risk-Informed Inspections and Remediations and Vegetation Management	0.6346	Risk-Informed Inspections and Remediations and Vegetation Management	0.6346
TUDOR	0.5491	Branch Line Fuses, Risk-Informed Inspections and Remediations and Vegetation Management	0.5473	Risk-Informed Inspections and Remediations and Vegetation Management	0.5473	Covered Conductor, Risk-Informed Inspections and Remediations and Vegetation Management	0.5234
ACROBAT	0.5427	Covered Conductor, Branch Line Fuses, Risk-Informed Inspections and Remediations and Vegetation Management	0.2531	Covered Conductor, Risk-Informed Inspections and Remediations and Vegetation Management	0.2531	REFCL, Risk-Informed Inspections and Remediations and Vegetation Management	0.1128
IDA	0.5036	Covered Conductor, Branch Line Fuses, Risk-Informed Inspections and Remediations and Vegetation Management	0.3919	Risk-Informed Inspections and Remediations and Vegetation Management	0.3919	Risk-Informed Inspections and Remediations and Vegetation Management	0.3906
LOTTO	0.4354	Covered Conductor, REFCL, Branch Line Fuses, Risk-Informed Inspections	0.2755	Covered Conductor, Risk-Informed Inspections and Remediations and Vegetation Management	0.2018	Risk-Informed Inspections and Remediations and Vegetation	0.2013

<i>Circuit</i>	<i>Jan. 1, 2023 Overall utility risk</i>	<i>Jan. 1, 2023 – Dec. 31, 2023 Mitigation Initiatives</i>	<i>Jan. 1, 2024 Overall utility risk</i>	<i>Jan. 1, 2024 – Dec. 31, 2024 Mitigation Initiatives</i>	<i>Jan. 1, 2025 Overall utility risk</i>	<i>Jan. 1, 2025 – Dec. 31, 2025 Mitigation Initiatives</i>	<i>Jan. 1, 2026 Overall utility risk</i>
		and Remediations and Vegetation Management				Management	
BLACKFOOT	0.2768	Covered Conductor, Branch Line Fuses, Risk-Informed Inspections and Remediations and Vegetation Management	0.2611	Risk-Informed Inspections and Remediations and Vegetation Management	0.2611	Risk-Informed Inspections and Remediations and Vegetation Management	0.2573
LUISENO	0.2686	Covered Conductor, Branch Line Fuses, Risk-Informed Inspections and Remediations and Vegetation Management	0.1642	Risk-Informed Inspections and Remediations and Vegetation Management	0.1642	Vibration Damper, Risk-Informed Inspections and Remediations and Vegetation Management	0.1458
PELONA	0.1954	Covered Conductor, Branch Line Fuses, Risk-Informed Inspections and Remediations and Vegetation Management	0.1953	Risk-Informed Inspections and Remediations and Vegetation Management	0.1953	REFCL, Risk-Informed Inspections and Remediations and Vegetation Management	0.0907
RHODA	0.1923	Covered Conductor, Branch Line Fuses, Risk-Informed Inspections and Remediations and Vegetation Management	0.0609	Long Span Initiative, Risk-Informed Inspections and Remediations and Vegetation Management	0.0607	Risk-Informed Inspections and Remediations and Vegetation Management	0.0606
PURCHASE	0.1710	Covered Conductor, Branch Line Fuses, Risk-Informed Inspections and Remediations and Vegetation Management	0.1705	Risk-Informed Inspections and Remediations and Vegetation Management	0.1705	Risk-Informed Inspections and Remediations and Vegetation Management	0.1705
TRIUNFO	0.1463	Undergrounding, Branch Line Fuses, Risk-Informed Inspections and Remediations and Vegetation Management	0.1409	Long Span Initiative, Risk-Informed Inspections and Remediations and Vegetation Management	0.1365	Covered Conductor, Risk-Informed Inspections and Remediations and Vegetation Management	0.1361
PERRIS	0.1409	Covered Conductor, Branch Line Fuses, Risk-Informed Inspections and Remediations and Vegetation Management	0.1397	Risk-Informed Inspections and Remediations and Vegetation Management	0.1397	Risk-Informed Inspections and Remediations and Vegetation Management	0.1384
DINELY	0.1348	Branch Line Fuses, Risk-Informed Inspections and Remediations and Vegetation Management	0.1340	Risk-Informed Inspections and Remediations and Vegetation Management	0.1340	Risk-Informed Inspections and Remediations and Vegetation Management	0.1340
KUFFEL	0.1327	Branch Line Fuses, Risk-Informed Inspections and Remediations and Vegetation Management	0.1322	Covered Conductor, Risk-Informed Inspections and Remediations and Vegetation Management	0.0713	Risk-Informed Inspections and Remediations and Vegetation Management	0.0713
ROTEC	0.1208	Branch Line Fuses, Risk-Informed Inspections and Remediations and Vegetation Management	0.1197	Covered Conductor, Risk-Informed Inspections and Remediations and Vegetation Management	0.0809	Covered Conductor, Risk-Informed Inspections and Remediations and Vegetation Management	0.0801
PHEASANT	0.1139	Covered Conductor, Branch Line Fuses, Risk-Informed Inspections and Remediations and Vegetation	0.1137	Risk-Informed Inspections and Remediations and Vegetation Management	0.1137	Covered Conductor, Risk-Informed Inspections and Remediations and Vegetation Management	0.1123

<i>Circuit</i>	<i>Jan. 1, 2023 Overall utility risk</i>	<i>Jan. 1, 2023 – Dec. 31, 2023 Mitigation Initiatives</i>	<i>Jan. 1, 2024 Overall utility risk</i>	<i>Jan. 1, 2024 – Dec. 31, 2024 Mitigation Initiatives</i>	<i>Jan. 1, 2025 Overall utility risk</i>	<i>Jan. 1, 2025 – Dec. 31, 2025 Mitigation Initiatives</i>	<i>Jan. 1, 2026 Overall utility risk</i>
		Management					
QUINBY	0.0996	Covered Conductor, Risk-Informed Inspections and Remediations and Vegetation Management	0.0343	Covered Conductor, Risk-Informed Inspections and Remediations and Vegetation Management	0.0339	REFCL, Risk-Informed Inspections and Remediations and Vegetation Management	0.0176
PINEWOOD	0.0976	Risk-Informed Inspections and Remediations and Vegetation Management	0.0976	Risk-Informed Inspections and Remediations and Vegetation Management	0.0976	Covered Conductor, Risk-Informed Inspections and Remediations and Vegetation Management	0.0909
BIANCO	0.0861	Branch Line Fuses, Risk-Informed Inspections and Remediations and Vegetation Management	0.0859	Risk-Informed Inspections and Remediations and Vegetation Management	0.0859	Covered Conductor, Risk-Informed Inspections and Remediations and Vegetation Management	0.0840
MUTUAL	0.0853	Covered Conductor, Branch Line Fuses, Long Span Initiative, Risk-Informed Inspections and Remediations and Vegetation Management	0.0494	Long Span Initiative, Risk-Informed Inspections and Remediations and Vegetation Management	0.0489	Risk-Informed Inspections and Remediations and Vegetation Management	0.0489
ROMERO	0.0807	Covered Conductor, Branch Line Fuses, Risk-Informed Inspections and Remediations and Vegetation Management	0.0352	Risk-Informed Inspections and Remediations and Vegetation Management	0.0352	Risk-Informed Inspections and Remediations and Vegetation Management	0.0352
BODKIN	0.0770	Covered Conductor, Branch Line Fuses, Risk-Informed Inspections and Remediations and Vegetation Management	0.0768	Risk-Informed Inspections and Remediations and Vegetation Management	0.0768	REFCL, Risk-Informed Inspections and Remediations and Vegetation Management	0.0416
DICE	0.0738	Covered Conductor, Risk-Informed Inspections and Remediations and Vegetation Management	0.0655	Risk-Informed Inspections and Remediations and Vegetation Management	0.0655	Risk-Informed Inspections and Remediations and Vegetation Management	0.0655
TONTO	0.0660	Covered Conductor, Branch Line Fuses, Risk-Informed Inspections and Remediations and Vegetation Management	0.0296	Risk-Informed Inspections and Remediations and Vegetation Management	0.0296	REFCL, Risk-Informed Inspections and Remediations and Vegetation Management	0.0110
AMETHYST	0.0655	Branch Line Fuses, Risk-Informed Inspections and Remediations and Vegetation Management	0.0636	Risk-Informed Inspections and Remediations and Vegetation Management	0.0636	Risk-Informed Inspections and Remediations and Vegetation Management	0.0636
LA GRANDE	0.0628	Branch Line Fuses, Risk-Informed Inspections and Remediations and Vegetation Management	0.0623	Covered Conductor, Risk-Informed Inspections and Remediations and Vegetation Management	0.0524	Risk-Informed Inspections and Remediations and Vegetation Management	0.0510
DOLORES	0.0571	Branch Line Fuses, Risk-Informed Inspections and Remediations and Vegetation Management	0.0569	Covered Conductor, Risk-Informed Inspections and Remediations and Vegetation Management	0.0444	Risk-Informed Inspections and Remediations and Vegetation Management	0.0444
WAITE	0.0510	Risk-Informed Inspections and Remediations and Vegetation	0.0510	Risk-Informed Inspections and Remediations and Vegetation Management	0.0510	Covered Conductor, REFCL, Risk-Informed Inspections and Remediations	0.0307

<i>Circuit</i>	<i>Jan. 1, 2023 Overall utility risk</i>	<i>Jan. 1, 2023 – Dec. 31, 2023 Mitigation Initiatives</i>	<i>Jan. 1, 2024 Overall utility risk</i>	<i>Jan. 1, 2024 – Dec. 31, 2024 Mitigation Initiatives</i>	<i>Jan. 1, 2025 Overall utility risk</i>	<i>Jan. 1, 2025 – Dec. 31, 2025 Mitigation Initiatives</i>	<i>Jan. 1, 2026 Overall utility risk</i>
		Management				and Vegetation Management	
CRAWFORD	0.0306	Risk-Informed Inspections and Remediations and Vegetation Management	0.0306	Risk-Informed Inspections and Remediations and Vegetation Management	0.0306	Risk-Informed Inspections and Remediations and Vegetation Management	0.0306
SILVA	0.0221	Covered Conductor, Risk-Informed Inspections and Remediations and Vegetation Management	0.0090	Risk-Informed Inspections and Remediations and Vegetation Management	0.0090	Risk-Informed Inspections and Remediations and Vegetation Management	0.0090
PARCO	0.0171	Branch Line Fuses, Risk-Informed Inspections and Remediations and Vegetation Management	0.0169	Covered Conductor, Risk-Informed Inspections and Remediations and Vegetation Management	0.0099	Risk-Informed Inspections and Remediations and Vegetation Management	0.0089
LIMITED	0.0027	Long Span Initiative, Risk-Informed Inspections and Remediations and Vegetation Management	0.0022	Covered Conductor, Long Span Initiative, Risk-Informed Inspections and Remediations and Vegetation Management	0.0007	Risk-Informed Inspections and Remediations and Vegetation Management	0.0007
CHUMASH	0.0027	Risk-Informed Inspections and Remediations and Vegetation Management	0.0027	Risk-Informed Inspections and Remediations and Vegetation Management	0.0027	Risk-Informed Inspections and Remediations and Vegetation Management	0.0027

7.2.3 Interim Mitigation Initiatives

As indicated in Section 7.1.4.3, for each mitigation that will require greater than one year to implement, the electrical corporation must assess the potential need for interim mitigation initiatives to reduce risk until the primary or permanent mitigation initiative is in place. If the electrical corporation determines that an interim mitigation initiative is necessary, it must also develop and implement that initiative as appropriate.

- The electrical corporation must provide a description of the following in this section of the WMP:
- The electrical corporation's procedures for evaluating the need for interim risk reduction
- The electrical corporation's procedures for determining which interim mitigation initiative(s) to implement
- The electrical corporation's characterization of each interim risk management/reduction action and evaluation of its specific capabilities to reduce risks, including:
 - Potential consequences of risk event(s) addressed by the improvement/mitigation
 - Frequency of occurrence of the risk event(s) addressed by the improvement/mitigation

Each interim mitigation initiative planned by the electrical corporation for implementation on high-risk circuits must be listed as a mitigation initiative in Section 8. In addition, interim mitigation initiatives must be discussed in the relevant mitigation initiative sections of the WMP and included in the related target tables.

SCE's overall approach to interim mitigations is based on two considerations. The first are the known risks on the circuit segment. For example, if there are long spans at heightened risk of wire-to-wire contact or heavy trees within range of SCE's facilities. The second is the current expected timeframe for the permanent mitigations to be deployed on the system. Generally speaking, the primary mitigation initiatives that require interim mitigation strategies due to their lead times are covered conductor and undergrounding, both of which are explained further below.

SCE deploys one interim mitigation (SH-14, described below), as local conditions require, on segments that will be hardened with covered conductor.

Long Span Initiative (SH-14). This initiative installs line spacers on segments that are at heightened risk of wire-to-wire contact. SCE can implement this remediation relatively quickly, making it an effective interim mitigation option to reduce risk on overhead lines that are especially subject to this risk driver.¹³³ Please see Section 8.1.2.5.2 for more details on LSI.

In addition to the above interim mitigation, SCE will also implement complementary mitigations, as local conditions require, prior to the installation of covered conductor. Mitigations including asset inspections, vegetation management, and fast curve settings will mitigate contact from object, wire-to-wire contact, and equipment failure risk drivers on the circuit segment before covered conductor is installed. In some cases, based on local conditions, SCE may perform additional inspections or vegetation management inspections as part of its Areas of Concern effort, which is described in more detail in Section 8.1. However, unlike LSI, SCE will continue using these mitigations on the circuit segment after covered conductor is installed. As discussed in Section 7.1.4, they complement covered conductor by either

¹³³ LSI may also be installed as a long-term mitigation on wires that are not scoped for covered conductor.

addressing risk drivers that covered conductor doesn't or has relatively lower effectiveness and by adding an extra layer of defense on risk drivers that covered conductor does address.

SCE deploys three interim mitigations on segments that will be hardened with undergrounding. These mitigations will cease in their current form after overhead lines are replaced with underground lines:

1) Long-Span Initiative (SH-14): See comments above.

2) The second interim mitigation is SCE's asset inspection portfolio (e.g., 360-degree inspections and Infrared); for more details, please see Section 7.2.3 Interim Mitigation Initiatives which reduces ignitions caused by overhead equipment failures.

3) SCE's vegetation management portfolio (e.g., expanded line clearing, Hazard Tree Mitigation Program, etc.); for more details, please see Section 8.2, which reduces ignitions caused by vegetation contacting overhead facilities.

SCE will also utilize, if necessary, PSPS in location that are scoped for undergrounding or covered conductor. Until such time as SCE installs covered conductor or undergrounding, SCE will utilize lower winder speed thresholds for bare-conductor isolatable segments. After installation of covered conductor or undergrounding, SCE will either raise de-energization thresholds or, in the case of where a segment and its feeder are undergrounded, not use PSPS. Further details can be found in Sections 8.1.2 and 9.

8 WILDFIRE MITIGATIONS

8.1 Grid Design, Operations, and Maintenance

8.1.1 Overview

In this section, the electrical corporation must identify objectives for the next 3- and 10-year periods, targets, and performance metrics related to the following grid design, operations, and maintenance programmatic areas:

- *Grid design and system hardening*
- *Asset inspections*
- *Equipment maintenance and repair*
- *Asset management and inspection enterprise system(s)*
- *Quality assurance / quality control*
- *Open work orders*
- *Grid operations and procedures*
- *Workforce planning*

8.1.1.1 Objectives

Each electrical corporation must summarize the objectives for its 3-year and 10-year plans for implementing and improving its grid design, operations, and maintenance.¹³⁴ These summaries must include the following:

- *Identification of which initiative(s) in the WMP the electrical corporation is implementing to achieve the stated objective, including Utility Initiative Tracking IDs*
- *Reference(s) to applicable codes, standards, and best practices/guidelines and an indication of whether the electrical corporation exceeds an applicable code, standard, or regulation*
- *Method of verifying achievement of each objective*
- *A target completion date*
- *Reference(s) to the WMP section(s) or appendix, including page numbers, where the details of the objective(s) are documented and substantiated*

This information must be provided in Table 8-1 for the 3-year plan and Table 8-2 for the 10-year plan.

The tables below are based on the examples provided in the Technical Guidelines.

¹³⁴ Annual information included in this section must align with Tables 1 and 12 of the QDR.

Table 8-1 - Grid Design, Operations, and Maintenance Objectives (3-year plan)

Objectives for Three Years (2023–2025)	Applicable Initiative(s), Tracking ID(s)	Applicable Regulations, Codes, Standards, and Best Practices (See Note)	Method of Verification (i.e., program)	Completion Date	Reference (section & page #)
Continue to perform targeted grid hardening to minimize impact on customers by reducing the scope and frequency of PSPS.	<ul style="list-style-type: none"> • WCCP (SH-1) • UG (SH-2) 	<ul style="list-style-type: none"> • GO 95 • SCE Distribution Overhead Construction Standards (DOH) • SCE Distribution Underground Construction Standards (DUG) • GO 128 	Completion of planned targeted covered conductor and/or sectionalization devices each year (which can be through work orders, GIS maps, etc.)	December 2025	Section 8.1.2, pp. 250-257
Continue to prioritize grid hardening deployment based on the IWMS Risk Framework	<ul style="list-style-type: none"> • WCCP (SH-1) • TUG (SH-2) • REFCL (SH-17, SH-18) • Long Span Initiative (SH-14) • Tree Attachment Remediation (SH-10) • Remote Controlled Automatic Reclosers (SH-5) • CB Relays & Fast Curve (SH-6) • Vibration Dampers (SH-16) • Fire Resistant Wrap Retrofit (8.1.2.3.2) • Vertical Switches (SH-15) • Transmission IWMS (8.1.2.12.1) 	<ul style="list-style-type: none"> • GO 95 • GO 165 • SCE DOH • SCE DUG • GO 128 • SCE Distribution Apparatus Construction Standards (DAP) • SCE Electrical Construction Station (ECS) • SCE Electric Design Station Wiring (EDSW) • SCE Distribution Design Standards (DDS) 	Measuring how much of grid hardening mitigation deployed (e.g., number of circuit miles, number of units, number of structures, etc.) is aligned with IWMS	December 2025	Sections 8.1.2, pp. 250-277, 8.1.8, pp. 331 - 342 and pp. 8.3.3, 467-492
Continue to deploy protection system mitigations and also refine circuit protection strategies to further reduce wildfire risk while balancing system reliability	<ul style="list-style-type: none"> • Distribution Open Phase Detection (8.1.8.1.3.3) • Transmission Open Phase Detection (SH-8) • CB Relays & Fast Curve (SH-6) • High Impedance Relay (8.1.8.1.3.1) • Branch line Protection Strategy (SH-4) 	<ul style="list-style-type: none"> • GO 95 	Validation of system updates or installations or review of pertinent outage, event, ignition, risk and/or reliability data to evaluate effectiveness.	December 2025	Sections 8.1.2, pp. 250-277, 8.1.8, pp. 331 - 342 and 8.3.3, pp. 467-492
Continue evaluation of emerging technologies to determine if any should be added to the grid hardening wildfire mitigation portfolio	<ul style="list-style-type: none"> • Remote Grid (8.1.2.9.1) • Spacer Cable 	<ul style="list-style-type: none"> • GO 95 	Provide report of remote grid and spacer cable that includes recommendations for plan and	December 2025	Section 8.1.2, pp. 274-275, 251-253

Objectives for Three Years (2023–2025)	Applicable Initiative(s), Tracking ID(s)	Applicable Regulations, Codes, Standards, and Best Practices (See Note)	Method of Verification (i.e., program)	Completion Date	Reference (section & page #)
			strategy going forward		
Perform assessments of transmission hardening options and develop potential pilots/programs (contingent upon results of assessments)	<ul style="list-style-type: none"> • Transmission IWMS (8.1.2.12.1) • High-risk transition spans 	<ul style="list-style-type: none"> • GO 95 • SCE Transmission Overhead Construction Standards (TOH) 	Provide report of transmission grid hardening assessment that includes recommendations for plan and strategy going forward	December 2025	Sections 8.1.2 p. 278, 8.1.3.2, pp. 289-293
Evaluate and update the inspection form regarding distribution and transmission high fire risk-informed (HFRI) inspections to reduce time required for data capture while still capturing critical information and incorporating lessons learned of potential failure modes.	<ul style="list-style-type: none"> • Inspections and Remediations <ul style="list-style-type: none"> - Distribution High Fire Risk-Informed (HFRI) Inspections and Remediations (IN-1.1) - Transmission FRI Inspections and Remediations (IN-1.2) • Inspection Work Management Tools <ul style="list-style-type: none"> - Inspection and Maintenance Tools (IN-8) - Asset Defect Detection using AI/ML (IN-8) 	<ul style="list-style-type: none"> • GO 95 • GO 165 • SCE Distribution Inspection Maintenance Program (DIMP) • SCE Transmission Inspection Maintenance Program (TIMP) 	Revised/new version of inspection form	December 2025	<p>Section 8.1.3.1, pp. 282-289 (IN-1.1)</p> <p>Section 8.1.3.2, pp. 289-293 (IN-1.2)</p> <p>Section 8.1.5, pp. 319-325 (IN-8)</p>
Continue to align scope selection of inspection programs with the IWMS Risk Framework	<ul style="list-style-type: none"> • Inspections and Remediations <ul style="list-style-type: none"> - Distribution HFRI Inspections and Remediations (IN-1.1) - Transmission HFRI Inspections and Remediations (IN-1.2) - Infrared Inspection of Energized Overhead Distribution Facilities and Equipment (IN-3) - Infrared Inspection, Corona Scanning, and High-Definition Imagery of Energized Overhead Transmission Facilities and Equipment (IN-4) - Generation High Fire Risk-Informed Inspections and Remediations in HFRA (IN-5) 	<ul style="list-style-type: none"> • GO 95 • GO 165 	Percent of overall risk inspected annually for each program	December 2025	<p>Section 8.1.3.1, pp. 282-289 (IN-1.1)</p> <p>Section 8.1.3.2, pp. 289-293 (IN-1.2)</p> <p>Section 8.1.3.5, pp. 297-299 (IN-3)</p> <p>Section 8.1.3.6, pp. 300-302 (IN-4)</p> <p>Section 8.1.3.7, pp. 303-304 (IN-5)</p>

Objectives for Three Years (2023–2025)	Applicable Initiative(s), Tracking ID(s)	Applicable Regulations, Codes, Standards, and Best Practices (See Note)	Method of Verification (i.e., program)	Completion Date	Reference (section & page #)
Develop and implement risk-prioritized remediations to reduce backlog of asset notifications	<ul style="list-style-type: none"> • Inspections and Remediations - Distribution HFRI Inspections and Remediations (IN-1.1) - Transmission HFRI Inspections and Remediations (IN-1.2) 	<ul style="list-style-type: none"> • GO 95 • GO 165 	Number of past due notifications and associated risk of those notifications	December 2025	Section 8.1.3.1, pp. 282-289 (IN-1.1) Section 8.1.3.2, pp. 289-293 (IN-1.2)

Note: An asterisk indicates that the electrical corporation exceeds a particular code, regulation, standard, or best practice. The electrical corporation must provide a reference to the appendix section and page providing further documentation and substantiation.

Table 8-02 - Grid Design, Operations, and Maintenance Objectives (10-year plan)

Objectives for Ten Years (2026–2032)	Applicable Initiative(s), Tracking ID(s)	Applicable Regulations, Codes, Standards, and Best Practices (See Note)	Method of Verification (i.e., program)	Completion Date	Reference (section & page #)
Complete all proactive wildfire mitigation grid hardening.	<ul style="list-style-type: none"> • WCCP (SH-1) • Inspections and Remediations <ul style="list-style-type: none"> - Distribution HFRI Inspections and Remediations (IN-1.1) - Transmission HFRI Inspections and Remediations (IN-1.2) 	<ul style="list-style-type: none"> • GO 95 • Rule 22.8 • GO 128 • GO 165 • SCE DOH • SCE DUG 	All IWMS areas identified have been hardened with the appropriate mitigation based on all factors considered (e.g., feasibility)	December 2032	Section 8.1.3.1, pp. 282-289 (IN-1.1) Section 8.1.3.2, pp. 289-293 (IN-1.2)
Obtain and implement more programmatic permitting that allows more streamlined execution of grid hardening work	<ul style="list-style-type: none"> • WCCP (SH-1) • TUG (SH-2) • Inspections and Remediations <ul style="list-style-type: none"> - Distribution HFRI Inspections and Remediations (IN-1.1) - Transmission HFRI Inspections and Remediations (IN-1.2) 	<ul style="list-style-type: none"> • GO 95 • GO 165 	Programmatic permit documents that were executed	2026-2028	Section 5.4.5 - Environmental Compliance and Permitting, pp. 83-88
Scale any new successful emergent technologies to supplement existing foundational grid hardening mitigations	<ul style="list-style-type: none"> • Hi-impedance relays (Hi-Z) (8.1.8.1.3.1) • Distribution Open Phase Detection (DOPD) (8.1.8.1.3.3) • Remote grid (8.1.2.9.1) • Transmission Open Phase Detection (TOPD) (SH-8) 	GO 95	Alignment between work being performed and output/recommendations from technologies and pilots	December 2032	Section 8.1.8.1.3, p. 334, p. 335, p. 337 Section 8.1.2.9.1, p. 274-275
If feasible and applicable, implement programs/pilots resulting from integrated transmission hardening strategy development and analysis	<ul style="list-style-type: none"> • Transmission IWMS (8.1.2.12.1) • High-risk transition spans 	<ul style="list-style-type: none"> • GO 95 • SCE TOH 	Alignment between work being performed and output/recommendations from transmission IWMS assessment	December 2032	Section 8.1.3.2, pp. 289-293 (IN-1.2), Section 8.1.2.12, p. 278
Integrate AI/ML analytical tools into inspection image data	<ul style="list-style-type: none"> • Inspections and Remediations 	<ul style="list-style-type: none"> • GO 95 	Number of AI/ML image	December	Section

Objectives for Ten Years (2026–2032)	Applicable Initiative(s), Tracking ID(s)	Applicable Regulations, Codes, Standards, and Best Practices (See Note)	Method of Verification (i.e., program)	Completion Date	Reference (section & page #)
analysis to identify assets and defects	<ul style="list-style-type: none"> - Distribution HFRI Inspections and Remediations (IN-1.1) - Transmission HFRI Inspections and Remediations (IN-1.2) - High Risk Transition Spans • Inspection Work Management Tools - Inspection and Maintenance Tools (IN-8) - Asset Defect Detection using AI/ML (IN-8) 	<ul style="list-style-type: none"> • GO 165 	models deployed	er 2032	8.1.3.1, pp. 282-289 (IN-1.1) Section 8.1.3.2, pp. 289-293 (IN-1.2) Section 8.1.3.5, pp. 297-299 (IN-3)
Integrate new technological tools into data collection for asset inspections (e.g., LiDAR) to identify defects (e.g., clearance issues) that need remediation	<ul style="list-style-type: none"> • Inspections and Remediations <ul style="list-style-type: none"> - Distribution HFRI Inspections and Remediations (IN-1.1) - Transmission HFRI Inspections and Remediations (IN-1.2) - High Risk Transition Spans • Inspection Work Management Tools <ul style="list-style-type: none"> - Inspection and Maintenance Tools (IN-8) - Asset Defect Detection using AI/ML (IN-8) 	<ul style="list-style-type: none"> • GO 95 • GO 165 	Number of assets inspected using new technological tools	December 2032	Section 8.1.3.1, pp. 282-289 (IN-1.1) Section 8.1.3.2, pp. 289-293 (IN-1.2) Section 8.1.5, pp. 319-325 (IN-8)
Maintain backlog at minimum levels and with as little fire risk as possible	<ul style="list-style-type: none"> • Inspections and Remediations <ul style="list-style-type: none"> - Distribution HFRI Inspections and Remediations (IN-1.1) - Transmission HFRI Inspections and Remediations (IN-1.2) 	<ul style="list-style-type: none"> • GO 95 • GO 165 	Number of past due notifications and associated risk of those notifications	December 2032	Section 8.1.3.1, pp. 282-289 (IN-1.1) Section 8.1.3.2, pp. 289-293 (IN-1.2)

Note: An asterisk indicates that the electrical corporation exceeds a particular code, regulation, standard, or best practice. The electrical corporation must provide a reference to the appendix section and page providing further documentation, justification, and substantiation.

8.1.1.2 Targets

Initiative targets are forward-looking quantifiable measurements of activities identified by each electrical corporation in its WMP. Electrical corporations will show progress toward completing targets in subsequent reports, including QDRs and WMP Updates.

The electrical corporation must list all targets it will use to track progress on its grid design, operations, and maintenance for the three years of the Base WMP. Energy Safety's Compliance Assurance Division and third parties must be able to track and audit each target.¹³⁵ For each initiative target, the electrical corporation must provide the following:

- *Utility Initiative Tracking IDs.*
- *Projected targets for each of the three years of the Base WMP and relevant units.*
- *Quarterly, rolling targets for 2023 and 2024 (inspections only).*
- *The expected "x% risk impact" for each of the three years of the Base WMP. The expected x% risk impact is the expected percentage risk reduction per year, as described in Section 7.2.2.2.*
- *Method of verifying target completion.*

The electrical corporation's targets must provide enough detail to effectively inform efforts to improve the performance of the electrical corporation's grid design, operations, and maintenance initiatives.

The tables below are based on the examples provided in the Technical Guidelines.

In Table 8-3 below, SCE provides the expected risk impact for each initiative at the scoping unit level and at the HFRA-level. As such, a given mitigation might appear to have a relatively smaller impact at the HFRA-level due to a limited scope of deployment, but a much larger impact at the segment or structure level. The risk impact percentages are in MARS and as discussed in Sections 6 and 7, SCE's IWMS Risk Framework takes into account additional factors not considered by MARS. SCE includes additional columns in the table below showing the percentage of an initiative's scope that is in Severe Risk Area (SRA) and High Consequence Areas (HCA).¹³⁶

¹³⁵ Annual information included in this section must align with Table 1 of the QDR.

¹³⁶ Percentages include adjustments resulting from detailed scope assessments pursuant to IWMS Framework.

Table 8-3 - Grid Design, Operations, and Maintenance Targets by Year

Initiative Activity	Tracking ID	2023 Target & Unit	x% Risk Impact 2023 (Unit /HFRA)	% in SRA/HCA 2023	2024 Target & Unit	x% Risk Impact 2024 (Unit /HFRA)	% in SRA/HCA 2024	2025 Target & Unit	x% Risk Impact 2025 (Unit /HFRA)	% in SRA/HCA 2025	Method of Verification
Covered Conductor	SH-1	Install 1,100 circuit miles of covered conductor in SCE’s HFRA SCE will strive to install up to as many as 1,200 circuit miles of covered conductor in SCE’s HFRA, subject to resource constraints and other execution risks	51% / 20%	91%	Install 1,050 circuit miles of covered conductor in SCE’s HFRA SCE will strive to install up to as many as 1,200 circuit miles of covered conductor in SCE’s HFRA, subject to resource constraints and other execution risks	53%/6%	91%	Install 700 circuit miles of covered conductor in SCE’s HFRA SCE will strive to install up to as many as 850 circuit miles of covered conductor in SCE’s HFRA, subject to resource constraints and other execution risks	51%/4%	80%	Listing of completed Work Orders
Undergrounding Overhead Conductor	SH-2	Convert 11 circuit miles of overhead to underground in SCE's HFRA	98%/.22%	100%	Convert 16 circuit miles of overhead to underground in SCE's HFRA SCE will strive to convert up to 20 miles of overhead to underground in SCE's HFRA, subject to resource constraints and other execution risks	98%/.64%	100%	Convert 48 circuit miles of overhead to underground in SCE's HFRA SCE will strive to convert up to 60 miles of overhead to underground in SCE's HFRA, subject to resource constraints and other execution risks	98%/.9%	100%	Listing of completed Work Orders
Branch Line Protection strategy	SH-4	Install or replace fusing at 500 fuse locations that serve HFRA circuitry SCE will strive to install or replace fusing at up to 570 locations that serve HFRA circuitry, subject to resource constraints and other execution risks	7%/.31%	97%	N/A – Sunsetting in 2023, further fuse replacements will be completed via opportunity work	N/A	N/A	N/A – Sunsetting in 2023, further fuse replacements will be completed via opportunity work	N/A	N/A	Listing of completed Work Orders

Initiative Activity	Tracking ID	2023 Target & Unit	x% Risk Impact 2023 (Unit /HFRA)	% in SRA/HCA 2023	2024 Target & Unit	x% Risk Impact 2024 (Unit /HFRA)	% in SRA/HCA 2024	2025 Target & Unit	x% Risk Impact 2025 (Unit /HFRA)	% in SRA/HCA 2025	Method of Verification
Remote Controlled Automatic Reclosers Settings Update	SH-5	SCE will install 6 RAR/RCS sectionalizing devices subject to 2022 PSPS analysis and subject to change SCE will strive to install up to 17 RAR/RCS sectionalizing devices subject to 2022 PSPS analysis, resource constraints and other execution risks	29%/.04%	7%	SCE will install 5 RAR/RCS sectionalizing devices subject to 2023 PSPS analysis and subject to change SCE will strive to install 17 RAR/RCS sectionalizing devices subject to 2023 PSPS analysis, resource constraints and other execution risks	34%/.24%	67%	SCE will install 5 RAR/RCS sectionalizing devices subject to 2024 PSPS analysis and subject to change SCE will strive to install 17 RAR/RCS sectionalizing devices subject to 2024 PSPS analysis, resource constraints and other execution risks	33%/.19%	95%	Listing of completed Work Orders
Circuit Breaker Relay Hardware for Fast Curve	SH-6	Replace/upgrade 75 CB relay units with fast curve settings in SCE's HFRA SCE will strive to replace/upgrade up to 88 relay units with fast curve settings in SCE's HFRA, subject to resource constraints and other execution risks	32%/.15%	95%	Replace/ upgrade remaining 10 CB relay units with fast curve settings in SCE's HFRA, subject to resource constraints and other execution risks	32%/.004%	92%	N/A - Activity Sunsetting in 2024	N/A	N/A	Listing of completed Work Orders
Transmission Open Phase Detection	SH-8	Install TOPD at 5 locations that serve HFRA circuitry with both alarm and trip functionality	1%/.01%	100%	Retrofit TOPD at 5 locations with trip capabilities where alarm mode was previously deployed and that serve HFRA circuitry	1%/.01%	100%	Target to be determined based on further evaluation	N/A	N/A	Listing of completed Work Orders

Initiative Activity	Tracking ID	2023 Target & Unit	x% Risk Impact 2023 (Unit /HFRA)	% in SRA/HCA 2023	2024 Target & Unit	x% Risk Impact 2024 (Unit /HFRA)	% in SRA/HCA 2024	2025 Target & Unit	x% Risk Impact 2025 (Unit /HFRA)	% in SRA/HCA 2025	Method of Verification
Tree Attachments Remediation	SH-10	Remediate 400 tree attachments in SCE's HFRA SCE will strive to complete up to 500 tree attachment remediations in SCE's HFRA, subject to resource constraints and other execution risks	21%/.02%	42%	Remediate 500 tree attachments in SCE's HFRA SCE will strive to complete up to 600 tree attachment remediations in SCE's HFRA, subject to resource constraints and other execution risks	21%/.03%	42%	Remediate the balance of tree attachments in SCE's HFRA, subject to change based on scope completed in previous years	22%/.03%	52%	Listing of completed Work Orders
Long Span Initiative (LSI)	SH-14	Remediate 400 spans in SCE's HFRA SCE will strive to remediate up to 500 spans in SCE's HFRA, subject to resource constraints and other execution risks	5%/.01%	92%	Remediate 1,000 spans in SCE's HFRA SCE will strive to remediate up to 1,200 spans in SCE's HFRA, subject to resource constraints and other execution risks	5%/.04%	82%	Remediate 1,000 spans in SCE's HFRA SCE will strive to remediate up to 1,200 spans in SCE's HFRA, subject to resource constraints and other execution risks	4%/.02%	98%	Listing of completed Work Orders
Vertical Switches	SH-15	Install 9 vertical switches in SCE's HFRA SCE will strive to install 11 vertical switches in SCE's HFRA, subject to resource constraints and other execution risks	44%/.01%	67%	N/A – Sunsetting in 2023	N/A	N/A	N/A – Sunsetting in 2023	N/A	N/A	Listing of completed Work Orders

Initiative Activity	Tracking ID	2023 Target & Unit	x% Risk Impact 2023 (Unit /HFRA)	% in SRA/HCA 2023	2024 Target & Unit	x% Risk Impact 2024 (Unit /HFRA)	% in SRA/HCA 2024	2025 Target & Unit	x% Risk Impact 2025 (Unit /HFRA)	% in SRA/HCA 2025	Method of Verification
Vibration Damper Retrofit	SH-16	Retrofit vibration dampers on 300 structures where covered conductor is already installed in SCE's HFRA SCE will strive to retrofit vibration dampers on up to 400 structures where covered conductor is already installed in SCE's HFRA, subject to resource constraints and other execution risks	19%/.04%	100%	Retrofit vibration dampers on 500 structures where covered conductor is already installed in SCE's HFRA SCE will strive to retrofit vibration dampers on up to 600 structures where covered conductor is already installed in SCE's HFRA, subject to resource constraints and other execution risks	11%/.01%	99%	Retrofit vibration dampers on 600 structures where covered conductor is already installed in SCE's HFRA SCE will strive to retrofit vibration dampers on up to 800 structures where covered conductor is already installed in SCE's HFRA, subject to resource constraints and other execution risks	20%/.09%	100%	Listing of completed Work Orders
Rapid Earth Fault Current Limiters (REFCL) (Ground Fault Neutralizer (GFN))	SH-17	SCE will complete construction of GFN at two substations (Acton and Phelan)	47%/3.6%	94%	SCE will complete construction of GFN at one substation (Banducci)	45%/.54%	88%	SCE will complete construction of GFN at four substations	49%/1.8%	89%	Listing of completed Work Orders
Rapid Earth Fault Current Limiters (REFCL) - Grounding Conversion	SH-18	SCE will complete grounding conversion at one location, subject to land availability.	45%/.06%	91%	SCE will target four locations for grounding conversion, subject to land availability SCE will strive to target up to 6 locations for grounding conversion, subject to land availability	N/A scope not determined yet	N/A scope not determined yet	SCE will target four locations for grounding conversion, subject to land availability SCE will strive to target up to 6 locations for grounding conversion, subject to land availability	N/A scope not determined yet	N/A scope not determined yet	Listing of completed Work Orders

The risk impact percentages shown in Table 8-4 are based on the cumulative MARS scores of the structures SCE expects to inspect for each initiative annually, divided by the cumulative MARS scores for all structures of that type in HFRA. SCE also provides the percentage of an initiative’s inspection scope that is in Severe Risk and High Consequence areas.

Table 8-4 - Asset Inspections Targets by Year

Initiative Activity	Tracking ID	Target End of Q2 2023 & Unit	Target End of Q3 2023 & Unit	End of Year Target 2023 & Unit	x% Risk Impact 2023	% in SRA/HC 2023	Target End of Q2 2024 & Unit	Target End of Q3 2024 & Unit	End of Year Target 2024 & Unit	x% Risk Impact 2024	% in SRA/HC 2023	Target 2025 & Unit	x% Risk Impact 2025	% in SRA/HC 2025	Method of Verification
Distribution High Fire Risk-Informed (HFRI) Inspections and Remediations (Ground and Aerial)	IN-1.1	101,320	172,640	Inspect 187,000 structures in HFRA SCE will strive to inspect up to 217,000 structures in HFRA This target includes HFRI inspections, compliance due structures in HFRA and emergent risks identified during the fire season (e.g., AOCs)	90%	94%	101,320	172,640	Inspect 187,000 structures in HFRA SCE will strive to inspect up to 217,000 structures in HFRA This target includes HFRI inspections, compliance due structures in HFRA and emergent risks identified during the fire season (e.g., AOCs)	90%	94%	Inspect 187,000 structures in HFRA SCE will strive to inspect up to 217,000 structures in HFRA This target includes HFRI inspections, compliance due structures in HFRA and emergent risks identified during the fire season (e.g., AOCs)	90%	94%	Listing of completed Work Orders
Transmission High Fire Risk-Informed (HFRI) Inspections and Remediations (Ground and Aerial)	IN-1.2	14,400	25,800	Inspect 28,000 structures in HFRA SCE will strive to inspect up to 29,500 structures in HFRA This target includes HFRI inspections, compliance due structures in HFRA	88% (Ground) 88% (Aerial)	86%	14,400	25,800	Inspect 28,000 structures in HFRA SCE will strive to inspect up to 29,500 structures in HFRA This target includes HFRI inspections,	88% (Ground) 88% (Aerial)	86%	Inspect 28,000 structures in HFRA SCE will strive to inspect up to 29,500 structures in HFRA. This target includes HFRI inspections, compliance due structures in HFRA	88% (Ground) 88% (Aerial)	86%	Listing of completed Work Orders

Initiative Activity	Tracking ID	Target End of Q2 2023 & Unit	Target End of Q3 2023 & Unit	End of Year Target 2023 & Unit	x% Risk Impact 2023	% in SRA/HC 2023	Target End of Q2 2024 & Unit	Target End of Q3 2024 & Unit	End of Year Target 2024 & Unit	x% Risk Impact 2024	% in SRA/HC 2023	Target 2025 & Unit	x% Risk Impact 2025	% in SRA/HC 2025	Method of Verification
				and emergent risks identified during the fire season (e.g., AOC)					compliance due structures in HFRA and emergent risks identified during the fire season (e.g., AOC)			and emergent risks identified during the fire season (e.g., AOC)			
Infrared Inspection of Energized Overhead Distribution Facilities and Equipment	IN-3	2,295	5,300	Inspect 5,300 distribution overhead circuit miles in HFRA	60%	77%	2,295	5,300	Inspect 5,300 distribution overhead circuit miles in HFRA	63%	77%	Inspect 5,300 distribution overhead circuit miles in HFRA	60%	77%	Listing of completed Work Orders
Infrared Inspection, Corona Scanning, and High-Definition Imagery of Energized Overhead Transmission Facilities and Equipment	IN-4	600	900	Inspect 1,000 transmission overhead circuit miles in HFRA	72%	81%	600	900	Inspect 1,000 transmission overhead circuit miles in HFRA	50%	80%	Inspect 1,000 transmission overhead circuit miles in HFRA	59%	81%	Listing of completed Work Orders
Generation High Fire Risk-Informed Inspections and Remediation	IN-5	55	170	Inspect 170 generation related assets in HFRA SCE will strive to inspect 200 generation related assets in HFRA,	17%	N/A	52	160	Inspect 160 generation related assets in HFRA SCE will strive to inspect 190 generation related assets in HFRA, subject to	29%	N/A	Inspect 170 generation related assets in HFRA SCE will strive to inspect 200 generation related assets in HFRA, subject to resource	14%	N/A	Listing of completed Work Orders

Initiative Activity	Tracking ID	Target End of Q2 2023 & Unit	Target End of Q3 2023 & Unit	End of Year Target 2023 & Unit	x% Risk Impact 2023	% in SRA/HC 2023	Target End of Q2 2024 & Unit	Target End of Q3 2024 & Unit	End of Year Target 2024 & Unit	x% Risk Impact 2024	% in SRA/HC 2023	Target 2025 & Unit	x% Risk Impact 2025	% in SRA/HC 2025	Method of Verification
s in HFRA				subject to resource constraints and other execution risks					resource constraints and other execution risks			constraints and other execution risks			
Inspection and Maintenance Tools	IN-8	Develop use cases to use in build of proof of concept (POC) to prove out design direction	Develop POC of key design elements to validate design direction	Complete detailed design to migrate the distribution ground inspection application to the single digital platform	N/A	N/A	Conduct requirements gathering for incorporating distribution ground and InspectCam capabilities in single digital platform	Initiate solution analysis for incorporating distribution ground and InspectCam capabilities in single digital platform	Execute the approved designs / recommendations for incorporating distribution ground and InspectCam capabilities into single digital platform	N/A	N/A	Monitor utilization of inspection work management tool, and make enhancements as necessary	N/A	N/A	Completed user acceptance testing, screenshots of tool enhancements
Transmission Conductor & Splice Assessment: Spans with LineVue	IN-9a	30	45	Will inspect 50 spans with Line Vue SCE will strive to inspect up to 75 spans with Line Vue, subject to resource constraints and other execution risks	0.0012%	100%	N/A	N/A	Target to be developed based on an engineering analysis to be performed in 2023	N/A	N/A	Target to be developed based on an engineering analysis to be performed in 2023 and 2024	N/A	N/A	Listing of completed Work Orders
Transmission Conductor & Splice Assessment:	IN-9b	30	45	Will inspect 50 splices with X-Ray SCE will strive to inspect up to 75	.03%	100%	N/A	N/A	Target to be developed based on a engineering analysis to be performed in 2023	N/A	N/A	Target to be developed based on an engineering analysis to be performed in 2023	N/A	N/A	Listing of completed Work Orders

Initiative Activity	Tracking ID	Target End of Q2 2023 & Unit	Target End of Q3 2023 & Unit	End of Year Target 2023 & Unit	x% Risk Impact 2023	% in SRA/HC 2023	Target End of Q2 2024 & Unit	Target End of Q3 2024 & Unit	End of Year Target 2024 & Unit	x% Risk Impact 2024	% in SRA/HC 2023	Target 2025 & Unit	x% Risk Impact 2025	% in SRA/HC 2025	Method of Verification
Splices with X-Ray				splices with X-Ray, subject to resource constraints and other execution risks								and 2024			
Wildfire Safety Data Mart and Data Management (WiSDM / Ezy)	DG-1	WiSDM: Execute parallel run of QDR reporting Ezy: Completed solution analysis for LIDAR data management in support of Veg Mgmt and asset inspection	WiSDM: Execute final validation of semi-automated QDR reporting Ezy: Complete Migration of legacy LIDAR data to Google Cloud Platform (GCP)	WiSDM: Enable semi-automated data aggregation and validations of Wildfire Data for SCE's Quarterly Data Request (QDR) submission and external portal for external data sharing Ezy: Enable LIDAR data management	N/A	N/A	N/A	N/A	N/A – Sunsetting in 2023	N/A	N/A	N/A – Sunsetting in 2023	N/A	N/A	WiSDM: WiSDM-generated QDR Ezy: Screenshots of tool by use case

8.1.1.3 Performance Metrics Identified by the Electrical Corporation

Performance metrics indicate the extent to which an electrical corporation's Wildfire Mitigation

Plan is driving performance outcomes. The electrical corporation must:

- *List the performance metrics the electrical corporation uses to evaluate the effectiveness of its grid design, operations, and maintenance in reducing wildfire and PSPS risk¹³⁷*

For each of these performance metrics listed, the electrical corporation must:

- *Report the electrical corporation's performance since 2020 (if previously collected)*
- *Project performance for 2023-2025*
- *List method of verification*

The electrical corporation must ensure that each metric's name and values are the same in its WMP reporting as its QDR reporting (specifically, QDR Table 2 and QDR Table 3). Metrics listed in this section that are the same as performance metrics required by Energy Safety and reported in QDR Table 2 (Performance Metrics)¹³⁸ must match those reported in QDR Table 2. Metrics listed in this section that are not the same as any of the performance metrics identified by Energy Safety and reported in QDR Table 2 must match those reported in QDR Table 3.

The electrical corporation must:

- *Summarize its self-identified performance metrics in tabular form*
- *Provide a brief narrative that explains trends in the metrics*

Metrics and underlying data are critical components for WMP development, execution, and evaluation, but we continue to emphasize that the near-term focus should be on efficient implementation of our planned activities, while the assessment of whether the activities are having the desired and expected impact on risk reduction should be measured over a longer time horizon. A clear distinction is necessary between targets that monitor compliance with approved WMPs and metrics that evaluate effectiveness of these approved plans and inform future WMP updates.

As in prior WMP submissions, we provide annual initiative targets (such as those provided in Table 8-3) for each WMP initiative which establish goals to evaluate compliance. As stated in previous filings and submittals, tracking initiative targets for approved WMPs is the best means of determining progress and assessing WMP compliance in the near-term.

SCE has identified several performance metrics in Table 3-1 of its Quarterly Wildfire Mitigation Data Tables which may be helpful to inform evaluation of the performance of SCE's wildfire mitigation portfolio. SCE identified metrics because WMP activities are ultimately designed to reduce wildfire ignitions associated with its electrical infrastructure and reduce the impact of PSPS de-energization events to customers.

¹³⁷ There may be overlap between the performance metrics the electrical corporation uses and performance metrics required by Energy Safety. The electrical corporation must list these overlapping metrics in this section in addition to any unique performance metrics it uses.

¹³⁸ The performance metrics identified by Energy Safety are included in Energy Safety's Data Guidelines.

Importantly, these metrics are within the reasonable control of utilities when appropriately normalized for weather and other exogenous factors. Other metrics such as safety incidents, acres burned or structures destroyed, though important to understand, track, and monitor are impacted by events and circumstances largely outside of the utility's control such as climate change, droughts, fire suppression efforts and fire response.

In Table 8-5, SCE provides a listing of performance metrics that may be helpful to inform the effectiveness of SCE's grid design, operations, and maintenance activities. Because several of the performance metrics identified in QDR Table 3 are impacted by mitigations across several WMP categories, SCE repeats the inclusion of performance metrics in multiple WMP Category tables where applicable. SCE notes that projections provided for its performance metrics are estimates only and subject to change. SCE describes each metric in more detail below.

Table 8-5 - Grid Design, Operations, and Maintenance Performance Metrics Results by Year

Performance Metrics	2020	2021	2022	2023 Projected	2024 Projected	2025 Projected	Method of Verification (e.g., third-party evaluation, QDR)
Number of CPUC reportable ignitions in HFRA	50	48	40	39	38	37	QDR, Tables 2 and 3
Number of wire downs in HFRA	379	468	316	361	360	361	QDR, Tables 2 and 3
Number of outages in HFRA	2,824	2,356	2,404	2,018	1,946	1,892	QDR, Tables 2 and 3
Number of asset management ignition risk-related work orders that are past due (excluding GO95 exceptions)	3,423	3,951	4,607	4,021	4,021	4,021	QDR, Table 3
Frequency of PSPS Events (total) ¹³⁹	10	8	3	7	7	7	QDR, Tables 3 and 10
Scope of PSPS Events (total) ¹⁴⁰	424	232	13	210	197	185	QDR, Tables 3 and 10
Duration of PSPS events (total) ¹⁴¹	4,455,936	3,700,254	112,274	2,508,101	2,282,372	2,076,958	QDR, Tables 3 and 10
Number of customers impacted by PSPS ¹⁴²	229,800	179,502	15,784	120,441	102,375	87,019	QDR, Tables 3 and 10

Number of CPUC Reportable Ignitions in HFRA, Wire Downs in HFRA, and Outages in HFRA: SCE is monitoring the number of ignitions and wire-down events at the structure level and by key driver (CFO, EFF, and other). SCE’s wildfire mitigations help to reduce wire downs and outages which can lead to ignitions, and also can reduce the likelihood that an ignition occurs as the result of an outage. By observing the key drivers of these events down to the circuit or individual structure level, SCE is building the capability to better evaluate the effectiveness of wildfire activities that were deployed to mitigate those specific drivers, as well as help align future deployment of mitigations to targeting specific drivers identified at those locations. Large variations in weather events, including temperature, rainfall, fuel moisture and wind, can heavily impact performance metrics including outages, wire-down events and ignitions, and can often skew direct comparisons of these metrics year over year. At this time, SCE does not incorporate weather normalization into its WMP ignition forecasts due to the complexity of determining the causal relationship between aberrant weather and ignition probability and fire spread. SCE discusses the trends for each metric below:

- **CPUC Reportable Ignitions in HFRA:** In 2022, HFRA ignitions decreased by 20% and 17% since 2020 and 2021, respectively. The decrease is primarily due to a decrease in CFO caused ignitions, which aligns with the mitigations central to SCE’s IWMS, namely covered conductor. SCE projects a decline in CPUC reportable ignitions in HFRA over the WMP period.
- **Wire Downs in HFRA:** Overall the number of wired down events year over year, there has not been a trend identified. However, specific sub-drivers such as conductor failure, splice failures and crossarm failures have declined year over year, which aligns with SCE's deployment of covered conductor. Moreover, circuits that are fully covered per mile compared to bare circuits, see a reduction of over 60% in wire downs for drivers that CC is expected to mitigate.
- **Outages in HFRA:** In 2022 Outages in HFRA decreased from 2020 and are consistent with 2021 values. While some drivers do not have a trend, the following drivers all have decreased year over year: vegetation and animal caused outages. Additionally, vehicle caused outages have increased year over year since 2020. SCE projects a decline in outages in HFRA over the WMP period.

Number of asset management ignition risk-related work orders that are past due (excluding GO95 exceptions): This metric tracks the number of past due notifications (work orders) identified through SCE’s transmission and distribution inspection programs that present a potential ignition risk in HFRA. To focus on those past due notifications that are largely within our control, SCE removes notifications that have GO 95 exceptions due to permitting constraints, third party refusal, customer access issues, etc. SCE has seen an increase in the number of asset management work orders as more inspections were completed (i.e., distribution ground inspections) which resulted in more findings and open work orders needing to be completed. As noted in ACI

¹³⁹ Frequency of PSPS Events definition: Number of instances where utility operating protocol requires de-energization of a circuit or portion thereof to reduce ignition probability, per year. Only include events in which de-energization ultimately occurred

¹⁴⁰ Scope of PSPS Events definition: Circuit-events, measured in number of events multiplied by number of circuits de-energized per year.

¹⁴¹ Duration of PSPS events definition: Customer hours per year.

¹⁴² Number of customers impacted by PSPS definition: Number of customers impacted by PSPS (if multiple PSPS events impact the same customer, count each event as a separate customer).

SCE-22-15 Targets Relating to Addressing Inspection Findings within Appendix D: Areas for Continued Improvement of this WMP and Section 8.1.7, SCE is working to mitigate the backlog. The current projection for future years is flat as SCE has seen an increase in repair work from inspections driven by changes to the inspection form and an increase in the number of inspections, which may offset the steps being taken to address the backlog.

Frequency of PSPS (Total), Scope of PSPS (Total), Duration of PSPS (Total), Number of Customers Impacted by PSPS (Total): Please see Section 9 – PPS – for a full explanation of these metrics and corresponding trends. SCE includes these PPS performance metrics in this Section due to our efforts to reduce the frequency, scope, and duration of PPS events through accelerated grid hardening of circuits impacted by PPS. For example, an isolatable circuit segment with covered conductor installed can have its PPS de-energization wind speed thresholds raised to higher wind speeds levels.

8.1.2 Grid Design and System Hardening

In this section the electrical corporation must discuss how it is designing its system to reduce ignition risk and what it is doing to strengthen its distribution, transmission, and substation infrastructure to reduce the risk of utility-related ignitions resulting in catastrophic wildfires.

The electrical corporation is required, at a minimum, to discuss grid design and system hardening for each of the following mitigation activities:

- 1. Covered conductor installation*
- 2. Undergrounding of electric lines and/or equipment*
- 3. Distribution pole replacements and reinforcements*
- 4. Transmission pole/tower replacements and reinforcements*
- 5. Traditional overhead hardening*
- 6. Emerging grid hardening technology installations and pilots*
- 7. Microgrids*
- 8. Installation of system automation equipment*
- 9. Line removal (in the HFTD)*
- 10. Other grid topology improvements to minimize risk of ignitions*
- 11. Other grid topology improvements to mitigate or reduce PSPS events*
- 12. Other technologies and systems not listed above*

In Sections 8.1.2.1 through 8.1.2.12, the electrical corporation must provide a narrative including the following information for each grid design and system hardening mitigation activity:

- Utility Initiative Tracking ID.*
- Overview of the activity: A brief description of the activity including reference to related objectives and targets. Additionally, the overview must identify whether the activity is a program, project, pilot, or study.*
- Impact of the activity on wildfire risk.*
- Impact of the activity on PSPS risk.*
- Updates to the activity: Changes to the initiative since the last WMP submission and a brief explanation as to why those change were made. Discuss any planned improvements or updates to the activity and the timeline for implementation*

8.1.2.1 Covered Conductor Installation

8.1.2.1.1 Covered Conductor

Utility Initiative Tracking ID: SH-1

Overview of activity: The Wildfire Covered Conductor Program (WCCP) is a program in HFRA to replace existing bare wire with covered conductor (CC) along with other associated components such as fire-resistant poles, composite crossarms, FR3 transformers¹⁴³, wildlife covers, surge arresters, polymer insulators and vibration dampers, and is scoped based on the risk assessment and mitigation selection processes described in Sections 6 and 7.

Covered conductor refers to a conductor with an internal semiconducting layer and external insulating UV-resistant layers to protect against the arcing, faults, or energy release that can come from incidental contact.

It is SCE's engineering standard to install covered conductor in HFRA any time bare wire needs to be replaced. Examples of this include during post-fire restoration work (outside of the WCCP) and other non-WCCP programmatic work, e.g., through the Overhead Conductor Program (OCP), where bare wires are replaced. SCE tracks and reports the installation of covered conductor under both WCCP and non-WCCP.

SCE installs composite poles or fire-resistant wrapped wood poles (together known as Fire-Resistant Poles or FRPs) during the implementation of WCCP when pole loading requirements require a replacement of a pole. FRPs provide the benefit to withstand a fire and maintain system resiliency and shorten the service restoration time. FRPs that are composite provide the additional benefit of minimizing ignitions from equipment at the top of pole (and thus used for poles with equipment on top or in an area with environmental or wildlife factors such as woodpeckers). Figure SCE 8-01 shows the physical layers of covered conductor, as well as illustrations of a fire-resistant composite pole and a fire-resistant wrapped wood pole.

Figure SCE 8-01 - Cross Section of Covered Conductor (left) Fire-Resistant Composite Pole (middle) and Fire-Resistance Wrapped Wood Pole (Right)

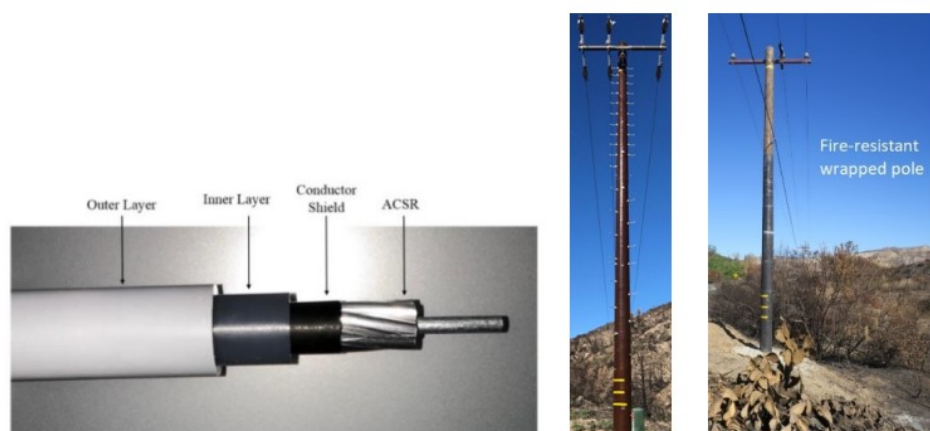

¹⁴³ A FR3 transformer contains plant-based oil instead of petroleum-based oil and can withstand higher temperatures before igniting, reducing the chances of the transformer fluid adding fuel to a fire.

SCE has continued to install CC per the previous filing, and is targeting 1,100, 1,050 and 700 miles in years 2023, 2024 and 2025, respectively. SCE will strive to install 1,200 miles in years 2023 and 2024 and 850 miles in 2025.

Impact of activity on wildfire risk: Installation of covered conductor and other associated components such as fire-resistant poles, composite crossarms, FR3 transformers, wildlife covers, and vibration dampers serve as preventative measures against several wildfire risks. It is effective at reducing the ignition drivers associated with contact-from-object (CFO) such as animal or vegetation contact and wire-to-wire faults. It is also effective at reducing ignition drivers associated with equipment or facility failures. In the case of an energized downed wire, covered conductor reduces the area of exposed base wire, thus reducing the likelihood of ignition and serious injury or fatality compared to contact with bare conductor.

SCE has realized significant benefits from covered conductor deployment. On circuits where the overhead primary is all covered conductor, SCE has observed a 71% reduction of faults covered conductor is expected to mitigate compared to bare wire.¹⁴⁴ Zero ignitions have occurred where cover conductor is deployed from drivers covered conductor is expected to mitigate.¹⁴⁵

Installing FRPs, such as composite poles, helps prevent ignitions at the top of the pole. Also, burned and/or fallen poles can cause other equipment on the pole to fail, making service restoration after a fire more difficult. FRPs can withstand a fire and maintain system resiliency and shorten the service restoration time.

Please see Table SCE 7-02 and Appendix F: Supplemental Information (i.e., “Mitigation Effectiveness Workpapers”) for additional information on how this mitigation impacts wildfire risk.

Impact of activity on PSPS risk: Covered conductor reduces PSPS risks by decreasing the likelihood of de-energization due to higher real-time de-energization windspeed thresholds for fully covered isolatable circuit segments.

SCE has determined that lines with covered conductor have a 90% reduction in PSPS activations.¹⁴⁶ When a circuit (or fully isolatable circuit segment) is all covered conductor, the de-energization threshold is increased to 40/58 mph (sustained wind/gusts).

Please see Table SCE 7-02 and Appendix F: Supplemental Information (i.e., “Mitigation Effectiveness Workpapers”) for additional information on how this mitigation impacts PSPS risk.

Updates to the activity: In 2022, SCE updated its covered conductor standard to include the replacement of open wire secondary or weather-resistant aluminum (OWS or WAL) with multiplex secondary conductors. Weather-resistant aluminum wire on the secondary system is outdated technology and will be updated to the new standard when WCCP is installed.

All OWS and WAL secondary lines that share the same line path or are attached to the same targeted primary structure shall be upgraded to multiplex conductors (see Figure SCE 8-02 below). Multiplex conductors are fully insulated secondary conductors that can help mitigate contact-related faults and

¹⁴⁴ Measurement of CC effectiveness began in 2018.

¹⁴⁵ As of year-end 2022.

¹⁴⁶ Based on PSPS control thresholds for bare and CC circuit using weather data from 2011 to 2021.

associated ignitions.

SCE addressed these issues by updating the inspection forms and covering bare connectors with tape. In 2022, the main driver of secondary ignitions was Equipment/Facility Failure in approximately 70% of cases, followed by CFO in approximately 15% of cases. SCE estimates a small portion of its secondary system (10%) is still bare open wire and weather resistant aluminum which are outdated technology. SCE plans to replace these in the coming years.¹⁴⁷

Figure SCE 8-02 - Outdated Secondary Conductor (Left) and In-Standard Secondary Conductor (Right)

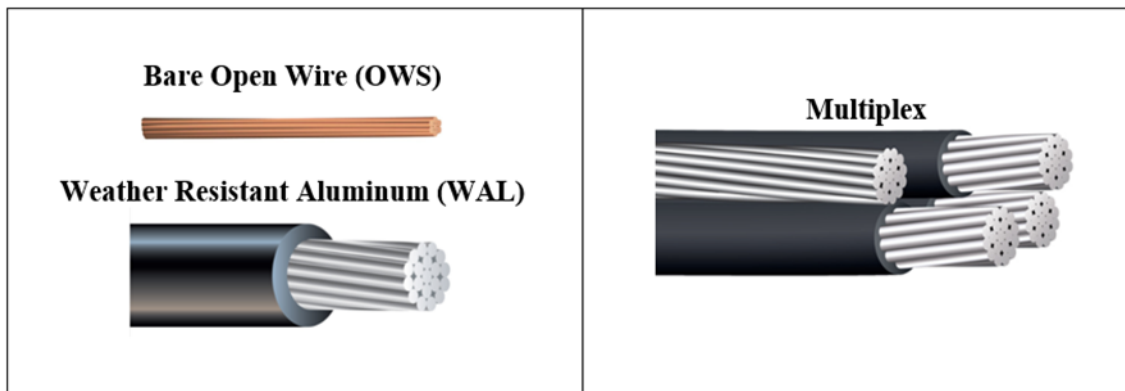

As described in the ACI SCE-22-17 Address Secondary Conductor Issues in Appendix D: Areas for Continued Improvement, SCE describes results of analysis on secondary ignition events from 2019-2022¹⁴⁸ in SCE's HFRA. SCE observes an increasing trend in the number of secondary ignition events in 2020 and 2021, where the main drivers are CFO and EFF.

Open wire secondaries and weather-resistant aluminum conductors can pose an ignition risk because they are vulnerable to contact-from-object faults. Upgrading OWS and WAL conductors to multiplex conductors (duplex, triplex, or quadraplex), which are a bundle of conductors twisted around each other (see picture of the multiplex conductor on the right of Figure SCE 8-02 above) will help mitigate ignition events. Since multiplex conductors are covered and bundled together, they can withstand CFO much better than the bare open wire or single conductor can.

This standard update will only affect WCCP installations starting in 2024, and not planned WCCP work for 2022 and 2023, as work for these years is already in the design or construction phase. As described in ACI SCE-22-17 Address Secondary Conductor Issues in Appendix D: Areas for Continued Improvement, SCE has enhanced vegetation management and inspection measures to address the risk of secondaries until they can be remediated. Upgrading secondaries to multiplex conductors and covering bare connectors with tape can mitigate ignition events associated with secondaries.

In 2022 SCE initiated a spacer cable pilot to examine how covered conductor is supported by a high strength messenger through diamond shaped spacers instead of the traditional open crossarm arrangement. The pilot encompassed six spans or about 800 feet of covered conductor. SCE will continue to evaluate the viability of this type of installation as possibly another solution in mitigating

¹⁴⁷ There are approximately 0.3 miles of secondary conductor for every mile of primary conductor in HFRA. SCE estimates that approximately 10% of the secondary conductor requires replacement, with an estimated 7% of secondary spans being weather-resistant aluminum and 3% being bare open wire.

¹⁴⁸ Partial year data was collected for 2019 and 2020 was the first year with a full year of data.

wildfire ignitions.

8.1.2.1.2 Vibration Damper Retrofit

Utility Initiative Tracking ID: SH-16

Overview of activity: SCE's Vibration damper retrofit program aims to stop wind-driven vibration (known as Aeolian vibration) that may lead to conductor abrasion or fatigue over time. This is an issue for both bare and covered conductor. However, covered conductor may be more susceptible to vibration because of the covering's smoothness (perfect cylinder) and the reduction of strand movement due to the covering. If this vibration is not mitigated, the long-term damage may reduce the covered conductor's useful life. While it does not pose an immediate risk, vibration can reduce the covered conductor's useful life from 45 years to an average of 20 years if not addressed, particularly in high and medium vibration susceptibility area.

Figure SCE 8-03 - Types of Vibration Dampers: Stockbridge Damper (left) and Spiral Damper (right)



As discussed in response to the ACI SCE-22-17 in Appendix D: Areas for Continued Improvement, SCE examines potential areas for damper retrofits and prioritizes lines based on defined terrain type categories and persistence of wind. SCE uses the risk informed analysis described to determine CC installations with high, medium and low susceptibility to Aeolian vibrations. Note that this program targets covered conductor installations constructed prior to Q4 2020, when SCE’s vibration damper standard was published. For new installations, vibration dampers are required per SCE’s covered conductor construction standard.

SCE is targeting installations on 300, 500 and 600 structures in years 2023, 2024 and 2025, respectively. SCE will strive to complete 400, 600 and 800 installations in years 2023, 2024 and 2025, respectively.

Impact of activity on wildfire risk: Installing vibration dampers maintains the expected useful life of the covered conductor, and thus the ability to minimize certain equipment failure ignition drivers, such as damage or failure of the conductor, connector, and/or splice. Please see Table SCE 7-02 and Appendix F: Supplemental Information (i.e., “Mitigation Effectiveness Workpapers”) for additional information on how this mitigation impacts wildfire and PSPS risk.

Impact of activity on PSPS risk: As with wildfire risk, vibration dampers support the effectiveness of covered conductor by maintaining its useful life, which allows covered conductor to be utilized to increase de-energization windspeed threshold for a fully covered circuit during an extremely windy conditions and reduce the frequency of PSPS. Please see Table SCE 7-02 and Appendix F: Supplemental Information (i.e., “Mitigation Effectiveness Workpapers”) for additional information on how this mitigation impacts wildfire and PSPS risk.

Updates to the activity: SCE will continue this program as described in SCE’s 2022 WMP. SCE will increase the volume of vibration damper retrofits over the next several years, focusing on the riskiest circuit segments identified based on vibration susceptibility studies.

8.1.2.2 Undergrounding of Electric Lines and/or Equipment

8.1.2.2.1 Targeted Undergrounding

Utility Initiative Tracking ID: SH-2

Overview of activity: Targeted Undergrounding (TUG) is a program to underground existing overhead power lines to significantly reduce wildfire and PSPS risk by significantly reducing the possibility for objects to contact energized conductor as well as greatly limiting the ignition-causing potential from equipment failures. In addition to those drivers, fault conditions can weaken and sometimes cause electrical stresses on hardware and insulators, which could lead to energized wire-down events or electrical arcing. Removing overhead lines and replacing them with underground wire significantly reduces this risk. Undergrounding has the added benefit of reducing the need for PSPS during extreme wind events. While the deployment of covered conductor may significantly increase the windspeed threshold for de-energization during a risk event, it does not completely prevent those de-energizations during extreme wind events like undergrounding can. Accordingly, as described in Section 7, undergrounding is the preferred method to nearly eliminate risk in Severe Risk Areas. However, there are some locations that are not feasible to underground due to factors such as rocky terrain, etc. In those cases, SCE would instead consider other mitigation measures including covered conductor combined with other measures.

Generally, when converting existing overhead lines to underground facilities, a line route needs to be determined. Often in urbanized areas, this route can be the same as the existing overhead line assuming pre-existing underground utilities (e.g., natural gas, water, sewer, etc.) do not preclude the addition of a new duct and structure system. Routes may also need to be altered to avoid obstructions. For example, this may involve moving a rear property pole line to curbside to avoid swimming pools, block walls, etc.

In coastal, mountainous, or more rural communities, topography can present additional challenges to those already mentioned above. Lines may need to be moved to the road to avoid steep terrain, heavy vegetation, water crossings, erosion concerns, and to generally avoid environmental considerations associated with heavy equipment access to construct and/or maintain lines. Because of these topographical challenges with some existing overhead lines, vehicle access required for installing underground cable is not available, which makes undergrounding along the same route impractical. Therefore, overhead lines may need to be brought out to the public right-of-way for undergrounding, increasing the length of the undergrounding needed and significantly increasing the cost as well as the construction timeline.

Figure SCE 8-04 shows an example of a necessary re-route. The picture on the left shows the current overhead line path, crossing a steep, hilly terrain. The lines may need to be moved to the road to avoid environmental considerations associated with heavy equipment access to construct and/or maintain lines, as shown in the picture on the right. Re-routing requires an additional length of conductor, labor, and materials.

Figure SCE 8-04 - Re-Route Example in Malibu Area

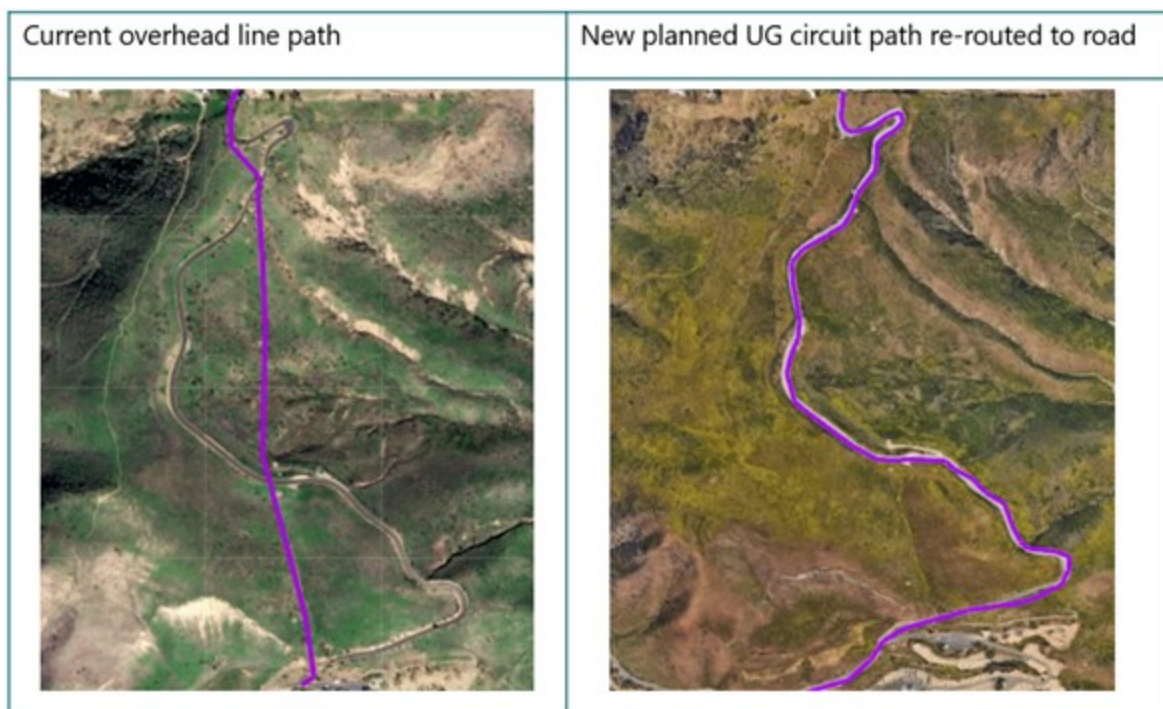

SCE aims to convert 11, 16 and 48 miles of overhead conductor to underground facilities in years 2023, 2024 and 2025, respectively. SCE will strive to convert 20 and 60 miles in years 2024 and 2025, respectively.

Impact of activity on wildfire risk: Undergrounding substantially reduces the risk of ignitions and outages associated with drivers such as wire contact with objects (e.g., vegetation, metallic balloons, debris, etc.), equipment failure, and wire-to-wire faults. Please see Table SCE 7-02 and Appendix F: Supplemental Information (i.e., “Mitigation Effectiveness Workpapers”) for additional information on how this mitigation impacts wildfire and PSPS risk.

Impact of activity on PSPS risk: Undergrounding substantially reduces the need to call PSPS events on circuits and isolatable segments that are fully undergrounded.¹⁴⁹ Please see Table SCE 7-02 and Appendix F: Supplemental Information (i.e., “Mitigation Effectiveness Workpapers”) for additional information on how this mitigation impacts wildfire and PSPS risk.

Updates to the activity: In 2023, SCE will continue to deploy TUG based on the previous risk prioritization methods prior to the introduction of IWMS. SCE has updated our methodology to release

¹⁴⁹ Note that isolatable segments that are connected to upstream OH circuits can still experience PSPS outages if there is no way to reroute them to get power from another non-PSPS impacted circuit.

scope using IWMS, which considers factors such as egress, fire travel, and burn history. More details can be found in Section 6.2.1.

8.1.2.3 Distribution Pole Replacements and Reinforcements

SCE has historically had two major pole replacement programs, Deteriorated (Det) Pole Program and Pole Loading Program (PLP),¹⁵⁰ to improve the safety and reliability of the electric grid. As part of the Det Pole Program, SCE intrusively inspects poles through the Intrusive Pole Inspection (IPI) Program. An intrusive inspection involves drilling into the pole interior to identify and measure the extent of internal decay that is typically undetectable with external observation alone. The PLP Program assesses the safety factor of a pole to identify instances that do not meet either GO 95 or SCE's internal requirements that exceed GO 95. Poles that do not meet these requirements are documented and scheduled for either repair or replacement.

Poles are also replaced as part of SCE's HFRI inspections and maintenance programs. In addition, poles may be identified for replacement during various activities if they do not meet pole loading criteria when new equipment is added or if visual damage is identified by field personnel. All these programs span SCE's entire service area, except for HFRI inspections and maintenance which are only in SCE's HFRA. In HFRA, any poles replaced will be replaced with FRPs using the same strategy as described above for WCCP, which is the engineering standard in SCE's HFRA. SCE does not consider pole replacements to be a stand-alone WMP initiative but is incorporated already as part of its system hardening and asset management activities. As described above in regards to SH-1, FRPs are installed in HFRA as part of WCCP and non-WCCP activities (such as post-fire restoration work).

8.1.2.3.1 Tree Attachment Remediation

Utility Initiative Tracking ID: SH-10

Overview of activity: Tree Attachment Remediation is a Program. Older construction methods used in SCE's forested service area used existing trees to support overhead conductors instead of installing utility poles. These "tree attachments" do not meet SCE's current design standards. The integrity of the trees cannot be verified using inspections and assessment techniques for poles. In addition, tree attachments increase the probability of faults and damages from vegetation contact and "fall-ins."

This initiative entails removing the electrical equipment attached to trees and installing the equipment on new fire-resistant poles to reduce ignition driver risks. Note that most tree attachment work is completed with aerial cable as that is the design standard for areas with dense vegetation. Aerial cable is a fully insulated conductor, equivalent to underground cable, and can withstand permanent phase-to-phase and phase-to-ground contact. If the existing tree attachment has aerial cable in good condition, SCE will relocate the aerial cable to a pole instead of installing covered conductor.

¹⁵⁰ SCE's Pole Loading Program was completed in 2021. Some resulting remediations will take place up to 2024.

Figure SCE 8-05 - An Example of a Tree Attachment Where Electrical Equipment Was Attached to a Live Tree

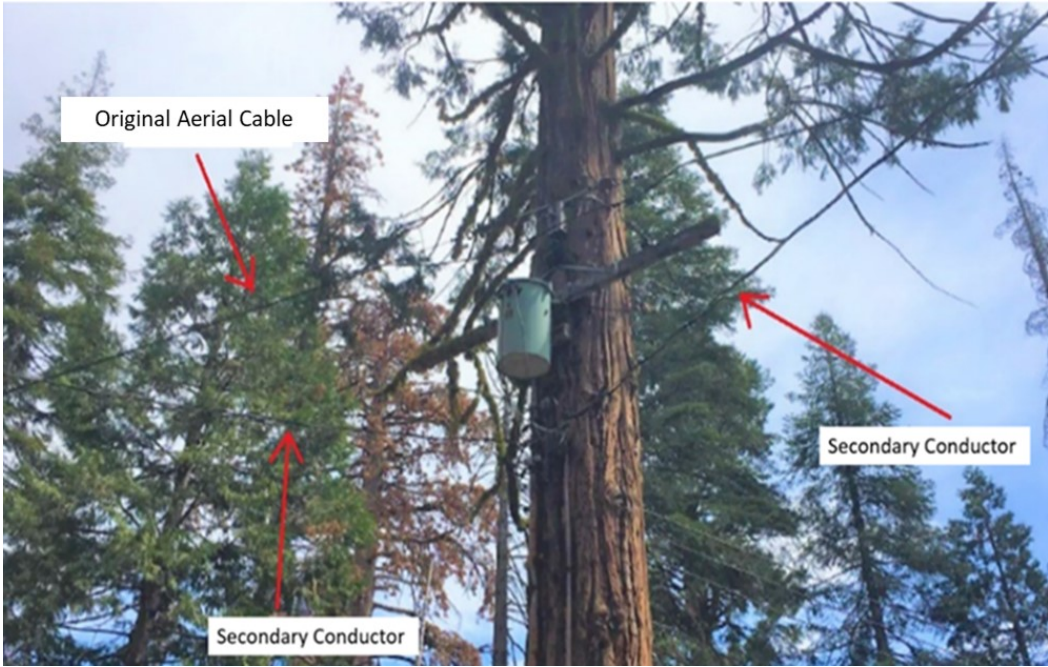

Impact of activity on wildfire risk: Tree attachment remediations address contact-from-object and equipment failure ignition risks. Removing a tree attachment reduces the probability of vegetation contact and the potential ignition caused by a spark close to vegetation. Leaving overhead conductors attached to trees, especially in HFRA, is inherently risky so SCE is transferring overhead conductor from trees to poles.

SCE aims to complete remediation of 400 and 500 structures in 2023 and 2024 respectively. SCE will strive to complete 500 and 600 structures in 2023 and 2024, respectively. In 2025, SCE will remediate the balance of tree attachments in SCE’s HFRA, which is subject to change based on scope completed in previous years.

Please see Table SCE 7-02 and Appendix F: Supplemental Information (i.e., “Mitigation Effectiveness Workpapers”) for additional information on how this mitigation impacts wildfire and PSPS risk.

Impact of activity on PSPS risk: This initiative does not directly impact PSPS risk.

Updates to the activity: This program will continue through this WMP period without significant changes from our 2022 WMP, with an anticipated conclusion in 2025.

8.1.2.3.2 Fire Resistant Wrap Retrofits
Utility Initiative Tracking ID: 8.1.2.3.2

Overview of activity: Fire Resistant (FR) Wrap Retrofits is a pilot. A dead-end pole is a pole that supports the end of a conductor run spanning multiple poles. A tangent pole supports the conductor in the middle of a conductor run as depicted in Figure SCE 8-06. If a wood dead-end or tangent pole fails in a large fire, it can result in cascading failures such as the collapse of the adjacent poles/wires in a distribution line (if it is a tangent pole, then one on each side of the failed structure; if it is a dead-end pole, then on one side of the failed structure).

Figure SCE 8-06 - Dead-end Structure (left) and Tangent Structure (right)



Although wood poles themselves are generally not the source of ignition, dead-end and tangent structures carry significant amounts of weight and tension from supporting sections of overhead wire. Installing a FR wrap on dead-end and tangent poles can help the poles maintain structural integrity after a fire, which can prevent cascading failures of other poles, and shorten the restoration time. This activity will focus on installing FR wraps on dead end and tangent poles for the top riskiest circuits/circuit segments in HFRA that are located within areas experiencing the highest frequency of burns.¹⁵¹

This activity goes back to previously installed covered conductor structures to install FR wraps on unreplaced dead-end poles and adjacent tangent poles (that were not replaced because they passed pole loading requirements when covered conductor was installed) to prevent cascading failures.

Impact of activity on wildfire risk: FR wrap retrofits help mitigate against reliability concerns associated with wildfire consequence by preventing structures from falling and failing during or after wildfire events, which could create cascading failures and longer restoration time for customers post-fire. Please see Table SCE 7-02 and Appendix F: Supplemental Information (i.e., “Mitigation Effectiveness Workpapers”) for additional information on how this mitigation combined with covered conductor impacts wildfire and PSPS risk.

Impact of activity on PSPS risk: FR wrap retrofits do not have an impact on PSPS.

Updates to the activity: The retrofit of poles with FR wrap will be done in 2024. SCE will install 325 FR wraps targeting the riskiest locations. SCE may increase the scope as needed.

8.1.2.4 Transmission Pole/Tower Replacements and Reinforcements

SCE has two major pole replacement programs, the Deteriorated (Det) Pole Program and the Pole Loading Program (PLP).

As part of the Det Pole Program, SCE intrusively inspects poles through the Intrusive Pole Inspection (IPI) Program (please see Section 8.1.3.9 for a detailed description of IPI). An intrusive inspection involves drilling into the pole interior to identify and measure the extent of internal decay that is typically undetectable with external observation alone. Additionally, through the PLP, SCE assesses poles to

¹² Based on fire scar counts.

identify and repair or replace poles that do not meet GO 95 loading, temperature and safety factor requirements or, in areas with known local conditions such as high winds, SCE's loading, temperature and safety factor requirements (please see Sections 8.1.2.3 and 8.1.4 for more information on PLP). These pole programs are driven by CPUC GO 95 and GO 165 requirements.

Poles are also replaced as part of SCE's HFRI inspections and maintenance programs. SCE inspects all Transmission structures in HFRA annually (please see Section 8.1.3.2 for a detailed description of Transmission HFRI). At a minimum, each structure in HFRA is viewed via a routine/annual circuit patrol. Each structure also receives a detailed inspection at minimum every three years—or as frequently as every year—based on the risk-ranking of the structure.

Regardless of the inspection type, any issue requiring remediation is documented and worked according to GO 95 timeframes. These remediations can call for the repair or replacement of the structure or any of the structure's components, depending on its location and severity. Additionally, in HFRA, HFRI inspections are prioritized for faster completion. The timeframe for pole remediations in HFRA Tiers 2 and 3 is typically shorter than in non-HFRA areas (i.e., typically six months to remediate in HFRA Tier 3 and twelve months to remediate in HFRA Tier 2).

Poles may also be identified for replacement during miscellaneous activities if they do not meet pole loading criteria when new equipment is added or if visual damage is identified by field personnel. All these programs span SCE's entire service area, except for HFRI inspections and maintenance, which are only in SCE's HFRA.

SCE also has a Transmission Corrosion Program that assesses and remediates corroded transmission structures identified in SCE's transmission system. This program focuses on all-steel structures across SCE's service area, including out-of-state interties. The structures and lattice towers are mostly comprised of galvanized, painted steel.

Aging steel structures may be at risk of failing due to environmental factors such as soil corrosivity and atmospheric corrosion which can affect the integrity of the structure. The corrosive environments can lead to rusting, pitting, and steel loss, thereby increasing the failing risk of the structures. Once a galvanized tower begins to corrode, the corrosion advances more quickly and can lead to steel loss and structure failures unless mitigated appropriately.

The Transmission Corrosion Program consists of assessment and mitigation of these structures. During the assessment phase, SCE performs above- and below-ground visual inspections and engineering analyses such as pitting depth, remaining steel thickness measurements, and soil sampling. In addition, SCE may perform bore scoping and ultrasonic testing on Light Weight Steel (LWS) poles to determine asset health in the future.

The mitigation phase typically begins two years after the assessment phase to allow completion of the required technical review, procurement, and approval process. Mitigations depends on the assessment recommendations for each structure and may include, but are not limited to installing concrete cap footings, replacing steel members, coating structures, engaging in cathodic protection, and, if necessary, replacing the structure.

SCE discusses various transmission pole/tower replacements and reinforcements in other sections of its WMP. Please refer to Section 8.1.3.2 for a discussion of Transmission remediations, including remediation of transition spans and Transmission Integrated Wildfire Mitigation Strategy (IWMS) Engineering Analysis and Testing in Section 8.1.2.12.1 for a discussion of these efforts.

8.1.2.5 Traditional Overhead Hardening

8.1.2.5.1 Branch Line Protection Strategy

Utility Initiative Tracking ID: SH-4

Overview of activity: SCE’s Branch Line Protection activity is a program. Arcing and increased currents associated with electrical faults may produce incandescent particles which can lead to ignitions or stress equipment leading to increased failures. Reducing fault energy can lessen the amount and size of incandescent particles which decreases ignition risks. Current Limiting Fuses (CLF) are safety devices consisting of an internal filament that melts and interrupts an electric circuit if the current exceeds the fuse rating.

Some fuse designs do not meet the Cal Fire “Exempt” classification and can expel molten material when they operate, creating the potential for ignitions. Current Limiting Fuses and other CAL FIRE Exempt fuse designs generally clear faults and reduce fault energy more quickly, reducing arcing and sparks during fault events and the impact of a fault on electrical equipment along the circuit.

The objective of initiative SH-4 involves proactively installing CLFs on branch lines (Branch Line Fuses or BLFs) where no fusing previously existed and replacing conventional fuses with CLFs or other CAL FIRE Exempt fuse designs. This aims to reduce the expulsion of flammable material and the amount of fault energy, thereby reducing the potential for ignitions.

In 2018 and 2019 SCE made substantial efforts for application of branch line fusing (BLF) with current limiting fuse technology where fusing did not previously exist to help reduce ignition risk and improve electric service reliability. From 2020-2023, SCE’s focus for the fusing program shifted to branch line fuse replacements, particularly for Cal Fire non-exempt expulsion fuses and other fuses with operational concerns.

Figure SCE 8-07 - Example of Current Limiting Fuse and Fuse Holder



In addition, SCE also bundles fusing replacements, for both BLF or equipment applications with other work. These bundling efforts for equipment fuses largely focuses on replacements for non-exempt fuses for transformer applications. Tracking these fuse replacements was initiated in during inspection efforts in 2019 which cataloged these remaining non-exempt equipment fuses.

SCE is targeting to replace 500 units and will strive to replace 570 units in 2023, concluding the proactive

replacement of branch line fuses. Post 2023, SCE will work to replace any remaining fuses requiring replacement as opportunity work, or will continue to bundle replacement activities with other work.

Impact of activity on wildfire risk: By reducing the amount of fault energy and incandescent particles during a fault compared to a legacy fuse or no fusing, a CLF or other CAL FIRE “Exempt” fuses reduces the potential for faults to cause ignitions.

Impact of activity on PSPS risk: No direct impact on PSPS.

Updates to the activity: SCE does not have significant changes to branch line fuse installation and replacement strategies compared to the 2022 WMP beyond the strategies described above. Legacy fuses for these applications have largely been replaced through prior years’ WMP efforts. SCE is targeting to replace 500 units in 2023, concluding the proactive replacement of branch line fuses. Beyond 2023, additional fuses will be replaced as part of ongoing infrastructure maintenance when CLFs are identified needing replacement or repair or as part of other work when regular maintenance can be bundled.

8.1.2.5.2 Long Span Initiative

Utility Initiative Tracking ID: SH-14

Overview of the activity: SCE’s Long Span Initiative is a program that addresses increased risk of conductor clash in high wind conditions associated with distribution conductor spans of a certain length, spans with mixed conductor, spans that have a sharp angle, or spans that transition between vertical and horizontal configuration

In 2020, SCE began using LiDAR on its distribution long spans to identify locations with potential conductor clash issues and planned to remediate the highest risk locations upon field validation. In 2022, SCE enhanced its risk methodology and prioritization by incorporating the IWMS and developing a risk analysis that considers LiDAR measurements, conductor POI, and wind-related features to better target conductor clash scenarios.

Long spans that are at high risk for conductor clashing and that fall within locations that are largely consequential in the case of an ignition are prioritized for remediation. The type of remediation selected is determined by the specific details of each span and the corresponding field conditions.

This initiative includes three types of remediations that are carried out with the purpose of reducing conductor clashing risks from long spans:

1. **Line spacers** – Insulated equipment that separates the lines to reduce the possibility of wire-to-wire. It is the preferred remediation type due to the speed of deployment and its effectiveness against clashing. They are utilized during instances where there is bucket truck accessibility.

Figure SCE 8-08 - A Line Spacer Installed on a Long Span to Mitigate Wire-to-Wire Contact (Left), Close Up Line Spacer View (Right)



2. **Alternate Construction** – This includes ridge pin, box construction, wider crossarms, and interset poles. These construction configurations increase phase spacing or reduce sag, which minimizes the probability of wire-to-wire contact. This type of remediation is typically utilized when there is no bucket truck accessibility for line spacers.
3. **Covered Conductor** - The wire ensures that the lines are protected if clashing occurs. Covered conductor will be installed in instances where there is no bucket truck access and either a 3-wire span is underbuilt, or a 4-wire span does not have sufficient space for box construction.

The following flow chart demonstrates how SCE makes a determination on the type of remediation appropriate for different scenarios.

Figure SCE 8-09 - Long Span Initiative Remediation Decision Tree

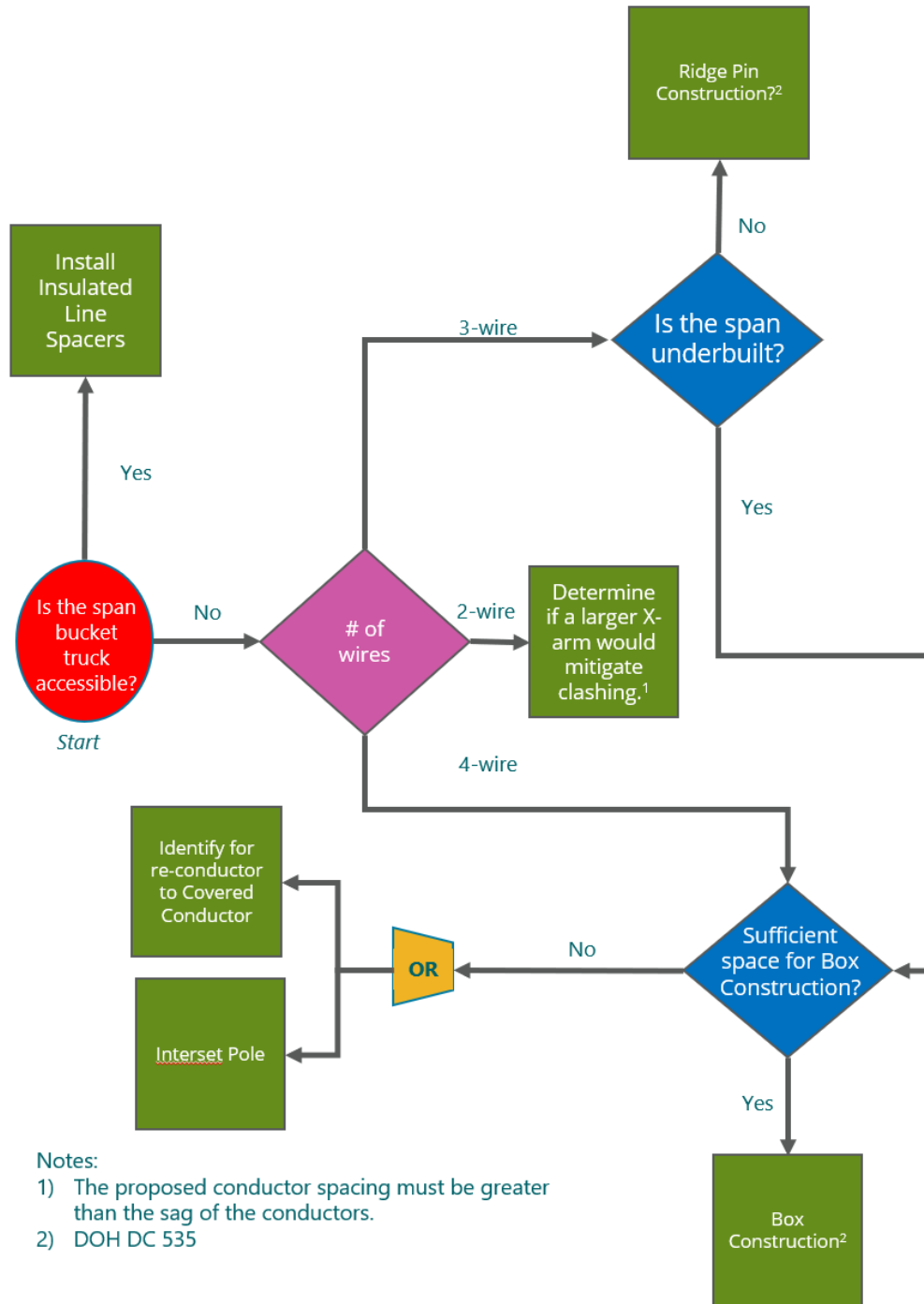

SCE aims to complete 400 spans in 2023 with a strive goal of 500 spans and aims to complete 1,000 spans in 2024 and 2025, striving to complete 1,200 spans in each 2024 and 2025.

Impact of activity on wildfire risk: This initiative is aimed to prevent wire-to-wire contact, which reduces the risk of ignition events. Please see Table SCE 7-02 and Appendix F: Supplemental Information (i.e., “Mitigation Effectiveness Workpapers”) for additional information on how this mitigation impacts wildfire and PSPS risk.

Impact of activity on PSPS risk: No direct impact on PSPS risk.

Updates to the activity: The risk prioritization methodology to determine LSI scope has been updated by using the IWMS risk analysis described above. To determine risk prioritization, SCE's new methodology considers spans in severe risk and high consequence areas and uses the LSI risk model to determine the probability of wire-to-wire contact. For example, a span with high probability of wire-to-wire contact in a Severe Risk Area would be prioritized over a span outside of a Severe Risk Area.

8.1.2.6 Emerging Grid Hardening Technology Installations and Pilots

8.1.2.6.1 Rapid Earth Fault Current Limiter – Grounding Fault Neutralizers

Utility Initiative Tracking ID: SH-17

Overview of activity: The Rapid Earth Fault Current Limiter (REFCL) initiative is a program that deploys technology that detects ground faults as small as a half ampere on one phase of a three-phase powerline. This technology almost instantly reduces the voltage on the faulted conductor while boosting the voltage on the two remaining phases. This allows SCE to maintain service for customers while extinguishing arcs. SCE is utilizing its REFCL program in HFRA to reduce the energy released from ground faults to the point that an ignition is unlikely.

SCE utilizes two approaches to implement REFCL technology: Ground Fault Neutralizer (SH-17) and Grounding Conversions (SH-18).

Ignitions caused by single phase to ground faults can be mitigated with the use of the Ground Fault Neutralizer which reduces fault energy by a factor of a thousand or more compared to typical utility designs. A Ground Fault Neutralizer can detect and act upon ground faults as small as a half ampere, making it substantially more sensitive than traditional protection.

The first GFN on the SCE system was recently installed at SCE's Neenach substation to reduce ground fault energy across the approximately 170 miles of circuitry fed by Neenach, of which approximately 70 miles are in HFRA. The Ground Fault Neutralizer is likely to be the preferred REFCL design for large substations. Large systems produce greater fault currents, which benefit more from the additional equipment used in a Ground Fault Neutralizer project. Figure SCE 8-10 below shows an example of a Ground Fault Neutralizer.

Figure SCE 8-10 - Image of a Ground Fault Neutralizer



SCE provides additional details on its REFCL program in the workpaper titled, “Rapid Earth Fault Current Limiter (REFCL) Projects at Southern California Edison.”¹⁵² This report provides an overview of SCE’s evaluation of REFCL and experience with the Ground Fault Neutralizer at Neenach substation installed in 2021 as well as experience with three grounding conversion projects:

- An overhead isolation transformer installed in 2020 covering 2.5 miles of the Calstate 12kV circuit.
- A padmount isolation transformer covering 12 miles of the Stetson 12kV circuit in 2021.
- An Arc Suppression Coil (ASC) to resonant ground Arrowhead substation, covering 40 miles of 12 kV circuitry, installed in 2021.

Additional details of REFCL can also be found in Section 8.3.3 discussing Grid Monitoring systems.

SCE aims to complete GFN at two substations in 2023, one in 2024 and four in 2025. The reduction in number of units in 2024 is because SCE is using that time to onboard a second equipment supplier.

Impact of activity on wildfire risk: A substantial number of public safety hazards from high voltage electrical equipment, including downed wire incidents, energized conductor contacts, events involving underground equipment failures, arc flashes, step and touch voltage incidents, and fire ignitions come from ground faults. REFCL technology has been found to substantially reduce the energy released in ground faults, and therefore has the potential to significantly reduce these risks. Please see Table SCE 7-02 and Appendix F: Supplemental Information (i.e., “Mitigation Effectiveness Workpapers”) for additional information on how this mitigation impacts wildfire and PSPS risk.

¹⁵² See “Rapid Earth Fault Current Limiter (REFCL) Projects at Southern California Edison” workpaper, available at <https://www.sce.com/safety/wild-fire-mitigation>

Impact of activity on PSPS risk: Currently SCE does not factor the presence of REFCL into PSPS thresholds, however that may change as SCE’s REFCL deployment expands and more experience is gained with the technology.

Updates to the activity: SCE has decided to split out Grounding Conversions from SH-17 into its own initiative, SH-18, as each has distinct uses and targets. As described below, GFN differs from grounding conversions and SCE believes it is appropriate to examine and report on these separately.

8.1.2.6.2 Rapid Earth Fault Current Limiter – Grounding Conversions

Utility Initiative Tracking ID: SH-18

Overview of activity: SH-18 is part of the REFCL program, but a newly designated activity. The REFCL grounding conversion applications act to reduce energy and ignition risk associated with single phase to ground faults. SCE created a separate category for grounding conversion projects which are utilized on smaller substations or applied at the distribution circuit level, rather than larger substations which are targeted by the REFCL GFN program. These projects convert the existing electric system to operate either ungrounded or resonant grounded without the use of the GFN. For the purposes of REFCL systems, the distinction between "large" and "small" substations/systems primarily depends on the lengths of overhead and underground circuitry. Typical grounding conversion projects cover 2 to 15 miles of circuitry.

Figure SCE 8-11 below shows the main components used to resonant ground Arrowhead substation. This project demonstrated resonant grounding which was added at an existing substation. This type of grounding conversion is likely to be the preferred REFCL design for smaller substations. Smaller substations produce lower fault current and resonant grounding alone can be used to reduce fault currents to help mitigate ignitions from ground faults.

Figure SCE 8-11 - Image of a Resonant Grounded Substation

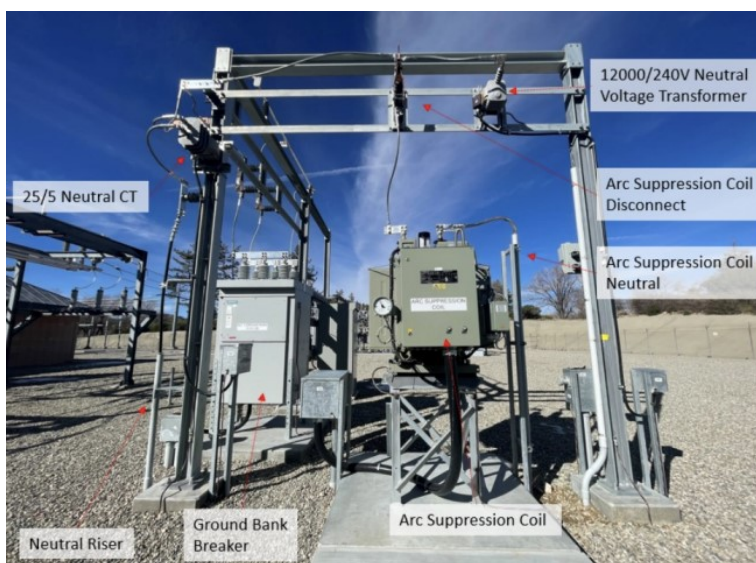

Grounding conversions for distribution circuitry outside of the substation is also possible in two variations. First the application of isolation transformers and, second the application of what SCE calls “pole tops.”

Traditionally “poletop” transformers were located on the top of a pole as depicted in Figure SCE 8-12, below, however many newer installs use padmounted equipment.

Figure SCE 8-12 - Pole Top Step Down (33kV to 12kV) Transformer (left) and Isolation (Iso) Bank Transformer (12kV to 12kV) (right)



Figure SCE 8-13 below shows an example of overhead compared to a pad-mounted isolation transformer installation. Overhead isolation transformer installations have a few limitations when compared to the pad-mounted alternative, with the main limitation being smaller size equipment which limits the amount of customer load that can be converted to the REFCL scheme. The pad-mounted isolation transformers can be built much larger and therefore be applied to serve more customer load, and additionally can simplify certain construction and operational practices.

Figure SCE 8-13 - Images of Isolation Transformers used for Grounding Conversion



In 2023, SCE anticipates completing one grounding conversion project, then four projects in each 2024 and 2025 with strive targets of six in 2024 and 2025.

Impact of activity on wildfire risk: A substantial number of public safety hazards from high voltage electrical equipment, including downed wire incidents, energized conductor contacts, events involving underground equipment failures, arc flashes, step and touch voltage incidents, and fire ignitions come from ground faults. REFCL technology has been found to substantially reduce the energy released in ground faults, and therefore has the potential to significantly reduce these risks. Please see Table SCE 7-02 and Appendix F: Supplemental Information (i.e., “Mitigation Effectiveness Workpapers”) for additional information on how this mitigation impacts wildfire and PSPS risk.

Impact of activity on PSPS risk: Currently SCE does not factor the presence of REFCL into PSPS thresholds, however that may change as SCE’s REFCL deployment expands and more experience is gained with the technology.

Updates to the activity: This is a new initiative.

8.1.2.7 Microgrids

8.1.2.7.1 Microgrid Assessments

Utility Initiative Tracking ID: 8.1.2.7.1

Overview of activity: Microgrid assessments are studies that SCE has undertaken to understand the feasibility of microgrid deployment. The microgrid program and microgrids are important tools that can help reduce wildfire risks during extreme weather conditions and support customers during PSPS de-energizations. Microgrids that can island from the grid during de-energization events can provide backup power to maintain reliability, thereby increasing community resilience.

This initiative focuses on two activities: 1) produce a study evaluating sites that are subject to frequent PSPS events to determine which sites would benefit from having a microgrid that provides backup power during de-energizations, and 2) engaging the property owners of those sites with a proposal to install a microgrid at the location to support community resilience to PSPS events.

Impact of activity on wildfire risk: This activity indirectly reduces wildfire risk since it allows SCE to maintain power delivery to customers while de-energizing the overhead lines during extreme windy events which may cause ignitions.

Impact of activity on PSPS risk: This initiative enables those served by the microgrid to maintain reliability and circumvent the impacts of a disruption in power due to a PSPS de-energization.

Updates to the activity: In October 2022, SCE identified 1,400 sites with the potential for microgrids, by identifying clusters of customers that are affected by frequent PSPS events and are mostly served through underground wires. The microgrids would operate during PSPS de-energization events, to help customers maintain reliability. However, SCE found through its study that the net cost for installing the microgrid was higher than the value of service it would provide to customers for most sites. Project deployment cost—which includes the added civil work, information technology (IT) costs, project management, and contingency costs—is on average 76% higher than the costs to both purchase microgrid assets and the lifetime operations and maintenance cost of the microgrid (e.g., fuel purchases, asset repairs and replacement, etc.) and is the driving factor behind the high cost of deploying microgrids.

Based on the evaluation, only 13 of the 1,400 sites had substantially high value of service¹⁵³ to justify further review. In November 2022, a manual site review was performed on the 13 sites to validate the feasibility of deploying the microgrid based on exposure to high winds, the configured network topology, and cost-effective alternatives. For all 13 sites, SCE determined that microgrids were not cost-effective, especially when considering the costs needed to scale the microgrid to a level that could provide enough coverage for the feeder impacted by the PSPS outage.

In 2023, SCE will re-evaluate its approach, re-run its assessment, and explore potential cooperative opportunities through the Microgrid Incentive Program, the Microgrid OIR (R.19-09-009), and/or other microgrid mechanisms. SCE also plans to pilot remote grid capabilities and is undertaking feasibility studies to determine optimal locations for the pilot. Please see Section 8.1.2.9.1 for more information about the remote grid feasibility studies.

8.1.2.8 Installation of System Automation Equipment

8.1.2.8.1 Remote Controlled Automatic Reclosers

Utility Initiative Tracking ID: SH-5

Overview of activity: SH-5 is a program to install and update Remote Controlled Automatic Reclosers. The updates are to accommodate enhanced protective settings known as Fast Curves (described further in Section 8.1.8.1.1). Distribution circuits span many miles, may traverse areas of varying risk, and are subject to varying weather conditions based on specific asset locations. In the past, during PSPS events, both the portions of circuits that do not pose ignition risks and the portions that present ignition risks have been de-energized, as there were no available means of isolating these segments to only de-energize portions of concern. To address this issue, SCE is installing Remote Control Switches (RCS) and Remote Automatic Reclosure (RARs) devices to help sectionalize circuits and control the flow of electricity remotely.

¹⁵³ SCE uses the Value of Service (VOS) as described by the Nexant 2019 Value of Service Study presented in the 2021 General Rate Case (GRC).

Remote Control Switches (RCS)

RCS are a type of load sectionalization device that helps SCE limit PSPS de-energization to fewer and smaller circuit segments. Although SCE has traditionally installed automation equipment to improve reliability and provide operational flexibility, it has since expanded its distribution automation activities as part of wildfire and PSPS mitigation strategy (see Figure SCE 8-13 - Images of Isolation Transformers used for Grounding Conversion).

Having manual switches increases the time and resources needed for de-energization, testing, and re-energization. The remote-control capabilities associated with RCS are necessary to enable SCE to quickly respond to emergent fire danger conditions to reduce ignition driver risks and minimize the effects of PSPS events.

Remote Automatic Reclosures (RARs)

RARs are a type of fault-interrupting automatic switch that shuts off electric power when an electrical fault or short circuit is detected, thus reducing the risk of ignition (see Figure SCE 8-13 - Images of Isolation Transformers used for Grounding Conversion). RARs are reclosers that have been modified to be remotely operated by means of a radio. They operate in a similar fashion to a substation Circuit Breaker but are located on distribution line sections remote from the substation.

Figure SCE 8-14 - Sectionalizing Devices Limit De-energization to Smaller Segments

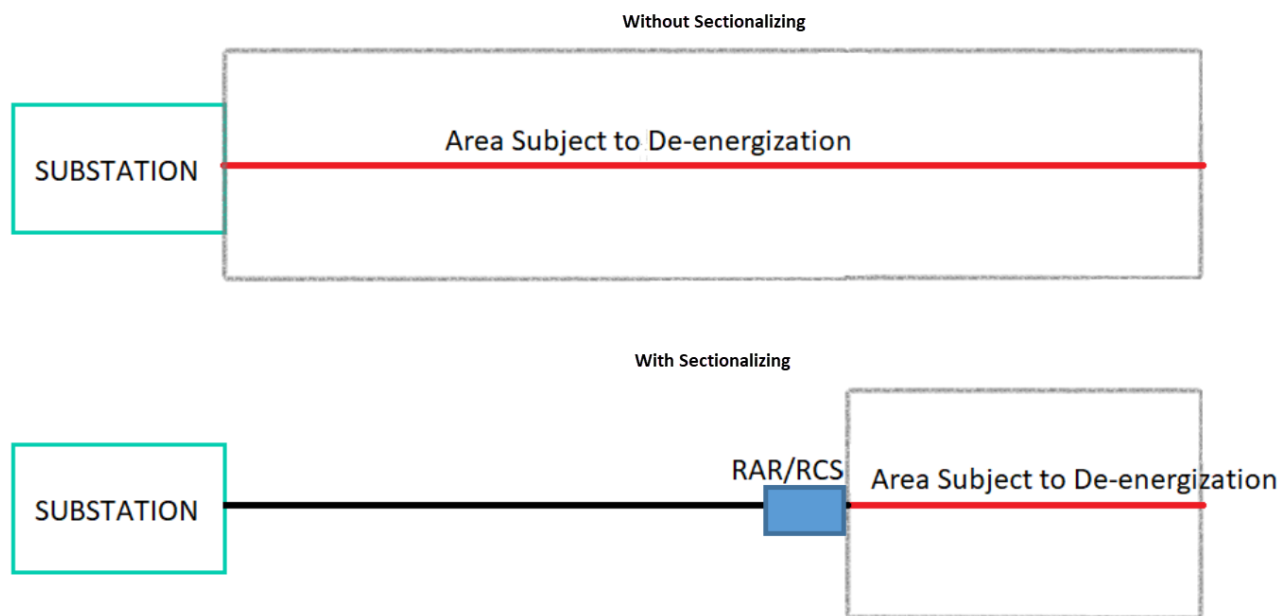

New RARs and RCSs will be required to further sectionalize circuits and circuit segments and improve ability to reduce PSPS scope, isolate faults and improve restoration time. As described in Section 8.1.8.1.1, SCE increases the fault sensitivity of RARs by way of operational settings during adverse weather conditions.

Figure SCE 8-15 - A Remote Control Box (left) and Remote Automatic Recloser (RAR) Switch (right)



SCE aims to complete six RAR/RCS projects in 2023 and five in each 2024 and 2025, subject to PSPS analysis from the prior year, which can inform where projects are most needed. SCE will strive to complete as many as 17 projects each year between 2023 and 2025.

Impact of activity on wildfire risk: Fast Curve settings that are enabled on RARs can reduce response time to protect the line from fault currents when they occur, thereby reducing ignition risk. Please see Section 8.1.8.1.1 for further discussion on Fast Curves. Please see Table 7-2 and Appendix F: Supplemental Information (i.e., “Mitigation Effectiveness Workpapers”) for additional information on how this mitigation impacts wildfire risk.

Impact of activity on PSPS risk: RARs and RCSs allow SCE to sectionalize circuits into smaller segments during PSPS and thus reduce the scope and size of PSPS. Please see Table SCE 7-02 and Appendix F: Supplemental Information (i.e., “Mitigation Effectiveness Workpapers”) for additional information on how this mitigation impacts PSPS risk.

Updates to the activity: SCE plans to perform detailed engineering reviews to identify locations for new RARs to help further expand to potentially impacted customers the coverage afforded by these devices. In addition, SCE has been making updates to the Fast Curve settings that are enabled on these devices, which is discussed in more detail in Section 8.1.8.1.1

8.1.2.8.2 Circuit Breaker Relay Hardware for Fast Curve

Utility Initiative Tracking ID: SH-6

Overview of activity: Upgrading circuit breakers is a program. At substations, a relay is a device designed to trip a Circuit Breaker (CB) when it detects a fault, which is an electrical disturbance in the power system accompanied by a sudden increase in current. The CB then interrupts the current flow, cutting off the power supply to minimize damage to the circuit. As discussed in Section 8.1.8.1.1 and 8.3.3, SCE has implemented Fast Curve settings at substation CB relays (SH-6) in addition to the RARs (SH-5), discussed above, to increase the speed of the relay detecting a fault and deenergizes a circuit, thus decreasing the risk of an ignition. SCE upgrades old electromechanical relays with new microprocessor relays that can accommodate Fast Curve settings integration.

Figure SCE 8-16 - Depiction of Circuit Breaker Relative to Remote Automatic Reclosers & Fuses

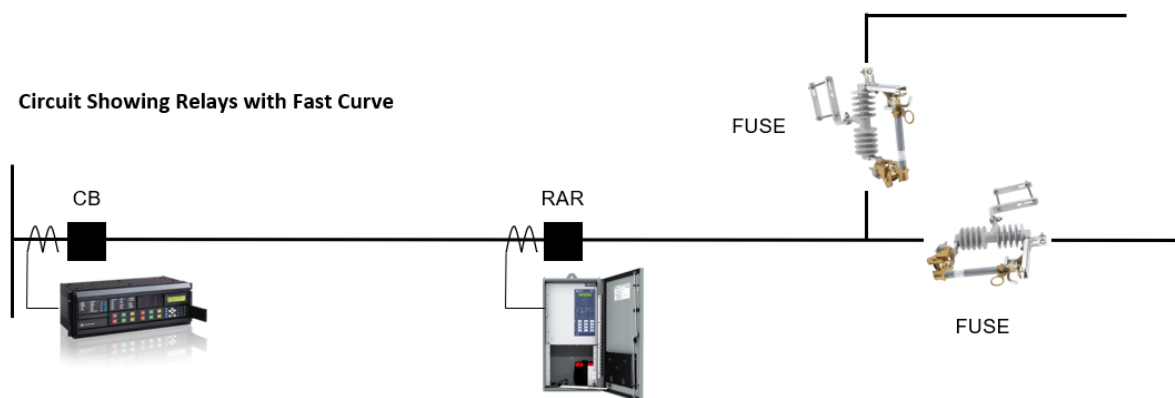

SCE aims to replace or upgrade 75 circuit breakers in 2023 but will strive for 88. In 2024 SCE aims to complete an additional 10 units, sunsetting the program after these units are completed.

Impact of activity on wildfire risk: CB Relays with Fast Curve settings allows SCE to more quickly protect circuits when fault currents are detected. The result is reduced ignition risk from any fault event. Please see Section 8.1.8.1.1 for a discussion of Fast Curve settings, and Table SCE 7-02 and Appendix F: Supplemental Information (i.e., “Mitigation Effectiveness Workpapers”) for additional information on how this mitigation impacts wildfire risk.

Impact of activity on PSPS risk: This initiative does not impact PSPS risk as PSPS prevents faults from occurring whereas CBs with Fast Curve settings protect a circuit quicker after a fault occurs. Please see Table SCE 7-02 and Appendix F: Supplemental Information (i.e., “Mitigation Effectiveness Workpapers”) for additional information on how this mitigation impacts PSPS risk.

Updates to the activity: SCE is continuing to replace old electromechanical relays with modern microprocessor relays on circuit breakers to allow them to be set with Fast Curves. SCE is also updating its Fast Curve settings as discussed in Section 8.1.8.1.1.

8.1.2.9 Line Removal (in the HFTD)

8.1.2.9.1 Remote Grid Feasibility Study for Wildfire Reduction

Utility Initiative Tracking ID: 8.1.2.9.1

Overview of the Activity: A remote grid is a configuration where a small number of customers in remote locations are served entirely by local Distributed Energy Resources (DERs) that are disconnected from the SCE grid, as shown in Figure SCE 8-17. These are similar to microgrids, without the option to be connected to the larger grid. See Section 8.1.2.7.1 for more information about SCE’s Microgrid Assessment.

Figure SCE 8-17 - Remote Grid System Diagram

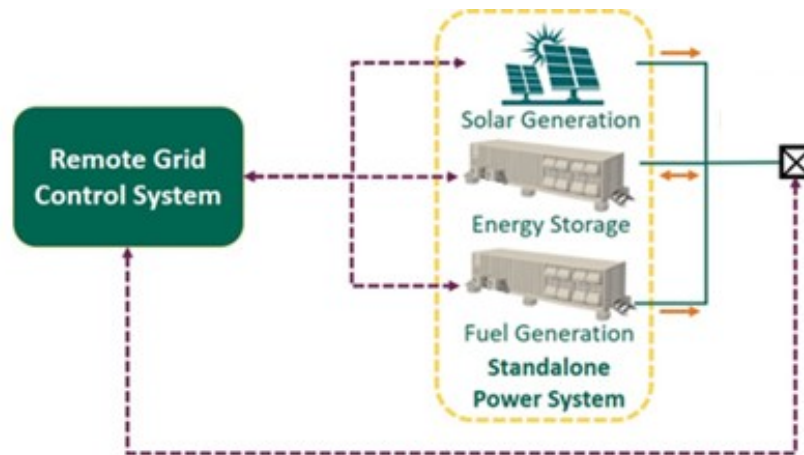

Remote grid systems are comprised of solar PV, battery energy storage, backup fuel generator and grid system controller to form a permanent islanded power system co-located with the customer loads. Customers in remote areas with relatively small and steady load (typically < 100 kW) can potentially be served by remote grids, allowing for improved resiliency by isolating the customer loads from other portions of the grid where ignitions or faults may occur (i.e., the overhead portion of the grid serving those customers). As SCE's IWMS identifies undergrounding line segments in severe risk areas where there are egress constraints and other high consequential criteria, remote grids may be a viable alternative to reducing ignition risk in select cases where undergrounding of distribution lines are infeasible or very expensive (see Section 8.1.2.2.1 for a discussion of SCE's undergrounding initiatives).

There are also potential additional benefits, such as reduced vegetation management and inspection work, since the long lines that connect the customer load to the rest of the grid will be removed. A related activity is the Microgrid Assessment which is discussed in Section 8.1.2.7.1.

The focus of this activity is to perform a feasibility study to determine whether a remote grid is a viable option at locations that are scoped for undergrounding and exhibit high length to load ratio (i.e., has a long line segment feeding a small load). The outcome of each study will indicate whether a remote grid is feasible and cost-effective and determine its effectiveness as a mitigation strategy in lieu of undergrounding.

The number of studies were determined based on SCE's evaluation of how many locations SCE found where undergrounding is infeasible and the ratio of line length to load appears to be relatively high. This list was further refined using SCE's IWMS risk tranches to prioritize locations in Severe Risk Areas. From this review process, SCE has identified 13 locations that meet the criteria.

Impact of activity on wildfire risk: This activity does not directly impact wildfire risk drivers. However, once the study identifies a location appropriate for a remote grid, the resulting associated work will remove overhead lines and thus substantially reduce the risk of wildfire from those overhead lines.

Impact of activity on PSPS risk: This activity does not directly impact PSPS risk. However, once the study identifies a location appropriate for a remote grid, the resulting associated work will substantially reduce PSPS risk to a particular location as it will no longer be impacted by de-energized facilities.

Updates to the activity: Not applicable as this is a new WMP activity.

8.1.2.10 Other Grid Topology Improvements to Minimize Risk of Ignitions

8.1.2.10.1 Legacy Facilities

Utility Initiative Tracking ID: 8.1.2.10.1, formerly SH-11

Overview of activity: In prior WMPs, SCE implemented initiative SH-11, Legacy Facilities, to harden electrical equipment supporting SCE's hydroelectric generation operations. These generation-related assets in HFRA were examined for potential ignition risks and mitigations applied in the form of installing covered conductor, removing bare conductor, re-routing to existing lines that are already equipped with covered conductor, and updating control circuits with updated protections. SCE previously had three sub-activities in this initiative:

- Low Voltage site hardening, which assesses a variety of low voltage sites in HFRA for opportunities to reduce wildfire risk.
- Updating hydro control circuits, which involves an assessment of distribution lines that feed hydroelectric generation facilities exclusively.
- Assessing and updating grounding grids and lightning arrestors help ensure that in the event of a lightning strike or electrical incident, equipment can handle the voltage and release safely instead of causing additional wildfire risk.

Impact of activity on wildfire risk: Bare copper control circuit wire between the hydroelectric generation facility and operating gatehouse travels along the same path as the open wire distribution lines feeding the legacy facility. Re-routing to an existing covered conductor line and upgrading the bare copper controls to a fiber circuit reduces the risks of ignitions due to contact from object or clashing of bare conductors. Remediation of the grounding grid and lightning arrestors help ensure equipment is able to safely discharge voltage in the event of a lightning strike or electrical fault and not cause additional wildfire risk.

Impact of activity on PSPS risk: Sites with grid hardening measures such as covered conductor can benefit from reduced PSPS risk as CC increases wind thresholds allowing lines to remain energized during higher wind speed events.

Updates to the activity: In 2022, SCE completed its targets for low voltage hardening and grounding grid studies, however only completed two out of the three hydro control reconductoring projects. The incomplete reconductor project at Siphon was delayed due to external environmental permitting issues and SCE expects to complete the project in Q3 2023.

On a going forward basis, SCE will continue to assess and update grounding grids and lightning arrestors

as applicable to help ensure that in the event of a lightning strike or electrical incident, equipment can handle the voltage and release safely instead of causing additional wildfire risk. This may involve installing grounding rods, rushed rock, and lightning arrestors in years 2023, 2024 and 2025 at various legacy facility sites.

8.1.2.10.2 Vertical Switches

Utility Initiative Tracking ID: SH-15

Overview of activity: Vertical switch upgrades is a program to upgrade switches, which need replacement. Engineering analysis of legacy vertical distribution switches concluded that older switches may generate incandescent particles if not properly adjusted or constructed. Additionally, a study revealed that wooden crossarms, upon which these switches are mounted, may shrink or warp over time potentially allowing the switch system to move out of alignment. A misaligned or improperly constructed switch may not perform normally and within its ratings. Findings from vertical switch inspections performed in 2019 in HFRA reinforced the need to replace the vertical switch population. The findings identified misadjusted switches and other construction issues that may negatively affect the wood crossarm based vertical switch systems.

Specifically, the mounting hardware for these legacy vertical switches clamp and bolt to the wood crossarms. Over time, warping of the wooden crossarms can cause the mounting hardware to loosen and correspondingly cause the vertical switch contacts to be out of alignment, potentially leading to failures. If a vertical switch fails, arcing may generate sparks with sufficient heat content to reach the ground.

This initiative replaces previously identified wooden crossarm mounted vertical switches requiring replacement with composite crossarm mounted vertical switches in SCE's HFRA.

Impact of activity on wildfire risk: A concern with vertical switch failures is the production of sparks associated with misaligned contacts. If a vertical switch fails, arcing may generate arcs or spark showers with sufficient heat content to reach the ground. The replacement of wooden crossarm mounted vertical switches identified for requiring replacement with composite crossarm mounted vertical switches in SCE's HFRA may reduce these events from faulty or worn devices, and therefore reduce the risk of ignitions from equipment failure that can lead to wildfires.

Impact of activity on PSPS risk: No direct impact on PSPS.

Updates to the activity: SCE has made no changes to the initiative since the last WMP submission. SCE will continue replacement of vertical switches as reported for 2021 and 2022. SCE anticipates completing remaining switch replacements in 2023.

8.1.2.11 Other Grid Topology Improvements to Mitigate or Reduce PSPS Events

As part of its IWMS, SCE evaluates circuits that face potential impacts from PSPS and determines appropriate mitigations such as grid hardening (see SH-1, Section 8.1.2.1 and SH-2, Section 8.1.2.2) and sectionalizing devices (see SH-5, Section 8.1.2.8). These targeted mitigations can help reduce the need for PSPS or reduce the number of customers impacted by PSPS. For example, these efforts could reduce the impact of PSPS on customers located in non-HFRA that are connected to circuits that traverse HFRA, and customers located on certain underground circuit segments within HFRA that are fed from overhead circuitry within HFRA. Targeted covered conductor deployment can help increase windspeed thresholds for PSPS de-energization. Please see Section 9 – PSPS for further discussion on SCE’s PSPS program and approaches to minimize impacts to customers.

8.1.2.12 Other Technologies and Systems Not Listed Above

8.1.2.12.1 Transmission Integrated Wildfire Mitigation Strategy (IWMS) Engineering Analysis and Testing

Utility Initiative Tracking ID: 8.1.2.12.1

Overview of activity: Transmission IWMS is a study. While transmission lines have a lower probability of failure compared to distribution lines, there still exists risks associated with ignitions that could propagate from a transmission line. SCE has primarily focused its wildfire mitigation efforts on the riskiest areas of the distribution system and has made significant progress. SCE now looks to address the remaining risk on the Transmission System.

Currently, SCE performs ongoing inspections, maintenance, and vegetation management related wildfire mitigations on the transmission system. This proposed activity will explore additional potential mitigations for the transmission system in 2023, which would include an assessment of feasibility and a cost analysis of potential mitigation options. If the studies find that the mitigations are feasible and cost-effective, then SCE may deploy them in the future.

Impact of activity on wildfire risk: This activity does not directly impact WF risk drivers. However, the mitigations that may come out of this activity are intended to address drivers such as contact-from-object, wire-to-wire contact, and equipment failure.

Impact of activity on PSPS risk: This activity does not directly impact PSPS risk drivers. However, the mitigations that may come out of this activity will be reviewed to see if they can reduce PSPS risk in addition to wildfire risk.

Updates to the activity: Not applicable, this is a new study.

8.1.3 Asset Inspections

In this section, the electrical corporation must provide an overview of its procedures for inspecting its assets.

The electrical corporation must first summarize details regarding its ~~vegetation management~~¹⁵⁴ inspections in Table 8-6. The table must include the following:

- **Type of inspection:** i.e., distribution, transmission, or substation
- **Inspection program name:** Identify various inspection programs within the electrical corporation
- **Frequency or trigger:** Identify the frequency or triggers, such as inputs from the risk model. Indicate differences in frequency or trigger by HTFD Tier, if applicable
- **Method of inspection:** Identify the methods used to perform the inspection (e.g., patrol, detailed, aerial, climbing, and LiDAR)
- **Governing standards and operating procedures:** Identify the regulatory requirements and the electrical corporation's procedures for addressing them

Table 8-6 - Asset Inspection Frequency, Method, and Criteria

Type	Inspection Program	Frequency or Trigger (Note 1)	Method of Inspection (Note 2)	Governing Standards & Operating Procedures
Distribution	Distribution Detailed Inspections and Remediations	As Identified in Section 8.1.3.1 Frequency	Detailed ¹⁵⁵ Ground Inspection Detailed Aerial Inspection (See Section 8.1.3.1 Process)	GO 95 GO 165 Distribution Inspection Maintenance Program (DIMP)
Transmission	Transmission Detailed Inspections and Remediations	As Identified in Section 8.1.3.2 Frequency	Detailed Ground Inspection Detailed Aerial Inspection (See Section 8.1.3.2 Process)	GO 95 GO 165 Transmission Inspection Maintenance Program (TIMP) North American Electric Reliability Corporation (NERC) Western Electricity Coordinating Council (WECC) California Independent System Operator's (CAISO) Transmission

¹⁵⁴ Manual adjustment by SCE to reflect the asset inspections section.

¹⁵⁵ As referenced within GO 165, Section III-A4.

Type	Inspection Program	Frequency or Trigger (Note 1)	Method of Inspection (Note 2)	Governing Standards & Operating Procedures
				Control Agreement
Distribution	Distribution Patrol Inspections	Annually	Patrol ¹⁵⁶ (See Section 8.1.3.3 Process)	GO 95 GO 165 DIMP
Transmission	Transmission Patrol Inspections	Annually	Patrol (See Section 8.1.3.4 Process)	GO 165 TIMP NERC WECC CAISO Transmission Control Agreement
Distribution	Distribution Infrared (IR) Inspections	As Identified in Section 8.1.3.5	Infrared (IR) (See Section 8.1.3.5 Process)	GO 95 GO 165
Transmission	Transmission Infrared (IR) and Corona Scan Inspections	As Identified in Section 8.1.3.6	Infrared (IR) and Corona Scan (See Section 8.1.3.6 Process)	GO 95 GO 165
Generation	Generation Inspections	As Identified in Section 8.1.3.7	Detailed Ground Inspection (See Section 8.1.3.7 Process)	GO 95 GO 165 GO 167-B
Transmission	Transmission Conductor and Splice Assessment	As Identified in Section 8.1.3.8	LineVue or X-Ray (See Section 8.1.3.8 Process)	GO 95 GO 165
Distribution	Intrusive Pole Inspections	Annually	Visual and Internal Examination (See Section 8.1.3.9 Process)	GO 95 GO 165 Materials Specification (MS) 454
Substation	Substation Inspections	For substations that were identified as part of the Failure Mode &	Predictive Maintenance Assessment (PMA) (includes Circuit Breaker Online	GO 174 Substation Construction & Maintenance (SC&M) Maintenance and Inspection Manual (MIM) Appendix A: PMA

¹⁵⁶ As referenced within GO 165, Section III-A3.

Type	Inspection Program	Frequency or Trigger (Note 1)	Method of Inspection (Note 2)	Governing Standards & Operating Procedures
		Effects Analysis (FMEA), ¹⁵⁷ these inspections are performed every 2 years.	Monitoring (CBOLM) and Oil Circuit Breaker Analysis (OCBA) Inspection is done for all substation equipment by means of visual, infrared thermography and ultrasonic inspection (See Section 8.1.3.10 Process)	Criteria, Pages A-1, A-2 and A-3

Note 1: The electrical corporation must provide electrical corporation-specific risk-informed triggers used for asset inspections.

Note 2: The electrical corporation must provide electrical corporation-specific definitions of the different methods of inspection.

The electrical corporation must then provide a narrative overview of each ~~vegetation asset~~¹⁵⁸ inspection program identified in the above table; Sections 8.2.2.1. provides instructions for the overviews. The sections should be numbered 8.1.3.1 to Section 8.1.3. (i.e., each ~~vegetation asset~~¹⁵⁹ inspection program is detailed in its own section). The electrical corporation must include inspection programs it is discontinuing or has discontinued since the last WMP submission; in these cases the electrical corporation must explain why the program is being discontinued or has been discontinued.

¹⁵⁷ The purpose of the study was to develop recommendations for substation equipment inspection and maintenance based on qualitative analysis of probability and consequence of failure and associated ignition.

¹⁵⁸ Manual adjustment by SCE to reflect the asset inspections section.

¹⁵⁹ Manual adjustment by SCE to reflect the asset inspections section.

8.1.3.1 Distribution Detailed Inspections and Remediations (IN-1.1)¹⁶⁰

Process

In this section, the electrical corporation must provide an overview of the individual asset inspection program, including inspection criteria and the various inspection methods used for each inspection program.

SCE performs visual detailed inspections of distribution facilities as part of its routine practices throughout its service area in compliance with GO 165. Degradation of equipment and structures as part of wear and tear during normal operations and due to external factors, such as weather or third-party caused damage increases the probability of in-service malfunction or failures that can have safety and service reliability impacts. GO 95 provides guidance on overhead electric line construction standards and GO 165 provides guidance on the minimum timing for inspections. SCE performs inspections in our high-fire risk areas that go beyond the GO 95 and GO 165 requirements as described below.

To identify equipment or structure degradation that occurs between compliance cycles that could lead to a potential ignition risk, SCE conducts more frequent and ignition-focused risk inspections in HFRA beyond GO 165 requirements (“High Fire Risk-Informed inspections” or “HFRI inspections”). Prior to 2019, distribution detailed inspections entailed a ground-based visual inspection conducted by inspectors within HFRA and non-HFRA.

In 2019, a crossarm failed on a pole, and resulted in a small fire. An investigation revealed that the crossarm was damaged, and the damage was not visible from the ground. Thus, in 2019 SCE began to also perform aerial detailed visual inspections via helicopter or drone as shown below in Figure SCE 8-18 in HFRA to supplement ground-based inspections to identify deterioration or unfavorable asset conditions, such as a damaged pole top as shown below in Figure SCE 8-19. Ground inspections continue to be necessary because they help detect equipment/structure conditions that are difficult to identify via aerial inspections (e.g., the condition of guy anchors are not able to be assessed appropriately via aerial inspections), such as a damaged wood pole and h-frame (see Figure SCE 8-20 and

Figure SCE 8-21 below). In 2022, SCE piloted a single visit 360 inspection for distribution (for inspections on 33kV assets and below), this consisted of performing the ground and aerial inspections for the structure on the same visit. 360 Inspections will not typically be performed by one individual, but instead by both an inspector and a pilot. In some cases, a single inspector will perform an inclusive inspection (ground and aerial). A quality review of a pre-determined percentage will be performed to ensure consistency and aptitude of inspection.

¹⁶⁰ The “Distribution Detailed Inspections and Remediations” program is referred to as “HFRA 360” within the 2025 GRC.

Figure SCE 8-18 - Drone (left) and SCE Helicopter (right)

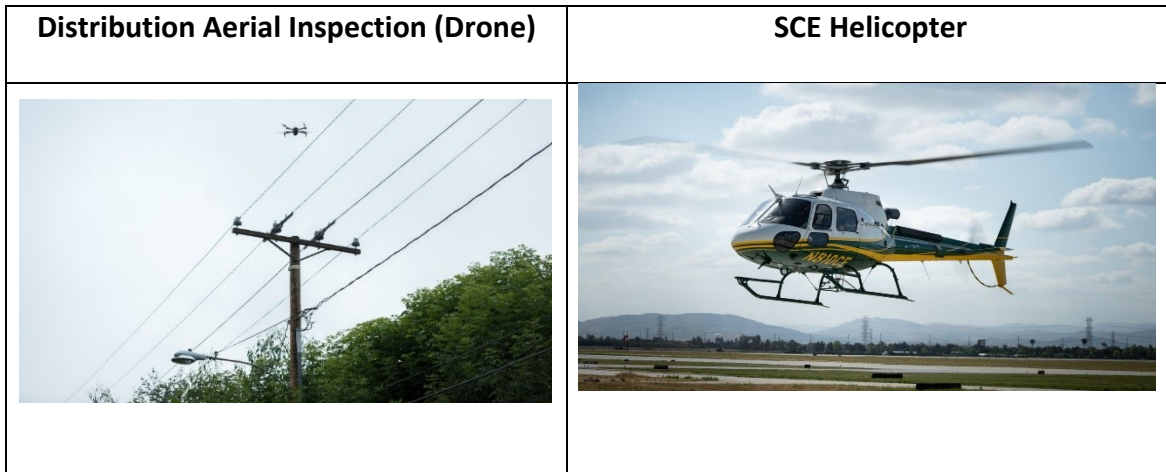

Figure SCE 8-19 - Damaged Pole Top on a 4kV Circuit (Drone Capture)

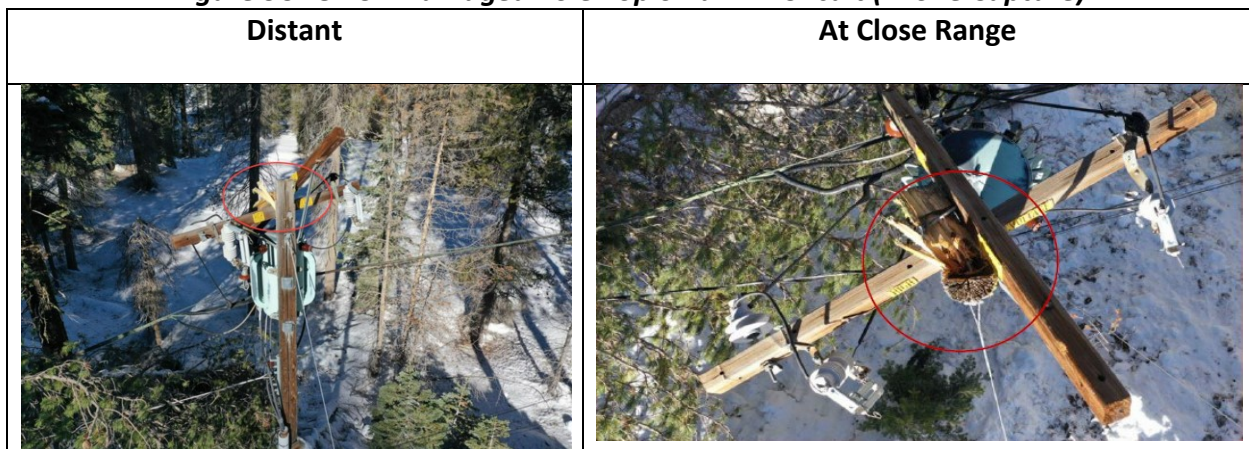

Figure SCE 8-20 - Damaged Wood Pole on a 16kV Circuit

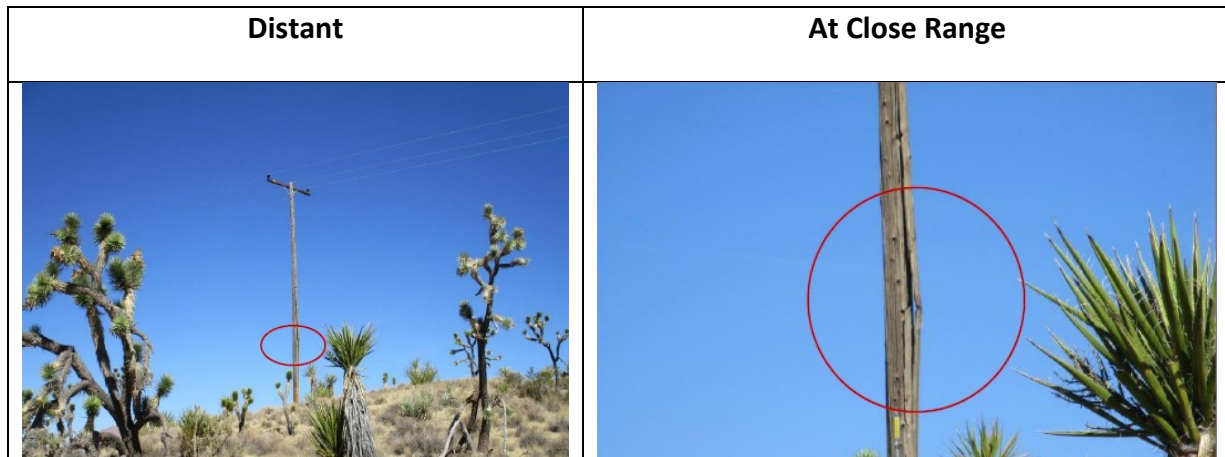
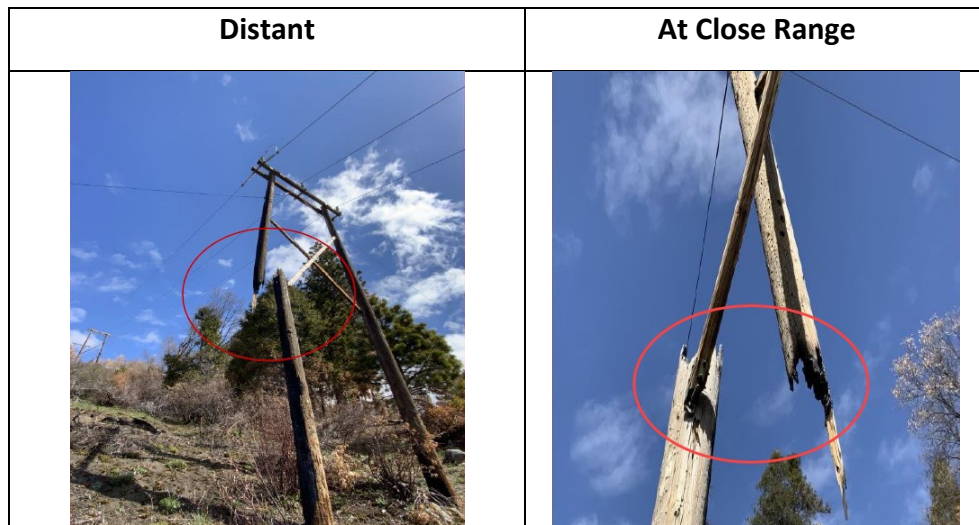

Figure SCE 8-21 - Damaged H-Frame on a 12kV Circuit



The frequency of HFRI inspections varies by the location-specific risk (as defined by IWMS) within SCE’s HFRA and emergent conditions. Issues identified by inspectors during the detailed inspections are prioritized for remediation to be completed within GO95 compliance timelines. Remediations can be repairs to or replacements of existing assets depending on asset condition. For example, SCE repairs ground molding with that is found to be broken/damaged with an exposed ground wire at the public level. Also, SCE replaces wood guy guards if found to be missing, damaged or outdated.

SCE has enhanced its HFRI inspections since 2018 based on continuously improving data and ignition risk analysis. One such example is that since 2020, SCE’s Fire Science team has identified Areas of Concern (AOCs) in HFRA based on actual current year conditions, which are areas that pose increased fuel-driven (Summer AOCs) and wind-driven (Fall AOCs) fire risk. The AOCs are identified based on several factors, including fire history, current and near-term weather conditions, fuel type, exposure to wind, and egress, among others. To mitigate the potential risk in AOCs, SCE implements an action plan in the AOCs that includes inspections of the assets (e.g., distribution, transmission, and generation) and, acceleration of remediations for the assets with the highest risk.

SCE also updates its AOCs effort each year based on lessons learned in order to optimize efficiency in execution of the action plan prior to peak fire season.

From 2023 to 2025, SCE’s distribution detailed inspections will include a single visit ground and aerial inspection of the structure also known as the “360 inspection.” In addition, SCE plans to continue the Summer and Fall AOCs program as a component of the distribution detailed inspections.

Include relevant visuals and graphics depicting the workflow and decision-making process the electrical corporation uses for the inspection program.

Figure 8-1a below depicts the workflow and decision process regarding distribution detailed inspections.

Figure 8-1a - Distribution Detailed Inspections and Remediations Workflow

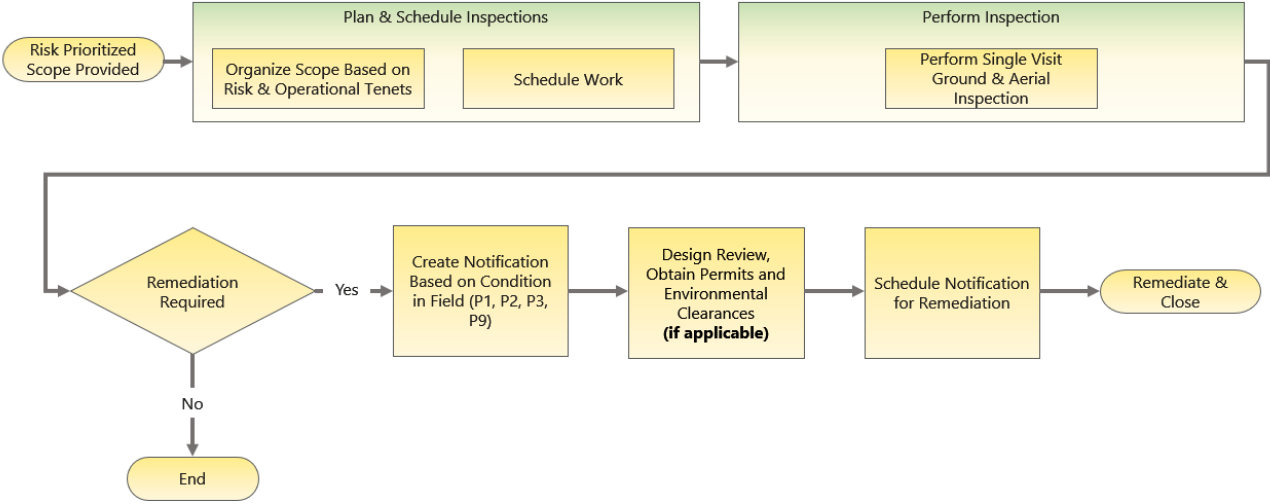

Frequency or Trigger

In this section, the electrical corporation must identify the frequency (including how frequency may differ by HFTD Tier or other risk designation[s]) or triggers used in the inspection program, such as inputs from the risk model.

SCE conducts detailed inspections of each structure within HFRA at least once every three years, which exceeds the GO 165 requirements of once every five years.¹⁶¹ Standard ground-based distribution detailed inspections continue to be performed in SCE's non-HFRA every five years in accordance with GO 165 requirements.

Because risk levels vary across SCE's HFRA, structures are prioritized for inspection based on POI and consequence. In determining the 2023 Distribution HFRI inspection scope, SCE used the locational risk categorization from its IWMS Risk Framework, incorporated the latest risk modeling, and appropriate reserve capacity needed for resources to perform emergent AOCs. Figure SCE 8-22 below, outlines the process by which SCE incorporates risk through its inspection scoping processes.

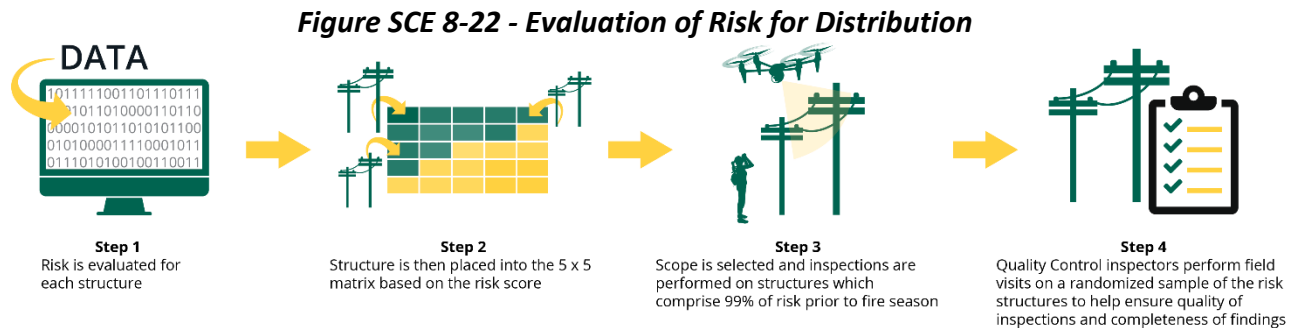

In 2022, SCE shifted to a 5x5 matrix with one dimension of the matrix representing five levels of POI risk and the other dimension representing five levels of consequence. The structures that fall into Severe Risk Area and High Consequence Area IWMS tranches and qualify as the highest risk structures in their respective 5x5 matrix are inspected more frequently. This is illustrated in Figure SCE 8-23 below. Each 5x5 matrix in the figure represents the portion of the structure population that qualifies as the specific IWMS tranche (e.g., Severe Risk Areas, High Consequence Areas or Other HFRA). The percentages within each cell represents the percent of total risk associated with the structures within the population. The percent of total risk takes into consideration the number of structures in the cell which may result in a higher percentage in a relatively lower risk cell compared to a relatively higher risk cell (i.e., POI Level 5, TS Level 1 contains a higher risk total percent than POI Level 1, TS Level 1). Figure SCE 8-23 shows that in 2023, SCE will inspect structures that comprise approximately 99% of risk in HFRA associated with distribution structures.¹⁶²

¹⁶¹ The not to exceed three-year frequency guidance applies to all structures within HFRA distribution scope (e.g., distribution poles, combination poles and streetlight only poles) unless designated as higher frequency based on risk.

¹⁶² Risk as measured by multiplying POI by Technosylva consequence. The same 99% risk coverage applies to SCE's Transmission Detailed Inspections.

SCE will annually inspect at minimum, all structures in areas identified as Severe Risk Areas and those structures identified within an AOCs. Additionally, in 2023 SCE will inspect highest risk structures in Severe Risk Areas IWMS category twice per year. Structures in High Consequence Areas will either be inspected annually, or once every two years depending on the risk profile. All remaining lower risk structures captured within the IWMS Other HFRA category will be inspected once every three years.

Figure SCE 8-23 - Visualization of Risk Analysis for Distribution

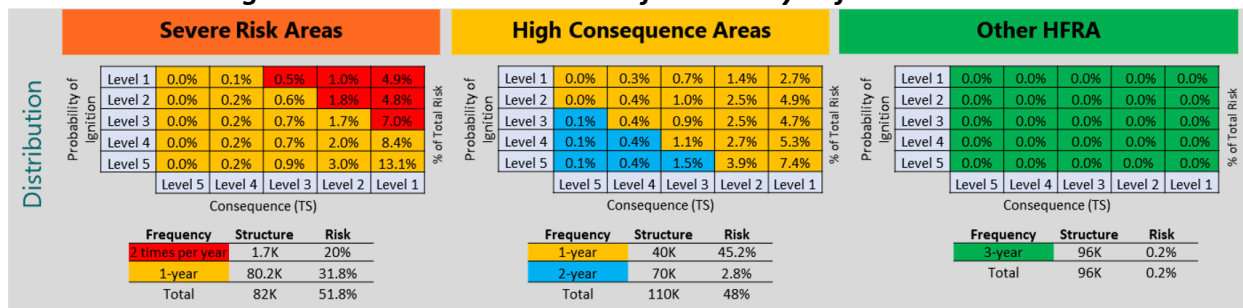

Regarding remediations, Priority 1 (P1) conditions are addressed within 72 hours either by fully remediating the condition or by temporarily repairing the equipment or structure and resolving immediate safety concerns prior to more extensive follow-up corrective action. P1 notifications are emergent activities, also referred to as breakdown maintenance, and include the repair of SCE equipment and structures that are severely damaged, compromised or have failed while in service. Examples of P1 conditions include vegetation touching lines, broken crossarms or insulators, burned connectors, or wires laying on crossarms.

Priority 2 (P2) issues are lower risk than P1s and therefore are resolved within six months for Tier 3 or 12 months for Tier 2 within HFRA. Examples of P2 issues include vegetation near lines and deteriorated crossarms or splices.

Priority 3 (P3) issues do not require near-term remediation because they do not pose material safety, reliability, or fire risks, and will either be repaired in conjunction with other scheduled work at the structure or re-evaluated at or before the next detailed inspection. P3 issues generally require remediation within 60 months pursuant to GO 95, Rule 18. Examples of P3 issues include missing items such as reflector strips, ground moldings, guy wire guards, or high voltage signs.

If the inspection program is schedule-based, the electrical corporation must explain how it uses risk prioritization in the scheduling of the inspection program to target high-risk areas. If the electrical corporation does not use risk prioritization in the scheduling of the inspection program, it must explain why.

SCE utilizes a risk-informed strategy as described above to identify inspection scope and then schedules those inspections in HFRA to be performed before the peak of fire season and Non-HFRA inspections to be completed based on their compliance due dates. Additionally, SCE informs its schedule by prioritizing inspections in Summer AOCs areas to be completed prior to summer and Fall AOCs areas to be completed prior to fall.

Accomplishments, Roadblocks, and Updates

In this section, the electrical corporation must discuss:

- *Noteworthy accomplishments for the inspection program since the last WMP submission*

In 2022, SCE completed 162,721 distribution ground inspections and 157,144 distribution aerial inspections which exceeded the targets of 152,000 and 150,000 respectively. As discussed above, in 2022, SCE successfully completed the 360 inspections for distribution pilot, which consisted of performing ground and aerial inspections for structures on the same visit. The previous approach, for HFRA inspections, consisted of a ground and aerial inspection taking place on separate schedules. The benefits of this new approach are fewer anticipated customer impacts, more efficient notification prioritization, safety benefits for field personnel, more consistent asset data capture, as well as reduction in environmental impacts (e.g., reduced driving in the field).

Another noteworthy accomplishment in 2022 is a decrease in QA/QC findings regarding secondary conductors. SCE has deployed improved training for its inspectors and improvements within the inspection survey which has contributed to this decrease. Please reference ACI SCE-22-17 Address Secondary Conductor Issues within Appendix D: Areas for Continued Improvement of this WMP for additional details.

- *Roadblocks the electrical corporation has encountered while implementing the inspection program and how the electrical corporation has addressed the roadblocks*

In 2022, SCE encountered access and customer issues when performing the distribution detailed inspection program. To address access issues, SCE utilized Air Operations to perform the inspections aerially, where possible. For any customer issues raised, SCE coordinated with each of the customers in an attempt to resolve their concerns and perform the inspections.

- *Changes/updates to the inspection program since the last WMP submission including known future plans (beyond the current year) and new/novel strategies the electrical corporation may implement in the next 5 years (e.g., references to and strategies from pilot projects and research)*

As discussed above, in 2022 SCE began implementation of the single-visit 360 inspection for distribution HFRA detailed inspections. From 2023 to 2025, SCE will continue to execute the single-visit 360 inspections for distribution detailed inspections.¹⁶³

For 2023 and beyond, SCE will utilize a purely risk-based inspections and will inspect more frequently than GO 165 5-year requirement for all structures within HFRA. Over the next five years, SCE will transition to a risk-informed remediation framework for all asset notifications.

A new strategy that SCE is evaluating is the ability to utilize LiDAR specifically for asset inspections. Currently, SCE does not directly collect LiDAR data for the purpose of inspecting T&D distribution lines and equipment. Historically, SCE collected LiDAR data for vegetation management, engineering, and electric asset data needs. To directly mitigate wildfire ignition risk, the vegetation management organization utilizes LiDAR datasets to inspect vegetation grow/fall-in encroachment risks to identify priority notifications. The use of LiDAR for inspecting vegetation encroachment and clearance is

¹⁶³ While the intent of the program is for most inspections to follow these 360 single visit approaches, there may be instances where the ground and aerial inspections cannot be performed on the same visit and must be performed on different visits.

described in Section 8.2.2.4.1.

In 2021, the scope, schedule, and cost of procuring LiDAR data for SCE was consolidated in the centralized inspections organization to ensure that the inspections organizations are aware of LiDAR data collected throughout SCE. Then in 2022, SCE performed a detailed evaluation and competitive procurement to select a LiDAR visualization and analytics software platform to enable the visualization of the collected LiDAR data. This platform will help SCE prepare for advanced analytics capabilities supporting overhead structural T&D inspections via AI/ML analytics at a network scale. In addition, SCE also engaged in the procurement of a diverse array of suppliers that provide end-to-end data LiDAR life cycle capabilities including ground control survey, data collection, data processing (e.g., calibration and feature classification), and data analytics. In 2023, SCE will begin operationalizing the LiDAR visualization and software platform as well as explore the development of T&D LiDAR inspection surveys that can be leveraged by the inspection programs to log and track identified inspection risk and issue notification work orders if necessary.

8.1.3.2 Transmission Detailed Inspections and Remediations (IN-1.2)

Process

In this section, the electrical corporation must provide an overview of the individual asset inspection program, including inspection criteria and the various inspection methods used for each inspection program.

SCE performs detailed inspections of SCE's overhead transmission electric system in compliance with regulatory requirements including GO 165, NERC and WECC rules and regulations, and the CAISO Transmission Control Agreement.

Degradation of transmission equipment and structures as part of wear and tear during normal operations and due to external factors, such as weather or third-party caused damage, increases the probability of in-service malfunction or failure which can have safety and service reliability impacts. CPUC, NERC, WECC and CAISO regulatory requirements as well as SCE's wildfire risk models for HFRA drive the type and frequency of inspections to be performed.

To identify asset conditions that may lead to malfunction or failure, SCE's Transmission Inspection and Maintenance Program (TIMP) performs visual detailed inspections of overhead transmission and sub-transmission assets. For compliance purposes, these inspections are conducted by qualified inspectors every three years. GO 95 provides guidance on overhead electric line construction standards and GO 165 provides guidance on the minimum timing for inspections and maintenance for which SCE is required to comply. However, to identify transmission equipment or structure degradation that occurs between compliance cycles due to natural wear and tear or emergent events such as weather or third party caused damages that could lead to a potential ignition risk, SCE has implemented more frequent and ignition-focused risk inspections on transmission equipment and structures in HFRA ("HFRI inspections").

As with distribution inspections, aerial inspections supplement ground-based inspections. Aerial inspections are typically performed at the same locations as ground inspections and in combination provides a 360-degree view of the assets to detect equipment/structure conditions that are difficult to identify via ground inspections, such as missing cotter keys, which could lead to faults and ignitions (see

Figure SCE 8-24 below). From 2023 to 2025, SCE’s compliance driven structure inspections within HFRA will follow the same type and scope of inspection that SCE uses to perform its transmission HFRI inspections as discussed below, which includes both a ground and an aerial inspection of the structure.

Figure SCE 8-24 - Transmission Missing Cotter Key (Drone Capture)

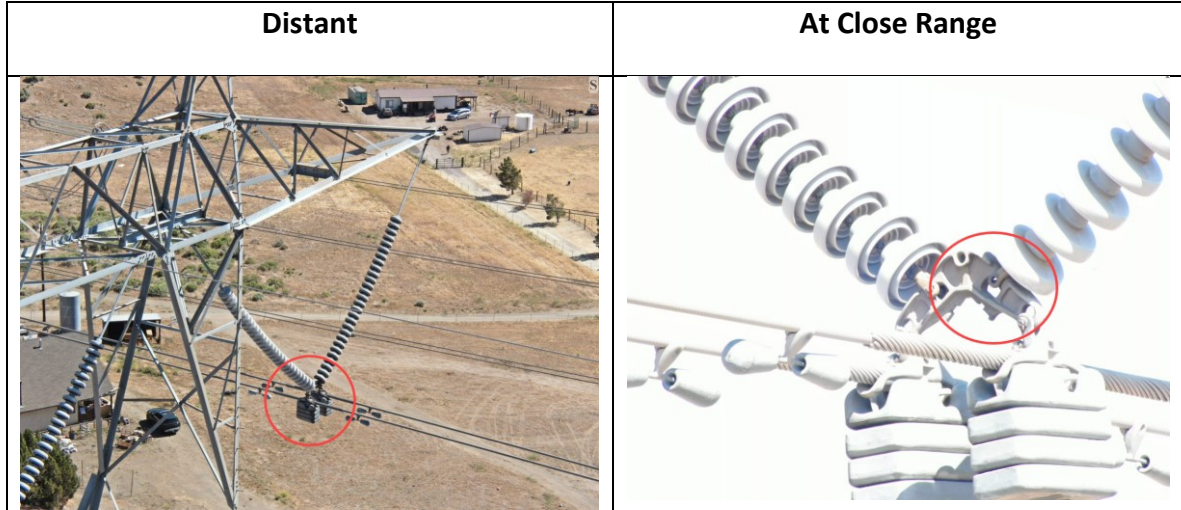

Include relevant visuals and graphics depicting the workflow and decision-making process the electrical corporation uses for the inspection program.

Below in Figure 8-1 b, is a relevant visual that depicts the workflow and decision process regarding transmission detailed inspections.

Figure 8-1 b - Transmission Detailed Inspections Workflow

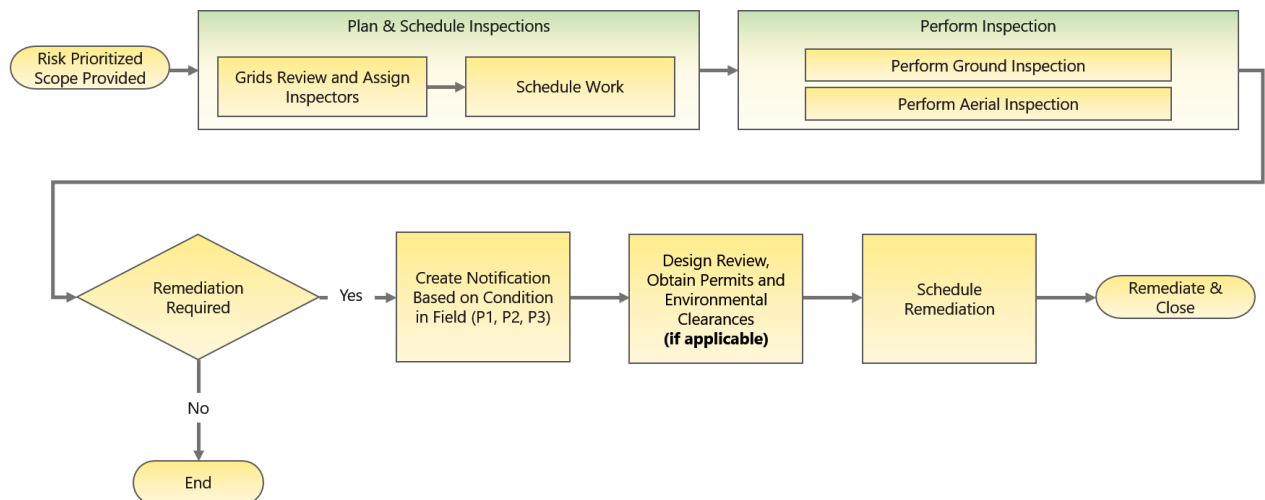

Frequency or Trigger

In this section, the electrical corporation must identify the frequency (including how frequency may differ by HFTD Tier or other risk designation[s]) or triggers used in the inspection program, such as inputs from the risk model.

SCE performs a detailed transmission inspection of its entire service area over the span of three years. As risk levels vary across SCE’s HFRA, a targeted quantitative approach for transmission inspections is being deployed to balance risk reduction, resource availability, and costs. Structures are prioritized for inspection based on POI and consequence. SCE aligned 2023 inspection scope with the IWMS and incorporated the latest risk modeling while taking into account the resource requirements of potential emergent inspections throughout the year. Figure SCE 8-25 summarizes the frequency of Transmission structure inspections based on IWMS risk tranche. Transmission structures in Severe Risk Areas and those structures identified within an AOC will be inspected annually at a minimum and a portion of highest risk structures in the Severe Risk Areas will be inspected twice a year. Additionally, transmission structures in High Consequence Areas will either be inspected annually, or once every three years based on the risk-informed 5x5 Matrix as shown below in Figure SCE 8-25. All remaining lower risk transmission structures in the IWMS Other HFRA category will be inspected once every three years. Where an inspection in HFRA is scheduled to be performed for compliance reasons around the same time as SCE’s risk analysis determines that an HFRI inspection should be performed, these inspection requirements are combined into one inspection. The transmission HFRI inspections and remediations frequency methodology is similar to distribution as described within Section 8.1.3.1 above. Please refer to that section for additional detail.

Figure SCE 8-25 - Visualization of Risk Analysis for Transmission

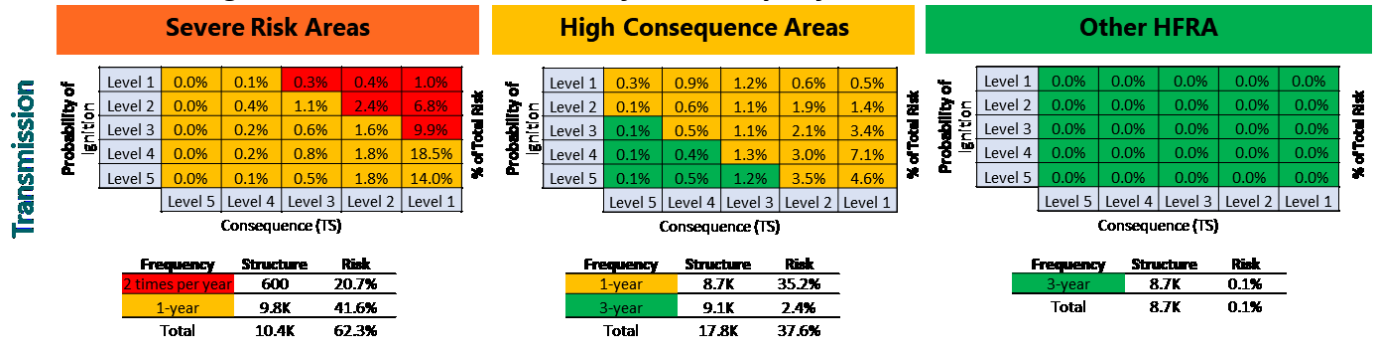

If the inspection program is schedule-based, the electrical corporation must explain how it uses risk prioritization in the scheduling of the inspection program to target high-risk areas. If the electrical corporation does not use risk prioritization in the scheduling of the inspection program, it must explain why.

SCE utilizes a risk-informed strategy as described above to identify inspection scope and then schedules those inspections in HFRA to be performed before the peak of fire season. Additionally, SCE informs its schedule by prioritizing inspections in Summer AOCs areas to be completed for summer readiness and Fall AOCs areas to be completed for fall readiness.

Accomplishments, Roadblocks, and Updates

In this section, the electrical corporation must discuss:

- Noteworthy accomplishments for the inspection program since the last WMP submission

In 2022, SCE completed 17,542 transmission ground inspections and 17,133 transmission aerial inspections which exceeded the target of 16,000 (both ground & aerial). In addition, SCE initiated a more formalized process to incorporate field expertise in the development of the next yearly inspection scope. SCE supplemented the inspection scope informed by the risk models with input from Transmission Senior Patrolman who have field knowledge about asset and location conditions that may not be included in current models. Based on this analysis, SCE expanded the 2023 HFRI inspection annual scope. Field input not only helps us improve risk reduction, but also facilitates risk model validation and enhancements. This is a good example of frontline worker feedback of wildfire risk they see in the field.

- *Roadblocks the electrical corporation has encountered while implementing the inspection program and how the electrical corporation has addressed the roadblocks*

SCE rolled out a new inspection tool in 2022 (InspectForce) for Transmission ground and for Distribution and Transmission aerial inspections. SCE experienced challenges relating to logistics and access to bug fixes and desired enhancements. SCE's Transmission and Distribution execution teams worked very closely with SCE's IT department to prioritize fixes and enhancements and were able to stabilize the tool so that 2022 inspections could be effectively completed. This tool will bring together all core inspection programs into one inspection tool that will integrate into SCE's systems of record.

- *Changes/updates to the inspection program since the last WMP submission including known future plans (beyond the current year) and new/novel strategies the electrical corporation may implement in the next 5 years (e.g., references to and strategies from pilot projects and research)¹⁶⁴*

In 2022, SCE began the new unified 360 approach for distribution inspections, which consisted of performing ground and aerial inspections for structures on the same visit. SCE is evaluating whether to implement a similar approach for transmission inspections in the future. Additionally, please reference Section 8.1.3.1 for the specialized T&D LiDAR program's accomplishments, current state and future plans for transmission.

Another update to our transmission inspection program is that SCE identified five transition span locations that require remediation to reduce ignition risk as part of wire-to-wire contact. Analysis of outage data indicated that transition span clashing accounts for 30% of outage events that were recorded in the "Other" primary driver category. High-risk transition spans, as shown below in

Figure SCE 8 are conductor spans on the transmission system where the conductor changes orientation from a horizontal configuration to a vertical configuration (or vice versa). In addition, transition spans are more susceptible to wire-to-wire contact under certain situations. These situations may include a high wind event or a vehicle-hit-structure where the wire-to-wire contact may create incandescent particles that could spark an ignition. This mitigation activities include

¹⁶⁴ In prior WMPs, SCE included a mitigation initiative (SH-13 – C-Hook Replacements) to proactively identify and remove C-Hooks from SCE's Transmission system and replace with hardware in SCE's current construction standard. SCE completed this proactive replacement program in 2022 and has since sunset the program. SCE maintains a question in its Transmission inspection form regarding the identification of C-Hooks, just to ensure all C-Hooks have been removed from SCE's system. Further, to the extent SCE acquires new transmission lines that contain C-Hooks, SCE intends to remove all C-Hooks prior to energizing those lines.

increasing conductor phase spacing by re-arranging the pole-head configuration, adding inter-set poles to decrease the span length, upgrading pole structures that will accommodate larger phase clearances, and installing line spacers to reduce risks where transition spans are identified. To identify high-risk transition spans, SCE revised the inspection survey form to include a question on the location of transition spans and to then SCE's engineering team will perform additional analysis on those locations.

Figure SCE 8-26 - Example of Transition Span



8.1.3.3 Distribution Patrols Inspections

Process

In this section, the electrical corporation must provide an overview of the individual asset inspection program, including inspection criteria and the various inspection methods used for each inspection program.

SCE performs patrol inspections of SCE's overhead distribution electric system in compliance with GO 165. A patrol inspection is a simple visual inspection that is designed to identify obvious structural problems or hazards. GO 165 requires SCE to perform an annual patrol inspection of all overhead distribution electric assets that are in SCE's HFRA. Annual grid patrols inspections provide SCE an additional opportunity to identify P1 conditions that may have occurred since the last inspection.

Include relevant visuals and graphics depicting the workflow and decision-making process the electrical corporation uses for the inspection program.

Below in Figure 8-1c, is a relevant visual that depicts the workflow and decision process regarding distribution patrol inspections.

Figure 8-1c - Distribution Patrol Inspections Workflow

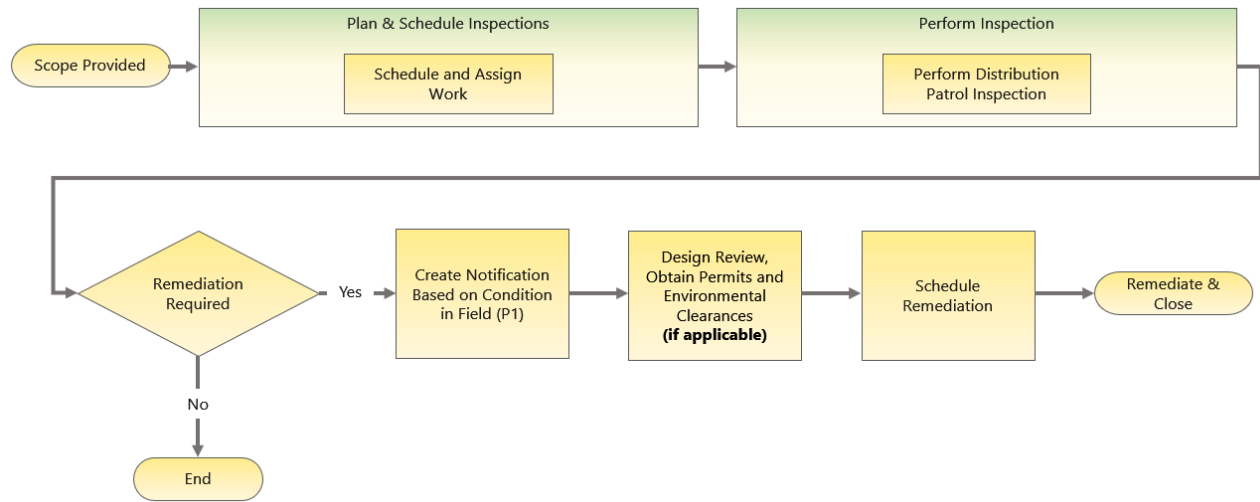

Frequency or Trigger

In this section, the electrical corporation must identify the frequency (including how frequency may differ by HFTD Tier or other risk designation[s]) or triggers used in the inspection program, such as inputs from the risk model.

Annual Patrols are performed on all above ground structures, overhead conductors and equipment, as well as entryways to subsurface enclosures and vaults throughout SCE’s service area. Additionally, in 2021 SCE introduced the concept of a Fall AOCs pre-patrol as a component of the AOCs effort to prepare for peak fire season. The Fall AOCs pre-patrol consists of a vehicle-based (where possible) patrol which looked for P1 conditions, mid-span clearance conditions (e.g., vegetation in lines or potential wire slap) and Communication Infrastructure Provider (CIP)/third party hazardous conditions.

If the inspection program is schedule-based, the electrical corporation must explain how it uses risk prioritization in the scheduling of the inspection program to target high-risk areas. If the electrical corporation does not use risk prioritization in the scheduling of the inspection program, it must explain why.

SCE schedules its annual grid patrols in HFRA to be completed in the first half of the year in order to be performed prior to the summer months. SCE’s Fall AOCs pre-patrols are scheduled to be completed prior to peak fire season.

Accomplishments, Roadblocks, and Updates

In this section, the electrical corporation must discuss:

- *Noteworthy accomplishments for the inspection program since the last WMP submission*

SCE completed patrol inspections of all distribution grids (which includes HFRA), and associated structures, in 2022.

- *Roadblocks the electrical corporation has encountered while implementing the inspection program and how the electrical corporation has addressed the roadblocks*

SCE encountered access issues with certain distribution assets performing this inspection program in 2022. To mitigate, SCE utilized helicopters to perform the inspections aerially.

- *Changes/updates to the inspection program since the last WMP submission including known future plans (beyond the current year) and new/novel strategies the electrical corporation may implement in the next 5 years (e.g., references to and strategies from pilot projects and research)*

Since 2022, SCE engaged contractors to perform all grid patrol inspections to free up capacity for inspectors to focus on detailed inspections. There are no current plans for additional changes or improvements going forward; however, SCE will continue to evaluate the methods and data collections tools to improve the efficiency and risk mitigation opportunities of patrol inspections.

8.1.3.4 Transmission Patrols Inspections

Process

In this section, the electrical corporation must provide an overview of the individual asset inspection program, including inspection criteria and the various inspection methods used for each inspection program.

This program is part of SCE's portfolio of inspection activities. SCE performs patrol inspections of SCE's overhead transmission electric system in compliance with GO 165, NERC, WECC rules and regulations and CAISO's Transmission Control Agreement. A patrol inspection is a simple visual inspection that is designed to identify obvious structural problems or hazards associated to the structure.

Include relevant visuals and graphics depicting the workflow and decision-making process the electrical corporation uses for the inspection program.

Below in Figure 8-1d is a relevant visual that depicts the workflow and decision process regarding transmission patrol inspections.

Figure 8-1d - Transmission Patrol Inspections Workflow

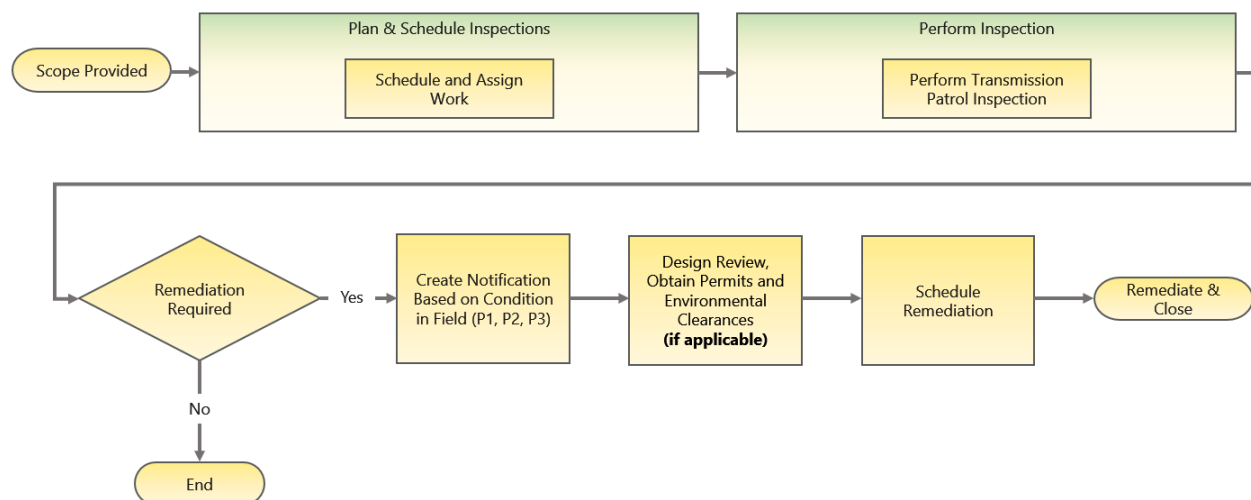

Frequency or Trigger

In this section, the electrical corporation must identify the frequency (including how frequency may differ by HFTD Tier or other risk designation[s]) or triggers used in the inspection program, such as inputs from the risk model.

SCE performs routine patrol inspections of all circuits in SCE’s service area annually and performs detailed patrol inspections every three years. Patrols are visual inspections and are done inside and outside of SCE’s HFRA. The more detailed HFRI inspections are often done at the same time as patrols, with structures in that scope getting a more comprehensive inspection than the patrol provides. Additionally, in 2021 SCE introduced the concept of a Fall AOCs pre-patrol to prepare for peak fire season. The Fall AOCs pre-patrol consists of a vehicle-based (where possible) patrol which looked for P1 conditions.

If the inspection program is schedule-based, the electrical corporation must explain how it uses risk prioritization in the scheduling of the inspection program to target high-risk areas. If the electrical corporation does not use risk prioritization in the scheduling of the inspection program, it must explain why.

SCE aligns its patrol schedules based on compliance dates and optimizes scheduling where possible with transmission HFRA detailed inspections when the scope of the two programs overlap. Additionally, the Fall AOCs pre-patrols are scheduled to be completed prior to peak fire season.

Accomplishments, Roadblocks, and Updates

In this section, the electrical corporation must discuss:

- *Noteworthy accomplishments for the inspection program since the last WMP submission*

SCE completed patrol inspections of all transmission and sub-transmission circuits (which includes HFRA), and associated structures, in 2022.

- *Roadblocks the electrical corporation has encountered while implementing the inspection program and how the electrical corporation has addressed the roadblocks*

SCE did not experience any roadblocks when implementing this inspection program in 2022.

- *Changes/updates to the inspection program since the last WMP submission including known future plans (beyond the current year) and new/novel strategies the electrical corporation may implement in the next 5 years (e.g., references to and strategies from pilot projects and research)*

Changes to the program scope or approach are not planned at this time. SCE plans to perform patrol inspections each year from 2023 to 2025 in alignment with previous years and in accordance with regulatory requirements.

8.1.3.5 Distribution Infrared (IR) Inspections (IN-3)

Process

In this section, the electrical corporation must provide an overview of the individual asset inspection program, including inspection criteria and the various inspection methods used for each inspection program.

SCE evaluated the need for infrared (IR) inspections on its distribution circuits and found that these inspections offer a substantial benefit beyond standard visual inspections. SCE had benchmarked methods to evaluate distribution overhead lines and learned that using IR technology to detect thermal differences and identify hot splices and connectors can be leading indicators of asset failure. SCE piloted IR inspections of energized distribution lines and equipment in 2017 and 2018 to help reduce the risk of conductor failure. Following the pilot, SCE deemed it prudent to inspect all distribution facilities in HFRA over a two-year cycle using IR technology.

The IR scan can detect temperature differences between components and identify heat signatures of components called “hot spots,” that may indicate deterioration in structures and equipment not visible to the naked eye. Most inspections have been performed from ground vehicles; however, a small percentage of the inspections require the inspector to hike to the structure or perform the inspection from a helicopter.

IR inspections can detect conditions that may indicate a wide range of anomalies, including, but not limited to, failing switch and fuse contacts, poor connections, loose bushings, overloaded/failing transformers, and other issues that can result in component failure. These conditions are often not visible to the human eye and can go undetected during detailed visual inspections as shown below in Figure SCE 8-27.

Figure SCE 8-27 - Distribution Infrared (IR) Inspection of a 16kV Circuit

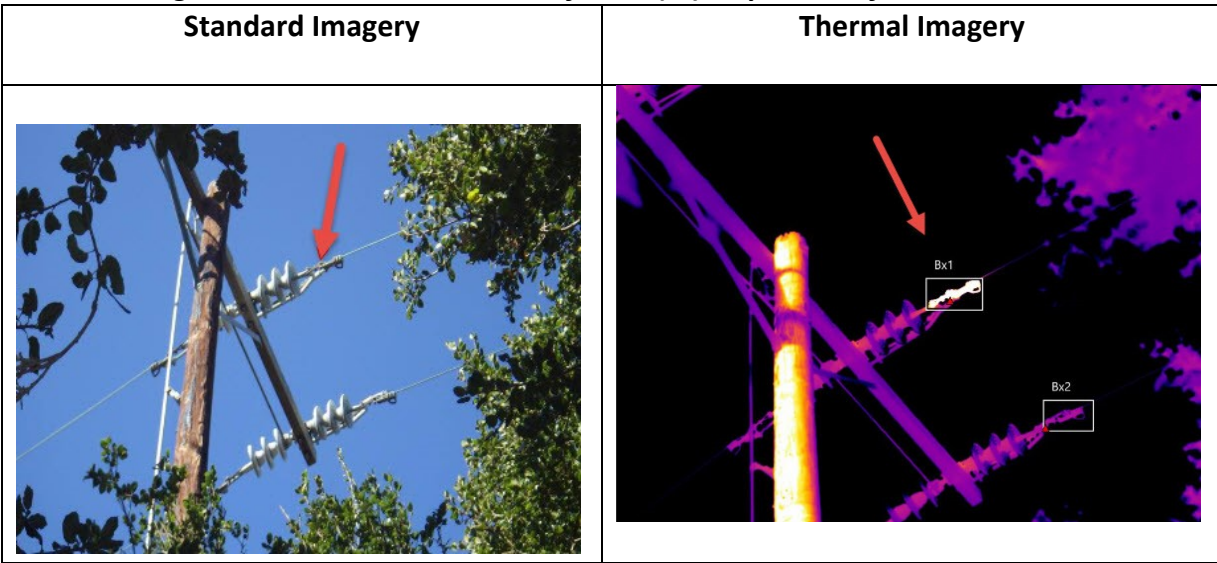

Include relevant visuals and graphics depicting the workflow and decision-making process the electrical corporation uses for the inspection program.

Below in, is a relevant visual that depicts the workflow and decision process regarding distribution infrared (IR) inspections.

Figure 8-1e - Transmission Patrol Inspections Workflow

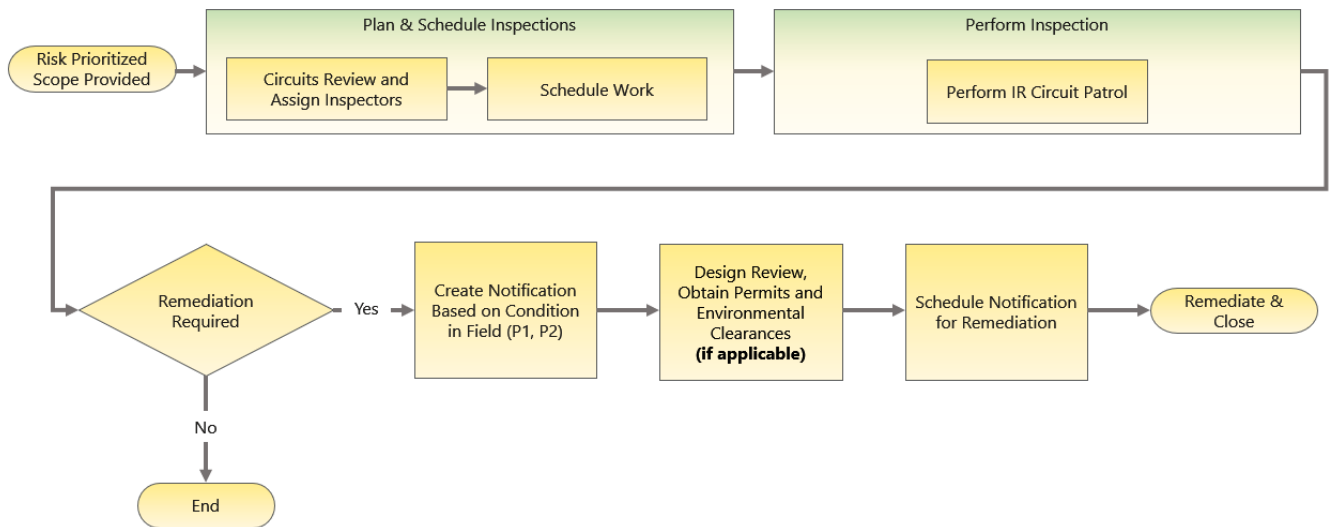

Frequency or Trigger

In this section, the electrical corporation must identify the frequency (including how frequency may differ by HFTD Tier or other risk designation[s]) or triggers used in the inspection program, such as inputs from the risk model.

SCE will continue to perform IR scans on overhead distribution equipment throughout SCE's territory within HFRA from 2023 through 2025. Circuits within Tier 3 (extreme fire threat) and Tier 2 (elevated fire threat) are grouped by district and then prioritized by relative risk. Risk for each district is calculated by multiplying the POI by the Technosylva consequence, and then aggregating the risk scores of each structure in the district. District risk scores are ranked highest to lowest and are then scheduled accordingly. Since 2023 is the first year of the two-year cycle, SCE also incorporated IWMS in the prioritization analysis. The districts selected to be inspected annually were not only the highest risk, but also had large portions of their circuits that were within High Consequence Areas and Severe Risk Areas. From 2023 to 2025, following this methodology, SCE plans to inspect a total of approximately 5,300 distribution circuit miles annually within HFRA; the circuits in the highest risk districts will be inspected annually and the remaining circuits every other year.

If the inspection program is schedule-based, the electrical corporation must explain how it uses risk prioritization in the scheduling of the inspection program to target high-risk areas. If the electrical corporation does not use risk prioritization in the scheduling of the inspection program, it must explain why.

SCE inspects the highest risk districts annually with the remaining scope approximately being split evenly and inspected every two years. The inspections are optimized and scheduled around the summer months to best recognize peak loading and temperatures of SCE's equipment.

Accomplishments, Roadblocks, and Updates

In this section, the electrical corporation must discuss:

- *Noteworthy accomplishments for the inspection program since the last WMP submission*

For 2022, the second year of the two-year cycle, SCE inspected the remaining overhead distribution circuit miles in HFRA which included 4,408 miles.

- *Roadblocks the electrical corporation has encountered while implementing the inspection program and how the electrical corporation has addressed the roadblocks*

SCE encountered issues relating to truck access (e.g., rural areas, secured areas, etc.) which were circumvented by performing the inspections from a helicopter. In addition, due to seasonal constraints (e.g., inclement weather) some inspections were re-scheduled to a different period of the year.

- *Changes/updates to the inspection program since the last WMP submission including known future plans (beyond the current year) and new/novel strategies the electrical corporation may implement in the next 5 years (e.g., references to and strategies from pilot projects and research)*

Since SCE's 2022 WMP Update, changes have included optimizing the program schedule to balance risk coverage across each year while distributing mileage equivalently across both years. Additionally, in 2023, SCE will plan and schedule the distribution infrared inspections, where operationally efficient, to be conducted May through September to take advantage of expected higher loading during those months which could result in better conditions to identify hot spots.

8.1.3.6 Transmission Infrared (IR) and Corona Scan Inspections (IN-4)

Process

In this section, the electrical corporation must provide an overview of the individual asset inspection program, including inspection criteria and the various inspection methods used for each inspection program.

In the first quarter of 2019, SCE launched the Transmission IR & Corona Scanning program. Specialized infrared and ultraviolet (Corona) light cameras are mounted to helicopters, which inspect the line, with special attention paid to splices, conductor connection/attachment points, and insulators. SCE utilizes internal resources to conduct all aspects of the IR and Corona inspections.

Similar to the distribution infrared inspection protocol, the IR scan detects temperature differences and heat signatures of components, which may indicate problems that could result in component/conductor failure. Corona scanning is a technology that is only being used on transmission circuits in HFRA as certain anomalies (e.g., insulator failures) are not as common on distribution circuits.

Corona detection is accomplished by identifying ultraviolet energy, which is generated by electric discharge or “leakage” due to the ionization of air surrounding high voltage electric components. In some cases, the “leakage” is substantial enough that it may result in an arc flash and potential ignition. The Corona image identifies a conductor that has broken strands by showing the ultraviolet energy that is generated by electric discharge. It is very difficult to identify this type of issue with conventional photographs. Figure SCE 8-28 below shows an example of a defect that was captured by a Corona scan that could not be detected during a visual or IR inspection. Helicopters (see Figure SCE 8-29 below) are used for these inspections due to the long distances between structures and because these assets are frequently located on rugged terrain.

Figure SCE 8-28 - Midway-Vincent No 1 & No 2 500kV Lines

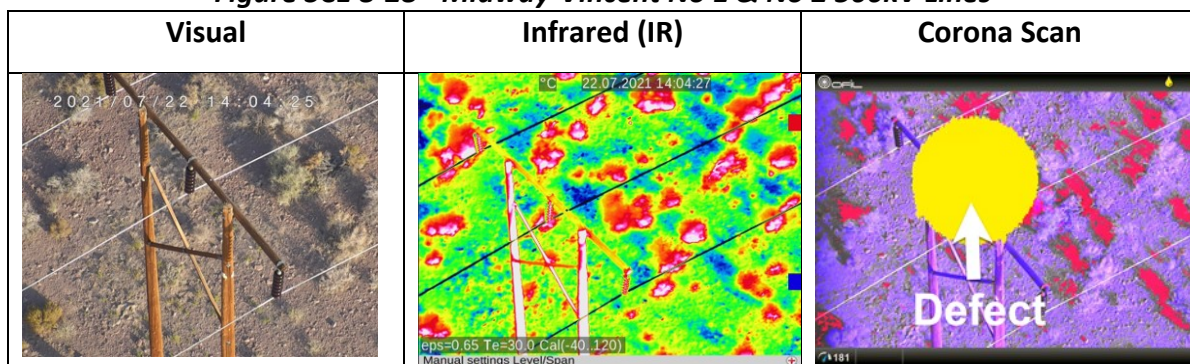
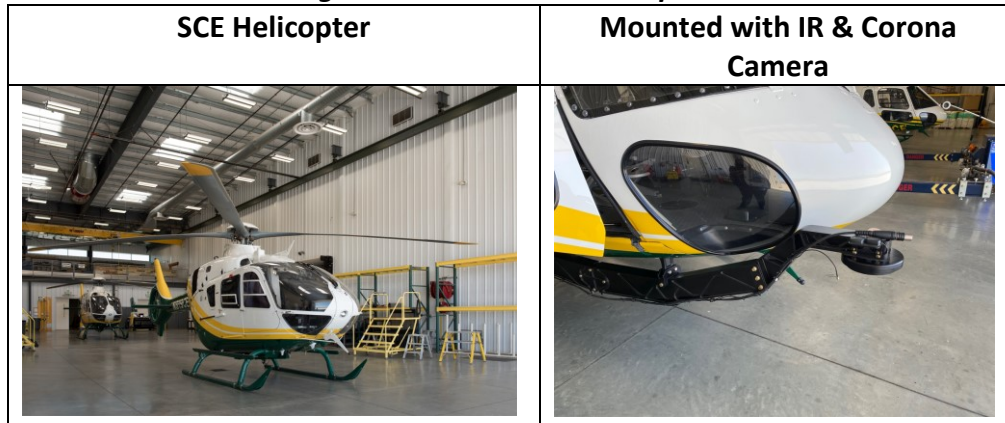

Figure SCE 8-29 - SCE Helicopters



Include relevant visuals and graphics depicting the workflow and decision-making process the electrical corporation uses for the inspection program. (see the example in Figure 8-1f).

Below in Figure 8-1f, is a relevant visual that depicts the workflow and decision process regarding transmission infrared (IR) and Corona scan inspections.

Figure 8-1f - Transmission Infrared (IR) and Corona Scan Inspections Workflow

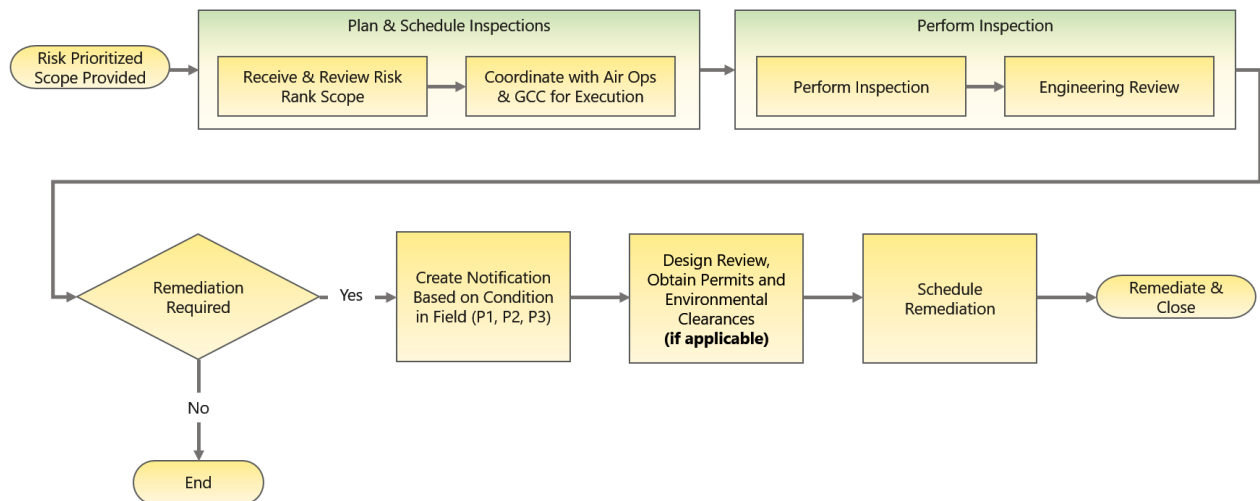

Frequency or Trigger

In this section, the electrical corporation must identify the frequency (including how frequency may differ by HFTD Tier or other risk designation[s]) or triggers used in the inspection program, such as inputs from the risk model.

The Transmission IR & Corona Scanning program uses a risk prioritized method with consideration given to HFRA circuit miles and circuits completed in the previous year. The circuits are risk assessed by their probability of ignition and consequence levels and then prioritized by their calculated risk score. The circuits inspected in the previous year are removed from the priority list unless identified as one of the highest risk circuits utilizing POI and Technosylva.

Finally, the scope is chosen by identifying the remaining circuits that should be inspected to inspect approximately 1,000 HFRA circuit miles annually with this program. 1,000 annual miles allows SCE to inspect all transmission circuit miles roughly every five years while also targeting higher risk circuits more frequently.

If the inspection program is schedule-based, the electrical corporation must explain how it uses risk prioritization in the scheduling of the inspection program to target high-risk areas. If the electrical corporation does not use risk prioritization in the scheduling of the inspection program, it must explain why.

SCE inspects the highest risk circuits annually with the remaining scope on a five-year review cadence which distributes the risk proportionally each year. The work is executed in an operationally efficient manner, taking into account weather conditions, circuit loading, outages and the proximity of other circuits.

Accomplishments, Roadblocks, and Updates

In this section, the electrical corporation must discuss:

- *Noteworthy accomplishments for the inspection program since the last WMP submission*

In 2022, SCE exceeded its WMP target of completing 1,000 circuit miles by completing 1,075 miles.

- *Roadblocks the electrical corporation has encountered while implementing the inspection program and how the electrical corporation has addressed the roadblocks*

SCE did not experience any roadblocks in implementing this inspection program in 2022.

- *Changes/updates to the inspection program since the last WMP submission including known future plans (beyond the current year) and new/novel strategies the electrical corporation may implement in the next 5 years (e.g., references to and strategies from pilot projects and research)*

Since SCE's 2022 WMP Update, there have been no changes to this inspection program. SCE will continue to evaluate the results of this program to determine appropriate scope and methods for this activity going forward. Starting in 2023, SCE will investigate the most ideal way to align the Transmission Infrared risk methodology with IWMS.

8.1.3.7 Generation Inspections (IN-5)

Process

In this section, the electrical corporation must provide an overview of the individual asset inspection program, including inspection criteria and the various inspection methods used for each inspection program.

In 2019, SCE began performing wildfire inspections on all electrical lines to align with the EOI/HFRI initiative that began in late 2018 for transmission & distribution, equipment, and overhead wiring associated with generation infrastructure, including secondary and control lines feeding ancillary generation assets in HFRA. These inspections included ignition-focused assessments of low-voltage ancillary assets and their associated overhead lines, supporting structures, and any exposed wiring and/or threats from vegetation that require additional mitigation. In 2020 and 2021, SCE continued to inspect generation-related assets and worked towards integrating wildfire related inspections into existing routine equipment and operations inspections to streamline field efforts.

From 2023 to 2025, SCE is continuing its inspection program of relevant generation-related assets in HFRA, including powerhouses, substations, and low-voltage ancillary assets to identify needed remediations to reduce the risk of wildfire ignition. SCE’s generation facilities in HFRA are often located in or near heavily forested areas; ignitions related to these facilities could lead to substantial wildfire risk. Once asset deterioration or other corrective actions are identified during inspections, remediations of these conditions are intended to reduce the probability of faults and potential ignitions.

Include relevant visuals and graphics depicting the workflow and decision-making process the electrical corporation uses for the inspection program. (see the example in Figure 8-1g).

Below in Figure 8-1g is a relevant visual that depicts the workflow and decision process regarding generation inspections.

Figure 8-1g - Generation Inspections Workflow

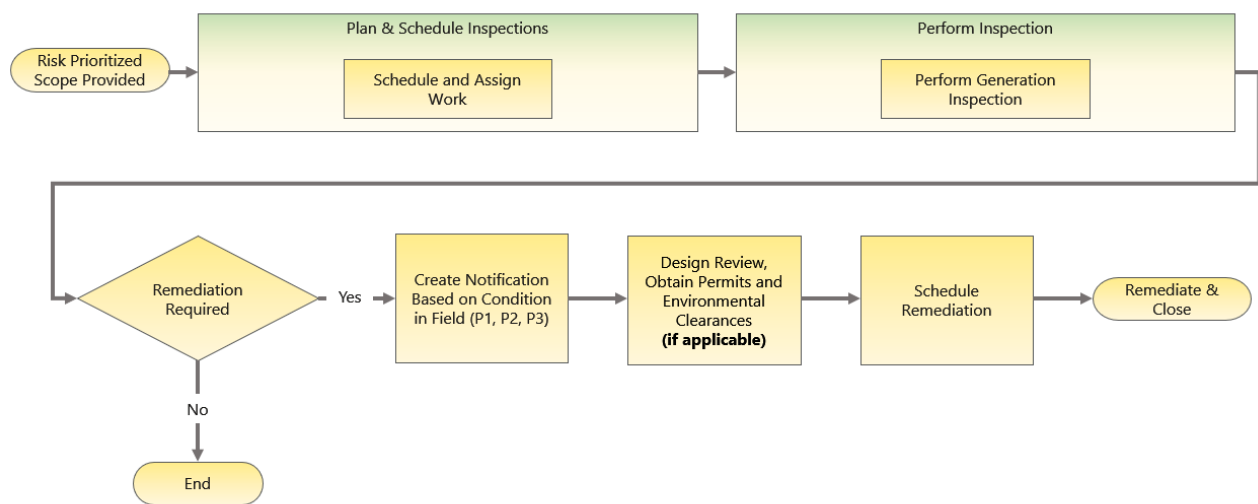

Frequency or Trigger

In this section, the electrical corporation must identify the frequency (including how frequency may differ by HFTD Tier or other risk designation[s]) or triggers used in the inspection program, such as inputs from the risk model.

The frequency of generation HFRI inspections is based on each asset's calculated risk, based on POI and Technosylva consequence. SCE inspects 75% of the risk associated with these generation facilities on an annual cadence. The remaining 25% is lower risk and is divided equally over a two-year cycle. This allows SCE to inspect approximately 88% of the risk associated with these facilities on a yearly basis.

Generation HFRI inspections are performed on a two-year cycle utilizing the same risk methodology each year and which allows SCE to inspect every generation asset during the cycle. In 2022, SCE began the first year of the two-year cycle. In 2023, SCE will continue with the second year of the two-year cycle.

If the inspection program is schedule-based, the electrical corporation must explain how it uses risk prioritization in the scheduling of the inspection program to target high-risk areas. If the electrical corporation does not use risk prioritization in the scheduling of the inspection program, it must explain why.

Generation inspections are scheduled to be executed in an operationally efficient manner, which considers weather conditions and geographical location and are completed before peak fire season.

Accomplishments, Roadblocks, and Updates

In this section, the electrical corporation must discuss:

- *Noteworthy accomplishments for the inspection program since the last WMP submission*

SCE exceeded its 2022 WMP target of inspecting 190 assets by completing 222 asset inspections.

- *Roadblocks the electrical corporation has encountered while implementing the inspection program and how the electrical corporation has addressed the roadblocks*

SCE encountered some inclement weather while implementing the inspection program in 2022; however, SCE was able to overcome this roadblock by rescheduling the affected inspections to different periods of the year when weather was more favorable.

- *Changes/updates to the inspection program since the last WMP submission including known future plans (beyond the current year) and new/novel strategies the electrical corporation may implement in the next 5 years (e.g., references to and strategies from pilot projects and research)*

Starting in 2024, SCE will investigate the most ideal way to align the generation risk methodology with IWMS. In addition, SCE will continue to monitor the asset inspections performed as well as the notifications found and should any trends or opportunities for improvement be identified, will seek to implement those as quickly as possible.

8.1.3.8 Transmission Conductor and Splice Assessment (IN-9)

Process

In this section, the electrical corporation must provide an overview of the individual asset inspection program, including inspection criteria and the various inspection methods used for each inspection program.

SCE is continuing its transmission conductor and splice assessment methods (LineVue and X-Ray) in HFRA to complement existing inspection processes. SCE identified 87 transmission wire down events that occurred from 2015 to 2022¹⁶⁵ throughout the SCE service territory, with most failures attributed to conductors and splices.¹⁶⁶ Conductors and splices can fail due to age, weather, contact from object, and other factors that can lead to wires down. To reduce transmission conductor wire down events, SCE is using transmission conductor and splice assessment methods to identify anomalies and any underlying issues in order to replace or remediate conductors and/or splices that have a higher probability of failure. In addition, these methods help capture issues that may not be visibly apparent to the human eye or other inspection technologies. To the extent possible, SCE will coordinate LineVue and X-Ray on the same outage.

LineVue and X-Ray, as shown below in Figure SCE 8-30, were chosen for their enhanced inspection methods of finding anomalies which are not apparent or visibly exposed.

Figure SCE 8-30 - Transmission Conductor and Splice Assessment

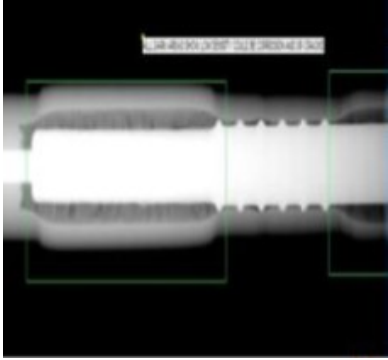
LineVue	X-Ray
 <p data-bbox="310 1488 786 1598">Utilizes a magnetic flux to detect the degradation of the steel core of the conductor.</p>	 <p data-bbox="829 1488 1305 1635">Takes an internal image of the splice, which is used to determine degradation due to corrosion/improper installation.</p>

LineVue determines the deterioration of the cross-sectional area of the conductor steel core and detects any localized breaks or corrosion pits on the steel wires and loss of zinc galvanized layer. LineVue inspections are more effective than visual inspections in identifying these issues given the difficulty in seeing internal issues. *Figure SCE 8-31* below shows an example of a LineVue inspection being

¹⁶⁵ 2022 will be an historical year when SCE files the WMP in 2023.

¹⁶⁶ A wire down event is considered a risk to the public due to being on the ground or within eight feet of the ground.

performed on a transmission line.

Figure SCE 8-31 - LineVue Inspection

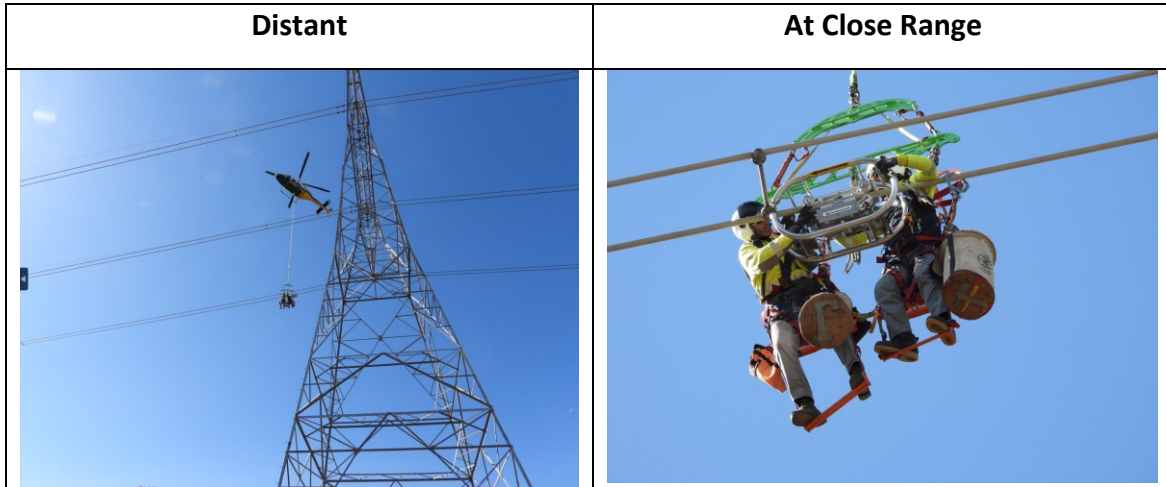

X-Ray is used on conductor splices to verify proper installation as well as identify broken strands or deformities. X-Ray inspections are more effective than visual inspections in identifying these issues given the difficulty in seeing internal issues or improper termination installations.

Figure SCE 8-32 below shows an example of an x-ray inspection being performed on a transmission line. In addition, Figure SCE 8-33 below shows an example of an anomaly identified during an x-ray inspection that otherwise could not be captured visually.

Figure SCE 8-32 - X-Ray Inspection

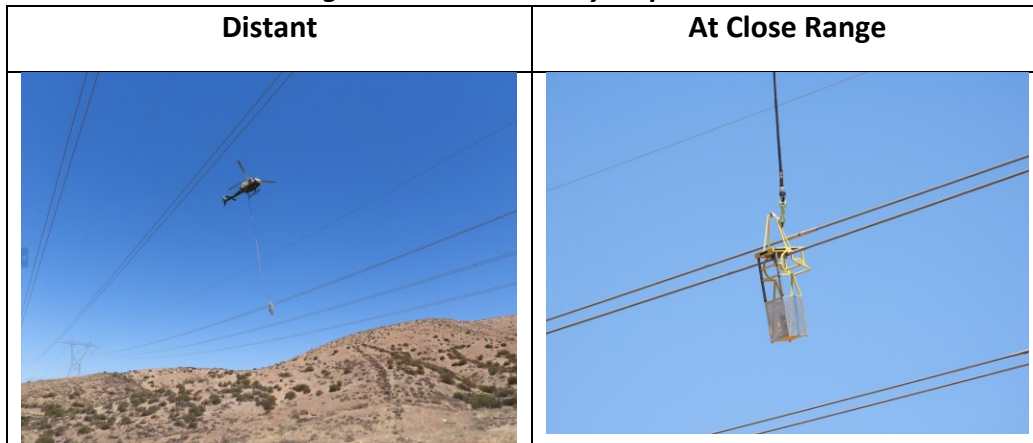
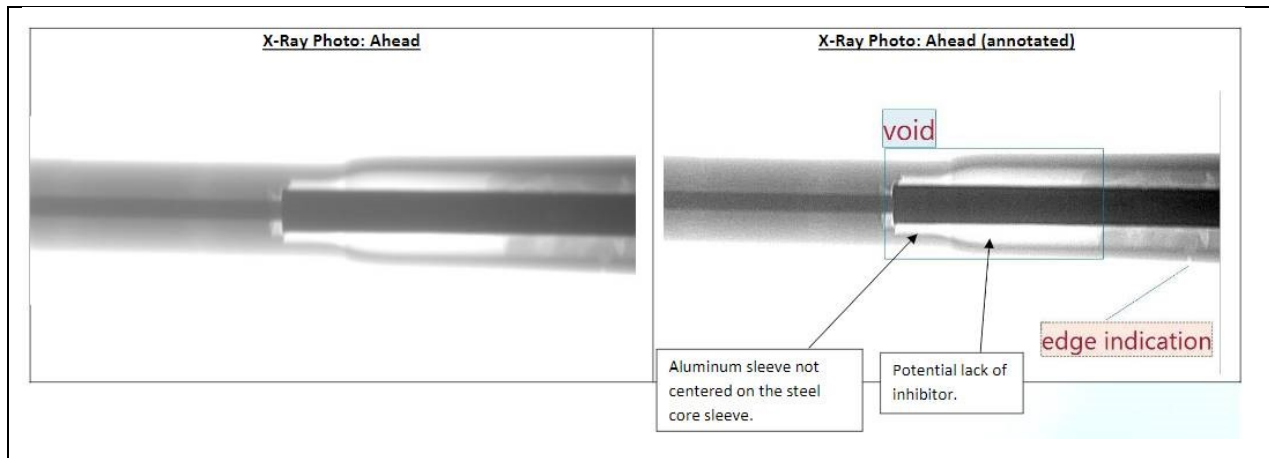

Figure SCE 8-33 - Anomaly Identified During X-Ray Inspection



Include relevant visuals and graphics depicting the workflow and decision-making process the electrical corporation uses for the inspection program.

Below in Figure 8-1h is a relevant visual that depicts the workflow and decision process regarding transmission conductor and splice assessment.

Figure 8-1h - Transmission Conductor and Splice Assessment Workflow

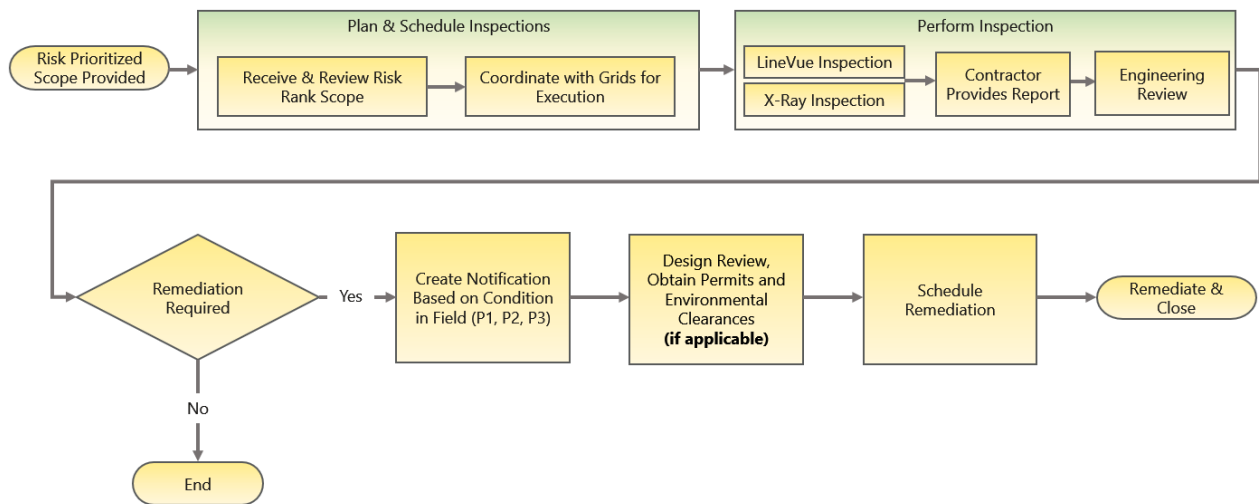

Frequency or Trigger

In this section, the electrical corporation must identify the frequency (including how frequency may differ by HFTD Tier or other risk designation[s]) or triggers used in the inspection program, such as inputs from the risk model.

As outlined below in Figure SCE 8-34, SCE developed a risk methodology to evaluate risk across

transmission structures to help prioritize transmission inspections. This methodology utilizes various data elements, including structure age and location, circuit loading, splice count, conductor type, outage data, and repair notifications. SCE then incorporated Technosylva consequence impacts and an environmental multiplier composed of atmospheric corrosivity and historical fire maps to calculate and rank risk across assets.

In 2023, inspections will be prioritized in the order of the risk ranking by structures, followed by a desktop analysis to determine whether LineVue or X-Ray should be utilized. For example, X-Ray is only performed on splices. Coordination is then needed with SCE’s Air Operations team to determine availability of helicopters to perform LineVue and/or X-Rays as well as outage availability. Finally, a field inspection is performed with either LineVue or X-Ray to identify if any anomalies or underlying issues are present. While locations for LineVue and X-Ray are selected based on risk analysis, consideration is also given to operational feasibility and locations that offer specific learnings.

Figure SCE 8-34 - Transmission Conductor and Splice Prioritization

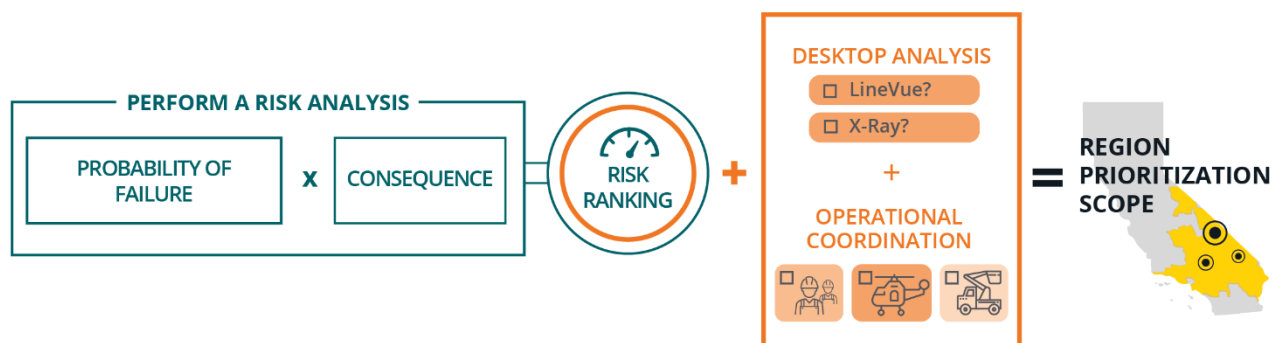

If the inspection program is schedule-based, the electrical corporation must explain how it uses risk prioritization in the scheduling of the inspection program to target high-risk areas. If the electrical corporation does not use risk prioritization in the scheduling of the inspection program, it must explain why.

As described above, the transmission conductor and splice assessment program utilize risk prioritization to identify its scope. SCE prioritizes mitigations and to the extent possible leverages work bundling on existing planned outages to minimize the potential reliability and customer impacts.

Accomplishments, Roadblocks, and Updates

In this section, the electrical corporation must discuss:

- *Noteworthy accomplishments for the inspection program since the last WMP submission*

In 2022, SCE inspected 79 spans with LineVue, 63 splices with x-ray and obtained six conductor samples which exceeded the targets of 75 spans, 50 splices and 5 conductor samples respectively.

- *Roadblocks the electrical corporation has encountered while implementing the inspection program and how the electrical corporation has addressed the roadblocks*

The LineVue and x-ray inspection methods can technically be performed while the transmission line is either energized or de-energized; however, due to safety and qualification requirements (e.g., helicopter and crew training), SCE chose to schedule most of the inspections while de-energized. To mitigate this challenge, SCE is looking to obtain additional training and equipment to perform these inspections while energized safely.

- *Changes/updates to the inspection program since the last WMP submission including known future plans (beyond the current year) and new/novel strategies the electrical corporation may implement in the next 5 years (e.g., references to and strategies from pilot projects and research)*

Since the 2022 WMP update, SCE is no longer obtaining conductor samples due not being able to obtain viable samples within the field without potentially adding risk into the system. In addition, as a result of the 63 splices x-rayed four P1s, 20 P2s and 10 P3s were identified. The high find rate of P1s, P2s and P3s compared to the number of x-rays conducted validated the continuation of this inspection program into 2023. SCE will continue to monitor the find rate and should it continue to remain high, more proactive mitigations will be considered in the future. Starting in 2023, SCE will investigate the most ideal way to align the transmission conductor & splice assessment risk methodology with IWMS.

8.1.3.9 Intrusive Pole Inspections

Process

In this section, the electrical corporation must provide an overview of the individual asset inspection program, including inspection criteria and the various inspection methods used for each inspection program.

SCE performs intrusive pole inspections (IPI) in compliance with GO 165. The strength of wood poles can diminish over time due to insect infestation or material deterioration, increasing the probability of structure failure, which is a safety hazard given the electrical equipment supported by the poles and proximity of these poles to the public.

The IPI program is a preventative program designed to identify deteriorated poles within HFRA and non-HFRA that may require remediation to meet with GO 95 requirements, while maintaining the safety of personnel, public, and environment. The IPI program was established in accordance with GO 165 to evaluate SCE's wood poles using visual and internal examination of the poles (by drilling into the pole and testing the extracted wood) to identify damage or decay, analyze the remaining strength of the pole, and determine if remediation is required. As an industry practice approved by the Commission, the program performs remedial treatments during intrusive inspections to prevent poles from deteriorating and to extend the useful lives of the poles.

Include relevant visuals and graphics depicting the workflow and decision-making process the electrical corporation uses for the inspection program.

Below in Figure 8-1i, is a relevant visual that depicts the workflow and decision process regarding intrusive pole inspections.

Figure 8-1i - Intrusive Pole Inspections Workflow

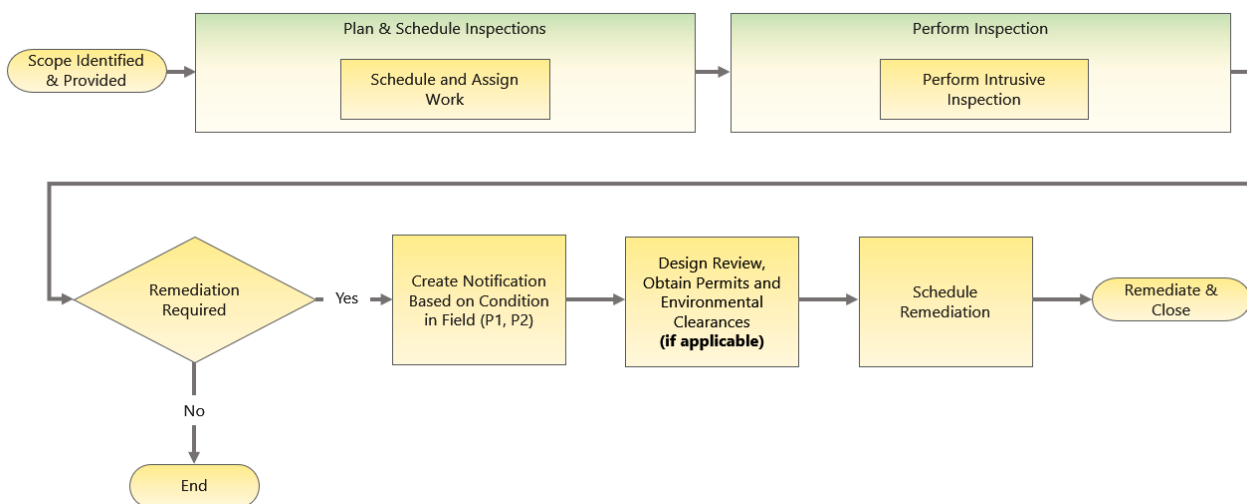

Frequency or Trigger

In this section, the electrical corporation must identify the frequency (including how frequency may differ by HFTD Tier or other risk designation[s]) or triggers used in the inspection program, such as inputs from the risk model.

SCE utilizes a 10-year inspection cycle using a grid-based approach to maintain operational and resource allocation efficiencies and is in line with industry practices and benchmarking. This inspection cadence is more frequent than what is generally required in GO 165. Small portions of annual work are prioritized to address constrained poles that SCE was unable to inspect previously for various reasons (e.g., unable to access and/or obstructions). Additionally, GO 95 Rule 44.2 informs ad hoc inspections that are performed through the IPI program annually.¹⁶⁷

If the inspection program is schedule-based, the electrical corporation must explain how it uses risk prioritization in the scheduling of the inspection program to target high-risk areas. If the electrical corporation does not use risk prioritization in the scheduling of the inspection program, it must explain why.

SCE utilizes a 10-year grid approach to maintain operational and resource allocation efficiencies and compliance throughout the system. Small portions of annual work are prioritized to address constrained poles unable to be inspected previously for various reasons (e.g., unable to access and/or obstructions). By aligning with a 10-year cycle, SCE is able to help ensure that decay rates do not increase for local

¹⁶⁷ Rule 44.2 of GO 95 mandates that pole loads calculated in anticipation of additional construction incorporate the results of an intrusive inspection completed within the previous 5 years for wood poles older than 15 years.

conditions.

Accomplishments, Roadblocks, and Updates

In this section, the electrical corporation must discuss:

- *Noteworthy accomplishments for the inspection program since the last WMP submission*

SCE's find rate for the IPI program is decreasing due to the preventative maintenance program which identifies deteriorated poles prior to failure and speaks to the health of poles throughout SCE's service territory.

- *Roadblocks the electrical corporation has encountered while implementing the inspection program and how the electrical corporation has addressed the roadblocks*

In 2022, SCE experienced roadblocks, such as access issues and obstruction at the base of the pole within HFRA. In order to address this, SCE worked through customer notifications, appointments, and removal of customer-built obstructions and will continue to work through any outstanding obstacles to obtain the inspection results.

- *Changes/updates to the inspection program since the last WMP submission including known future plans (beyond the current year) and new/novel strategies the electrical corporation may implement in the next 5 years (e.g., references to and strategies from pilot projects and research)*

In 2023, SCE will continue evaluating performance and scope identifications of the IPI program through ongoing asset performance and risk prioritization analysis. This includes investigating historical data concerning poles that are selected for remediation and identifying reasons for failure. This will help SCE ensure that it is installing the right pole type in the grid, and reducing foreseeable failure (e.g., replacing wood with non-wood poles where damage is caused by woodpecker activity).

8.1.3.10 Substation Inspections

Process

In this section, the electrical corporation must provide an overview of the individual asset inspection program, including inspection criteria and the various inspection methods used for each inspection program.

In 2020, SCE performed a study to help identify potential sources of ignition from major substation assets and develop recommendations for substation equipment inspections and maintenance. This study concluded in 2020 and recommended three actions in the inspection space: continue the installation of Circuit Breaker Online Monitoring (CBOLM), prioritize inspections of oil-filled CBs in HFRA substations through the Oil Circuit Breaker Analysis (OCBA) program, and increase Predictive Maintenance Assessment (PMA) inspections on approximately 40 HFRA substations identified in the Failure Mode & Effects Analysis (FMEA). In 2021, SCE developed plans to perform this work, and began executing that year.

Include relevant visuals and graphics depicting the workflow and decision-making process the electrical corporation uses for the inspection program.

Below in Figure 8-1j, is a relevant visual that depicts the workflow and decision process regarding substation inspections.

Figure 8-1j - Substation Inspections Workflow

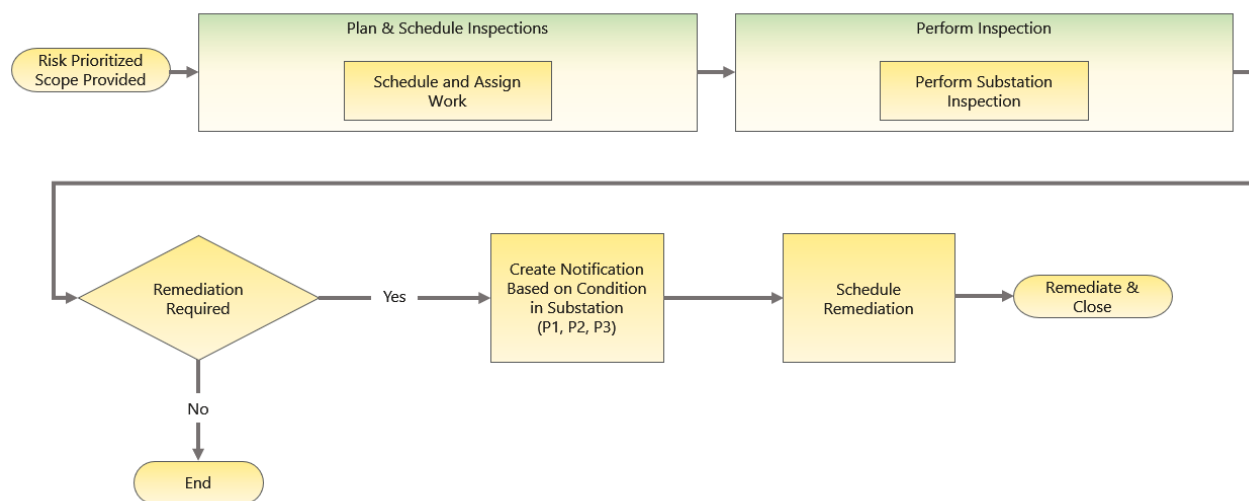

Frequency or Trigger

In this section, the electrical corporation must identify the frequency (including how frequency may differ by HFTD Tier or other risk designation[s]) or triggers used in the inspection program, such as inputs from the risk model.

For these programs, substations located within HFRA boundaries are given priority. Within the OCBA program, priority is first given to the HFRA equipment, although equipment condition, diagnostic results and/or known issues will also be taken into consideration when assessing priority order. Regarding PMA, priority is given to the HFRA substations identified within the FMEA. For CBOLM, prioritization is given to HFRA substations, followed by larger/more critical distribution voltage substations, especially those with elevated number of interruption events, and finally by transmission voltage stations.

In 2022, SCE increased the frequency of PMA inspections from three and five years (depending on the substation) to a consistent two-year cycle for approximately 40 HFRA substations identified through the FMEA. SCE will also continue the installation of CBOLM devices as well as prioritizing existing oil equipment inspections through the OCBA program.

If the inspection program is schedule-based, the electrical corporation must explain how it uses risk prioritization in the scheduling of the inspection program to target high-risk areas. If the electrical corporation does not use risk prioritization in the scheduling of the inspection program, it must explain why.

SCE schedules PMA inspections based on which substations were identified within the FMEA. The substations within HFRA are then inspected every two years. For OCBA, prioritization is given to circuit breakers located in HFRA substations. For CBOLM, SCE is installing Circuit Breaker On-Line Monitors (CBOLM) at substations in HFRA to enable collection of real time circuit breaker operational health data during all normal and fault-clearing circuit breaker operations. When this real-time operational health data shows slowing or other operational risk, emergent maintenance is immediately triggered by a back-end server to activate crews to perform corrective maintenance.

Accomplishments, Roadblocks, and Updates

In this section, the electrical corporation must discuss:

- *Noteworthy accomplishments for the inspection program since the last WMP submission*

SCE completed its target of inspecting all substations that were originally identified within the FMEA by June 2022.

- *Roadblocks the electrical corporation has encountered while implementing the inspection program and how the electrical corporation has addressed the roadblocks*

SCE did not encounter any roadblocks while implementing the program for substation inspections in 2022.

- *Changes/updates to the inspection program since the last WMP submission including known future plans (beyond the current year) and new/novel strategies the electrical corporation may implement in the next 5 years (e.g., references to and strategies from pilot projects and research)*

In 2022, SCE increased the frequency of PMA inspections from three to five years to a two-year inspection cycle for 37 HFRA substations. Substation inspection scope decreased to 37 substations; Topanga substation, which is out of service and Isabella and Tengen substations were omitted from the inspection cycle list due to not meeting the risk criteria. SCE will incorporate any lessons learned in its deployments of this new frequency in the future.

8.1.4 Equipment Maintenance and Repair

In this section, in addition to the information described above regarding distribution, transmission, and substation inspections, the electrical corporation must provide a brief narrative of maintenance programs. As a narrative, the electrical corporation must include its strategy for maintenance, such as whether the electrical corporation replaces or upgrades facilities/equipment proactively (for example, an electrical corporation may monitor dissolved gases in its transformers to detect potential transformer failures to alert engineering and maintenance personnel or component lifecycle management) or if it runs its facilities/equipment to failure.

SCE maintains a robust infrastructure replacement (IR) program across its service area. Infrastructure replacements are typically: (1) unplanned, to address in-service failures; (2) planned, based on inspections; or (3) planned, based on engineering and data analysis. SCE's infrastructure replacement programs discussed in this section are not wildfire driven, but rather driven by maintaining a safe and reliable electric distribution system.

The narrative must include, at minimum, the following types of equipment:

- *Capacitors*

Transmission

Not applicable as SCE currently does not have capacitors on the transmission system.

Distribution

The distribution capacitor bank replacement program replaces or removes failed distribution capacitor banks and their associated capacitor switches. Each capacitor bank is comprised of capacitor units, fuses, a rack, and mounting hardware. For switched capacitor banks, capacitor switches and a capacitor control are also included. Capacitor banks are identified for reactive replacement through either cyclic or ad hoc field inspections. Capacitor data points are collected on a survey while aerial and/or ground inspections are being performed.

Substation

SCE substation capacitor banks are on a condition-based program, which entails periodic thermal and visual inspection and analysis by the Predictive Maintenance Assessment group. Also, SCE performs proactive maintenance, which involves a period inspection on equipment by operators. If an issue is identified, it is documented and reported to Maintenance personnel and further investigation of the issue is performed.

- *Circuit breakers*

Transmission

Not applicable as these are substation equipment.

Distribution

Not applicable as these are substation equipment.

Substation

SCE has multiple programs to mitigate risks related to circuit breaker failures. SCE health scores all circuit breakers from bulk electric system (BES) voltage down to distribution customer circuit voltage. Our maintenance and inspection programs monitor and maintain circuit breaker conditions. The substation infrastructure replacement (IR) program replaces aging circuit breakers preemptively before they reach the end of their usable lives. The Substation Equipment Replacement Program (SERP) replaces overstressed circuit breakers. Both programs regularly interact to review forecast and bundle projects for cost effective implementation. These mitigations are intended to reduce the number of circuit breaker failures, which in turn reduces the associated reliability and safety risks. SCE also proactively tries to mitigate unplanned events by the utilization of the health index tool for circuit breakers. This takes input from SCE's substation Condition Based Maintenance (CBM) programs which are designed for the ongoing identification, prioritization, and quantification of condition assessment performed on a recent asset.

- *Connectors, including hotline clamps*

Transmission

As part of SCE's Transmission Overhead Re-conductor Program (ORCP), hardware, and associated components including connectors will be replaced as a result of reconductoring. Additionally, while performing inspections conditions found to need repair will be documented and remediated.

Distribution

As part of SCE's OCP, hardware and associated components including connectors will be replaced as a result of reconductoring. Additionally, while performing inspections conditions found to need repair will be documented and remediated.

Substation

Not applicable as SCE currently does not have a designated replacement program.

- *Conductor, including covered conductor*

Transmission

The ORCP replaces transmission conductor, to reduce the likelihood of risk events, such as wire downs, by replacing overhead segments with new conductor. Additionally, while performing inspections conditions found to need repair will be documented and remediated.

Distribution

The OCP is the primary vehicle for the proactive replacement of overhead conductor outside of High Fire Risk Areas (HFRA). OCP is a risk-informed program that proactively replaces high-risk conductor segments and includes the installation of protective devices as needed. To further optimize the program, SCE uses a risk analysis that considers factors such as consequences of a wire down event in areas with a high degree of public safety.

This program aims to prevent failures that can lead to wire down events by replacing conductor that is more resilient to fault events and reduces the number of faults. OCP also replaces problematic conductor segments that have been spliced or damaged with larger more resilient conductor to improve system integrity and to reduce the number of potential wire downs.

Substation

The Copper Wire Replacement program replaces aging copper communication cable with fiber optic cable to preserve the reliability of grid protection and grid operations circuits and provides more bandwidth for increasing data needs. The average service life of copper cable ranges from 25 to 35 years, depending on the environment where the cable is installed. Most of SCE's copper cables are over 25 years old, with more than 50% (over 1,000 miles of cable) over 35 years old. As copper cable reaches the end of its useful life, performance degrades because of ground faults, susceptibility to noise, and the effects of high-voltage testing and cable outages. These factors all greatly reduce system reliability.

SCE has other substation programs related to communication assets, such as fiber optic replacement program, which replaces aging and problematic fiber optic cables, and microwave replacement program, which replaces obsolete, failed, beyond useful life, and damaged microwave equipment.

- *Fuses, including expulsion fuses*

Transmission

Not applicable as SCE currently does not have fuses on the transmission system.

Distribution

While performing inspections conditions found to need repair will be documented and remediated. Fuses are installed per our engineering standards for new construction and fuses are replaced when a failure has been identified.

Substation

While performing inspections, conditions found to need repair will be documented and remediated. Fuses are installed per our engineering standards for new construction and fuses are replaced when a failure has been identified. Refer to “other equipment not listed” section for ignition events reviewed through our Wildfire Mitigation Strategy department for proactive measures established through the evaluation of asset trends.

- *Distribution poles*

Programs, such as Pole Loading Program (PLP) and Intrusive Pole Inspection Program (IPI) identify when a pole needs to be replaced based on calculated criteria. SCE also has a Steel Stub Program, which supports the remediation of deteriorated wood poles that are within a specified threshold by restoring the poles to their original load capacity. The steel stub extends the useful service life of the wood pole while ensuring safety factors are maintained for safety and compliance. Pole data points are collected on a survey while aerial and/or ground inspections are being performed. Pole replacements can also be identified through detailed inspections, patrols, new construction (e.g., covered conductor, equipment replacement, new equipment installation, etc.) which requires pole loading that can result in pole replacement.

Per SCE standards, distribution pole replacements in HFRA locations with no equipment and not located in a woodpecker area will be installed with a wood pole with fire resistant (FR) wrap. Distribution pole replacements in HFRA locations with specific equipment (e.g., transformer, capacitor, automatic recloser, RCS, or riser) will be installed with a composite pole with fire shield.

- *Lightning arrestors*

Transmission

Not applicable as these are not installed on transmission lines.

Distribution

SCE performs aerial and/or ground inspections where issues pertaining to lightning arrestors could be identified. Lightning arrestor data points are collected on a survey while aerial and/or ground inspections are being performed. Refer to “other equipment not listed” section for ignition events reviewed through our Wildfire Mitigation Strategy department for proactive measures established through the evaluation of asset trends.

Substation

While performing inspections conditions found to need repair will be documented and remediated. Refer to “other equipment not listed” section for ignition events reviewed through our Wildfire Mitigation Strategy department for proactive measures established through the evaluation of asset trends.

- *Reclosers*

Transmission

Not applicable as SCE currently does not have a designated replacement program.

Distribution

The distribution automatic recloser replacement program replaces automatic reclosers (ARs) identified as being obsolete and/or unreliable. SCE has been replacing ARs in recent years to remove all old oil filled ARs from inventory and replace them with new vacuum ARs. The program will continue to replace older and obsolete vacuum ARs as well as Vacuum Fault Interrupters in the upcoming GRC cycle. Recloser data points are collected on a survey while aerial and/or ground inspections are being performed.

Substation

Automatic recloser replacement program is not applicable to substations.

- *Splices*

Transmission

As part of SCE’s Transmission program (ORCP), hardware and associated components including splices will be replaced as a result of reconductoring. Additionally, while performing inspections conditions found to need repair will be documented and remediated.

Distribution

As part of SCE’s Distribution overhead conductor program (OCP), hardware and associated components including splices will be replaced as a result of reconductoring. Additionally, while performing inspections conditions found to need repair will be documented and remediated. SCE will continue to perform infrared (IR) inspections in HFRA. The IR scan detects temperature differences and heat signatures of components, which may indicate problems that could result in component failure. Additionally, while performing inspections conditions found to need repair will be documented and remediated. Fuses are installed per our engineering standards for new construction and fuses are replaced when a failure has been identified.

Substation

SCE uses infrared technology during substation inspection to identify hot spots on connection and components. While performing inspections conditions found to need repair will be documented and remediated.

- *Transmission poles/towers*

SCE performs both proactive and reactive maintenance and repairs on the transmission system based on inspection findings and system conditions. Proactive maintenance identifies issues during regular inspections, and reactive maintenance occurs due to unplanned events. This activity includes performing repairs on transmission line equipment and structures, such as poles, towers, conductors, and their components, including FAA tower lighting and marker balls.

Programs, such as Pole Loading Program (PLP) and Intrusive Pole Inspection Program (IPI) identify when a pole needs to be replaced based on calculated criteria. SCE also has a Steel Stub Program, which supports the remediation of deteriorated wood poles that are within a specified threshold by restoring the poles back to the original load capacity. The steel stub extends the useful service life of the wood pole, while ensuring safety factors are maintained for safety and compliance. Pole data points are collected on a survey for HFRA locations while aerial and/or ground inspections are being performed. Pole replacements can also be identified through detailed inspections, patrols, new construction (e.g., covered conductor, equipment replacement, new equipment installation, etc.) which requires pole loading that can result in pole replacement. Per SCE standards, new construction or pole replacements are installed with wood pole with fire resistant (FR) wrap.

SCE's Transmission Infrastructure Replacement Program targets assets for replacement, such as overhead conductor, underground cable, switches, cable terminations, and other infrastructure based on risk, engineering and data analysis. The tower corrosion program is an assessment program that SCE implements annually to identify the total scope of remediation work. These assessments will be above and below ground. Without mitigation, especially in more extreme weather areas, SCE's lattice towers will continue to corrode.

Finally, regarding insulator washing, this program requires a visual inspection of a circuit for contamination, often indicated by arcing or buzzing. If no or minimal contamination is present, the circuit will continue to be monitored. If excessive contamination is present, the circuit must be washed. Typically, beach areas with high salt levels and high traffic volume require more frequent washing than a desert area with drier air and less exhaust from traffic.

- *Transformers*

Transmission

Not applicable as SCE does not install transmission transformers. Transformers are installed inside substations when transforming down to lower voltages.

Distribution

SCE's Polychlorinated Biphenyls (PCB) Transformer Removal Program replaces distribution line transformers suspected of being contaminated with PCB oil greater than 50 parts per million. PCBs are chemicals that could have negative effects on the environment and human health.

In addition, SCE will be proposing in the upcoming GRC, a proactive replacement program for distribution service transformers, focused on assets where heat stress is likely to be most impactful. The program aims to improve safety and reliability by reducing catastrophic and routine service transformer failures, and to reduce operational burden during and after heat waves by proactively replacing units that are most likely to fail.

At this time, SCE does not have a transformer replacement program for other types of transformers not mentioned above. SCE's approach is to run this equipment to or near failure. However, when aerial and/or ground inspections are being performed, transformers repairs/replacements are identified, and transformer data points are collected on a survey when performing a detailed inspection. Additionally, while performing inspections conditions found to need repair will be documented and remediated. Fuses are installed per our engineering standards for new construction and fuses are replaced when a failure has been identified.

Substation

The substation transformer replacement program identifies and replaces transformers approaching the end of their service lives, which contain parts known to be problematic or are no longer available. Also, SCE proactively tries to mitigate unplanned events by the utilization of the health index tool for transformers. This takes input from SCE's substation Condition Based Maintenance (CBM) programs, which are designed for the ongoing identification, prioritization, and quantification of condition assessment performed on recent assets. The substation transformer asset replacement program consists of the following transformer classes:

- AA-Bank transformers – located in major substations where they take electricity at the 500kV transmission level and transform it down to 220kV
- A-Bank transformers – located in major substations where electricity at the 220kV transmission level is transformed down to a sub-transmission voltage, either 115kV or 66kV
- B-Bank transformers – located at the sub-transmission level, usually 66kV but sometimes 115kV, transform it down to 33kV, 16kV, 12kV, or 4kV, and distribute it onto distribution circuits to feed pole-mounted, pad-mounted, or subsurface line transformers.
- *Other equipment not listed*

For transmission and distribution equipment, SCE reviews ignition events and asset trends across HFRA and non-HFRA locations. Engineers and technical experts will review and analyze data to identify potential trends and determine if further evaluation is required, which may result in a proactive mitigation program being established to address the identified risk(s). Additionally, while performing inspections conditions found to need repair will be documented and remediated.

In the 2022 WMP, SCE committed to perform a FMEA study for substation assets located in HFRA locations to identify potential failures associated with ignition risks. This study resulted in shortened inspection timeframe for a select number of substations the If a risk was identified, the inspection timeframe was shortened.

8.1.5 Asset Management and Inspection Enterprise System(s)

In this section, the electrical corporation must provide an overview of inputs to, operation of, and support for centralized asset management and inspection enterprise system(s) updated based upon inspection results and activities such as hardening, maintenance, and remedial work. This overview must include discussion of:

The electrical corporation's asset inventory and condition database.

SAP is SCE's enterprise resource planning software that serves as our systems of record for asset inventory and asset conditions. As such, software developed specifically for wildfire mitigation receives master data from SAP, updates data with work order status information, and writes the results of work back to the SAP system.

Describe the electrical corporation's internal documentation of its database(s).

SAP has documentation of both transaction and database elements of the software housed in augmented tools as well as formal documentation that comes with the software. Additionally, any customizations that SCE makes to SAP are documented in functional design specifications and/or technical design specifications.

Integration with systems in other lines of business.

The SAP software is integrated through hundreds of interfaces to hundreds of subscribing enterprise systems that require master data similar to the software that is reliant on SAP for asset master data in this volume. Other lines of business, such as customer service, transmission & distribution, human resources, information technology, grid operations, supply chain management, finance, and a myriad of other operating units utilize systems that are integrated with SAP.

Integration with the auditing system(s) (see QA/QC section below).

SAP has Sarbanes-Oxley (SOX) financial controls and separation of duty controls that are built directly into the software. Additionally, software changes and updates go through rigorous QA/QC testing to help ensure all subscribing systems and interfaces continue to function to support SCE operations once the changes are put into production.

Describe internal procedures for updating the enterprise system including database(s) and any planned updates.

SAP is SCE's core enterprise resource planning (ERP) system. SAP is responsible for updating the respective components (including databases) on a regular basis to ensure compatibility with SCE's operational systems, meaning all the systems that rely on master data from SAP. When these updates are available, SCE loads this new code into our test environment, and validates the functionality end to end with regression and user acceptance testing to ensure everything works as expected in our environment. Any bugs found are communicated back to the vendor to be fixed and retested. Once the new code passes testing, we migrate the new functionality to our production environment. For any custom developed functionality, SCE follows a standard software development lifecycle process, including quality assurance testing, regression testing, and user acceptance testing before new functionality is moved into our production environment.

Any changes to the initiative since the last WMP submission and a brief explanation as to why those changes were made. Include any planned improvements or updates to the initiative and the timeline for implementation.

Since the last WMP submission, SAP continuously undergoes changes based on enterprise needs, however, with respect to wildfire mitigation no changes were made to SAP due to the WMP. SCE's

design approach for SAP is to ensure all subscribing systems can obtain the same master data from SAP databases, which allows programs that connect to SAP for that data to customize as necessary outside of SAP.

Wildfire Mitigation Systems that Leverage SCE's Asset Management and Inspection Enterprise System

There are several systems and tools that SCE has and continues to build to support wildfire mitigation efforts. These systems connect with SAP. SCE summarizes several of these systems below, including:

- Wildfire Safety Data Mart and Portal (WiSDM)
 - Ezy Data
 - InspectForce
 - FMP360
-
- **Wildfire Safety Data Mart and Portal (WiSDM)**

WiSDM is a scalable, cloud-based, and geospatially enabled centralized wildfire data repository.¹⁶⁸ The main asset inventory master data resides in SAP and condition data is collected from various systems and inspection tools.

In addition to data ingestion from the source systems, Foundry also provides data harmonization and normalization, visually displays the data ontology (model), tracks data lineage and transformations, and can help to automate manual business workflows. Within WiSDM, a common data design is created that allows for simplified access to asset data, asset condition, asset inspections, and wildfire mitigation, and further allows for use of this data in SCE's risk analysis and internal and external reporting.

From a software design and integration standpoint, WiSDM relies on a shared meta-data directory with Ezy to help ensure structured and unstructured data, such as LiDAR data, photos, and video, can be associated with each other accurately. Additionally, QA/QC personnel may use the data in WiSDM to check timestamped photos, videos, and LiDAR to validate that work has been completed. Similarly, data used for various reports will be timestamped and stored for future reference.

In 2023, SCE intends to perform the following:

- Initial consolidation of wildfire data ingestion and management into WiSDM
- Build an Enterprise Data Warehouse (EDW) on Snowflake for storage and analytics of wildfire data (including historical data)
- Building a Wildfire Data Portal using ArcGIS Portal

¹⁶⁸ A data repository (or data mart) is a subject-oriented database that meets the demands of a specific group of users. It is typically a subject area within a data warehouse.

- **Ezy Data**

Ezy Data is a system that collects unstructured data (e.g., pictures, video, LiDAR) from various inspection tools and consolidates inspection data reporting across wildfire activities. In addition, Ezy Data manages the full life cycle of SCE's unstructured data that supports aerial and other asset inspection programs at SCE. SAP's asset inventory and other GIS datasets are used to schedule and manage image capture assignments related to SCE structures.

The part of Ezy Data that documents the metadata for unstructured data is the Universal Data Descriptor Repository (UDDR), which is being built to catalog unstructured remote sensing data. UDDR stores metadata in a centralized repository that references underlying raw data stored in various cloud platforms (GCP, Azure, AWS). Specifically, structured data is used to tag unstructured data (e.g., asset information on a high-definition video) in order for inspectors and other consumers of the data to be able to quickly locate the unstructured data they require.

The UDDR provides a mechanism to integrate unstructured (e.g., images, documents) data with their relevant asset master (e.g., data associated with an asset such as location or type) and transactional data (e.g., information captured during inspection). The AI/ML algorithms leverage the UDDR data in order to provide insights to optimize the inspection business process.

Ezy Data has data pipelines that process multiple inspection programs data, one of which is QA/QC inspection. This integration contains two use cases:

- Dedicated data pipeline that processes QA/QC photos (from AGOL on AWS) and add both photo thumbnails and metadata to UDDR on GCP
- UDDR exposes all inspection photos (as linkable GRViewer url) to QA/QC PowerBI based dashboard

SCE plans to derive data insights (e.g., structure lat/long location) from structured/unstructured data collected from Ezy Data and use these findings to remediate asset master datasets. One such example is structure location data. From millions of high-definition (HD) images, algorithms and ML models are run to predict correct structure location with high confidence. Once data insights are gathered from the automated latitude/longitude location accuracy report, remediation workflow will update master data in source systems. For 2023, SCE plans to update asset master data for 100,000 structures.

Since the last WMP submission, Ezy Data is adding more unstructured data into its repository, including videos from aerial inspections and other programs, which will enable a more comprehensive database of asset information in support of SCE's wildfire programs. Ezy Data is also extending its integration with other systems, such as Salesforce-based field inspection platforms, AI/ML projects for object/defect detection, image analytics, and others. In addition, SCE is also expanding its design and development of UDDR to support future analytics and solutions capabilities with both structured and unstructured datasets.

The planned improvements or updates to Ezy Data include:

- Centralize storage and processing of LiDAR datasets collected from multiple SCE programs, integrate them with HD images and videos in UDDR, and support various business use cases.
- With the expansion of UDDR data, especially the association of LiDAR, HD photos and videos with a high degree of data accuracy assurance, SCE can better support future analytics and solutions capabilities with both structured and unstructured datasets.
- Continue to enhance advanced AI/ML capabilities using SCE's data science environment on Ezy Data. With more advanced object and defect detection models, SCE can enhance automatic detection of potential fault conditions by leveraging all of the data tools and technologies in the Ezy Data environment. This will increase the enhance the efficiency of our inspectors by identifying potential faults and prioritizing them for review. For example, The AI/ML computer vision models for asset defect detection are being used by Overhead Distribution Inspections and Transmission Inspections. They will automatically analyze images to identify characteristics within the image (e.g., defects) without human intervention. These models are currently running in an advisory mode, where the output is presented to an inspector who then reviews and validates the detected defect's accuracy. The inspector will agree with the defect, which raises a notification for mitigation, or will disagree, which retrains and improves the model's accuracy.

- **InspectForce**

InspectForce is the centralized asset inspection product used for planning and executing inspections, which was developed on the Salesforce platform. It is a common inspection management solution to support many inspection types (aerial and ground for transmission and distribution, post failure and post construction asset inspections, etc.). This establishes a foundation for sharing work and information across inspections and will improve the effectiveness and speed of inspections, data quality and record accuracy, and help ensure that information is available, accessible, and timely to support wildfire mitigation activities.

InspectForce utilizes the asset inventory from the asset system of record, SAP. The survey data collected during the inspections is stored in Salesforce and is available for reporting and analytics. Any condition issues that are identified during an inspection that requires remediation will result in the creation of a notification that is stored in SAP.

The InspectForce application solution design, including the data model, data schema, and all other database design aspects, are documented in the Solution Architecture Document for the application.

The majority of master data that InspectForce consumes comes from interfaces with our SAP and cGIS (consolidate geographic information system) systems. SAP is the system of record for asset master data while cGIS is the system of record for location-based data. All interfaces are documented in the logical architecture.

IT systems are continuously monitored to ensure operational and data integrity is maintained through a variety of tools. Additionally, IT operations has a help desk function for SCE users experiencing any problems with any systems to report those as necessary.

SCE is utilizing Salesforce as well as two Salesforce partner products, Youreka (for mobile complex, dynamic forms) and Lemur (for mobile maps), as the core technology components of InspectForce. As inspections are completed using InspectForce, the inspection information (inspection survey and any notifications raised) are captured in the InspectForce (Salesforce) database.

These vendors are responsible for updating their respective software products (including databases) on a regular basis to ensure compatibility with SCE's operating system (typically 3-4 times a year). When these updates are available, SCE loads this new code into our test environment, and validates the functionality end to end with regression and user acceptance testing to ensure everything works as expected in our environment. Any bugs found are communicated back to the vendor to be fixed and retested. Once the new code passes testing, we then migrate the new functionality to our production environment. For any custom developed functionality for the solution, we use an agile development process with a standard monthly release schedule. This process also includes quality assurance testing, regression testing, and user acceptance testing before new functionality is moved into our production environment.

Since SCE's last WMP submission, SCE is planning in 2023 the following updates:

- Utilizing the feasibility assessment and high-level design completed in 2022, SCE will develop the detailed design to migrate the distribution ground inspection application to the single digital platform. Migration of distribution ground to a single digital inspection platform is tentatively scheduled for 2024.
- Based on the outcome of the analysis completed in 2022 for incorporating the work bundling functionality into the Scope Mapping Tool, a decision was made to defer implementation of the functionality into a future iteration of SMT as this was determined to be a more effective approach.
- Plan to pilot the ability to run the ML models in the field. This will help the inspector in the field identify potential defects at the time of inspection that may have been missed, speeding up the time to raise a notification if required.
- Plan to complete the evaluation and design to integrate the assisted reality InspectCam capability, including the ability to automatically detect if the image captured is at the appropriate image clarity, into the InspectForce solution.

- **FMP360**

The FMP360 mobile application is used for tracking the remediation work resulting from an asset inspection. FMP360 is a field solution specifically deployed to help ensure ignition risk conditions identified by ground and aerial inspections are tracked and validated as those issues are corrected in the field.

FMP360 is primarily integrated with SAP through the consolidated mobile solution (CMS) system and the data subsequently updates the status and evidence of work in our SAP and records management systems. This makes the state of remediations available to users across the organization.

As part of software quality assurance, SCE performs rigorous software testing including user acceptance testing (UAT) to ensure software meets operational needs. In addition, data captured by the FMP360

mobile app in the field on an iPad by crew foreman or QA inspectors is uploaded into the CMS enterprise back-office system with time stamps, work order numbers, and associated metadata. That data is then published to other subscribing systems across the enterprise, such as SAP.

8.1.6 Quality Assurance and Quality Control

In this section, the electrical corporation must provide an overview of its quality assurance and quality control (QA/QC) activities for asset management and inspections. This overview must include:

- *Reference to procedures documenting QA/QC activities.*

SCE field supervisors perform random quality field checks as a first line of defense. SCE also has a Compliance & Quality (C&Q) organization that performs QA/QC assessments of wildfire and non-wildfire activities and drives continuous improvement throughout the organization as a second line of defense. Current QA/QC programs include assessments of distribution planning, distribution and transmission construction activities by SCE and contract crews, as well as various transmission and distribution inspection programs. The group assesses compliance with General Order Nos. 95/128/165 and various SCE maintenance, inspection, and construction standards. Supporting documentation for QA/QC activities is available at <https://www.sce.com/safety/wild-fire-mitigation> for assessments of construction activities, Distribution Detailed Inspections and Remediations [Section 8.1.3.1], Transmission Detailed Inspections and Remediations [Section 8.1.3.2] and Generation Inspections [Section 8.1.3.7].

- *How the sample sizes are determined and how the electrical corporation ensures the samples are representative.*

SCE's Compliance & Quality (C&Q) group uses a risk-based approach to determine sample size/selection and measure performance targets (i.e., Confidence Level (CL). The CL and Confidence Interval (CI) used to determine the sample size varies by risk from Very High, High, Medium, to Low. In 2023, C&Q shifted to the new IWMS 5x5 matrix with one dimension of the matrix representing five levels of POI risk and the other dimension representing five levels of consequence. These dimensions were translated into the four categories for IWMS risk shown in

Figure SCE 8- 35 below (also see Figure SCE 8-25 for further detail on this translation). Programs also receive a tanking based on factors such as complexity, potential downstream impacts, and component or structure risk. Under this methodology the C&Q organization performs QC reviews on wildfire and non-wildfire activities using the CL/CI levels as shown below in Figure-SCE-8-35.

Figure SCE 8- 35 - Confidence Level (CL)/Confidence Interval (CI) for QC inspection programs

	IWMS Risk							
	Very High		High		Medium		Low/Non	
	CL	CI	CL	CI	CL	CI	CL	CI
Program Ranking								
Very High	100%	0%	99%	1%	99%	2%	99%	5%
High	99%	1%	97%	1%	97%	3%	97%	5%
Medium	97%	1%	97%	2%	96%	3%	96%	5%
Low	95%	1%	95%	2%	95%	3%	95%	5%

- *Qualifications of the auditors.*

All QC inspectors meet the defined Personnel Qualification Standard (PQS) and perform the field inspections following the Inspection and Maintenance Program manual developed for each respective inspection program (e.g., Distribution Inspection and Maintenance Program (DIMP), Transmission Inspection & Maintenance Program (TIMP), etc.).¹⁶⁹ This involves required office and field training, as well as certification testing and re-qualification for each program being reviewed.

- *Documentation of findings and how lessons learned based on those findings are incorporated into trainings and/or procedures.*

The C&Q group partners with organizations throughout SCE’s T&D operating unit to identify potential quality gaps and assess compliance with CPUC General Order’s 95/165 and various SCE maintenance, inspection, and construction standards. SCE’s inspection QA/QC program helps drive continuous improvement and is deemed effective when it identifies non-conformance with SCE standards, determines causes of non-conformance, or implements necessary corrective actions. SCE follows the progress of the formal action plans to corrective actions, which can include implementing changes or enhancements to inspection processes, training, etc., to continuously improve the inspection programs based on QA/QC findings. Corrective actions and their status are tracked in a corrective action tracker until completion. Increases in conformance rates over time also reflect the effectiveness of the program.

- *Any changes to the initiative since the last WMP submission and a brief explanation as to why those changes were made. Include any planned improvements or updates to the initiative and the timeline for implementation.*

Since SCE’s last WMP submission, the Quality Program risk rankings and the risk methodology used to determine sample size/selection are updated annually. The CL and CI used to determine the sample size varies by program risk and structure level risk as determined by SCE’s risk model. As described above,

¹⁶⁹ This section pertains to Quality Assurance and Quality Control activities, therefore, the “Qualification of the auditors” is referring to the QC inspectors performing the activities described in this section. SCE also has an independent Audit Services Department that performs audits and that is not what is being described in this section.

C&Q shifted to the new IWMS 5x5 matrix in 2023.

Tabular information that includes:

- Sample sizes
- Type of QA/QC performed (e.g., desktop or field)
- Resulting pass rates, starting in 2022
- Yearly target pass rate for the 2023-2025 WMP cycle

Table 8-7 - Grid Design and Maintenance QA/QC Program

Activity Being Audited	Sample Size	Type of Audit	Audit Results 2022	Yearly Target Pass Rate for 2023-2025
Overhead Detailed QC Inspection	4,132 samples in 2022, Randomly selected Risk Based Inspections in Tier 2 and Tier 3 Areas	Field	96%	2023: 95%; 2024-25: To be Developed Annually after previous year results become available
Transmission Detailed Inspections	532 samples in 2022, Randomly selected Risk Based Inspections in Tier 2 and Tier 3 Areas	Field	98%	2023: 97%; 2024-25: To be Developed Annually after previous year results become available
Generation Inspections	150 samples in 2022, Randomly selected Risk Based Inspections in Tier 2 and Tier 3 Areas	Field	95%	2023: 95%; 2024-25: To be Developed Annually after previous year results become available

8.1.7 Open Work Orders

In this section, the electrical corporation must provide an overview of the procedures it uses to manage its open work orders resulting from inspections that prescribe asset management activities. This overview must include a brief narrative that provides:

- Reference to procedures documenting the work order process. The electrical corporation must provide a summary of these procedures or provide a copy in the supporting documents location on its website.

Supporting documentation is available at <https://www.sce.com/safety/wild-fire-mitigation> for both the TIMP and DIMP.

- *A description of how work orders are prioritized based on risk.*

SCE currently prioritizes open work orders¹⁷⁰ based on the severity of the finding and the associated compliance deadline based on HFTD location (i.e., HFRA Tier 2, HFRA Tier 3, or Non-HFRA). An explanation of the various severity notification types is discussed in Section 8.1.3.1.

In 2020, SCE introduced a supplemental notification prioritization algorithm to accelerate remediation of the highest risk notifications in AOCs. In Q4 2022, after considering existing risk processes and incorporating lessons learned, SCE expanded on the prioritization methodology to apply to the notification backlog that currently exists, and which is discussed in response to ACI SCE-22-15 Targets Relating to Addressing Inspection Findings. In 2023, SCE will expand the prioritization methodology to apply to all open notifications in order to remediate the highest risk notifications.

- *A description of the plan for eliminating any backlog of work orders (i.e., open work orders that have passed remediation deadlines), if applicable.*

SCE's plan for eliminating its backlog of notifications that have passed their remediation deadline is discussed in detail in ACI SCE-22-15 Targets Relating to Addressing Inspection Findings. Additionally, to prevent the occurrence of new past-due notifications, SCE will analyze how it can prioritize all open-notifications to eliminate the riskiest and oldest notifications instead of the compliance focused "first-in and first-out" method used historically. Considering the growth in volume of work since SCE implemented more rigorous and frequent inspections in HFRA, SCE will modify its prioritization methods to prevent a growing backlog. In 2023, using lessons learned, SCE plans to update its notification backlog prioritization (as described in ACI SCE-22-15 Targets Relating to Addressing Inspection Findings) and aim to apply it to all open notifications. SCE will also investigate the possibility of expanding its open notification prioritization methodology based on lessons learned. While the reduction of the overall backlog count is desired, SCE's goal is to prioritize and close work orders that pose the highest risk to SCE's electrical system. The trade-off in prioritizing riskier work is that low risk work sometimes becomes past-due. The majority of SCE's backlog is comprised of low-risk notifications.

- *A discussion of trends with respect to open work orders.*

SCE's past due open work orders constitute less than 3% of SCE's overall open work orders. While this is a small fraction of the total, SCE is investigating new prioritization approaches for its open work orders to minimize the backlog in the future. Please reference SCE-22-15 Targets Relating to Addressing Inspection Findings.

- *In addition, each electrical corporation must:*
- *Graph open work orders over time as reported in the QDRs (Table 2, metrics 7.a and 7.b)¹⁷¹.*

¹⁷⁰ SCE utilizes the term notification instead of work order.

¹⁷¹ Manual adjustment by SCE to reflect open work orders as metric 8.a refers to "Response time to locked open circuit breaker."

Figure SCE 8-36 shows open work orders over time as reported in the QDRs. This data includes all transmission and distribution P2 and P3 open work orders regardless of whether they present an ignition risk or not.

Figure SCE 8-36 - Open Work Orders Over Time as Reported in the QDRs

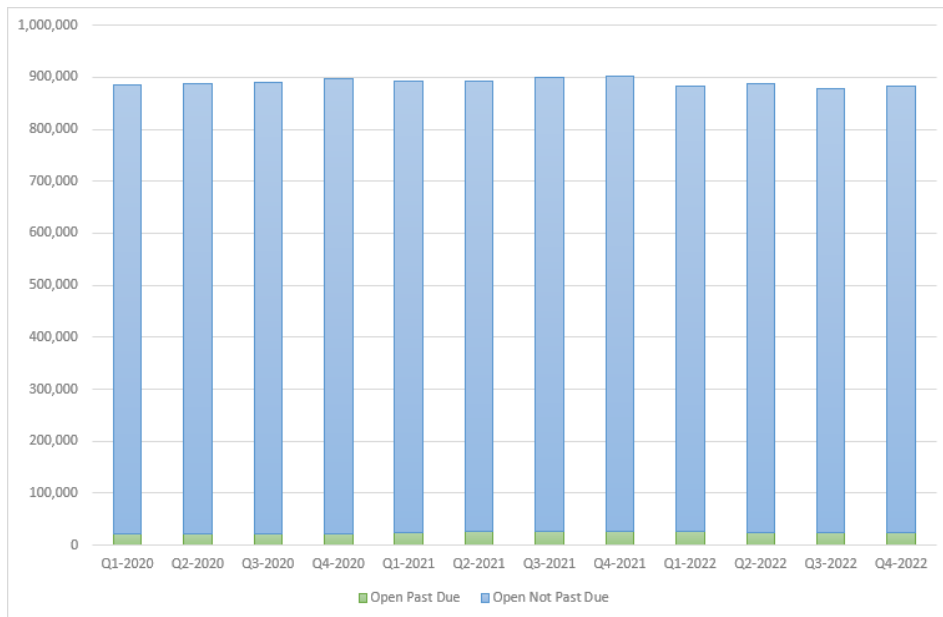

- *Provide an aging report for work orders past due.*

The three below tables for past due notifications (as of 12/31/2022) are broken down by (Table 8-8a) all past due notifications within HFRA and non-HFRA, (Table 8-8b) ignition risk past due notifications within HFRA and (Table 8-8c) ignition risk past due notifications within HFRA excluding GO 95 exceptions. SCE clarifies that for Table 8-8a, a portion of these notifications are non-ignition risk. For example, P2 notifications regarding right of way, ground clearing, and 3rd party customer attachments below the communication level. As discussed above, any notification that may result in an imminent ignition risk (P1) is made safe within 24 hours and the remediation is started within 72 hours, thus P1s do not contribute to the scope of notifications past their compliance due date.

**Table 8-8a - Number of Past Due Asset Work Orders Number of Past Due Asset Work Orders
¹⁷² Categorized by Age as of 12/31/2022 – All (HFRA & Non-HFRA)**

HTFD Area	0-30 Days	31-90 Days	91-180 Days	181+ Days	TOTAL
Non-HFTD	452	779	613	13,951	15,795
HFTD Tier 2	29	82	118	2,646	2,875
HFTD Tier 3	419	1,118	937	3,638	6,112
TOTAL	900	1,979	1,668	20,235	24,782

**Table 8-8b - Number of Past Due Asset Work Orders Categorized by Age as of 12/31/2022 –
 Ignition Risk (HFRA)**

HTFD Area	0-30 Days	31-90 Days	91-180 Days	181+ Days	TOTAL
HFTD Tier 2	25	70	111	2,319	2,525
HFTD Tier 3	412	1,076	876	2,948	5,312
TOTAL	437	1,146	987	5,267	7,837

**Table 8-8c - Number of Past Due Ignition Risk Asset Work Orders Categorized by Age as of
 12/31/2022 - Excluding GO 95 Exceptions (HFRA)**

HTFD Area	0-30 Days	31-90 Days	91-180 Days	181+ Days	TOTAL
HFTD Tier 2	13	32	34	977	1,056
HFTD Tier 3	275	780	705	1,791	3,551
TOTAL	288	812	739	2,768	4,607

¹⁷² SCE refers to “work orders” and “notifications” interchangeably.

8.1.8 Grid Operations and Procedures

8.1.8.1 Equipment Settings to Reduce Wildfire Risk

In this section, the electrical corporation must discuss the ways in which operates its system to reduce wildfire risk. The equipment settings discussion must include the following:

- *Protective equipment and device settings*
- *Automatic recloser settings*
- *Settings of other emerging technologies (e.g., rapid earth fault current limiters)*

For each of the above, the electrical corporation must provide a narrative on the following:

- *Settings to reduce wildfire risk*
- *Analysis of reliability/safety impacts for settings the electrical corporation uses*
- *Criteria for when the electrical corporation enables the settings*
- *Operational procedures for when the settings are enabled*
- *The number of circuit miles capable of these settings*
- *An estimate of the effectiveness of the settings*

8.1.8.1.1 Protective Equipment and Device Settings

Settings to reduce wildfire risk

Fast Curves are protective settings that operate faster than traditional relay protection settings to open the RAR or substation circuit breaker to stop the flow of electricity when an electrical fault unexpectedly occurs on a line. SCE implements Fast Curve settings on devices such as the Remote Automatic Reclosers (RARs) (SH-5) and substation circuit breaker relays (SH-6) as described in Section 8.1.2.8. Devices with Fast Curve settings reduce the amount of energy released at the fault location (due to causes such as a lightning strike or car hit pole incident) and, thus, reduce the likelihood of a fault creating an arc or sparking event that could result in an ignition.

Analysis of reliability/safety impacts for settings the electrical corporation uses

SCE studies and coordinates the settings applied to each protective device installed on every circuit to minimize the number of customers impacted. SCE coordinates Fast Curve settings so that the nearest device upstream of a fault operates before other upstream devices. This helps ensure that only the section of the circuit downstream of the protective device is interrupted from service while the rest of the circuit remains energized. For example, if a fault occurs downstream of a branch line fuse at the end of a circuit, the fuse should operate before the upstream recloser or circuit breaker, which would mean that only the section of the circuit downstream of the branch line fuse is interrupted from service. SCE reviews this type of coordination and deploys its Fast Curve settings accordingly based on the configuration of each circuit.

SCE began installing Fast Curve settings in 2018 to enable faster protection response to faults on higher risk circuits. In 2021, SCE did a MATLAB/Simulink analysis on 15 HFRA circuits and determined that we could refine our Fast Curve settings to improve reliability. SCE also determined in 2022 through a

desktop analysis that we could further increase the sensitivity of our settings without impacting reliability. When SCE conducted an analysis comparing older Fast Curve settings with newer Fast Curve settings installed since June 2021, we found that Fast Curve installations have not had any significant impact on customer reliability. Additionally, we found that outage impacts have been mitigated by other wildfire mitigations such as covered conductor and branch line fuses. SCE benchmarked its Fast Curve setting practices with several other electric utilities' fast trip practices to gain further insights. Based on the benchmarking analysis, SCE's Fast Curve settings operate comparable to other utilities while striking a balance between fast operation and reliable coordination with other protection devices.

SCE will conduct engineering reviews of previous installations of Fast Curve in 2023 to determine which devices should receive updated settings.

Criteria for when the electrical corporation enables the settings

SCE enables Fast Curve settings during elevated fire conditions. The criteria for these conditions include Red Flag Warnings (RFW) declared by the NWS and/or a Fire Weather Threats (FWT), Fire Climate Zones (FCZ), Thunderstorm Threats (TT) or PSPS Proximity Threats declared by SCE's weather forecasting team. This criteria is outlined in SCE's Standard Operating Bulletin 322 (SOB 322) and has evolved based on lessons learned from historical conditions (e.g., addition of FCZ, TT, etc.). SOB 322 helps to ensure consistency in the execution of HFRA protocols by consolidating the protocols into one bulletin that is used to train key stakeholders. SOB 322 contains updated operational protocols and standards for the safe operation of HFRA circuits and guides SCE's response during wildfire events and PSPS operations to help mitigate and reduce wildfire ignitions. The application of Fast Curve settings for the distribution system during a RFW, FCZ, FWT, TT, or PSPS proximity threat helps to ensure that any relay operation during a time of high wildfire risk releases as little electrical energy as possible. Transmission and sub-transmission systems already have high-speed tripping relays, so Fast Curve settings are not needed on these systems.

Operational procedures for when the settings are enabled

Following operation of a relay that has Fast Curve settings enabled, the impacted circuit is patrolled prior to re-energization pursuant to SOB 322. This helps ensure that qualified personnel identify and mitigate any conditions that could potentially lead to a wildfire ignition upon re-energization.

The number of circuit miles capable of these settings

All HFRA miles are capable of Fast Curve settings. Currently, approximately ~900 of ~1075 circuits have Fast Curve enabled on them. SCE is continuing to replace old electromechanical relays with modern microprocessor relays on the remaining ~175 circuits which will allow them to be set with Fast Curves. This relay replacement work should be completed by 2024. Furthermore, SCE anticipates revising all Fast Curves with the new setting strategy to provide better coverage by the end of its next GRC period ending in 2028.

An estimate of the effectiveness of the settings

SCE has seen a reduction of ~54% in the ignition-to-fault ratio on circuits with Fast Curve enabled during FCZ, compared to circuits without Fast Curve enabled, when analyzed over the same time period. The mitigation effectiveness value of Fast Curve settings, which includes the benefits of blocking automatic reclosers, is estimated to be up to 40% depending on the sub-driver.

8.1.8.1.2 Automatic Recloser Settings

Settings to reduce wildfire risk

During normal operations, automatic reclosing devices that are installed on circuits will operate to reenergize the circuit after a fault event to quickly restore electric service to customers. Although this approach has many benefits for addressing faults that are temporary, if the fault persists (e.g., is permanent) and fire risk is present, then subsequent attempts to automatically re-energize the circuits through this process could potentially lead to an ignition. SCE blocks automatic reclosers in areas and times of particular risk of an ignition. Blocking reclosing means that no attempted re-energization takes place automatically. SCE's current remote-control capabilities allow for blocking of reclosing relays for CBs and RARs with group commands of hundreds of devices at once.

Analysis of reliability/safety impacts for settings the electrical corporation uses

SCE has practiced blocking of automatic recloser relays for at least 30 years. Industry research has found that roughly 70% of distribution fault events are temporary in nature.¹⁷³ In some instances in the past, when an automatic recloser re-energized the line, the initial condition that created the fault had not cleared and caused another fault. SCE's practice of blocking reclosing is intended to reduce re-energization of permanent fault conditions, preventing repeat ignition risks.

Criteria for when the electrical corporation enables the settings

SCE blocks reclosers in HFRA during a RFW declared by the NWS, and/or a FWT, TT or PSPS Proximity Threat declared by SCE's weather team. This criteria is outlined in SCE's SOB 322.¹⁷⁴

The number of circuit miles capable of these settings

All HFRA miles are capable of blocking automatic reclosing of reclosers.

Operational procedures for when the settings are enabled

Blocking reclosing is enabled during Red Flag Warnings declared by the National Weather Service, and/or a FWT, FCZ, TT or PSPS Proximity Threats declared by SCE's weather forecasting team. This

¹⁷³ Sanap, M., & Shrivastava, P. K. (2018). Single phase fault analysis for temporary and permanent fault. *Asian Journal For Convergence In Technology* (AJCT) ISSN -2350-1146, 4(1). Retrieved from <https://asiansr.org/index.php/ajct/article/view/514>

¹⁷⁴ See Section 8.1.8.1.1 for a description of SOB 322.

criteria is outlined in SCE's SOB 322. When reclosing is blocked, the circuit or circuit section will remain de-energized until crews can be dispatched to patrol the line and determine if it is safe to re-energize.

An estimate of the effectiveness of the settings

SCE has calculated the mitigation effectiveness of Fast Curve, which includes blocking automatic reclosers. The mitigation effectiveness value of Fast Curve settings with recloser blocking is estimated to be up to 40% depending on the sub-driver.

8.1.8.1.3 Settings of other emerging technologies

This section describes emerging technologies that are currently being piloted in "alarm mode" only to determine if the device/algorithm detects the targeted grid conditions correctly. As such, the settings are in development and there are no grid response procedures that have been developed or implemented yet to respond to such events since the detection ability of these technologies is not yet proven. Much of the pilot evaluation is focused on eliminating the number of false positives generated from the schemes and are not advanced enough to be able to evaluate the impacts of different settings on reliability and safety if/when a detected condition is tripped. The responses below are provided with these constraints in mind.

8.1.8.1.3.1 High Impedance Relays (Hi-Z)

Settings to reduce wildfire risk

Hi-Z settings are designed to sense high impedance events on SCE distribution circuits residing within the field devices. Currently these settings are designed to raise an alarm if a potential condition is detected.

Analysis of reliability/safety impacts for settings the electrical corporation uses

In lab testing, SCE has demonstrated that the Hi-Z relay technology can detect Hi-Z conditions; however, SCE is still validating the technology's efficiency in the field in detecting actual Hi-Z events.

Criteria for when the electrical corporation enables the settings

Hi-Z settings are being piloted and will remain in "alarm mode" only until the technology and SCE's use of it has been validated in the field. If the technology is successful, SCE plans develop a standard for Hi-Z relay operations and expects that the technology would be deployed to continuously monitor the lines for high impedance conditions.

Operational procedures for when the settings are enabled

As the deployment is still in the pilot phase, there are no specific actions required for Hi-Z alarms at this time. Since Hi-Z alarms are integrated with the monitoring systems for SCE's grid operations, if the Hi-Z alarms, then the grid operations team will determine next steps, e.g., verifying the alarm and determining the appropriate response. If an actual Hi-Z condition results in a faulted event, SCE has procedures in place for system restoration to respond to the fault.

The number of circuit miles capable of these settings

The Hi-Z algorithm can be installed on any solidly grounded distribution system.¹⁷⁵ Once installed, the Hi-Z settings are only able to detect high impedance conditions downstream of the field devices where the settings are installed.

An estimate of the effectiveness of the settings

Detection of Hi-Z conditions is an industry-wide challenge and SCE's traditional feeder protection elements are based on overcurrent, meaning the protection elements rely on fault magnitude to trigger the relay to operate. In a Hi-Z event, however, the fault magnitude is relatively small to non-existent. Therefore, protection schemes that can detect Hi-Z conditions can reduce the propagation of low magnitude fault conditions and reduce ignition risk. When fully operational, with the ability to alarm and trip, Hi-Z relays are effective at mitigating the impact of downed energized wire conditions. Please see Appendix F: Supplemental Information for additional information on the estimated effectiveness of Hi-Z at addressing each risk driver.

8.1.8.1.3.2 Transmission Open Phase Detection (TOPD)

Settings to reduce wildfire risk

Transmission Open Phase Detection (TOPD) facilitates detection and de-energization of an open phase (broken transmission conductor) before it can contact a grounded object and create a fault event. While most of the pilot installation is operated in alarm-mode only, if deployed with the ability to alarm and trip this technology could reduce ignition risk associated with the high voltage transmission system.

Table SCE 8-37 below shows an illustration of a TOPD scheme.

Figure SCE 8-37 - Illustration of a TOPD Scheme

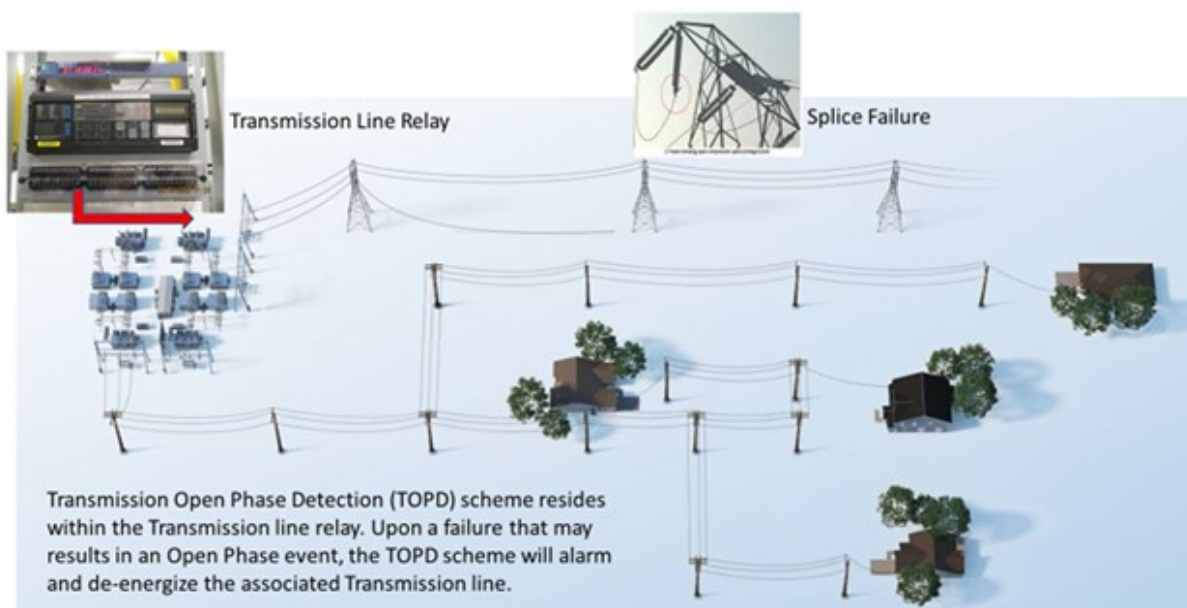

¹⁷⁵ Solidly grounded systems are those that have a power source in which the neutral wire of the transformer or generator is directly connected to the ground.

Analysis of reliability/safety impacts for settings the electrical corporation uses

Open phase conditions refer to the scenario where one of three phases is physically disconnected on the transmission system. This could occur due to a loose cable, broken conductor, or hardware/splice failure. An undetected open phase condition may cause the energized conductor to drop to the ground. In 2019, SCE evaluated the effectiveness of the open phase detection scheme using Real Time Digital Simulation (RTDS). Test results indicated the technology works as intended, that is, TOPD was able to correctly identify all broken conductor testing events simulated. In collaboration with our relay vendors, TOPD settings will be vetted through RTDS to ensure that TOPD settings deployed will respond correctly.

Criteria for when the electrical corporation enables the settings

TOPD is in the pilot stage and most of the installation will remain in “Alarm mode” only. During “Alarm Mode”, the TOPD scheme will not de-energize Transmission lines. In December 2022, SCE enabled trip functionality on TOPD settings for five of the Transmission lines. The TOPD settings for these five lines were set to continuously monitor the lines for any open phase conditions.

Operational procedures for when the settings are enabled

Since TOPD alarms are integrated with the monitoring systems for SCE’s grid operations, if the TOPD alarms then the grid operations team will determine next steps, e.g., verifying the type of event, validating the alarm and determining the appropriate response. If an actual open phase condition results in a faulted event, SCE has procedures in place for system restoration to respond to the fault.

The number of circuit miles capable of these settings

TOPD scheme may only be deployed for transmission lines that have single-conductor per phase and connect between two substations. TOPD installations through 2025 will have covered nearly all Transmission circuits in HFRA capable of this technology. TOPD is not deployable on distribution circuits.

An estimate of the effectiveness of the settings

In 2020, SCE evaluated two false positive events related to a fault on a transmission line which resulted in the refinement of the logic scheme by incorporating a 0.7 second delay timer. This made TOPD logic less susceptible to events that normally occur on the system and are not related to open phase events. The deployment of TOPD across different regions is required to identify similar/new challenges with the security of the TOPD logic since each Transmission line will vary in complexity. This complexity is related to factors, such as line loading, number or terminals, CT ratios, and frequency of faults within the region. All these factors play a role in the effectiveness of the TOPD. From the 2021 efforts, SCE learned that TOPD detection depends on seasonal factors. For instance, factors such as current transformer (CT) ¹⁷⁶ ratios and seasonal loading profiles may impact the technology’s ability to sense an open phase (generally more loading is better for TOPD detections).

The TOPD sensitivity is dependent upon the available Transmission line loading and CT ratios. If the minimum arming requirements are met, the TOPD is expected to successfully detect an Open Phase condition. To date, TOPD logic is mostly accurate except for a few false positive alarms. SCE is continuing to refine its TOPD logic to improve detection accuracy.

¹⁷⁶ The components used to monitor the Transmission lines are CTs. The TOPD scheme is a current-based algorithm and requires a minimum loading of current to be armed based on CT ratios. The higher the CT ratio, the more line loading that is required for the TOPD scheme to operate correctly.

8.1.8.1.3.3 Distribution Open Phase Detection (DOPD)

Settings to reduce wildfire risk

A Distribution Open Phase Detection (DOPD) scheme aims to detect open phase (broken conductor) conditions on the distribution system. The scheme focuses on reducing ignition risk associated with wire-down incidents for both bare and covered conductor systems, by allowing the protection system to isolate a separated conductor before the wire contacts the ground. SCE's detection scheme leverages existing recloser installations at circuit tie-points and pairs these devices with new high-speed radio installations (point-to-point communications) to detect a separated conductor. Once detected, an alarm operation is rapidly deployed to an upstream source recloser. The pilot effort also helps SCE understand the potential for additional circuit outages related to the increased sensitivity of this protection system.

Analysis of reliability/safety impacts for settings the electrical corporation uses

DOPD settings have been vetted through extensive Power System Computer-Aided Design simulations and RTDS to ensure that DOPD settings deployed will respond correctly to normal system transients and reliably detect for open phase conditions.

Criteria for when the electrical corporation enables the settings

DOPD is in the pilot stage and is engineered to provide alarm indication only. If DOPD is successful, then SCE's grid operations will work to identify how such devices should be used (e.g., whether deployed to continuously monitor or in response to certain conditions) and incorporate these protocols into relevant standard operating bulletins.

Operational procedures for when the settings are enabled

As the deployment is still in the pilot phase, there are no specific actions required for DOPD alarms at this time. Since DOPD alarms are integrated with the monitoring systems for SCE's grid operations, if the DOPD alarms then the grid operations team will determine next steps, e.g., verifying the alarm and determining the appropriate response. If an actual open phase condition results in a faulted event, SCE has procedures in place for system restoration to respond to the fault.

The number of circuit miles capable of these settings

DOPD can be deployed on all mainline circuits that are solidly grounded and have a high-speed communication channel.

An estimate of the effectiveness of the settings

The DOPD scheme is intended to successfully detect Open Phase conditions for its zone of protection. If successful at detecting open phase conditions and isolating lines prior to the lines contacting ground, the DOPD system is expected to reduce ignition probability. The success rate for detecting open phase conditions and isolating lines in the required time is still under review. Evaluation includes: (1) Ability to identify and isolate an open phase condition within 1.2 seconds; ¹⁷⁷ (2) Reduction in number of energized wire-down events; (3) System reliability impacts from false detections with an operational OPD scheme; and (4) Costs for broad scale deployment of OPD systems.

¹⁷⁷ Using the freefall equation, 1.2 seconds is the estimated time it would take for a Distribution conductor to hit the ground after separating.

8.1.8.2 Grid Response Procedures and Notifications

The electrical corporation must provide a narrative on operational procedures it uses to respond to faults, ignitions, or other issues detected on its grid that may result in a wildfire including, at a minimum, how the electrical corporation:

- *Locates the issues*
- *Prioritizes the issues*
- *Notifies relevant personnel and suppression resources to respond to issues*
- *Minimizes/optimizes response times to issues*

Locates the issues detected

Identification of issues detected on the grid can come from a number of sources, including analysis of meter data, HD cameras, customer calls, circuit patrols (including PSPS pre- and post-event patrols), and grid monitoring equipment.

Prioritize issues detected

Prioritization depends on severity of issue and the circumstances of the event, e.g., a fault in HFRA during a fire weather threat (FWT) period may be prioritized over less potentially severe issues. Public safety issues (such as wires down, 911 emergencies) are typically prioritized first, followed by reliability/significant customer issues, then power quality related (voltage problems, etc.). However, prioritization of such matters would still depend on circumstances, including whether there is an immediate safety issue present, and typically reviewed at our dispatch operations centers.

For protection equipment, such as RARs, SCE follows SOB 322 procedures to prioritize the issues identified.

For fires detected through SCE's HD cameras, SCE will map the location of the fire and conduct a fire threat assessment related to SCE's infrastructure. SCE will prioritize threats based on proximity to bulk power, distribution lines, generation facilities, and public assets at risk, as these will have the greatest downstream impacts to customers.

Notifies relevant personnel and suppression resources to respond to issues detected

In HFRA, SCE typically de-energizes and sends out a troubleman to patrol the entire line to find and address any damage prior to re-energization. In certain circumstances, SCE may send out a troubleman to investigate the line first, prior to making any decisions about de-energization.

For an energized wire down detected by smart meters, such as through Meter Alarm Down Energized Conductor (MADEC), the alerts are sent to a switching center, which will take appropriate steps prior to de-energizing the line. For Primary Issue Alerts,¹⁷⁸ SCE sends a troubleman to investigate the issue.

Furthermore, for fires and other emergencies, SCE's Public Safety Partners are already integrated with the same HD camera networks and email alerts as SCE for fires in their areas. SCE works with responding

¹⁷⁸ Primary Issues Alerts are system-generated alerts that notify SCE's grid operations about possible primary issues based on meter exception data and SCE connectivity information.

fire agencies to coordinate emergency response, damage assessment, and electrical service restoration. SCE also provides year-round standby funding to Orange County, Los Angeles County, and Ventura County to be able to use helitankers to aid with fire suppression in SCE's service area.

For PSPS, SCE will send out pre- and post-event patrols to monitor the lines for any hazards prior to re-energization.

Minimizes/optimizes response times to issues detected

SCE works to ensure that enough troublemen are assigned to cover each area to lower response times. This may include, for example, assigning more troublemen to report to districts with a higher frequency of events and obtaining additional resources when needed (e.g., from adjacent sectors or from other personnel). For wire-downs, SCE typically measures the response time from the time of the call to the time of arrival at the location.

Circuit patrols also carry some limited fire suppression resources in case of sparks or ignitions discovered during a patrol performed pursuant to SOB 322.

For fires, SCE has a 24-7 Watch Office that monitors fires and coordinates with SCE's Grid Control Center to advise of any fire threats to the bulk power system. SCE's Fire Management organization will also reach out to the troublemen at the affected District(s) to provide liaison support, such as coordination for potential de-energizations and to provide detailed information about the fire.

For PSPS events, SCE will assess where to pre-stage staff resources prior to an inclement weather event. SCE also deploys CCVs to areas where an extended outage is anticipated/experienced.

8.1.8.3 Personnel Work Procedures and Training in Conditions of Elevated Fire Risk

The electrical corporation must provide a narrative on the following:

- *The electrical corporation's procedures that designate what type of work the electrical corporation allows (or does not allow) personnel to perform during operating conditions of different levels of wildfire risk, including:*
 - *What the electrical corporation allows (or does not allow) during each level of risk*
 - *How the electrical corporation defines each level of wildfire risk*
 - *How the electrical corporation trains its personnel on those procedures*
 - *How it notifies personnel when conditions change, warranting implementation of those procedures*

Training personnel performing high risk grid operating procedures in elevated fire conditions is necessary to promote sound decision-making and to reduce the chance of utility-associated ignitions. SCE has implemented work procedures that outline the necessary steps to mitigate ignitions associated with crews and equipment in HFRA and empower qualified employees to request temporary de-energization of a line or line segment. These procedures also contain provisions which restrict or delay field work when conditions call for such action. Non-emergency/routine work involving hot work activities shall be cancelled when working on or near circuits under consideration for or de-energized due to a PSPS event. SCE also provides these employees with the training necessary to safely perform

these activities. All personnel responses to issues on the grid are subject to SOB 322 operating restrictions in HFRA and PSPS Outages, which are captured by the Hazard Event Restriction and Management Emergency System (HERMES) application within SCE's Grid Management System (GMS). The HFRA Hot Work Restriction and Mitigation Measures program applies to both SCE employees and contractors and is intended to reduce their risk of causing an ignition during the normal course of work in HFRA when the weather and fuel conditions are more susceptible to fire ignitions.

SCE provides annual training to all field personnel (both employees and contractors) performing wildfire mitigation activities, patrols, and live field observations, which includes all updates to SOBs, which encompass operating protocols, remedial actions, communication and notification protocols, ratings and limits of lines and equipment, and system protection schemes. In addition, the training includes PSPS Operating Protocols, PSPS Decision-Making Tool Enhancements, Patrolling and Live Field Observation for field operations, and Field Operations Tool Training. This training will be refreshed for all field personnel performing the same types of patrols in 2023, which includes both experienced and new resources.

SCE will continue to provide training to field personnel prior to every wildfire season, as additional resources are onboarded every year that will need to be trained. The annual training will include updates to all SOBs and any updates in work restriction procedures. SCE continues to refine its training program based on feedback from field employees and its QC program.

The electrical corporation's procedures regarding deployment of firefighting staff and equipment (e.g., fire suppression engines, hoses, water tenders, etc.) to construction and/or electrical worksites for site-specific fire prevention and ignition mitigation during on-site work

When SCE crews perform construction and maintenance work in the field, especially if it is considered "hot work," there is a small chance of generating sparks, arcs or incandescent particles. "Hot work" is defined as activities that are capable of initiating a fire or generating potential ignition sources. SCE and contract crews performing this work are equipped with basic fire mitigation and suppression tools.

SCE's HFRA Hot Work Restriction and Mitigation Measures program contains provisions to mitigate crew caused ignitions and are in effect whenever performing hot work activities in SCE's HFRA's, with limited exceptions. The program requires SCE and contract crews performing hot work activities to be equipped with basic fire mitigation and suppression tools with the goal of preventing ignitions and rapidly responding to incipient stage ignitions should one occur during the normal course of their work in the field.

SCE performed benchmarking studies regarding dedicated fire suppression resources and services with other utility companies and determined that the number and size of ignitions first encountered by field crews did not support pursuing professional, private firefighting resources at this time. SCE will continue using its existing HFRA Hot Work Restriction and Mitigation program and related protocols that are in place to help prevent crew or equipment caused ignitions, and in the event of an ignition, the crews will use their equipment, such as fire extinguishers, shovels, and/or rakes, to put out incipient stage fires that could occur during the course of their activities in the field. SCE will also continue to monitor the risks posed by ignitions first encountered by its field crews and consider professional firefighting crews as an option in future iterations of its WMP.

8.1.9 Workforce Planning

In this section, the electrical corporation must report on qualifications and training practices regarding wildfire and PSPS mitigation for workers in the following target roles:

- *Asset inspections.*
- *Grid hardening.*
- *Risk event inspection.*

For each of the target roles listed above, the electrical corporation must:

- *List all worker titles relevant to the target role.*
- *For each worker title, list and explain minimum qualifications, with an emphasis on qualifications relevant to wildfire and PSPS mitigation. Note if the job requirements include:*
- *Going beyond a basic knowledge of GO 95 requirements to perform relevant types of inspections or activities.*
- *Being a “Qualified Electrical Worker” (QEW). If so, define what is required by the electrical corporation for it to consider a worker to be a QEW in terms of certifications, qualifications, experience, etc.*
- *Report the percentage of electrical corporation and contractor full-time employees (FTEs) in the target role, with specific job titles.*
- *Report plans to improve qualifications of workers relevant to wildfire and PSPS mitigation work. The electrical corporation must explain how it is developing training programs that teach electrical workers to identify hazards that could ignite wildfires.*

SCE summarizes the applicable information in the tables below for each of the target roles identified. Full time employee (FTE) figures represent counts and percentages as of month-end November 2022 and include SCE and contractor field workers relevant to each target role. It is important to note that worker counts can fluctuate throughout the year depending on work required, resource availability, etc., particularly with contract workers. Below each table, SCE provides a more detailed description of the qualifications for each role, as well as discussion on training and plans to improve worker qualifications.

8.1.9.1 Target Role: Asset Inspections

SCE performs detailed inspections of SCE’s overhead distribution and transmission electric system in its HFRA that meet and exceed compliance requirements. For details on SCE wildfire-related inspection programs, please see Section 8.1.3

SCE performs aerial and ground detailed inspections of its transmission and distribution assets to identify hazards that could lead to safety and reliability issues. SCE uses employees and contractors to take high-definition imagery of assets from the air, either via helicopter or unmanned aircraft system (UAS). In some cases, helicopters will also collect LiDAR data.

SCE Aircraft Operations employs a rigorous aviation vendor qualification audit to determine a

prospective aviation vendor's suitability to provide aviation services for SCE. Appropriate Federal Aviation Administration (FAA) certifications¹⁷⁹ are a basic conditional check during aviation audits. Only aviation vendors approved under this process are eligible for SCE contracts involving aviation activities.

SCE uses employee and contract Inspectors to perform ground and aerial inspections. These Inspectors identify structural issues that may require possible remediations based on these inspections and create a notification.

Our worker qualifications and training for Asset Inspections will evolve and adapt in accordance with any future changes to our inspection programs, designs, and operational practices.

Table 8-9 details the worker titles and associated statistics pertaining to Asset Inspections. For purposes of this table and target role, "Special Certification Requirements" includes: Qualified Electrical Worker (QEW),¹⁸⁰ FAA Certification and Infrared Thermographer Level III.¹⁸¹

¹⁷⁹ FAA certification required for helicopter pilots are 14 CFR 61, 91 and 133; FAA certification required for UAS pilots is 14 CFR 107 or higher. FAA certification is not required for UAS observers.

¹⁸⁰ A Qualified Electrical Worker (QEW) is an individual who has a minimum of two years' training and experience with exposed high voltage circuits and equipment and demonstrated familiarity with the services to be performed and the hazards involved. In addition, for roles where it is applicable, SCE specifies in its contracts with vendors that the contractors at a minimum should meet the qualifications for a QEW as defined by the International Brotherhood of Electrical Workers (IBEW) Local No 47. SCE also specifies that contractors that perform Journeyman Lineman tasks on SCE's Distribution system must be certified "Journeyman Linemen" as determined by criteria set forth by IBEW Local No 47.

¹⁸¹ A Level III thermographer is primarily a thermography program manager who writes the company's written predictive maintenance/inspection practices, develops the test procedures and severity criteria, determines how often equipment should be inspected, and calculates the return on investment the thermography program is providing. By completing this advanced infrared training, a Level III thermographer can provide guidance to Level I and II certified personnel. The Level III thermographer is the resource to consult when repeat equipment problems necessitate a review of operating and maintenance procedures or involve a redesign of equipment.

Table 8-9 - Workforce Planning, Asset Inspections

Worker Title	Minimum Qualifications for Target Role	Special Certification Requirements	Electrical Corporation % FTE Min Quals ¹⁸²	Electrical Corporation % Special Certifications ¹⁸³	Contractor % FTE Min Quals ¹⁸²	Contractor % Special Certifications ¹⁸³	Reference to Electrical Corporation Training/Qualification Programs
ELECTRICAL SYSTEM INSPECTOR	See Below	N/A	40.6%	N/A	34.7%	N/A	See ESI Training in Table 8-9-1, "New Electrical System Inspector (ESI) Training " and "Existing ESI Inspection Training"
JOURNEYMAN TRANSMISSION/DISTRIBUTION LINEMAN	See Below	QEW	19.8%	100%	25.6%	100%	See Training for Aerial Inspection in Table 8-9-1, "Aerial Inspection Training"
PATROLMAN	See Below	QEW	29.5%	100%	0%	N/A	See below
HELICOPTER PILOT	See Below	FAA Certified	3.6%	100%	0%	N/A	See below
SENSOR OPERATOR	See Below	N/A	1.5%	N/A	0%	N/A	See below
GENERATION: TECHNICIAN, HYDRO ELECTRICIAN & INSTRUMENT CONTROL /ICE TECHNICIAN	See Below	QEW	1.0%	100%	0%	N/A	See below
GENERATION: HYDRO FOREMAN ELECTRICIAN & INSTRUMENT CONTROL TECHNICIAN /FOREMAN, ICE TECHNICIAN	See Below	QEW	2.0%	100%	0%	N/A	See below
GENERATION: OPERATOR, CHIEF HYDRO STATION	See Below	N/A	1.0%	N/A	0%	N/A	See below
GENERATION: HYDRO OPERATOR MECHANIC /PLANT EQUIPMENT OPERATOR	See Below	N/A	1.0%	N/A	0%	N/A	See below
UAS PILOT	See Below	FAA Certified	0.0%	N/A	17.6%	100%	See below
UAS OBSERVER	See Below	N/A	0.0%	N/A	17.6%	N/A	See below
INFRARED THERMOGRAPHER	See Below	N/A	0.0%	N/A	2.8%	N/A	See below
INFRARED GENERAL MANAGER THERMOGRAPHER	See Below	Infrared Thermographer Level III	0.0%	N/A	0.6%	100%	See below
AERIAL DESKTOP FOREMAN	See Below	QEW	0.0%	N/A	1.1%	100%	See below
			100%		100%		

¹⁸² "% of FTE Min Quals" column = # of SCE Workers in each Worker Title / Total # of SCE Workers in the Table. The same logic applies for Contractor.

¹⁸³ "% Special Certification" column = # of SCE workers in that Worker Title that have the special certification / total number of SCE workers in that Worker Title. The same logic applies for Contractor.

General Minimum Qualifications:

Workers who conduct detailed transmission, distribution overhead (or underground) and aerial electrical inspections must have knowledge of the basic uses and functions of electrical equipment, hand tools, power tools, techniques in performing electrical system inspections and repairs. Workers must understand the fundamentals of electric circuitry and operation of electrical equipment. Further, workers must understand SCE standards, policies and procedures, and basic GO 95 requirements.

A Qualified Electrical Worker (QEW) is an individual who has a minimum of two years' training and experience with exposed high voltage circuits and equipment and demonstrated familiarity with the services to be performed and the hazards involved. In addition, for roles where it is applicable, SCE specifies in its contracts with vendors that the contractors at a minimum should meet the qualifications for a QEW as defined by the International Brotherhood of Electrical Workers (IBEW) Local No 47. SCE also specifies that contractors that perform Journeyman Lineman tasks on SCE's Distribution system must be certified "Journeyman Linemen" as determined by criteria set forth by IBEW Local No 47.

Additional Minimum Qualifications:

ELECTRICAL SYSTEM INSPECTOR: Responsible for performing inspections of distribution poles and equipment and must pass the required Edison Electric Institute (EEI) aptitude test as well as have the ability to obtain and maintain a California driver's license. Inspectors must also have knowledge of: Basic electricity and electrical distribution principles; computer programs and email systems; company work rules, regulations and policies, construction methods, procedures, and standards; SCE's Accident Prevention Manual and safe work practices; and the motor vehicle code.

JOURNEYMAN TRANSMISSION/DISTRIBUTION LINEMAN: Responsible for performing construction and maintenance work on overhead and underground facilities. Journeyman linemen are QEWs and must have working experience as a lineman or groundman and graduated from SCE's apprenticeship program and have working knowledge of SCE's Accident Prevention Manual. Linemen must also have successfully passed a pre-hire physical assessment. Skills and abilities required by this job are of a level normally acquired by completion of job-related high school courses and the apprenticeship program for Lineman.

PATROLMAN: Responsible for patrolling, inspecting, and ensuring assigned transmission lines are properly maintained. Transmission Senior Patrolmen are QEWs and must have knowledge of: equipment, tools, techniques, and methods employed in the construction, installation, maintenance, and repair of overhead line facilities, roads, trails, and rights-of-way (ROWS); stresses, strains, and rigging; safety regulations; capabilities and limitations of insulator washing equipment; transmission overhead and underground circuitry and switching; and SCE's Accident Prevention Manual. The knowledge, skills, and abilities required for this job are of a level comparable with those normally acquired through a high school education, supplemented by technical study, extensive training, and experience as a journeyman, patrolman or lineman.

HELICOPTER PILOT: Responsible for conducting routine and complex missions including power line patrols, passenger transports, photo flights, positioning flights, snow surveys, and external load missions, as required. Pilots are FAA certified and must also have knowledge of: all applicable governmental aviation regulations, company policies, procedures, practices, work instructions, and FAA Regulations, 14 CFR Part 91 & 133. The knowledge, skills, and abilities required of this job are of a level comparable with those with a high school education and a minimum of 3,000 hours of helicopter pilot in command and 250 hours pilot in command above 5,000 feet. Pilots must also possess and maintain a Class II FAA Medical Certificate and a valid California driver's license.

SENSOR OPERATOR: Responsible for remote sensing mission planning, sensor configuration, and understanding complex sensing system technology from data collection to product hand off. The knowledge, skills, and abilities required for this job include operating and maintaining complex sensing equipment as part of an aircrew onboard a helicopter; and understanding the evolution of advanced three-dimensional geospatial tools and analysis as this has a direct bearing on the collection of data with remote sensing equipment.

GENERATION: HYDRO ELECTRICIAN & INSTRUMENT CONTROL TECHNICIAN/ICE TECHNICIAN: Responsible for maintaining, repairing and installing computerized control systems. Must have knowledge of: Basic power plant system operations; electrical and pressure instruments and devices and functions as related to power plant systems; tools, methods, materials and techniques used in repair, adjustment and testing, including computerized tooling and interface hardware and software; theory of electricity, mechanics and instruments; materials, methods, practices and tools used in installation and maintenance; principles of physics and advanced mathematics; county and state electrical code; SCE's Accident Prevention Manual and environmental regulations and procedures. The knowledge, skills, and abilities for this job are of a level comparable to those normally acquired through a high school education, additional technical study, and knowledge of complex digital and analog control systems and equipment; plus, experience typically attained in a similar technical field or journeyman electrician.

GENERATION: HYDRO FOREMAN ELECTRICIAN & INSTRUMENT CONTROL TECHNICIAN /FOREMAN, ICE TECHNICIAN: Supervises and oversees repairs and installations of control systems. Must have knowledge of: Basic power plant system operations; electrical and pressure instruments and devices and functions as related to power plant systems; tools, methods, materials and techniques used in repair, adjustment and testing, including computerized tooling and interface hardware and software; theory of electricity, mechanics and instruments; materials, methods, practices and tools used in installation and maintenance; principles of physics and advanced mathematics, county and state electrical code; SCE's Accident Prevention Manual, safety rules and regulations, environmental regulations and procedures. The knowledge, skills, and abilities for this job are of a level comparable to those normally acquired through a high school education, additional technical study, and knowledge of complex digital and analog control systems and equipment; plus, experience typically attained in a similar technical field or journeyman electrician.

GENERATION: CHIEF HYDRO STATION OPERATOR: Supervises and controls the operation of hydroelectric generating stations and related equipment; dams, intakes, forebays, spillways, and water conduits to assure efficient loading and operations of the Hydro Division plants. Must have knowledge of: Fundamentals of electricity, basic Alternate Current-Direct Current (AC-DC) theory, computer theory and language; hydraulics and the principles of physics; dispatching, system operating and water management procedures and operator's duties; general electrical and mechanical maintenance; overall plant facilities and operating characteristics; and SCE's Accident Prevention Manual. The knowledge, skills, and abilities required for this job are of a level comparable to those normally acquired through a high school education and extensive progressive training and experience in hydro generating plant operations.

GENERATION: HYDRO OPERATOR MECHANIC/PLANT EQUIPMENT OPERATOR: Operates attended and unattended hydroelectric generation stations; dams, intakes, fore bays, spillways, and water conduits; and related electronic, electrical, mechanical, hydraulic and pneumatic equipment. Must have knowledge of: electrical, hydraulic, pneumatic and mechanical equipment; basic computer theory and language, system construction, capacity, limitation, theories of operation and operating procedures; plant design and equipment locations, valve configurations, and normal range of flows, temperatures, levels, methods to clear equipment; tools, safety rules, equipment and systems malfunctions; reporting procedures and practices, maintenance procedures and practices; and electrical and mechanical prints, rigging standards, generation plant terminology and nomenclature. The knowledge, skills, and abilities required of this job are of a level comparable to those normally acquired through a high school education and considerable experience operating and maintaining a generation facility.

UAS PILOT: Responsible for conducting UAS missions, including preflight inspections, specific aircraft and ground control station checks, maintenance, and operational safety activities. Must possess a current and valid Federal Aviation Remote Pilot Certificate (14 CFR 107 or higher, as appropriate) and be proficient in operating each UAS model appropriate to the current pending mission profile. The knowledge, skills, and abilities required for this job include the capability of mission planning relative to the appropriate level of mission complexity and federal certification.

UAS VISUAL OBSERVER: A visual observer is considered an optional crewmember for most operations under 14 CFR Part 107. There are, however, more complex instances in which at least one visual observer will be required by SCE UAS Operations. The UAS Operator and UAS Observer are responsible for functioning as a crew in a safe, responsible and coordinated manner.

INFRARED THERMOGRAPHER: Responsible for performing thermal inspections of poles and equipment. Must be certified as a level-one thermographer and possess 40-hours minimum of field and office training and pass an associated written exam administered by Osmose or an outside agency. The knowledge, skills, and abilities required for this job include a basic understanding of electrical and communication infrastructure and GO 95. Additionally, level-one thermographers are provided specific training on the cameras used for the patrol and capture of IR images used for SCE's reports.

INFRARED GENERAL MANAGER THERMOGRAPHER: Responsible for training and managing of level-one thermographers and must be certified as a level-three thermographer. Minimum qualifications include the level-one thermographer requirements, plus an additional 32-hour training program and certification exam administered by an outside agency. Level-three thermographers are also responsible for the creation and evaluation of reports containing IR imagery; designing and implementing written procedures; and understanding regulatory requirements with a focus on safety and compliance. Level-three thermographers are trained and certified through the IR Training Center systems company.

AERIAL DESKTOP FOREMAN: Supervise work performed by desktop inspectors to help ensure the work is performed qualitatively. Oversees and approves timesheets related to hours worked. Requires knowledge of SCE Standards relating to construction and Inspections. Skills and abilities required for this job are of a level comparable with those normally acquired through a high school education and extensive training and experience as a Journeyman Lineman.

Training and plans to improve worker qualifications:

To facilitate asset inspection work, SCE implements training for those performing inspections. This technical training prepares workers to perform their jobs safely, comply with regulatory requirements and laws, maintain system reliability, and meet the demands of new technology. SCE will continue to deploy new work methods and technologies in support of wildfire activities. SCE's risk-informed inspection strategy involves using new tools to help perform field inspections, modify inspection checklists to evaluate asset conditions, and establish new processes. These new technologies and work methods require the creation of new training material and deployment of the training to SCE employees. In addition to technical competency, this training must provide education and clarification on new procedures and standards, building upon lessons learned obtained from field activities. SCE also conducts training for workers in the Risk Event Inspection role related to its wildfire mitigation and PSPS work, which is described in Section 8.1.9.3 Table 8-11 below.

Separately, SCE surveys its workers to identify where more focused training may be needed. These surveys provide information at the employee and supervisor level, which allows SCE to identify specific areas where individuals may benefit from additional training.

As technical aspects (e.g., process, technology, or tool changes) of SCE's various inspection programs change, SCE will provide the requisite training to those who will be performing inspections. Further, SCE will update its training program based on lessons learned and provide refresher training as necessary to communicate changes in protocols. For example, SCE continuously adds or updates material as supplements to its training for Electrical System Inspectors (ESIs) who perform inspections through SCE's Overhead Detail Inspection and/or HFRI programs, as shown in Table SCE 8-01.

SCE requires all new ESIs to take the comprehensive training identified below. In addition, all ESIs take regular refresher training every 12 months to incorporate new processes, procedures, and lessons-learned relevant to inspection practices; and engage in a comprehensive quality and consistent program to help ensure accurate and consistent inspections. The program consists of four major components all focused on improving inspection quality and to help ensure inspection results are consistent.

Table SCE 8-01 -SCE Training Courses Specific to Asset Inspections

Course Name	Course Description
<p>New Electrical System Inspector(ESI) Training</p> <ol style="list-style-type: none"> 1. Introduction 2. Safety 3. Tools 4. Equipment Recognition 5. Clearances 6. Detailed Inspection 7. Inspect App 8. Notifications 9. Repairs 10. Private Property 11. Quality Assurance (QA) 	<ol style="list-style-type: none"> 1. Describe GOs 95 & 165, explain purpose of inspection programs 2. Requirements of Inspection safety for ESIs, guidelines for PPE, safe driving & parking 3. Identify tools, proper maintenance of tools, how to use tools safety 4. Identify common Distribution equipment and purpose of equipment. How to identify damage 5. Measure & report clearances that legally define basic minimum allowable vertical clearance values 6. Purpose & duties regarding inspections, steps of the inspection method, describe P1 conditions, purpose of Annual Grid Patrol 7. Layout of survey questions by category, practice answering surveyquestions on iPad 8. Categorize different types of Priority conditions, how & when todocument notifications, how to make changes in the field tool 9. Precautions to take prior to making repairs, proper actions to takefor repairs they cannot make 10. Outline responsibilities of ESI, describe access issues an ESI faces and how to approach and remedy 11. At the end of this module ESI’s will be able to explain elements &purpose of QA Program and how it applies to ESI 12. Explain their part in the inspection, repair and reporting of overhead structures 13. Training refresher annually
<p>Existing ESI Inspection Training</p>	<ol style="list-style-type: none"> 1. ODI Survey App Reference Guide (Responding to Survey Questions) 2. Inspection App User Guide 3. ESI Help Guide 4. Laser Rangefinder – TruePulse 360 Quick Start Manual

	<ol style="list-style-type: none"> 5. Overhead Detail Inspections (ODI) Covered Conductor Training 6. New ESI Training (Details above)
Aerial Inspection Training	<ol style="list-style-type: none"> 1. Identify common Distribution equipment and purpose of equipment. How to identify damage 2. Purpose & duties regarding inspections, steps of the inspection method, describe P1 conditions 3. Layout of survey questions by category, practice answering survey questions on Inspection Application 4. Categorize different types of Priority conditions, how & when to document notifications 5. Outline responsibilities of Aerial Inspectors, including photos capturing misalignment, for example, blurriness, oblique, and improper contrast photos. 6. At the end of this training, Aerial Inspectors will be able to identify appropriate level of priority risk-based Notifications. 7. Explain their part in the inspection and reporting of overhead structures
Transmission Inspection Training	<ol style="list-style-type: none"> 1. Overview of program, including schedule, deadlines and targets 2. Layout of survey questions, with emphasis on new questions or question changes 3. Outline responsibilities of Transmission Ground Inspectors

8.1.9.2 Target Role: Grid Hardening

SCE’s Grid Hardening activities focus on implementing grid infrastructure that mitigates the risks of ignitions associated with utility equipment. This includes several activities, such as deploying covered conductor, undergrounding of overhead lines, installing system automation equipment, remediating issues with long conductor spans, replacing old and potentially faulty equipment, and more. For more information on SCE’s Grid Hardening programs, please see Section 8.1.2.

Table SCE 8-10 details the field worker titles and associated qualifications pertaining to Grid Hardening.

Table 8-10 - Workforce Planning, Grid Hardening¹⁸⁴

Worker Title	Minimum Qualifications for Target Role	Special Certification Requirements	Electrical Corporation % FTE Min Quals¹⁸²	Electrical Corporation % Special Certifications¹⁸³	Contractor % FTE Min Quals¹⁸²	Contractor % Special Certifications¹⁸³	Reference to Electrical Corporation Training/Qualification Programs
TRANSMISSION /DISTRIBUTION APPRENTICE LINEMAN	See below	N/A	15.1%	N/A	17.3%	N/A	See Distribution Apprentice Lineman program in Table 8-02 and Transmission Apprentice Lineman training in Table 8-03
JOURNEYMAN TRANSMISSION /DISTRIBUTION LINEMAN	See below	QEW	32.8%	100%	41.5%	100%	See below
FOREMAN	See below	QEW	16.4%	100%	18.8%	100%	See below
GROUNDMAN	See below	N/A	20.2%	N/A	21.7%	N/A	See below
SPLICER	See below	QEW	3.0%	100%	0.7%	100%	See below
SUBSTATION MAINTENANCE ELECTRICIAN	See below	QEW	5.7%	100%	0.0%	N/A	See Substation Electrician Apprentice Program (SEAP) in Table 8-04 and Acting Operator Training in Table 8-06
TEST TECHNICIAN	See below	QEW	6.6%	100%	0.0%	N/A	See Substation Test Technician Program in Table 8-05 and Acting Operator Training in Table 8-06
GENERATION: TECHNICIAN, HYDRO ELECTRICIAN & INSTRUMENT CONTROL /ICE TECHNICIAN	See below	QEW	0.1%	100%	0.0%	N/A	See below
GENERATION: FOREMAN, HYDRO ELECTRICIAN & INSTRUMENT CONTROL TECHNICIAN /FOREMAN, ICE TECHNICIAN	See below	QEW	0.1%	100%	0.0%	N/A	See below
GENERATION: HYDRO OPERATOR MECHANIC /PLANT EQUIPMENT OPERATOR	See below	N/A	0.0%	N/A	0.0%	N/A	See below
			100.0%		100.0%		

¹⁸⁴ The SCE worker population identified in this Table overlaps with the SCE worker population identified in Section 8.1.9.2 (Risk Event Inspections), as these FTE can perform both target roles.

General Minimum Qualifications: Workers are required to have knowledge of applicable Accident Prevention Manual rules, SCE standards, policies and procedures, GO 95/128; electrical theory and mechanical principals.

Additional Minimum Qualifications:

TRANSMISSION/DISTRIBUTION APPRENTICE LINEMAN: Knowledge of and proficiency in the principles of electricity and mechanics; characteristics of electrical AC and DC circuits; the connections of electrical apparatus; equipment, circuits and their functions; principles of physics and advanced mathematics. In addition, must possess knowledge of SCE's Accident Prevention Manual and proficiency in safe work practices, County and State Electrical Code; rigging practices; and proper and safe use of cleaning agents. The knowledge, skills, and abilities required for this job are of a level comparable with those normally acquired through courses taken in obtaining a high school education and considerable working experience in electrical repair work. Table SCE 8-02 and Table SCE 8-03 below details the associated training pertaining to the Distribution and Transmission Apprentice Lineman.

JOURNEYMAN TRANSMISSION/DISTRIBUTION LINEMAN: See qualifications of Lineman in Section 8.1.9.1.

FOREMAN: Oversee work performed by their crews and helps to ensure the work is performed safely. Requires knowledge of and proper use of approved tools, material, equipment, as applied to the construction, maintenance and repair of overhead and underground electrical systems. Skills and abilities required for this job are of a level comparable with those normally acquired through a high school education and extensive training and experience as a Journeyman Lineman.

GROUNDMAN: Assist with overhead and underground work as assigned. General knowledge of principles of electricity and mechanics; characteristics of electrical AC and DC circuits; and the connections of electrical apparatus; equipment, circuits and their functions. In addition, must possess knowledge of SCE's Accident Prevention Manual and safe work practices; rigging practices; and proper and safe use of tools and cleaning agents. The knowledge, skills, and abilities required for this job are of a level comparable with those normally acquired through courses taken in obtaining a high school education.

SPLICER: Responsible for all types of power cable and major electrical equipment and related facilities. Must have knowledge of and proficiency in electrical theory and shop mathematics; methods, practices, and procedures; tools, instruments, equipment and materials; SCE's Accident Prevention Manual and safety rules; established codes and standards; and the nomenclature and functions of parts necessary for installation, replacement, inspection, servicing, overhauling and repairing overhead and underground lines, electrical equipment and related facilities. The knowledge, skills, and abilities required for this job are of a level comparable with those normally acquired through experience as an Electrical Helper or Apprentice Electrician.

SUBSTATION MAINTENANCE ELECTRICIAN: Responsible for the installation, maintenance, and repair of high voltage electrical substation apparatus. Utilizes various meters, testing and diagnostic devices, performs routine testing, troubleshoots equipment problems, performs wiring of substation equipment, dismantles and overhauls CBs, transformers, regulators, and associated substation equipment. Qualification includes completion of the Substation Apprentice Electrician Program and Substation Operators School. The knowledge, skills, and abilities required by the job are of a level comparable with those normally acquired through courses taken in obtaining a high school diploma and the training and experience required to successfully complete the apprentice electrician program.

TEST TECHNICIAN: Responsible for programs and tests, inspections, repairs, relay adjustments, instrumentation equipment, local controllers, pilot wire equipment, battery chargers, and associated devices for the protection, control, and indication of system equipment. Must be a qualified substation operator. The knowledge, skills, and abilities required for this job are normally acquired through completion of high school and/or formal training in electrical engineering, or experience with extensive comprehension of electrical theory and use of principles of electrical theory in actual performance.

GENERATION: HYDRO ELECTRICIAN & INSTRUMENT CONTROL TECHNICIAN/ICE TECHNICIAN: See qualifications of Hydro Electrician & Instrument Control Technician in Section 8.1.9.1.

GENERATION: HYDRO FOREMAN ELECTRICIAN & INSTRUMENT CONTROL TECHNICIAN FOREMAN/FOREMAN, ICE TECHNICIAN: See qualifications of Hydro Electrician & Instrument Control Technician Foreman in Section 8.1.9.1.

GENERATION: CHIEF HYDRO STATION OPERATOR: See qualifications of Chief Hydro Station Operator in Section 8.1.9.1.

Training and plans to improve SCE worker qualifications:

To facilitate grid hardening work, SCE implements training for SCE workers, such as those identified above. This technical training includes core technical training for working on the electric system, as well as specialized training on PSPS, HFRA, grid hardening, etc., and prepares workers to perform their jobs safely, comply with regulatory requirements and laws, maintain system reliability, and meet the demands of new technology. SCE will continue to deploy new work methods and technologies in support of wildfire activities. Wildfire activities may also require the use of new technology, such as situational awareness tools or information technology (IT). The use of new technology is usually accompanied by end-user training to help ensure the appropriate click-through of the application and accurate capture of data. New work methods also require the creation of new training material and deployment of the training to SCE employees. In addition to technical competency, this training will provide education and clarification on new procedures and standards, building upon lessons learned obtained from field activities. For example, these trainings can include Hot Sticks Training, Aerial

Construction Training, etc. SCE provides these trainings through ongoing efforts with existing employees and through its Apprenticeship programs for new employees, which is shown Table SCE 8-02 and Table SCE 8-03. In addition, SCE also provides training program to Substation Maintenance Technician and Test Technician, which is shown in Table SCE 8-04, Table SCE 8-05, and Table SCE 8-06. SCE also conducts training for workers in the Risk Event Inspection role related to its wildfire mitigation and PSPS work, which is described in Section 8.1.9.3 below.

Table SCE 8-02 - SCE Training Courses Specific to a Distribution Apprentice Lineman

Course Name	Course Description
<p>1st Step Distribution Apprentice Lineman Training is comprised of 13 modules</p> <ol style="list-style-type: none"> 1. Orientation 2. Climbing Basics 3. Grounding 4. Guying 5. Meter Panels 6. OH Services 7. Pole Framing 8. Pole Top Rescue 9. PPE and Safety 10. Primary Conductors 11. Rigging Basics 12. Secondary Conductors 13. Streetlights 	<p>Basic Climbing Climbing and Pole Top Rescue, and safety & equipment basics.</p>
<p>2nd Step Distribution Apprentice Lineman Training is comprised of 14 modules</p> <ol style="list-style-type: none"> 1. Wire Banks 2. AC vs DC 3. Delta vs Wye 4. Ferroresonance 5. Interconnected Systems 6. Orientation 7. Ohms Law 8. Temp Grounding Devices 9. Transformer Design & Theory 10. Transformer Load Calcs 11. Transformer Nameplates 12. Polarity 13. Vectoring 14. Voltage Problems 	<p>Basic Theory Introduction to Electrical Theory, vectoring and Ferroresonance.</p>

Course Name	Course Description
<p>3rd Step Distribution Apprentice Lineman Training is comprised of 9 modules</p> <ol style="list-style-type: none"> 1. Orientation 2. UG Components 3. UG Conductors 4. UG Fuses 5. UG Grounding 6. UG Rules & Regulations 7. UG Structures 8. UG Switches 9. UG Transformer 	<p>Underground Underground equipment, rules, and procedures.</p>
<p>4th Step Distribution Apprentice Lineman Training is comprised of 13 modules</p> <ol style="list-style-type: none"> 1. Orientation 2. Ohms Law 3. Vectoring 4. Ferroresonance 5. Reclosers 6. Fuses 7. HV Testing & Phasing 8. Capacitor Banks & PF 9. Metering Theory 10. Voltage Regulators 11. RCS Theory 12. Ground Banks 13. PE Gear 	<p>Advanced Theory Application and deep dive of Electrical Theory. Equipment theory.</p>
<p>5th Step Distribution Apprentice Lineman Training is comprised of 9 modules</p> <ol style="list-style-type: none"> 1. Orientation 2. Fuses 3. 4kV Rubber Gloving 4. Hot Stick Basics 5. Armor Rods & Gins 6. Corner Pole Taps & Phasing 7. Double Dead-Ending 8. Hot Splicing 9. Hot Stick Skills 	<p>Step Hot Stick & Live line Tools Rubber gloving and hot sticking.</p>
<p>6th Step Distribution Apprentice Lineman Training is comprised of 25 modules</p> <ol style="list-style-type: none"> 1. Orientation 2. Safety Protocol 3. 6.6 Streetlights 	<p>Operations and troubleshooting.</p>

Course Name	Course Description
4. Capacitors 5. SOB 322 6. Remote Automatic Reclosers (RAR) 7. Remote Sectionalizing Recloser (RSR) 8. N-1 SOB 311 9. Event Response 10. Circuit Balancing 11. Circuit Maps 12. Clearances & No Test Orders 13. Co-Generation 14. Dist. Ops Responsibilities 15. Emergency Primary Trouble shooting 16. Fault Indicators 17. Fault Interrupters 18. Patrol Collector App 19. Metering ESR 20. PE Gear 21. RCS Switches – Operating 22. Secondary Trouble Shooting 23. Substation Entry & Logbook 24. Switching Procedures 25. Switching Techniques	

Table SCE 8-03 - SCE Training Courses Specific to Transmission Apprentice Lineman

Course Name	Course Description
1 st Step: Transmission Apprentice Lineman Training is comprised of 11 modules <ol style="list-style-type: none"> 1. Orientation 2. Grounding – Induction Mitigation 3. Induction – Guy Wires 4. Pole Climbing Basics 5. Grounding 6. Knife Safety 7. Rigging Basics 8. Guying 9. Pole Framing 10. Pole Top Rescue 11. Rigging 	Basic Climbing <ul style="list-style-type: none"> • Climbing and Pole Top Rescue, and safety & equipment basics. • Rigging Techniques. • Review of more in depth grounding, installing grounds and learning foreign grounds on various configurations. Hanging varying martials in various configurations.
2nd Step: Transmission Apprentice Lineman Training is comprised of 15 modules <ol style="list-style-type: none"> 1. Orientation 2. Grounding Review 3. Interconnected Systems 	Basic Electrical Theory Introduction to Electrical Theory, Transformers, vectoring.

Course Name	Course Description
<ol style="list-style-type: none"> 4. Ohm's Law 5. AC vs. DC 6. Transformer Design and Theory 7. Transformer Polarity 8. Transformer Nameplates 9. Vectoring 10. Delta Vs Wye 11. Transformer Load Calculations 12. Guying 13. Splicing <ol style="list-style-type: none"> 1. Guying 14. Basic Aerial Construction 	
<p>3rd step: Transmission Apprentice Lineman Is comprised of 10 modules</p> <ol style="list-style-type: none"> 1. Orientation 2. Daggett Orientation 3. Wood Poles and LWSPs 4. Tubular Steels Poles (TSPs) 5. Shotgun Splicing 6. Wire Stringing (Conductors) 7. Towers 8. Insulators 9. Hot Washing from a Truck 10. Working from Space Carts 	<ul style="list-style-type: none"> • Introduction to standard pole configuration and construction • Assemble tower sections. <p>Learn about insulators.</p>
<p>4th step: Transmission Apprentice Lineman Is comprised of 7 modules</p> <ol style="list-style-type: none"> 1. Cable Pulling 2. Cable Splicing 3. Risers 4. Terminations 5. UG Cable 6. UG Grounding 7. UG Systems Overview 	<p>Underground Learn underground equipment, rules, and procedures.</p> <p>Cable Learn to pull cable from vault to Riser, and installing and setting cable support grips</p>
<p>5th step: Transmission Apprentice Lineman Is comprised of 16 modules</p> <ol style="list-style-type: none"> 1. 4 kV Rubber Gloving 2. Avian Protection 3. Capacitor Banks 4. Change Out Insulators on Energized Lines 5. Distribution Risers 6. Double Dead Ending 7. Energize/De-energized Transformers 8. Fuses and Test Equipment 9. Hot Stick Basics 	<p>Rubber Gloving Use HV rubber gloves on energized 4kV lines. Change out insulators with energized lines. TS-5 and OH wiring, including inspection, testing, temporary grounding device, connecting primary taps.</p>

Course Name	Course Description
<ol style="list-style-type: none"> 10. Overhead Transformers 11. Primary Distribution Circuit Transfer 12. Protective Covers 13. Transformer Theory 14. Conductor Ties and Shunts 15. Incorporating the MGPN 16. Grounding Additions 	
<p>6th step: Transmission Apprentice Lineman Is comprised of 19 modules</p> <ol style="list-style-type: none"> 1. Orientation 2. Grid Operations 3. Substation Basics 4. Distribution Circuit Maps 5. Line Programming and Clearances 6. Circuit Field Phasing 7. Wood Pole Inspections 8. Steel Pole Inspections 9. Steel Pole and Tower Inspections 10. Pole and Tower Signs 11. Switch Installation Lead a Work Crew 12. Switch Repair and Maintenance 13. Underground Inspections 14. Underground Service Alerts (USAs) 15. On Job Training (OJT) 16. Pilot Wire 17. Helicopter Operations 18. OJT 19. Lead a Work Crew 	<ul style="list-style-type: none"> • Circuit Phasing • Switching • Submit Grid Ops and Distribution circuit maps changes <p>Learn how to lead crew</p>

Table SCE 8-04 - SCE Training Courses Specific to Substation Electrician Apprentices Program (SEAP)¹⁸⁵

Course Name	Course Description
<p>Step 1 of this program consists of 3 modules, OJT, and TPEs during a six-month time period:</p> <ol style="list-style-type: none"> 1. Safety 2. Clearances 3. Personal Grounding 	<p>At the end of this step, the apprentice will be able to:</p> <ul style="list-style-type: none"> • Perform switching in a substation under supervision • Take clearances under supervision • Apply personal grounds under supervision
<p>Step 2 of this program consists of 11 modules, OJT, and TPEs during a six-month time period:</p> <ol style="list-style-type: none"> 1. Pneumatics Hydraulics 2. Mechanical Concepts 3. Hot Washing 4. Rigging 5. Operating Heavy Equipment 6. Electrical Equipment Grounding 7. High Voltage Connectivity 8. Basic Test Instruments 9. Oil Handling 10. Gas Handling 11. Circuit Breaker Fundamentals 	<p>At the end of this step, the apprentice will be able to:</p> <ul style="list-style-type: none"> • Perform job setup and observe safety precautions during hot wash under supervision • Identify and use tools and fasteners • Tie knots • Inspect slings and shackles • Plan requirements for a given rigging job and operate heavy equipment under Supervision • Clean, bolt, and torque connections • Operate Microhmeter (Ductor), Megohmmeter (Megger), and Multimeters • Perform Dielectric Oil test • Draw DGA sample • Switch and Operate as a “Qualified Operator”

¹⁸⁵ SEAP is a 6-step (3-year) apprenticeship program for New-to-Role employees. The curriculum uses a blended learning approach, including instructor-led, web-based, and On-the-Job Training to provide the Substation Electrician apprentice with the skills and knowledge to install, repair, and maintain high voltage substation electrical equipment.

Course Name	Course Description
<p>Step 3 of this program consists of 5 modules, OJT, and TPEs during a six-month time period:</p> <ol style="list-style-type: none"> 1. CB Print Reading 2. CBA 3. Timing 4. Advanced CB's 5. Trouble Shooting 	<p>At the end of this step, the apprentice will be able to:</p> <ul style="list-style-type: none"> • Perform Ductor and Megger tests on CBs • Perform timing tests • Perform vacuum bottle tests • Install, setup, run and interpret basic CBA records • Perform gas and oil tests: test purity and moisture of SF6 gas; run gas reclaimer for SF6 breaker; run filter cart for CB oil • Perform CB Mechanical Maintenance using MM sheet and Internal Inspection using overhaul sheet under supervision <p>Troubleshoot CB problems under supervision</p>
<p>Step 4 of this program consists of 16 modules, OJT, and TPEs during a six-month time period:</p> <ol style="list-style-type: none"> 1. Substation Battery Systems 2. Electrical Checking 3. Electrical Equipment Grounding 4. Substation Print Reading 5. Disconnects and Switchers 6. Intro to Instrument Transformers 7. Pressure Relief Devices and Sudden Pressure Relays 8. Transformer Principles 9. Power Transformers Components, Core, Windings, and Insulation 10. Station Light and Power 11. Water in Paper (Transformers) 12. PTC Construction and Auxiliary Components (Enclose Tank, Cooling, Temp Rise Cooling Cases 13. Dissolve Gas Analysis 14. On-Line Monitoring 15. Transformer Connections 16. Auxiliary Control Circuit 	<p>At the end of this step, the apprentice will be able to:</p> <p>Work on hydraulic and pneumatic systems</p> <p>Ground station equipment to the ground grid</p> <p>Perform work on CT's, PTs, and SL&P</p> <p>Install, maintain, and test transformers and the auxiliary equipment under supervision</p> <p>Replace fuses</p> <p>Batteries (check voltage; check bad cells; make necessary connections; check battery charger)</p> <p>Perform Checking duties under Supervision</p>

Course Name	Course Description
<p>Step 5 of this program consists of 19 modules, OJT, and TPEs during a six-month time period:</p> <ol style="list-style-type: none"> 1. Capacitors 2. LTC Testing and Quality Pointers 3. LTC Maintenance 4. LTC Intro and Theory 5. DTA Record Transfer 6. Intro to Doble Bushings Testing 7. Dry Wall Calibrator 8. Ground Bank and Delta Zig Zag Testing 9. Doble Leakage Reactance Test 10. LTC Testing 11. Transformer Megger Testing 12. Brushing Name Plate 13. Oil Power Factor Test 14. Circuit Breaker Testing 15. Recommended Testing Voltage 16. Surge Arrestor 17. Transformer Testing Safety Protocol 18. TTR Set Up 19. WRM Vanguard Bridge Testing 	<p>At the end of this step, the apprentice will be able to:</p> <ul style="list-style-type: none"> Perform primary conductoring Perform secondary wiring Overhaul LTCs under supervision Installation, maintenance, and adjustment of switches and disconnects Overhaul regulators Balance, check and test shunt and series capacitors Apply covers and barriers Test A Bank Transformers and below <p>Employee will become a qualified electrical worker at the 2-year mark if all conditions are met</p>
<p>Step 6 of this program consists of 7 modules, OJT, and TPEs during a six-month time period:</p> <ol style="list-style-type: none"> 1. Coaching 2. Decision Making 3. Effective Communication 4. Evaluating 5. Listening 6. Memorable People Exercise 7. Mentoring 	<p>At the end of this step, the apprentice will be able to:</p> <ul style="list-style-type: none"> Perform duties of lead person on major job (e.g., order materials, assign positions on job, tailboard, direct personnel, and complete overhaul sheets).

Table SCE 8-05 - SCE Training Courses Specific to Substation Test Technician Program¹⁸⁶

Course Name	Course Description
<p>Session 1 of this program consists of 5 modules, OJT, and TPEs during a six-month time period:</p> <ol style="list-style-type: none"> 1. Print Reading 2. Phasor Analysis 3. Instrument Transformers 4. Protection Suite 5. Initial and Routine Testing 	<p>After completing this session, the Test Technician should be able to:</p> <ul style="list-style-type: none"> • Understand and describe basic circuits on electrical print diagrams and descriptive information • Calculate both voltage and current quantities for wye and delta three-phase transformer connections • Perform basic phasoring using a phasor wheel, and devise connections • Devise auxiliary current transformer connections • Perform the following tests on current and potential transformers • Create data bases • Develop a test plan for a CO relay • Use the Maintenance & Inspection Manual (MIM) to identify the necessary tests for each specific piece of equipment. • Use the necessary prints, including the one line for operation, wiring, and elementary diagrams. • Verify the equipment is labeled correctly • Verify a “bill of materials” form • Compare Station Elementary Diagrams against Wiring Diagrams to verify circuits or correct wire connections • Use Elementary Diagrams to prove or troubleshoot the operation of station equipment

¹⁸⁶ The Test Tech program is a 6-session (3-year) program for New-to-Role employees. The curriculum uses a blended learning approach, including instructor-led, web-based, and On-the-Job Training.

Course Name	Course Description
<p>Session 2 of this program consists of 4 modules, OJT, and TPEs during a six-month time period:</p> <ol style="list-style-type: none"> 1. Non-Directional Over Current Protection 2. Directional Overcurrent Protection 3. Power Transformer Theory and Calculations 4. Power Transformer Test and Connect 	<p>After completing this session, the Test Technician should be able to:</p> <ul style="list-style-type: none"> • Set and test a directional overload relay. IBC type suggested • Set and test CO and IAC type overload relays • Set and test a directional overload relay • Perform calculations for power transformers and transformer banks by using the appropriate formulas to determine results for: <ul style="list-style-type: none"> ○ Full load ○ Single-phase ○ Three-phase ○ Parallel operation ○ Impedance ○ Parallel operation ○ Short circuit current • Perform the following tests on a power transformer: <ul style="list-style-type: none"> ○ Transformer turns ratio ○ Winding resistance (bridge) ○ Insulation resistance (megger) ○ Impedance ○ High voltage Doble power factor tests using DTA software ○ In service • Calibrate, set, and test gauges, alarms, and controls • Calculate capacitor bank KVAR or MVAR ratings. Balance single capacitor units connected in series and parallel bank configurations. Connect, set, and test shunt capacitor controls.

Course Name	Course Description
<p>Session 3 of this program consists of 3 modules, OJT, and TPEs during a six-month time period:</p> <ol style="list-style-type: none"> 1. Bank Differential Relays 2. Bus Differential Relays 3. Metering 	<p>After completing this session, the Test Technician should be able to:</p> <ul style="list-style-type: none"> • Set and test a PVD electromechanical bus differential relay. • Set and test station metering. • Perform in-service readings and show the expected results on a test sheet for the following two and three-element watt/var metering: <ul style="list-style-type: none"> ○ Substation equipment ○ Distribution lines ○ Transmission lines • Set and test a bank differential relay • Perform in-service tests on a bank differential relay. • Properly connect, set, and test the general integrity of the alarms and annunciator equipment. <ul style="list-style-type: none"> ○ Plan initial testing of new installations; perform routine testing of in-service schemes; and trip test, adjust, and calibrate alarm relays.
<p>Session 4 of this program consists of 5 modules, OJT, and TPEs during a six-month time period:</p> <ol style="list-style-type: none"> 1. Distance Relays 2. Ground Relays 3. HCB Relays 	<p>After completing this session, the Test Technician should be able to:</p> <ul style="list-style-type: none"> • Set and test a directional ground relay. IBCG relay suggested. • Perform in-service tests on an IBCG relay • Set and test an HCB relay including the pilot wires and terminal equipment. • Perform in-service testing on an HCB pilot relay scheme. • Set and test a distance relay • Perform in-service tests on a distance relay • Set and test reclosing relays • Set and test automatic substation schemes for Stage I-V substations and automatic-service schemes. • Read and interpret the applicable AC and DC diagrams, flow charts, function

Course Name	Course Description
	<p>numbers, and symbols.</p>
<p>Session 5 of this program consists of 5 modules, OJT, and TPEs during a six-month time period:</p> <ol style="list-style-type: none"> 1. Prog. Logic Continued 2. LBFB and LBBU Relay Schemes 3. HCB Relays 	<p>After completing this session, the Test Technician should be able to:</p> <ul style="list-style-type: none"> • Properly connect LBFB and LBBU relays • Safely set up and operate test instruments/equipment specific to LBFB and LBBU schemes. • Apply settings to the relays and test the general integrity of each LBFB/LBBU backup scheme. • Plan, initial test, routine test, trip-test, adjust, and calibrate LBFB and LBBU relays. • Properly test and set the following power line equipment: <ul style="list-style-type: none"> • Line traps • Line tuners • Properly test and set SWR reference readings. • Perform utility functions, including loading and storing a PLC program. • Change capacitor control, clock, & PT settings. • Test a PLC program and associated equipment after changing a setting. • Properly connect, set, and test the general integrity of the relays.
<p>Session 6 of this program consists of 4 modules, OJT, and TPEs during a six-month time period:</p> <ol style="list-style-type: none"> 1. Substation Automation System (SAS) 2. Regulators 	<p>After completing this session, the Test Technician should be able to:</p> <ul style="list-style-type: none"> • Perform duties of lead person on major job (e.g., order materials, assign

Course Name	Course Description
3. Pilot Relays 4. Leadership and Communication	positions on job, tailboard, direct personnel, and complete overhaul sheets). <ul style="list-style-type: none"> • Plan initial testing of new installations (whenever necessary); perform routine testing of in-service schemes; trip-test, adjust, and calibrate relays. • Troubleshoot and perform minor repairs to these relays using applicable diagrams and prints.

Table SCE 8-06 - SCE Training Courses Specific to Acting Operator Training¹⁸⁷

Course Name	Course Description
Kickoff <ol style="list-style-type: none"> 1. Acting Operator Class Documentation 2. Acting Operator Station Tour 3. Acting Operator Substation Safety Kick-Off 	At the end of this session, the participant will be able to: <ul style="list-style-type: none"> • Identify program documentation • Identify, at a high-level, components of a Substation. • Discuss the expectations of their participation in this program. • Identify safety risks and mitigations in Substations.

¹⁸⁷ New-to-role Electrician Apprentices and Test Technicians are required to take the Acting Operator program as a pre-requisite to their specific New-to-Role programs (SEAP and Test Technician training in Table 8-04 and Table 8-05). The Acting Operator program provides the skills and knowledge to perform routine and emergency switching tasks.

Course Name	Course Description
<p>Session 1</p> <ul style="list-style-type: none"> • Session 1 Study Guide (Student Version) <ul style="list-style-type: none"> o NERC o SCE Electrical System o SOB 12 o Intro to Substations o Personnel o One Lines & Exercises o APM rules o Rack Structures o Power System Safety o Nomenclature & Exercises o Sub Station Logs & Exercises o Power Flow Exercises o SAS o Basic Protection o Live Line Tools o 900 MHz Radio OJT Guidelines <ol style="list-style-type: none"> 1. One Lines & Symbols OJT 2. Rack Structures OJT 3. Nomenclature OJT 4. Powerflow OJT 5. Logging OJT 6. APX 400 900 MHz Hand-Held Radio OJT 7. Basic Protection OJT <ul style="list-style-type: none"> o 401-01 Electron Theory o 401-03 Ohm's and Kirchoff's Laws Relating to DC Circuits o 401-04 Evaluating Series and Parallel DC Circuit Performance 	<p>At the end of this session, the participant will be able to:</p> <ul style="list-style-type: none"> • Discuss key resources (e.g., Accident Prevention Manual, System Operating Bulletins, Safety concepts, etc.) that will be used in their role. • Learn and perform key tasks (e.g., using one lines, nomenclature, logging, tracing powerflow, using 900 MHz Radio, etc.). • Discuss basic protection theory (e.g., Electron theory, Ohm's Law and Kirchoff's Law). • Evaluate Series and Parallel DC Circuit Performance .

Course Name	Course Description
<p>Session 2</p> <ol style="list-style-type: none"> 1. Session 1 Review 2. Basic Protection <ul style="list-style-type: none"> o Zone of Protection o Overload and Directional o Differential Relays o Bank Protection Relays 3. Ground Systems (Solid & Med) 4. Reclosers 5. Live Line Tools 6. Switching Technique (Tailboard, PDOE) 7. SAS 8. Alarm Processing 9. Red Logbook 10. Pinch Points 11. Disconnects 12. Switching with a Checker 13. MMI and Relay Panel Switching 14. Basic Protection Additional Material 15. Line, Bank & Bus Protection 16. Clearances 17. Routine Switching Practice 	<p>At the end of this session, the participant will be able to:</p> <ul style="list-style-type: none"> • Discuss high level basic protection concepts • Identify safety risks and mitigations (e.g., pinch points, clearances, etc.). • Perform switching tasks based on foundational concepts and knowledge (e.g., ground systems, reclosers, Switching Technique, PDOE, etc.).
<p>Session 3</p> <ol style="list-style-type: none"> 1. Program Writing OJT 2. Real Time Switch OJT 3. Clearances OJT 4. Field Assignment OJT 	<p>At the end of this session, the participant will be able to:</p> <ul style="list-style-type: none"> • Experience performing program writing tasks • Experience performing real time switching tasks. • Experience requesting clearances • Perform other field assignments

Course Name	Course Description
<p>Session 4</p> <ol style="list-style-type: none"> 1. Transformers 2. Instrument Transformers 3. Automatic Subs 4. DC Systems 5. Station Light & Power 6. Fuse Replacement 7. Circuit Breakers / Switchers 8. Ino-LECT Racking Device 9. VAR Principles 10. Capacitors 11. Reactors 12. Load Tap Changers and Voltage Regulators 13. Basic Protection (Review, Local Breaker Back up Unit (LBBU), Local Break Failure Back up (LBFB), Differential/Distance Line Protection, Permissive Trip Bus (PTB)/ Fast Bus Blocking (FBB), Fast Curve Relay Settings). 14. Program Writing 15. Grounding Systems/SOB 322 	<p>At the end of this session, the participant will be able to:</p> <ul style="list-style-type: none"> • Identify and describe the purpose and safety risks of common substation equipment. • Discuss basic protection concepts in further detail. • Continue program writing practice • Explain grounding systems/ SOB 322
<p>Session 5</p> <ol style="list-style-type: none"> 1. Program Writing OJT 2. Real Time Switch OJT 3. Clearances OJT 	<p>At the end of this session, the participant will be able to:</p> <ul style="list-style-type: none"> • Write programs • Switch in real time • Request clearances

Course Name	Course Description
<p>Session 6</p> <ol style="list-style-type: none"> 1. Review various System Operator Bulletins, Operating Bulletins and APM rules that apply to Emergency Switching. 2. Hands on practices of various Emergency Switching Scenarios. 3. Practice Emergency Logging 4. Technology Integration Introduction 	<p>At the end of this session, the participant will be able to:</p> <ul style="list-style-type: none"> • Identify how and where to find critical resources (e.g., SOBs, APM rules, etc.) pertaining to emergency switching. • Perform various Emergency Switching scenarios. • Perform emergency logging • Identify where to find resources pertinent to the installation, operations, and maintenance of new equipment in the field (Technology Introduction).

8.1.9.3 Target Role: Risk Event Inspection

SCE inspects various risk events – ignitions, outages, wire-down, faults, etc. – to determine cause and to remediate issues. This work is performed by many of the same qualified field personnel who also perform other work on the system, such as Grid Hardening work.

Table 8-11 below details the worker titles and associated qualifications pertaining to these Risk Event Inspections.

Table 8-11 - Workforce Planning, Risk Event Inspection¹⁸⁸

Worker Title	Minimum Qualifications for Target Role	Special Certification Requirements	Electrical Corporation % FTE Min Quals ¹⁸²	Electrical Corporation % Special Certifications ¹⁸³	Contractor % FTE Min Quals ¹⁸²	Contractor % Special Certifications ¹⁸³	Reference to Electrical Corporation Training/Qualification Programs
TRANSMISSION/ DISTRIBUTION APPRENTICE LINEMAN	See below	N/A	14.5%	N/A	17.3%	N/A	See Distribution Apprentice Lineman training in Table 8-10-1 and Transmission Apprentice Lineman training in Table 8-10-2
JOURNEYMAN TRANSMISSION/ DISTRIBUTION LINEMAN	See below	QEW	31.5%	100%	41.6%	100%	See below
FOREMAN	See below	QEW	15.8%	100%	18.7%	100%	See below
GROUNDMAN	See below	N/A	19.4%	N/A	21.7%	N/A	See below
PATROLMAN	See below	QEW	1.9%	100%	0.0%	N/A	See below
SPLICER	See below	QEW	2.8%	100%	0.7%	100%	See below
APPARATUS TECHNICIAN	See below	N/A	2.8%	N/A	0.0%	N/A	See below
TROUBLEMAN	See below	QEW	11.0%	100%	0.0%	N/A	See below
FIPA ENGINEER	See below	N/A	0.3%	N/A	0.0%	N/A	See below
			100.0%		100.0%		

¹⁸⁸ The SCE worker population identified in this Table overlaps with the SCE worker population identified in Section 8.1.9.2 (Grid Hardening), as these FTE can perform both target roles.

Minimum qualifications:

TRANSMISSION/DISTRIBUTION APPRENTICE LINEMAN: See qualifications of Apprentice Lineman in Section 8.1.9.2.

JOUJNEYMAN TRANSMISSION/DISTRIBUTION LINEMAN: See qualifications of Lineman in Section 8.1.9.1

FOREMAN: See qualifications of Foreman in Section 8.1.9.2.

GROUNDMAN: See qualifications of Groundman in Section 8.1.9.2.

PATROLMAN: See qualifications of Groundman in Section 8.1.9.1.

SPLICER: See qualifications of Lineman in Section 8.1.9.2.

APPARATUS TECHNICIAN: Responsible for performing inspections and maintenance on equipment unique to electric distribution overhead and underground systems. Must have knowledge of: Advanced principles of three phase electrical theory, mathematics, phasor analysis, use of scientific engineering calculator, publications and standards, including system operating bulletins, grounding and G.O. 95/128 manuals, equipment design, and programming manuals. Must possess computer skills, including but not limited to Company desktop applications as well as software and programming applications used to configure, program, and test specific equipment installations. The knowledge, skills, and abilities required for this job are of a level comparable to those normally acquired through Journeyman Lineman experience and demonstrated ability to apply the principles of electrical theory.

TROUBLEMAN: Responsible for troubleshooting and performing routine inspections and minor repairs of the electric distribution system. Must have knowledge of: Equipment, tools, techniques, and methods employed in the construction, installation, maintenance, and repair of distribution overhead and underground line facilities; overhead and underground circuitry and switching; and SCE's Accident Prevention Manual. The knowledge, skills, and abilities required for this job are of a level comparable with those normally acquired through a high school education, supplemented by technical study and extensive training and experience as a Journeyman, Patrolman, or Lineman.

Fire Investigation Preliminary Analysis (FIPA) Engineer: Responsible for investigating, collecting information, performing root cause and failure analysis, and supporting the development of mitigations to ignitions within SCE service territory. The knowledge, skills, and abilities required by the job are of a level comparable with those normally acquired through courses taken in an engineering degree from an accredited university regarding electrical theory, material science, and any experience in root cause analysis.

Training and plans to improve worker qualifications:

SCE will continue to refine its training program and worker qualifications based on lessons learned and feedback from field employees. SCE will continue to provide training to existing field personnel and those that are onboarded prior to every wildfire season. As it relates to wildfire and PSPS, SCE has implemented several training courses to educate and train field workers on proper practices and procedures. These training efforts are described in Table SCE 8-07.

Table SCE 8-07 - List of Instructor Led and Web-Based Transmission and Distribution Wildfire and PSPS-Related Training Courses in 2022

Course Name	Course Description
PSPS Training	The purpose of this workshop is to provide an overview of the overall PSPS protocol including: 1) Roles and responsibilities 2) Communications process 3) Internal and external types of notifications 4) A detailed timeline of events and 5) How to access the pertinent information during a PSPS activation
PSPS 2022 Patrolling & Live Field Observation (LFO) Training	Training on PSPS patrolling and live field observations protocols, and any updates since prior year.
PSPS Patrolling & Live Field Observation (LFO) Refresher: Contractor Orientation (Train the Trainer)	Orientation with contractor supervisors on PSPS patrolling and live field observations protocols, and any updates since prior year; contractor supervisors train their own field crews and submit rosters to SCE.
Protection from Wildfire Smoke	This course is to teach how to protect workers when working in areas where there may be exposure to wildfire smoke. Teaches where to acquire the Air Quality Index, the health effects from wildfire smoke and how to obtain medical treatment if needed. Also teaches how to select, use and maintain proper respirator protection.
Wildfire Smoke Respirator (PAPR)	This course provides usage and maintenance procedures and requirements for Powered Air Purifying Respirator (PAPR) respirators.
Technology Integration – Grid Resiliency	Provides initial training on pilots or new equipment technologies being deployed across HFRA.
SOB 322 Refresher Training	SOB 322 that outlines the operational protocols for overhead distribution, sub-transmission, and transmission equipment within HFRA.

8.1.10 Maturity Advancement

SCE continually seeks alignment with government and industry organizations and practices and continues to look for opportunities to improve maturity over time.

The activities discussed in this section could lead to Grid Design, Inspections and Maintenance and Grid Operations and Protocols maturity advancements. Below is a summary of broader anticipated maturity improvements over the WMP period that supplement the objectives outlined at the beginning of the Section.

Table SCE 8-08 - Inspections and Maintenance and Grid Operations Maturity Improvements

Capability Name	Projected Maturity Improvements
Asset Maintenance and Repair	Improvements include evaluating new considerations in establishing maintenance frequency (e.g., local PSPS risk, equipment utilization).
Asset and Grid Personnel Training and Quality Assurance	Improvements include benchmarking with other utilities in areas such as training (e.g., sharing best practices, consistent venue/forum, etc.)
Protective equipment and device settings	Improvements include an increased portion of the service territory that has protective equipment and device settings installed.
Incorporation of ignition risk factors in Grid Control	Improvements include clearly defined processes to include wildfire risk to determine control limits beyond its current carrying capacity and the increase in subject matter review of these processes.

8.2 Vegetation Management and Inspections

8.2.1 Overview

In accordance with Public Utilities Code section 8386(c)(9), each electrical corporation's WMP must include plans for vegetation management.

In this section, the electrical corporation must identify objectives for the next 3- and 10-year periods, targets, and performance metrics related to the following vegetation management programmatic areas:

- *Vegetation inspections*
- *Vegetation and fuels management*
- *Vegetation management enterprise system*
- *Environmental compliance and permitting*
- *Quality assurance / quality control*
- *Open work orders*
- *Workforce planning*

8.2.1.1 Objectives

Each electrical corporation must summarize the objectives for its 3-year and 10-year plans for implementing and improving its vegetation management and inspections.¹⁸⁹ These summaries must include the following:

- *Identification of which initiative(s) in the WMP the electrical corporation is implementing to achieve the stated objective, including Utility Initiative Tracking IDs*
- *Reference(s) to applicable codes, standards, and best practices/guidelines and an indication of whether the electrical corporation exceeds an applicable code, standard, or regulation*
- *Method of verifying achievement of each objective*
- *A completion date for when the electrical corporation will achieve the objectiveReference(s) to the WMP section(s) or appendix, including page numbers, where the details of the objective(s) are documented and substantiated*

This information must be provided in Table 8-12 for the 3-year plan and Table 8-13 for the 10- year plan.

¹⁸⁹ Annual information included in this section must align with the QDR data.

Table 8-12 - Vegetation Management Implementation Objectives (10-year plan)

Objectives for Three Years (2023–2025)	Applicable Initiative(s), Tracking ID(s)	Applicable Regulations, Codes, Standards, and Best Practices (See Note)	Method of Verification (i.e., program)	Completion Date	Reference (section & page #)
Complete Joint-IOU Effectiveness of Expanded Clearances Study	Routine Line Clearing (VM-7, VM-8), Expanded Clearances (VM-7, VM-8)	GO 95, Rule 35, Clearance Requirements in UVM 02 and 03 Distribution and Transmission Vegetation Management Plan	Report from 3rd party project manager	2025	Section 8.2.3.3.1 Expanded Clearing, pp. 412-418
Deploy consolidated inspection strategy and transition to circuits from grids	Distribution and Transmission inspections (VM-7, VM-8); Hazard Tree Management Program (HTMP) (VM-1); Dead & Dying Tree Removal (VM-4)	Feedback from Independent Third Party Evaluation ¹⁹⁰	Documentation of percentage completion as compared to the master schedule.	2025	Section 8.2.2 Vegetation Management Inspections, pp. 384-408 Section 8.2.3.3.1 Expanded Clearing, pp. 412-418 Section 8.2.3.4 Fall-In Mitigation, pp. 418-422
Develop and implement a risk-informed process to minimize backlog	Distribution and Transmission inspections (VM-7, VM-8); HTMP (VM-1); Dead & Dying Tree Removal (VM-4)	GO 95, Rule 35, Tree Trimming Guidance	For Routine Line Clearing, target the completion of prescribed mitigation work within 60 days from planned month, subject to constraints. For HTMP and Dead and Dying Tree Removal, target the completion of prescribed work within 180 days of assignment.	2025	Section 8.2.6 Open Work Orders, pp. 432-438
Make substantial progress on evaluating remote sensing technology for vegetation inspections	LiDAR (VM-9, VM-10), Satellite Technology	N/A	Develop report on progress	2025	Section 8.2.2.4 Remote Sensing Inspections, pp. 398-408

¹⁹⁰ In 2022, on behalf of the Governor’s Office, Filsinger Energy Partners (FEP) was brought in to provide oversight and potential enhancement opportunities for SCE’s wildfire mitigation strategies.

Note: An asterisk indicates that the electrical corporation exceeds a particular code, regulation, standard, or best practice. The electrical corporation must provide a reference to the appendix section and page providing further documentation, justification, and substantiation.

Table 8-13 - Vegetation Management Implementation Objectives (10-year plan)

Objectives for Ten Years (2026–2032)	Applicable Initiative(s), Tracking ID(s)	Applicable Regulations, Codes, Standards, and Best Practices (See Note)	Method of Verification (i.e., program)	Completion Date	Reference (section & page #)
Replace a majority of ground inspection for vegetation line clearing in HFRA with remote sensing technology (e.g., LiDAR, satellite), subject to the evolution and effectiveness of the technology	LiDAR (VM-9, VM-10), Satellite Technology	GO 95, Rule 35, Tree Trimming Guidance	Total Number of HFRA miles of vegetation inspections performed with remote sensing and total reduction in ground inspections.	2033	Section 8.2.2.4 Remote Sensing Inspections, pp. 398-408
Create and implement predictive growth model to facilitate "auto prescription" to reduce the frequency of manual or remote inspection in HFRA.	LiDAR (VM-9, VM-10), Satellite Technology	GO 95, Rule 35, Tree Trimming Guidance	Total Number of HFRA miles auto-prescribed trims, reduction in ground inspections.	2033	Section 8.2.2.4 Remote Sensing Inspections, pp. 398-408
Optimize vegetation inspection cycles/prescriptions based on risk factors (e.g., species, wind) for more granular locations	Routine Line Clearing (VM-7, VM-8), HTMP (VM-1), Dead & Dying Tree Removal (VM-4)	GO 95, Rule 35, Tree Trimming Guidance	Updated vegetation protocols with revised inspection schedule and/or trim instructions to account for risk analysis	2028	Section 8.2.3.3.1 Expanded Clearing, pp. 412-418 Section 8.2.3.4 Fall-In Mitigation, pp. 418-422
Obtain and implement programmatic permits to facilitate timely vegetation management work execution	Routine Line Clearing (VM-7, VM-8), HTMP (VM-1), Dead & Dying Tree Removal (VM-4)	Relevant environmental regulations	Programmatic permit documents that were executed	2026-2028	Section 5.4.5 - Environmental Compliance and Permitting, pp. 83-88

Note: An asterisk indicates that the electrical corporation exceeds a particular code, regulation, standard, or best practice. The electrical corporation must provide a reference to the appendix section and page providing further documentation, justification, and substantiation.

8.2.1.2 Targets

Initiative targets are forward-looking quantifiable measurements of activities identified by each electrical corporation in its WMP. Electrical corporations will show progress toward completing targets in subsequent reports, including QDRs and WMP Updates.

The electrical corporation must list all targets it will use to track progress on its vegetation management and inspections for the three years of the Base WMP. Energy Safety's Compliance Assurance Division and third parties must be able to track and audit each target.¹⁹¹ For each initiative target, the electrical corporation must provide the following:

- *Utility Initiative Tracking IDs.*
- *Projected targets for each of the three years of the Base WMP and relevant units.*
- *Quarterly, rolling targets for 2023 and 2024 (inspections only).*
- *The expected "x% risk impact" For each of the three years of the Base WMP. The expected x% risk impact is the expected percentage risk reduction per year, as described in Section 7.2.2.2.*
- *Method of verifying target completion.*

The electrical corporation's targets must provide enough detail to effectively inform efforts to improve the performance (i.e., reduction in ignition probability or wildfire consequence) of the electrical corporation's vegetation management and inspections initiatives.

Table 8-14 and Table 8-15 provide examples of the minimum acceptable level of information.

The risk impact percentages shown in Table 8-14 and Table 8-15 below are based on the cumulative MARS scores of the structures in the area SCE expects to inspect for each vegetation management initiative annually, divided by the cumulative MARS scores for all structures in the applicable area covered by that initiative in HFRA. SCE also provides the percentage of a vegetation management initiative's inspection scope that is in Severe Risk and High Consequence areas.

¹⁹¹ Annual information included in this section must align with Table 1 of the QDR.

Table 8-14 - Vegetation Management Initiative Targets by Year

Initiative Activity	Tracking ID	2023 Target & Unit	x% Risk Impact 2023	% in SRA/HCA 2023	2024 Target & Unit	x% Risk Impact 2024	% in SRA/HCA 2024	2025 Target & Unit	x% Risk Impact 2025	% in SRA/HCA 2025	Method of Verification
Expanded Clearances for Generation Legacy Facilities	VM-3	Perform vegetation treatment and maintenance to 50 sites SCE will strive to perform vegetation treatment and maintenance to 60 sites	23%	N/A	Perform vegetation treatment and maintenance to 50 sites SCE will strive to perform vegetation treatment and maintenance to 60 sites	23%	N/A	Perform vegetation treatment and maintenance to 60 sites SCE will strive to perform vegetation treatment and maintenance to 70 sites	21%	N/A	Listing of all completed work orders
Vegetation Management Work Management Tool (Arbora)	VM-6	Enable supplemental Vegetation Management (emergent work) tree maintenance program capabilities in Arbora by end of year	N/A	N/A	Monitor stabilization of Arbora and develop plan and begin execution of plan to enable additional VM maintenance programs	N/A	N/A	Monitor stabilization of Arbora and continue execution of plan to enable additional VM maintenance programs	N/A	N/A	System evidence of the capability to assign non-routine work activity in work management tool

*To inform trimming prescriptions in the January to December calendar year, with inspections occurring as early as November 1 in the prior year.

Table 8-15 - Vegetation Inspections Targets

Initiative Activity	Tracking ID	Target End of Q2 2023 & Unit	Target End of Q3 2023 & Unit	End of Year Target 2023 & Unit	x% Risk Impact 2023	% in SRA/HCA 2023	Target End of Q2 2024 & Unit	Target End of Q3 2024 & Unit	End of Year Target 2024 & Unit	x% Risk Impact 2024	% in SRA/HCA 2024	Target 2025 & Unit	x% Risk Impact 2025	% in SRA/HCA 2025	Method of Verification
Hazard Tree Management Program (HTMP)	VM-1	260	350	Inspect 412 grids/circuits and prescribe mitigation for hazardous trees with strike potential within those grids in SCE's HFRA	83%	88%	250	358	Inspect 408 grids/circuits and prescribe mitigation for hazardous trees with strike potential within those grids in SCE's HFRA * (see insertion text above)	70%	88%	Inspect 440 grids/circuits and prescribe mitigation for hazardous trees with strike potential within those grids in SCE's HFRA* (see insertion text above) Note: 2025 schedule will be developed at the circuit /span level, subject to change	63%	70%	Tracking of year-to-date completed grids/circuits for inspection and mitigation
Structure Brushing	VM-2	29,870	63,700	Inspect and clear (where clearance is needed) 63,700 structures,* with the exception of structures for which there are customer access or environmental constraints SCE will strive to inspect and clear (where clearance is needed) 135,200 structures,* with the exception of structures for which there are customer access or environmental constraints * These structures are in addition to poles subject to PRC 4292	62%	84%	29,870	63,700	Inspect and clear (where clearance is needed) 63,700 structures,* with the exception of structures for which there are customer access or environmental constraints SCE will strive to inspect and clear (where clearance is needed) 135,200 structures,* with the exception of structures for which there are customer access or environmental constraints * These structures are in addition to poles subject to PRC 4292	62%	84%	Inspect and clear (where clearance is needed) 63,700 structures,* with the exception of structures for which there are customer access or environmental constraints SCE will strive to inspect and clear (where clearance is needed) 135,200 structures,* with the exception of structures for which there are customer access or environmental constraints * These structures are in addition to poles subject to PRC 4292	62%	84%	Listing of work orders attempted, inspected and/or completed in calendar year
Dead & Dying Tree Removal	VM-4	298	433	Inspect 509 grids/circuits and prescribe mitigation for	100%	85%	281	424	Inspect 485 grids/circuits and prescribe mitigation for dead and dying trees	100%	85%	Inspect 536 grids/circuits and prescribe mitigation for dead and dying trees with strike potential	100%	77%	Tracking of year-to-date completed grids/circuits

*To inform trimming prescriptions in the January to December calendar year, with inspections occurring as early as November 1 in the prior year.

Initiative Activity	Tracking ID	Target End of Q2 2023 & Unit	Target End of Q3 2023 & Unit	End of Year Target 2023 & Unit	x% Risk Impact 2023	% in SRA/HCA 2023	Target End of Q2 2024 & Unit	Target End of Q3 2024 & Unit	End of Year Target 2024 & Unit	x% Risk Impact 2024	% in SRA/HCA 2024	Target 2025 & Unit	x% Risk Impact 2025	% in SRA/HCA 2025	Method of Verification
				dead and dying trees with strike potential within those grids/circuits					with strike potential within those grids/circuits* (see insertion text above)			within those grids/circuits* (see insertion text above) Note: 2025 schedule will be developed at the circuit /span level, subject to change			for inspection and mitigation
Detailed Inspections for the Prescription, Where Necessary and Feasible, of Expanded Vegetation Clearances from Distribution Lines in HFRA	VM-7	308	539	Inspect 770 grids within our distribution system* (see insertion above)	100%	75%	308	539	Inspect 770 grids within our distribution system* (see insertion text above)	100%	75%	Inspect 770 grids/circuits within our distribution system* Note: 2025 schedule will be developed at the circuit /span level, subject to change (see insertion text above)	100%	75%	Listing of all completed work orders
Detailed Inspections for the Prescription, Where Necessary and Feasible, of Expanded Vegetation Clearances from Transmission Lines in HFRA	VM-8	273	378	Inspect 416 circuits within our transmission system* (see insertion text above)	100%	75%	273	378	Inspect 416 circuits within our transmission system* (see insertion text above)	100%	75%	Inspect 416 circuits within our transmission system* Note: 2025 schedule will be developed at the circuit /span level, subject to change (see insertion text above)	100%	75%	Listing of all completed work orders
LiDAR Distribution Vegetation Inspections	VM-9	650	1,020	Inspect at least 1,020 HFRA circuit miles *Subject to change based on technology, program adjustments, and grid/circuits layout	7%	78%	650	1,020	Inspect at least 1,020 HFRA circuit miles *Subject to change based on technology, program adjustments, and grid/circuits layout	N/A	N/A	Inspect at least 1,020 HFRA circuit miles *Subject to change based on technology, program adjustments, and grid/circuits layout. Targets for 2025 for HFRA LiDAR miles assume continuation of support of ground inspections and do not reflect SCE's planned transition to remote sensing for	N/A	N/A	Listing of all completed work orders

Initiative Activity	Tracking ID	Target End of Q2 2023 & Unit	Target End of Q3 2023 & Unit	End of Year Target 2023 & Unit	x% Risk Impact 2023	% in SRA/HCA 2023	Target End of Q2 2024 & Unit	Target End of Q3 2024 & Unit	End of Year Target 2024 & Unit	x% Risk Impact 2024	% in SRA/HCA 2024	Target 2025 & Unit	x% Risk Impact 2025	% in SRA/HCA 2025	Method of Verification
												inspections			
LiDAR Transmission Vegetation Inspections	VM-10	1,180	1,620	Inspect at least 1,820 HFRA circuit miles *Subject to change based on program adjustments and evolution of remote sensing technologies	25%	89%	973	1,335	Inspect at least 1,500 HFRA circuit miles *Subject to change based on program adjustments and evolution of remote sensing technologies	N/A	N/A	Inspect at least 1,750 HFRA circuit miles *Subject to change based on technology, program adjustments, and grid/circuits layout. Targets for 2025 for HFRA LiDAR miles assume continuation of support of ground inspections and do not reflect SCE's planned transition to remote sensing for inspections	N/A	N/A	Listing of all completed work orders

8.2.1.3 Performance Metrics Identified by the Electrical Corporation

Performance metrics indicate the extent to which an electrical corporation's Wildfire Mitigation Plan is driving performance outcomes. The electrical corporation must:

- *List the performance metrics the electrical corporation uses to evaluate the effectiveness of its vegetation management and inspections in reducing wildfire and PSPS risk¹⁹²*

For each of these performance metrics listed, the electrical corporation must:

- *Report the electrical corporation's performance since 2020 (if previously collected)*
- *Project performance for 2023-2025*
- *List method of verification*

The electrical corporation must ensure that each metric's name and values are the same in its WMP reporting as its QDR reporting (specifically, QDR Table 2 and QDR Table 3). Metrics listed in this section that are the same as performance metrics required by Energy Safety and reported in QDR Table 2 (Performance Metrics)¹⁹³ must match those reported in QDR Table 2. Metrics listed in this section that are not the same as any of the performance metrics identified by Energy Safety and reported in QDR Table 2 must match those reported in QDR Table 3.

The electrical corporation must:

- *Summarize its self-identified performance metric(s) in tabular form*
- *Provide a brief narrative that explains trends in the metrics*

SCE identifies performance metrics that its vegetation management activities support in Table 8-16. SCE then provides a brief narrative describing trends for each metric.

¹⁹² *There may be overlap between the performance metrics the electrical corporation uses and performance metrics required by Energy Safety. The electrical corporation must list these overlapping metrics in this section in addition to any unique performance metrics it uses.*

¹⁹³ *The performance metrics identified by Energy Safety are included in Energy Safety's Data Guidelines.*

Table 8-16 - Vegetation Management and Inspection Performance Metrics Results by Year

Performance Metrics	2020	2021	2022	2023 Projected	2024 Projected	2025 Projected	Method of Verification (e.g., third-party evaluation, QDR)
Number of trees inspected in HFRA where at least some vegetation was found in a non-compliant condition	22,600	16,555	16,613	15,782	14,993	14,244	QDR, Tables 2 and 3
Number of Tree-Caused Circuit Interruptions (TCCIs) in HFRA	90	73	60	57	54	51	QDR, Table 3
Number of CPUC reportable ignitions in HFRA	50	48	40	39	38	37	QDR, Tables 2 and 3
Number of wire downs in HFRA	379	468	316	361	360	361	QDR, Tables 2 and 3
Number of outages in HFRA	2,824	2,356	2,404	2,018	1,946	1,892	QDR, Tables 2 and 3

- **Number of trees inspected in HFRA where at least some vegetation was found in a non-compliant condition:** This metric applies to SCE’s routine transmission and distribution vegetation clearing programs and counts the number of trees that were found to have some vegetation within the respective required clearance distances.

This metric has been trending downward in the 2020 through 2022 period. SCE anticipates its vegetation management initiatives will contribute to the continuation of a downward trend for this metric over the 2023-2025 WMP period. This projection is an estimate, and actual performance is dependent on weather and other factors.

- **Number of Tree-Caused Circuit Interruptions (TCCIs) in HFRA:** This metric applies to the number of tree-caused circuit interruptions occurring in SCE’s HFRA. This metric has experienced a downward trend from 2020 – 2022. SCE anticipates its vegetation management initiatives to make further progress and influence a continued downward trend for this metric over the 2023-2025 WMP period. This projection is an estimate only and actual performance is dependent on weather and other factors. This metric is impacted by multiple factors beyond SCE’s control, such as weather-related factors. For instance, due to weather factors, there may be a significant unanticipated increase in growth rate for certain vegetation creating a potential for fall-in events.
- **Number of CPUC reportable ignitions, wire downs, and outages in HFRA:** Please see Section 8.1.1.3 for a narrative describing these metrics and associated trends. These metrics represent total counts across SCE’s HFRA and are not solely attributable to risk events driven by vegetation.

8.2.2 Vegetation Management Inspections

In this section, the electrical corporation must provide an overview of its procedures for vegetation management inspections.

The electrical corporation must first summarize details regarding its vegetation management inspections in Table 8-17. The table must include the following:

- **Type of inspection:** distribution, transmission, substation, etc.
- **Inspection program name:** Identify various inspection programs within the electrical corporation (e.g., routine, enhanced vegetation, high-risk species, and off-cycle)
- **Frequency or trigger:** Identify the frequency or triggers, such as inputs from the risk model. Indicate differences in frequency or trigger by HTFD Tier, if applicable
- **Method of inspection:** Identify the methods used to perform the inspection (e.g., patrol, detailed, sounding or root examination, aerial, and LiDAR)
- **Governing standards and operating procedures:** Identify the regulatory requirements and the electrical corporation’s procedures for addressing them

Table 8-17 - Vegetation Management Inspection Frequency, Method, and Criteria

Type	Inspection Program	Frequency or Trigger (Note 1)	Method of Inspection (Note 2)	Governing Standards & Operating Procedures
Distribution	Distribution Vegetation Management Plan (DVMP) (Routine Line Clearing)	<p>Frequency: Vegetation inspections and maintenance should be completed annually or more often as deemed necessary.</p> <p>Trigger: The work is based on an annual schedule with risk-informed prioritization based on the Tree Risk Index (TRI)</p>	(1) Ground and (2) LiDAR;	<p>SCE’s standard operating procedures for the DVMP are documented in SCE’s Utility Vegetation Management (UVM) Program titled, UVM-03 (DVMP).</p> <p>Manage vegetation to prevent vegetation encroachment into Clearance Zones stated in the following regulations, as applicable: GO 95 Rule 35 (Case 13 and Case 14)</p>

Type	Inspection Program	Frequency or Trigger (Note 1)	Method of Inspection (Note 2)	Governing Standards & Operating Procedures
		model. ¹⁹⁴ However, emergent work is driven by off-cycle notifications, including customer notification and priority conditions.		GO 95 Rule 37 PRC 4293 PRC 4292 Title 14 CCR Sections 1250-1258
Transmission	Transmission Vegetation Management Plan (TVMP) (Routine Line Clearing)	<p>Frequency: Vegetation inspections and maintenance should be completed annually or more often as deemed necessary.</p> <p>Trigger: The work is based on an annual schedule. However, emergent work is driven by off-cycle notifications, including customer notification and priority conditions.</p>	(1) Ground and (2) LiDAR	<p>SCE's standard operating procedures for the TVMP are documented in SCE's UVM Program titled, UVM-02 (TVMP).</p> <p>Manage vegetation to prevent vegetation encroachment into Clearance Zones stated in the following regulations, as applicable: FAC-003-4 GO 95 Rule 35 (Case 13 and Case 14) GO 95 Rule 37 PRC 4293 PRC 4292 Title 14 CCR Sections 1250-1258</p>
Transmission and Distribution HFRA-only	Hazard Tree Management Plan (HTMP)	Frequency: Inspection scope and frequency are driven by the TRI model. Grids in the highest risk category A,	(1) Ground and (2) LiDAR	SCE's standard operating procedures for HTMP are documented in SCE's UVM Program titled, UVM-04 (HTMP).

¹⁹⁴ The factors incorporated in the TRI model are described in more detail in Section 8.1.2.2.

Type	Inspection Program	Frequency or Trigger (Note 1)	Method of Inspection (Note 2)	Governing Standards & Operating Procedures
		<p>according to the TRI, will follow an annual inspection cycle, while grids in categories B, C, and D will follow a three-year inspection cycle. The three-year inspection cycle for categories B, C, and D will start in 2023 with the highest risk category B grids, then descend by risk category with C grids in 2024 and D grids in 2025.¹⁹⁵</p> <p>Trigger: Off-cycle inspections may be triggered by a trouble order or wildfire or unique request to mitigate a hazardous tree.</p>		
<p>Transmission and Distribution</p> <p>HFRA-only</p>	<p>Dead and Dying Tree Removal</p>	<p>Frequency: Inspections are performed in applicable areas within SCE’s Tier 2 and Tier 3 HFRA. Applicable areas are determined based on California’s Tree</p>	<p>Ground</p>	<p>SCE’s Dead and Dying Tree Removal is documented in SCE’s UVM Program titled, UVM-18 (Assessment and Removal of Dead and Dying Trees), which meets and/or exceeds the requirements</p>

¹⁹⁵ For more information on TRI, see Section 8.2.2.1 under Frequency or Trigger.

Type	Inspection Program	Frequency or Trigger (Note 1)	Method of Inspection (Note 2)	Governing Standards & Operating Procedures
		<p>Mortality Task Force, which updates maps annually to show High Hazard Zones and Hazard Severity Zones. All Zones are included in inspection scope.</p> <p>Trigger: Off-cycle inspections may be triggered by a trouble order¹⁹⁶ or wildfire or unique request from the Senior Specialist (SSP) to mitigate a hazardous tree.</p>		<p>established by GO 95, PRC 4923, and the California Public Utilities Commission (CPUC) Drought Resolution ESRB-4, dated June 12, 2014.</p>

¹⁹⁶ Trouble orders is work performed outside of SCE's Vegetation Management compliance programs. They may include work to remediate Priority 1 (P1) emergency conditions related to vegetation.

Type	Inspection Program	Frequency or Trigger (Note 1)	Method of Inspection (Note 2)	Governing Standards & Operating Procedures
Transmission and Distribution	LiDAR	<p>Frequency: LiDAR is scheduled based on the risk value assigned¹⁹⁷ and how frequently the LiDAR data is refreshed. For detailed information, see SCE’s UVM-06 for a schedule based on risk criteria for LiDAR surveys to be performed.</p> <p>Trigger: Same as frequency</p>	LiDAR	<p>SCE’s standard operating procedures for LiDAR are documented in SCE’s UVM Program titled, UVM-06 (LiDAR Schedule Reference Guide) and UVM-02 (TVMP).</p> <p>Manage vegetation to prevent vegetation encroachment into Clearance Zones stated in the following regulations, as applicable: NERC FAC-003-4 GO 95 Rule 35 (Case 13 and Case 14) GO 95 Rule 37 Cal. Pub. Res. Code (PRC) § 4293 Cal. Pub. Res. Code (PRC) § 4292 Title 14 CCR Sections 1250-1258</p>

Note 1: The electrical corporation must provide electrical corporation-specific risk-informed triggers used for vegetation management.

Note 2: The electrical corporation must provide electrical corporation-specific definitions of the different methods of inspection.

The electrical corporation must then provide a narrative overview of each vegetation inspection program identified in the above table; Sections 8.2.2.1. provides instructions for the overviews. The sections should be numbered 8.2.2.1 to Section 8.2.2.n (i.e., each vegetation inspection program is detailed in its

¹⁹⁷ For Transmission, SCE utilizes the class ranking system to assign risk by circuits as described in Section 8.2.2.4.1. For Distribution, SCE deploys LiDAR for AOC and use IWMS as described in Section 8.1.3.1.

own section). The electrical corporation must include inspection programs it is discontinuing or has discontinued since the last WMP submission; in these cases, the electrical corporation must explain why the program is being discontinued or has been discontinued.

8.2.2.1 Routine Line Clearing

In this section, the electrical corporation must provide an overview of the individual vegetation inspection program, including inspection criteria and the various inspection methods used for each inspection program.

Include relevant visuals and graphics depicting the workflow and decision-making process the electrical corporation uses for the inspection program (see the example in Figure SCE 8-38).

Inspection Process

SCE performs annual inspections and trimming for clearance around conductors in accordance with applicable regulations and internal processes such as GO 95, PRC 4293 and SCE's Transmission Vegetation Management Plan (UVM-02) and Distribution Vegetation Management Plan (UVM-03).

Inspections of vegetation clearance distances from transmission and distribution lines and equipment are generally performed by vegetation ground personnel.¹⁹⁸ During these inspections, the inspector identifies vegetation that requires trimming or removal to meet program requirements designed to maintain required clearances from the lines, taking into consideration a tree's anticipated growth over the ensuing twelve months.¹⁹⁹ Additionally, SCE performs level 1 assessments to address fall-in risk. In level 1 assessments, the inspectors conduct an assessment from the side of the tree nearest to the electrical facilities, focusing on identifying obvious tree defects (e.g., dead branches or leaning) that are observable. Finally, inspectors investigate vegetation concerns raised by customers, assess vegetation adjacent to electrical line work, and address inspection findings requiring immediate planning or schedule coordination.

SCE also uses remote sensing (LiDAR and Satellite) in the inspection cycle and continues to explore the possibility of transitioning from ground inspections to more remote options.

¹⁹⁸ SCE also uses aerial inspections and LiDAR in specific conditions. Where line clearance cannot be readily assessed from the ground but the horizontal and vertical clearance between the vegetation and conductors can be determined from an aerial inspection, then aerial inspections may be performed. SCE uses LiDAR as an inspection and measurement tool to identify clearances between high-voltage lines and vegetation. SCE also uses LiDAR data, which are acquired via air patrol.

¹⁹⁹ Fast-growing species, or trees in HFRA, may need additional inspections, trimming, or removal to maintain regulatory compliance.

Figure SCE 8-38 - Routine Line Clearing Scheduling Process Flow

High level overview of the Routine Line Clearing scheduling process

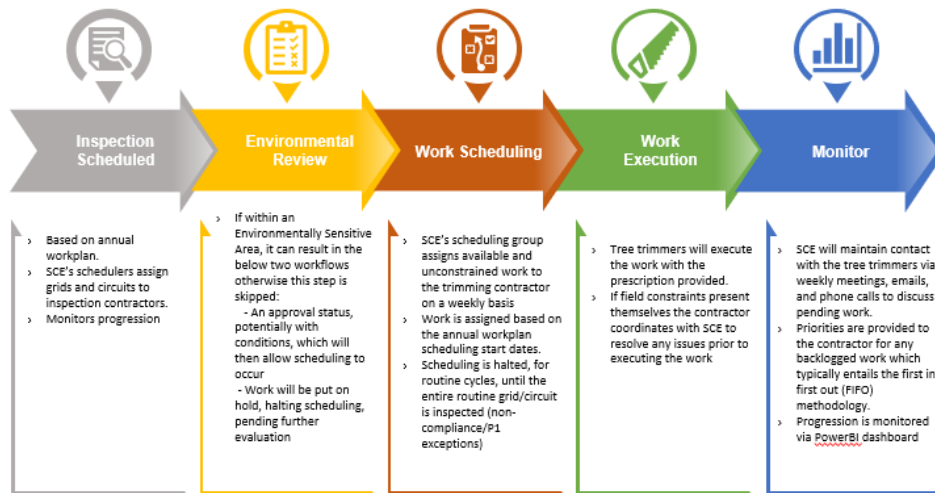

Frequency or Trigger

In this section, the electrical corporation must identify the frequency or triggers used in the inspection program, such as inputs from the risk model. It must also identify how the frequency or trigger might differ by HFTD Tier or other risk designation.

If the inspection program is based on a schedule, the electrical corporation must explain how it uses risk prioritization in the scheduling of the inspection program to target high-risk areas. If the electrical corporation does not use risk prioritization in the scheduling of the inspection program, it must explain why.

SCE’s Routine Line Clearing inspections are scheduled such that each grid in SCE’s service area is inspected annually. Grids are SCE-defined geographic boundaries that define a work area. SCE has approximately 3,000 grids systemwide, including roughly 1,100 in HFRA. SCE plans to transition to a circuit basis by 2025 to align with other wildfire mitigation efforts and PSPS decision making.

For non-HFRA grids, the inspection schedules consider factors such as resource availability, appropriate allocation of work throughout the year, permitting lead times and availability, and challenges with access to worksites based on seasonal weather conditions. The schedule incorporates risk prioritization by ranking grids according to historical vegetation related outages and tree density.

For HFRA grids, SCE applies the outcome from the Tree Risk Index (TRI), which ranks grids according to the “probability of ignition” (POI) from contact with vegetation based on species, locations, and other factors, and the Technosylva “consequence scores.” The TRI model is described in more detail in Section 8.2.2.2 under “Frequency or Trigger.” To the extent feasible, SCE strives to schedule annual inspections for higher-risk locations in HFRA grids in the months leading up to peak-fire season.

SCE also conducts supplemental patrols to help ensure that vegetation encroachments do not occur during peak fire season and high wind conditions. The risks are higher in certain locations, such as canyons, which experience higher winds. SCE also uses the TRI model to optimize and help reduce the

need for supplemental patrols, which incorporates a number of risk factors into the POI value. SCE analyzes all methods of alternative patrols, selecting the most appropriate patrol based on the location-specific need for inspection.

For more information on risk prioritization related to the TRI, refer to Section 8.2.2.2.

Accomplishments, Roadblocks, and Updates

In this section, the electrical corporation must discuss:

Noteworthy accomplishments for the inspection program since the last WMP submission

Roadblocks the electrical corporation has encountered while implementing the inspection program and how the electrical corporation has addressed the roadblocks

Changes/updates to the inspection program since the last WMP submission including known future plans (beyond the current year) and new/novel strategies the electrical corporation may implement in the next 5 years (e.g., references to and strategies from pilot projects and research)

Noteworthy accomplishments for the inspection program since the last WMP submission

Senior Specialist (SSP) Oversight Project

In 2022, SCE began implementing a new initiative to increase SCE oversight after a pre-inspection is performed called the Senior Specialist (SSP) Oversight Project. SCE uses internal SSPs, who are International Society of Arboriculture (ISA) -certified arborists, to provide oversight and general guidance to contractors for SCE routine line clearing activities. The purpose of this increased post-work verification (PWV) is to improve the quality of work, create more accurate prescriptions released to tree trimmers, and reduce missed trees. SCE made these improvements to its pre-inspection program, in part to address recommendations identified by an independent third-party review of its program.

The additional oversight provided by this initiative will help improve the performance and quality of pre-inspections. SCE analyzes the data from PWV to help inform future training and continuous learning opportunities provided to inspectors and/or other key Vegetation Management personnel. Based on the effectiveness of the PWV in 2022, it will be formalized across the service area by first quarter 2023.

Satellite Technology Pilot Program

In 2022, SCE also launched a pilot program to test the use of satellite technology for confirming the accuracy of vegetation clearances and identifying trees near overhead lines. Section 8.2.2.4.2 describes this effort in more detail.

Workforce Retention and Upskilling

SCE is developing new contractor requirements to improve its ability to attract and retain skilled inspectors, in order to help facilitate overall improvement of the quality of prescriptions. In 2022, SCE revised the Statement of Work (SOW) for Vegetation Management inspectors to include an experience and education-based classification structure. This structure aligns wages to specific experience and education levels for individuals performing various inspection activities, thus promoting the advancement of inspection-related skills and experiences.

Roadblocks the electrical corporation has encountered while implementing the inspection program and how the electrical corporation has addressed the roadblocks

Customer Refusals

Inspections can be impeded by customer refusals, but these constraints, among others, are more prevalent when SCE executes remediation. Please see the discussion in Section 8.2.3.3.1 describing customer refusals and other constraints, which can impact the Routine Line Clearing Program.

Changes/updates to inspection program since the last WMP Including known future plans (beyond the current year) and new/novel strategies the electrical corporation may implement in the next 5 years (e.g., references to and strategies from pilot projects and research)

Consolidated Inspection Strategy

In 2023, SCE will introduce a new centralized tree inspection schedule for its three largest inspections programs: Routine Line Clearing, HTMP,²⁰⁰ and Dead & Dying Tree Removal. Historically, SCE has hired different inspection personnel for each program. Therefore, in practice, when a contracted inspection company conducted routine inspections in a particular district, the company would not inspect trees that fell within another program's scope, such as hazard or dead and dying trees, even if those trees were in the same district.²⁰¹ SCE explored consolidating the vegetation inspection programs to improve effectiveness and efficiency, which was validated by recommendations from an independent third-party review. With the new centralized tree inspection schedule, SCE will assign one inspection contractor company to inspect the entire designated district and apply the criteria for all three inspection programs, as needed. The figure below shows the flowchart for consolidated inspections.

²⁰⁰ For Hazard Tree Management Program, inspectors will continue to be required to be Certified Arborists.

²⁰¹ Although the inspector would not formally assess all trees, if a concerning issue was observed, the inspector would escalate their finding to SCE personnel.

Figure 8-2 - Vegetation Management Consolidated Inspection Overview

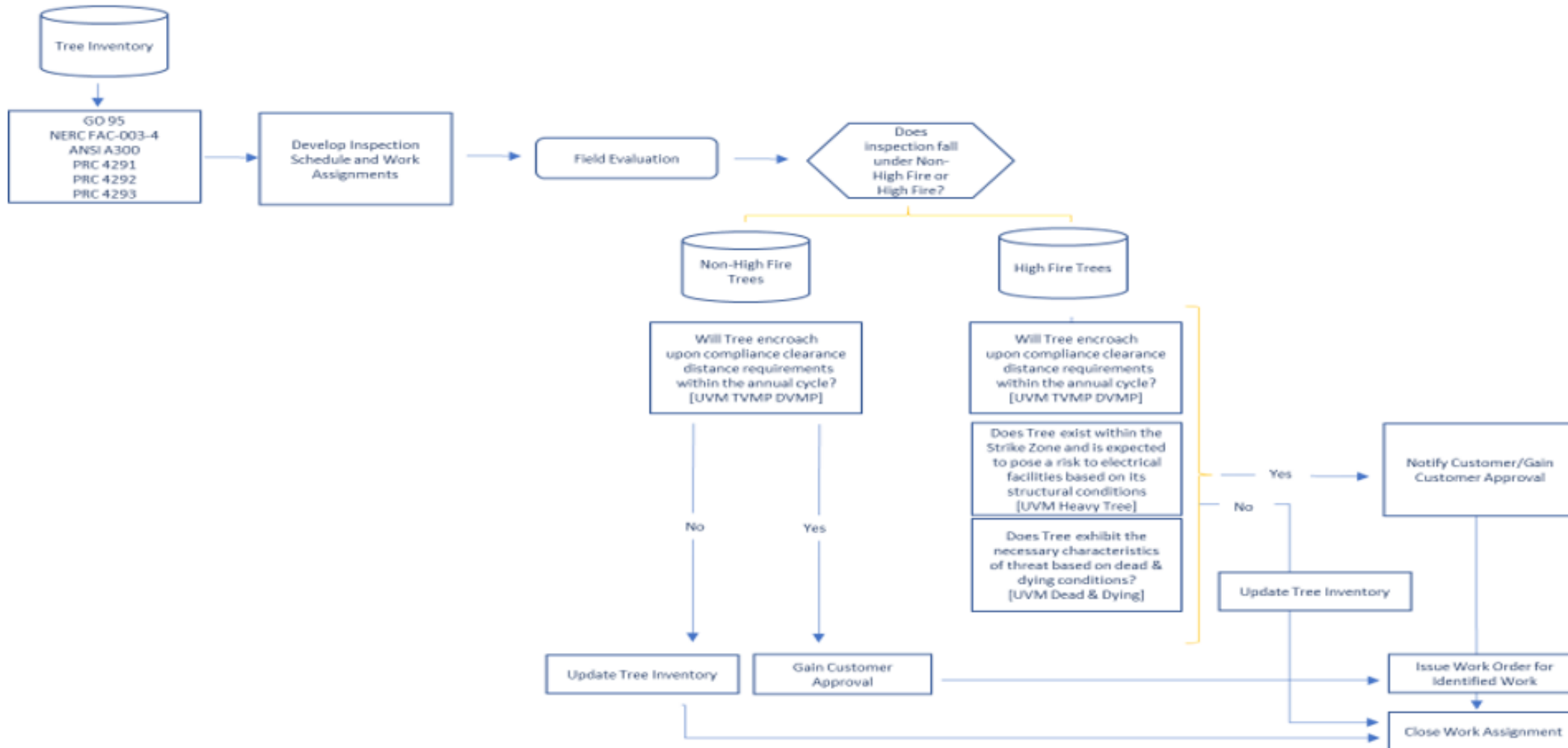

Circuit Basis

In 2022, inspections of SCE's Distribution Routine Line Clearing were conducted on a grid-by-grid basis while inspections for other Vegetation Management programs such as Transmission Routine Line Clearing, HTMP, and Dead and Dying Tree Removal inspections were conducted on a circuit basis. In 2023, inspections related to distribution assets for HTMP, Dead and Dying Tree Removal, and Routine Line Clearing program will be conducted on a grid basis in order to deploy the centralized tree inspection schedule. Consistent with recommendations from an independent third-party observation, by 2025, SCE plans to transition inspections for all Vegetation Management programs to a circuit basis, thus completing the consolidated inspection strategy.

LiDAR

As described in Section 8.2.2.4.1, SCE will continue to evaluate the use of LiDAR to supplement and/or replace ground inspections.

8.2.2.2 Hazard Tree Management Program

Inspection Process

The Hazard Tree Management Program (HTMP) assesses live trees in HFRA that pose a fall-in risk due to the condition of the tree and other site-specific factors when they are located far enough from SCE lines and equipment to meet statutory clearance requirements.

Once a circuit²⁰² is scheduled for inspection, certified arborists complete a detailed level 2 assessment to identify subject trees that could potentially fall into or otherwise impact electrical facilities in HFRA. This assessment is distinct from the inspection process related to Routine Line Clearing, where visual level 1 assessments are performed on trees immediately adjacent to electrical facilities. The arborists inspect trees in the Utility Strike Zone (USZ), the area on either side of SCE's electrical facilities from which a tree or a portion of a tree could strike or impact electrical facilities. The USZ can vary significantly based on the height of the trees, slope conditions, and the potential for impacts from wind-driven vegetation.

HTMP inspectors use the Tree Risk Calculator (TRC) to document tree defects and likelihood of failure and target impact. The certified arborist assigns a risk score based on six criteria: (1) Voltage Impact; (2) Fire Impact; (3) Likelihood of Impact; (4) Tree Lean; (5) Tree Height Factor; and (6) Site Condition Attributes. The final scoring results can range from 1-100 (100 being the highest risk score).

Depending on the inspector's assessment results, a tree is classified into one of two categories: (1) a subject tree which does not need mitigation but is added to SCE's tree inventory for continued monitoring or (2) a hazard tree needing mitigation (trim) or removal. A subject tree is a tree within SCE's tree inventory that is identified as low-risk and with a typical risk score between 0 to 49. A hazard tree needing mitigation, while alive, is considered hazardous with a typical risk score between 50 to 100. The classification of the tree and arborist opinion informs the remediation required.

SCE performs inspections using a risk-based approach encompassed in the TRI model, as described in the below section Frequency or Trigger. Based on the results of the inspection, SCE generates

²⁰² In 2023, SCE's HTMP program for distribution assets, and not for transmission assets, will be inspected on a grid basis to align with the current Distribution Routine Line Clearing program. However, SCE plans to transition back to a circuit basis in 2025.

prescriptions and performs the required remediations.

The HTMP will also be impacted by the implementation of the consolidated inspection strategy. Please refer to Figure 8-2 in Section 8.2.2.1 for the workflow of the consolidated inspection process.

Frequency or Trigger

In this section, the electrical corporation must define and identify the frequency (including how frequency may differ by HFTD or other risk designation[s]) or triggers of the inspection program, such as inputs from the risk model.

If the inspection program is schedule based, the electrical corporation must explain how it uses risk prioritization in the scheduling of the inspection program to target high-risk areas. If the electrical corporation does not use risk prioritization in the scheduling of the inspection program, it must explain why.

The HTMP is focused on SCE's HFRA service area. HTMP inspection scope and frequency are driven by the TRI model. Within the TRI model, each structure in HFRA is evaluated for the risk of vegetation contact and is assigned a probability of ignition (POI) as well as a Technosylva consequence score (which estimates the potential number of acres burned should an ignition occur at the location of the structure). These structures with assigned POI and consequence scores are then aggregated to the Vegetation Management grid level. Grids are then assigned to risk categories A, B, C, and D (with A being the highest risk category) according to their TRI score.

To align the TRI with SCE's Integrated Wildfire Mitigation Strategy (IWMS),²⁰³ the consequence category for those grids with higher proportions of Severe Risk Area miles were classified as "A". In *Figure SCE 8-39* below, the numbers in the boxes identify grids that have been categorized based on their TRI score. The red boxes in the top right of the figure show the grids with the highest risk level, resulting from having the highest scores in both categories, while the green boxes in the bottom left show the grids with the lowest risk level.

Based on their TRI score, grids in the highest risk category of A follow an annual cycle for HTMP inspections, while grids in categories B, C, and D follow a three-year inspection cycle for HTMP. The three-year inspection cycle for categories B, C, and D will start in 2023 with the highest risk category B grids, then C grids in 2024 and D grids in 2025. Any hazardous tree that was trimmed as a mitigation prescription in HTMP pass one (2019-2022) will continue to be inspected based on TRI ranking. This methodology yields various assessment quantities for HTMP per year and will be refreshed annually for new subject trees recorded in each category.

²⁰³ This strategy determines how SCE assigns risk categories in HFRA (severe risk areas, high consequence areas, and other HFRA)

Figure SCE 8-39 - Tree Risk Index (TRI) – Distribution Grids (HFRA)

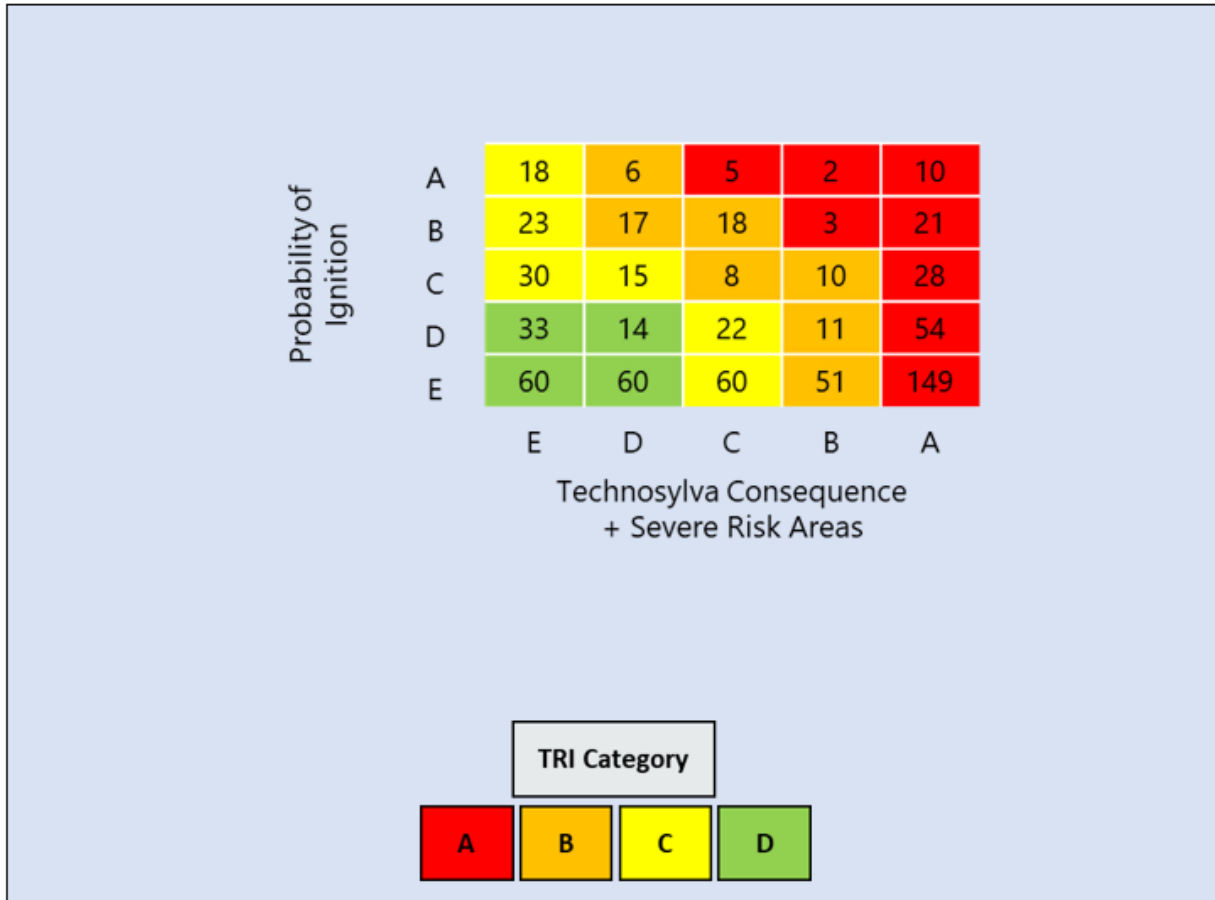

Accomplishments, Roadblocks, and Updates

- *Noteworthy accomplishments for the inspection program since the last WMP.*

Assessment of HFRA Circuits

In 2022, SCE substantially completed the first pass of inspections of circuits in HFRA for Hazard Trees, which enabled the unified inspection scope beginning in 2023 under the consolidated inspection strategy for SCE’s Routine Line Clearing, HTMP, and Dead & Dying Tree Removal Program. This resulted in performing over 350,000 HTMP assessments. The subject trees not removed as a result of the HTMP assessment will be re-inspected on a defined cadence, based on risk category as determined by the TRI model. See sub-section “Frequency or Trigger” above for a description of SCE’s risk prioritization method.

- *Roadblocks the electrical corporation has encountered while implementing the inspection program and how the electrical corporation has addressed the roadblock.*

Inspections can be impeded by customer refusals, but these constraints, among others, are more prevalent when SCE executes remediation. Please see the discussion in Section 8.2.3.3.1 describing

customer refusals and other constraints, which can impact the Hazard Tree Management Program.

- *Changes/updates to inspection program since the last WMP Including known future plans (beyond the current year) and new/novel strategies the electrical corporation may implement in the next 5 years (e.g., references to and strategies from pilot projects and research)*

Consolidated Inspection Strategy

As discussed in Section 8.2.2.1 Routine Line Clearing (Distribution & Transmission) above, in 2023, SCE will deploy a new centralized inspection schedule to consolidate the inspection processes for Routine Line Clearing, HTMP, and Dead and Dying Tree Removal Program to allow for better contract and planning optimization.

8.2.2.3 Dead and Dying Tree Removal Program

Inspection Process

SCE uses its ground crews to patrol its HFRA to identify dead and dying trees for removal in its Dead and Dying Tree Removal Program. A tree is classified as dead when the canopy has declined 75% or greater and/or is significantly infected with bark beetles or other invasive insects.

After an inspection is performed and the prescription is generated, SCE will remove the tree consistent with industry practice. This is discussed further below in Section 8.2.3.4 Fall-In Mitigation.

The Dead and Dying Tree Removal Program will also be impacted by the implementation of the consolidated inspection strategy. Please refer to Figure SCE 8-49 in Section 8.2.2.1 for the workflow of the consolidated inspection process.

Frequency or Trigger

For the Dead and Dying Tree Removal program, inspections are performed in applicable areas within Tier 2 and Tier 3 of SCE's HFRA. Applicable areas are determined based on California's Tree Mortality Task Force,²⁰⁴ which updates maps annually to show High Hazard Zones and Hazard Severity Zones. SCE utilizes these Tree Mortality Task Force categories to incorporate risk prioritization into the Dead and Dying Tree inspection scope.

Starting in 2023, inspections for the Dead and Dying Tree Removal program will be scheduled based on the consolidated inspection strategy. All Hazard Severity Zones and HFRA tiers 2 and 3 have been mapped to a grid/circuit or grids/circuits²⁰⁵ and will be inputted in SCE's work management tool based on planning month. Building off the Routine Line Clearing schedule (which covers all SCE service area, and not just the applicable areas within Tier 2 and Tier 3 of HFRA targeted by the Dead and Dying Tree Removal program), inspectors who are sent during "cycle buster"²⁰⁶ visits looking for uncharacteristic growth will

²⁰⁴ For more information, see the link for the [California Tree Mortality Task Force](#).

²⁰⁵ In 2025, SCE intends to return to circuit based mapping for all VM inspections to align with T&D processes.

²⁰⁶ Cycle buster visits typically occur on a six-month cadence and are intended to address vegetation that will not make it through the annual routine trim cycle without encroaching on the required minimum clearances and which therefore require pruning midterm before the routine cycle is completed.

now have the opportunity to identify hazard trees in addition to routine maintenance.

Accomplishments, Roadblocks, and Updates

- *Noteworthy accomplishments for the inspection program since the last WMP.*

In 2022, SCE continued to conduct the Dead and Dying Tree Removal Program as planned and consistent with past practices.

- *Roadblocks the electrical corporation has encountered while implementing the inspection program and how the electrical corporation has addressed the roadblock.*

Inspections can be impeded by customer refusals, but these constraints, among others, are more prevalent when SCE executes remediation. Please see the discussion in Section 8.2.3.3.1 describing customer refusals and other constraints, which can impact the Dead and Dying Tree Removal Program.

- *Changes/updates to inspection program since the last WMP Including known future plans (beyond the current year) and new/novel strategies the electrical corporation may implement in the next 5 years (e.g., references to and strategies from pilot projects and research)*

Consolidated Inspection Strategy

As discussed in Section 8.2.2.1 Routine Line Clearing (Distribution & Transmission) above, in 2023, SCE will deploy a new centralized inspection schedule to consolidate the inspection process for Routine Line Clearing, HTMP, and Dead and Dying Tree Removal Program to allow for better contract and planning optimization.

8.2.2.4 Remote Sensing Inspections

8.2.2.4.1 LiDAR Inspections

Inspection Process

In this section, the electrical corporation must provide an overview of the individual vegetation inspection and inspection criteria. Include the various methods of inspection conducted for each inspection program. Include relevant visuals and graphics that depicts the workflow and decision process the electrical corporation uses for the inspection program (see example Figure 8-3).

LiDAR is a surveying inspection method that measures distance to a target by illuminating the target with pulsed laser light and measuring the reflected pulses with a sensor. Differences in laser return times are then used to make digital three-dimensional representations of field conditions at the time of survey.

LiDAR for Transmission Assets

For Transmission lines, SCE calculates the maximum sag and sway of conductors (modeled conditions under maximum current load and maximum wind load) and compares the resulting conductor positions

under those “worst case scenarios” to existing vegetation as determined by LiDAR for the purposes of determining where mitigation is required. This form of inspection supplements and has the potential to help reduce/replace the typical ground-based, visual vegetation management inspections used as part of the maintenance of minimum clearance distances under maximum heat, wind, and load conditions.

SCE provides LiDAR data to inspectors conducting foot patrols on circuits, when available, to assist them in identifying potential encroachments and to help them validate that right-of-way clearances fully account for conductor dynamics. SCE uses LiDAR technology to inspect select Transmission and Sub-Transmission lines in accordance with FAC 003-4, General Order 95, Rule 35, and Public Resources Code 4293 to maintain appropriate clearances between SCE’s lines and vegetation.

Implementation of LiDAR for Bulk Transmission Lines was a 2019 WMP initiative and the use of LiDAR was operationalized using the class ranking system.²⁰⁷ The success of the initiative demonstrated the effectiveness of using LiDAR for Transmission

inspections. LiDAR delivers consistently accurate results and allows for inspection of difficult terrain that may be inaccessible to ground inspectors.

LiDAR for Distribution Assets

Currently, utilizing LiDAR on a large scale to supplement routine Distribution-related inspections is not feasible primarily because inspections for SCE’s distribution network is grid-based, while deploying LiDAR occurs on a circuit basis. As discussed in sub-section Circuit Basis in Section 8.2.2.1, SCE plans to transition to deploying work on a circuit basis by 2025. Once the circuit-based approach is implemented, SCE plans to use LiDAR to supplement or replace routine Distribution inspections

The workflow for LiDAR is illustrated below in Figure SCE 8-40.

²⁰⁷ The class ranking system is a schedule based on criteria for LiDAR surveys to be performed and the frequency that LiDAR is used on impacted rights-of-way within the SCE System, as described in SCE’s UVM-06 LiDAR Schedule Reference Guide, Section 3.1.

Figure SCE 8-40 - LiDAR Process Flow

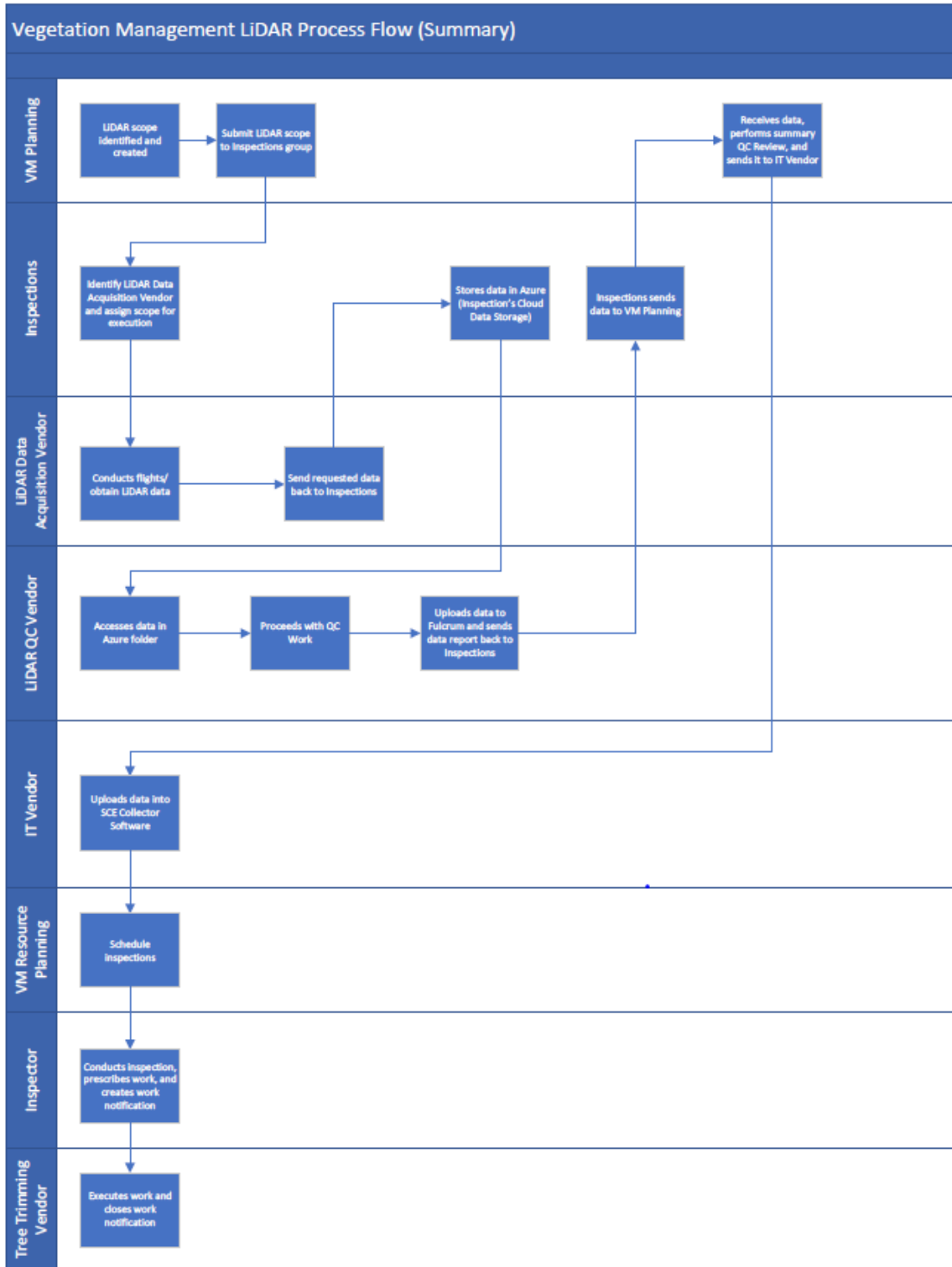

Frequency or Trigger

In this section, the electrical corporation must define and identify the frequency (including how frequency may differ by HFTD or other risk designation[s]) or triggers of the inspection program, such as inputs from the risk model.

If the inspection program is schedule based, the electrical corporation must explain how it uses risk prioritization in the scheduling of the inspection program to target high-risk areas. If the electrical corporation does not use risk prioritization in the scheduling of the inspection program, it must explain why.

LiDAR for Transmission Assets

As documented in SCE's UVM-06, SCE uses a class ranking system to establish a schedule for LiDAR surveys to be performed on Transmission lines based on certain criteria. SCE provides the LiDAR Right-of-Way (ROW) Schedule via the Class designation for each ROW in UVM-06.

For 2023 and 2024, SCE plans to utilize LiDAR in Transmission as a supplemental tool to support inspections on circuits according to their class designation. Additionally, SCE will continue to evaluate the use of LiDAR to replace ground inspections for low-risk areas²⁰⁸ and advance internal processes on how to auto-prescribe work to trim crews. Also, to realize additional remote sensing benefits, SCE plans on conducting targeted inspections based only on LiDAR-identified points rather than inspecting entire circuits via ground inspections. Lastly, this two-year window will also be critical to calibrate fall-in and grow-in modeled clearances in SCE's licensed Visualization & Analytics software. This calibration will enable SCE to begin building a vegetation inventory model that connects the LiDAR clearance data to the vegetation inventory's corresponding species and predicted growth rates.

Beginning in 2025, SCE will create a baseline set of fall-in/grow-in data points for the vegetation inventory across SCE's electrical assets, which will determine future LiDAR data capture optimization needs. SCE can build on this baseline LiDAR data to add to the inventory and process and visualize clearances systematically. Achieving this capability may allow SCE to revise or eliminate the Transmission class ranking system.

LiDAR for Distribution Assets

The use of LiDAR on SCE's distribution assets for inspections occurred for the first time in 2022 to support AOC. No trigger or frequency can be established from this occurrence. SCE provides more details on the use of LiDAR for AOC in the below section Accomplishments.

Accomplishments, Roadblocks, and Updates

- *Noteworthy accomplishments for the inspection program since the last WMP.*

Area of Concern (AOC)

In 2022, LiDAR was successfully deployed to support AOC (Area of Concern) for the first time. This method was used as a quicker way to identify abnormal growth and unexpected risks. Inspectors were

²⁰⁸ A low-risk area is one defined by low inventory circuits with fewer than 50 inventory points and more than five miles long or long circuits over 50 miles in desert areas.

deployed to verify LiDAR points on the ground, and as a result of the accuracy of LiDAR measurements, did not have to inspect the entire circuit. Section 8.2.3.1.1 and Section 8.1.3.1 provide more details on AOCs.

- *Roadblocks the electrical corporation has encountered while implementing the inspection program and how the electrical corporation has addressed the roadblock.*

Weather Delays and Vendor Procurement

Some challenges that SCE has encountered with LiDAR include delays caused by weather and vendor procurement. While flights are scheduled as far in advance as possible for cost and schedule reasons, if inclement weather prohibits a flight due to safety concerns, the flight is rescheduled to the next earliest possible date.

SCE is currently working to engage multiple vendors to facilitate fewer interruptions in the execution of work. For instance, if one vendor has issues accomplishing the scope, SCE may request another vendor to assist in completing the scope. In addition to revising the acquisition and processing procurement strategy, SCE is expanding acquisition and processing capabilities, as detailed in Section 8.1.3.1.

- *Changes/updates to inspection program since the last WMP Including known future plans (beyond the current year) and new/novel strategies the electrical corporation may implement in the next 5 years (e.g., references to and strategies from pilot projects and research)*

Expanded Capabilities for LiDAR Inspections

SCE plans to improve the internal capability to collect, process, visualize and analyze vegetation clearances from LiDAR data, and vegetation health data from multispectral and hyperspectral imaging, respectively. As mentioned above, SCE also plans to capture a baseline LiDAR data set of fall-in/grow-in points. This data would eventually be systematically associated with the vegetation inventory. With a newly formed digital database, SCE expects to use AI/ML to develop schedules and determine work prescriptions.

SCE Inspection Team Software Dependency

In 2023, SCE plans to utilize licenses of a SaaS LiDAR Visualization & Analytics software platform to automate the vegetation encroachment clearance calculations and identify instances where Priority 1 (P1) clearance is not met at a network scale. Between Q3 2023 and Q2 2024, SCE plans to train the model and simultaneously test the algorithm to transition from vendor performed processing and analytics and move toward utilizing the SaaS licensed platform. After establishing the vegetation inventory, SCE anticipates being able to associate the inventory with vegetation encroachment clearance calculations and instances when P1 clearances are not met. Once the clearance data is mapped to the associated vegetation inventory, additional data such as vegetation health, species, and other attributes can be incorporated into the vegetation inventory to enable future AI/ML capabilities such as predictive growth, predictive trims, designation of high-risk areas, and network level vegetation health and density information. Advanced details around the integration of Vegetation Management's work management tool among the various analytics software are forthcoming. As mentioned in Section 8.1.3.1, SCE will execute the 2023 LiDAR Operations RFP to maintain current state procured third-party capabilities while concurrently building out in-house capabilities.

Work Prescriptions

The increase in utilization of remote sensing technology and related software is intended to reduce the amount of ground inspections over time. However, processes related to generating tree prescriptions through remote sensing technology and collecting environmental data attributes need to be developed further to complete the transition. Currently, prescriptions require a ground crew inspector to record a comprehensive amount of information including species, environmental considerations, and specifics regarding tree structure and health. To obtain this information through remote sensing technology, the use of multispectral and hyperspectral imagery along with AI/ML may become necessary. Even with those technologies in place, other information currently required for prescriptions may not be obtainable with remote sensing. In a multi-faceted effort to address these challenges and ultimately achieve the ability to issue prescriptions via remote sensing, SCE will be exploring the following:

- Employing the use of multispectral and hyperspectral imaging data processing through various mediums such as satellite
- Augmenting various data types (multispectral and LiDAR) with AI/ML technologies to perform optimized remote vegetation inspections
- Employing the use of AI/ML technologies on SCE Inspections' in-house software platform
- Potentially reducing the amount of information required for prescriptions
- Creating "hybrid" trim crews comprised of one or more individuals capable of completing prescriptions at the same time trim work takes place without a separate inspection visit
 - Initial prescription created via remote sensing and final prescription completed by trim crew
- Leveraging personnel in environmentally sensitive areas who pre-field, or examine site conditions, prior to trim work taking place
 - Initial prescription created via remote sensing and final prescription completed by pre-fielding personnel

8.2.2.4.2 Satellite Inspections

Inspection Process

In this section, the electrical corporation must provide an overview of the individual vegetation inspection and inspection criteria. Include the various methods of inspection conducted for each inspection program. Include relevant visuals and graphics that depicts the workflow and decision process the electrical corporation uses for the inspection program (see example Figure 8-3).

In 2022, SCE launched a pilot program to test the use of satellite technology for confirming the accuracy of vegetation clearances and identifying trees near overhead lines. This program evaluated a satellite's ability to identify the need for remediation on circuits with lower tree density

using hyperspectral imaging to identify vegetation health, density, and species. A variety of Transmission circuits were selected for this effort and results were validated against ground inspection data.

Similar to LiDAR, satellite-based inspection may be used to supplement or replace ground-based, visual vegetation management inspections to help maintain minimum clearance distances under maximum heat, wind, and load conditions. Satellite technology may be a viable alternative for inspecting circuits and could prove less expensive than LiDAR because it would not require helicopters or ground inspectors in the field. Satellite technology could also be a companion to LiDAR in higher risk areas by providing hyperspectral imagery and allowing SCE to reallocate resources, such as ground inspectors, to other areas. An additional use case for satellite is to evaluate tower locations that are only accessible by helicopter to determine if there is a need for brushing work prior to dispatching a helicopter-based brushing crew to the location. This provides the potential to reduce time, risk, and cost for the structure brushing activities. The benefits for all use cases are still under evaluation.

The projected implementation for satellite is generally the same as that of LiDAR. Below are three potential use cases that SCE is evaluating for satellite technology. SCE will continue to evaluate the viability, cost-effectiveness, operational feasibility, and other factors of satellite technology before adopting satellite technology into its Vegetation Management portfolio and deploying it for these use cases.

1. Satellite to Drive Inspections

- a. Use satellite data as the primary reference for ground inspectors to locate work points.
- b. Dispatch ground inspectors to work points identified by satellite only.
- c. Consider the remainder of the circuit clear.
- d. As with LiDAR, there may be a potential to save time and expenses related to ground inspector work with this method.

2. Satellite to Replace Inspections

- a. Use satellite as the complete inspection, obviating the need for ground inspections.
- b. Auto-prescribe all identified work points and assign to trim crews
 1. Requires the use of hyperspectral imagery to identify species (if required for prescriptions)
- c. Use historical imagery, ongoing scans, and AI/ML to create a working predictive analysis model of a circuit that predicts growth rate of inventory to facilitate planning on when and where trims will be required

- d. Prescribe work based on predictions and validate new or eliminated inventory via ongoing scans
 2. Requires a one-time effort to create the existing tree inventory in SCE's LiDAR and Visualization and Analytics and/or other data platform(s)

3. Satellite to Assist LiDAR

- a. Use the hyperspectral imagery and AI/ML to identify species and tree health
- b. Assist with LiDAR to facilitate auto-prescriptions

Frequency or Trigger

In this section, the electrical corporation must define and identify the frequency (including how frequency may differ by HFTD or other risk designation[s]) or triggers of the inspection program, such as inputs from the risk model.

If the inspection program is schedule based, the electrical corporation must explain how it uses risk prioritization in the scheduling of the inspection program to target high-risk areas. If the electrical corporation does not use risk prioritization in the scheduling of the inspection program, it must explain why.

Satellite technology is a pilot program and therefore, does not have a schedule. The scope will be strategically developed to test the functionality of satellite within each of the Vegetation Management programs listed in Table SCE 8-06. For more information on future frequency see the "Changes/Updates" section below.

Accomplishments, Roadblocks, and Updates

- Noteworthy accomplishments for the inspection program since the last WMP.

In 2022, SCE launched a pilot program to test the use of satellite technology for confirming the accuracy of vegetation clearances and identifying trees near overhead lines. This program evaluated a satellite's ability to identify the need for remediation on circuits with less dense vegetation while using hyperspectral imaging to identify vegetation health, density, and species. Lower vegetation density circuits have vegetation points that are more easily identifiable, thus allowing SCE to become more familiar with satellite's capabilities. While SCE is still evaluating results, the results appear favorable in the areas of clearances, species identification, health identification, and inventory counting.

- *Roadblocks* the electrical corporation has encountered while implementing the inspection program and how the electrical corporation has addressed the roadblock.

Limited Resolution

While satellite possesses an advantage over ground inspections in terms of hyperspectral imagery and subsequent species/health identification, the current centimeter resolution is not accurate enough to use the tool independent of ground verification. As satellite technology matures, the capability and accuracy of satellite distance measurements should also improve. Public satellites with better resolution are forecasted to be launched and in orbit in the three-year WMP window, and SCE plans to continue

piloting with the goal of transitioning to more remote sensing as the technology continues to improve.

- Changes/updates to inspection program since the last WMP Including known future plans (beyond the current year) and new/novel strategies the electrical corporation may implement in the next 5 years (e.g., references to and strategies from pilot projects and research)

Table SCE 8-09 below displays ways in which SCE is considering using satellite for its Vegetation Management programs.

Table SCE 8-09 - Satellite’s Future Potential

Vegetation Management Programs	Potential Implementation of Satellite
<ul style="list-style-type: none"> • Routine Line Clearing 	<ul style="list-style-type: none"> - Drive inspections (clearance analysis) - Replace inspections (auto prescription) - “Cycle Buster” activities (predictive analysis)
<ul style="list-style-type: none"> • HTMP and Dead and Dying Tree Removal Program 	<ul style="list-style-type: none"> - Assess tree health/need for mitigation (hyperspectral/species analysis)
<ul style="list-style-type: none"> • Structure Brushing 	<ul style="list-style-type: none"> - Identify the existence of vegetation and need for mitigation work (hyperspectral analysis)
<ul style="list-style-type: none"> • Weed Abatement 	<ul style="list-style-type: none"> - Identify the existence of vegetation and need for mitigation work (hyperspectral analysis)
<ul style="list-style-type: none"> • Supplemental Patrols 	<ul style="list-style-type: none"> - Drive or perform inspections (clearance analysis) - Determine the need for patrols (predictive analysis)
<ul style="list-style-type: none"> • QA/QC 	<ul style="list-style-type: none"> - Post-work verification (clearance analysis)

For 2023 and beyond, SCE plans to expand the satellite technology pilot program by adding approximately 1,000 circuit miles per year, depending on the technology’s evolution. Additionally, SCE intends to increase the evaluation of inaccessible tower locations in the structure brushing program by approximately 50 sites per year. The full implementation of satellite technology throughout Vegetation Management’s programs depends on: 1) improvements in accuracy, 2) SCE inspections processing software, and 3) integration with Arbora. These efforts are all in development.

8.2.3 Vegetation and Fuels Management

In this section, the electrical corporation must discuss the following mitigation initiatives associated with vegetation and fuels management:

1. *Fuels management*
2. *Clearance*
3. *Fall-in mitigation*
4. *Substation defensible space*
5. *High-risk species*
6. *Fire-resilient right-of-way*
7. *Emergency response vegetation management*

In the following subsections, the electrical corporation must provide an overview of its vegetation and fuels management initiatives. These overviews should include figure(s) that depict the workflow and decision process used for vegetation and fuels management. Figure 8-3 provides an example of the appropriate level of detail for tree trimming and removal.

In addition to figure(s), the electrical corporation must provide a narrative overview of each vegetation and fuels management initiative. The discussion must include the following:

- *Utility Initiative Tracking ID.*
- **Overview of the initiative:** *A brief description of the initiative including reference to related objectives and targets.*
- **Governing standards and electrical corporation standard operating procedures:** *Reference to the appropriate code and electrical corporation procedure. If any standard exceeds regulatory requirements, the electrical corporation must reference the document that the electrical corporation uses as a basis for exceeding the regulatory requirements.*
- **Updates to the initiative:** *Changes to the initiative since the last WMP submission and a brief explanation as to why those change were made. Discuss any planned improvements or updates to the initiative and the timeline for implementation.*

8.2.3.1 Pole Clearing

In this subsection, the electrical corporation must provide an overview of pole clearing activities, including:

- *Pole clearing per Public Resources Code section 4292*
- *Pole clearing outside the requirements of Public Resources Code section 4292 (e.g., pole clearing performed outside of the State Responsibility Area)*

8.2.3.1.1 Structure Brushing

Utility Initiative Tracking ID: VM-2 (formerly Expanded Pole Brushing)

Overview of initiative – Brief description of the initiative including the objective and the risk targeted by the initiative.

Vegetation at the base of poles and structures can provide the fuel needed to convert a spark from equipment failure into a fire. This vegetation can also support fire propagation, especially during dry and windy conditions. Additionally, even where the equipment is not the source of the ignition, brush surrounding a pole may catch fire and damage electric assets, impeding power restoration and reconstruction efforts. Thus, SCE removes vegetation around all poles and structures subject to PRC 4292 in State Responsibility Areas, while targeting additional Distribution poles outside of these areas in HFRA for risk mitigation.

The figure below illustrates the clearances around structures as required by PRC 4292. The structure brushing program maintains clearance from the ground up to 8 feet. Clearances above 8 feet are maintained in Routine Line Clearing.

Figure SCE 8-41 - Structure Brushing Program

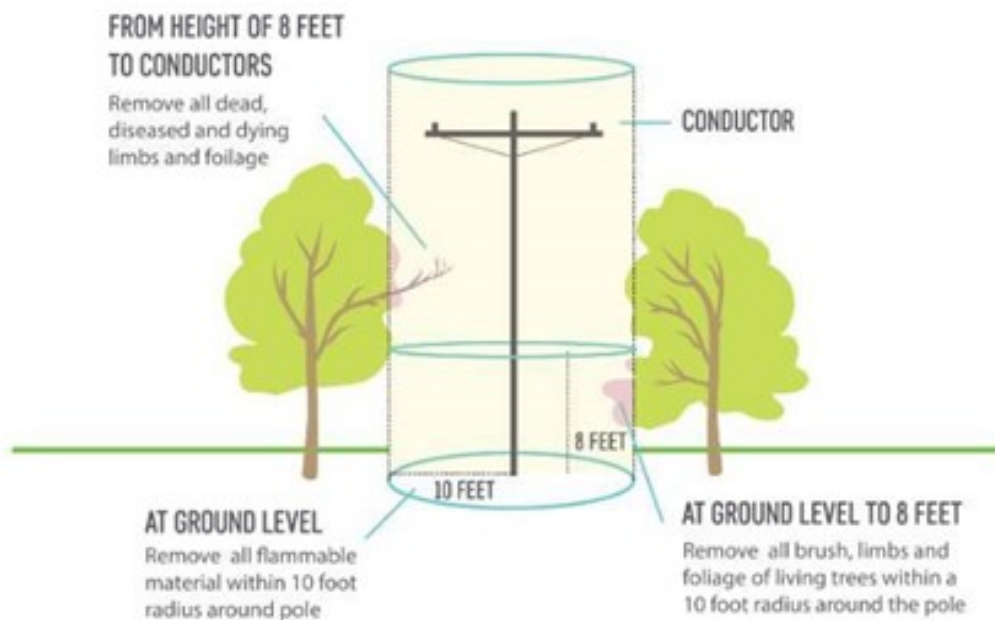

One of SCE's priorities is to maintain clearance on those poles subject to PRC 4292 in State Responsibility Areas. SCE also prioritizes poles in AOC in HFRA. The AOC population aims to mitigate risk in areas identified by SCE's Fire Science team that pose intra-year increased fuel-driven and wind-driven fire risk. SCE also addresses other poles identified in HFRA with non-exempt equipment and highest potential wildfire consequence. SCE considers both regulatory compliance and ignition risk in prioritizing its brushing schedule, as well as access issues (e.g., landowner consents, environmental approvals) and operational efficiency.

The figure below illustrates the workflow and decision process for all structure brushing scope.

Figure SCE 8-42 - Structure Brushing Decision Process

2023 VEGETATION MANAGEMENT STRUCTURE BRUSHING SCOPE

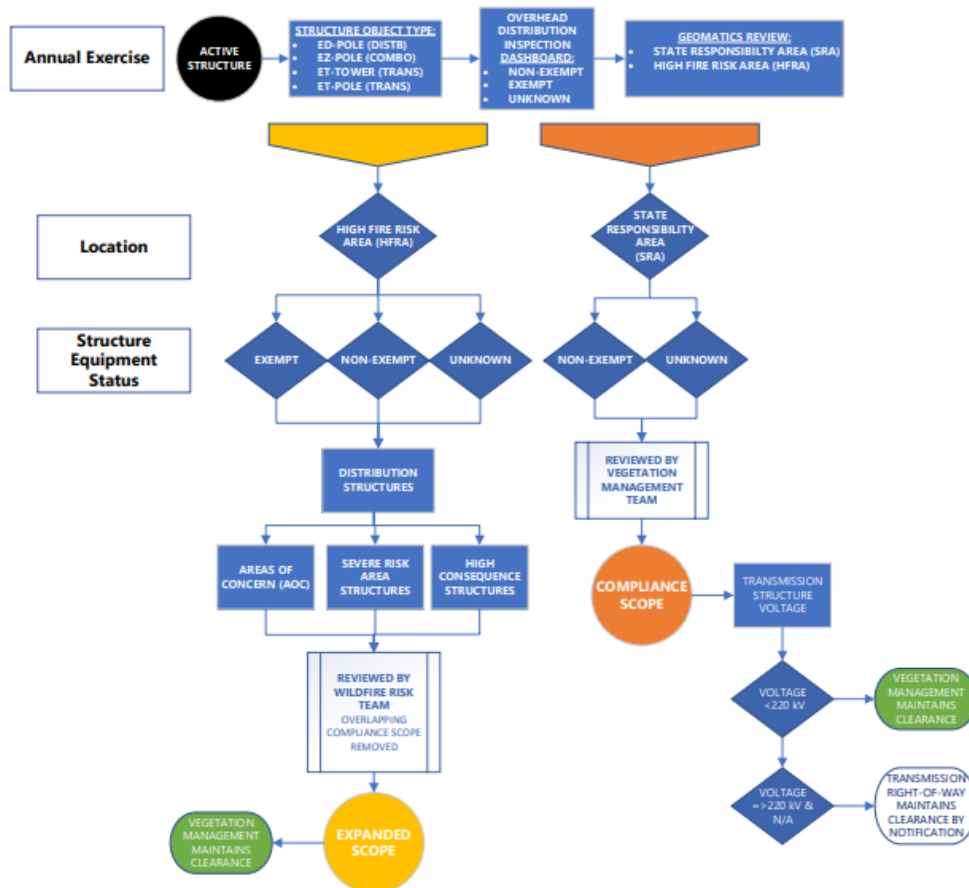

Governing standards and electrical corporation standard operating procedures – Reference to the appropriate code and electrical corporation program/process. If any standard exceeds regulatory requirements, this must include reference to the basis document for the electrical corporation-specific values.

PRC 4292

California Public Resource Code (PRC) 4292 and related regulations require utilities in certain areas and at certain times to “maintain around and adjacent to any pole or tower which supports a switch, fuse, transformer, lightning arrester, line junction, or dead end or corner pole, a firebreak which consists of a clearing of not less than 10 feet in each direction from the outer circumference of such pole or tower.” The structure brushing program removes vegetation at the base of distribution poles to reduce the risk of ignition and/or fire spread due to a spark or contact with failed equipment. This activity removes vegetation around applicable structures subject to PRC 4292 in State Responsibility Areas, while

targeting additional distribution poles in HFRA for further risk mitigation.

The scope incremental to that required by PRC 4292 aligns with SCE's IWMS which targets distribution structures in AOCs, Severe Risk Areas, and High Consequence Segments. These areas have been identified to present heightened wildfire risk and are being targeted for grid hardening with additional mitigations, which includes additional Vegetation Management activities like structure brushing.

Climate Adaptation Vulnerability Assessment

SCE filed its first Climate Adaptation Vulnerability Assessment (CAVA) on May 13, 2022 as required by CPUC D.20-08-046. This Decision required utilities to study climate risks to their assets, operations, and services and to file the assessment results one year before their GRC to enable the results of the assessment to inform GRC requests. In the CAVA, wildfire was studied as a climate variable of concern alongside temperature, sea level rise, precipitation, and cascading events. Importantly, CAVA studied the risks wildfires pose to utility infrastructure and operations, and not the risks from ignitions associated with utility equipment. The CAVA included a detailed analysis of the exposure of assets, operations, and services to wildfire, the adaptive capacity of the system to continue to provide service to customers in the event of climate-related disruption, and the potential impacts on vulnerable communities and community adaptive capacity, as developed through an in-depth community engagement process. The CAVA identified structure brushing as one potential adaptation strategy to limit the probability of fires damaging high-risk sub-transmission poles.

Climate projections show that fire exposure is projected to increase in and around HFRA, which already have an elevated risk of wildfires.²⁰⁹ Summer wildfires are projected to become more intense, particularly in mountainous regions. Most non-HFRA portions of SCE's service area are projected to experience fire exposure similar to their historical exposure. Based on this analysis and subject to approved cost recovery, SCE proposes to add a limited scope of approximately 200 structures to its sub-transmission pole brushing activity in HFRA, incremental to the pole brushing activity already discussed in this WMP. The current pole brushing scope is intended to mitigate the risk of utility-caused ignitions, while the additional scope proposed in this section is intended to adapt to higher burn activity resulting from climate change. The sub-transmission poles proposed as incremental scope were selected based on the highest projected burn areas in 2030 and are located in geographic proximity to other pole brushing scope. This activity is projected to begin in 2025.

Updates to initiative - Changes to the initiative since the last WMP submission and a brief explanation as to why those changes were made. Discuss any planned improvements or updates to the initiative and timeline for implementation.

In 2023, SCE plans to explore leveraging AI/ML to improve structure brushing prioritization and furthering the integration of pole brushing into SCE's IWMS by targeting structures in severe and high consequence areas.

Also, as mentioned above, in 2025 SCE plans to increase the scope of its sub-transmission pole brushing activity in response to the CAVA analysis, if approved in the 2025 GRC.

²⁰⁹ Climate Change Vulnerability Assessment Pursuant to Decision 20-08-046, Section IV.D.1, pp.104-108.

8.2.3.1.2 Reduction or adjustment of live fuel (based on species or otherwise)

See Section 8.2.3.6 for details regarding the fuel management of “high-risk species”, Section 8.2.3.7 for details regarding the management of live fuel in rights-of-way and Section 8.2.3.1.1 above for details on the management of live fuel at the base of structures.

8.2.3.2 Wood and Slash Management

In this subsection, the electrical corporation must provide an overview of how it manages all downed wood and “slash” generated from vegetation management activities, including references to applicable regulations, codes, and standards.

8.2.3.2.1 Reduction or adjustment of dead fuel, including all downed wood and “slash” generated from vegetation management activities

Utility Initiative Tracking ID: Reduction of downed wood and slash from Vegetation Management activities is incorporated into each Vegetation Management initiative and therefore relates to VM-1 through VM-4, VM-7, and VM-8. SCE describes these efforts in this section.

Overview of initiative – Brief description of the initiative including the objective and the risk targeted by the initiative.

Vegetation Management activities produce woody debris that, if not properly handled, can act as fuel around or near electrical equipment and other critical infrastructure and increase the probability of ignition and spread of wildfire. SCE reduces slash (e.g., cut limbs and other woody debris) from Vegetation Management activities by chipping and hauling the material away to be disposed or recycled by pruning/removal contractors.

SCE’s contract crews strive to remove all wood and material resulting from mitigation for Routine Line Clearing, Structure Brushing, HTMP, and the Dead and Dying Tree Program typically within 100 feet of a dirt or paved road, subject to site conditions. On private property, crews will typically strive to remove all wood, providing that crews are able to maneuver and operate their equipment close enough to the area (e.g., skid steers). On federal lands, crews will typically remove logs, branches, and debris within 100 feet of a road or structure. Beyond 100 feet, SCE lops and scatters the limbs and brush with a height no greater than 18 inches above the ground and leaves logs greater than four inches in manageable sections, subject to site conditions.

SCE’s pruning and removal contractors abide by the standard cleanup and disposal expectations for work sites. Removal and disposal of debris generated during SCE vegetation management activity, except as requested by the customer (e.g., for firewood or mulch) or where logistical constraints exist (e.g., steep slope with no vehicular access), is typically performed the same day. For example, where possible, all debris after pruning or removal is chipped with trailer chippers and hauled away from the work site. In some cases, debris is moved the following day due to the volume or is not removed at all due to logistical constraints. Where logistical constraints exist, SCE will work to mitigate the potential fuel risk by scattering the debris according to best practices or any existing fuel management plan applicable to the work site. Concerted efforts are made to rake up and dispose of green or freshly removed leaves, and work sites are left in a condition consistent with the condition prior to Vegetation Management activity.

Governing standards and electrical corporation standard operating procedures – Reference to the appropriate code and electrical corporation program/process. If any standard exceeds regulatory requirements, this must include reference to the basis document for the electrical corporation-specific values.

Reducing slash from Vegetation Management initiatives is a standard prudent practice conducted during Vegetation Management activities, as documented in UVM-02 and UVM-03. SCE requires its Vegetation Management contractors to include debris removal as part of their Statement of Work, with a few exceptions such as in remote forested areas where lopping and scattering debris approximately 100 feet from the road, subject to site conditions, is generally permitted.

Updates to initiative - Changes to the initiative since the last WMP submission and a brief explanation as to why those changes were made. Discuss any planned improvements or updates to the initiative and timeline for implementation.

There have been no updates since the last WMP submission.

8.2.3.3 Clearance

In this subsection, the electrical corporation must provide an overview of clearance activities, including:

- Clearances established in excess of the minimum clearances in Table 1 of GO 95
- The bases for the clearances established

8.2.3.3.1 Expanded Clearing (Clearances established in excess of the GO 95 minimum required clearances in Table 1 of GO 95 - for purposes of clarification SCE utilizes the GRCD as verification that an expanded clearance has been obtained)

Utility Initiative Tracking ID: SCE seeks to achieve expanded clearances where feasible in HFRA as part of its Routine Line Clearing activities (Distribution Vegetation Management Plan (VM-7) and Transmission Vegetation Management Plan (VM-8)), and thus this activity does not have a separate tracking ID.

Overview of initiative – Brief description of the initiative including the objective and the risk targeted by the initiative.

SCE performs expanded line clearances to mitigate the risk of vegetation contact with energized conductors. For line voltages between 2.4 kV to 69 kV, vegetation can create a risk to SCE facilities when the vegetation is located in “grow-in zones” (i.e., beneath or adjacent to the conductors), “blow-in zones” (i.e., within general proximity to conductors where there exists the risk of vegetation being blown into conductors), and “fall-in zones” (i.e., outside of the grow-in zone but within striking distance of conductors). For line voltages greater than 115 kV, SCE has a “wire-zone” which is defined as the area directly beneath the conductors and includes the distance of the conductors at maximum sway condition. Vegetation within this zone has grow-in and fall-in potential, which creates risk to SCE equipment and facilities.

SCE utilizes the Grid Resiliency Clearance Distance (GRCD) to verify whether an expanded clearance has been obtained. In HFRA, SCE strives to obtain expanded clearances of 12 feet for Distribution lines, and 30 feet for Transmission lines. At a minimum, SCE’s Routine Line Clearing work within HFRA maintains at

least the required four feet clearance for Distribution lines and the required 10 feet clearance for Transmission lines for a full annual inspection cycle. Where GRCD has been achieved historically, SCE strives to maintain the expanded clearance thereafter. Additionally, within the wire-zone, fast-growing species are targeted for removal if the species has the capability to encroach into the wire zone.

Over the last two years, SCE has worked to categorize the GRCD exemption status of trees in HFRA to support analysis and understanding of the total inventory available to achieve expanded clearances. Over the next three years, SCE seeks to improve the support and execution of expanded clearing by applying the TRI calculations to SCE’s high fire inventory and overlaying that data set with the GRCD exemption status from the 2022 annual cycle. SCE’s initial efforts will focus on highly challenged districts in high TRI ranking quadrants.

The figure below depicts the various types of clearance to be achieved, with Regulation Clearance Distance (RCD) representing required distance per GO 95 and GRCD representing expanded clearing.

Figure SCE 8-43 - Clearance Descriptions²¹⁰

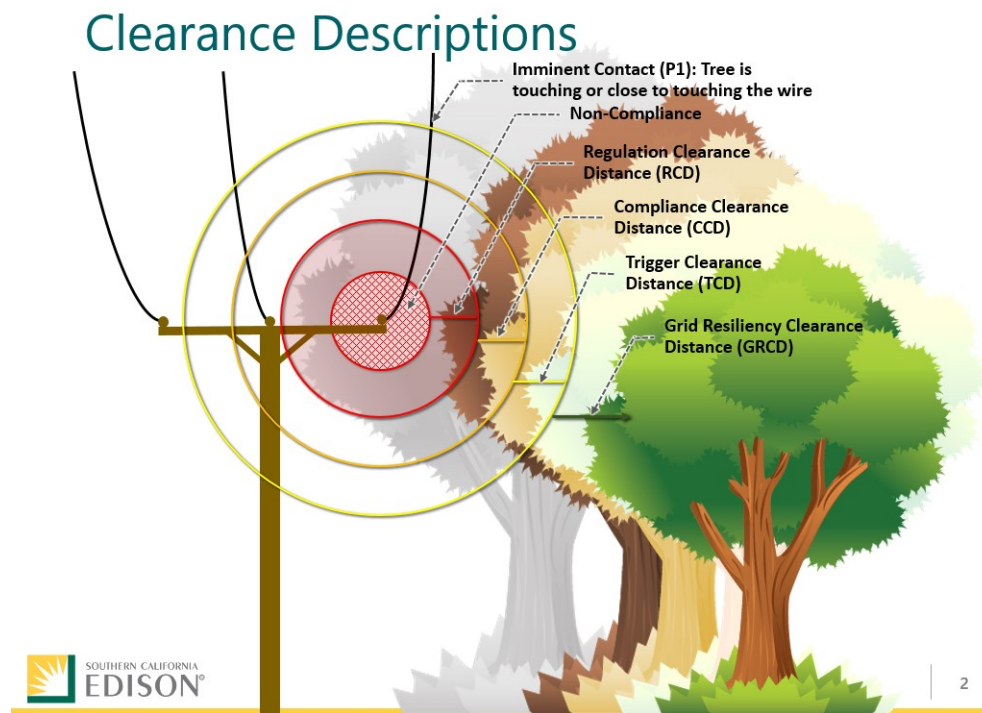
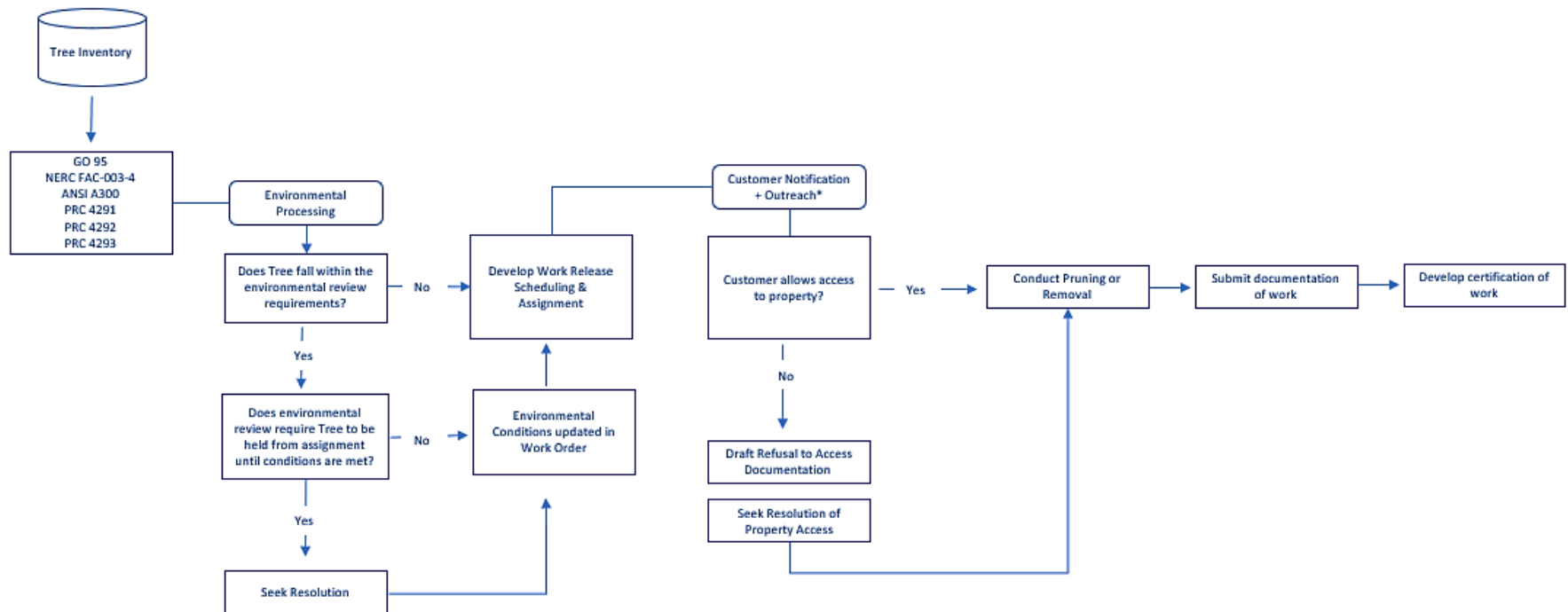

Figure 8-3 below shows the workflow for the remediation work, including trimming and removal, performed under Routine Line Clearing, HTMP and Dead and Dying Removal Program.

²¹⁰ RCD means Regulatory Clearance Distance, and is the minimum clearance required by regulation. CCD means Compliance Clearance Distance and is SCE’s minimum clearance standard which is 1.5 times the RCD. TCD means Trigger Clearance Distance. TCD is derived from CCD plus 3 feet and is the distance that triggers the maintenance activity. GRCD is the Grid Resiliency Clearance Distance, which aligns with the GO95 Rule 35, Appendix E recommended clearance.

Figure 8-3 - Trim and Removal Workflow

Vegetation Management Routine Line Clearing/ HTMP/ Dead and Dying Tree Trimming and Removal Workflow



*Notification process for Routine and Heavy Tree differs slightly based on material requirements (door hanger vs letter) on timeline for customer to respond (See UVM XX)

In some instances, SCE may not achieve expanded clearances due to the factors noted in the table below.

Table SCE 8-10 - Operational Factors

Operational Factors	Description
Agency and environmental regulatory requirements	Work in environmentally sensitive areas may be restricted in both scope and timing, or may require a lengthy permitting process, making timely expanded clearances infeasible. For more information, see the Environmental Compliance and Permitting in Section 5.4.5
Crew equipment	Trees that may require the use of specialized equipment/needs (such as a crane or outage) to safely and adequately achieve the GRCD
Customer denies GRCD	Customer requests to not trim back “more” than in previous trim cycles. No authorization from property owners to clear beyond Regulation Clearance Distance (RCD) + 1-year’s growth. SCE takes appropriate and at times, extensive, steps to engage customers in these matters.
PRC Exemption (Major Woody Stem)	Trees that qualify for Cal. Code Regs. Tit. 14, § 1257 - exempt minimum clearance provisions
Site condition/environmental factors	Crew-identified conditions at time of work being performed which necessitate less than desired clearance (e.g., active wildlife nests or site construction). For more information, see the Environmental Compliance and Permitting in Section 5.4.5
Tree condition	Indication that the tree could not be cleared back to the GRCD without a significant impact to the tree health and could ultimately worsen tree health and increased potential for future hazardous tree conditions
UVM Exception (e.g., Oaks, Conifers, Historic, etc.)	Trees known to have slower growth rates/risk profiles and have regional, local, or arboricultural requirements that prevent the GRCD from being achieved

Governing standards and electrical corporation standard operating procedures – Reference to the appropriate code and electrical corporation program/process. If any standard exceeds regulatory requirements, this must include reference to the basis document for the electrical corporation-specific values.

For expanded clearing, SCE strives to meet, when possible, the recommended clearances of GO 95 Rule 35, Appendix E.

These standards have been incorporated into SCE’s Transmission Vegetation Management Plan (TVMP) found in UVM-02 and Distribution Vegetation Management Plan (DVMP) found in UVM-03.

Updates to initiative - Changes to the initiative since the last WMP submission and a brief explanation as the why those change were made. Discuss any planned improvements or updates to the initiative and timeline for implementation.

Helisaw Pilot

SCE has been exploring an alternative method of bulk tree trimming by utilizing helicopters to trim trees. This method would primarily be used on long spans of transmission ROW, where a high density of trees exists. The work is performed by suspending a large saw on a helicopter to trim trees as the helicopter directs it along the ROW, with the ground crew typically removing all debris. SCE is exploring costs and other benefits that might result from using this method of work. The new work method will only be utilized when the project is cost neutral or less than traditional ground maintenance.

Improvements in GRCD Achievement Rate

In 2019, SCE implemented expanded clearances, then known as Grid Resiliency Clearance Distance (GRCD), per the recommendation of GO 95 Rule 35 Appendix E. At present, SCE has an approximate 67% success rate in achieving GRCD. As part of SCE’s collaboration with an independent third-party, SCE is conducting an analysis related to GRCD achievement and will prioritize locations and specific steps to be taken based on the analysis results in an effort to increase the GRCD achievement rate, subject to the operational factors noted in Table SCE 8-10 above.

As a first step, SCE overlaid its GRCD achievement rates to the TRI analysis rankings to prioritize the highest risk districts. SCE has been collecting GRCD deviation data for the past two years and will use that data to develop plans to address each district. SCE plans to deploy an engagement strategy for targeted geographic locations over the next two to three annual cycles to improve GRCD achievement rates, excluding the UVM excepted tree species (e.g., Oaks, Conifers, Historic) and the PRC exempted heavy woody stem species.

8.2.3.3.2 Expanded Clearances for Legacy Facilities

Utility Initiative Tracking ID: Expanded Clearances for Legacy Facilities, VM-3

Overview of initiative – Brief description of the initiative including the objective and the risk targeted by the initiative

Legacy facilities comprise SCE's generation assets located in Tier 2 or 3 in HFRA that have a risk of ignition and include high voltage facilities such as powerhouses, switchyards, and substations. These energized facilities may also be low voltage facilities or assets such as weather stations, valves, pull boxes or other electrified equipment.

Many of SCE's energized legacy facilities, including powerhouses and switchyards, are located in or near heavily forested areas. Electrical facilities in close proximity to vegetation face an increased risk of faults due to vegetation contact, and potential for those faults leading to an ignition. Therefore, this initiative seeks to reduce the risk of vegetation contact associated with these facilities.

The compliance defensible space in accordance with PRC 4291 is 100 feet for occupied facilities and 30 feet for unoccupied structures, respectively. In this initiative, SCE seeks to remove or clear additional vegetation using the standard remediation methods of trims, removals, and/or weed abatement to render the defensible space²¹¹ around a facility even more vegetation-free.

In 2020, SCE completed an analysis of all sites to prioritize treatment based on HFRA tier and assessment findings. SCE's analysis identified 156 legacy facilities in HFRA to be targeted for expanded clearances in the 2020-2022 WMP cycle. In 2020, all 156 sites were assessed, with SCE completing treatment of 62 of the highest risk locations. In 2021, SCE completed treatment of an additional 62 sites, with the remaining 32 sites treated in 2022.

For the current WMP cycle, the scope of the expanded clearance program for legacy facilities is being increased to include an additional 95 legacy facilities. Due to resource constraints, these additional 95 facilities, which represent lower risk than the original 156 sites, were not included in the 2020-2022 cycle.

However, the inclusion of these sites helps to further reduce wildfire risk. In the 2023-2025 cycle, the program will continue maintaining expanded clearance of 95 previously treated legacy facilities that have experienced vegetation re-growth.

Governing standards and electrical corporation standard operating procedures – Reference to the appropriate code and electrical corporation program/process. If any standard exceeds regulatory requirements, this must include reference to the basis document for the electrical corporation-specific values.

PRC 4291 requires a landowner that owns a building in or adjoining a mountainous area, forest-covered lands, shrub covered lands, grass-covered lands, or land covered with flammable material to maintain a defensible space of 100 feet around an occupied building with more intense fuel reductions within 30 feet around the structure. For unoccupied structures (e.g., gatehouse, gauging station, or intake structure),²¹² the defensible space required is 30 feet from the structure.

²¹¹Defensible space comprises the area around a legacy facility which fire personnel can safely enter to defend a legacy facility from fires.

²¹² SCE personnel and contractors may visit these structures (outbuildings) from time to time, but they would not occupy them for an extensive period of time.

SCE incorporates these standards in its procedures found in “SCE VM-3 Program Guide.”

Updates to initiative - *Changes to the initiative since the last WMP submission and a brief explanation as to why those change were made. Discuss any planned improvements or updates to the initiative and timeline for implementation*

SCE identified an additional 95 energized sites located in Tier 2 and Tier 3 of SCE’s HFRA for treatment in 2023 through 2025, as well as re-treatment of 95 previously treated sites. See the above sub-section “Overview of Initiative” for more details.

8.2.3.4 Fall-In Mitigation

In this subsection, the electrical corporation must provide an overview of its actions taken to identify and remove or otherwise remediate trees that pose a high risk of failure or fracture that could potentially strike electrical equipment (e.g., danger trees or hazard trees).

8.2.3.4.1 Hazard Tree Management Program (HTMP)

Utility Initiative Tracking ID: VM-1

Overview of initiative - *Brief description of the initiative including the objective and the risk targeted by the initiative*

SCE’s HTMP is a wildfire mitigation program performed in SCE’s HFRA designed to reduce fall-in or blow-in risk to SCE’s electrical assets posed by green or live trees with specific conditions. Analysis of Tree Caused Circuit Ignition (TCCI) data revealed that a significant number of faults were caused by green trees “falling in” or branches, fronds, or other tree parts from green trees “blowing in” to SCE lines and equipment. These trees were typically outside of the compliance clearance zone.

The purpose of an HTMP assessment is to identify trees that pose a risk to electric facilities based on the tree’s observed structural integrity and site conditions. Some visually healthy trees located beyond the required clearance distances can still pose a fall-in risk, depending on the condition of the tree and other site-specific factors. Branches or fronds can become dislodged from trees near electrical facilities, blow into the lines and equipment, and cause faults that can potentially initiate an ignition. As discussed in Section 8.2.2.2, SCE prioritizes locations within HFRA based on HFRA tier and density of vegetation surrounding SCE’s facilities.

Please refer to Figure 8-3 in Section 8.2.3.3.1 for the workflow to the remediation process.

Governing standards and electrical corporation standard operating procedures – *Reference to the appropriate code and electrical corporation program/process. If any standard exceeds regulatory requirements, this must include reference to the basis document for the electrical corporation-specific values.*

SCE’s standard operating procedures (SOP) for HTMP are documented in SCE’s Utility Vegetation Management (UVM) Program titled, UVM-04 “Hazard Tree Management Plan.”

Updates to initiative - Changes to the initiative since the last WMP submission and a brief explanation as to why those changes were made. Discuss any planned improvements or updates to the initiative and timeline for implementation

As discussed in Section 8.2.2.1 above, SCE will deploy a new centralized inspection schedule to consolidate the inspection process for Routine Line Clearing, HTMP and Dead and Dying Tree Removal Program. SCE anticipates more efficiency in the deployment of contractor resources to execute work because cross-program scope will generally be identified at the same time in one geographical area under the new consolidated inspection strategy.

SCE has also made changes to the Tree Risk Calculator (TRC) and plans to utilize the new formula for Hazard Tree re-inspections beginning June 2023. A review of the TRC identified opportunity to align rated tree lean severity with direction of lean to better capture risk of vegetation strike to SCE assets. Previously, separation of lean from likelihood of impact could cause a severe lean to elevate the priority of a tree leaning away from SCE assets.

8.2.3.4.2 Dead and Dying Tree Removal Program

Utility Initiative Tracking ID: VM-4

Overview of initiative - Brief description of the initiative including the objective and the risk targeted by the initiative

The Dead & Dying Tree Removal program (formerly called the Drought Relief Initiative or DRI) was established as a result of the epidemic of dead and dying trees brought on by climate change and years of drought. Moreover, Resolution ESRB-4, GO 95 and PRC 4923 require that SCE mitigate the hazards posed by dead trees or those that are identified as significantly compromised.

Dead and dying trees have a higher probability of failing, and if within striking distance of SCE lines and equipment, can cause fault conditions, sparks, and ignition. Under this program, SCE conducts patrols in HFRA to identify and remove dead, dying, or diseased trees affected by drought conditions and/or insect infestation. All trees that are identified within strike distance of SCE overhead facilities that are dead or expected to die within one year are prescribed for removal.

Please refer to Figure 8-3 in Section 8.2.3.3.1 for the workflow to the remediation process.

Governing standards and electrical corporation standard operating procedures – Reference to the appropriate code and electrical corporation program/process. If any standard exceeds regulatory requirements, this must include reference to the basis document for the electrical corporation-specific values.

SCE's Dead and Dying Removal Tree Program is documented in SCE's UVM procedure UVM-18, "Assessment and Removal of Dead and Dying Trees" which meets and/or exceeds the requirements established by GO 95, PRC 4923 and the CPUC Drought Resolution ESRB-4, dated June 12, 2014.

Updates to initiative - Changes to the initiative since the last WMP submission and a brief explanation as to why those changes were made. Discuss any planned improvements or updates to the initiative and timeline for implementation

As discussed in Section 8.2.2.1 above, SCE will deploy a new centralized inspection schedule to consolidate the inspection process for Routine Line Clearing, HTMP and Dead and Dying Tree Removal Program. SCE anticipates more efficiency in the deployment of contractor resources to execute work because cross-program scope will generally be identified at the same time in one geographical area under the new consolidated inspection strategy.

8.2.3.5 Substation Defensible Space

In this subsection, the electrical corporation must provide an overview of its actions taken to reduce ignition probability and wildfire consequence due to contact with substation equipment.

8.2.3.5.1 Substation Inspection and Management

Utility Initiative Tracking ID: 8.2.3.5.1 Substation Inspection and Management

Overview of initiative – Brief description of the initiative including the objective and the risk targeted by the initiative

SCE inspects vegetation around its substations for potential risks from encroachment or blow-in or fall-in hazards and manages vegetation around its substations by performing pruning, removal, and weed abatement. The primary risk to be mitigated is vegetation contact with energized conductors and equipment, as well as preventing fire damage to substations.

Governing standards and electrical corporation standard operating procedures – Reference to the appropriate code and electrical corporation program/process. If any standard exceeds regulatory requirements, this must include reference to the basis document for the electrical corporation-specific values.

The governing standards for substation inspection and management is documented in CPUC GO 174. SCE's SOP for substation inspection and management is documented in SCE's Substation Operations and Maintenance Policy and Procedures (SOM), SCE's Electrical Design Standards Layout 06-90-01.

Updates to initiative - Changes to the initiative since the last WMP submission and a brief explanation as to why those changes were made. Discuss any planned improvements or updates to the initiative and timeline for implementation

There are no changes to this initiative since the last WMP submission.

8.2.3.6 High-Risk Species

In this subsection, the electrical corporation must provide an overview of its actions, such as trimming, removal, and replacement, taken to reduce the ignition probability and wildfire consequence attributable to high-risk species of vegetation.

Utility Initiative Tracking ID: SCE targets high-risk (which SCE refers to as “at-risk”) species through its HTMP (VM-1) initiative and/or Routine Line Clearing (VM-7 and VM-8) activities.

Overview of initiative - *Brief description of the initiative including the objective and the risk targeted by the initiative.*

SCE manages at-risk species and implements clearances to reduce the probability of vegetation contacting electric facilities. Certain tree species, due to their characteristics, have the potential to cause “grow-in”, “blow-in”, or “fall-in” incidents that could lead to an outage or an ignition. Accordingly, SCE takes steps to mitigate the risk of at-risk species coming into contact with energized conductors.

SCE considers other factors, but primarily focuses on tree growth rates, to identify at-risk tree species. SCE has identified tree inventory species within three growth rate categories (fast, medium, slow). In addition, SCE has documented the list of species contained in SCE’s service area that have historically caused problems such as Tree Caused Circuit Interruptions (TCCI). Some of the risk attributes associated with these species include, but are not limited to: being prone to trunk failure, branch failure, limb sway during windy conditions, frond drop, root failure, and tree flammability.

SCE’s tree species inventory list with growth rates and risk characteristics has been integrated into SCE’s probability of ignition (POI) model that informs the TRI. The TRI is used to develop the inspection scope and frequency for HTMP, as discussed further in Section 8.2.2.2 .

SCE’s vegetation crews are knowledgeable about both tree growth rates and tree risk attributes. Line clearing crews are instructed to factor risk attributes into the decision-making process when determining the right tree prescriptions, to ensure compliance clearances are maintained, or when determining if a tree removal is warranted. Additionally, all fast-growing species in grow-in zones are targeted for removal, if possible, when the species has the capacity to encroach into the clearance distance. When practical, SCE removes immature vegetation in the drop-in zone (e.g., overhangs) within HFRA and removes or makes safe palms that have the potential to dislodge fronds.

Due to a palm’s fast growth rate, palms drive a significant amount of off-cycle trims and emergency work required to prevent circuit interruptions and other safety risks. Palms make up approximately 6 percent of SCE’s overall inventory but are responsible for almost 45 percent of TCCIs. Trimming a palm also poses worker safety risks. Approximately 45% of palm inventory requires climbing the tree to trim it. To further mitigate public and worker safety risks associated with trimming palm trees, palms near lines are typically targeted for removal.

In 2021, SCE implemented its palm removal program to help mitigate the risk of vegetation- related ignitions and faults caused by palms. This program deployed resources to seek removal of palms based on specific risk criteria. Depending on their proximity to electrical facilities, these palms may pose significant operational challenges, which include: (1) the palm is a major driver of emergent work and outages (e.g., palm fronds drop onto primary wire); (2) the palm represents a wildfire threat, as dead

palm fronds are highly flammable and are easily blown long distances by winds; and (3) the palm is fast-growing (upwards) and may require multiple trims per year to maintain compliance.

Since 2021, SCE has removed over 20,000 palm trees posing potential blow-in or grow-in hazards, and currently has an inventory of approximately 95,000 palms remaining. SCE will continue applying criteria to determine when a palm should be targeted for removal. SCE will also continue to monitor both removal rates and ignition/fault data to determine if additional efforts are warranted.

Governing standards and electrical corporation standard operating procedures – Reference to the appropriate code and electrical corporation program/process. If any standard exceeds regulatory requirements, this must include reference to the basis document for the electrical corporation-specific values.

SCE's standard operating procedures for at-risk species are documented in SCE's UMV-09, which provides information on at-risk species and subsequent remediation.

Updates to initiative - Changes to the initiative since the last WMP submission and a brief explanation as the why those change were made. Discuss any planned improvements or updates to the initiative and timeline for implementation.

There are no changes to this initiative since the last WMP submission.

8.2.3.7 Fire-Resilient Right-of-Ways

In this subsection, the electrical corporation must provide an overview of its actions taken to promote vegetation communities that are sustainable, fire-resilient, and compatible with the use of the land as an electrical corporation right-of-way. It must also provide an overview of its actions to control vegetation that is incompatible with electrical equipment and with the use of the land as an electrical corporation right-of-way. This may include, but is not limited to, the following activities: the strategic use of herbicides, growth regulators, or other chemical controls; tree-replacement programs; promotion of native shrubs; prescribed fire; or fuel treatment activities not covered by another initiative.

Utility Initiative Tracking ID: 8.2.3.7

Overview of initiative – Brief description of the initiative including the objective and the risk targeted by the initiative.

SCE's Fuel Management Program demonstrates SCE's commitment to wildfire safety through active management of Rights-of-Way (ROW) and reduction of hazardous fuel loading on the landscape that is not captured by routine VM operations. The goal of SCE's Fuel Management Program is to proactively remove vegetation, typically with mechanized equipment, under transmission and distribution conductors, in areas beyond the scope of Routine Line Clearance. An added benefit of this initiative is the creation of wildfire fuel breaks and increased buffer protection for conductor infrastructure.

Additionally, SCE currently manages several pilot programs, that if successful and subject to an assessment of constraints and feasibility, may be incorporated into this initiative in future years. Several of these pilot programs have been implemented in conjunction with environmentally approved Integrated Vegetation Management (IVM) practices. SCE focuses its IVM programs in mountainous

service area due to the high inventory counts, frequency of maintenance, and the potential impact from wildfires and hazardous trees.

SCE's pilot programs related to this initiative include the use of herbicides, hydroseeding, goat grazing, the use of tree growth regulators (TGRs), and the ROW Low Growth program.

- For the herbicide program, SCE is piloting the use of herbicides for pre- and post-emergent applications. The former works well for sites where re-growth of fast and/or invasive woody stem species is undesirable while the latter is useful for combatting invasive species.
- Hydroseeding involves the application of seeds, mulch, water, and additional components and is designed to develop a desired plant community of beneficial, slow-growing vegetation.
- Goat grazing allows SCE to target specific plant species while minimizing ground disturbance and provides a more cost-effective approach to brush mitigation. Also, SCE is looking to partner with the USFS to develop a plan for fuel management by goat grazing across several forests, where steep terrain and limited access make it challenging for traditional tree crews to navigate.
- The TGR pilot is testing the viability of TGR technology in which trees are treated with a growth slowing compound that inhibits cell elongation. The compound is injected into the soil at the base of a tree, and is gradually absorbed by the tree, resulting in slower outward growth rates for several years. Slower growth rates have the potential to extend trim cycles and/or reduce the frequency of visits.
- Finally, the ROW Low Growth program seeks to employ the use of pre-emergent and post-emergent herbicide on certain parcels where feasible to eliminate all vegetation within Transmission ROWs and fee owned parcels. If successful, these treatments would reduce the need for brushing crews to manually clear the vegetation, thereby saving time, cost, and reducing safety risks.

Governing standards and electrical corporation standard operating procedures – Reference to the appropriate code and electrical corporation program/process. If any standard exceeds regulatory requirements, this must include reference to the basis document for the electrical corporation-specific values.

SCE's standard operating procedures for IVM are documented in UVM-05, "Utility Vegetation Management Integrated Vegetation Management Plan (IVMP)" & UVM-08 "Utility Vegetation Management Managing Vegetation Threats."

Updates to initiative - Changes to the initiative since the last WMP submission and a brief explanation as the why those change were made. Discuss any planned improvements or updates to the initiative and timeline for implementation.

In 2023, SCE will continue the development and implementation of IVM practices described above with the goal of evaluating environmentally sound and cost-effective means to promote desirable, stable, low-growing vegetation that is resistant to undesirable tree species. The use of these methods may

provide long-term cost efficiencies and reduce the risk of outages and fires while improving wildlife habitat. SCE intends to consult with agencies before expanding or rolling out the various pilot programs as a broader strategy.

Emergency Response Vegetation Management

In this subsection, the electrical corporation must provide an overview of the following emergency response vegetation management activities:

- *Activities based on weather conditions:*
 - *Planning and execution of vegetation management activities, such as trimming or removal, executed based on and in advance of a Red Flag Warning or other weather condition forecast that indicates an elevated fire threat in terms of ignition probability and wildfire potential.*
- *Post-fire service restoration:*
 - *Vegetation management activities during post-fire service restoration, including, but not limited to, activities or protocols that differentiate post-fire vegetation management from programs described in other WMP initiatives; supporting documentation for the tool and/or standard the electrical corporation uses to assess the risk presented by vegetation after a fire; and how the electrical corporation includes fire-specific damage attributes in its assessment tool/standard. The description of such activities must differentiate between those emergency actions initiated to restore power while active fire suppression is ongoing and actions that occur following active fire suppression during the post-fire suppression repair and rehabilitation phases of fire protection operations.*

8.2.3.8 Emergency Response Vegetation Management

Utility Initiative Tracking ID: 8.2.3.8.1

SCE conducts this activity within its inspection and line clearing programs and therefore, relates to VM-7 and VM-8.

Overview of initiative – *Brief description of the initiative including the objective and the risk targeted by the initiative*

As part of mitigating increased wildfire risk, SCE performs incremental vegetation inspections and remediations in certain locations within its HFRA during the fire season based on weather conditions and other factors. This initiative is distinct from emergent work that may arise leading to P1 and/or P2 work orders, as described in more detail in Section 8.2.6.

For this activity, SCE targets locations that experience increased wildfire risk conditions, such as elevated dry fuel levels, known as Areas of Concern (AOC). These AOCs are identified by a combination of factors

such as age of the fuels, current and forecasted state of fuel moisture, and the area’s subjectivity to fire during periods of high wind, high temperatures and low humidity. The AOCs are prioritized by risk ranking.

Weather conditions such as high wind or extended heat during periods of low fuel moisture have greater potential to generate significant fire events if an ignition occurs. In 2020, SCE’s Fire Science team identified 17 AOCs in its HFRA, which are areas that pose increased fuel-driven and wind-driven fire risk primarily due to elevated dry fuel levels. This threat can be magnified during periods of high wind, high temperatures and low humidity, as forecasts predicted for Fall 2020 in Southern California. The methodology used to identify the AOCs was based on several factors, including fire history, weather conditions, fuel type, exposure to wind, and egress, among others. In 2021, SCE improved its AOC inspections by implementing both a Summer and a Fall AOC program. The Summer AOC effort identified 12 areas where there was risk of a fuel-driven fire, five of which were identified as significant risk and were the focus of additional inspections. The 2021 Fall AOC effort was very similar to the 2020 AOC exercise, and indeed many of the same areas were identified (11 areas). The identified AOCs will continue to be a part of SCE’s wildfire strategy with similar areas consistently targeted for inspection unless a significant event or weather condition adjusts the makeup of the AOCs.

Additionally, SCE modifies its Vegetation Management activities during red flag warning (RFW) periods to help mitigate potential risks. For example, SCE will pause non-emergency work in HFRA (e.g., use of chainsaws) that has the potential to cause sparks, and instead work in non-HFRA areas. For any PSPS events during high fire risk days, Vegetation Management crews are on standby to mitigate any vegetation-related ignition risks identified during PSPS pre- or post-patrols.

Governing standards and electrical corporation standard operating procedures – Reference to the appropriate code and electrical corporation program/process. If any standard exceeds regulatory requirements, this must include reference to the basis document for the electrical corporation-specific values.

SCE’s standard operating procedures related to this initiative are documented in “Vegetation Management Operations Incident Management Team (IMT) Storm Manual.”

Updates to initiative - Changes to the initiative since the last WMP submission and a brief explanation as the why those change were made. Discuss any planned improvements or updates to the initiative and timeline for implementation

Currently, there are no changes to this initiative since the last WMP submission.

8.2.3.8.1 Emergency Response Vegetation Management Post-Fire

Utility Initiative Tracking ID: 8.2.3.8.1.1

SCE performs post-fire Vegetation Management activities as a response to fires that occur unexpectedly and not as a planned fire mitigation initiative with forecasted scope.

Overview of initiative – Brief description of the initiative including the objective and the risk targeted by the initiative

SCE conducts post-fire remediation efforts to remove trees that have become hazards due to fire damage and address resulting debris. Trees can become hazards as a result of recent fire damage and be at risk of falling into SCE facilities and infrastructure.

For example, in response to 2020's Creek Fire events, SCE identified trees that had become hazards and conducted requisite removals. Similarly, in 2021, SCE responded to the French fire, and performed mitigation work to identify hazard trees and remove them.

Governing standards and electrical corporation standard operating procedures – Reference to the appropriate code and electrical corporation program/process. If any standard exceeds regulatory requirements, this must include reference to the basis document for the electrical corporation-specific values.

In 2021, SCE began developing internal standard practices for post-fire remediation work. This involved integrating SCE's Vegetation Management documentation processes with those of SCE's Incident Management Team (IMT) related to restoration work. This allows for an integrated approach to post-fire Vegetation Management work as part of SCE's overall restoration efforts. Because this Vegetation Management work is critical to helping ensure the safety and reliability of the electric system, and the health and safety of our workers and our customers, and because it is often necessary to clear vegetation from roads, ROWs, and properties prior to other restoration work beginning, SCE works expeditiously to remediate identified Vegetation Management issues post-fire. Delaying restoration efforts until routine work is scheduled is not practical and could result in increased risks of tree failure.

SCE relies on the professional judgment of its ISA certified arborist employees and qualified contractor inspectors to determine whether a tree has the potential to live and/or presents a high enough risk to utility infrastructure to warrant trimming or removal. This is especially important in environmentally sensitive areas, such as waterways and areas where protected wildlife live.

Updates to initiative - Changes to the initiative since the last WMP submission and a brief explanation as to why those change were made. Discuss any planned improvements or updates to the initiative and timeline for implementation.

There have been no updates to this initiative since the last WMP filing.

8.2.4 Vegetation Management Enterprise System (Arbora)

In this section, the electrical corporation must provide an overview of inputs to, operation of, and support for a centralized vegetation management enterprise system updated based upon inspection results and management activities such as trimming and removal of vegetation. This overview must include discussion of:

- *The electrical corporation's vegetation inventory and condition database(s).*

Throughout 2023, SCE will transition from legacy work management systems to the Arbora system. Multiple databases will be utilized for work execution during this transition period. As a mitigation effort, SCE plans to leverage a data warehouse to house these databases for consolidated work tracking and reporting. In 2024 and beyond, all VM programs are eventually planned for integration with Arbora.

Transitioning all VM programs to Arbora will help optimize day-to-day operations and improve data accuracy.

The legacy database used for Routine Vegetation Management was based on Esri native/off-the-shelf tools, mostly referred to as Survey123, which is a cloud-based application that houses SCE's tree related inventory and related inspections. These tools were deployed to field users in 2019 to replace the paper-based inspection form previously used to collect tree-related information.

Since 2018, HTMP and the Dead and Dying Tree Program have maintained inspection and mitigation inventory in Fulcrum, another cloud-based application. Field personnel use the Fulcrum application to enter tree risk assessment data captured from ISA Arborists' Level 2 assessments and execute the resulting mitigations. This data includes tree characteristics and location information.

Arbora, a Salesforce-based platform, is being developed to integrate programs from Survey123 and Fulcrum into a single work management system. SCE began integrating HTMP and the Dead and Dying Tree Program inventory data into Arbora in 2022 and will incorporate Routine VM inspection data in 2023. Field personnel will leverage mobile applications for mapping and data collection.

These tools are all adapted to either iOS (Apple-based iPad) or Android (Google-based tablets) platforms for easy field use. SCE provides iPads to inspection personnel as the preferred data collection tool. Use of electronic devices eliminates time-consuming and manual data entry and scanning of the paper-based forms.

- *Describe the electrical corporation's internal documentation of its database(s) - IT*

All current solutions are cloud-based platforms (Esri, Amazon Web Services, Salesforce). SCE maintains an in-house database as the system of record, and system support comprises both in-house and contract services. Our future planned work management system, Arbora, a Salesforce software-as-a-service, includes Salesforce's standards for backup and recovery processes.

The Arbora application solution design, including the data model, data schema, and all other database design aspects, are documented in the Solution Architecture Document for the application.

Functionally, SCE provides user job aids and training materials for users on how to enter data into field forms.

- *Integration with systems in other lines of business.*

The primary systems that Arbora integrates with are SAP and cGIS (consolidated geographic information system). All integrations are documented in the Solution Architecture Document for the Arbora application.

SCE is currently integrating Arbora with other systems, primarily for purposes related to Vegetation Management reporting. SCE is integrating Arbora with Snowflake, which SCE plans to use for operational reporting. Snowflake allows for a greater degree of reporting for Arbora along with legacy data from previous work management systems. Daily database archiving of Arbora data will be stored in Snowflake. With vastly different databases and system architectures, migrating historic data from

system to system is not practical. This streamlined reporting via a single source of data provides an overarching business advantage in reporting current and historic data.

- *Integration with the auditing system(s) (see Section 8.2.5, “Quality Assurance and Quality Control”).*

QA/QC is currently performed within Survey123 and Fulcrum applications and will be performed in Arbora once programs are fully transitioned. SCE will continue to work within these work management systems to perform all necessary QC functions.

Describe internal procedures for updating the enterprise system including database(s) and any planned updates.

SCE is utilizing Salesforce as well as two Salesforce partner products, Youreka (for mobile forms) and Lemur (for mobile maps), as the core technology components of Arbora. The vendors for these products are responsible for updating their respective systems, including internal databases, on a regular basis (typically 3-4 times a year). When these updates are available, SCE loads this new code into the test environment and validate the functionality end-to-end with regression and user acceptance testing to help ensure everything works as expected in the production environment. Any bugs found are communicated back to the vendor to be fixed and retested. Once the testing is completed and passed, SCE migrates the new functionality to the production environment. For any custom developed functionality for the solution, SCE uses an agile development process with a standard monthly release schedule. This process also includes quality assurance testing, regression testing, and user acceptance testing before new functionality is moved into the production environment.

Any changes to the initiative since the last WMP submission and a brief explanation as to why those changes were made. Include any planned improvements or updates to the initiative and the timeline for implementation.

SCE implemented Arbora for HTMP and the Dead and Dying Tree program in June 2022 and for Routine Line Clearing in December 2022. As with other large system implementations, SCE will continue to monitor performance, and as applicable, run legacy systems in parallel. A data cutover comprising remaining open work from legacy systems is expected to occur in 2023. Existing work created in those systems will be “worked down” while Arbora ramps up with new work generation. Emergent line clearing work that is not part of routine maintenance cycles will be enabled by year-end 2023. SCE plans to enable Arbora for additional VM maintenance programs in 2024.

8.2.5 Quality Assurance and Quality Control

In this section, the electrical corporation must provide an outline of its quality assurance and quality control (QA/QC) activities for vegetation management. This overview must include:

- Reference to procedures documenting QA/QC activities.

VM QA/QC activities are addressed in procedure UVM-07, “Post Work Verification and UVM Program Oversight.”²¹³

²¹³ This procedure is included as a supporting document at <https://www.sce.com/safety/wild-fire-mitigation>.

- *How the sample sizes are determined and how the electrical corporation ensures the samples are representative.*

For Distribution line clearing, VM QC sampling is performed on a circuit mile basis. SCE uses a combination of risk-based (through its TRI risk model) and judgmental sampling²¹⁴ for this activity and applies varying Confidence Levels (CL) and Confidence Intervals (CI). First, sampling is performed using SCE’s TRI risk model which identifies four specific risk categories: A, B, C and D, with A being the highest risk tranche. The table below identifies the four risk categories and planned circuit miles to be inspected. 100% of Category A High Fire Risk miles will inspected, when practical, and miles within Category B, C & D will be inspected using a Confidence Level / Confidence Interval of 99/3%.

Table SCE 8-11 – Distribution Circuit Mile Inspections

Distribution HFRA & State Responsibility Area (SRA)				
TRI Category	HFRA & SRA	Total Miles	CL/CI %	Miles Inspected
A	4718	4718	100%	4718
B	2332	5788	99/3	1402
C	1887			
D	1569			
Total	10506		N/A	6120

With these risk-informed sampling volumes established, SCE then performs judgmental sampling to determine which miles to inspect. Judgmental sampling is performed in lieu of random sampling because VM QC is required to verify that work performed by all VM inspection and trimming contractors meets SCE and regulatory compliance requirements. This allows for an appropriate balance of QC inspections across the contractors that perform work.

For Transmission line clearing activities, sampling is performed on a circuit mile basis. Sampling for Transmission miles is performed using judgmental sampling and a CL/CI of 99/5%. Section 4.4 in UVM-07 provides the sampling strategy in more detail.

For VM’s Hazard Tree and Dead and Dying Tree programs, 100% QC is performed to verify the remediation was performed. Additionally, for SCE’s Hazard Tree program, independent QC tree assessments are performed to provide assurance the assessments performed by the Hazard Tree assessments are accurate. QC typically samples assessments that had a risk score of between 35 to 49 (the typical threshold where mitigation was not required) providing added assurance the trees requiring mitigation were not missed. QC sampling for the independent risk assessments is performed using a CL/CI of 99/2%.

Additionally, for Structure Brushing, in 2023 QC inspectors will focus structure brushing QC on Distribution structures subject to Public Resource Code 4292. The intent of the QC will be to confirm: (1)

²¹⁴ Judgmental sampling is a type of non-random sample that is selected based on the opinion of an expert. Results obtained from a judgment sample are subject to some degree of bias, due to the frame and population not being identical.

Structures brushed have met the requirements of PRC 4292, and: (2) reasonable assurance that structures are maintaining clearance requirements during the declared fire season. QC will target to inspect PRC 4292 Distribution Structures using a CL/CI of 99/2%, approximately 330 structures monthly.

- *Who performs QA/QC (internal or external, is there a dedicated team, etc.).*

QC is performed by a dedicated external contractor for all of SCE's VM programs, including Routine Line Clearing, Hazard Tree, Dead and Dying Trees, and Structure Brushing. However, selection and assignment of the QC work is performed by SCE internal compliance personnel. QC work is typically assigned 60 days after work completion.

- *Qualifications of the auditors.*

SCE interprets "auditors" to be the resources that perform QC, the function described in this section. QC personnel for HTMP, Dead and Dying Tree Removal, Routine Line Clearing for both Transmission and Distribution, and Structure Brushing are ISA Certified Arborists with utility vegetation management experience. QC inspectors that are not ISA certified but have utility vegetation experience may also be used but are required to obtain ISA certification within twelve-months of being hired.

- *Documentation of findings and how the lessons learned from those findings are incorporated into trainings and/or procedures.*

QC findings are tabulated using a dashboard system that identifies conformance rate and specific locations where work is performed and by the specific contractor. Monthly reports are generated documenting the results of the QC inspections in addition to monthly performance review meetings where performance in general is discussed. Contractors not meeting internal quality requirements (Acceptable Quality Level) may be placed on a corrective action plan if repeat performance issues are identified. The QC inspection, review and reporting process provides a continuous learning environment.

- *Any changes to the procedures since the last WMP submission and a brief explanation as to why those changes were made. Include any planned improvements or updates to the initiative and the timeline for implementation.*

SCE is reviewing the current oversight strategy for post-work verification performed by SCE senior specialists and will be increasing the volume and type of inspections performed for Routine Line Clearing. The changes will include additional oversight of Pre-inspection and Trimming activities and will be implemented in Q2 2023.

- *Tabular information:*
 - *Sample sizes*
 - *Type of QA/QC performed (e.g., desktop or field)*
 - *Resulting pass rates, starting in 2022*
 - *Yearly target pass rate for the 2023-2025 Base WMP cycle Table 8-18 provides an example of the appropriate level of detail.*

Table 8-18 - Vegetation Management QA/QC Program

Activity Being Audited	Sample Size	Type of Audit	Audit Results 2022	Yearly Target Pass Rate for 2023-2025
Distribution Vegetation Management Plan	SCE’s Tree Risk Index (TRI) risk model is applied to sampling for Distribution circuits and was developed using outputs from SCE’s Wildfire Risk Reduction Model (WRRM), historic Tree Caused Circuit Interruption (TCCI) data and other VM inventory data. The TRI risk model identifies four risk categories A, B, C & D, with category A being the highest risk. Sampling is performed using the following Confidence Level (CL)/Confidence Interval (CI) levels. UVM-07, Section 4.4 provides the sampling strategy in more detail.	Field	RCD: ²¹⁰ 99.56% CCD: ²¹⁰ 97.80%	RCD Target Pass Rate is 100% CCD Target Pass Rate is 95%
Transmission Vegetation Management Plan	Sampling for Transmission miles is performed using a CL/CI of 99/5%. UVM-07, Section 4.4 provides the sampling strategy in more detail.	Field	RCD: 99.74% CCD: 99.28%	RCD Target Pass Rate is 100% CCD Target Pass Rate is 95%

Activity Being Audited	Sample Size	Type of Audit	Audit Results 2022	Yearly Target Pass Rate for 2023-2025
Dead & Dying Tree Removal	100% verification of remediation	Field	>99.5%	100% remediation
HTMP	100% verification of remediation	Field	>99.5%	100% remediation

8.2.6 Open Work Orders

In this section, the electrical corporation must provide an overview of the procedures it uses to manage its open work orders resulting from vegetation management inspections that prescribe vegetation management activities. This overview must include a brief narrative that provides:

- *Reference to procedures documenting the work order process.*

Work order-related procedures are included in the standard operating procedures for each program and the overall vegetation management program.

- UVM Program Governance, reflected in UVM-01, “Utility Vegetation Management Program Manual.”
- Transmission Vegetation Management Plan (TVMP), reflected in UVM-02, “Utility Vegetation Management Transmission Vegetation Management Plan (TVMP)” and UVM-08 “Utility Vegetation Management Managing Vegetation Threats”.
- Distribution Vegetation Management Plan (DVMP), reflected in UVM-03, “Utility Vegetation Management Distribution Vegetation Management Plan (DVMP)” and UVM-08 “Utility Vegetation Management Managing Vegetation Threats”.
- Integrated Vegetation Management Plan (IVMP), reflected in UVM-05, “Utility Vegetation Management Integrated Vegetation Management Plan (IVMP)” & UVM-08 “Utility Vegetation Management Managing Vegetation Threats”.
- Hazard Tree Management Plan (HTMP), reflected in UVM-04, “Utility Vegetation Management Hazard Tree Management Plan (HTMP)”. & UVM-08 “Utility Vegetation Management Managing Vegetation Threats”.
- *A description of how work orders are prioritized based on risk.*

SCE prioritizes and endeavors to complete work orders within certain time frames based on the risk

posed by observed conditions. First, SCE categorizes vegetation work orders between Priority 1 (P1) and Priority 2 (P2).

The conditions below are situations that most likely would trigger a P1 work order:

- Any observed tree, or parts thereof, that is expected to imminently fail and contact electric facilities
- Any observed vegetation condition where it appears that contact has occurred with primary electric facilities
- Any observed vegetation condition where it appears that strain or abrasion has occurred with secondary bare open wire
- Specific to HTMP and Dead and Dying Tree Removal, any observed tree, where failure of the tree and contact with the conductors is highly probable to occur in a high-wind events
- Any observed tree, or parts thereof, where vegetation contact or arcing with bare-wire conductors is highly probable to occur in a high-wind or modeled maximum load event due to vegetation proximity to power lines

The conditions below are situations that most likely would trigger a P2 work order:

- Any observed tree, or parts thereof, that is not a P1 condition and is currently stable but the likelihood of failure and/or contact with primary electric facilities is plausible but not imminent
- Any observed vegetation condition, that is not a P1 condition and is currently stable but where it appears that vegetation may cause a failure of electric facilities (i.e., a condition that changes pole loading conditions such as excessive strain on a down guy or communication wires)
- Any observed tree, or parts thereof, that is not a P1 condition but is within the Trigger Clearance Distance (TCD), Compliance Clearance Distance (CCD), or Regulatory Clearance Distance (RCD)²¹⁵ (including strain or abrasion at the secondary level that is not a P1 condition)
- Any Vegetation with an HTMP Risk score resulting in a P2 mitigation (typically a risk score 50–100 using the Tree Risk Calculator)

SCE then endeavors to remediate according to the following time frames:

For P1 Work Orders

- SCE endeavors to remediate P1s where there is vegetation contact or evidence of contact (e.g., scarring or burn marks) within 24 hours.
- SCE endeavors to remediate P1s in HFRA only, where vegetation is within approximately 18

²¹⁵ See UVM-03 Distribution Vegetation Management Plan (DVMP) in Supporting Docs. RCD means Regulatory Clearance Distance, and is the minimum clearance required by regulation. CCD means Compliance Clearance Distance and is SCE's minimum clearance standard which is 1.5 times the RCD. TCD means Trigger Clearance Distance. TCD is derived from CCD plus 3 feet and is the distance that triggers the maintenance activity. GRCD is the Grid Resiliency Clearance Distance, which aligns with the GO95 Rule 35, Appendix E recommended clearance.

inches of energized equipment and thus an imminent threat, but there is no evidence of actual contact (e.g., scarring or scorch marks) within 72 hours.

For P2 Work Orders

- SCE endeavors to remediate P2s when vegetation is closer than the regulatory required distance (e.g., four feet) but beyond 18 inches within 30 days.
- For all other P2s related to Routine Line Clearing, SCE endeavors to remediate them within 90 days, unless there is a limited timeframe triggered by permitting requirements or customer requests. Currently SCE addresses these based on a first-in/first-out methodology, but starting in 2023 SCE anticipates utilizing a new risk calculation accounting for factors such as species growth rate, days elapsed since identification of work, TRI identification, and the clearance distance at time of inspection. These combined factors will provide a better depiction of overdue work risk based on the data collected in the field.
- For P2s related to HTMP and the Dead and Dying Tree Removal Program, SCE endeavors to address them within 180 days. Currently SCE addresses these based on a first-in/first-out methodology, but starting in 2023 SCE anticipates utilizing Tree Risk Calculator scores to help prioritize P2 work orders based on the various conditions that the score incorporates, such as root defects, cracks, rot, pest infestations, lean, height, and fire impact.
- A description of the plan for eliminating work order backlogs (i.e., open work orders that have passed remediation deadlines), if applicable.

SCE is working diligently to address work order backlogs. These backlogs can form for several reasons, including environmental regulatory requirements and permitting, contractor performance, and other factors. In Section 5.4.5, SCE outlines the steps it is taking to address environmental related backlogs. Further, SCE has implemented process improvements for monitoring contractor progress against plan, and grouping and prioritizing work. Additionally, SCE's continued progress on developing a single work order system will improve efficiency for contractor assignment and data input. Finally, SCE has implemented more robust reporting to improve the monitoring of work order completion progress.

To mitigate the risk of an overdue vegetation work order becoming a fire risk, SCE monitors overdue work orders related to Routine Line Clearing that involve vegetation breaching the required compliance distance from SCE's lines by revisiting them every 30 days to help ensure they do not become imminent threats.

- *A discussion of trends with respect to open work orders.*

SCE's open work order history shows a reduction of 22% when comparing the average of total open work orders at year-end for 2019 through 2021 to the year-end count of open work orders in 2022. Additionally, in the last four years, SCE has maintained a 55-day average turnaround time for all

generated work not impacted by environmental constraints. For environmentally constrained work, SCE’s work orders have been completed in an average turnaround time of 110 days. The longer duration is generally a result of the high level of coordination required with various entities and stakeholders. Additionally, it should be noted that the environmentally impacted tree inventory has increased from 13% in 2019 to 36% in 2022, a significant factor underlying SCE’s open work order counts.

In addition, each electrical corporation must:

- *Graph open work orders over time as reported in the QDRs (Table 2, metrics 7.a and 7.b).*

The figure below shows the count of open work orders for Vegetation Management for 2020 through 2022, as of each quarter-end, and as reflected in SCE’s QDR Table 2 for metric 6a.

Figure SCE 8-44 - Volume of Open Work Orders

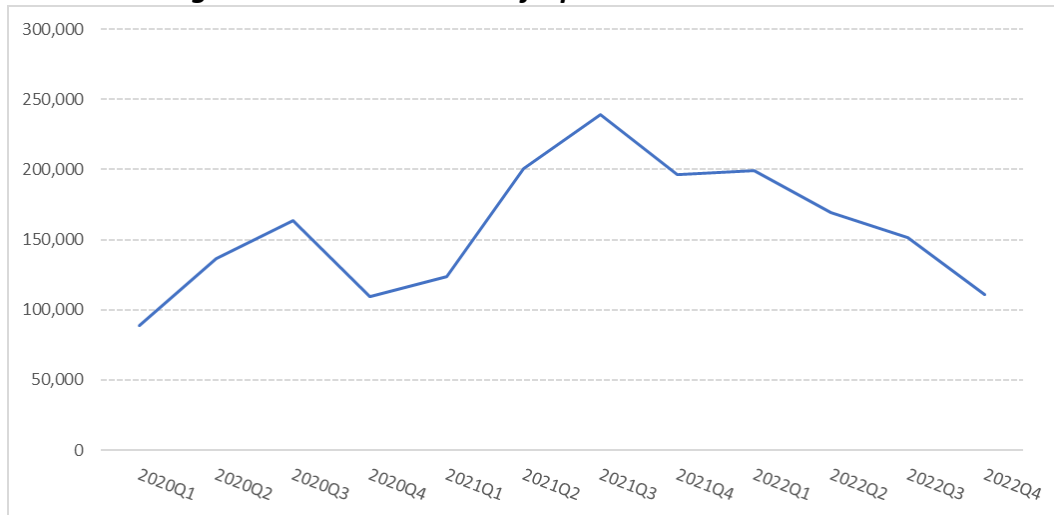

The figure below shows the count of past due work orders for Vegetation Management for 2020 through 2022, as of each quarter-end, and as reflected in SCE’s QDR Table 2 for metric 6b. SCE defines “past due work orders” as those work orders that have exceeded internal targets of 30 days for work where the existing clearance is less than the Regulatory Clearance Distance (RCD) and for 90 days where the existing clearance is between the RCD and the Trigger Clearance Distance (TCD).

Figure SCE 8-45 - Volume of Past Due Work Orders

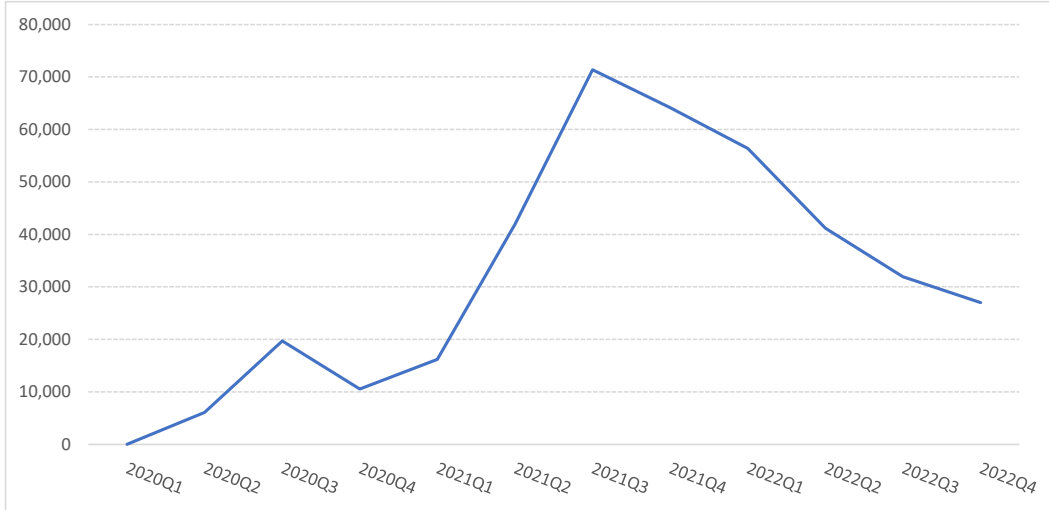

Note: In 2019, SCE began building its capabilities to capture data related to past due work orders. Due to the time lag required to render a work order “past due,” first quarter of 2020 shows a low volume, with a steady increase throughout the year.

In 2021, SCE experienced a higher level of both open and past due work orders as a result of an increase in mitigation work requiring environmental review and the shifting of work resulting from safety stand-downs for two contractors.

- Provide an aging report for work orders past due (Table 8-19 provides an example).

Table 8-19: Number of Past Due Vegetation Management Work Orders Categorized by Age

Table 8-19 - Routine Line Clearing as of 12/31/2022 (1)

HFTD Area	0-30 Days	31-90 Days	91-180 Days	181+ Days	Total
Non-HFTD	4,592	2,582	1,962	2,113	11,249
HFTD Tier 2	2,049	1,512	1,661	6,522	11,744
HFTD Tier 3	2,107	7,545	1,988	6,284	17,924

Note: The majority of the past due open work orders comprise P2 work orders.

Hazard Tree (HTMP/DRI) as of 12/31/2022

HFTD Area	0-30 Days	31-90 Days	91-180 Days	181+ Days	Total
Non-HFTD	7	30	18	192	247
HFTD Tier 2	57	423	291	2,328	3,099
HFTD Tier 3	0	14	5	82	101

Note: The majority of the past due open work orders comprise P2 work orders.

8.2.7 Workforce Planning

In this section, the electrical corporation must provide a brief overview of its recruiting practices for vegetation management personnel. It must also provide its worker qualifications and training practices for workers in the following target roles:

- *Vegetation inspections*
- *Vegetation management projects*

For each of the target roles listed above, the electrical corporation must:

- *List all worker titles relevant to the target role.*
- *List and explain minimum qualifications for each worker title with an emphasis on qualifications relevant to vegetation management. Note if the job requirements include the following:*
 - *Special certification requirements, such as being an International Society of Arboriculture Certified Arborist with specialty certification as a Utility Specialist or a California-licensed Registered Professional Forester*
 - *Additional training on biological resources identification and protection (e.g., plant and animal species and habitats); and cultural prehistoric and historic resources identification and protection*
- *Report the percentage of electrical corporation and contractor full-time equivalents (FTEs) in target roles with specific job titles*
- *Report plans to improve qualifications of workers relevant to vegetation management. The electrical corporation must explain how it is developing more robust outreach and onboarding training programs for new electric workers to identify hazards that could ignite wildfires*

Table 8-20 provides an example of the required information.

SCE's vegetation management personnel are integral to the success of its operations. To that end, in addition to a pay structure emphasizing work experience and education, SCE utilizes employment-focused social media platforms and community outreach programs to recruit resources. See Section 8.2.2.1 Routine Line Clearing under "Accomplishments" in sub-section "Workforce Retention and Upskilling" for more details on SCE's alignment between compensation and qualifications.

In the table below, SCE summarizes the applicable information for each of the target roles identified. Full time employee (FTE) figures represent counts and percentages as of month-end November 2022 and include SCE and contractor field workers relevant to each target role. It is important to note that worker counts can fluctuate throughout the year depending on work required, resource availability, and other factors, particularly for contract workers. Below each table, SCE provides a more detailed description of the qualifications for each role, as well as discussion on training and plans to improve worker qualifications.

8.2.7.1 Target Role: Vegetation Inspections

SCE's Vegetation Management program performs several types of inspections to identify the risk of vegetation contact with energized conductors and electrical assets. Recruiting and training vegetation personnel is an ongoing activity. Staffing levels are continuously evaluated and adjusted based on identified needs and implementation of future programs. See Section 8.2.2 for detailed information on vegetation management inspections.

Vegetation Management Inspections include the following target role positions:

- Specialist
- Senior Specialist
- Inspector
- Lead Inspector
- Customer Coordinator
- General Foreman
- Quality Control Inspector

Table 8-20 details the worker titles and associated qualifications pertaining to Vegetation Inspections. For purposes of this table and target role, "Special Certification Requirements" includes International Society of Arboriculture (ISA) Arborist.²¹⁶

²¹⁶ To earn a credential as an ISA Certified Arborist, an individual must be trained and knowledgeable in all aspects of arboriculture and adhere to the ISA's Code of Ethics. To be eligible, individuals must have one or both of the following: three or more years of full time, eligible, practical work experience in arboriculture; a degree in the field of arboriculture, horticulture, landscape architecture, or forestry from a regionally accredited educational institute

Table 8-20 - Vegetation Inspections Qualifications and Training

Worker Title	Minimum Qualifications for Target Role	Special Certification Requirements	Electrical Corporation % FTE Min Qualls²¹⁷	Electrical Corporation % Special Certifications²¹⁸	Contractor % FTE Min Qualls	Contractor % Special Certifications	Reference to Electrical Corporation Training/Qualification Programs
SPECIALIST	See below	N/A	26.3%	N/A	0.0%	N/A	See below
SENIOR SPECIALIST	See below	ISA Arborist ²¹⁹	73.7%	100%	4.0%	47%	See below
LEAD INSPECTOR	See below	ISA Arborist	0.0%	N/A	13.4%	62%	See below
PRE-INSPECTOR ²²⁰	See below	N/A	0.0%	N/A	39.7%	20%	See below
CUSTOMER COORDINATOR ²²⁰	See below	N/A	0.0%	N/A	20.4%	9%	See below
GENERAL FOREMAN	See below	ISA Arborist	0.0%	N/A	13.7%	12%	See below
QUALITY CONTROL INSPECTOR	See below	ISA Arborist	0.0%	N/A	8.8%	67%	See below
TOTAL			100.0%	N/A	100.0%	N/A	N/A

²¹⁷ “% of FTE Min Qualls” column = # of SCE Workers in each Worker Title / Total # of SCE Workers in the Table. The same logic applies for Contractor.

²¹⁸ “% Special Certification” column = # of SCE workers in that Worker Title that have the special certification / total number of SCE workers in that Worker Title. The same logic applies for Contractor.

²¹⁹ ISA Certified Arborist is required for SCE-employed Senior Specialists. For contractor Senior Specialists who may perform some work duties on a temporary basis, ISA certification is encouraged, but not required.

²²⁰ ISA Certified Arborist is not a requirement for Inspectors and Customer Coordinators, but they are encouraged to obtain certification when eligible.

All Vegetation Management field workers must meet certain minimum qualifications. In some cases, certain worker types are required to be ISA-certified. Specific qualifications for each position are detailed below.

Additional Minimum Qualifications:

SPECIALIST: Provides oversight and guidance to field contractors performing vegetation work. All of SCE's Specialists must have three or more years' experience in Utility Vegetation Management.

SENIOR SPECIALIST: Provides oversight and guidance to field contractors performing vegetation work. Senior Specialists have additional responsibilities such as being able to perform post-work verification (to help ensure that work is done to regulatory requirements and program standards), responding to trouble orders, and performing review of work performed on SCE's Bulk Transmission System. SCE employed Senior Specialists must be ISA Certified Arborists.²²¹

PRE-INSPECTOR: Personnel performing pre-inspections without supervision responsibilities. Pre-Inspectors are qualified if they meet one of the following conditions at date of hire: Possess a 4-year degree in related field with ability to obtain ISA certification in 12 months; possess a 2-year degree in related field with one year experience and ability to obtain certification in 12 months; possess two years of industry experience with the ability to obtain ISA certification in 12 months.

LEAD PRE-INSPECTOR: Personnel responsible for supervising pre-inspections. Lead pre-Inspectors are qualified if they meet of the following conditions at date of hire: classified as a level 3 or higher on the T&E Labor Classifications described in the Pricing Workbook²²² and be an International Society of Arboriculture (ISA) Certified Arborist,²²³ it is recommended that they also obtain the Tree Risk Assessment Qualification (TRAQ).

CUSTOMER COORDINATOR: Issues notifications regarding upcoming vegetation management work, fields customer constraints (e.g., refusals, issues with site access, etc.) related to vegetation management work, and works to obtain customer permissions, e.g., for recommended expanded clearances. To qualify, the individual must possess a minimum of two years of related utility vegetation management pruning, inspection, or planning experience.

GENERAL FOREMAN: Oversees crew operations by helping to ensure crew safety, scheduling work based on crew qualifications, resolving escalated customer constraints, and coordinating with the Senior Specialists in their district. At a minimum, SCE's contracts require one designated General Foreman per every eight crews. The General Foremen must be ISA Certified Arborists and/or must possess a minimum of three years of related utility vegetation management pruning, inspection, or planning experience.

QUALITY CONTROL (QC) INSPECTOR: QC Inspectors are independent of vegetation management

²²¹ To earn a credential as an ISA Certified Arborist, an individual must be trained and knowledgeable in all aspects of arboriculture and adhere to the ISA's Code of Ethics. To be eligible, individuals must have one or both of the following: Three or more years of full time, eligible, practical work experience in arboriculture; a degree in the field of arboriculture, horticulture, landscape architecture, or forestry from a regionally accredited educational institute

²²² For more information, please see Pricing Workbook in Supplemental Materials.

²²³ In certain situations, pending Edison Representative approval, a contractor may recommend a non-ISA certified arborist to perform pre-inspection supervisory functions.

operations and perform inspections to verify that regulatory and program standards have been achieved. They must have either an ISA Arborist Certification or have a minimum of two years of experience performing utility vegetation inspections and have experience measuring vegetation to conductor clearance using precision measuring tools. Once the inspector is eligible for ISA certification, it is expected that the inspector will become certified within six months of eligibility.

Training and plans to improve worker qualifications:

SCE provides onboard and annual training— Utility Vegetation Management Core Plans Training – to all vegetation management employees and vegetation contractor lead personnel. This training provides detailed reviews of program requirements, practices, and procedures, and any updates or enhancements pertaining to SCE’s vegetation management program. Typical training included in Core Plans Training reviews the following vegetation management process documents that guide work in this space: Transmission Vegetation Management Plan (TVMP); Distribution Vegetation Management Plan (DVMP); Hazard Tree Management Plan; Vegetation Threat Management; Customer Refusals; and QC and SCE’s Oversight Strategy. As it pertains to wildfire mitigation practices, this training identifies and conveys differences in inspecting, and pruning practices (e.g., clearance distances) within SCE’s HFRA vs. non-HFRA and identifies vegetation that pose a risk and/or hazard to electrical facilities.

Additionally, SCE provides Environmental Awareness Orientation annually or at time of personnel onboarding to all vegetation management employees and vegetation contractor personnel listed in Table 8-20 and Table 8-21. This Orientation includes review of biological, wetlands/waters, and cultural/historical resources avoidance and protection; environmental compliance and requirements; and environmentally sensitive areas.

In addition to Core Plans Training, all vegetation management personnel receive training to identify and understand the actions required when work is being performed in environmentally sensitive locations. For SCE’s Bulk Transmission vegetation management inspections, SCE also provides technical training on how to use LiDAR-acquired data to determine vegetation encroachments into the minimum vegetation clearance distance.

To grow the pool of ISA-certified arborists, SCE plans to continue to hire Specialists who do not yet have an ISA-certification but who will, under the guidance of Senior Specialists, acquire the vegetation management-related experience necessary to meet the experience requirement for an ISA-certification.

8.2.7.2 Target Role: Vegetation Management Projects

SCE’s vegetation management projects are programs focused on removing hazards, such as dead and dying trees and those that are in proximity and may pose a risk to electric facilities.

Recruiting and training vegetation personnel is an ongoing activity. Staffing levels are continuously evaluated and adjusted based on identified needs and implementation of future programs. Please see Sections 8.2.3.1.1 and 8.2.3.4 for detailed information on vegetation management projects.

The three vegetation management projects are: (1) Structure Brushing; (2) HTMP; (3) Dead and Dying Tree Removal Program, as described in Sections 8.2.3.1.1, 8.2.3.4.1 and 8.2.3.4.2, respectively.

Table SCE 8-12 below detail the worker titles and associated qualifications pertaining to Vegetation Projects.

Table SCE 8-12 - Vegetation Management Qualifications and Training

Worker Title	Minimum Qualifications for Target Role	Special Certification Requirements	Electrical Corporation % FTE Min Quals ³⁵	Electrical Corporation % Special Certifications ³⁶	Contractor % FTE Min Quals	Contractor % Special Certifications	Reference to Electrical Corporation Training/Qualification Programs
SPECIALIST	See below	N/A	26.3%	N/A	0.0%	N/A	See below
SENIOR SPECIALIST	See below	ISA Arborist ²²⁴	73.7%	100%	8.6%	47%	See below
HTMP ASSESSOR	See below	ISA Arborist	0.0%	N/A	17.1%	100%	See below
DEAD AND DYING TREE ASSESSOR ²²⁵	See below	N/A	0.0%	N/A	20.0%	9%	See below
QUALITY CONTROL HTMP ASSESSOR	See below	ISA Arborist	0.0%	N/A	4.0%	100%	See below
FOREMAN	See below	N/A	0.0%	N/A	5.7%	N/A	See below
HAZARDOUS TREE SPECIALIST	See below	N/A	0.0%	N/A	2.9%	N/A	See below
STRUCTURE BRUSHER	See below	N/A	0.0%	N/A	41.7%	N/A	See below
TOTAL			100.0%	N/A	100.0%	N/A	N/A

²²⁴ ISA Certified Arborist is required for SCE-employed Senior Specialists. For contractor Senior Specialists who may perform some work duties on a temporary basis, ISA certification is encouraged, but not required.

²²⁵ ISA Certified Arborist is not a requirement for Dead and Dying Tree Assessor, but they are encouraged to obtain certification when eligible.

Additional Minimum Qualifications:

SPECIALIST: Support Senior Specialists in their Routine Line Clearing, HTMP and Dead and Dying Tree Program work. Specialists are also not assigned to specific geographic Districts and are available to support where needed. See qualifications of Specialist in Section 8.2.8.1.

SENIOR SPECIALIST: Resolve customer constraints and help ensure that the Routine Line Clearing, HTMP and Dead and Dying Tree Program work is done. See qualifications of Senior Specialist in Section 8.2.8.1

HTMP ASSESSOR: Responsible for conducting risk assessments on trees located in the Utility Strike Zone (USZ). Assessors are qualified if, at date of hire, they possess an ISA Arborist Certification and a minimum of three years of related utility vegetation management inspection/planning experience.

DEAD AND DYING TREE ASSESSOR: Responsible for performing visual inspections to detect dead, dying and diseased trees in the field. Assessors are qualified if, at date of hire, they have the requisite experience as a vegetation management professional and have two years of previous utility vegetation management experience.

QUALITY CONTROL HTMP ASSESSOR: Independent of HTMP operations and perform two specific roles related to QC of HTMP: Perform an independent risk assessment to verify the accuracy of the risk assessment score achieved by the HTMP assessors; and verify all HTMP remediations have been performed. ISA Certification is only required for HTMP QC personnel who perform risk assessment using the TRC. All other QC work requires a minimum of two years of experience performing utility vegetation inspections.

FOREMAN: Oversees work performed by crews to help ensure proper tools and equipment are available and the work is performed safely; help ensures process adherence and conducts QC reviews. Must have knowledge of: Brush clearance requirements; herbicide restrictions; and environmental requirements. Skills and abilities required for this job are of a level comparable with those normally acquired through a high school education and extensive training and experience as a Structure Brusher.

HAZARDOUS TREE SPECIALIST: Conducts the felling of trees and identifies the hazards and obstacles before and after felling each tree. Provides direction to crews and helps allocate resources and equipment such that work is performed safely and efficiently, and without compromising surrounding trees and environment. The knowledge, skills, and abilities required for this job are of a level comparable with those normally acquired through a high school education, Supplemental by one year of experience as a timber faller with thorough knowledge of tree soundness and cutting techniques to directionally fall trees.

STRUCTURE BRUSHER: Responsible for conducting pole and sub-transmission tower brushing by eliminating weeds, grass, and other flammable materials to bare soil by mechanical methods from 10-foot radius at ground level to a height of 8 feet. Skills and abilities required for this job are of a level comparable with those normally acquired through a high school education and annual environmental training.

Training summary and plans to improve worker qualifications:

Training for HTMP, the Dead and Dying Tree Removal Program, and Structure Brushing includes: Training of specific work processes; refusal management; vegetation threat management; QC requirements; Tree Risk Calculator training for those involved in HTMP; and environmental-specific training.

Through the substantive minimum qualifications established for the various roles within Vegetation Projects, SCE has established the foundation of a strong skilled workforce. SCE will continue requiring the qualifications discussed above and encourage continued advancement of SCE and Contract workers. For example, once an assessor is eligible for ISA certification, it is expected that he or she will become certified within twelve months of eligibility.

As part of continuing education and improvement of the vegetation management program, SCE updates its training programs based on lessons learned. SCE also provides refresher training and relevant communications to workers on updated guidelines, as there are typically changes in protocols that occur each year.

8.2.8 Maturity Advancement

SCE continually seeks alignment with government and industry organizations and continues to look for opportunities to improve vegetation management maturity over time.

The activities discussed in this section could lead to Vegetation Management and Inspections maturity advancements. Below is a summary of broader anticipated maturity improvements over the WMP period that supplement the objectives outlined at the beginning of the Section.

Table SCE 8-13 – Vegetation Management Maturity Improvements

Capability Name	Projected Maturity Improvements
Vegetation Inventory and Condition Database	Improvements include utilization of remote sensing information that will help validate database information.
Vegetation Inspections	Improvements include new considerations taken for inspection frequency (i.e., tree health) and using remote sensing information to support increased inspection frequency and QA/QC assessment of inspection program conducted on a quarterly basis.

8.3 Situational Awareness and Forecasting

8.3.1 Overview

In this section, the electrical corporation must identify objectives for the next 3- and 10-year periods, targets, and performance metrics related to the following situational awareness and forecasting programmatic areas:

- *Environmental monitoring systems*
- *Grid monitoring systems*
- *Ignition detection systems*
- *Weather forecasting*
- *Ignition likelihood calculation*
- *Ignition consequence calculation²²⁶*

8.3.1.1 Objectives

Each electrical corporation must summarize the objectives for its 3-year and 10-year plans for implementing and improving its situational awareness and forecasting.²²⁷ These summaries must include the following:

- *Identification of which initiative(s) in the WMP the electrical corporation is implementing to achieve the stated objective, including Utility Initiative Tracking IDs*
- *Reference(s) to applicable codes, standards, and best practices/guidelines and an indication of whether the electrical corporation exceeds an applicable code, standard, or regulation*
- *Method of verifying achievement of each objective*
- *A completion date for when the electrical corporation will achieve the objective*
- *Reference(s) to the WMP section(s) or appendix, including page numbers, where the details of the objective(s) are documented and substantiated*

This information must be provided in Table 8-21 for the 3-year plan and Table 8-22 for the 10- year plan. Examples of the minimum acceptable level of information are provided in Tables below.

²²⁶ The final 2023-2025 Wildfire Mitigation Plan Technical Guidelines, issued on December 6, 2022, removes Ignition likelihood calculation and Ignition consequence calculation and replaced it with Fire Potential Index.

²²⁷ Annual information included in this section must align with the QDR data.

Table 8-21 - Situational Awareness Initiative Objectives (3-year plan)

Objectives for Three Years (2023–2025)	Applicable Initiative(s), Tracking ID(s)	Applicable Regulations, Codes, Standards, and Best Practices (See Note)	Method of Verification (i.e., program)	Completion Date	Reference (section & page #)
Increased data collection (through additional weather station deployment, explore increased collection intervals, and additional SCE HD camera deployment) to expand situational awareness of real-time conditions and refine weather models	Weather Stations, SA-1, HD Cameras, SA-10 Satellite & Other Imaging Technology, SA-10	SA-1 Requested by OEIS to increase weather station data collection periods (more than 6 reads per hour) ²²⁸ SA-10: N/A	SA-1: GIS data, increase frequency of reads SA-10: Additional GIS data, data camera feed on vendor network.	SA-1: End of 2025 SA-10: End of 2024	Section 8.3.2.1.1 Weather Stations (SA-1), pp. 454-459 Section 8.3.4.1.1 (HD Cameras SA-10), pp. 492-497 Section 8.3.4.1.2 (Satellite & Other Imaging Technology SA-10), pp. 494-498
Expand data analysis supporting wildfire mitigation efforts, advance fire potential forecasting further, and improve modeling efforts as it relates to fire science	Fire Science, SA-8	N/A	Additional data sets, analysis results, operational products	Ongoing	Section 8.3.2.1 Existing Systems, Technologies and Procedures pp. 453-464; Section 8.3.4 Ignition Det. Sys. pp. 490-501
Increase ability to detect issues (e.g., damage and degradation) on the electric grid prior to risk events occurring	Early Fault Detection (D&T), SA-11	<ul style="list-style-type: none"> • GO 95 • GO 165 	Number of EFD devices deployed	Ongoing	Section 8.3.3.1.1, Radio Frequency Monitors: Early Fault Detection (EFD) (SA-11), p. 469
Review emerging technologies to improve weather situational awareness and forecasting capabilities for potential evaluation or adoption	Weather & Fuels Modeling, SA-3	N/A	Technical report from academic or vendor work, and/or new product outputs.	Ongoing	Section 8.3.5, Weather Forecasting, pp. 499-515
Continue to increase situational awareness and improve the accuracy of weather forecasting to help optimize the scope of PSPS events	Weather Stations, SA-1, Weather & Fuels Modeling, SA-3, Fire Science, SA-8, HD Cameras, SA-10	Best practices	<p>SA-1: Continue installing new weather stations, commitment of 85. Upgrade more stations for dual comms for real-time reads capabilities.</p> <p>SA-3 and SA-8: Weather and fuel forecast output from operational systems and associated verification and/or technical reports.</p> <p>SA-10: Continued installs of HD Cameras, goal of 10, max of 20.</p>	Ongoing; annual scope	<p>Section 8.3.2.1.1 Weather Stations (SA-1), pp. 454-458</p> <p>Section 8.3.5, Weather Forecasting, pp. 499-514</p> <p>Section 8.3.2.1 Existing Systems, Technologies and Procedures pp. 453-462; Section 8.3.4 Ignition Det. Sys. pp. 490-497</p> <p>Section 8.3.4.1.1 (HD Cameras SA-10), p. 492-497</p>

²²⁸ Decision on SCE's 2022 Wildfire Mitigation Plan Update, p. 45.

Note: An asterisk indicates that the electrical corporation exceeds a particular code, regulation, standard, or best practice. The electrical corporation must provide a reference to the appendix section and page providing further documentation, justification, and substantiation.

Table 8-22 - Situational Awareness Initiative Objectives (10-year plan)

Objectives for Ten Years (2026–2032)	Applicable Initiative(s), Tracking ID(s)	Applicable Regulations, Codes, Standards, and Best Practices (See Note)	Method of Verification (i.e., program)	Completion Date	Reference (section & page #)
Incorporate climate modeling (e.g., impacts of climate change) into medium- and long-term weather and fire potential forecasts	SA-3 SA-8	N/A	Provide commentary on trends in weather, fuels, and fire potential. Develop new products.	2028	Section 8.3.5, Weather Forecasting, pp. 499-514 Section 8.3.2.1.2 Existing Systems, Technologies and Procedures pp. 457-462; Section 8.3.4 Ignition Det. Sys. pp. 490-501
Continue to incorporate technologies and pilots into grid monitoring	Early Fault Detection (D&T), SA-11	<ul style="list-style-type: none"> • GO 95 • GO 165 	Grid monitoring procedure updates.	End of 2032	Section 8.3.3.1.1, Radio Frequency Monitors: Early Fault Detection (EFD) (SA-11), p. 469

Note: An asterisk indicates that the electrical corporation exceeds a particular code, regulation, standard, or best practice. The electrical corporation must provide a reference to the appendix section and page providing further documentation, justification, and substantiation.

8.3.1.2 Targets

Initiative targets are forward-looking quantifiable measurements of activities identified by each electrical corporation in its WMP. Electrical corporations will show progress toward completing targets in subsequent reports, including QDRs and WMP Updates.

The electrical corporation must list all targets it will use to track progress on its situational awareness and forecasting for the three years of the Base WMP. Energy Safety's Compliance Assurance Division and third parties must be able to track and audit each target.²²⁹ For each initiative target, the electrical corporation must provide the following:

- *Utility Initiative Tracking IDs.*
- *Projected targets for each of the three years of the Base WMP and relevant units.*
- *The expected "x% risk impact" For each of the three years of the Base WMP. The expected x% risk impact is the expected percentage risk reduction per year, as described in Section 7.2.2.2*
- *Method of verifying target completion.*

The electrical corporation's targets must provide enough detail to effectively inform efforts to improve the performance (i.e., reduction in ignition probability or wildfire consequence) of the electrical corporation's situational awareness and forecasting initiatives.

Table 8-23 provides an example of the minimum acceptable level of information.

In Table 8-23 below, SCE provides the expected risk impact for each initiative at the scoping unit level and at the HFRA-level. The risk impact percentages are in MARS. SCE includes additional columns in the table below showing the percentage of an initiative's scope that is in Severe Risk Area (SRA) and High Consequence Areas (HCA).

²²⁹ Annual information included in this section must align with Table 1 of the QDR.

Table 8-23 - Situational Awareness Initiative Targets by Year

Initiative Activity	Tracking ID	2023 Target & Unit	x% Risk Impact 2023 (Scoped / HFRA)	2024 Target & Unit	x% Risk Impact 2024 (Scoped / HFRA)	2025 Target & Unit	x% Risk Impact 2025 (Scoped / HFRA)	Method of Verification
Weather Stations	SA-1	Install 85 weather stations in SCE's HFRA SCE will strive to install up to 95 weather stations in SCE's HFRA, subject to resource and execution constraints	32%/.01% <i>(PSPS risk only)</i>	Install 50 weather stations in SCE's HFRA SCE will strive to install up to 55 weather stations in SCE's HFRA, subject to resource and execution constraints	32%/.001% <i>(PSPS risk only)</i>	Install 15 weather stations in SCE's HFRA SCE will strive to install up to 20 weather stations in SCE's HFRA, subject to resource and execution constraints	32%/.0001% <i>(PSPS risk only)</i>	List and location of installed weather stations
Weather and Fuels Modeling	SA-3	Equip 500 weather station locations with machine learning capabilities SCE will strive to equip up to 600 weather station locations with machine learning capabilities, subject to resource and execution constraints	3%/.03% <i>(PSPS risk only)</i>	Equip 200 weather station locations with machine learning capabilities SCE will strive to equip up to 300 weather station locations with machine learning capabilities, subject to resource and execution constraints	3%/.03% <i>(PSPS risk only)</i>	Implement machine learning at remaining weather station locations that meet eligible criteria, and for additional variables deemed necessary to improve PSPS planning	3%/.03% <i>(PSPS risk only)</i>	List and location of weather stations equipped with machine learning capabilities
Fire Spread Modeling	SA-8	Complete analytics report summarizing assessment of historical consequence data for improved fire spread modeling	2%/.02%	Provide vendor with analytics report and work with the vendor to complete a plan on future improvements	2%/.02%	Provide recommendation for how consequence metrics can be used for PSPS Decision-Making	2%/.02%	Final analytics report
High Definition (HD) Cameras	SA-10	Install 10 HD Cameras SCE will strive to install up to 20 HD Cameras, subject to resource and execution constraints	4.6%/.01%	Install 10 HD Cameras SCE will strive to install up to 20 HD Cameras, subject to resource and execution constraints	4.60/.01%	No planned installs. Additional installs will be based on reassessment in 2024	N/A	List and location of installed HD cameras
Early Fault Detection	SA-11	Install Early Fault Detection (EFD) at 50 locations SCE will strive to install EFD at up to	6%/.16%	Install Early Fault Detection (EFD) at 50 locations SCE will strive to install EFD at up to 100	6%/.08%	Install Early Fault Detection (EFD) at 200 locations SCE will strive to install EFD at up	5%/.44%	List of completed Work Orders

Initiative Activity	Tracking ID	2023 Target & Unit	x% Risk Impact 2023 (Scoped / HFRA)	2024 Target & Unit	x% Risk Impact 2024 (Scoped / HFRA)	2025 Target & Unit	x% Risk Impact 2025 (Scoped / HFRA)	Method of Verification
		100 locations, subject to resource constraints and other execution risks		locations, subject to resource constraints and other execution risks		to 300 locations, subject to resource constraints and other execution risks		

8.3.1.3 Performance Metrics Identified by the Electrical Corporation

Performance metrics indicate the extent to which an electrical corporation's Wildfire Mitigation Plan is driving performance outcomes. Each electrical corporation must:

- *List the performance metrics the electrical corporation uses to evaluate the effectiveness of its situational awareness and forecasting in reducing wildfire and PSPS risk²³⁰*

For each of these performance metrics listed, the electrical corporation must:

- *Report the electrical corporation's performance since 2020 (if previously collected)*
- *Projected performance for 2023-2025*
- *List method of verification*

The electrical corporation must ensure that each metric's name and values are the same in its WMP reporting as its QDR reporting (specifically, QDR Table 2 and QDR Table 3). Metrics listed in this section that are the same as performance metrics required by Energy Safety and reported in QDR Table 2 (Performance Metrics)²³¹ must match those reported in QDR Table 2. Metrics listed in this section that are not the same as any of the performance metrics identified by Energy Safety and reported in QDR Table 2 must match those reported in QDR Table 3.

The electrical corporation must:

- *Summarize its self-identified performance metric(s) in tabular form*
- *Provide a brief narrative that explains trends in the metrics*

SCE identifies performance metrics that its situational awareness activities support in Table 8-24. Because SCE's situational awareness and forecasting activities are instrumental in reducing PSPS impacts, these metrics overlap with those identified in Section 9 – PSPS. Please refer to Section 9 for a narrative that explains trends in these metrics.

²³⁰ There may be overlap between the performance metrics the electrical corporation uses and performance metrics required by Energy Safety. The electrical corporation must list these overlapping metrics in this section in addition to any unique performance metrics it uses.

²³¹ The performance metrics identified by Energy Safety are included in Energy Safety's Data Guidelines.

Table 8-24 - Situational Awareness and Forecasting Performance Metrics Results by Year

Performance Metrics	2020	2021	2022	2023 Projected	2024 Projected	2025 Projected	Method of Verification (e.g., third-party evaluation, QDR)
Frequency of PSPS Events (total) ²³²	10	8	3	7	7	7	QDR, Tables 3 and 10
Scope of PSPS Events (total) ²³³	424	232	13	210	197	185	QDR, Tables 3 and 10
Duration of PSPS events (total) ²³⁴	4,455,936	3,700,254	112,274	2,508,101	2,282,372	2,076,958	QDR, Tables 3 and 10
Number of customers impacted by PSPS ²³⁵	229,800	179,502	15,784	120,441	102,375	87,019	QDR, Tables 3 and 10

²³² Frequency of PSPS Events definition: Number of instances where utility operating protocol requires de-energization of a circuit or portion thereof to reduce ignition probability, per year. Only include events in which de-energization ultimately occurred

²³³ Scope of PSPS Events definition: Circuit-events, measured in number of events multiplied by number of circuits de-energized per year

²³⁴ Duration of PSPS events definition: Customer hours per year

²³⁵ Number of customers impacted by PSPS definition: Number of customers impacted by PSPS (if multiple PSPS events impact the same customer, count each event as a separate customer)

8.3.2 Environmental Monitoring Systems

The electrical corporation must describe its systems and procedures for monitoring environmental conditions within its service territory. These observations should inform the electrical corporation's near-real-time risk assessment and weather forecast validation. The electrical corporation must document the following:

- *Existing systems, technologies, and procedures*
- *How the need for additional systems is evaluated*
- *Implementation schedule for any planned additional systems*
- *How the efficacy of systems for reducing risk are monitored*

Reference the Utility Initiative Tracking ID where appropriate.

8.3.2.1 Existing Systems, Technologies, and Procedures

The electrical corporation must report on the environmental monitoring systems and related technologies and procedures currently in use, highlighting any improvements made since the last WMP submission. At a minimum, the electrical corporation must discuss systems, technologies, and procedures related to the reporting of the following:

- *Current weather conditions:*
 - *Air temperature*
 - *Relative humidity*
 - *Wind velocity (speed and direction)*
- *Fuel characteristics:*
 - *Seasonal trends in fuel moisture*

Each system must be summarized in Table 8-25. The electrical corporation must provide the following additional information for each system in the accompanying narrative:

- *Generalized location of the system / locations measured by the system (e.g., HTFD, entire service territory).*
- *Integration with the broader electrical corporation's system.*
- *How measurements from the system are verified.*
- *Frequency of maintenance.*
- *For intermittent systems (e.g., aerial imagery, line patrols), what triggers collection. This should include flow charts and equations as appropriate.*

For calculated quantities, how raw measurements are converted into calculated quantities. This should include flow charts and equations as appropriate.

SCE summarizes each of its environmental monitoring system in the table below. SCE details its efforts

to understand trends in seasonal fuel moisture and other fuel characteristics in Section 8.3.2.1.2 - Fuel Sampling (Fire Science SA-8).

Table 8-25 - SCE’s Environmental Monitoring Systems

System	Measurement/ Observation	Frequency	Purpose and Integration
Weather Stations (SA-1)	Wind speed, wind direction, 3-second max wind gust, temperature, dew point, relative humidity, solar radiation (where applicable)	10-minutes, hourly, 24-hour (daily), 30-second reads on stations with cellular communications	Provide weather data for PSPS decision making Provide weather data for forecasts.
Fuel Sampling (SA-8)	Vegetation Moisture	Bi-weekly	Assess how receptive the fuels are to fire and help align FPI values when forecasts of live fuel moisture are misaligned with observations.
Fire Science (SA-8)	Santa Ana Wind Outlook	Monthly	Determine above or below normal Santa Ana wind days for the one-month and three-month periods.
Live Field Observations	Supplement information from weather stations and also identify flying debris, wire slap and other hazardous conditions that may be present at impacted area	As needed during PSPS	Qualified personnel can be deployed to high-risk portions of the grid to take live wind readings to supplement information from fixed weather stations and to watch for other inclement hazards.

8.3.2.1.1 Weather Stations (SA-1)

Weather stations are used to provide critical situational awareness for PSPS decision-making and help improve weather models. SCE’s weather stations provide data points such as temperature measurements, wind speeds, wind direction, dew point, and relative humidity. Weather conditions can differ significantly at any given time within the HFRA in SCE’s service area, due to the large size and diverse topography involved. For example, Southern California’s mountains have rapid elevation changes and differing canyon orientations, which create localized weather zones. Installing weather stations on specific segments of circuits, SCE can sectionalize circuits and reduce the scope of PSPS events, where possible, thereby reducing the impact on our customers.

SCE monitors and analyzes weather data at the circuits and circuit segments, where available, across HFRA to inform critical operational decisions such as deploying PSPS protocols during elevated weather

conditions. Granular, circuit-level or circuit-segment level weather data is used by incident management team (IMT) personnel to inform initiation of PSPS events, customer notifications, de-energization decisions for SCE circuits, re-energizations, as well as limiting the impact of PSPS to the extent possible to particular segments of a circuit instead of a full circuit, where applicable, dependent on circuit configurations.

To improve existing weather models and access more granular real-time information during wildfire risk conditions, SCE increased the number of weather stations across distribution, sub-transmission and bulk-transmission circuits in its HFRA. A higher density of weather stations allows SCE to validate real-time conditions in the field during elevated fire conditions. Adding weather stations to transmission circuits will also help improve the visibility of the service area for enhanced weather models and accuracy, where data was not previously captured. Weather stations on transmission circuits provide a broader, more holistic weather forecast model as data from these stations are in locations not previously captured. Transmission weather stations allow for more complete weather modeling for situational awareness. Having more stations also expands and increases the granularity of data to enable improved weather forecasting capabilities at the circuit and circuit-section level.

As of December 2022, SCE has over 1,600 weather stations deployed across its HFRA, primarily on the distribution system, including over 115 stations on the sub-transmission and bulk-transmission system. SCE used industry equipment standards and placement techniques to capture the wind profiles of its circuits, while at times siting more than one station per circuit to account for variations in terrain, as well as circuit segmentation to minimize customer impacts.

Highlights since last WMP submission

SCE continued to expand its weather station network by installing 160 new weather stations in 2022, of which 53 were dual communications (cellular and satellite) stations. SCE further enhanced the existing network of weather stations by converting 127 existing stations to dual communication stations, to allow for real-time weather read capabilities as well as redundancy. Dual communication stations have both cellular and satellite communication capabilities. The satellite network is not reliable enough to facilitate increased weather reads more frequently than the current 10-minute reads. Cellular communications are capable and reliable for increased data collection intervals. Post 2019, weather station installations only consisted of satellite communications, therefore the addition of cellular modems will help us to achieve more frequent data reads per Energy Safety's Final Decision on SCE's WMP 2022 Update.

In 2023, SCE plans to convert approximately 500 existing stations into dual communication stations by adding cellular modems, where cellular coverage is available. In addition, SCE will attempt to pilot 30-second reads during 2023 PSPS events in order to learn how to best operationalize real time data reads on selected stations, based on PSPS needs and station functionality. Please see Appendix D: Areas for Continued Improvement for additional detail provided in response to a related ACI from SCE's 2022 WMP.

Generalized location of the system / locations measured by the system (e.g., HTFD, entire service territory)

SCE prioritizes weather station installations on HFRA circuits that are most likely to exceed PSPS wind thresholds. All distribution circuits that have met or exceeded PSPS wind thresholds in the past five

years now have at least one weather station installed. Not every distribution circuit in the HFRA has a weather station installed, but is in close enough proximity to have a nearby weather station assigned to provide coverage. Some circuits also need additional stations to obtain the desired level of situational awareness due to repeated PSPS impacts.

At this time, SCE considers the following in sequential order when prioritizing the locations of weather station installations:

1. HFRA distribution circuits with historical instances of forecasts reaching PSPS criteria²³⁶ and does not have an assigned weather station to provide coverage.
2. HFRA distribution circuits that have previously experienced PSPS conditions and could benefit from extra weather stations for additional sectionalizing.
3. Sub-transmission and transmission monitoring zones with historical instances of forecasts reaching PSPS criteria and have no representative weather stations.
4. PSPS Operations subject matter experts' identification of circuits that would benefit from a weather station or an additional weather station by potentially limiting the number of customers impacted by a PSPS event by having more granular weather data available at a circuit/segment

Once the circuit is identified, placement along the circuits depends on several factors, including, but not limited to the following:

- Location is in a wind prone area (SCE prioritizes those circuits in wind-prone locations where the potential consequences of a catastrophic fire are high);
- Location is easily accessible to maintenance crews;
- Location has a clear view of the southern horizon for solar power recharge purposes as the stations are battery-powered;
- Location is free from major obstructions such as trees and buildings.

Integration with the broader utility system

While the primary intended purposes of the weather stations installed under this initiative are intended to support wildfire and PSPS risk mitigation, they can and do support other secondary functions within the utility. The following are some of the other applications of weather stations:

- SCE uses the weather data from the weather stations to forecast demand for load conditions to aide energy procurement.
- SCE's Transmission and Distribution organization uses weather data forecasts from SCE's weather services organization for outage forecasting to complete field work related to outages (e.g. pole replacements).

²³⁶ See <https://energized.edison.com/pssp-decision-making> for a description of SCE's PSPS decision-making criteria.

- SCE inputs the weather data for its-flown field conditions, the weather at the time of an aerial inspection, into its computer aided design and drafting program to help determine max-sag and max-sway for lidar imaging.
- SCE uses the current and historical weather data to provide seasonal outlooks for long term weather forecasting.
- Various IMTs unrelated to PSPS are sometimes activated during storm events, where high winds, rains, thunderstorms, etc. may be present but PSPS conditions are lacking, and rely on data from weather stations for situational awareness.

Process to verify measurements from the system

The weather stations in the field are calibrated on a nearly annual basis, based on field access, scheduling and coordination with other work. These calibrations are conducted with a set of specific tools as a part of the routine maintenance. The calibrations are a form of quality control to ensure accurate data reads as the tools compare station data to kit tools monitoring the same field conditions.

The data collected from the weather stations is also verified by checking for outlier reads compared to nearby stations. Outlier data is identified as possibly erroneous and not recorded for historical recall.

Frequency of maintenance

The weather stations are currently maintained approximately once per year, based on field access, scheduling and coordination with other work. SCE plans to adopt an annual calibration maintenance cycle by the end of 2023, based on weather station industry standards. Calibrations are completed on each station. The calibration validates data observed in the field and compares the values to those being collected by the weather station. The various weather station instruments are cleaned, tightened, re-aligned, replaced, etc., as needed during the calibration.

For intermittent systems (e.g., aerial imagery, line patrols), the processes used to trigger collection. This should include flow charts and equations as appropriate to describe the process.

Weather Stations are not considered an intermittent system; as such, this question does not apply.

For calculated quantities, the processes used to convert raw measurements to calculated quantities. This should include flow charts and equations as appropriate to describe the process

Weather stations are not a calculated quantity; as such, this question does not apply.

8.3.2.1.2 Fuel Sampling (Fire Science SA-8)

Frequently throughout the year it is important to view and collect vegetation moisture observations for the purposes of increasing our intra-year wildfire situational awareness. While local fire agencies conduct fuel sampling, SCE determined it would be beneficial to sample in areas where gaps exist both spatially and temporally in areas not covered by fire agencies and within its service territory. Fuel sampling consists of physically collecting small portions of the native vegetation, which is then brought to a lab to be weighed, dried, and then weighed again to determine the vegetation's moisture content. To assure the fuels sampling program is properly managed and there is little interruption of data, SCE

checks that all samples are collected and analyzed properly and resolves issues that may arise at any of the sites with the vendor as quickly as possible. This helps to ensure that the fuel sampling data is high-quality and will result in better model solutions and outputs.

Highlights since last WMP submission

In 2022, SCE continued sampling moisture levels within the live vegetation at the same 15 locations through its Fuels Sampling Program. SCE is continuing to evaluate the feasibility of expanding the program to collect samples from additional sites in SCE's HFRA where observation gaps may still exist (for instance in the Tehachapis or Southern Sierra). Also, SCE successfully used some of its sampled data from the past two years to approximate live fuel moisture content in other vegetation species such as sagebrush and ceanothus/manzanita.

Generalized location of the system / locations measured by the system (e.g., HTFD, entire service territory)

There are 15 fuel sampling sites within SCE's HFRA. These sites were initially selected by determining where areas could use more sampling to improve its locational fuel data, and then further refined based on SCE's right-of-way access, proximity to major roads, and the amount, type, and health of the vegetation at each location.

Integration with the broader utility system

This data is used extensively to help assess daily fire potential and to adjust FPI calculations when needed during PSPS events.

Process to verify measurements from the system

Measurements are verified by comparing the results with fuel sampling measurements performed by fire agencies.

Frequency of maintenance

Sampling is performed every two weeks throughout the year except when conditions are too wet from rain or vegetation is covered in snow.

For intermittent systems (e.g., aerial imagery, line patrols), the processes used to trigger collection. This should include flow charts and equations as appropriate to describe the process

Fuel Sampling is not considered an intermittent system, and as such, this question does not apply.

For calculated quantities, the processes used to convert raw measurements to calculated quantities. This should include flow charts and equations as appropriate to describe the process

Live Fuel Moisture Content (LFMC) is calculated by the following:

$$\text{LFMC} = \frac{\text{Weight of water in the vegetation}}{\text{Dry weight of the vegetation}} \times 100$$

This formula is applied individually to each vegetation species sampled at each of the 15 fuel sampling locations.

8.3.2.1.3 Fire Science Enhancements (Fire Science, SA-8)

SCE continues to build upon its foundational fire science program established several years ago. These enhancements include improving dead fuel moisture modeling, investigating historical weather patterns associated with critical fire weather events, and improving long-range fire potential forecasting. These enhancements are specifically designed to support the higher prioritized objectives associated with SCE's wildfire mitigation efforts for more risk-informed decision-making.

Improvements to dead fuel moisture modeling are necessary for better assessments of fire potential, especially how it relates to PSPS and associated customer notifications. Dead fuel moisture is one of the major inputs into the Fire Potential Index (FPI), which is a critical metric used in helping identify which customers may be affected by PSPS and when.

In 2025, SCE plans to utilize Self-Organizing Maps (SOMS) which are a form of pattern recognition and can be used to identify meteorological patterns that lead to extreme weather events. For example, SOMS can be used to not only identify Santa Ana winds, but they can also identify the characteristic of the Santa Ana wind events (i.e., magnitude, duration, and location). SOMS can also relate weather patterns to fire activity to show what fires may exhibit extreme fire behavior based on weather scenarios. This type of pattern recognition can be used as a predictive tool in helping identify potential PSPS events and situations where multiple large fires can occur simultaneously. SOMS can be incorporated into climate change modeling to show what trends exist in critical weather patterns that may pose a threat to SCE's infrastructure.

SCE's Santa Ana Wind Outlook subscription allows SCE to continue receiving 1-month and 3-month ahead forecasts of Santa Ana winds over the service territory. The model consists of several components, including a machine learning approach to help determine the approximate number of days over the forecast period in which Santa Ana wind conditions will occur. These forecasts are used in combination with SCE's seasonal outlooks to help inform the frequency of these events when planning for inspections and remediations across SCE's service area.

Finally, SCE has partnered with the California Polytechnic State University, San Luis Obispo (Cal Poly-SLO) and SJSU on academic research initiatives through the Wildland Urban Interface Fire Institute and the Wildfire Interdisciplinary Research Center (WIRC), respectively to support projects that address California's IOUs efforts to reduce utility caused ignitions.

Highlights since last WMP submission

In 2022, SCE retrained the machine learning models used to generate its Santa Ana Wind 1-month and 3-month-ahead outlooks. These retrained models incorporate more history and allow for improved forecasting of these types of events. In addition, SCE was able to generate products that compare forecasts of wind, temperature, FPI, etc., to historical weekly climatologies. These products allow the

user to understand the current forecast as it relates to past weather events.

Generalized location of the system / locations measured by the system (e.g., HTFD, entire service territory)

These efforts cover the SCE service area.

Integration with the broader utility system

The Santa Ana wind outlook is utilized for seasonal forecasting, while the dead fuel moisture model is used as a direct input into our daily assessment of fire potential.

Process to verify measurements from the system

SCE's vendor, ADS, provides verification for the Santa Ana Wind Outlook and the dead fuel moisture forecast.

Frequency of maintenance

Models are retrained every two-to-four years in order to better account for any large-scale atmospheric changes. In meteorology, large-scale is defined as a horizontal length scale of the order of 1000 kilometers (about 620 miles) or more.

For intermittent systems (e.g., aerial imagery, line patrols), the processes used to trigger collection. This should include flow charts and equations as appropriate to describe the process

Fire Science Enhancements is not an intermittent system and as such this question is not applicable.

For calculated quantities, the processes used to convert raw measurements to calculated quantities. This should include flow charts and equations as appropriate to describe the process

Fire Science Enhancements is not a calculated quantity and as such this question is not applicable.

8.3.2.1.4 Live Field Observations

SCE trains and deploys personnel to perform line patrols and live field observations (LFOs), providing critical situational awareness during PSPS to inform decision-making.

During PSPS, real-time information regarding the impacted areas can help determine the need for various just-in-time wildfire mitigations efforts, such as vegetation remediation and infrastructure repairs. In-person observations may help to supplement information from weather stations and identify flying debris, wire slap and other hazardous conditions that may be present at the impacted area. Prior to re-energization, in-person observations may also help to identify whether lines are clear of potential hazards. Without these observations, SCE would miss some valuable inputs, compromising its ability to make informed decisions about potential PSPS de-energizations and re-energizations.

Line patrols and LFOs (monitoring) provide critical sources of situational awareness that allow for the execution of SCE's PSPS protocols before and during a PSPS event, and after weather conditions have abated. Before an event, line patrols are carried out by qualified personnel (e.g., troublemen, senior patrolmen, etc.) using iPads to examine SCE assets for any potential concerns that may be exacerbated by the upcoming wind event. During an event, qualified personnel can be deployed to high-risk portions of the grid to take live wind readings using handheld weather stations to provide field conditions readings to supplement information from fixed weather stations and to watch for other inclement hazards (e.g., airborne debris). These LFOs are performed to provide real-time data to SCE's Emergency

Operations Center. After concerning weather conditions have abated, SCE must dispatch qualified personnel again to perform restoration patrols on all circuits that experienced a PSPS de-energization to ensure that they are safe for service restoration.

These protocols are imperative to SCE's decision making and will continue to be a part of SCE's WMP for the foreseeable future. Even with expanding automation and new technology, providing SMEs with visibility to grid and weather conditions provides invaluable situational awareness on local hazards like swaying lines with potential for wire-to-wire contact and airborne debris or vegetation. Field observers can also provide real-time weather reads using portable devices, supplementing weather station coverage of SCE's HFRA circuits.

Highlights since last WMP submission

In the latter half of 2022, SCE augmented PSPS pre-patrols with inspectors from the Vegetation Management team as part of an exploratory effort to better understand vegetation-related risks leading up to and associated with PSPS events, and to prescribe appropriate mitigations if any concerning issues were identified. In 2023, SCE plans to review the findings to better understand the risks involved and how they specifically relate to asset and field conditions associated with PSPS events and develop the appropriate mitigation, if any, through the established vegetation management inspection and remediation programs.

Using lessons-learned, SCE focused on resource management in order to execute on live field observations and quickly mobilize patrol resources, particularly during holidays when resources can be constrained. SCE modified internal policies that limited SCE's ability to pre-stage patrol aircraft to ensure they were available as soon as PSPS conditions abated, in addition resource planning meetings were held several days prior to the event to ensure the right level of support through the entire duration of events.

Generalized location of the system / locations measured by the system (e.g., HTFD, entire service territory)

Line patrols and field observations are performed throughout the HFRA on any circuit that is in scope for PSPS consideration.

Integration with the broader utility system

The deployment and use of Live Field Observers (LFOs) is limited to PSPS events and, as a result, is not integrated with daily operations on the SCE grid.

Process to verify measurements from the system

Not applicable, as this activity involves observations of weather and environmental conditions.

Frequency of maintenance

Annually, SCE delivers training to PSPS field personnel and briefs its contractors engaged in wildfire mitigation activities on requirements, potential impacts, and any updates to PSPS protocols since the prior year.

For intermittent systems (e.g., aerial imagery, line patrols), the processes used to trigger collection. This should include flow charts and equations as appropriate to describe the process

SCE utilizes proactive de-energization as a measure of last resort when all alternatives to de-energization are insufficient to address wildfire risk. The period of concern (POC) is when fire weather is forecasted that could potentially impact SCE’s service territory. SCE performs pre-patrols of circuits in scope and deploys field personnel to circuits at risk to monitor real-time weather conditions.

LFOs provide critical sources of situational awareness that allow for the execution of SCE’s PSPS protocols before and during a PSPS event, and after weather conditions have abated. These LFOs are performed to provide real-time data back to SCE’s Emergency Operations Center. If field conditions are unsafe, field personnel performing the LFOs are required to notify the PSPS IMT.

After weather conditions have subsided, SCE dispatches qualified personnel to perform restoration patrols on all circuits that experienced a PSPS de-energization to ensure that re-energization is safe for service restoration.

The type of patrols performed by field personnel on circuits that appear on the POC Report include:

1. Pre-patrol: May be initiated up to five days in advance of the forecasted event.
2. LFO: Patrols performed during the POC Report.
3. Restoration Patrols: Performed during restoration to ensure no hazards exist before energizing circuit sections
4. Post-Patrol: Performed on circuits that were not de-energized at the request of the IMT Incident Commander.

Figure SCE 8-46 - PSPS LFO & Patrolling Process

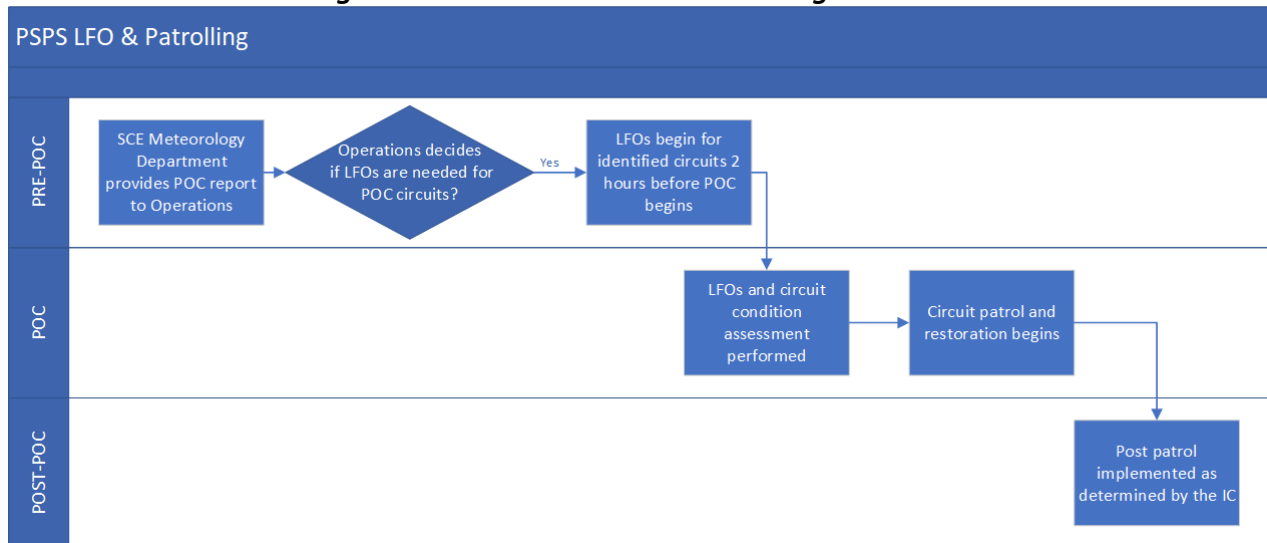

For calculated quantities, the processes used to convert raw measurements to calculated quantities. This should include flow charts and equations as appropriate to describe the process

Live Field Observations is not a calculated quantity, and as such this question does not apply.

8.3.2.2 Evaluation and Selection of New Systems

The electrical corporation must describe how it evaluates the need for additional environmental monitoring systems. This description must include:

- How the electrical corporation evaluates the impact of new systems on reducing risk (e.g., expected quantitative improvement in weather forecasting)
- How the electrical corporation evaluates the efficacy of new technologies These descriptions should include flow charts as appropriate.

SCE continuously evaluates its current environmental monitoring systems for opportunities for improvement. As noted in Section 8.3.2.3, SCE is developing several changes and improvements to its environmental monitoring activities, which are intended to address areas and needs where SCE determined that its activities could be improved as existing technology advances.

8.3.2.2.1 How the electrical corporation evaluates the impact of new systems on reducing risk (e.g., expected quantitative improvement in weather forecasting)

SCE evaluates the impact of new systems by first proving the use case for the new system or technology with small case studies or limited deployment of the system or technology. SCE will observe the new technology or system to see if there are quantifiable impacts to SCE operations (e.g., fewer customers on a circuit de-energized during a PSPS event) or if the system or technology can aide in SCE's operational decision marking (e.g., improvement in weather forecasting).

8.3.2.2.2 How the electrical corporation evaluates the efficacy of new technologies

Once a system or technology has been operationalized, SCE evaluates the efficacy of the new systems or technologies by validating that the systems or technologies are being used and providing essential information to aide in SCE's decision-making process. This process occurs in a few cross-functional groups across SCE who routinely meet and discuss identified improvements to aide in efforts to continuously improve its situational awareness.

8.3.2.3 Planned Improvements

The electrical corporation must describe its planned improvements for its environmental monitoring systems.²³⁷ This must include any plans for the following:

- Expansion of existing systems
- Establishment of new systems

For each planned improvement, the electrical corporation must provide the following in Table 8-26:

- **Description:** A description of the planned initiative activity
- **Impact:** Reference to and description of the impact of the initiative activity on each risk and risk component
- **Prioritization:** A description of the x% risk impact (see Section 8.1.1.2 for explanation)

²³⁷ Annual information included in this section must align with Tables 7 and 8 of the QDR.

- **Schedule:** A description of the planned schedule for implementation

SCE provides its planned improvements to its Environmental Monitoring Systems in Table 8-26 below.

Table 8- 26 - SCE’s Planned Improvements to Environmental Monitoring Systems

System	Description	Impact	x% Risk Impact	Implementation Schedule
Weather Stations (SA-1)	SCE plans to install an additional 85, with a strive goal of 95, weather stations in 2023. SCE will continue to install on sub-transmission and bulk-transmission locations for more complete weather forecast models. Installs will also still occur at the distribution circuit level.	The additional weather stations will improve existing weather models and provide more granular real-time information during wildfire risk conditions. Additional weather stations will also enable SCE to sectionalize circuits and reduce the scope of PSPS events, where possible, thereby reducing the impact on our customers	Please see Table 8-23 for risk impact information	End of 2025
Remote Sensing (SA-8)	SCE plans to develop the Vegetation Build-up Index with the University of Colorado.	The Vegetation Build-up index will provide better assessment of long-term fire potential	Please see Table 8-23 for risk impact information for all of SA-8	End of 2024

System	Description	Impact	x% Risk Impact	Implementation Schedule
Fire Science Enhancements (SA-8)	SCE will work to continuously improve the accuracy of its weather modeling capabilities and begin work in SOMS in 2025.	SOMS can be used to identify meteorological patterns that lead to extreme weather events.	Please see Table 8-23 for risk impact information for all of SA-8	End of 2025
Climate Change Modeling (SA-8)	Starting in 2025, SCE will downscale multiple Global Climate Models (GCM's) to 1-kilometer resolution with hourly temporal resolution of various weather and fuel parameters such as temperature, relative humidity, wind, fuel moisture, and FPI.	This allow for detailed analysis to be conducted to show trends in weather, fuels, and fire potential.	Please see Table 8-23 for risk impact information for all of SA-8	End of 2028

SCE also provides additional information on its Remote Sensing and Climate Change Modeling planned improvements that was not discussed in Section 8.3.2.1.

8.3.2.3.1. Remote Sensing (Fire Science-SA-8)

SCE is implementing remote sensing technology to collect additional information on weather, fuels, and fire activity to enhance SCE’s wildfire modeling capabilities. Collecting weather, fuels, and fire activity information in remote areas is challenging, which makes it necessary for SCE to continually evaluate ways to improve its situational awareness in these areas.

SCE’s Fire Sciences organization is actively engaged in two remote sensing projects:

1. SCE is working with the University of Colorado, Boulder to develop a Vegetation Build-Up Index which will utilize remote sensing information pertaining to vegetation amount, type, and age to determine where the greatest threat for significant fire may be possible within SCE’s service area within the next 6 months. The Vegetation Buildup Index will result in a heat map showing

the approximate areas where the dynamic combustibility of fuels is greatest. This product will allow for an objective, quantifiable process to help identify AOCs which are areas where inspections and potential remediations of any known issues are accelerated.

2. SCE will continue to explore its LiDAR pilot project with San Jose State University (SJSU) to measure wind speeds. While SCE uses LiDAR for vegetation management purposes, LiDAR technology in this case is used to observe wind speeds above the ground every 5 minutes. When circuit level wind speeds are difficult to predict due to complex terrain, monitoring wind speeds above these circuits could provide insight into the behavior of the wind and the potential for PSPS threshold winds to extend down to the circuit level. This data may potentially be useful in the decision-making process regarding PSPS de-energization.

SCE began implementing a lower atmospheric wind profiler pilot project in 2021 in connection with SJSU. The pilot includes profiling winds in the lower atmosphere using LiDAR technology to collect wind observations above ground level. In 2022, SCE continued to use SJSU's LiDAR system to sample wind speeds at specific locations on an ad hoc basis dependent on the occurrence of Santa Ana winds.

8.3.2.3.2 Climate Change Modeling (Fire Science-SA-8)

With the rapid change in climate and its impact on wildfire activity, it is imperative that SCE have detailed projections of weather and fuel conditions to determine changes in fire potential and fire activity in the future. This information will drive decision-making regarding any remaining grid hardening activities and will help SCE be better prepared for future changes in wildfire.

Starting in 2025, SCE will downscale multiple Global Climate Models (GCM's) to 1-kilometer resolution with hourly temporal resolution of various weather and fuel parameters such as temperature, relative humidity, wind, fuel moisture, and FPI. These datasets will allow for detailed analysis to be conducted to show trends in weather, fuels, and fire potential. It is also possible that this data can help determine trends in the number of PSPS events in the future. The result of these analyses will not only help to improve SCE's weather and fuels modeling, but it will also help inform how SCE designs its equipment and grid structure moving forward.

8.3.2.4 Evaluating Mitigation Initiatives

The electrical corporation must describe its procedures for the ongoing evaluation of the efficacy of its environmental monitoring program.

SCE's procedures for the ongoing evaluation of the efficacy of its environmental monitoring program include a review of how these systems are used and verifying system measurements are accurate.

SCE continuously evaluates the efficacy of its environmental monitoring program by validating that it consistently provides essential information to aide in SCE's decision-making process. SCE's environmental monitoring systems and processes have evolved from operational decision making during PSPS events only, to being used on a daily basis to inform assessments of the service territory, fire risk, and provide situational awareness. The continued use and refinement of SCE's environmental monitoring systems assures SCE is producing the desired result it intended to. In evaluating new technologies and industry standards of the same or similar systems, SCE is able to assess and confirm efficacy due to the growth of use, and even expansion, in its various systems.

And as discussed in each environmental monitoring system, SCE has developed a process to verify the

measurement from the system so that SCE can rely on the information the system or process provides. SCE is continuously evaluating its environmental monitoring systems to determine areas for improvements. As noted above in Section 8.3.2.3, SCE is developing several changes and improvements to its environmental monitoring activities, which are intended to address areas and needs where SCE determined that its activities could be improved.

8.3.3 Grid Monitoring Systems

The electrical corporation must describe its systems and procedures used to monitor the operational conditions of its equipment. These observations should inform the electrical corporation's near-real-time risk assessment. The electrical corporation must document:

- *Existing systems, technologies, and procedures*
- *Procedure used to evaluate the need for additional systems*
- *Implementation schedule for any planned additional systems*
- *How the efficacy of systems for reducing risk are monitored Reference the Utility Initiative Tracking ID where appropriate.*

8.3.3.1 Existing Systems, Technologies, and Procedures

The electrical corporation must report on the grid system monitoring systems and related technologies and procedures currently in use, highlighting any improvements made since the last WMP submission. At a minimum, the electrical corporation must discuss systems, technologies, and procedures related to the detection of:

- *Faults (e.g., fault anticipators, rapid earth fault current limiters, etc.)*
- *Failures*
- *Recloser operations*

Each system must be summarized in Table 8-27 below. The electrical corporation must provide the following information for each system in the accompanying narrative:

- *Location of the system / locations measured by the system*
- *Integration with the broader electrical corporation's system*
- *How measurements from the system are verified*
- *For intermittent systems (e.g., aerial imagery, line patrols), what triggers collection. This should include flow charts and equations as appropriate*
- *For calculated quantities, how raw measurements are converted to calculated quantities. This should include flow charts and equations as appropriate.*

Below, SCE summarizes each of its grid operation monitoring systems in Table 8-27. SCE employs a variety of systems/technologies to track and monitor issues on its grid related to faults, failures and recloser operations. SCE's Grid Operations team will monitor faults and power flow, and work to respond and/or dispatch qualified resources to remediate issues in the field.

For systems such as Early Fault Detection (EFD) and Distribution Fault Anticipation (DFA), reviews of data collected from EFD and DFA are not performed immediately and therefore the information does not inform near-term risk assessment. SCE also analyzes outages, faults and wire-down data collected from these systems to make recommendations for any changes needed to the suite of existing grid monitoring systems/technologies.

Table 8-27 - Grid Operation Monitoring Systems

System	Measurement/ Observation	Frequency	Purpose and Integration
Radio Frequency Monitors	<ul style="list-style-type: none"> • High frequency discharges 	Approximately 4.16 million samples per cycle	Identifies incipient faults before they are realized, e.g., Early Fault Detection (EFD) (SA-11)
Protective Relays	<ul style="list-style-type: none"> • Electrical current • Electrical voltage • Wave form harmonics 	Minimum 4 samples per cycle.	Detects abnormal grid conditions such as faults, wire-downs, open phase conditions, and high impedance faults and deenergizes those circuits or circuit segments, e.g., TOPD (SH-8), Hi-Z, DOPD, and Fast Curves
Smart Meters	<ul style="list-style-type: none"> • Electrical voltage • Electrical usage (kWh) • Meter exceptions and events (voltage thresholds that are exceeded, power off and on) 	Voltage readings are in hourly intervals. Usage readings are either 15 minute or 1 hour intervals. Meter events are logged in the meter as they exceed thresholds. Meter exceptions are generated near real-time when thresholds are exceeded.	Detects energized wire-downs and other high impedance faults/hazards or identifies a failure mode of distribution transformers, e.g., MADEC, Transformer Early Damage Detection
Fault Recorders	<ul style="list-style-type: none"> • Electrical current • Electrical voltage • Wave form harmonics 	For transient records, minimum 20 samples per cycle. For long term records, minimum 4 samples per cycle.	Verifies faulted phases, fault locations and relay operation after a faulted event, e.g., Digital Fault Recorder (DFR)

System	Measurement/ Observation	Frequency	Purpose and Integration
Fault Current Limiters	<ul style="list-style-type: none"> • Electrical current • Electrical voltage 	Approximately 83 samples per cycle	Detects ground fault and reduces voltage on faulted lines, e.g., REFCL

8.3.3.1.1 Radio Frequency Monitors: Early Fault Detection (EFD) (SA-11)

EFD technology detects high frequency radio emissions that can occur from arcing or partial discharge conditions on the electric system. These types of conditions can be indicative of an incipient failure, such as severed strands on a conductor, vegetation contact, or deterioration of insulating material (known as tracking). EFD could potentially be used to monitor the overall health of the electric system which may inform operational decisions during high-risk conditions. Each pair of sensors is able to “bi-angulate” the detection down to a specific location.

- *Location of the system / locations measured by the system:* EFD sensors are installed every 3 circuit miles on distribution circuits and every 5 circuit miles on sub-transmission and transmission circuits. All circuitry between sensor pairs is monitored by the system.
- *Integration with the broader electrical corporation’s system:* EFD presently leverages the use of conventional cellular carriers (AT&T, T-Mobile, Verizon) and cloud service providers (Amazon Web Services) to operate and is not directly integrated with SCE systems.
- *How measurements from the system are verified:* SCE uses patrols and inspections to verify the conditions of assets identified by EFD as being potentially degraded or defective.
- *For intermittent systems (e.g., aerial imagery, line patrols), what triggers collection. This should include flow charts and equations as appropriate:* Not applicable. These are not intermittent systems despite having sampling intervals as the systems are continuously operating to detect conditions. EFD sensors continually monitor the lines in locations where the sensors are deployed. If a potential fault condition is detected, the EFD system will begin recording and reporting the data. A "detection" is either a high voltage excursion or a sample that is detected at multiple EFD's ("matching detection"). The analysis of EFD data is then performed manually by SCE’s engineers. If engineering finds that the EFD technology detected a potential issue on the grid, they will notify the district, who creates a notification and repair work order for patrols and inspections to verify the condition of the asset(s) in the field.
- *For calculated quantities, how raw measurements are converted to calculated quantities. This should include flow charts and equations as appropriate:* Not applicable. EFD does not use calculated quantities.

8.3.3.1.2. Protective Relay—e.g., Transmission Open Phase Detection (TOPD), Distribution Open Phase Detection (DOPD), High-Impedance faults Relays (Hi-Z), Rapid Earth Fault Current Limiters (REFCL), RARs, Fast Curve, Circuit Breaker Relays

8.3.3.1.2.1 Protective Relay - Transmission Open Phase Detection (TOPD) (SH-8)

TOPD technology allows de-energization of an open phase (broken conductor) on the transmission system before it contacts a grounded object resulting in a fault event. This technology reduces ignition risks associated with the high voltage transmission system. Please see Section 8.1.8.1.3.2 for a detailed discussion of TOPD.

- *Location of the system / locations measured by the system:* SCE equips existing Transmission relays that protect the Transmission lines residing in HFRA with the TOPD scheme. The TOPD scheme provides open phase detection from both the local and remote terminal to the whole Transmission line on which the TOPD-equipped Transmission relay sits.
- *Integration with the broader electrical corporation's system:* The TOPD scheme provides an additional layer of protection for Transmission lines and is integrated with the Energy Management System (EMS).
- *How measurements from the system are verified:* TOPD is in the pilot stage and most of the installation will remain in "Alarm mode" only, including new installations of TOPD. During "Alarm Mode" the TOPD scheme will not de-energize Transmission lines (please see Section 8.1.8.1.3.2 for a detailed discussion of TOPD). Upon receiving an Open Phase alarm, analysis of the any available relay oscillographs will be performed to determine operational effectiveness.
- *For intermittent systems (e.g., aerial imagery, line patrols), what triggers collection. This should include flow charts and equations as appropriate:* Not applicable. These are not intermittent systems despite having sampling intervals as the systems are continuously operating to detect conditions. TOPD provides continuous monitoring of the Transmission line for an Open phase event related to a hardware failure.
- *For calculated quantities, how raw measurements are converted to calculated quantities. This should include flow charts and equations as appropriate:* The TOPD scheme is continuously monitoring the Transmission line for a loss of current on any single phase (wire). The minimum arming requirements must be met to successfully declare an open phase event. Upon an identification of a loss of phase, the TOPD scheme will validate that remaining phases are continuing to operate normally (un-faulted, normal load, etc.). If the above requirements are met, the TOPD will successfully declare an Open Phase event providing a local and remote alarm.
- TOPD is armed when loading is above 13% of the primary current transformer ratio (CTR) and identifies an open phase event on the transmission line for a single conductor break. The scheme measures the primary current of a Current Transformer (CT) by measuring the secondary of the CT and then multiplying by the CTR.

$$TOPD_{Arming} \geq 13\% * CTR_{Pri}$$

8.3.3.1.2.2 Protective Relay—Distribution Open Phase Detection (DOPD)

Similar to TOPD, DOPD is a technology on the distribution system that allows de-energization of an open phase (broken conductor) before it contacts a grounded object resulting in a fault event.

- *Location of the system / locations measured by the system:* The DOPD scheme leverages existing assets (Distribution Recloser Controllers) that protect the Distribution lines residing in high fire risk areas.

- *Integration with the broader electrical corporation's system:* The DOPD scheme is integrated with the Distribution Management System (DMS) and provides an additional layer of protection that is continuously monitoring the Distribution line for an Open phase event related to a hardware failure.
- *How measurements from the system are verified:* The DOPD scheme is being deployed initially in "alarm mode" only during the pilot stage. Upon receiving an open phase alarm, analysis is performed on the available relay oscillographs to determine operational effectiveness. Figure SCE 8-47 below demonstrates how DOPD alarms are currently verified.

Figure SCE 8-47 - DOPD Alarm Verification Process

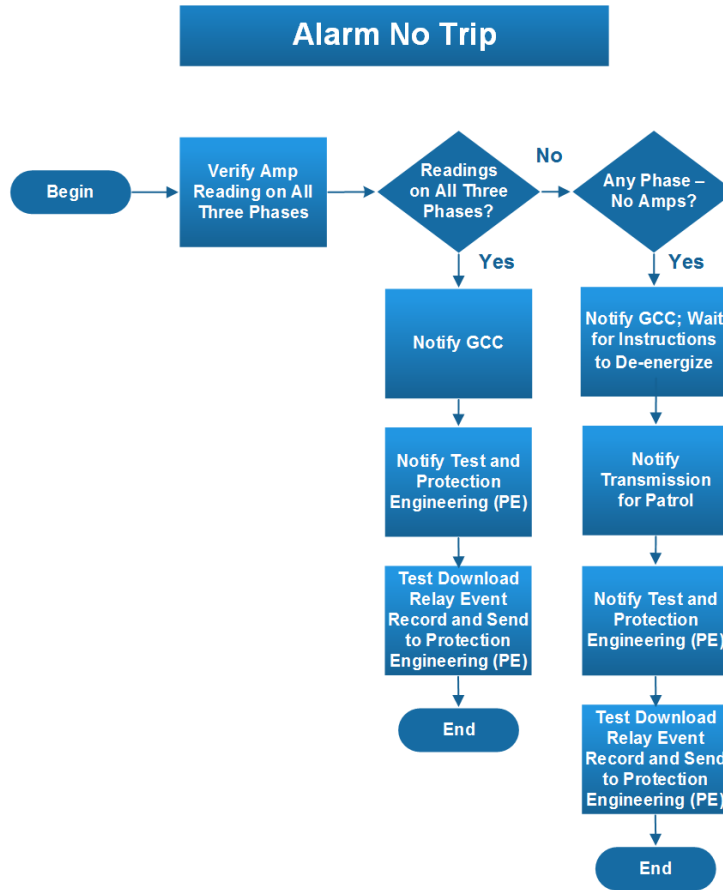

- *For intermittent systems (e.g., aerial imagery, line patrols), what triggers collection.* This should include flow charts and equations as appropriate: Not applicable. These are not intermittent systems despite having sampling intervals as the systems are continuously operating to detect conditions. DOPD provides continuous monitoring.
- *For calculated quantities, how raw measurements are converted to calculated quantities.* This should include flow charts and equations as appropriate: The DOPD scheme is continuously monitoring the Distribution line for changes in the magnitude and angle of the voltage to detect for an Open Phase condition.

DOPD utilizes the voltage (V) and current (I) transformation signals to identify an open phase(s) event on the primary portion of the distribution circuit. The scheme measures the primary voltage of a Potential Transformer (PT) by measuring the secondary of the PT and then multiplying by the PT ratio (PTR). The scheme measures the primary current of a CT by measuring the secondary of the CT and then multiplying by the CTR.

$$I_{Pri} = I_{Sec} * CTR$$

$$V_{Pri} = V_{Sec} * PTR$$

8.3.3.1.2.3 Protective Relay—High Impedance (Hi-Z) Relays

SCE’s traditional feeder protection elements are based on overcurrent, meaning the protection elements rely on fault magnitude to trigger the relay to operate. In a Hi-Z event, however, the fault magnitude is relatively small to non-existent. A Hi-Z scheme may detect incipient faults that are undetectable by the conventional overcurrent-based schemes. SCE is evaluating and validating Hi-Z efficiency in the field in detecting actual Hi-Z events.

- *Location of the system / locations measured by the system:* The Hi-Z scheme leverages existing assets (Distribution Recloser Controllers) that protect the Distribution lines residing in HFRA. The Hi-Z controllers are installed at recloser controller locations in HFRA to assess the effectiveness of detecting Hi-Z conditions. The locations were selected based on having voltage-sensors with minimum required current levels (i.e., ≥ 25 amps).
- *Integration with the broader electrical corporation’s system:* The Hi-Z scheme is integrated with the DMS system and is an additional layer of protection for incipient faults that is continuously monitoring the Distribution line for high impedance conditions.
- *How measurements from the system are verified:* The Hi-Z scheme is being deployed initially in “alarm mode” only during the pilot stage. Upon receiving a Hi-Z alarm, analysis of the any available relay oscillographs will be performed to determine operational effectiveness.
- *For intermittent systems (e.g., aerial imagery, line patrols), what triggers collection. This should include flow charts and equations as appropriate:* Not applicable. These are not intermittent systems despite having sampling intervals as the systems are continuously operating to detect conditions. The Hi-Z scheme is continuously monitoring the Distribution line for changes in circuit harmonics to detect Hi-Z conditions.
- *For calculated quantities, how raw measurements are converted to calculated quantities. This should include flow charts and equations as appropriate:* Once a Hi-Z condition is detected, records from the controller are collected to be analyzed to evaluate the schemes’ performance.

Hi-Z algorithm utilizes voltage (V) and currents (I) from the primary to arm the scheme when the loading is above 5% of the primary CTR to detect for Hi-Z conditions. The scheme measures the primary voltage of a PT by measuring the secondary of the PT and then multiplying by the PTR. The scheme measures the primary current of a CT by measuring the secondary of the CT and then multiplying by the CTR.

$$HiZ_{Arming} \geq 5\% * CTR_{Pri}$$

$$I_{Pri} = I_{Sec} * CTR$$

$$V_{Pri} = V_{Sec} * PTR$$

8.3.3.1.2.4 Protective Relays—Fast Curves

Fast Curves provide an additional layer of protection that detects faults and operates faster than traditional relay protection to deenergize the fault circuit or circuit section to reduce the fault energy and reduce ignition risk. For detailed information about Fast Curve Settings, please refer to Section 8.1.8.1.1. Information about the Remote Automatic Reclosures (RARs) (SH-5) and substation circuit breakers (CBs) (SH-6) on which Fast Curve settings are installed can be found in Section 8.1.2.8.2.

- *Location of the system / locations measured by the system:* Fast Curves leverage new or existing microprocessor relays on distribution lines at the station CB or RARs residing in HFRA.
- *Integration with the broader electrical corporation's system:* Fast Curve settings are integrated with RARs and substation CBs on the system (please refer to Sections 8.1.2.10 and 8.1.2.11 for more information). Fast Curve integrates with and utilizes both EMS and DMS for remote enablement and disablement of Fast Curve settings.
- *How measurements from the system are verified:* Fast Curve operation initiates an event record in the protective relay for analysis. Analyzing records after an event can identify which phases were faulted, the amount of fault current detected, and the possible location of the fault. The analysis is useful in identifying improper relay operations that can be remedied, by helping field crews verify the fault source and confirm correct protection equipment operation after a fault event.
- *For intermittent systems (e.g., aerial imagery, line patrols), what triggers collection. This should include flow charts and equations as appropriate:* Not applicable. These are not intermittent systems despite having sampling intervals as the systems are continuously operating to detect conditions.
- *For calculated quantities, how raw measurements are converted to calculated quantities. This should include flow charts and equations as appropriate:* When enabled during fire weather threats, Fast Curves continuously monitor the circuit or circuit section for sudden increases in line current indicating an electrical fault and take action to deenergize the station CB or RAR to reduce the fault energy.

Fast Curve equations: CB station and RAR relays

Phase Fast Curve Pickup: >2.3x existing phase min trip

Phase Delay: 4 cycles

Ground Fast Curve Pickup: >5x existing ground min trip

Ground Delay: 4 cycles

8.3.3.1.3 Fault Current Limiters—Rapid Earth Fault Current Limiters (REFCL)

REFCL devices can detect ground faults as small as a half ampere on one phase in a three-phase powerline and almost instantly reduce the voltage on the faulted line while boosting the voltage on the two remaining phases, to maintain service for customers while extinguishing arcs. SCE utilizes two different forms of REFCL technology: Ground Fault Neutralizer (GFN) and Grounding Conversions for small systems. Significant details on SCE's REFCL program can be found in the workpaper titled, "Rapid

Earth Fault Current Limiter (REFCL) Projects at Southern California Edison.”²³⁸

- *Location of the system / locations measured by the system:* The REFCL project covering the most circuit miles at SCE, Ground Fault Neutralizer (GFN), is installed in substations feeding circuits that go into HFRA. SCE is also performing other grounding conversion projects in 2023 through 2025 which monitor a smaller system, often a single circuit or even part of a distribution circuit.
- *Integration with the broader electrical corporation’s system:* REFCL is integrated with the distribution system. GFN is integrated with EMS and DFRs. The GFN is connected to the source transformer for the distribution circuits. Isolation Transformers can also be installed so only part of a distribution circuit is monitored by these devices.
- *How measurements from the system are verified:* A digital fault recorder measures line currents and voltages for a post-fault analysis.
- *For intermittent systems (e.g., aerial imagery, line patrols), what triggers collection. This should include flow charts and equations as appropriate:* Not applicable. These are not intermittent systems despite having sampling intervals as the systems are continuously operating to detect conditions. While operating modes continue to be developed, the expectation is the system will run constantly except when equipment reliability or activities such as single-phase switching require taking it temporarily out of service.
- *For calculated quantities, how raw measurements are converted to calculated quantities. This should include flow charts and equations as appropriate:* The controller for the GFN calculates many quantities. For a detailed description of the quantities calculated by REFCL systems see the workpaper titled, “Rapid Earth Fault Current Limiter (REFCL) Projects at Southern California Edison.”²³⁹

8.3.3.1.4 Smart Meters—e.g., Meter Alarm Down Energized Conductor (MADEC), Transformer Early Damage Detection

MADEC is a machine-learning (ML) algorithm utilizing smart meter data to detect a subset of energized wire-downs and other high impedance faults/hazards. MADEC generates an alarm that allows an operator to act quickly and de-energize the circuit.

Transformer Early Damage Detection (EDD) utilizes meter data and a custom algorithm to proactively identify one failure mode of distribution transformers. Identified transformers are replaced before possible failure to mitigate safety hazards for the public, prevent grid disruptions, and outages.

- *Location of the system / locations measured by the system:* MADEC and Transformer EDD are currently being used to actively monitor SCE’s service area, in locations where smart meters exist and adequate data can be collected. Each system resides on internal SCE hardware/software.
- *Integration with the broader electrical corporation’s system:* Each system uses existing collected smart data from our meter data management system and meter data warehouse. Smart meters

²³⁸ See “Rapid Earth Fault Current Limiter (REFCL) Projects at Southern California Edison” workpaper, available at <https://www.sce.com/safety/wild-fire-mitigation>.

²³⁹ *Ibid.*

are already integrated into the grid.

- *How measurements from the system are verified:* During algorithm design, historical meter data is analyzed and validated to be suitable for use cases. Additionally, various meter data are captured for further analysis as warranted.
- *For intermittent systems (e.g., aerial imagery, line patrols), what triggers collection. This should include flow charts and equations as appropriate:* MADEC (described in Figure SCE 8-48 below) runs automatically every minute on the available near real-time meter data, given all supporting infrastructure is available. Personnel at the Reliability Operations Center trigger the algorithm for Transformer EDD (described in Figure SCE 8-49 below) to review the preliminary results since manual post-processing of results is required before any trouble orders for field investigation or remediation can be created.

Figure SCE 8-48 - MADEC Flowchart

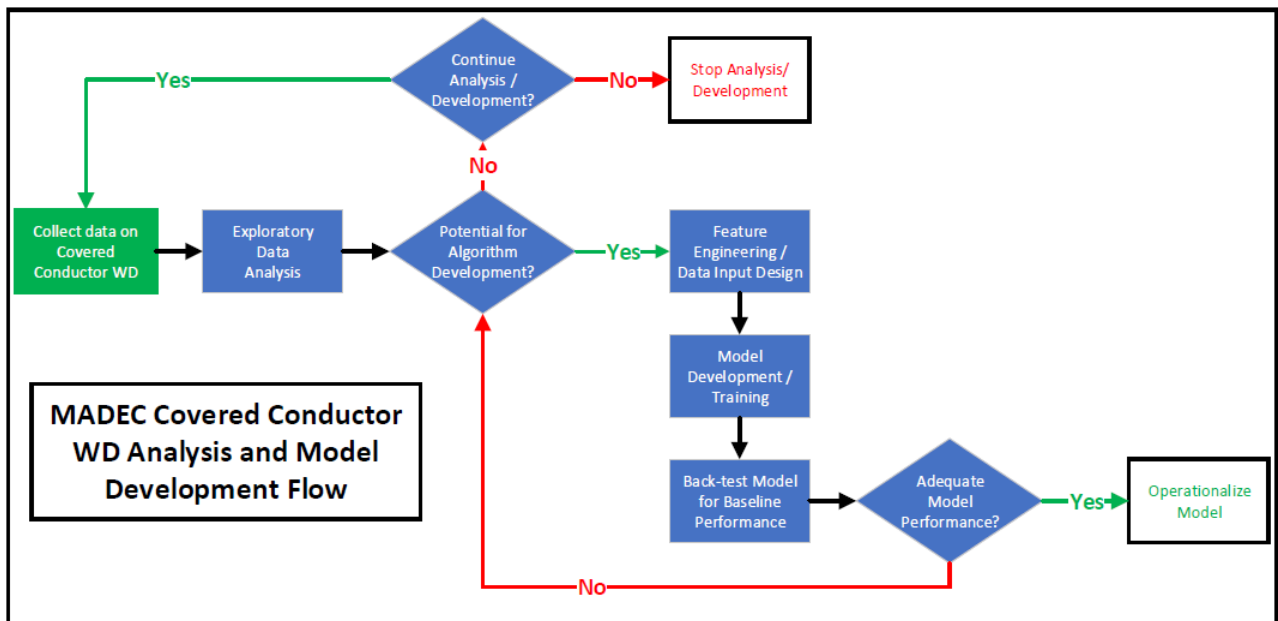
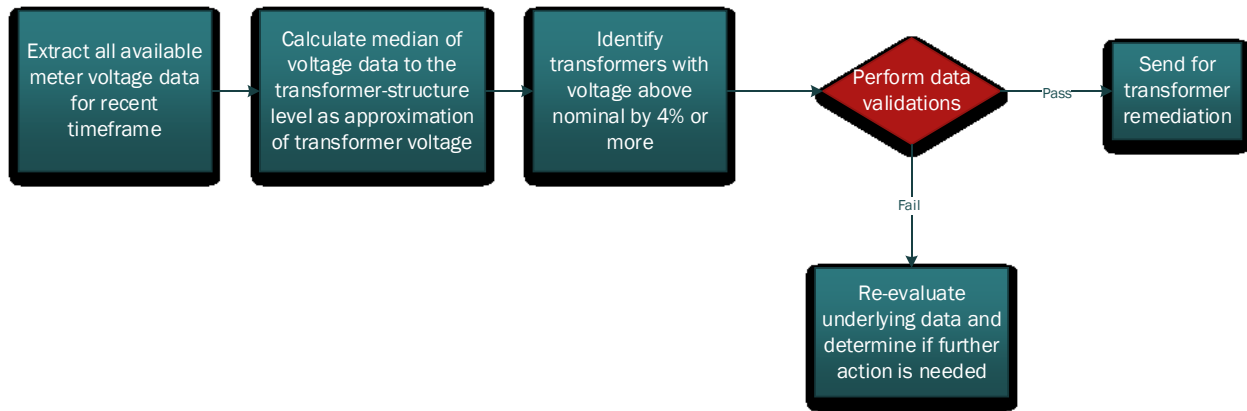

Figure SCE 8-49 - Transformer EDD Flowchart



- *For calculated quantities, how raw measurements are converted to calculated quantities. This should include flow charts and equations as appropriate:*

For MADEC, simple calculations and transformations are used to convert incoming raw data into binned values and ratios. While the calculations are not easily captured here as the ML model is constantly refining the algorithm used for detections, SCE provides the following information:

- MADEC uses internal grid connectivity data and voltage type exception information to create various downstream features for the model. Most of these features are used to create/calculate bins, ratios, and the timing/sequence of events and are typically aggregated to the structure or meter level.
- The model itself utilizes a standard Gradient Boosted Trees model. Model hyperparameters are based on a historic dataset.
- If a potential wire down situation is determined, the model output will identify a line with the circuit and nearby device or structures to help with locating the wire down. No output is generated if nothing is detected.

For Transformer EDD, raw meter voltage data—e.g., historic smart meter hourly voltage interval data and internal grid connectivity information—is used to calculate the list of transformer failures for remediation. The output is produced by identifying transformers with voltage (V) $\geq 4\%$ above nominal, which is calculated by taking the median voltage of smart meters per transformer-structure and then comparing the calculations between neighboring transformers to understand if the transformer could have damage.

$$V_{Transformer\ meter\ median} \geq 1.04\% * V_{Nominal}$$

8.3.3.1.5 Fault Recorders —e.g., Digital Fault Recorder

Digital Fault Recorders (DFRs) can be used to verify faulted phases, potential fault locations and correctness of relay operation after a faulted event, which helps with remediation of failed equipment (line or relay) to prevent reoccurrence of these events.

- *Location of the system / locations measured by the system:* DFRs are located on Transmission Substations in SCE’s territory across the Bulk Electric System (BES) to record faults on Transmission lines. DFRs are also being deployed at Distribution Substations, including those substations located in HFRA.
- *Integration with the broader electrical corporation’s system:* At the moment, DFRs are not integrated with the broader system. The data from the Distribution DFRs are automatically stored on the devices but needs to be retrieved from the devices manually since there are no commercial products currently available or a production grade system that has been implemented for automatically retrieving and aggregating the data in a central repository.
- *How measurements from the system are verified:* Data collected by the DFRs can be independently verified by other Intelligent Electronic Devices such as relays and meters.
- *For intermittent systems (e.g., aerial imagery, line patrols), what triggers collection. This should include flow charts and equations as appropriate:* DFRs are triggered whenever the voltage is 110% over or 10% under. Additionally, one ampere secondary residual current and external digital inputs are used to trigger fault recordings on the DFR at the BES.
- *For calculated quantities, how raw measurements are converted to calculated quantities. This should include flow charts and equations as appropriate:* The DFR provides the primary voltage of a Potential Transformer (PT) by measuring the secondary of the PT and then multiplying by the PT ratio.

$$V_{Pri} = V_{Sec} * P$$

The DFR provides the primary Current of a Current Transformer (CT) by measuring the secondary of the CT and then multiplying by the CT ratio.

$$I_{Pri} = I_{Sec} * CTR$$

8.3.3.2 Evaluation and Selection of New Systems

The electrical corporation must describe how it evaluates the need for additional grid operation monitoring systems. This description must include:

- *How the electrical corporation evaluates the impact of new systems on reducing risk (e.g., expected reduction in ignitions from failures, expected reduction in failures)*
- *How the electrical corporation evaluates the efficacy of new technologies*

These descriptions should include flow charts as appropriate.

How the electrical corporation evaluates the impact of new systems on reducing risk (e.g., expected reduction in ignitions from failures, expected reduction in failures)

Please refer to Section 8.3.2.2 for a general description of the process that SCE takes to evaluate new technologies for wildfire mitigation/prevention.

SCE's Fire Incident Preliminary Analysis (FIPA) processes investigate all ignitions and identify the drivers that may have caused the ignitions. An engineering evaluation is performed to understand whether there were mitigations in place to address the underlying cause of the risk event, and whether that mitigation performed as intended. SCE also identifies improvements to reduce the likelihood of recurrence, improve mitigation actions, and improve operational procedures and practices. This includes selecting and evaluating new grid monitoring technologies or systems based on an identified need and/or the mitigation's overall effectiveness at risk reduction. For instance, SCE may determine that a new system or mitigation is required when, upon review and analysis of ignition and fault data on the grid, it becomes apparent that one or more drivers of ignitions/faults cannot be adequately addressed using existing mitigations or a better mitigation may be available if proved to be effective.

SCE will also consider each new grid monitoring technology or a system's efficiency in reducing system risk. New systems (such as DOPD) are deployed in detection-only modes until the pilot program is determined to be successful at detecting the target issues on the grid. However, SCE evaluates the impact of new systems on reducing risk by first developing an estimate of the mitigation's effectiveness against various drivers of ignition risk, such as contact-from-object or equipment failure. Once the mitigation effectiveness percentage is identified, SCE will compare the overall risk for a specific area to the mitigation's effectiveness against that risk in locations where the mitigation is deployed. As discussed in Section 7.1.4.1, SCE also considers a host of other factors such as cost, resource availability, and overall feasibility when evaluating new grid monitoring systems. This step helps SCE to calculate how much risk could be reasonably reduced by the mitigation at that specific location when the mitigation is fully operational and can act to prevent a fault or ignition while successfully detecting issues on the grid.

How the electrical corporation evaluates the efficacy of new technologies.

SCE evaluates the efficacy of new technologies based on the historical ignition and fault data in conjunction with subject matter expert judgement. The specific process for evaluating the technology's efficacy at grid monitoring may vary depending on the technology. For example, the mitigation effectiveness percentages for REFCL are based on a combination of SCE testing and analysis conducted from 2019 to 2021, testing conducted in Australia, and SCE subject matter expert judgement. Other evaluations may involve using historical data, comparing geographies, or lab testing. Please refer to Section 8.3.2.2 for additional detail on the evaluation process.

8.3.3.3 Planned Improvements

The electrical corporation must describe its planned improvements in its grid operation monitoring systems. This must include any plans for the following:

- *Expansion of existing systems*
- *Establishment of new systems*

For each planned improvement, the electrical corporation must provide the following in Table 8-28:

- *Description: A description of the planned initiative activity*
- *Impact: Reference to and description of the impact of the initiative activity on each risk and risk component*
- *Prioritization: A description of the x% risk impact (see Section 8.1.1.2 for explanation)*
- *Schedule: A description of the planned schedule for implementation*

SCE describes in Table 8-28, below, its planned improvements to expand its grid operation monitoring capabilities through installations of: EFD sensors, relays capable of applying fast curve and Hi-Z settings, open phase detection schemes for Transmission and Distribution systems, and new DFRs.

Table 8-28 - Planning Improvements to Grid Operation Monitoring Systems

System	Description	Impact	x% Risk Impact	Implementation Schedule
Radio Frequency Monitors	Installation of EFD sensors in HFRA prioritized by risk analysis (SA-11).	EFD sensors are capable of detecting and locating degraded or defective assets that produce radio frequency emissions prior to failure, such as damaged conductor strands or insulator tracking. Early identification of these facilities and their replacement reduces ignition risk as the conditions further degrade.	Please see Table 8-23 for risk impact	Please see Table 8-23 in Section 8.3.1.2 for EFD's implementation schedule.

System	Description	Impact	x% Risk Impact	Implementation Schedule
Protective Relays - Fast Curves	Installation of microprocessor relays capable of applying fast trip settings to reduce fault energy.	Fast acting overcurrent protection used to detect faults on the grid and quickly deenergize circuits or circuit sections may reduce ignitions by reducing the amount of fault energy.	Please see Table 8-23 for risk impact	Please see Table 8-3 in Section 8.1.1.2 for the implementation schedule for circuit breaker relay units.
Protective Relays - Hi Z	Installation of recloser controllers capable of applying Hi-Z settings that detect high impedance conditions in HFRA.	Hi-Z settings detect high impedance conditions. Ignition risk can be reduced by detecting and isolating the high impedance conditions within HFRA.	N/A, evaluation still underway	Monitor the installations that are in-service in 2023 and 2024. Install Hi-Z at 20 new locations in 2025 and beyond, pending results of pilot analysis.
Protective Relays - TOPD (SH-8)	Installation and retrofit of open phase detection schemes on the Transmission system in HFRA.	TOPD scheme will detect an open phase (Broken Conductor) condition on its Transmission line, allowing for de-energization of the line before it contacts a grounded object and results in a fault.	Please see Table 8-23 for risk impact	Please see Table 8-3 in Section 8.1.1.2 for TOPD's implementation schedule.
Protective Relays - DOPD	Installation of open phase detection schemes on the Distribution	DOPD scheme will detect an open phase (Broken Conductor) condition on the distribution line, allowing for de-energization of the line before it contacts a	N/A, evaluation still underway	Monitor the installations that are in-service. Install DOPD at 12 locations in 2025 and beyond, pending

System	Description	Impact	x% Risk Impact	Implementation Schedule
	system in HFRA.	grounded object and results in a fault.		results of pilot analysis.
Fault Recorder	Installation of DFRs in SCE's territory across the Bulk Electric System (BES) and at Distribution Substations.	DFRs do not directly reduce wildfire risk. As a post-event analysis tool, DFRs are useful for performing root cause analysis on faulted events to help inform corrective action.	N/A	Install 20 DFRs per year in 2024 and 2025.
Fault Current Limiter	Installation of Ground Fault Neutralizers (GFN) (SH-17) in substations supplying HFRA circuitry and grounding conversions (SH-18) of small distribution systems.	Both GFN and grounding conversion designs target increases in ground fault sensitivity to 0.5 amperes and a 99.9% reduction in energy release from ground faults. This impacts wildfire drivers caused by ground faults, such as down wires, or phase-to-ground foreign object contact.	Please see Table 8-23 for risk impact	Please see Table 8-3 in Section 8.1.1.2 for REFCL's implementation schedule.

8.3.3.4 Evaluating Mitigation Initiatives

The electrical corporation must describe its procedures for the ongoing evaluation of the efficacy of its grid operation monitoring program.

SCE monitors the efficacy of its mitigations by performing engineering reviews of ignitions involving SCE facilities through the Fire Investigation Preliminary Analysis (FIPA) process. The FIPA process examines ignitions to determine:

- Cause
- Contributing Factors
- Involved Equipment
- Deployed Mitigation in the area

SCE routinely monitors the data derived from its FIPA process and other pieces of information, such as outages and wire downs, to ensure SCE's programs are performing as desired. If an engineer in the FIPA process notices an event where mitigations did not perform as expected, the engineer will escalate the issue and the team will discuss whether changes to SCE's standards or policies are needed to correct any issues. Additionally, SCE will periodically supplement its FIPA analysis by reviewing fault data, repair notification and wire downs to evaluate whether the grid monitoring mitigations are operating as intended. In addition, SCE will periodically review other fault data not captured in the FIPA process to evaluate whether the grid monitoring mitigations are operating as intended.

8.3.3.5 Enterprise System for Grid Monitoring

In this section, the electrical corporation must provide an overview of its enterprise system for grid monitoring. This overview must include discussion of:

- *Any database(s) used for storage*
- *Describe the electrical corporation's internal documentation of its database(s)*
- *Integration with systems in other lines of business*
- *Describe any QA/QC or auditing of its system*
- *Describe internal processes for updating the enterprise system including database(s)*
- *Any changes to the initiative since the last WMP submission and a brief explanation as to why those changes were made. Include any planned improvements or updates to the initiative and the timeline for implementation*

Several systems support the technologies described above. The supporting systems are listed below, and support the following technologies:

- PSPS-related situational awareness and decision-making: Supported by the Integrated PSPS Event Management System (iPEMS) and Centralized Data Platform (CDP).
- TOPD, DOPD, Hi-Z, REFCL, and Fast Curve Settings: Supported by the Protective Relay Database (Aspen) and the SCADA Historian.
- MADEC and Transformer EDD: Hosted on Splunk.

8.3.3.5.1 The Integrated PSPS Event Management System (iPEMS)

The iPEMS software application was created to efficiently manage Public Safety Power Shutoff (PSPS)

events by integrating electric grid and weather station information on a single platform for effective decision-making. iPEMS consolidates several legacy tools into a simplified cloud-based application by taking inputs from Weather Stations, other Grid Monitoring Systems, and Fire Risk Calculation sources to provide situational awareness for potential PSPS de-energizations and track decision-making for de-energizing and restoring circuits during PSPS events.

- *Any database(s) utilized for storage:* iPEMS uses NoSQL data (blobs and tables) spread out over seven storage accounts.
- *Describe the utilities internal documentation of its database(s):* iPEMS is hosted by an Azure cloud-based application. The documentation is contained within SCE Azure documentation and iPEMS Solution Architecture Document.
- *Integration with systems in other lines of business:* iPEMS integrates with CDP, Outage Management System (OMS), eDNA historian, Survey 123, SCE's Geographic Information Systems (GIS), Weather Services, and Fire Science Analytical Service.
- *Describe any QA/QC or auditing of its system:* iPEMS ingests data from other systems, which are subject to their own QC. For example, internal operational datasets in these other systems are validated and QC'd using built-in reasonability logic and user interface indications of potential data discrepancies. While there is no ongoing QA/QC of iPEMS after deployment, SCE conducts extensive user acceptance testing when new versions of iPEMS are deployed and makes developer support available during PSPS events to address any bugs that are identified.
- *Describe internal processes for updating enterprise system including database(s):* iPEMS utilizes Azure for its platform. Updates to the platform are performed by the vendor, and SCE validates functionality through user acceptance testing.
- *Any changes to the initiative since the last WMP submission and a brief explanation as to why those changes were made. Include any planned improvements or updates to the initiative and timeline for implementation:* Since the last WMP submission in 2022, SCE matured its iPEMS system capability to increase focus on supporting in-event PSPS decision-making. This means that PSPS pre-event considerations—such as the Risk Comparison Tool described in 2022 WMP under iPEMS²⁴⁰—are now managed under the CDP instead of iPEMS.²⁴¹ While the CDP supports all three phases of a PSPS event, the CDP system is primarily used now to provide support for PSPS pre-event and post-event data processing and analyses.

The types of iPEMS and CDP system support for each of three phases of a PSPS event are described in Figure SCE 8-50, below. During the Pre-Event phase, the CDP system stores and processes information that will help identify the specific circuits (Monitored Circuit List, or MCL) and potential timeframe (Period of Concern, or POC) in scope for potential de-energization and prepare pre-event PSPS notifications, as applicable. During the In-Event phase, iPEMS utilizes real-time grid and weather station monitoring and other situational awareness tools to inform PSPS decision-making about whether or not

²⁴⁰ See Section 8.1.1 of SCE's 2022 Wildfire Mitigation Plan Update, p. 521.

²⁴¹ See the section following (8.3.3.5.2) for a detailed description of the CDP.

to de-energize or re-energize circuits on the MCL during the POC timeframes. iPEMS also provides the threshold information necessary to trigger any in-event notifications. Meanwhile, the CDP system documents any changes to the MCL or the POC due to weather model forecasts and builds notification campaigns to execute in-event notifications, as needed. In the Post-Event phase, CDP is used to perform data quality control and generate post-event reports. Information about PSPS decision-making, that are stored in iPEMS, is shared with CDP and is used to contribute to event reports and analyses.

Figure SCE 8-50 - Systems Support for PPS Events

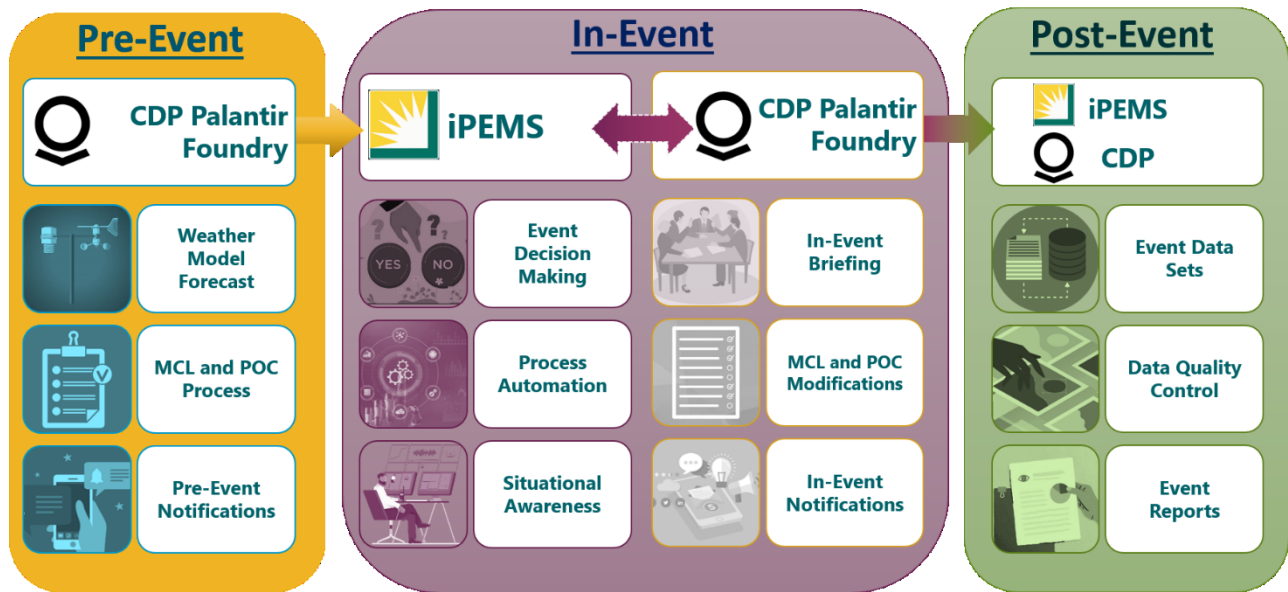

To improve the efficiency and performance of PPS data systems, SCE plans to improve the collection frequency of weather station reads, integrate Smart Meter data sets, and enhance the ability to integrate with future grid operational systems. SCE also plans to reduce system processing time through automation, including time for processing PPS notification campaigns, and to work towards integration of its CDP and iPEMS systems, where feasible. The specific timeline and details around these improvements are noted below:

- In 2023, SCE will work to improve the sampling frequency of SCE weather stations in the iPEMS application for enhanced situational awareness by piloting technology that can help reduce the data retrieval times from once every ten minutes to once every thirty seconds as observed winds speeds near PPS thresholds for de-energization.
- In 2023, SCE will work to automate several PPS operational processes within CDP and iPEMS, including processes that initiate customer notifications and restoration activities.
- In 2024 and 2025, SCE plans to enhance iPEMS' ability to integrate Smart Meter data (e.g., Advanced Metering Infrastructure [AMI]) for enhanced situational awareness. Whereas SCE currently relies on its list of de-energized and re-energized circuits to understand customer impacts from a PPS event, the smart meter information collected improves SCE's understanding of the exact times that customers experienced a PPS de-energization and validate when restoration has occurred.
- In 2024 and 2025, SCE will work to enhance iPEMS' ability to integrate with new grid operational systems (e.g., Advanced Distribution Management System [ADMS], GMS, PI Historian, etc.) that are being introduced.
- SCE will continue to investigate potential integration opportunities between iPEMS and CDP to increase efficiencies between the systems, where feasible.

8.3.3.5.2 Consolidated Data Platform (CDP)

The CDP organizes data about PSPS functionality such as pre- and in-event notifications, data centralization, data management (e.g., modeling, semantics, clean-up, and validation), event analytics and reporting and process automation (e.g., elimination of manual hand-offs between different software programs by replacing those programs with one data platform).

- *Any database(s) utilized for storage:* The CDP's PSPS Data is stored on the Palantir Foundry Product on the Amazon Web Services (AWS) Platform.
- *Describe the utilities internal documentation of its database(s):* The data ontology and data objects are built into the Foundry Platform. The application solution design and all other database design aspects are documented in the Solution Architecture Document.
- *Integration with systems in other lines of business:* PSPS CDP integrates with iPEMS, OMS, Weather Forecasting, Message Broadcast, Everbridge, Operational GIS Data Store (ODS), and SAP High Performance Analytic Appliance (HANA).
- *Describe any QA/QC or auditing of its system:* QA is performed during product updates, as described in the next response below.
- *Describe internal processes for updating enterprise system including database(s):* SCE is utilizing the Palantir Foundry platform as the core technology components for PSPS CDP. The vendor is responsible for updating the product (including databases) on a regular basis. When these updates are available, SCE validates the functionality end to end with regression and user acceptance testing to ensure everything works as expected. Any bugs found are communicated back to the vendor to be fixed and retested. Once the testing is completed and passed, the new functionality is migrated to our production environment.
- *Any changes to the initiative since the last WMP submission and a brief explanation as the why those changes were made. Include any planned improvements or updates to the initiative and timeline for implementation:* Please see response to this prompt in the section above, 8.3.3.5.1, for a description of updates to the CDP since the last WMP.

8.3.3.5.3 SCADA Historian

SCE uses eDNA and OSI PI as historians for its Grid Monitoring Systems. These historians capture analog values for grid parameters including voltage, current, and power flow, as well as device status changes (e.g., Circuit Breaker Open/Close, relay actuation).

- *Any database(s) utilized for storage:* SCE uses both the eDNA and PI System for historization of power system data, which is maintained at full fidelity in real time. Since the eDNA product has an upcoming end of life of 2026, SCE is moving to the PI System for all SCADA data.
- *Describe the utilities internal documentation of its database(s):* The systems are documented in accordance with standard IT governance for support, approval of change, and end user access.
- *Integration with systems in other lines of business:* The eDNA and PI historians capture data from SCE's SCADA systems (i.e., EMS and DMS and non-SCADA transformer data for Dissolved Gas Analysis). The current system is integrated with an enterprise analytics platform. The PI System has an integrated analytics platform.

- *Describe any QA/QC or auditing of its system:* The PI and eDNA Systems were tested in accordance with SCE's IT governance prior to being placed into production and is monitored on a daily basis with a variety of monitoring tools, including applications monitoring data flow from various collection points to the historian servers, Windows Performance counters for data center machines, and dedicated dashboards to monitor system health. This is in addition to standard SCE tools monitoring basic server health.
- *Describe internal processes for updating enterprise system including database(s):* Historian applications are updated and/or enhanced in response to SCE's technical and business needs. OSI PI replaced eDNA as the historian for the SCE Distribution System outside the Substations in 2022 and will become the historian system for all Distribution voltages inside and outside the substations upon deployment of the Grid Management System (GMS) in 2024.
- *Any changes to the initiative since the last WMP submission and a brief explanation as the why those changes were made. Include any planned improvements or updates to the initiative and timeline for implementation:* Not applicable, as this is a new section for the WMP.

8.3.3.5.4 Protective Relay Database (Aspen)

Aspen is an application used to store relay information.

- *Any database(s) utilized for storage:* Aspen uses an Oracle database to store information about a relay's name, ID, type, setting, link and activity.
- *Describe the utilities internal documentation of its database(s):* The systems are documented in accordance with standard IT governance for support, approval of change and end user access.
- *Integration with systems in other lines of business:* Aspen has interfaces with Doble, Master Data Governance (MDG), and SAP.
- *Describe any QA/QC or auditing of its system:* As Aspen is classified as a NERC CIP application; changes are tested by end users prior to being placed in production.
- *Describe internal processes for updating enterprise system including database(s):* Aspen is not updated unless required by a business need.
- *Any changes to the initiative since the last WMP submission and a brief explanation as the why those changes were made. Include any planned improvements or updates to the initiative and timeline for implementation:* Not applicable, as this is a new section for the WMP.

8.3.3.5.5 Splunk

The MADEC and Transformer EDD applications run in Splunk.

- *Any database(s) utilized for storage:* Splunk stores data in a proprietary storage system called “index,” based upon flat files.
- *Describe the utilities internal documentation of its database(s):* SCE does not have internal documentation. Splunk documentation is available online from the vendor.
- *Integration with systems in other lines of business:* Splunk uses feeds from the smart meter exception data to send email/text alerts or uses scripts to route meter data to other systems, e.g., sending a MADEC to EMS alert.
- *Describe any QA/QC or auditing of its system:* Data is not generated in Splunk. Data is ingested from various sources with source QCs.
- *Describe internal processes for updating enterprise system including database(s):* Splunk is upgraded regularly by the Splunk team based upon new vendor releases offering functionality improvements or based upon security fixes.
- *Any changes to the initiative since the last WMP submission and a brief explanation as the why those changes were made. Include any planned improvements or updates to the initiative and timeline for implementation.* Not applicable, as this is a new WMP section in 2022.

8.3.3.5.6 Early Fault Detection (EFD) Data Storage

Data from EFD (SA-11) are stored and managed in a data storage system.

- *Any database(s) utilized for storage:* SCE uses a cloud-based data storage system used for EFD data collection, analysis, and storage. Each EFD installation reports discharge activity that is detected and incorporated by the vendor into proprietary algorithms. SCE then accesses the data via an online user interface which turns the detection data into the information that can be assessed for potential system degradation or defects. When defects or degradation is detected by EFD, SCE follows present processes for creating repair notifications in existing repair databases that are tracked in SAP.
- *Describe the utilities internal documentation of its database(s):* Documentation is maintained by the vendor for the database. SCE user documentation of the system has not been formalized although with broader EFD deployment additional documentation will be needed around use of the new web portal system anticipated in 2024.
- *Integration with systems in other lines of business:* This is a standalone system with no integration to other SCE systems. Future capabilities may include integration with SCE’s GIS. EFD equipment itself must also be inspected and includes maintenance of the equipment such as battery replacement. The EFD hardware is being incorporated into SCE’s maintenance plans in SAP.
- *Describe any QA/QC or auditing of its system:* SCE regularly reviews the EFD database to confirm its accuracy and may identify system improvements. One recent improvement in the QC process is related to phasing of the conductors for the sensor installations. The initial EFD hardware did

not have the data capabilities to check the accuracy of phasing. Although SCE has not observed any phasing issues to date (as of December 2022), to remedy this concern and others, the present hardware now includes the capability to check the accuracy of phasing connection for each EFD sensor. Should a problem be identified, it is then reported to SCE, and can either be remedied in software changes or physically in the field with sensor placement.

- *Describe internal processes for updating enterprise system including database(s):* EFD data storage is presently a standalone application that will only be updated in response to EFD needs. When new EFD devices are installed, SCE’s vendor, who hosts the EFD database, will identify an EFD unit as online when the device connects to a cellular network and transmits the device’s activation and location information. SCE will then perform an end point test on the device in order to log the device as complete in the system. This process ensures that the device is included in the data system and algorithm for monitoring.
- *Any changes to the initiative since the last WMP submission and a brief explanation as to why those changes were made. Include any planned improvements or updates to the initiative and timeline for implementation:* Not applicable, as this is a new section for the WMP.

8.3.4 Ignition Detection Systems

The electrical corporation must describe its systems, technologies, and procedures used to detect ignitions within its service territory and gauge their size and growth rates.

- *The electrical corporation must document the following:*
- *Existing ignition detection sensors and systems*
- *Evaluation and selection of new ignition detection systems*
- *Planned integration of new ignition detection technologies*
- *Monitoring of mitigation improvements*

Reference the Utility Initiative Tracking ID where appropriate.

8.3.4.1 Existing Ignition Detection Sensors and Systems

The electrical corporation must report on the sensors and systems, technologies, and procedures for ignition detection that are currently in use, highlighting any improvements made since the last WMP submission. At a minimum, the electrical corporation must document the deployment of each of the following:

- *Early fire detection including, for example:*
 - *Satellite infrared imagery*
 - *High-definition video*
 - *Infrared cameras*
- *Fire growth potential software*

The electrical corporation must summarize each system in Table 8-29 below. It must provide the following additional information for each system in an accompanying narrative:

- General location of detection sensors (e.g., HFTD or entire service territory)
- Resiliency of sensor communication pathways
- Integration of sensor data into machine learning or AI software
- Role of sensor data in risk response
- False positives filtering
- Time between detection and confirmation
- Security measures for network-based sensors

While SCE is not a fire suppression agency, it does maintain various technologies and systems that can help confirm ignition and gauge their size and/or growth rates. These tools help to monitor and evaluate weather and climate conditions for the purpose of understanding ignition potential and consequence, which informs a range of short-and long-term mitigations such as PSPS, inspections, and grid hardening. As such, SCE summarizes each of its applicable systems in the table below.

Table 8-29 - Fire Detection Systems Currently Deployed

Detection System	Capabilities	Companion Technologies	Contribution to Fire Detection and Confirmation
HD Cameras (SA-10)	Real-time viewing of remote areas to confirm smoke and wildfires	Used with Artificial Intelligence satellite imagery for fire confirmation	SCE partners with University of California, San Diego (UCSD) to install HD cameras on non-SCE infrastructure, such as a communications towers, in locations where its Fire Science Team, Fire Management Team, IMT and fire agencies have previously identified gaps in the spatial data related to fire detection.
Satellite & Other Imaging Technology (SA-10)	Resolve gaps in SCE’s spatial data and provide improved fire confirmation capabilities.	Used with HD Cameras for fire confirmation	Satellite & Other Imaging fire confirmation will be used with the current fire confirmation capabilities provided by UCSD. The Satellite detection will provide full coverage of the SCE territory and work as tool to

Detection System	Capabilities	Companion Technologies	Contribution to Fire Detection and Confirmation
			help confirm fires on the HD camera system.
Fire Spread Modeling (SA-8)	SCE plans to use advanced fire spread modeling tools—Technosylva’s FireCast and FireSim applications—to predict fire spread and consequence outputs such as fire perimeter size, structures impacted, populations affected, and injury and death	N/A	Ability to estimate the impacts that fire activity will have on a particular area (i.e., wildfire consequences).

Additional information for each of its system is detailed below.

8.3.4.1.1 HD Cameras (SA-10)

HD camera installations address areas for improvement in SCE’s spatial data and provides improved fire confirmation capabilities. To support situational awareness with respect to fuel conditions, help inform PSPS decision-making, and have the ability to confirm smoke and/or fire in a location via an Artificial Intelligence pilot, SCE maintains a network of 182 HD cameras installed through University of California, San Diego’s (UCSD’s) AlertCalifornia (formerly AlertWildfire) system. The live data feeds aide in faster information gathering for fire location and possible direction of growth. This information is imperative for SCE asset protection as well as for fire departments to assess resource deployment.

SCE has observed areas for improvement in its ability to view certain parts of its service area, including locations where SCE infrastructure cannot currently be seen, and in communities that intersect mountainous terrain. Left unaddressed, these blind spots could compromise SCE’s ability to provide adequate and timely response for asset protection from fires and to help supplement fire response efforts and coordinate with fire response agencies. SCE’s 2023-2024 HD camera installations will help improve SCE’s spatial data and provide improved fire confirmation capabilities.

Highlight any improvements made since the last WMP submission

SCE has installed 16 additional cameras in 2022, to address areas for improvement described above. In partnership with UCSD, SCE continues to pilot artificial intelligence (AI) that utilizes the cameras data feeds to alert a specific camera location so personnel can better assess real-time conditions of a fire (i.e., location, growth potential, nearby SCE assets, possible communities in danger, fire department

resource deployment). The primary goal of the AI is for fire fighting agencies to subscribe to alerts in their respective areas for greater situational awareness in fighting fires. An ancillary benefit for utilities as the camera sponsors, are to be informed of confirmed fires in or around SCE infrastructure to assist with asset protection.

General location of detection sensors (e.g., HFTD or entire service territory)

SCE partners with UCSD to install HD cameras in locations where its Fire Science Team, Fire Management Team, IMT and/or fire agencies provide insight for rural areas needing viewshed to assist in confirming the start of a fire. UCSD installs on towers of opportunity in these remote locations, such as shared communication towers or county owned communication towers. Cameras are not installed on SCE-owned infrastructure. The number and location of future installations will be based on requests by SCE's fire science, fire management, IMT teams or by fire agencies. To fulfill these requests, SCE is forecasting to install at least 10 and up to 20 HD cameras per year through 2024, based on need.

Resiliency of sensor communication pathways

The HD Camera communication pathways are provided through UCSD. UCSD secures network connections through wireless internet service providers which are available at the location of installation. Not every camera is on the same communication path network. UCSD monitors the connectivity and is responsible for connectivity maintenance and any necessary break fix. UCSD allows SCE access to the HD camera status page in order to view the connectivity status.

Integration of sensor data into machine learning or AI software

SCE has partnered with UCSD to allow access to SCE cameras for AI software development. SCE is currently receiving alerts from a pilot UCSD is conducting with an AI software company. SCE provides feedback on alerts to better train and grow the AI software.

Role of sensor data in risk response

HD Cameras are not sensors, per se, however the live feeds that are provided from the cameras provide direct indication for wildfire conditions and ignition propagation. These confirmation capabilities can be enhanced through the use of AI to send alerts to fire agencies to inform of early-stage ignitions. The confirmation capabilities and AI alerts provide situational awareness to better inform decision making post ignition.

False positives filtering

Upon receiving notifications, SCE personnel view for situational awareness and decide if an alert needs to be investigated or any further actions taken. Amongst the alerts, false positives are seen where further action is not needed and the alert is dismissed.

Time between detection and confirmation

Artificial Intelligence (AI) is used primarily to confirm the existence of a fire. SCE does not use the AI to detect fire starts therefore SCE does not track time stamping of the alert notifications. The AI will alert of a potential fire or a confirmed fire.

Security measures for network-based sensors

SCE relies on the vendor UCSD to keep the data feeds secure. SCE accesses the cameras through the

vendor provided website, <https://AlertCA.live> which is available to the public.

8.3.4.1.2 Satellite & Other Imaging Technology (SA-10)

Satellite and other imaging technology can be used to help determine the point of ignition origin and perform threat assessments, among other information that can be derived from having an overhead or aerial view of the fires. SCE uses this technology to confirm and follow changes in fire locations and the spread of a fire. SCE will communicate that information with stakeholders and SCE resources impacted by the area of threat. This technology will allow SCE to reduce the impact of wildfire, though quantifying the reduction will be difficult to ascertain.

Highlight any improvements made since the last WMP submission

SCE created a map on its website for customer to view fire detection from public satellites along with fire perimeters from local fire agencies, which includes weather station observation from the National Weather Service.²⁴² This SCE website provides customers and other stakeholders with increased situational awareness.

General location of detection sensors (e.g., HFTD or entire service territory). The technology produces an output that covers the entire SCE service area.

Resiliency of sensor communication pathways

Communication pathways are control by NOAA and NASA since this is a government owned satellite system.

Integration of sensor data into machine learning or AI software

Satellite fire confirmation capabilities will be integrated in the current fire conformation technology being used by SCE that UCSD is providing. This service will add additional notification and confirmation abilities.

Role of sensor data in risk response

Sensor provides increased coverage for wildfire detection within the SCE service territory. This increases the ability to reduce risk by increasing fire conformation coverage capabilities across the SCE territory.

False positives filtering

False positives are filtered out by the algorithm that will provide the alert of a possible wildfire. False positives will still occur as this is a new technology being used within SCE. The AI software for the HD cameras will be used for fire conformation.

Time between detection and confirmation

Satellite & Other Imaging will be used primarily to confirm or track the existence of a fire by SCE or local fire agencies. SCE will not use the Satellite & Other Imaging to detect fires therefore SCE will not track detection and confirmation. Fire Confirmation will depend on the geographic location of the detection and view shed of any existing alert wildfire camera to confirm this detection. Some detections will not

²⁴² See <https://www.sce.com/wildfire/situational-awareness>

be within the view of the cameras and will need to be confirmed by local fire agencies.

Security measures for network-based sensors

Sensors from the satellite detection is operated and managed by the United States' National Oceanic and Atmospheric Administration (NOAA)'s National Environmental Satellite, Data, and Information Service division. No sensor will be placed within the SCE network, system or assets.

8.3.4.1.3 Fire Spread Modeling (SA-8)

SCE plans to use advanced fire spread modeling tools—Technosylva’s FireCast and FireSim applications—to simulate fire ignitions and subsequent consequences such as fire perimeter size, structures impacted, populations affected, and potential fatalities. SCE’s Fire Science team will continue to evaluate the output to help ensure that FireCast and FireSim are suitable tools for accurately estimating fire consequences.

In 2022, Technosylva began estimating the number of buildings destroyed as one of its metrics. In addition, they created a metric that evaluates response complexity as a proxy to address wildfire suppression. In 2023, SCE will work with Technosylva to build upon these newly created metrics to more accurately reflect the number of buildings destroyed by wildfire and the ability to predict resource response. This will include an analytical study detailing circuits having met consequence criteria which will enable the Fire Science team to more adequately address any potential inaccuracies in the output.

Highlights since last WMP submission

In 2022 and under the direction of SCE, Technosylva developed the Buildings Destroyed metric and the Response Complexity Metric to address known deficiencies in the fire spread modeling consequence processes. In addition, Fire Sciences evaluated the performance of the deliverables from Technosylva which included the Building Loss Factor Metric, the Response Complexity Metric (previously referred to as Suppression Effectiveness), the Extended Attack Index, the Custom Fuels Atlas, and the WRRM Historical Percent Daily Forecast Integration. Specifically, the Building Loss Factor and the Response Complexity metrics were reviewed in the Fall of 2022 to determine their ability to properly inform PSPS decision-making. Although the addition of the two metrics in 2022 further improves fire spread modeling, more analysis and refinement to the metrics from 2023 through 2024 will be needed before anticipated integration into PSPS decision-making by the end of 2025.

General location of detection sensors (e.g., HFTD or entire service territory)

The Technosylva output covers SCE’s HFRA plus a 20-mile buffer.

Resiliency of sensor communication pathways

N/A – This technology does not use sensors.

Integration of sensor data into machine learning or AI software

N/A – This technology does not use sensors.

Role of sensor data in risk response

N/A – This technology does not use sensors.

False positives filtering

N/A – This technology does not use sensors.

Time between detection and confirmation

N/A – This technology does not detect ignitions.

Security measures for network-based sensors

N/A – This technology does not use sensors.

8.3.4.2 Evaluation and Selection of New Detection Systems

The electrical corporation must describe how it evaluates the need for additional ignition detection technologies. This description must include:

- *How the electrical corporation evaluates the impact on new detection technologies on reducing and improving detection and response times*
- *How the electrical corporation evaluates the efficacy of new technologies*
- *The electrical corporation's budgeting process for new detection system purchases*

SCE consults with external agencies, such as fire agencies, to determine additional fire confirmation technology needs. As discussed in Section 8.3.4.1, SCE partners with other entities for its fire confirmation systems and capabilities, such as UCSD's Alert California system and NOAA and NASA's satellite system. Any needs identified by SCE or fire agencies are reviewed and approved collaboratively.

How the electrical corporation evaluates the impact on new detection technologies on reducing and improving detection and response times.

SCE evaluates the impact of new ignition confirmation technologies by first proving out the use case for the technology with small case studies or limited deployment of the system or technology. SCE then assesses the new technology or system to see if there are quantifiable impacts on its or fire agencies' abilities to confirm ignitions. SCE notes that it is not a fire suppression agency and therefore focuses efforts on methods to support customer safety, grid resiliency, and the ability for fire suppression agencies to respond to wildfires.

How the electrical corporation evaluates the efficacy of new technologies

SCE evaluates the efficacy of new ignition confirmation technology by, as described above, assessing if it is useful for fire mitigation efforts and to inform analyses of the service territory, fire risk, and provide situational awareness, in addition to operational decision making, including but not limited to PSPS. In addition to the assessment described above, SCE also consults with fire agencies for their own assessments of the efficacy of new technologies.

The electrical corporation's budgeting process for new detection system purchases

As indicated above, SCE partners with external agencies to determine additional ignition confirmation needs. Once a need is identified and confirmed, SCE's share of the cost is reviewed and approved by SCE's internal approval process, which includes review by a variety of stakeholders, such as SCE's wildfire strategy and enterprise risk management groups, in addition to senior management.

8.3.4.3 Planned Integration of New Ignition Detection Technologies

The electrical corporation must provide an implementation schedule for new ignition detection and alarm system technologies. This must include any plans for the following:

- *Integration of new systems into existing physical infrastructure*
- *Integration of new systems into existing data analysis*
- *Increases in budgets and staffing to support new systems*

For each new technology system, the electrical corporation must provide the following in Table 8-30:

- **Description:** *A description of the technology's capabilities*
- **Impact:** *A description of the impact the technology will have on each risk and risk component*
- **Prioritization:** *A description of the x% risk impact (see Section 8.1.1.2 for explanation)*
- **Schedule:** *A description of the planned schedule for implementation*

Please see the table below for SCE's implementation schedule for new ignition confirmation system technologies.

Table 8-30 - SCE's Planning Improvements to Fire Detection and Alarm Systems

System	Description	Impact	x% Risk Impact	Implementation Schedule
HD Cameras and Satellite & Other Imaging (SA-10)	SCE plans to support UCSD's planned integration of satellite & other imaging technology into the Alert CA HD camera network	An integrated system of HD Cameras and Satellite & Other Imaging technology will enhance SCE's situational awareness by providing additional fire confirmation abilities	Please See Table 8-23 for risk impact information	End of 2025

8.3.4.4 Evaluating Mitigation Initiatives

The electrical corporation must describe its procedures for the ongoing evaluation of the efficacy of its fire detection systems.

SCE's procedures for the ongoing evaluation of the efficacy of its ignition confirmation technologies include reviewing how HD cameras and Satellite & Other Imaging technology are used and that its fire spread modeling provides essential information to aid in SCE's decision-making process. SCE evaluates the efficacy of HD cameras and Satellite & Other Imaging based on the amount of usage of the SCE networks, feedback from the SCE Fire Management Team, and feedback from firefighting agencies. SCE's ignition confirmation systems and processes are useful for fire mitigation efforts and to inform assessments of the service territory, fire risk, and provide situational awareness, in addition to operational decision making, including but not limited to PSPS.

The HD Cameras and Satellite & Other Imaging technology are viewed on a near daily basis by SCE Fire Science and SCE Fire Management Officers. Fire Agencies also routinely use the cameras and have provided positive feedback to SCE's Fire Management Officers and UCSD. Efficacy can also be determined by the expansion of the Alert California system. The camera network has undergone user interface improvements and other agencies, including the US Forest Service and CalFire, continue to install cameras across California, in addition to SCE. The growth of the camera network platform and Satellite & Other Imaging technology helps to validate the efficacy of these technologies and confirm they are fulfilling their intended purpose.

SCE's ignition confirmation systems provide essential information to aid in fire mitigation efforts, but do not directly influence wildfire risk drivers. For example, HD Cameras have proven useful in fire mitigation efforts by providing live views of fires for fire management officers to use for situational awareness. SCE fire management officers heavily rely on the HD cameras and are one of the most frequent users of the network. SCE fire management officers are able to view the proximity of a fire to SCE infrastructure and help direct asset protection efforts. Fire departments also utilize the HD Cameras to be able to help identify smoke, fire location, size of fire, direction of fire, direct response efforts, possible growth potential etc.

SCE measures the efficacy of its fire spread model by its application and use for decision marking. First, fire spread modeling is used extensively alongside historical data to help identify areas that have the greatest wildfire risk. This information is used to help prioritize various mitigation activities such as installing covered conductor, undergrounding, etc. Second, fire-spread modeling is used in real-time ahead of a PSPS event to populate SCE's In-Event Risk Calculator. This allows SCE to determine the risk associated with a wildfire occurring versus the risk associated with de-energization. Third, projections of fire size potential in real-time are used to help brief external partners during PSPS events. This information becomes very useful for explaining why certain areas are being considered for potential de-energization. Lastly, fire spread modeling is used in real-time to model new and on-going wildfire incidents. This helps SCE understand how the fire will spread and how its assets may be impacted and when.

8.3.4.5 Enterprise System for Ignition Detection

In this section, the electrical corporation must provide an overview of its enterprise system for ignition detection. This overview must include discussion of:

- *Any database(s) used for storage.*
- *Describe the electrical corporation's internal documentation of its database(s).*
- *Integration with systems in other lines of business.*
- *Describe any QA/QC or auditing of its system.*
- *Describe internal processes for updating the enterprise system including database(s).*
- *Any changes to the initiative since the last WMP submission and a brief explanation as to why those changes were made. Include any planned improvements or updates to the initiative and the timeline for implementation.*

SCE does not use any enterprise systems for ignition detection or confirmation. As discussed in Section 8.3.4.1, SCE partners with UCSD for its camera database systems. SCE uses Technosylva servers and databases for its fire spread modeling. SCE does not store its fire spread models.

There are no changes to SCE's approach of using third party vendor for its databases for its ignition confirmation systems since SCE's last WMP submission. SCE does not have plans for changes to this approach in the future.

8.3.5 Weather Forecasting

The electrical corporation must describe its systems and procedures used to forecast weather within its service territory. These forecasts should inform the electrical corporation's near-real-time-risk assessment and PSPS decision-making processes. The electrical corporation must document the following:

- *Its existing modeling approach*
- *The known limitations of its existing approach*
- *Implementation schedule for any planned changes to the system*
- *How the efficacy of systems for reducing risk are monitored Reference the Utility Initiative Tracking ID where appropriate.*

8.3.5.1 Existing Modeling Approach

At a minimum, the electrical corporation must discuss the following components of weather forecasting:

- **Data assimilation** *from environmental monitoring systems within the electrical corporation service territory*
- **Ensemble forecasting** *with control forecast and perturbations*
- **Model inputs** *including, for example:*
 - *Land cover / land use type*

- *Local topography*
- **Model outputs** including, for example:
 - *Air temperature*
 - *Barometric pressure*
 - *Relative humidity*
 - *Wind velocity (speed and direction)*
 - *Solar radiation*
 - *Rainfall duration and amount*
- **Separate modules** (e.g., local weather analysis and local vegetation analysis)
 - *Subject matter expert (SME) assessment of forecasts*
 - *Spatial granularity of forecasts including:*
 - *Horizontal resolution*
 - *Vertical resolution*
- **Time horizon** of the weather forecast throughout the service territory

The electrical corporation must highlight improvements made to the electrical corporation's weather forecasting since the last WMP submission.

The electrical corporation must also provide documentation of its modeling approach pertaining to its weather forecasting system in accordance with the requirements in Appendix B.

Data assimilation

SCE uses new weather forecast information from either in-house model systems or public weather data from vendors at a frequency of up to every hour. SCE's in-house models are generated by downscaling initial conditions provided by various government agencies described in 8.3.5.2 twice per day. Additionally, during high-impact events, meteorologists consult rapidly-updating forecasts from the High Resolution Rapid Refresh (HRRR) model that is generated every hour by the National Centers for Environmental Prediction (NCEP). SCE weather station observations are also shared into the Meteorological Assimilation Data Ingest (MADIS) system used by the National Weather Service to integrate observations into their models that are received by SCE.

Ensemble Forecasting

SCE creates an ensemble forecast consisting of 18 individual Weather Research and Forecasting (WRF) model solutions. The ensemble members are developed by using multiple model initial and boundary conditions sources, multiple physics parameterization choices, and multiple grid lengths. Physics parameterization selections within the control and ensemble models are listed in the table below. Initial and boundary conditions for the ensemble models are provided by the NCEP Global Forecast System (GFS), NCEP North American Mesoscale Model (NAM), and the European Centre for Medium-range Weather Forecasts (ECMWF) Integrated Forecast System (IFS; i.e., European Global Weather Model).

The control model is initialized using the GFS. Model grid length is described later in this section. More detail on the physics choices can be found in the WRF users guide published by the National Center for Atmospheric Research https://www2.mmm.ucar.edu/wrf/users/docs/user_guide_v4/.

Table SCE 8-14 - Summary of WRF Model Physics Configurations

Physics Parameterization Selections	Control Model (Deterministic WRF)	Ensemble Perturbations
Cloud Physics	Morrison	Morrison, New Thompson, Eta
Boundary Layer Physics	MYNN3	MYNN, MYNN3, YSU, Shin-hong, MYNN2.5
Surface Layer Physics	MYNN	MYNN, Revised MM5
Shortwave Radiation	New Goddard	New Goddard, RTTMG, CAM
Longwave Radiation	New Goddard	New Goddard, RTTMG, CAM
Land Surface Model	NoahMP	NoahMP

Model Inputs

The following are input of SCE’s weather and fuels modeling

- **Operational and historical Weather Research and Forecasting Model Inputs**
 - Operational forecast models are driven by upper-level weather conditions, surface weather conditions from the GFS, NAM, and ECMWF initial and boundary conditions with soil moisture estimates from the NASA SPoRT dataset.
 - Historical reanalysis data stored within SCE’s Data Manager tool is initialized from the NCEP Climate Forecast System Reanalysis (CFSR)
- **Machine Learning**
 - Multiple fields from the control WRF model including:
 - Surface wind speed
 - Surface wind direction
 - Surface dew point temperature
 - Friction velocity (a measure of the degree of turbulence and mixing)
 - Terrain roughness

- Surface temperature gradient
- Surface wind speed gradient
- Wind speed (at 500 m, 1000 m, and 1500 m above ground level (AGL))
- Wind direction (at 500 m, 1000 m, and 1500 m AGL)
- Temperature (at 500 m, 1000 m, and 1500 m AGL)
- Historical weather station observations
- **Fuels Model**
 - Machine Learning model utilizing WRF weather model output to approximate live fuel moisture.

Model outputs

The following are outputs of SCE's weather and fuels modeling:

- Air temperature
- Mean Sea Level Pressure
- Relative humidity
- Wind velocity (speed and direction)
- Incoming shortwave radiation
- Geopotential Heights
- Omega (vertical velocity)
- Absolute Vorticity
- Dead Fuel Moisture
- Live Fuel Moisture
- Normalized Difference Vegetation Index
- Energy Release Component
- Burning Index
- Spread Component
- Ignition Component
- Keetch-Byram Index
- Growing Season Index
- Large Fire Potential Weather Component
- Large Fire Potential Fuel Moisture Component

- Greenness
- Convective Available Potential Energy
- Lifted Index
- Total Totals
- Rainfall
- Snow water equivalent
- Precipitable Water
- Peak 15 min rainfall accumulation
- Low, Mid, and High Cloud Cover
- Soil moisture
- Soil temperature
- Probability of exceeding sustained wind speed thresholds
- Probability of exceeding gust wind speed thresholds
- Weather Score component of the Fire Potential Index
- Fire Potential Index

Separate modules (e.g., local weather analysis and local vegetation analysis)

The Weather Research and Forecast (WRF) model deployed by SCE for its in-house weather modeling system is comprised of several separate modules that can be customized around forecast accuracy. These include the choice of initial and lateral boundary conditions, the underlying terrain resolution, and each of the physics parameterizations specified in Section 8.3.5.1.2. While each of these represent individual modules, they are linked within the WRF framework such that regardless of the module settings used to create a final forecast, a set of standard WRF output is created thereby providing flexibility in the form of allowing SCE to tailor “module” choice for improved forecast accuracy. This framework also allows SCE and its vendors to quickly test new module options as they become available from the research community. The initial and lateral boundary conditions provide information on both the synoptic and mesoscale weather features that will be impacting the SCE territory, which are then downscaled within the WRF model to finer detail. Inclusive in the WRF model solution is a module known as the planetary boundary layer scheme, which is responsible for including the impacts of large eddy scale weather on the overall weather solution as well as the land surface module responsible for including the impacts of local topography and land cover on the weather forecast.

Separate from SCE’s numerical weather prediction system described above is SCE’s machine learning forecast module. The machine learning module leverages the output from the numerical weather prediction system as input and then removes forecast biases from these inputs based on historical weather observations co-located at the forecast points. The machine learning module and the ensemble forecast output provide additional information on forecast uncertainty to SMEs. As of the end of 2022,

machine learning has been deployed at 564 weather station locations throughout the SCE territory.

Finally, SCE's fuel moisture modeling is a separate module that leverages SCE's weather forecast output in conjunction with mathematical algorithms to estimate dead fuel moisture across the service area. In addition, SCE, through its vendor, Atmospheric Data Solutions, has developed a machine learning model which has been trained on SCE's gridded historic weather and fuels data to predict live fuel moisture through the forecast period.

Collectively, SCE's weather and fuels model output are linked to shapefiles of SCE's infrastructure to produce forecasts directly on assets.

Subject matter expert (SME) assessment of forecasts

SCE Weather Services assesses weather model forecast outputs distilled to electrical circuit and weather station locations from models produced in house (i.e., the ensemble and machine learning guidance described above) as well as publicly available from government weather agencies. Automation is used to quickly identify areas of concern meeting key weather and fuels thresholds for meteorologist and fire scientist assessment. Use of multiple weather models and probabilistic forecast output allows SMEs to evaluate multiple possible forecast outcomes and their likelihood of occurrence. The machine learning models provide point forecasts that have been bias-corrected and probabilistically calibrated by historic observed weather that has occurred at that location. The team validates weather model forecasts for accuracy after each PSPS event and at the end of each year. SCE Weather Services additionally consults expert forecasts from the National Weather Service through publicly available weather discussions. Finally, SCE Weather Services utilizes historical climatological data compiled from each of our 1600+ weather stations installed on our distribution, sub-transmission and transmission systems. This climatological data helps the forecaster to calibrate forecast expectations with true, observable outcomes that have been recorded.

SCE's Fire Sciences assesses fuel conditions by reviewing its in-house fuel moisture modeling output and comparing that to live fuel moisture sampling observations. This information combined with meteorological forecasts helps SCE provide a daily assessment of fire potential across the landscape.

SCE's meteorologists review weather forecasts at a minimum of once per day.

Spatial Granularity

All WRF models' spatial granularity of either 2-km or 1-km. All WRF models are configured with 52 vertical levels.

Time Horizon

The maximum time horizon of SCE's in-house weather forecast and machine learning capabilities is 7 days. SCE meteorologists consult publicly available weather model guidance from vendors and the National Weather Service at longer forecast horizons up to two weeks in advance to gain knowledge on the broad-scale weather pattern and changes that may be coming in the future.

Highlights Since Last WMP Submission

Since the last WMP filing, SCE has improved its weather modeling system by focusing on expanding the use of machine learning to more locations. At the time of the last WMP filing, a total of 64 machine learning forecast locations were operational. As of this filing, 564 machine learning forecast locations are operational, a net gain of 500 new locations. Additionally, SCE has retrained older machine learning

model locations (e.g., the original 64) on additional available observations, improving their accuracy at capturing extreme wind scenarios. Finally, SCE has also developed new probabilistic forecast capabilities derived from machine learning at all 564 operational forecast locations to further aid in accurately estimated forecast uncertainty around sustained and gust winds.

SCE has additionally continued to update its gridded historical reanalysis dataset by twice-annual data refreshes. Data is uploaded into the Data Manager tool once generated.

8.3.5.2 Known Limitations of Existing Approach

The electrical corporation must describe any known limitations of its existing modeling approach resulting from assumptions, data availability, and computational resources. It must discuss the impact of these limitations on the modeling outputs.

SCE relies on numerical weather prediction models based on current state-of-the-art scientific methods developed and supported primarily by academia and government institutions. Several known limitations exist not only within SCE's weather models but generally all operational weather models in existence today. These limitations include:

1. It is not possible to achieve a perfect weather forecast because no perfect initial and boundary conditions exist to drive weather models. No perfect initial and boundary conditions exist because current observations sources used to determine the current state of the atmosphere do not provide complete planetary coverage (this includes areas well beyond the borders of the SCE territory). Additionally, such observations sources are subject to sampling errors that can result in inaccurate forecasts. SCE relies on the federal government to assimilate all surface and upper air observations into the initial and boundary conditions used as input into our WRF models. Therefore, the accuracy of the initial conditions is limited to the accuracy of the methods used in national meteorology centers like the US National Centers for Environmental Prediction and the European Centre for Medium-range Weather Forecasts. SCE uses multiple initial and boundary conditions to account for these uncertainties in its ensemble modeling approach.
2. There are no known analytical solutions to the equations of motion describing the state of the atmosphere. In other words, the equations used to predict the future state of the weather contain unknown terms that are parameterized using empirical experimental data from field campaigns. Such parameterizations do not provide perfect fits and can result in forecast errors. SCE has tested available physics parameterizations to choose those which provide the best forecast accuracy over our territory. SCE uses multiple parameterization choices to sample these unknowns in its ensemble approach.
3. Current state-of-the-art weather models such as the Weather Research and Forecasting (WRF) model are designed for grid lengths of roughly 1km by 1km and larger. This is due to computational restraints and the limitations of the physical parameterizations mentioned in (2). This limits the granularity of weather models until higher computational power becomes available as well as new physics parameterizations can be developed for smaller scales. The result is that fine-scale, unresolvable meteorology features impacting observations may be missed by weather models.

4. Computational constraints limit the number of high-resolution weather models SCE can run in-house, as well as the feasible forecast horizon for weather models. Currently this limits SCE to a forecast horizon of seven days, which is adequate for short to medium range planning. Additionally, it limits the number of ensemble members SCE can run in house, as well as the forecast update frequency as spare cycles are not currently available to run many rapid updates per day.
5. Weather model outputs can contain systematic (repeatable) bias resulting in inaccurate forecasts. SCE is removing these biases by using machine learning to create bias-corrected forecasts. Such forecasts require observations to train the machine learning to detect patterns in forecast error based on prior forecast-observation pairs. Given the dependence on observations for training, statistically correct forecasts are only available at locations where observations exist and with a long enough record for machine learning training. Still such forecasts will be subject to errors described in (1) and no perfect machine learning forecast exists. To overcome this, SCE has developed, and will continue to expand, probabilistic machine learning forecasts for wind speed and gust that estimate the possible forecast in each updated forecast.
6. Short periods of record for forecast evaluation and machine learning. SCE has installed 1600+ weather stations as of this WMP and continues to plan for more station installs. Such weather stations are used to evaluate forecast performance and train SCE's machine learning models. However, development of machine learning models requires at least six months of historical observations data to train new models. Thus, the coverage of SCE's machine learning network is limited to only those locations with sufficient historical data to train new models. Additionally, as the period of record for observations increases, existing machine learning model accuracy will be improved through retraining over more weather events.
7. Modeling fuel moisture is affected by the same limitations that are common in the numerical modeling stated above. In addition to the biases and other forecast errors associated with parameters such as temperature, atmospheric moisture, soil moisture, evaporation rates, etc., needed to calculate fuel moisture, uncertainties within the physical processes of vegetation phenology compound the errors associated with vegetation moisture outputs.

8.3.5.3 Planned Improvements

The electrical corporation must describe its planned improvements in its weather forecasting systems.

This must include any plans for the following:

- *Increase in model validation*
- *Increase in spatial granularity*
- *Decrease in limitations by removal of assumptions*
- *Increase in input data quality*
- *Increase in related frequency*

For each planned improvement, the electrical corporation must provide the following in Table 8-31:

- **Description:** A description of the planned initiative activity
- **Impact:** Reference to and description of the impact of the initiative activity on each risk and risk component
- **Prioritization:** A description of the x% risk impact (see Section 8.1.1.2 for explanation)
- **Schedule:** A description of the planned schedule for implementation

SCE’s planned improvements are documented in the Table 8-31.

Table 8-31 - SCE’s Planned Improvements to Weather Forecasting Systems

System	Description	Impact	x% Risk Impact	Implementation Schedule
Weather Visualization Tool	Build an internal visualization tool to view weather models available overlaid on top of SCE infrastructure.	Improve ability to analyze system impacts associated with weather events.	N/A, enhances foundational / enabling capabilities	System implementation in 2023 and will continue to operational in the following years.
Enhance ADS Date Manager	Extend historical datasets and enhance the functionality.	Allows for easy retrieval of model and historical weather data to perform analytics.	N/A, enhances foundational / enabling capabilities	Continued extensions of datasets and enhancements through foreseeable future
Update Gridded Wind Speed Percentiles	Use improved methods to model wind to produce an extreme wind map for winds at 10m above the ground.	Improves accuracy of wind models, which can help to inform PSPS wind thresholds.	N/A, enhances foundational / enabling capabilities	Updated in 2023 and every two years after.

System	Description	Impact	x% Risk Impact	Implementation Schedule
Monthly Circuit Geometry Updates	Continue to update information about circuits since work is always being done on them.	Ensuring proper data and shape of circuits is up to date to accurately forecast weather conditions on the circuit.	N/A, enhances foundational / enabling capabilities	Continued through foreseeable future.
Machine Learning Model Expansion	Continue to expand machine learning model capabilities to all weather station locations.	Improves forecast accuracy and ensures consistent situational awareness throughout	N/A, enhances foundational / enabling capabilities	Continue to implement as long as new weather stations come online.
Machine Learning Model Improvement	Evaluate forecasts and investigate future forecast improvements.	Ensures that new techniques and knowledge is used to continuously improve forecast models.	N/A, enhances foundational / enabling capabilities	Continued through foreseeable future.
Self-Organizing Maps (SOMs)	Use analog /pattern recognition approach in analysis for forecasts	Adding another model and forecasting technique adds resiliency and provides better insight to forecast uncertainty.	N/A, enhances foundational / enabling capabilities	Pilot system in 2023 and implement in 2024.
1-month and 3-month forecast of Santa Ana Wind days	Continue to create and improve seasonal Santa Ana Wind Forecasts.	Allows for advanced planning of potential critical weather conditions that can result in significant fire activity.	N/A, enhances foundational / enabling capabilities	Continued through foreseeable future.

System	Description	Impact	x% Risk Impact	Implementation Schedule
European Model Data Procurement	Continue European Model data feed.	Additional data feed increases forecast redundancy and improves planning around weather forecast uncertainties.	N/A, enhances foundational / enabling capabilities	Continued through foreseeable future.
Dead Fuel Moisture Model Improvement	Evaluate forecasts and investigate future forecast improvements	Ensures that new techniques and knowledge are used to continuously improve forecast models.	N/A, enhances foundational / enabling capabilities	Continue through 2023.

In 2022, SCE expanded its ML model capabilities to a total of 564 weather station locations and additionally built-out new probabilistic forecasts using machine learning at these same locations. SCE continued to expand its gridded historical data record through twice-yearly updates and improved the functionality of the Data Manager tool. SCE also kicked-off research efforts with UCSB on a gridded observations model and nowcasting tool and additionally began development of the Weather Visualization Portal.

In 2023, SCE plans to improve in-house weather modeling capabilities, by 1) expanding the number of ML model locations, 2) by evaluating a new ML modeling approach for improved forecast accuracy to inform future ML model development efforts, and 3) by implementing analog forecasts derived using Self-organizing Maps. In addition, SCE will continue to expand its gridded historical dataset through twice-yearly updates and add functionality improvements to the Data Manager used to access the historical data. SCE will also leverage this historical data and the ML methodology to refresh historical wind profiles (e.g., wind percentiles) on HFRA circuits. Finally, SCE will continue to explore new innovative technologies to mature situational awareness capabilities with research performed by UCSB and UCSD as well as through continued development of a Weather Visualization Portal with a vendor to enhance its ability to analyze data from several sources. A brief description of each improvement is noted below.

- ML models will be developed for select SCE weather station locations to improve wind forecast accuracy and provide calibrated estimates of forecast uncertainty. SCE plans to equip 500 to 600 weather station locations with Machine Learning (ML) capabilities in 2023.

- SCE will evaluate a new ML model approach that leverages new predictors from the SCE ensemble forecast systems for forecast accuracy improvements over the existing approach. The results will inform the ML model approach in 2024 and beyond.
- The Data Manager improves SCE’s ability to analyze historical weather and fuels conditions by providing users a platform to efficiently interact with SCE’s historical data. SCE will add further functionalities to the Data Manager around how data can be queried as well as extending the historical dataset to maintain currency.
- SCE is partnering with UCSB to create a gridded observation model that supplements the information provided by SCE’s existing network of weather stations. Additionally, UCSB is evaluating a nowcasting tool (very short-term forecast capability covering a horizon of the next six hours with rapid forecast updates) that will allow meteorologists to quickly analyze changing wind trends during PSPS events over granular areas.
- SCE is also planning to partner with the UCSD possibly along with other California utilities to evaluate a new, large 200-member ensemble weather forecast. This new forecast, if proven accurate across the period of research, would add to SCE’s forecast redundancy, provide another forecast solution for meteorologists to consider, and increase forecast capability maturity.
- SCE is developing a Weather Visualization Portal that, along with a more robust graphic user interface, will allow users to view and analyze large amounts of data from these models quickly and efficiently. This represents a marked improvement over the current process in which users are retrieving information from different data sources and comparing them, in order to produce an analysis.

In 2024 and 2025, SCE will continue to expand the development and implementation of its machine learning models to improve weather forecast accuracy and representation of confidence. SCE eventually plans to cover all weather station locations with a machine learning model as sufficient data becomes available and new weather station locations are added. SCE will also continually evaluate its machine learning approach and retrain models as updated data becomes available, which will make forecasts more accurate. SCE will also keep its gridded historical data current going forward and will pursue new innovative technologies through strategic academic partnerships. Finally, SCE intends to refresh its high-performance computing cluster (HPCC) infrastructure beginning in 2025 and periodically thereafter as current hardware reaches its end of life.

8.3.5.4 Evaluating Mitigation Initiatives

The electrical corporation must describe its procedures for the ongoing evaluation of the efficacy of its weather forecasting program.

To measure the efficacy of SCE’s weather forecast mitigations, SCE creates annual weather forecast verification summaries created by comparing forecast weather conditions to available observations. that the verifications provide robust indications of overall forecast performance which are used to further understand the limitations of current forecast capabilities. Additionally, SCE monitors its weather forecasting program through post event analyses for PSPS events. Finally, SCE asks vendors to include verification of developmental forecast systems within statements of work prior to implementation.

These summaries inform future continuous improvement efforts around weather forecasting as well as help to gain understanding of known modeling limitations.

8.3.5.5 Enterprise System for Weather Forecasting

In this section, the electrical corporation must provide an overview of its enterprise system for weather forecasting. This overview must include discussion of:

- *Any database(s) used for storage.*
- *Describe the electrical corporation's internal documentation of its database(s).*
- *Integration with systems in other lines of business.*
- *Describe any QA/QC or auditing of its system.*
- *Describe internal processes for updating the enterprise system including database(s).*
- *Any changes to the initiative since the last WMP submission and a brief explanation as to why those changes were made. Include any planned improvements or updates to the initiative and the timeline for implementation.*

Any database(s) used for storage

Full gridded weather forecast data from the deterministic weather forecast model (ensemble control model) is stored internally on SCE's Enterprise Analytics Platform – Hadoop in the Weather Data Mart (WDM) application. Distilled weather information at the circuit level is also maintained from all internal weather model sources (e.g., the ensemble and machine learning forecasts) in a file repository.

Describe the electrical corporation's internal documentation of its database(s)

The WDM application solution design and all other database design aspects are documented in the Solution Architecture Document.

Integration with systems in other lines of business

The WDM integrates weather/environmental dimensional data from multiple sources for data consolidation and processing. In addition to maintain the forecasts from the control model mentioned early, the WDM also stores specialized forecasts used by SCE Weather Services for the Energy Procurement and Management functions including those created by the National Weather Service.

Describe any QA/QC or auditing of its system

QA/QC of weather data being loaded into the WDM is handled via system checks and alerts which are in place for any exceptions or failures of automated data loads and integrations. These alerts and failures are addressed to ensure timely remediation. For any enhancements or fixes done to WDM, remediation is done by corresponding IT Support teams through an SCE established IT Service Management Process

ensuring requisite compliance and data quality.

Describe internal processes for updating the enterprise system including database(s)

SCE contracts with its Managed Services Provider, who is responsible for enhancements (including databases) on a regular basis. When these updates are completed, SCE validates the functionality end to end with regression and user acceptance testing to ensure everything works as expected. Any bugs found are communicated back to the vendor to be fixed and retested. Once the testing is completed and passed, the new functionality is migrated to our production environment. These changes are managed and tracked using BMC Remedy IT's change management control tool.

Any changes to the initiative since the last WMP submission and a brief explanation as to why those changes were made. Include any planned improvements or updates to the initiative and the timeline for implementation

SCE did not make any changes to its enterprise system for weather forecasting since the last WMP submission. In 2023, SCE will work to archive inputs used to drive in-house weather models within electric corporation maintained databases to improve weather forecast capability maturity.

8.3.6 Fire Potential Index

The electrical corporation must describe its process for calculating its fire potential index (FPI) or a similar a landscape scale index used as a proxy for assessing real-time risk of a wildfire under current and forecasted weather conditions. The electrical corporation must document the following:

- *Its existing calculation approach and how its FPI is used in its operations*
- *The known limitations of its existing approach*
- *Implementation schedule for any planned changes to the system Reference the Utility Initiative Tracking ID where appropriate.*

8.3.6.1 Existing Calculation Approach and Use

The electrical corporation must describe:

- *How it calculates its own FPI or if uses an external source, such as the United States Geological Survey³⁵*
- *How it uses its or an FPI in its operations*

Additionally, if the electrical corporation calculates its own FPI, it must provide tabular information regarding the features of its FPI. Table 8-32 provides a template for the required information.

How it calculates its own FPI or if uses an external source, such as the United States Geological Survey.

SCE assesses daily wildfire potential through use of its Fire Potential Index (FPI) which is based on weather and fuel (vegetation) conditions. FPI is calculated at the circuit level twice daily with output

every three hours, out to seven days and includes the following inputs.

- Wind speed—Sustained wind velocity at six meters above ground level.
- Dew point depression—The dryness of the air as represented by the difference between air temperature and dew point temperature at two meters above ground level.
- Energy release component (ERC)—As defined by the U.S. Department of Agriculture: “The available energy in British Thermal Unit (BTU) per unit area (square foot) within the flaming front at the head of a fire ... reflects the contribution of all live and dead fuels to potential fire intensity.”²⁴³
- 10-hour dead fuel moisture—A measure of the amount of moisture in ¼-inch diameter dead fuels, such as small twigs and sticks.
- 100-hour dead fuel moisture—A measure of the amount of moisture in 1- to 3-inch diameter dead fuels, i.e., dead, woody material such as small branches.
- Live fuel moisture—A measure of the amount of moisture in living vegetation.
- Normalized Difference Vegetation Index (NDVI)— As defined by the U.S. Department of the Interior: “... used to quantify vegetation greenness and is useful in understanding vegetation density and assessing changes in plant health.”²⁴⁴

²⁴³ U.S. Department of Agriculture. n.d. “Energy Release Component (ERC) Fact Sheet.” Forest Service. Accessed April 14, 2021. https://www.fs.usda.gov/Internet/FSE_Documents/stelprdb5339121.pdf.

²⁴⁴ Department of the Interior. n.d. Landsat Normalized Difference Vegetation Index. Access April 14, 2021. https://www.usgs.gov/core-science-systems/nli/landsat/landsat-normalized-difference-vegetation-index?qt-science_support_page_related_con=0#qt-science_support_page_related_com.

Figure SCE 8-51 - Fire Potential Index Equation

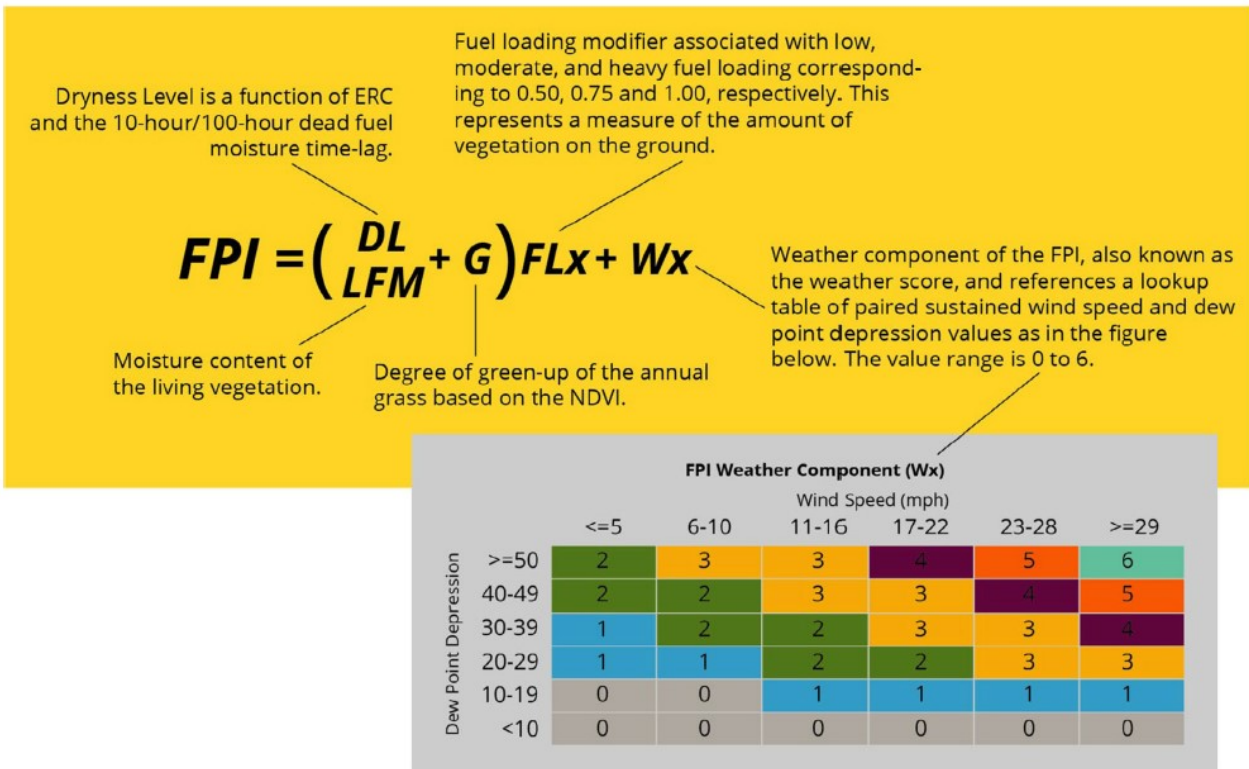

Based on a risk analysis of the historical fire data, the FPI is set at 13 for most areas. However, exceptions exist for certain areas and situations in which the FPI threshold is set at 12. These include:

- FCZ1 (Coastal region) — The threshold for FCZ1 remains at 12 because calculated historical probabilities indicated a significantly higher ignition risk factor at an FPI threshold of 13 for this FCZ than for the other FCZs (2, 3, 4, 9, and 10).
- Geographic Area Coordination Center (GACC) preparedness level of 4 or 5 — The GACC coordinates multiple federal and state agencies to track and manage regional fire resources. It provides a daily fire preparedness level on a score of 1-5. A high score signals that there could be resource issues in responding to a fire.
- Circuits located in an active Fire Science Area of Concern (AOC) — AOCs are areas within FCZs that are at high risk for fire with significant community impact. This designation is based on factors that are common to FPI as well as egress, fire history, and fire consequence.

How it uses its or an FPI in its operations

The Fire Potential Index (FPI) is a tool that is used to estimate fire potential across the landscape based on weather and fuel (vegetation) conditions and is one data point used in the PSPS decision-making process.

Table 8-32 - Fire Potential Features

Feature Group	Feature	Altitude	Description	Source	Update Cadence	Spatial Granularity	Temporal Granularity
Weather Component	Wind Speed	Surface	Wind speed in miles per hour at 6 meters above ground	Deterministic Weather model	2x per day	2 km	3 Hour Forecasts for 7 days
Weather Component	Dewpoint Depression	Surface	The difference between the temperature and dew point temperature in degrees Fahrenheit at 2 meters above ground	Deterministic Weather model	2x per day	2 km	3 Hour Forecasts for 7 days
Fuels Component	Dryness Level	Surface	Comprised of the Energy Release Component ²⁴⁵ and the 10-hour/100-hour dead fuel moisture time-lag ²⁴⁶	Deterministic Weather model	2x per day	2 km	3 Hour Forecasts for 7 days
Fuels Component	Live Fuel Moisture	Surface	Moisture content of the living vegetation in percent.	Deterministic Weather model	2x per day	2 km	3 Hour Forecasts for 7 days

²⁴⁵ Energy Release Component (ERC) is a measure of potential energy (BTU) at the flaming front of a fire and is a composite of fuel moisture from various dead and live fuels.

²⁴⁶ The time required for dead vegetation (1/2" diameter) to respond to changes in ambient temperature and humidity.

Fuels Component	Grass Green-Up	Surface	The degree of green-up of the annual grass based on the Normalized Difference Vegetation Index (NDVI) ²⁴⁷	Deterministic Weather model	2x per day	2 km	3 Hour Forecasts for 7 days
-----------------	----------------	---------	--	-----------------------------	------------	------	-----------------------------

8.3.6.2 Known Limitations of Existing Approach

The electrical corporation must describe any known limitations of current FPI calculation.

The current FPI is based on SDG&E’s index, which was adopted in 2018 and used for PSPS in 2019. During the 2019 PSPS events, SCE observed limitations in its current FPI. SCE added a fuel-loading modifier in 2019 to account for areas where fuels are sparse and unlikely to support a significant fire. In 2021, SCE calibrated the index and was able to raise FPI thresholds across much of its HFRA as a result. While FPI is a good metric for identifying critical weather events that can result in high fire potential and PSPS, SCE is looking to improve upon its current FPI in subsequent iterations. As a result, SCE is developing a new fire potential index (FPI 2.0) which employs a more sophisticated methodology for assessing fuel conditions. It also puts more emphasis on wind speed as wind can dominate the fire environment. This improved index will do a better job in capturing the sensitivity of critical fire weather conditions as well as being able to highlight extreme events.

8.3.6.3 Planned Improvements

The electrical corporation must describe its planned improvements for its FPI including a description of the improvement and the planned schedule for implementation.

In 2021, SCE developed a new FPI (2.0) to address the limitations stated previously, by placing more emphasis on wind speeds and constructing a new fuels component to account for the diversity of fuel conditions across SCE’s service area. The output of FPI 2.0 will provide supplemental data perspectives and continue to be compared with the current FPI in 2023. SCE plans to determine if FPI 2.0 captures more detail in the environmental conditions and provides a more accurate representation of fire potential across the SCE service area. This will allow for an extensive evaluation of FPI 2.0 to occur, with the goal of slowly integrating FPI 2.0 into the PSPS data driven decision making process.

8.3.7 Maturity Advancement

SCE continually seeks alignment with government and industry organizations and practices and continues to look for opportunities to improve situational awareness maturity over time.

²⁴⁷ The Normalized Difference Vegetation Index (NDVI) is an index of plant “greenness” or photosynthetic activity and is one of the most commonly used remotely sensed vegetation indices.

The activities discussed in this section could lead to Situational Awareness and Forecasting maturity advancements. Below is a summary of broader anticipated maturity improvements over the WMP period that supplement the objectives outlined at the beginning of the Section.

Table SCE 8-15 - Situational Awareness Maturity Improvements

Capability Name	Projected Maturity Improvements
Weather Forecasting	Improvements include improved documentation (i.e., version control) of model inputs and sharing of model performance and validation metrics with the public. Additional improvements include evaluating the expansion of ensemble size on forecast accuracy and development of forecasts that quantify uncertainty information for additional variables from those in use today.
Ignition Likelihood Estimation	Improvements include documentation of discrepancies between ignition likelihood estimates and observations, and a process to validate these SCE conducted analysis by a third-party. Additional improvements will be come from model enrichment with new data, the creation of sub-modules, and documentation on model sensitivity.
Wildfire spread forecasting	Improvements include new wildfire spread model inputs (i.e.; ensemble weather forecasts).
Data collection for near-real-time conditions	Clearly defined processes to track discrepancies between current and historical data; and providing information to the public (i.e.; statistical summary).

8.4 Emergency Preparedness

8.4.1 Overview

Each electrical corporation must develop and adopt an emergency preparedness²⁴⁸ plan in compliance with the standards established by the CPUC pursuant to Public Utilities Code section 768.6(a). Wildfires and PSPS events introduce unique risk management challenges requiring the electrical corporation to evaluate, develop, and implement wildfire- and PSPS- specific emergency preparedness activities as part of a holistic emergency preparedness strategy.

In this section, the electrical corporation must identify objectives for the next 3- and 10-year periods, targets, and performance metrics related to the following emergency preparedness programmatic areas:

- *Wildfire and PSPS emergency preparedness plan*
- *Collaboration and coordination with public safety partners*
- *Public notification and communication strategy*
- *Preparedness and planning for service restoration*
- *Customer support in wildfire and PSPS emergencies*
- *Learning after wildfire and PSPS events*

SCE maintains a comprehensive business continuity and emergency management program. This program includes emergency and continuity planning, a robust training and exercise program, a hazard

²⁴⁸ "Emergency and Disaster Preparedness" from Public Utilities Code section 768.6 has been shortened here to Emergency Preparedness.

analysis and mitigation program, and an after-action/corrective action process. This inclusive approach to emergency preparedness helps SCE in building and maturing emergency response capabilities year over year. SCE prioritizes emergency preparedness at all levels of the organization, including senior leadership.

SCE addresses emergency preparedness and response planning through an all-hazards approach, which focuses on capabilities that are critical to address a full spectrum of disruptive events, including natural and/or human-caused emergencies. SCE maintains a Business Resiliency (BR) All-Hazards Emergency Operations Plan (AHP) that incorporates disaster and emergency preparedness, emergency incident response and recovery activities that facilitate restoration and continuity of critical operations. The AHP outlines the roles and responsibilities for the company leadership and incident response personnel across the enterprise for response operations during any type of event.

The AHP serves as the foundation for emergency preparedness, response, and recovery operations and connects to more detailed and specific plans that are specialized to certain hazards and/or situations, including the Earthquake Response Plan, Electric Emergency Action Plan, Cyber Annex, Business Continuity Plans, and the PSPS Protocols. These response plans are available for responders to guide operations during emergency events.

8.4.1.1 Objectives

Each electrical corporation must summarize the objectives for its 3-year and 10-year plans for implementing and improving its emergency preparedness.²⁴⁹ These summaries must include the following:

- *Identification of which initiative(s) in the WMP the electrical corporation is implementing to achieve the stated objective, including Utility Initiative Tracking IDs*
- *Reference(s) to applicable codes, standards, and best practices/guidelines and an indication of whether the electrical corporation exceeds an applicable code, standard, or regulation*
- *Method of verifying achievement of each objective*
- *A completion date for when the electrical corporation will achieve the objective*
- *Reference(s) to the WMP section(s) or appendix, including page numbers, where the details of the objective(s) are documented and substantiated*

This information must be provided in Table 8-33 for the 3-year plan and Table 8-34 for the 10-year plan. Examples of the minimum acceptable level of information are provided below.

²⁴⁹ Annual information included in this section must align with the QDR data.

Below is a summary of SCE’s 3-year Emergency Preparedness objectives.

Table 8-33 - Emergency Preparedness Initiative Objectives (3-year plan)

Objectives for Three Years (2023–2025)	Applicable Initiative(s), Tracking ID(s)	Applicable Regulations, Codes, Standards, and Best Practices (See Note)	Method of Verification (i.e., program)	Completion Date	Reference (section & page #)
Maintain a comprehensive all-hazards planning and preparedness program to provide effective emergency response and to safely and expeditiously restore service during and after a major event.	Emergency Preparedness Plan (8.4.2)	<ul style="list-style-type: none"> • GO 95 • GO128 • GO 166 • ESRB-8 • PSPS OIR Phase 1 D.19-05-042, Phase 2 D.20-05-051, Phase 3 D.21-06-034 • PSPS OII D.21-06-014 • SEMS • NIMS 	Annual Filing**	Yearly	Section 8.4.2 Emergency Preparedness Plan, pp. 529-551
Provide effective and accurate communications to the public before, during and immediately following major outages and emergencies.	Public Emergency Communication Strategy (8.4.4)	<ul style="list-style-type: none"> • GO 95 • GO128 • GO 166 • ESRB-8 • PSPS OIR Phase 1 D.19-05-042, Phase 2 D.20-05-051, Phase 3 D.21-06-034 • PSPS OII D.21-06-014 • SEMS • NIMS 	Activity Reporting***	On-going	Section 8.4.4 Public Emergency Communication Strategy, pp. 558-566

Note: An asterisk indicates that the electrical corporation exceeds a particular code, regulation, standard, or best practice. The electrical corporation must provide a reference to the appendix section and page providing further documentation, justification, and substantiation.

** SCE maintains an annual schedule for completion of updates to both the All-Hazards Emergency Plan and associated hazard specific plans to provide for response and meet regulatory requirements. SCE also files these emergency plans annually to meet regulatory requirements (GO166, EEAP, etc.) with the Safety Enforcement Division of the CPUC. A publicly available version of the All Hazards Emergency Plan was also posted on the Energy Safety website in 2023 and can be found at <https://efiling.energysafety.ca.gov/eFiling/Getfile.aspx?fileid=53525&shareable=true>

*** Communication to customers occurs on our website, including banners and macro messaging on our home page, and updated information on our outage page and map; through Energized, our news channel; and on social media. During emergencies, all these channels are publicly available for review. News stories on Energized are posted in advance of flex alerts, and when there is a potential for significant customer impacts, with follow-up reporting as required. These articles are archived and publicly available indefinitely (going back to 2013) at energized.com. For PSPS, notifications are sent pursuant to PSPS guidelines and results are available in SCE post-event reports, 10 days after the conclusion of each event, which can be found on SCE’s website at: <https://www.sce.com/wildfire/wildfire-safety>.

Below is a summary of SCE’s 10-year Emergency Preparedness objectives.

Table 8-34 - Emergency Preparedness Initiative Objectives (10-year plan)

Objectives for Ten Years (2026–2032)	Applicable Initiative(s), Tracking ID(s)	Applicable Regulations, Codes, Standards, and Best Practices (See Note)	Method of Verification (i.e., program)	Completion Date	Reference (section & page #)
Refined emergency planning and preparedness practices and programs to support customers before, during, and following emergency events.	Customer Support in Wildfire and PSPS Emergencies (8.4.6)	<ul style="list-style-type: none"> • GO 95 • GO128 • GO 166 • ESRB-8 • PSPS OIR Phase 1 D.19-05-042, Phase 2 D.20-05-051, Phase 3 D.21-06-034 • PSPS OII D.21-06-014 • SEMS • NIMS 	Activity Reporting **	On-going	Section 8.4.6 Customer Support in Wildfire and PSPS Emergencies, pp. 570-576
Ongoing implementation of lessons learned and findings from After Action Reports (AARs) and other external sources to continuously improve emergency response capabilities.	<p>Emergency Preparedness Plan (8.4.2)</p> <p>External Collaboration and Coordination (8.4.3)</p> <p>Public Emergency Communication Strategy (8.4.4)</p>	<ul style="list-style-type: none"> • ESRB-8 • PSPS OIR Phase 1 D.19-05-042, Phase 2 D.20-05-051, Phase 3 D.21-06-034 • PSPS OII D.21-06-014 	<p>Activity Reporting</p> <p>AARs – completed after each exercise and real-world event. AARs include corrective action items for resolution that are managed to completion.</p>	On-going	Section 8.4.2 (Emergency Preparedness Plan), pp. 529-551; Section 8.4.3 (External Collaboration and Coordination) pp. 550-560; Section 8.4.4 (Public Emergency Communication Strategy), pp. 558-566

Note: An asterisk indicates that the electrical corporation exceeds a particular code, regulation, standard, or best practice. The electrical corporation must provide a reference to the appendix section and page providing further documentation, justification, and substantiation.

** All planning and preparedness programs to support customers before, during and following emergency events are described on SCE’s website at: <https://www.sce.com/outage-center/customer-resources-and-support> Information is updated to be current with any program updates or changes.

8.4.1.2 Targets

Initiative targets are forward-looking quantifiable measurements of activities identified by each electrical corporation in its WMP. Electrical corporations will show progress toward completing targets in subsequent reports, including QDRs and WMP Updates.

The electrical corporation must list all targets it will use to track progress on its emergency preparedness for the three years of the Base WMP. Energy Safety's Compliance Assurance Division and third parties must be able to track and audit each target.²⁵⁰ For each initiative target, the electrical corporation must provide the following:

- *Utility Initiative Tracking IDs.*
- *Projected targets for the three years of the Base WMP and relevant units.*
- *The expected "x% risk impact" for each of the three years of the Base WMP. The expected x% risk impact is the expected percentage risk reduction per year, as described in Section 7.2.2.2.*
- *Method of verifying target completion.*

The electrical corporation's targets must provide enough detail to effectively inform efforts to improve the performance (i.e., reduction in wildfire consequence) of the electrical corporation's emergency preparedness initiatives.

Table 8 - 3 5 provides an example of the minimum acceptable level of information.

In Table 8-35 below, SCE provides the expected risk impact for each initiative at the scoping unit level and at the HFRA-level. The risk impact percentages for PSPS-2 and PSPS-3 are based on the expected reduction to PSPS risk in MARS, while the risk impact percentages for DEP-2 is based on the expected reduction to wildfire risk in MARS.. SCE includes additional columns in the table below showing the percentage of an initiative's scope that is in Severe Risk Area (SRA) and High Consequence Areas (HCA).

²⁵⁰ Annual information included in this section must align with Tables 1 and 12 of the QDR.

Below is a summary of SCE’s Emergency Preparedness targets by year.

Table 8-35 - Emergency Preparedness Initiative Targets by Year

Initiative Activity	Tracking ID	2023 Target & Unit	x% Risk Impact 2023 (Scoped / HFRA)	2024 Target & Unit	x% Risk Impact 2024 (Scoped / HFRA)	2025 Target & Unit	x% Risk Impact 2025 (Scoped / HFRA)	Method of Verification
SCE Emergency Response Training	DEP-2	PSPS response teams are fully qualified/re-qualified by 7/1 annually to maintain readiness	N/A	PSPS response teams are fully qualified/re-qualified by 7/1 annually to maintain readiness	N/A	PSPS response teams are fully qualified/re-qualified by 7/1 annually to maintain readiness	N/A	IMT training roster
Aerial Suppression	DEP-5	Provide fire agencies with funding to support quick reaction force (QRF) program for 2023	1.6%	SCE will continue to reassess availability and funding for aerial suppression resources in SCE’s service area annually to determine ongoing QRF strategy	1.9%	SCE will continue to reassess availability and funding for aerial suppression resources in SCE’s service area annually to determine ongoing QRF strategy	2%	Copy of funding agreement
Customer Care Programs (Critical Care Backup	PSPS-2	Complete 85% of battery deliveries to eligible customers within 30 calendar days* of program enrollment, subject to customer	28%/.004% <i>(PSPS risk only)</i>	Complete 85% of battery deliveries to eligible customers within 30 calendar days* of program enrollment, subject to customer availability, reschedule	31%/.007% <i>(PSPS risk only)</i>	Complete 85% of battery deliveries to eligible customers within 30 calendar days* of program enrollment, subject to customer availability, reschedule	35%/.005% <i>(PSPS risk only)</i>	Year to date list of customer enrollment and battery deliveri

<i>Initiative Activity</i>	<i>Tracking ID</i>	<i>2023 Target & Unit</i>	<i>x% Risk Impact 2023 (Scoped / HFRA)</i>	<i>2024 Target & Unit</i>	<i>x% Risk Impact 2024 (Scoped / HFRA)</i>	<i>2025 Target & Unit</i>	<i>x% Risk Impact 2025 (Scoped / HFRA)</i>	<i>Method of Verification</i>
Battery (CCBB) Program)		<p>availability, reschedule requests and battery supply constraints</p> <p>Strive to complete 90% of battery deliveries to eligible customers within 45 calendar days of program enrollment, subject to customer availability, reschedule requests and battery supply constraints</p> <p>* Number of calendar/business days subject to change based on customer survey feedback to inform appropriate calendar/business day</p>		<p>requests and battery supply constraints</p> <p>Strive to complete 90% of battery deliveries to eligible customers within 45 calendar days of program enrollment, subject to customer availability, reschedule requests and battery supply constraints</p> <p>* Number of calendar/business days subject to change based on customer survey feedback to inform appropriate calendar/business day measurement</p>		<p>requests and battery supply constraints</p> <p>Strive to complete 90% of battery deliveries to eligible customers within 45 calendar days of program enrollment, subject to customer availability, reschedule requests and battery supply constraints</p> <p>* Number of calendar/business days subject to change based on customer survey feedback to inform appropriate calendar/business day measurement</p>		es

<i>Initiative Activity</i>	<i>Tracking ID</i>	<i>2023 Target & Unit</i>	<i>x% Risk Impact 2023 (Scoped / HFRA)</i>	<i>2024 Target & Unit</i>	<i>x% Risk Impact 2024 (Scoped / HFRA)</i>	<i>2025 Target & Unit</i>	<i>x% Risk Impact 2025 (Scoped / HFRA)</i>	<i>Method of Verification</i>
		measurement						
Customer Care Programs (Portable Power Station and Generator Rebates)	PSPS-3	Process 85% of all rebate claims within 30 business days* of receipt from website vendor; excluding website related delays and subject to receiving all required customer information Strive to process 90% of all rebate claims within 45 business days of receipt from website vendor; excluding website related delays and subject to receiving all required customer information	0.11%/.0001% (PSPS risk only)	Process 85% of all rebate claims within 30 business days* of receipt from website vendor; excluding website related delays and subject to receiving all required customer information Strive to process 90% of all rebate claims within 45 business days of receipt from website vendor; excluding website related delays and subject to receiving all required customer information * Number of calendar/business days subject to change	0.11%/.0002% (PSPS risk only)	Process 85% of all rebate claims within 30 business days* of receipt from website vendor; excluding website related delays and subject to receiving all required customer information Strive to process 90% of all rebate claims within 45 business days of receipt from website vendor; excluding website related delays and subject to receiving all required customer information * Number of calendar/business days subject to change based	0.11%/.0002% (PSPS risk only)	Year to date list of rebate claims and processing dates

<i>Initiative Activity</i>	<i>Tracking ID</i>	<i>2023 Target & Unit</i>	<i>x% Risk Impact 2023 (Scoped / HFRA)</i>	<i>2024 Target & Unit</i>	<i>x% Risk Impact 2024 (Scoped / HFRA)</i>	<i>2025 Target & Unit</i>	<i>x% Risk Impact 2025 (Scoped / HFRA)</i>	<i>Method of Verification</i>
		* Number of calendar/business days subject to change based on customer survey feedback to inform appropriate calendar/business day measurement		based on customer survey feedback to inform appropriate calendar/business day measurement		on customer survey feedback to inform appropriate calendar/business day measurement		

The projections provided in Table 8-35 are estimates and subject to change.

8.4.1.3 Performance Metrics Identified by the Electrical Corporation

Performance metrics indicate the extent to which an electrical corporation's Wildfire Mitigation Plan is driving performance outcomes. Each electrical corporation must:

- *List the performance metrics the electrical corporation uses to evaluate the effectiveness of its emergency preparedness in reducing wildfire and PSPS risk²⁵¹*

For each of these performance metrics listed, the electrical corporation must:

- *Report the electrical corporation's performance since 2020 (if previously collected)*
- *Project performance for 2023-2025*
- *List method of verification*

The electrical corporation must ensure that each metric's name and values are the same in its WMP reporting as its QDR reporting (specifically, QDR Table 2 and QDR Table 3). Metrics listed in this section that are the same as performance metrics required by Energy Safety and reported in QDR Table 2 (Performance Metrics)²⁵² must match those reported in QDR Table 2. Metrics listed in this section that are not the same as any of the performance metrics identified by Energy Safety and reported in QDR Table 2 must match those reported in QDR Table 3.

The electrical corporation must:

- *Summarize its self-identified performance metric(s) in tabular form*
- *Provide a brief narrative that explains trends in the metrics*

SCE has identified performance metrics relating to SCE's Emergency Preparedness activities. These metrics align with SCE's efforts to minimize the scope, duration, and customer impacts from PSPS events. SCE's IMT structure and overall emergency preparedness function is critical in being able to reduce these impacts and communicate effectively with all our stakeholders. Please see Section 9 for further discussion on these metrics, including a brief narrative that explains trends in the metrics.

²⁵¹ There may be overlap between the performance metrics the electrical corporation uses and performance metrics required by Energy Safety. The electrical corporation must list these overlapping metrics in this section in addition to any unique performance metrics it uses.

²⁵² The performance metrics identified by Energy Safety are included in Energy Safety's Data Guidelines.

Below is a summary of SCE’s Emergency Preparedness performance metrics by year.

Table 8-36 - Emergency Preparedness Performance Metrics Results by Year

Performance Metrics	2020	2021	2022	2023 Projected	2024 Projected	2025 Projected	Method of Verification (e.g., third-party evaluation, QDR)
Scope of PSPS Events (total) ²⁵³	424	232	13	210	197	185	QDR, Tables 3 and 10
Duration of PSPS events (total) ²⁵⁴	4,455,936	3,700,254	112,274	2,508,101	2,282,372	2,076,958	QDR, Tables 3 and 10
Number of customers impacted by PSPS ²⁵⁵	229,800	179,502	15,784	120,441	102,375	87,019	QDR, Tables 3 and 10

²⁵³ Scope of PSPS Events definition: Circuit-events, measured in number of events multiplied by number of circuits de-energized per year

²⁵⁴ Duration of PSPS events definition: Customer hours per year

²⁵⁵ Number of customers impacted by PSPS definition: Number of customers impacted by PSPS (if multiple PSPS events impact the same customer, count each event as a separate customer)

8.4.2 Emergency Preparedness Plan

In this section, the electrical corporation must provide an overview of how it has evaluated, developed, and integrated wildfire- and PSPS-specific emergency preparedness strategies, practices, policies, and procedures into its overall emergency plan based on the minimum standards described in GO 166. The electrical corporation must provide the title of its latest emergency preparedness report, the date of the report, and an indication of whether the plan complies with CPUC R. 15-06-009, D. 21-05-019, and GO 166. The overview must be no more than two paragraphs.

SCE's AHP (Version December 2022) outlines the company's emergency management response strategy and tactics, including wildfire responses. The plan integrates the strategies set by the National Response Framework,²⁵⁶ mirroring the mission areas and the applicable core capabilities as defined by the Federal Emergency Management Agency (FEMA). It aligns with concepts identified in both the California Standardized Emergency Management System (SEMS)²⁵⁷ and National Incident Management System (NIMS). In 2021, SCE performed a comprehensive update to the AHP that included additional elements recently required by D.21-05-019.²⁵⁸ PSPS-06-SCE-01 Public Safety Power Shutoff Protocol, Version 3, dated August 1, 2022, outlines PSPS strategy and tactics.

In both the AHP and the PSPS Protocol, SCE adheres to the regulations imposed by CPUC, FERC, CAISO, CalOES, and NERC. Please see Section 8.4.2.1 for additional information.

In addition, the electrical corporation must provide a list of any other relevant electrical corporation documents that govern its wildfire and PSPS emergency preparedness planning for response and recovery efforts. This must be a bullet point list with document title, version (if applicable), and date. For example: Electrical Corporation's Emergency Response Plan (ECERP), Third Edition, dated January 1, 2021

- SOB 21: System Emergency Response Plan, dated October 3, 2022.

Reference the Utility Initiative Tracking ID where appropriate.

²⁵⁶ See National Response Framework, available at <https://www.fema.gov/emergency-managers/national-preparedness/frameworks/response>

²⁵⁷ The California Standardized Emergency Management System is a structure for coordination between the government and local emergency response organizations. It provides and facilitates the flow of emergency information and resources within and between the organizational levels of field response, local government, operational areas, regions, and state emergency management. SCE has integrated SEMS into its emergency plans and response structure.

²⁵⁸ See Decision (D.) 21-05-19 from (Rulemaking 15-06-009) Addressing Phase II Issues Relating to Emergency and Disaster and Preparedness Plans, available at <https://docs.cpuc.ca.gov/PublishedDocs/Published/G000/M385/K377/385377826.PDF>

8.4.2.1 Overview of Wildfire and PSPS Emergency Preparedness

In this section of the WMP, the electrical corporation must provide an overview of its wildfire- and PSPS-specific emergency preparedness plan. At a minimum, the overview must describe the following:

- *Purpose and scope of the plan.*

The AHP is the base document for strategic, operational, and tactical planning for all SCE emergency response, and documents our company-wide approach to continue operations and meet the diverse needs of the community in coordination and participation with our emergency response partners. It is designed to guide us in the safe and efficient restoration after any type of outage through identification of applicable prioritization and restoration strategies, and the development of a common operating picture for communicating situational awareness to internal and external stakeholders. The AHP integrates the strategies set by the National Response Framework, including the mission areas and the applicable core capabilities defined by FEMA. It is in alignment with concepts identified in both the SEMS and NIMS.

The AHP does not supersede or replace existing procedures for safety, hazardous materials response, or other similar procedures adopted and in place, including but not limited to specific response plans prepared to address individual circumstances or to comply with regulatory requirements.

The PSPS Protocol coordinates critical preparedness, response, and recovery operations for PSPS, including public safety partner and customer notifications. It outlines specific PSPS IMT roles and responsibilities and describes the communication and coordination protocols between internal and external stakeholders when implementing a PSPS.

Overview of protocols, policies, and procedures for responding to and recovering from a wildfire or PSPS event (e.g., means and methods for assessing conditions, decision-making framework, prioritizations). This must include:

SCE maintains compliance with the protocols, policies, and procedures that govern PSPS. Multiple authorities guide the structure, development, and implementation of PSPS, including numerous regulatory agencies such as FERC, NERC, and the CPUC. SCE has built an internal program and structure to adhere to and implement these requirements, including establishing operational protocols pertaining to wildfire and PSPS-related outages and emergency response.

The following requirements inform emergency plans and procedures:

CPUC Requirements:

- General Order Number 166: Standards for Operation, Reliability, and Safety during Emergencies and Disasters, current revision
- General Order Number 95: Rules for Overhead Electric Line Construction
- General Order Number 128: Rules for Construction of Underground Electric Supply and Communication Systems

- Resolution ESRB-8: Resolution Extending De-Energization Reasonableness, Notification, Mitigation, and Reporting Requirements in Decision 12-04-024 to All Electric Investor Owned Utilities
- PSPS Order Instituting Rulemaking (OIR) Phase 1 (Decision (D.) 19-05-042), Phase 2 (D.20-05-051), Phase 3 (D.21-06-034) and PSPS Order Instituting Investigation (OII) (D.21-06-014)

CAISO

- California Independent System Operator (CAISO) Standards for Reliability and Safety during Emergencies and Disasters (May 2021)

Energy Safety

- Senate Bill 901 (2018) provided for the treatment of wildfire

SCE Policies/Procedures

- System Operating Bulletin No. 21: System Emergency Response Plan

Internally, SCE identifies general standards and authorities for IMT through the Incident Management Team guidelines, and unique standards and authorities specific to incident types through the development of Incident/Hazard Specific Annexes to the All-Hazards Plan. In some cases, SCE will stand up an Incident Support Team (IST). ISTs are more advanced teams, whose members go through more training and are typically in a management role in the company. ISTs are also subject to IMT guidelines. In addition, the Crisis Management Council (CMC) or Officer-In-Charge may issue a delegation of authority to IST/IMT Incident Commanders to outline incident-specific authorities.

An operational flow diagram illustrating key components of its wildfire- and PSPS-specific emergency response procedures from the moment of activation to response, recovery, and restoration of service.

Separate overviews and operational flow diagrams for wildfires and PSPS events.

Table SCE 8-16 illustrates the phases of emergency management. These phases generally apply to wildfire and all-hazards.

Table SCE 8-16 - Emergency Management Phases

Pre-Incident			Response			Recovery
1A	1B	1C	2A	2B	2C	3A
Normal Operations	Increased Likelihood	Credible Threat	Activation	Initial Response	Sustained Response	Long-Term Recovery

Figure SCE 8-52a illustrates the phases of emergency management through a PSPS event.

Figure SCE 8-52a - PSPS Flowchart

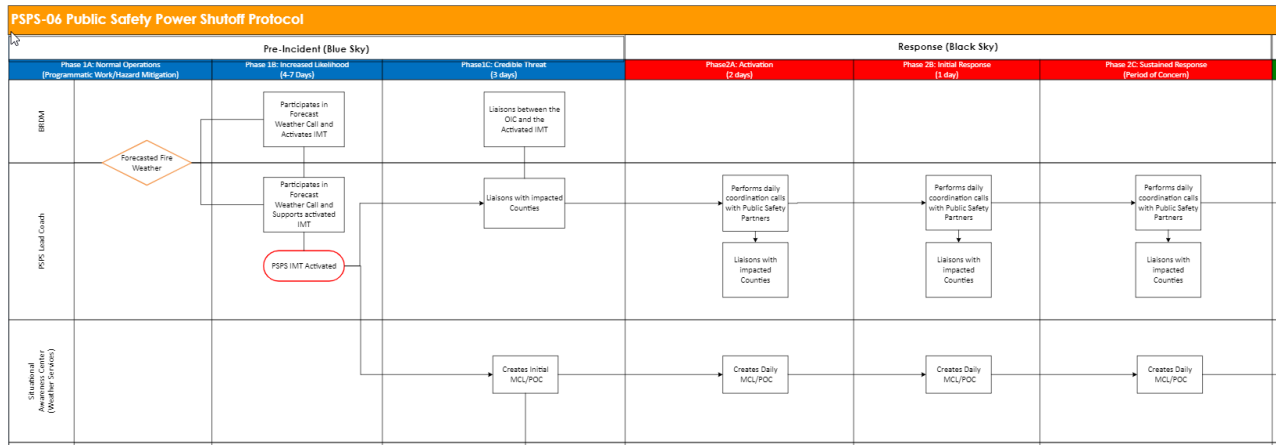

Full chart can be found in Appendix F: Supplemental Information.

Figure SCE 8-52b illustrates the initial phases of emergency management through a wildfire event up to IMT activation.

Figure SCE 8-52b – Wildfire Incident Process Through IMT Activation

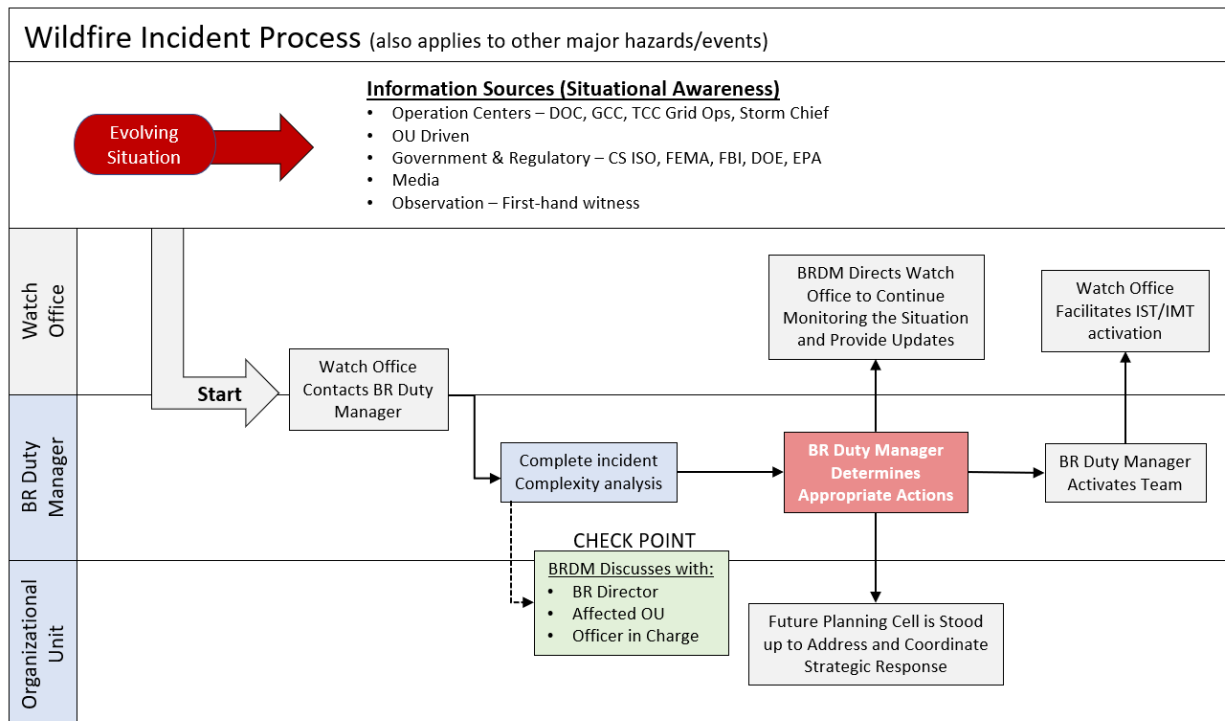
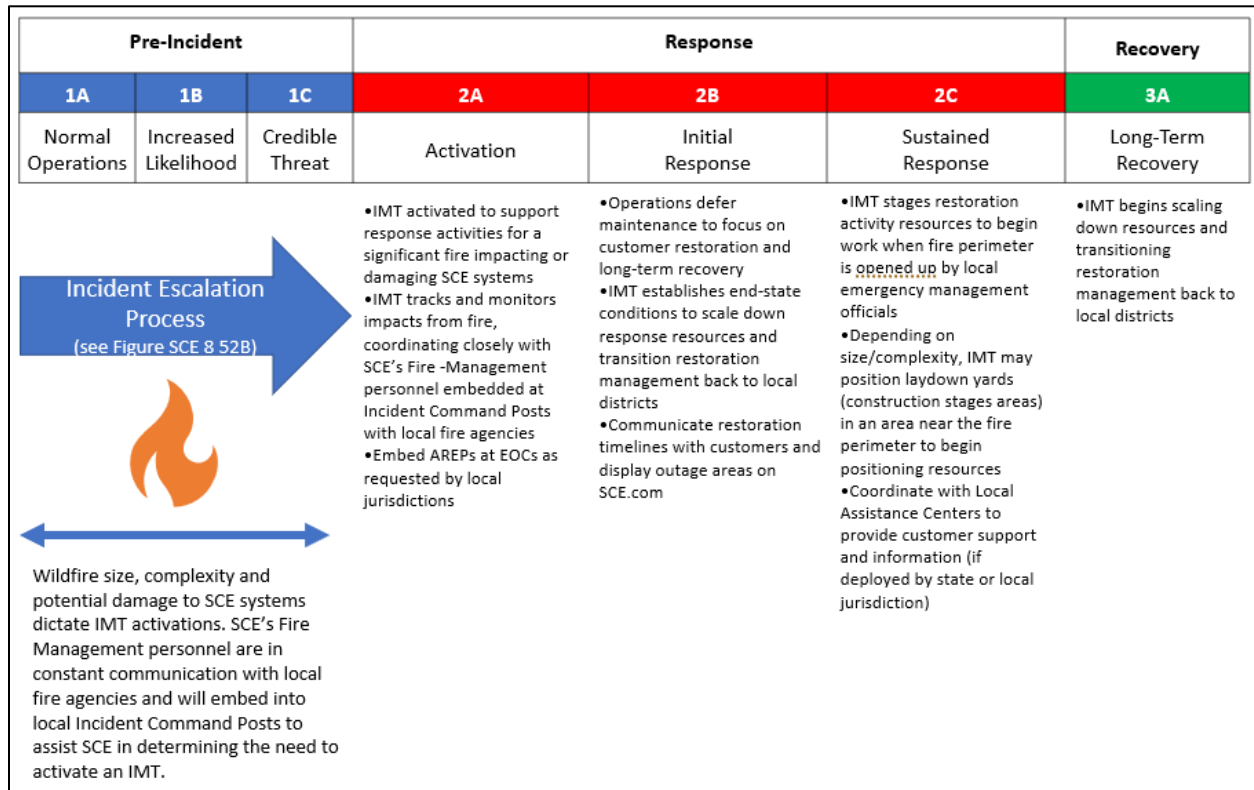

Figure SCE 8-52c illustrates the phases of emergency management through a wildfire event. SCE notes that these steps also apply to hazards generally, and that SCE continually evaluates its response practices and may adjust as needed.

Figure SCE 8-52c – Wildfire Incident Response Phases



Key personnel, qualifications, and training.

All-Hazards IMT and IST teams include qualified personnel from across the company whose emergency management roles use complimentary skills and capabilities to those used in their “blue sky” roles. For example, the Finance Section chief could be filled by someone in SCE’s Financial organization. These team members acquire and master proficiency at emergency response through independent and instructor-led classes, exercises, and feedback. Their participation in the IMT program is evaluated as part of their annual year-end performance review. Small teams of trained individuals are qualified for leadership roles. Support roles have deeper rosters, and these “pooled” team members are on call one week out of every four or six weeks.

PSPS IMT teams include dedicated team membe

rs whose blue-sky functions are to develop, train, and manage the PSPS program year-round. These dedicated leads are responsible for training and managing the pooled PSPS teams.

Team members are required to take on-line training through FEMA’s Emergency Management Institute (EMI) & California Specialized Training Institute (CSTI). These independent study courses provide a fundamental understanding of emergency management principles and concepts. SCE requires the following as prerequisites to classroom training:

- IS 100.c – Introduction to ICS

- IS 200.c – ICS for Single Resources & Initial Action
- IS 700.b – National Incident Management
- IS 800.d – National Response Framework, an Introduction

CSTI- certified instructors conduct the classroom training required for IST and IMT qualification. Course materials include materials pertinent to the electric utility industry as well as training for situations unique to SCE and meet national Incident Management standards. Some courses include information on SCE-specific plans or relevant technology, such as Web EOC.

Team members are required to take ICS 300 - Intermediate ICS for Expanding Incidents. IST members must complete ICS 400 after completing ICS 300.

Once training is complete, team members demonstrate proficiency in their position under the direct supervision of a fully qualified team member in their role during a functional exercise or real-world activation. Collectively, IS online and ICS classroom training and exercise/activation components are the minimum qualification requirements needed to build a baseline capability for responding to incidents. Additional familiarity and skill development take place through formal and informal learning opportunities provided throughout the year.

SCE also requires SEMS G606 (Standardized Emergency Management System Introduction Online Course) as an online course for IMT, IST, Pool Positions, and PSPS IMTs personnel. Selected IMT/IST positions also require G197 (G197 Integrating Access & Functional Needs into Emergency Management).

Each year SCE requires that all IMT, IST and pooled positions go through requalification to maintain a basic level of familiarity with their position and build on their knowledge, skills, and abilities. SCE reviews qualification requirements annually and communicates any changes out to all IMT/IST members through a cross-OU committee with representatives from all teams that are matrixed to the IMT. To maintain qualification, a member must complete the following:

- Position Specific User Group Training
- IMT/IST Requalification Training

Dedicated PSPS team members are required to attend an annual PSPS-position specific training and an exercise.

Resource planning and allocation (e.g., staffing).

Within one hour of the identification of a major outage or other emergency situation, SCE will coordinate internal resources.

When the Business Resiliency Duty Manager (BRDM) receives information that could potentially lead to an activation, analysis is applied to determine the severity of the incident and how the company should respond. The Complexity Analysis Tool is utilized to provide a standardized and rapid quantitative assessment regarding incident severity level. Severity level determines the course of action when leveraging company resources required to respond commensurate to the incident complexity.

The criteria in the Complexity Analysis tool determines the severity level of an incident and drives

activation decisions for an IMT/IST. The criteria in the Complexity Analysis is evaluated by the IC and BRDM regularly throughout an activation to assess appropriate staffing levels. This will drive a more gradual and methodical approach to both escalation and de-escalation of resources and ultimately demobilization of an IMT.

Drills, simulations, and tabletop exercises.

SCE Exercise and Evaluation Program

To foster exercise-related interoperability and collaboration, SCE has adapted the Department of Homeland Security Exercise and Evaluation Program (HSEEP), which was developed to provide an overview of exercise, development, conduct, evaluation, and improvement planning process. In alignment with HSEEP, SCE identifies gaps and lessons learned from exercises to improve the process over time. As part of this improvement process, an Integrated Preparedness Plan is developed to establish a strategy and structure for the exercise program to verify preparedness efforts are met, while setting the foundation for the planning, conduct, and evaluation of individual exercises.

Exercise Planning

HSEEP provides a set of guiding principles for exercise and evaluation programs, as well as a common approach to exercise program management, design and development, conduct, and improvement planning.

By incorporating the HSEEP process, SCE develops, executes, and evaluates exercises that address company preparedness priorities. These priorities are informed by hazards, capability assessment findings, corrective actions from previous events, and external requirements. These priorities guide the overall direction of the exercise program and the design and development of individual exercises. These priorities also guide planners as they identify exercise objectives and align them to capabilities for evaluation during the exercise.

SCE invites Public Safety Partners to observe and participate in emergency exercises to foster a high level of coordination and collaboration. Please see Table 8-41.

Coordination and collaboration with public safety partners (e.g., emergency planning, interoperable communications).

Annually, SCE coordinates emergency preparations with state, county, and local agencies, as well as Essential Customers who are defined in General Order 166 as “Customers representing critical infrastructure and Public Safety Partners.” As part of this activity, SCE has a process for confirming and maintaining contacts and communication channels.

SCE’s plan development process includes considerations and lessons learned from recent incidents and events, coordination, and consultation with key internal and external stakeholders, and follows a regular annual update and maintenance cycle, in accordance with CPUC GO-166 standards. Following emergency activations, SCE reviews that the activation and escalation standards are clear and appropriate in the plan. In addition, every two years, SCE invites local government representatives to provide consultation as the plan is updated as well as the opportunity to comment on draft plans.

SCE maintains multiple contacts for each local government potentially impacted by service interruptions

and requests that local governments provide a list of officials to be notified (i.e., Public Safety Partners, agency management, and elected officials) about service interruptions. SCE performs annual communications tests in advance of the peak wildfire season as requested by the Commission and defined by the California Department of Forestry and Fire Protection.

Notification of and communication to customers during and after a wildfire or PSPS event.

The objective of SCE's notification strategy is to provide State Agencies, Public Safety Partners, critical infrastructure and facilities providers, customers (including those with access and functional needs), and all interested stakeholders with accessible, actionable, and easy to understand information. For PSPS, this includes information provided before, during, and after events that may impact them.

SCE has established a messaging protocol that complies with all standard emergency alerting and warning protocols.

The Emergency Outage Notifications System (EONS) is the primary tool used to keep customers informed before, during, and after PSPS events. EONS allows SCE to communicate to all customer classes (receiving under 66kv power) impacted by PSPS via email, voice calls, and/or SMS. PSPS notification translations are available in 23 languages.

Please refer to Section 8.5.2 Public Outreach and Education Awareness Program for information on additional communications with customers.

Improvements/updates made since the last WMP submission.

SCE's All Hazards Plan development process includes considerations and lessons learned from recent incidents and events, coordination, and consultation with key internal and external stakeholders, and follows a regular annual update and maintenance cycle, in accordance with CPUC GO-166 standards. The current All Hazards Plan is dated December 2022 and includes additions and modifications. Please see Section 8.4.2.4 for additional information on updates and modifications made to the plan in recent years.

The overview must be no more than six pages.

In addition, the electrical corporation must provide a table with a list of current gaps and limitations in evaluating, developing, and integrating wildfire- and PSPS-specific preparedness and planning features into its overall emergency preparedness plan(s). Where gaps or limitations exist, the electrical corporation must provide a remedial action plan and the timeline for resolving the gaps or limitations. Table 8-37 provides an example of the minimum level of content and detail required.

Below is a summary of SCE's gaps and limitations in integrating wildfire and PSPS planning into emergency planning.

Table 8-37 - Key Gaps and Limitations in Integrating Wildfire- and PSPS-Specific Strategies into Emergency Plan

Gap or Limitation Subject	Remedial Brief Description	Remedial Action Plan
Training	SCE continues to mature training and exercises based on lessons learned within after action reports from exercises and real-world incidents. SCE’s annual readiness activities for IMT resources who respond to PSPS events through training and exercises is based on HSEEP’s improvement cycle approach.	The training and exercise program continually updates and improves training and exercises to incorporate changes to procedures and tools used for activations. Target timeline: SCE will conduct a PSPS Full-Scale Exercise in 2023, increasing complexity from the 2022 Functional Exercise.
After-action report reviews	After action reports are conducted after all PSPS exercises and real-world events to evaluate lessons learned and areas of improvement.	These reports are then translated into formal corrective actions that are tracked and monitored through completion. Target timeline: Exercise After Action reports are published as part of the annual July 1 readiness deadline and real-world incident After Action reports are produced within 2 weeks of an incident.

8.4.2.2 Key Personnel, Qualifications, and Training

In this section, the electrical corporation must provide an overview of the key personnel constituting its emergency planning, preparedness, response, and recovery team(s) for wildfire and PSPS events. This includes identifying key roles and responsibilities, personnel resource planning (internal and external staffing needs), personnel qualifications, and required training programs.

Personnel Qualifications

The electrical corporation must report on the various roles, responsibilities, and qualifications of electrical corporation and contract personnel tasked with wildfire emergency preparedness planning, preparedness, response, and recovery, and those tasked for PSPS-related events. This may include representatives from administration, information technology (IT), human resources, communications, electrical operations, facilities, and any other mission-critical units in the electrical corporation. As part of this section, the electrical corporation must provide a brief narrative describing its process for planning to meet its internal and external staffing needs for emergency preparedness planning, preparedness, response, and recovery related to wildfire and PSPS. The narrative must be no more than two to four pages.

SCE utilizes the Incident Command System (ICS) structure to guide its activations, exercises, and its planning process. The flexibility of ICS means it can be adapted for incidents and events of any type, scope, and complexity. It allows its users to adopt an integrated organizational structure that matches the complexities and demands of single or multiple incidents or events.

ICS allows for a scalable response. If a disruption is a localized, single incident in one functional area, only one IMT activates. If multiple incidents occur multiple IMTs may activate as well as an IST to coordinate the overall response and recovery activities and manage resource requirements between the IMTs.

A single IMT is typical for situations of limited scope. Additional IMTs and an IST activate for complex incidents with multiple impacts. In the event of a complex incident requiring a response by more than one IMT and coordination of those teams, the individual incident commanders adopt a Unified Command structure with all involved IMTs organized into a single team. The IST Incident Commander (IC) leads the unified command effort, and the teams work under a single set of objectives and one incident action plan.

SCE utilizes Area Command as an organizational approach for management of multiple incidents or during large incidents that cross jurisdictional boundaries. Area Command is typical for when an incident calls for a coordinated response, with large-scale coordination necessary at a higher jurisdictional level. SCE will typically organize under Area Command when a single functional business line is affected by multiple incidents across the SCE Service Territory.

SCE established a SEMS, NIMS and ICS compliant incident management structure built around Incident Management Teams (IMTs). An IMT is a group of trained personnel from different SCE organizational units called on to lead a response to an emergency or incident. IMTs typically activate for incidents expected to last longer than a day and requiring coordinated planning and resource allocation within a specific functional area. One primary IMT is:

- **Public Safety Power Shutoff (PSPS) IMT** activates when conditions are projected to meet established thresholds (combination of fuel conditions and weather). The PSPS IMT is led by a dedicated team of subject matter experts who manage each of the key positions on the team. Other supplemental team members are activated to fill out teams and to spell dedicated team members for additional shifts. In cases such as the PSPS IMT, having a dedicated team supports consistent decision making, deeper PSPS-specific experience, and greater ability to support continuous improvements and planning during non-event periods.

Among many responsibilities, these teams make de-energization recommendations, communicate potential outages with public safety partners and customers, manage company notification activities, re-energization activities and notifications. All de-energization decisions are authorized by the incident commander. In addition, these teams are responsible for maintaining communications with state/county representatives as required by California State Public Utilities Commission. Subject Matter Experts from across the company can be activated as Technical Specialists to support IMTs.

Initial Qualification

Team members are required to take on-line training through FEMA's Emergency Management Institute (EMI) & California Specialized Training Institute (CSTI). These independent study courses provide a fundamental understanding of emergency management principles and concepts. While there are several hundred different independent study courses available, SCE only requires the following as prerequisites to classroom training:

- IS 100.c – Introduction to ICS
- IS 200.c – ICS for Single Resources & Initial Action
- IS 700.b – National Incident– Management
- IS 800.d – National Response Framework, an Introduction

CSTI certified instructors conduct the classroom training required for IST and IMT qualification. Course materials include activities unique to SCE and the electric utility industry and meet national ICS standards. Some courses include information on SCE-specific plans or technology such as Web EOC.

Team members are required to take ICS 300 - Intermediate ICS for Expanding Incidents. IST Members must complete ICS 400 after completing ICS 300.

Once training is complete, team members must demonstrate proficiency in their position under the direct supervision of a fully qualified team member during a functional exercise or real-world activation. Collectively, ICS online and classroom training, and exercise/activation components are the minimum qualification requirements needed to build a baseline capability for responding to incidents. Additional familiarity and skill development will continue to take place through formal and informal learning opportunities provided throughout the year.

SCE also requires SEMS G606 online for IMT, IST, Pool Positions and PSPS IMTs personnel

- SEMS G606 - Standardized Emergency Management System Introduction Online Course
- For selected IMT/IST positions SCE will also require G197 Integrating Access & Functional Needs into Emergency Management Training

Requalification

Each year SCE requires that all IMT, IST and pooled positions go through requalification to maintain a

basic level of familiarity with their position and build on their knowledge, skills, and abilities. SCE will annually review qualification requirements and communicate any changes to all IMT/IST members through the matrix. To maintain qualification a member must complete the following:

- Positions Specific User Group Training
- IMT/IST Requalification Training

Public Safety Power Shutoff Incident Management Teams, PSPS Task Force and PSPS Dedicated Team are required to attend an annual PSPS position specific training and an exercise.

8.4.2.2.1 Emergency Response Training (DEP-2)

SCE maintains a robust and highly skilled workforce (both employees and contractors) to provide effective emergency response and restore service during and after a major event. SCE develops technical training programs that prepare employees to perform their jobs safely, comply with regulatory requirements and laws, maintain system reliability, and leverage new technology. SCE conducts specific training on an annual basis to adequately train employees and field workers responsible for restoration of power after emergencies.

SCE also provides specialized training on an annual basis for PSPS IMT members, who oversee and execute de-energization and restoration protocols. For the purposes of DEP-2, SCE is tracking training compliance against core PSPS positions as indicated in Table 8-38.

Below is a summary of SCE's emergency preparedness staffing and qualifications.

Table 8-38 - Emergency Preparedness Staffing and Qualifications

Role	Incident Type	Responsibilities	Qualifications	No. of Dedicated Staff Required	No. of Dedicated Staff Provided	No. of Contract Workers Required	No. of Contract Workers Provided
PSPS Incident Commander	PSPS	<ul style="list-style-type: none"> Approves monitored circuit list Approves circuits for de-energization and re-energization Directs mitigation strategies for potential public safety concerns and at-risk customers Works with IMT to determine resource requirements for staffing and equipment 	ICS 100, 200, 700, 800, 300, Position Specific Training, Qualifying Exercise or Shadow Activation	9	9	N/A	N/A
PSPS Operations Section Chief	PSPS	<ul style="list-style-type: none"> Responsible for providing situational awareness to the IMT Incident Commander, and supervising all operational actions, air operations and customer care functions 	ICS 100, 200, 700, 800, 300, Position Specific Training, Qualifying Exercise or Shadow Activation	7	7	N/A	N/A
PSPS Task Force (Substation Tech Spec, GCC Liaison, PSPS Analyst, Transmission Tech Spec, Distribution Tech Spec, Operations Compliance Tech Spec)	PSPS	<ul style="list-style-type: none"> Recommends de-energization and re-energization decisions and manages field resources and circuit situational awareness 	ICS 100, 200, 700, 800, 300, Position Specific Training, Qualifying Exercise or Shadow Activation	60	60	N/A	N/A
Customer Care Branch (Customer Care Branch Director, Customer Notifications Group, Access and Functional Needs Group, Customer Outreach)	PSPS	<ul style="list-style-type: none"> Responsible for customer programs including notifications, customer care resources and the needs of the AFN community 	ICS 100, 200, 700, 800, 300, Position Specific Training, Qualifying Exercise or Shadow Activation	217	217	N/A	N/A
Planning Section Chief	PSPS	<ul style="list-style-type: none"> Coordinates across IMT to establish incident response tempo and situational awareness consistency 	ICS 100, 200, 700, 800, 300, Position Specific Training, Qualifying Exercise or Shadow Activation	16	16	N/A	N/A

Personnel Training

The electrical corporation must report on its internal personnel training program(s) for wildfire and PSPS emergency events. This training must include, at a minimum, training on relevant policies, practices, and procedures before, during, and after a wildfire or PSPS event. The reporting must include, at a minimum:

- *The name of each training program*
- *A brief narrative on the purpose and scope of each program*
- *The type of training method*
- *The schedule and frequency of training programs*
- *The percentage of staff who have completed the most current training program*
- *How the electrical corporation tracks who has completed the training programs Table 8-39 provides an example of the minimum acceptable level of information.*

External Contractor Training

The electrical corporation must report on its external contractor training program(s) for wildfire and PSPS emergency events. This training must include, at a minimum, training on relevant policies, practices, and procedures before, during, and after a wildfire or PSPS event. The reporting must include, at a minimum:

- *The name of each training program*
- *A brief narrative on the purpose and scope of each program*
- *The type of training method*
- *The schedule and frequency of training programs*
- *The percentage of contractors who have completed the most current training program*
- *How the electrical corporation tracks who has completed the training programs*

SCE does not provide training to its Contract Field Workforce and instead, provides Orientation via Train the Trainer sessions with contractor Supervisors on PSPS patrolling and Live Field Observations protocols, and any updates since prior year; contractor Supervisors train their own field crews and submits attendance rosters to SCE.

Table 8-40 provides an example of the minimum acceptable level of information.

Below is a summary of SCE's Emergency Preparedness training programs.

Table 8-39 - Electrical Corporation Personnel Training Program

Training Topic	Purpose and Scope	Training Method	Training Frequency	Position or Title of Personnel Required to Take Training	# Personnel Requiring Training	# Personnel Provided with Training	Form of Verification or Reference
IS 100, 200, 700, 800	Incident command system fundamentals and basics. Standard training introducing personnel to the concepts of organized emergency response	Web Based Training via FEMA	Initial qualification – persons take once	All IMT / IST personnel	N/A - All IMT members	N/A - All active duty personnel rostered for an IMT	IMT Training materials and Attendance Rosters
ICS 300	ICS-300 provides an in-depth focus on the NIMS Incident Command System (ICS) that includes the tools, practices, and procedures that are available in ICS to effectively manage emergency incidents or planned local events at a local Type 3 level. Expanding upon ICS-100 and -200, this course ensures that responders understand the basic ICS concepts that allow an incident management organization to expand and contract as needed to fit the incident and maintain its operational effectiveness	Instructor Led Training	Initial qualification – persons take once	All IMT / IST personnel	N/A - All IMT members	N/A - All active duty personnel rostered for an IMT	IMT Training materials and Attendance Rosters
PSPS Position Specific Training	These courses provide IMT and IST members with an understanding of the position-specific duties, responsibilities, and capabilities of their positions. The courses provide information on their role and information on how to successfully execute on their role during all types of incidents. PSPS Position/Function Specific:	Instructor Led Training	Initial qualification – persons take once	All personnel assigned to a PSPS IMT	N/A - All PSPS IMT members	N/A - All active duty personnel rostered for a PSPS IMT	IMT Training materials and Attendance Rosters
PSPS General Training	Provide hazard-specific information to personnel based on the PSPS response plan, specifically review the interdependencies of the different positions on the team and how the key functions are executed in PSPS incidents and activations.	Virtual	Annually	All personnel assigned to a PSPS IMT	N/A - All PSPS IMT members	N/A - All active duty personnel rostered for a PSPS IMT	IMT Training materials and Attendance Rosters

Below is a summary of SCE's Emergency Preparedness contractor training programs.

Table 8-40 - Contractor Training Program

Training Topic	Purpose and Scope	Training Method	Training Frequency	Position or Title of Personnel Required to Take Training	# Contractors Requiring Training	# Contractors Completed Training	Form of Verification or Reference
PSPS Patrolling & Live Field Observation (LFO) Orientation for Contractors	Provide awareness of: <ul style="list-style-type: none"> • The Wildfire Mitigation Plan (WMP) • PSPS Incident Management • Circuit Switch Plans (to minimize customer impact) • Updates to "Operation of Circuits Traversing High Fire Risk Areas" procedure • Patrolling scenarios under various operating conditions • Timing of LFO deployment • PSPS Field Tools (PSPS Patrol Form) • Communication protocols when hazardous conditions exist • Various Patrolling Scenarios 	Train the Trainer	Annually	Line Contract Worker	576	576	Training materials and Attendance Rosters

8.4.2.3 Drills, Simulations, and Tabletop Exercises

Discussion-based and operational-based exercises enhance knowledge of plans, allow personnel to improve their own performance, and identify opportunities to improve capabilities to respond to real wildfire emergency events and PSPS events. Exercises also provide a method to evaluate an electrical corporation's emergency preparedness plan and identify planning and/or procedural deficiencies.

Internal Exercises

The electrical corporation must report on its program(s) for conducting internal discussion-based and operations-based exercises for both wildfire and PSPS emergency events. This must include, at a minimum:

- The types of discussion-based exercises (e.g., seminars, workshops, tabletop exercises, games) and operations-based exercises (e.g., drills, functional exercises, full-scale exercises)*
- The purpose of the exercises*
- The schedule and frequency of exercise programs*
- The percentage of staff who have completed/participated in exercises*
- How the electrical corporation tracks who has completed the exercises.*

Table 8-41 provides an example of the minimum acceptable level of information.

External Exercises

The electrical corporation must report on its program(s) for conducting external discussion-based and operations-based exercises for both wildfire and PSPS emergency events. This must include, at a minimum:

- The types of discussion-based exercises (e.g., seminars, workshops, tabletop exercises, games) and operations-based exercises (e.g., drills, functional exercises, full-scale exercises)*
- The schedule and frequency of exercise programs*
- The percentage of public safety partners who have participated in these exercises*
- How the electrical corporation tracks who has completed the exercises*

Table 8-42 provides an example of the minimum acceptable level of information.

External agencies and jurisdictions maintain responsibility for developing and delivering their own exercise programs. Therefore, SCE does not run an external exercise program. Where appropriate, SCE coordinates exercises with external agencies or invites external participation in SCE exercises when the scenario and objectives overlap with external partner agencies. SCE also sends personnel to external exercises when invited to participate.

Below is a summary of SCE’s Emergency Preparedness internal exercise programs.

Table 8-41 - Internal Drill, Simulation, and Tabletop Exercise Program

*External agencies and jurisdictions invited to participate in this exercise.

Category	Exercise Title and Type	Purpose	Exercise Frequency	Position or Title of Personnel Required to Participate	# Personnel Participation Required	# Personnel Participation Completed	Form of Verification or Reference
Discussion Based	Tabletop Exercise	Provide awareness and understanding of roles and responsibilities, existing documentation, policies, and procedures.	Annually	PSPS IMT Positions	Varies	Varies	Situation Manual, Registration Sheets
Operations Based	Drill	Provide awareness and understanding of roles and responsibilities, and how to execute on discrete tasks and actions.	As Needed	Targeted IMT positions as identified via the exercise planning process	Varies	Varies	Situation Manual, Registration Sheets
Operations Based	Functional Exercise	Demonstrate an ability to successfully execute roles and responsibilities of an IMT through a set period of time and incident response. Confirm positions are able to successfully work across incident response functions and work as a team in support of objectives.	Annually	PSPS IMT positions	Varies	Varies	Exercise Plan, Registration Sheets
Operations Based	Full Scale Exercise*	Successfully work across multiple levels of response to execute on roles and responsibilities in an incident. Demonstrate ability to work across complex systems and in response to a significant, high-impact scenario.	As Needed	PSPS IMT positions	Varies	Varies	Exercise Plan, Registration Sheets

Below is a summary of SCE’s Emergency Preparedness external exercise programs.

Table 8-42 - External Drill, Simulation, and Tabletop Exercise Program

Category	Exercise Title and Type	Purpose	Exercise Frequency	Position or Title of Personnel Required to Participate	# Personnel Participation Required	# Personnel Participation Completed	Form of Verification or Reference
Please see Section 8.4.2.3 External Exercises for additional information							

8.4.2.4 Schedule for Updating and Revising Plan

The electrical corporation must provide a log of the updates to its emergency preparedness plan since 2019 and the date of its next planned update.

Updates should occur every two years, per R. 15-06-009 and D. 21-05-019. For each update, the electrical corporation must provide the following:

- *Year of updated plan*
- *Revision type (e.g., addition, modification, elimination)*
- *Component modified (e.g., communications, training, drills/exercises, protocols/procedures, MOAs)*
- *A brief description of the lesson learned that informed the revision*
- *A brief description of the specific addition, modification, or elimination Table 8-43 provides an example of the minimum acceptable level of information.*

Below is a summary of updates to SCE's Emergency Preparedness plans.

Table 8-43 - Wildfire-Specific Updates to the Emergency Preparedness Plan

ID #	Year of Updated Plan	Revision Type	Lesson Learned	Revision Description	Reference Section
1	2021 AHP	Creation	Consolidated and expanded various annexes/response plans into an All-Hazards Plan	Creation of AHP	Entire document
2	2021 AHP	Creation	GO 166 standards and criteria	Inclusion of GO 166 standards and criteria	Reference Table; Chapters 2, 5 and Annual Filing
3	2021 AHP	Creation	Organization response information, including national and state guidelines (NIMS, SEMS)	Inclusion of NIMS and SEMS guidelines	Section 1: Purpose and Scope; Chapter 3: Organization; Chapter 4: Preparedness
4	2022 AHP	Addition	Proactive development of the AHP	Expansion of damage assessment, situational awareness, and restoration prioritization concepts of operation	Chapter 5: Concept of Operations
5	2022 AHP	Addition	Proactive development of the AHP	Incorporation of FERC Standards of Conduct	Appendix C
6	2022 AHP	Addition	Proactive development of the AHP	Inclusion of Macro Messaging	Appendix B
7	2022 AHP	Addition	Further clarification for GO 166 requirements stemming from internal self-assessment	Added detail for GO166 compliance areas such as post event data requirements for Call Center and Customer Average Interruption Duration Index (CAIDI)	Chapter 5: Major Outage and Restoration Estimate Communication
8	2022 AHP	Addition	Proactive development of the AHP	Inclusion of Major Outage criteria and Storm definitions	Chapter 2: Storm Conditions, Major Outages, and Measured Events
9	2022 PSPS Protocol	Modification	Proactive development of PSPS Protocol	<ul style="list-style-type: none"> Plan language updated to reflect relevant changes to PSPS protocols and IMT positions Organizational chart updated Hyperlinks to processes and procedures in the body of the document removed Formatting changes for plan cohesion and flow 	Overall document
10a	2022 PSPS Protocol	Modification	Proactive development of PSPS Protocol	Added introduction section to address alignment with SEMS/NIMS	Introduction
10b	2022 PSPS Protocol	Modification	Proactive development of PSPS Protocol	<ul style="list-style-type: none"> Minor revisions for cohesion and flow; added Concurrent Emergencies Minor revisions for formatting and updated IMT roles Substantive revisions to include the Centralized Data Platform and iPEMS systems 	<ul style="list-style-type: none"> Section 6 Section 8 Section 9

<i>ID #</i>	<i>Year of Updated Plan</i>	<i>Revision Type</i>	<i>Lesson Learned</i>	<i>Revision Description</i>	<i>Reference Section</i>
10c	2022 PSPS Protocol	Modification	Proactive development of PSPS Protocol	<ul style="list-style-type: none"> • Added link to PSPS Process Flow • Renamed Attachments • Updated Attachment C: IMT Organizational Structures • Updated Attachment D: High Fire Risk Area (HFRA) Map 	Attachments

8.4.3 External Collaboration and Coordination

8.4.3.1 Emergency Planning

In this section, the electrical corporation must provide a high-level description of its wildfire and PSPS emergency preparedness coordination with relevant public safety partners at state, county, city, and tribal levels within its service territory. The electrical corporation must indicate if its coordination efforts follow California's SEMS or, where relevant for multi-jurisdictional electrical corporations (e.g., PacifiCorp), the Federal Emergency Management Agency (FEMA) National Incident Management Systems (NIMS), as permitted by GO 166. The description must be no more than a page.

SCE uses the California Standardized Emergency Management System (SEMS) and the Federal National Incident Management System. Emergency events are managed using the Incident Command System through an Emergency Operations Center (or virtual EOC as required).

Depending on the circumstances, one or multiple Incident Management Teams may be activated. For more complex incidents, including concurrent emergencies, an Incident Support Team may be activated to manage the totality of the incident including prioritization and resource allocation. The IST will direct all aspects of communications and outreach including coordination with external agencies and first responders.

SCE maintains multiple contacts for each local government potentially impacted by service interruptions. SCE requests that local governments provide a list of officials to be notified (i.e., Public Safety Partners, agency management, and elected officials) about service interruptions. SCE performs an annual communications test in advance of the peak wildfire season as requested by the Commission and defined by the California Department of Forestry and Fire Protection.

During an EOC activation, SCE shares incident related information and timely notifications with public safety partners through the incident Liaison Officer and other SCE designees (Customer Support Branch Director, Regulatory Affairs Technical Specialist) tasked with coordination/notification of public safety partners.

The Command and General Staff provide interface between SCE and public sector emergency management and elected officials. Interface with public sector emergency management and elected officials is primarily conducted through the IST/IMT Liaison Officers and SCE Agency Representatives. As part of external coordination, SCE establishes two-way communication during an incident to share incident status, restoration strategies, and priorities.

In addition, the electrical corporation must provide the following information in tabular form, with no more than one page of information in the main body of the WMP and a full table, if needed, in an appendix:

List of relevant state, city, county, and tribal agencies within the electrical corporation's service territory and key point(s) of contact, with associated contact information. Where necessary, contact information can be redacted for the public version of the WMP.

For each agency, whether the agency has provided consultation and/or verbal or written comments in preparation of the most current wildfire- and PSPS-specific emergency preparedness plan. If so, the electrical corporation should provide the date, time, and location of the meeting at which the agency's feedback was received.

For each agency, whether it has an MOA with the electrical corporation on wildfire and/or PSPS emergency preparedness, response, and recovery activities. The electrical corporation must provide a brief summary of the MOA, including the agreed role(s) and responsibilities of the external agency before, during, and after a wildfire or PSPS emergency.

In a separate table, a list of current gaps and limitations in the electrical corporation's existing collaboration efforts with relevant state, county, city, and tribal agencies within its territory. Where gaps or limitations exist, the electrical corporation must indicate the remedial action plan and the timeline for resolving the gaps or limitations.

For all requested information, a form of verification that can be provided upon request for compliance assurance.

The electrical corporation must reference the Utility Initiative Tracking ID where appropriate.

Table 8-44 and Table 8-45 provide examples of the minimum level of content and detail required.

Below is a summary of contacts and collaboration SCE maintains with State and local agencies. This table is provided in full within the supporting documents folder at <https://www.sce.com/safety/wild-fire-mitigation>.

Table 8-44 - State and Local Agency Collaboration(s)

Name of State or Local Agency	Point of Contact and Information Confidential Information in Accordance with California Law and Regulations			Emergency Preparedness Plan Collaboration – Last Version of Plan Agency Collaborated	Emergency Preparedness Plan Collaboration – Collaborative Role	Memorandum of Agreement (MOA)?	Brief Description of MOA	
Acton Town Council				General WMP Plan and PSPS Protocols	Acton Town Council Concerned About Uptick in Emergency Outages	6/17/2022	N/A	N/A
Adelanto				General WMP Plan and PSPS Protocols	City of Adelanto WMP/Reliability Meeting Schedule	6/9/2022	N/A	N/A
Agoura Hills				General WMP Plan and PSPS Protocols	Wildfire Update	6/21/2022	N/A	N/A
Agua Caliente Band of Cahuilla Indians				General WMP Plan and PSPS Protocols	2022 Circuit Reliability Report sent	N/A	N/A	N/A
Alhambra				General WMP Plan and PSPS Protocols	Alhambra: June 2022 Vice Mayor Andrade-Stadler To Attend 6/29 EOC Tour	6/29/2022	N/A	N/A
Full table is included within the supporting documents folder at https://www.sce.com/safety/wild-fire-mitigation .								

Below is a summary of SCE’s gaps and limitations on collaborations with state and local agencies.

Table 8-45 - Key Gaps and Limitations in Collaboration Activities with State and Local Agencies

Gap or Limitation Subject	Remedial Brief Description	Remedial Action Plan
Resiliency Zones	Back-up generator at Resiliency Zone was not efficiently deployed due to incomplete equipment specifications.	<p>Strategy: SCE will clarify the complete specifications for each of the eight Resiliency Zones so that the specifications are prepared and ready for future deployments</p> <ul style="list-style-type: none"> • Target completion: 2023
External Coordination Calls and Debrief	SCE engages with its emergency management partners at the county and state level by hosting daily coordination calls with impacted agencies. SCE also conducts daily personalized PSPS outreach and engagement calls for both critical infrastructure providers and the AFN community.	<p>Strategy: SCE will evaluate its current strategy for conducting multiple daily operational briefings to identify opportunities to amplify and optimize engagement with public safety partners while reducing possible redundancy. SCE will hold debriefs to capture feedback with CBOs after major incidents.</p> <ul style="list-style-type: none"> • Target timeline: 2023 season

8.4.3.2 Communication Strategy with Public Safety Partners

The electrical corporation must describe at a high level its communication strategy to inform external public safety partners and other interconnected electrical corporation partners of wildfire, PSPS, and re-energization events as required by GO 166 and Public Utilities Code section 768.6. This must include a brief description of the policies, practices, and procedures the electrical corporation adopts to establish appropriate communication protocols with public safety partners for both wildfire- and PSPS-specific incidents to ensure timely, accurate, and complete communications. The electrical corporation must refer to its emergency preparedness plan as needed to provide more detail. The narrative must be no more than two pages.

Please see Section 8.4.2.1 Overview of Wildfire and PSPS Emergency Preparedness and Section 8.5.2.2 Public Outreach and Education Awareness Program for the communication strategy with public safety partners.

As each public safety partner will have its own unique communication protocols, procedures, and systems, the electrical corporation must coordinate with each entity individually. The electrical corporation must summarize the following information in tabulated format:

- *All relevant public safety partner groups (e.g., fire, law enforcement, OES, municipal governments, Energy Safety, CPUC, other electrical corporations) at every level of administration (state, county, city, or tribe) as needed.*
- *The names of individual public safety entities.*
- *For each entity, the point of contact for emergency communications coordination, and the contact information. Information may be redacted as needed.*
- *Key protocols for ensuring the necessary level of voice and data communications (e.g., interoperability channels, methods for information exchange, format for each data typology, communication capabilities, data management systems, backup systems, common alerting protocols, messaging), and associated references in the emergency plan for more details.*
- *Frequency of prearranged communication review and updates.*
- *Date of last discussion-based or operations-based exercise(s) on public safety partner communication.*

In a separate table, the electrical corporation must list the current gaps and limitations in its public safety partner communication strategy coordination. Where gaps or limitations exist, the electrical corporation must indicate the remedial action plan and the timeline for resolving the gaps or limitations. For all requested information, the electrical corporation must indicate a form of verification that can be provided upon request for compliance assurance.

Table 8-46 and Table 8-47 provide examples of the minimum level of content and detail required.

Below is a summary of SCE’s Emergency Preparedness communication procedures with Public Safety Partners.

Table 8-46 - Example of High-Level Communication Protocols, Procedures, and Systems with Public Safety Partners

This table is provided in full within the supporting documents folder at <https://www.sce.com/safety/wild-fire-mitigation>.

* See individual line items for contact information

** Information applies to all rows within entire column

Public Safety Partner Group*	Name of Entity*	Point of Contact and Information*	Key Protocols**	Frequency of Prearranged Communication Review and Update**	Communication Exercise(s): Date of Last Completed**	Communication Exercise(s): Date of Planned Next**
See individual line items in full table	See individual line items in full table	See individual line items in full table	<ul style="list-style-type: none"> • Update contact lists of public safety partners on an ongoing basis • Take actions to address any problems or deficiencies identified during an exercise • Business contact to be sent a message according to enrolled channel preference(es) (SMS, email, call) • Messages sent to inform of potential PSPS events and actual de-energizations and re-energizations: <ul style="list-style-type: none"> • Initial • Update • Expected Shutoff • Shutoff • Imminent Restoration • Restoration • Event Concluded • Undeliverable contacts will be reviewed and updated 	Conduct a minimum of two exercises prior to the WF season		
Full table is included within the supporting documents folder at https://www.sce.com/safety/wild-fire-mitigation .						

Table 8-47 - Key Gaps and Limitations in Communication Coordination with Public Safety Partners

Gap or Limitation Subject	Remedial Brief Description	Remedial Action Plan
Public Safety Portal	Delay between e-mail notifications and data updates being posted on Public Safety Partner Portal.	SCE is in the process of updating portal alert notifications to coincide with data being posted on external platforms. Target timeline: 2023

8.4.3.3 Mutual Aid Agreements

In this section, the electrical corporation must provide a brief overview of the Mutual Aid Agreements (MAA) it has entered into regarding wildfire emergencies and/or disasters, as well as PSPS events. The overview narrative must be no more than one page.

SCE participates in mutual assistance agreements at the State, Regional and National levels.

State-level mutual assistance is requested when SCE identifies that resource requirements will exceed existing capabilities. SCE will coordinate with in-state utilities through the California Utilities Emergency Association (CUEA) to request resource needs. CUEA is responsible for facilitating mutual assistance requirements between requesting and responding utilities.

In the event of statewide resource shortfalls, mutual assistance requests are then escalated to the Western Regional Mutual Assistance Group (WRMAG). WRMAG facilitates mutual assistance coordination at the regional-level between member utilities.

A National Response Event (NRE) is when a natural or man-made event is forecasted to cause or that causes widespread power outages impacting a significant population or several regions across the United States and requires resources from multiple Regional Mutual Assistance Groups (RMAGs). An NRE declaration is made by the Edison Electric Institute and is reserved only for events that may result in a widespread power outage, such as a major hurricane, earthquake, or an act of war, impacting industry's mutual assistance efforts.

8.4.3.3.1 Aerial Suppression (DEP-5)

Due to the limited availability of fire suppression resources available statewide, in 2021 SCE partnered with Los Angeles, Ventura, and Orange Counties to support their proposal to fund the stand-by time of aerial suppression resources to reduce wildfire risk to SCE's system and help protect SCE's infrastructure and communities. SCE established a funding agreement with each fire agency, pursuant to which SCE funded the cost of stand-by time for the helicopters, and each fire agency paid for flight time when the helicopters were used to fight fires.

Operational decisions regarding where and when the assets are used are at the discretion of the individual fire agencies and are prioritized and deployed by a regional fire coordination center, primarily within the SCE service territory. A regional fire agency coordination center maintains responsibility for directing the aerial suppression resources, using their existing prioritization and deployment process.

Starting in December 2022, SCE entered a new funding agreement with Los Angeles, Orange, and Ventura County fire agencies and expand QRF coverage from 165-days to year-round. SCE will continue to monitor funding and access to aerial suppression resources in SCE's service area to determine the need for continued investment in this area. Although the fire suppression assets are intended primarily for use in fighting wildfires in SCE's service territory, SCE relies on the professional judgment of the agencies to inform day to day operations, including determining how and when to deploy the assets.

In addition, the electrical corporation must provide the following wildfire emergency information in tabulated format:

- List of entities with which the electrical corporation has entered into an MAA
- Scope of the MAA
- Resources available from the MAA partner

Table 8-48 provides an example of the minimum level of content and detail required.

Below is a summary of SCE’s mutual aid agreements during wildfire and de-energization events.

Table 8-48 - High-Level Mutual Aid Agreement for Resources During a Wildfire or De-Energization Incident

Mutual Aid Partner	Scope of Mutual Aid Agreement	Available Resources from Mutual Aid Partner
California Utilities Emergency Association Mutual Assistance Agreement (CUEA) - 44 Member Companies	Both: Any storm, disaster, and/or catastrophic incident requiring supplemental resources and/or equipment provided to a private, municipal, and cooperative utility(s) that is a party to the CUEA mutual assistance agreement in support of electrical and gas restoration.	D-Line, T-Line, Substation, Veg Mgmt, DA, Gas, and ICS position-specific resources, and/or associated equipment and materials.
Edison Electric Institute Mutual Assistance Agreement (EEI) - Investor Owned Utilities across the U.S.	Both: Any storm, disaster, and/or catastrophic incident requiring supplemental resources and/or equipment provided to investor owned utility(s) that is a party to the EEI mutual assistance agreement in support of electrical restoration.	D-Line, T-Line, Substation, Veg Mgmt, DA, and ICS position-specific resources, and/or associated equipment and materials.
Western Energy Institute (WEI) - 62 Member Companies	Both: Any storm, disaster, and/or	D-Line, T-Line, Substation, Veg Mgmt, DA, Gas, and ICS

<i>Mutual Aid Partner</i>	<i>Scope of Mutual Aid Agreement</i>	<i>Available Resources from Mutual Aid Partner</i>
	catastrophic incident requiring supplemental resources and/or equipment provided to a private, municipal, and cooperative utility(s) that is a party to the Western Region Mutual Assistance Agreement (WRMAA) in support of electrical and gas restoration.	position-specific resources, and/or associated equipment and materials.
Los Angeles, Ventura, and Orange County Fire Agencies	Wildfire: Funding of stand-by time of aerial suppression resources.	Aerial suppression resources.

8.4.4 Public Emergency Communication Strategy

The electrical corporation must describe at a high level its comprehensive communication strategy to inform essential customers and other stakeholder groups of wildfires, outages due to wildfires, and PSPS and service restoration, as required by Public Utilities Code section 768.6. This should include a discussion of the policies, practices, and procedures the electrical corporation adopts to establish appropriate communication protocols to ensure timely, accurate, and complete communications. The electrical corporation may refer to its Public Utilities Code section 768.6 emergency preparedness plan to provide more detail. The narrative must be no more than one page.

SCE communicates with the public during and immediately following major outages and emergencies. SCE coordinates with various entities and key stakeholders on education, outreach, and feedback in preparation for emergency events which result in any type of outage. This preparedness extends to overall customer resiliency and while it has initially been directed to address PSPS, many of the efforts are also broadly applicable to other extended outages or emergencies.

Additionally, website improvements are being implement for customers to increase awareness of wildfire mitigation activities, receive up to date information regarding events and learn when an event is impacting their area. Website improvements will include digital user testing and research, content audit, end-to-end journey mapping, and user experience design improvements to deliver a simplified user experience for customers.

Please see Section 8.4.2.1 Overview of Wildfire and PSPS Emergency Preparedness and Section 8.5.2.2 Public Outreach and Education Awareness Program for additional information responsive to this prompt.

In the following sections, the electrical corporation must provide an overview of the following components of an effective and comprehensive communication strategy:

- *Protocols for emergency communications*
- *Messaging*
- *Current limitations*

Reference the Utility Initiative Tracking ID where appropriate.

8.4.4.1 Protocols for Emergency Communications

The electrical corporation must identify the relevant stakeholder groups in its service territory and describe the protocols, practices, and procedures used to provide notification of wildfires, outages due to wildfires and PSPS, and service restoration before, during, and after each incident type. Stakeholder groups include, but are not limited to, the general public, priority essential services, AFN populations, populations with limited English proficiency, tribes, and people in remote areas. The narrative must include a brief discussion of the decision-making process and use of best practices to ensure timely, accurate, and complete communications. The narrative must be no more than one page.

Please see Section 8.4.2.1 Overview of Wildfire and PSPS Emergency Management and Section 8.5.2.2 Public Outreach and Education Awareness Program for additional information responsive to this prompt.

The electrical corporation must also provide, in tabular form, details of the following:

- *Communication methods*
- *Message receipt verification mechanisms*

Table 8-49 provides an example of the minimum level of content and detail required.

Below is a summary of SCE's Emergency Preparedness communications.

Table 8-49 - Protocols for Emergency Communication to Stakeholder Groups

Stakeholder Group	Event Type	Method(s) for Communicating	Means to Verify Message Receipt
State agencies	PSPS	Delivers notices in recipient's preferred channel: email, SMS	N/A
Public safety partners	PSPS	Delivers notices in recipient's preferred channel: voice, email, SMS	Information is available as long as customer is signed up to receive notifications and there is an emergency preference alert (Water/wastewater and Communication Sector)
Critical facilities and infrastructure Customers	PSPS	Delivers notices in recipient's preferred channel: voice, email, SMS	Information is available as long as customer is signed up to receive notifications and there is an emergency preference alert
All customers including AFN	PSPS	Delivers notices in recipient's preferred channel: voice, email, SMS	Information is available as long as customer is signed up to receive notifications and there is an emergency preference alert. Verification of notification is only conducted for MBL, Critical Care and Self Certify
Local governments	PSPS	Delivers notices in recipient's preferred channel: email, SMS	N/A
Tribal governments	PSPS	Delivers notices in recipient's preferred channel: email, SMS	Recipient can acknowledge receipt of email
First responders	PSPS	Delivers notices in recipient's preferred channel: email, SMS	Recipient can acknowledge receipt of email
Non-customers who signed up for alerts and all other parties	PSPS	Address level alerts: email, SMS and voice Public Safety Portal, SCE.com, social media	Information is available as long as non-account holder is signed up in the address level alert portal hosted by vendor Message Broadcast.
State agencies	Maintenance or Repair Outage related to Wildfire	Delivers notices in recipient's preferred channel: voice, email, SMS	N/A
Public safety partners	Maintenance or Repair Outage related to Wildfire	Delivers notices in recipient's preferred channel: voice, email, SMS	N/A
Local governments	Maintenance or Repair Outage related to Wildfire	Delivers notices in recipient's preferred channel: voice, email, SMS	N/A
Tribal governments	Maintenance or Repair Outage related to Wildfire	Delivers notices in recipient's preferred channel: voice, email, SMS	N/A
First responders	Maintenance or Repair Outage related to Wildfire	Delivers notices in recipient's preferred channel: voice, email, SMS	N/A
Essential Use Customers	Repair Outage related to Wildfire	Delivers notices in recipient's preferred channel: voice, email, SMS	Verification of receipt of voice communication
Major Customers	Repair Outage related to Wildfire	Delivers notices in recipient's preferred channel: voice, email, SMS	Verification of receipt of Voice communication
All customers including Medical Baseline and Critical Care	Repair Outage related to Wildfire	Delivers notices in recipient's preferred channel: voice, email, SMS	Verification of receipt of Voice communication
Unassigned/Residential	Repair Outage related to Wildfire	Delivers notices in recipient's preferred channel: voice, email, SMS	Only able to verify receipt of Voice communication
Essential Use Customers	Wildfire – As needed communication	Delivers notices in recipient's preferred channel: voice, email, SMS	Information is available as long as customer is signed up to receive notifications and there is an emergency preference alert

Stakeholder Group	Event Type	Method(s) for Communicating	Means to Verify Message Receipt
Major Customers	Wildfire – As needed communication	Delivers notices in recipient’s preferred channel: voice, email, SMS	Information is available as long as customer is signed up to receive notifications and there is an emergency preference alert
All customers including Medical Baseline and Critical Care	Wildfire – As needed communication	Delivers notices in recipient’s preferred channel: voice, email, SMS	Information is available as long as customer is signed up to receive notifications and there is an emergency preference alert
Unassigned/Residential	Wildfire – As needed communication	Delivers notices in recipient’s preferred channel: voice, email, SMS	Information is available as long as customer is signed up to receive notifications and there is an emergency preference alert

8.4.4.2 Messaging

In this section, the electrical corporation must describe its procedures for developing effective messaging to reach the largest percentage of stakeholders in its service territory before, during, and after a wildfire, an outage due to wildfire, or a PSPS event.

In addition, the electrical corporation must provide an overview of the development of the following aspects of its communication messaging strategy:

- *Features to maximize accessibility of the messaging (e.g., font size, color contrast analyzer)*
- *Alert and notification schedules*
- *Translation of notifications*
- *Messaging tone and language*
- *Key components and order of messaging content (e.g., hazard, location, time)*

The narrative must be no more than one page.

All emergency management communications follow SCE's "One-Voice" communications strategy. This strategy adopted following the 2011 SCE response to windstorms in our service area requiring all communications across SCE through all channels to follow initial messaging laid out in a One Voice internal messaging document issued periodically via e-mail by the public information officer (PIO) and approved by the IC.

Channels using One Voice messaging include written communications, media outreach, SCE.com, and direct communication with customers (through the call center) and local officials (through the liaison officers). One Voice messaging is updated daily or more frequently when there is significant updated information available such as a substantial change in number of customers de-energized.

All messaging is written by PIOs, who are fully IMT-trained and have received additional specialized PIO and SCE-specific communications training. PIOs all serve in communications roles in their blue-sky roles or have communications backgrounds. PSPS PIOs can be in other marketing or communications roles across SCE or have moved from these roles into other roles across the company. There is a dedicated PIO resource on the PSPS IMT, whose blue-sky role is to develop and manage PSPS communications year-round and to prepare the team for activations.

One Voice messaging can be adapted by internal users to meet channel requirements. For example, the specific language and format used by social media will not be the same as language and format used in the call center. However, the messaging remains constant. The breadth of channels maximizes accessibility. Stakeholders can access messages verbally, through the call center, in a Web Content Accessibility Guidelines (WCAG)-compliant format through SCE.com, or via media reports. Outage communications and PSPS notifications are sent to customers in the format and channel of their choice. PSPS notifications are also available in multiple languages and formats; please see Section 8.5.2 Public Outreach and Education Awareness Program for additional information on these communications and notifications.

PSPS Notifications are written in simplified direct language with the goal of providing message clarity and actionable information. They are translated into 19 languages that are prevalent in SCE’s service territory as well as three indigenous (spoken) languages. Static versions of PSPS notifications translated into the prevalent languages can be accessed via SCE’s Wildfire Communications Center (<https://www.sce.com/wildfire/wildfire-communications-center>)

PSPS notifications follow the alerts and warnings systems in the California Public Alert and Warning System (CalPAWS) Plan.

Initial notifications are classified as alerts, in keeping with the definition that alerts “draw the attention of recipients to some previously unexpected or unknown condition or event.”

Update notifications 24 hours before the onset of the period of concern are classified as warnings, in keeping with the definition that warnings encourage “recipients to take immediate protective actions appropriate to some emergent hazard or threat.”

Other notifications, including PSPS Expected, Shutoff, Prepare to Retore and restoration are classified as notifications as they are “intended to inform recipients of a condition or event for which contingency plans are in place.”

PSPS alert and notification schedules can be found in Appendix F: Supplemental Information.

Please see Section 8.5.2 Public Outreach and Education Awareness Program for additional information.

8.4.4.3 Current Gaps and Limitations

In tabulated format, the electrical corporation must provide a list of current gaps and limitations in its public communication strategy. Where gaps or limitations exist, the electrical corporation must indicate the remedial action plan and the timeline for resolving the gaps or limitations. For all requested information, the electrical corporation should indicate a form of verification that can be provided upon request for compliance assurance. Table 8-50 provides an example of the minimum level of content and detail required.

Below is a summary of SCE’s gaps and limitations in public emergency communication strategy.

Table 8-50 - Key Gaps and Limitations in Public Emergency Communication Strategy

Gap or Limitation Subject	Remedial Brief Description	Remedial Action Plan
Notifications	SCE was not able to send advance notifications for an event due to the sudden onset of unexpected weather.	SCE will examine current protocols for activating the PSPS IMT for marginal weather conditions to determine if changes to activation criteria should be made. Target timeline: 2023
Notifications	Cancellation notices for portions of some circuits were not sent within two hours of the decision to cancel or remove those segments from scope.	SCE will evaluate the process for sending cancellation notices to customers on circuit segments removed from scope to reduce end-to-end processing time in situations where segment-level (and sub-segment level) decision making is necessary to minimize customer impacts. Target timeline: 2023

8.4.5 Preparedness and Planning for Service Restoration

8.4.5.1 Overview of Service Restoration Plan

In this section of the WMP, the electrical corporation must provide an overview of its plan to restore service after an outage due to a wildfire or PSPS event. At a minimum, the overview must include a brief description of the following:

- *Purpose and scope of the restoration plan.*

SCE begins assessment of restoration priorities and development of a restoration plan once damage assessment are available and the extent of impacts are analyzed. The protection of life safety, the environment, infrastructure, and property are base planning factors for restoration planning. Across SCE, considerations taken as part of restoration planning include technical factors related to impacts, availability of resources and replacement equipment, as well as internal and external dependencies.

- *Overview of protocols, policies, and procedures for service restoration (e.g., means and methods for assessing conditions, decision-making framework, prioritizations, degree of customization).*

SCE may employ different restoration strategies based on the size, scope, complexity, and intensity of each non PSPS incident. In smaller, more isolated incidents, SCE typically employs the standard order-based strategy that it uses under routine outage circumstances. This strategy is not effective in larger incidents where there is an overwhelming volume of orders. When incidents are larger, SCE moves to an area-based strategy where repair priorities are assigned by areas and circuits. This is a tactical decision

made during the planning process for a given operational period and documented in the IAP. The two strategy types, order- and area-based can be used together within an event as needed.

For PSPS, PSPS IMT personnel monitor all circuits that are de-energized and will watch for winds to decrease below thresholds, which triggers circuit patrols for re-energization. Upon receiving the All-Clear declaration and approval from the PSPS IMT Incident Commander to begin restoration of a circuit circuits or circuit segments under PSPS protocols are patrolled and re-energized. The patrols are intended to ensure there is no damage to SCE facilities before power can be safely restored. In most cases, field crews are standing by for patrol, so that patrols can typically take place within eight hours. However, visual inspections of the power lines usually take place during daylight hours for safety and accuracy. Consequently, patrol and restoration operations may be limited or prolonged during overnight hours. SCE strives to restore all power within 24 hours of de-energization when possible. For multiday events, with gaps of even a few hours, field crews will attempt to restore customers before a second POC begins, even if this requires a repeat de-energization. Some circuits will require a helicopter patrol. When possible, customers on difficult-to-patrol circuits are switched to more accessible circuits for restoration, so that circuits with no customers on them will be the last in line for restoration. PSPS IMT personnel perform ongoing assessments of restoration plans to monitor progress and address any delays to re-energization that may occur.

This must include:

An operational flow diagram illustrating key components of the service restoration procedures from the moment of the incident to response, recovery, and restoration of service.

See figures in Section 8.4.2.1 Overview of Wildfire and PSPS Emergency Preparedness for such diagram.

Resource planning and allocation (e.g., staffing, equipment).

Please see Section 8.4.2.2 Key Personnel, Qualifications, and Training and Section 8.4.6.2 Planning and Allocation of Resources for information on resource planning and allocation.

Drills, simulations, and tabletop exercises.

Please see Section 8.4.2.2 for additional information.

Coordination and collaboration with public safety partners (e.g., interoperable communications).

Within four hours of the identification of a major (non PSPS) outage, SCE will notify state and local public agencies, and the media of the major outage, its location, expected duration and cause (if available). SCE will provide estimates of restoration times as soon as possible following an initial assessment of damage and the establishment of priorities for service restoration.

Within four hours of the initial (non PSPS) damage assessment and the establishment of priorities for restoring service, SCE will make estimated restoration times, by geographic area, available to state and local public agencies, and to media. If restoration time estimate is not available, SCE will provide that update.

For PSPS, Prepare to Restore notifications are sent to all impacted customers and public safety partners as soon as restoration has been authorized. These notifications specify that restoration typically takes up to 8 hours.

Notification of and communication to customers during and after a wildfire- or PSPS- related outage.

Within four hours of the identification of a major (non PSPS) outage, SCE will make information available to customers through our call center and notify Essential Customers, state and local public agencies, and the media of the major outage, its location, expected duration and cause (if available). SCE will provide estimates of restoration times as soon as possible following an initial assessment of damage and the establishment of priorities for service restoration.

Within four hours of the initial (non PSPS) damage assessment and the establishment of priorities for restoring service, SCE will make estimated restoration times, by geographic area, available through its call center to Essential Customers, state and local public agencies, and to media. If restoration time estimate is not available, SCE will provide that update.

For PSPS, upon receiving the All-Clear declaration and approval from the PSPS IMT Incident Commander to begin restoration of a circuit, restoration notifications are sent to impacted customers.

The electrical corporation may refer to its Public Utilities Code section 768.6 emergency preparedness plan to provide more detail. Where the electrical corporation has already reported the requested information in another section of the WMP, it must provide a cross- reference with a hyperlink to that section. The overview must be no more than one page.

Reference the Utility Initiative Tracking ID where appropriate.

8.4.5.2 Planning and Allocation of Resources

The electrical corporation must briefly describe its methods for planning appropriate resources (e.g., equipment, specialized workers), and allocating those resources to assure the safety of the public during service restoration.

In addition, the electrical corporation must provide an overview of its plans for contingency measures regarding the resources required to respond to an increased number of reports concerning unsafe conditions and expedite a response to a wildfire- or PSPS-related power outage.

This must include a brief narrative on how the electrical corporation:

- *Uses weather reports to pre-position manpower and equipment before anticipated severe weather that could result in an outage*
- *Sets priorities*
- *Facilitates internal and external communications*
- *Restores service*

The narrative for this section must be no more than two pages.

Emergency management during an incident within the SCE service territory is a comprehensive effort that requires SCE to work and coordinate with a diverse set of internal and external stakeholders. SCE is prepared to respond to natural and human-caused emergencies promptly and effectively and to take all appropriate actions including steps to preserve life, property and infrastructure, and maintain the ability to deliver safe and reliable electricity. On incidents when SCE internal capabilities are overwhelmed, mutual assistance resources are requested and incorporated into the incident organizational structure following the same ICS and NIMS principles for internal SCE resources.

The All-Hazards Plan discusses a Concept of Operations (ConOps)²⁵⁹ which provides further guidance to SCE leadership and emergency responders regarding the sequence and scope of actions to be taken during an incident. It describes all levels of SCE's emergency management capability and corresponding roles and responsibilities operational procedures during an emergency and describes SCE's alignment with SEMS and NIMS. The Plan also describes SCE's phased approach at emergency response, details functions of the SCE EOC, and demonstrates how information flows internally within SCE and externally to and from various public safety and emergency response partners.

During an incident response, the Incident Commander, Planning Section Chief, and BRDM continue to evaluate any dynamic changes to resource needs which may change throughout the incident.

Objectives: Resource scaling decisions are driven by incident objectives that are developed at the start of an event/incident. They are re-evaluated daily through the course of the IMT activation to help determine resource needs. This re-evaluation is dependent upon situational awareness such as weather reports, current outages, and cascading effects.

Operational Periods and Shifts: Incident Commanders establish operational periods, the time frames for executing a set of operation actions as specified in the Incident Action Plan. Operational Periods can be of various lengths, although usually not over 24 hours. There may be multiple shifts within an operational period (e.g., 3X 8 hr. shifts or 2X 12 hr.) and shift ranges may vary by position demand and associated deliverables.

SCE employs a PSPS-compatible Communications Strategy during an All Hazards incident to provide effective communications with both internal and external stakeholders. SCE's Watch Office, Incident Commander, Public Information Officer, Liaison Officer, Operations Section Chief, and Customer Care Branch Director all work together to coordinate internal and external facing communication and messaging.

8.4.5.3 Drills, Simulations, and Tabletop Exercises

Discussion-based and operational-based exercises enhance knowledge of plans, allow personnel to improve their own performance, and identify opportunities to improve capabilities to respond to wildfire- and PSPS-related service outages. Exercises also provide a method to evaluate an electrical corporation's emergency preparedness plan and identify planning and/or procedural deficiencies.

²⁵⁹ Concept of Operations is discussed within the All-Hazards Plan, Section 6.1, p 43.

Internal Exercises

The electrical corporation must report on its program(s) for conducting internal discussion- based and operations-based exercises for service restoration. This must include, at a minimum:

- *The types of discussion-based exercises (e.g., seminars, workshops, tabletop exercises, games) and operations-based exercises (e.g., drills, functional exercises, full-scale exercises)*
- *The purpose of the exercises*
- *The schedule and frequency of exercise programs*
- *The percentage of staff who have completed/participated in exercises*
- *How the electrical corporation tracks who has completed the exercises Table 8-51 provides an example of the minimum acceptable level of information.*

External Exercises

The electrical corporation must report on its program(s) for conducting external discussion- based and operations-based exercises for service restoration due to wildfire. This must include, at a minimum:

- *The types of discussion-based exercises (e.g., seminars, workshops, tabletop exercises, games) and operations-based exercises (e.g., drills, functional exercises, full-scale exercises)*
- *The schedule and frequency of exercise programs*
- *The percentage of public safety partners who have participated in these exercises*
- *How the electrical corporation tracks who has completed the exercises Table 8-52 provides an example of the minimum acceptable level of information.*

Below is a summary of SCE’s Emergency Preparedness internal exercise programs.

Table 8-51 - Internal Drill, Simulation, and Tabletop Exercise Program for Service Restoration

Category	Exercise Title and Type	Purpose	Exercise Frequency	Position or Title of Personnel Required to Participate	Personnel Required	Personnel Completed	Form of Verification or Reference
Discussion Based	Tabletop Exercise	Provide awareness and understanding of roles and responsibilities, existing documentation, policies, and procedures.	Annually	PSPS IMT positions	Varies	Varies	Situation Manual, Registration Sheets
Operations Based	Drill	Provide awareness and understanding of roles and responsibilities, and how to execute discrete tasks and actions.	As needed	Targeted IMT positions as identified via the exercise planning process	Varies	Varies	Situation Manual, Registration Sheets
Operations Based	Functional Exercise	Demonstrate an ability to successfully execute roles and responsibilities of an IMT through a set period and incident response. Confirm positions can successfully work across incident response functions and work as a team in support of objectives.	Annually	PSPS IMT positions	Varies	Varies	Exercise Plan, Registration Sheets
Operations Based	Full Scale Exercise	Successfully work across multiple levels of response to execute roles and responsibilities in an incident. Demonstrate ability to work across complex systems and in response to a significant, high-impact scenario.	As needed	PSPS IMT positions	Varies	Varies	Exercise Plan, Registration Sheets

Below is a summary of SCE’s Emergency Preparedness external exercise programs.

Table 8-52 - External Drill, Simulation, and Tabletop Exercise Program for Service Restoration

Category	Exercise Title and Type	Purpose	Exercise Frequency	Position or Title of Personnel Required to Participate	Personnel Required	Personnel Completed	Form of Verification or Reference
N/A	N/A	Please see Section 8.4.2.3 External Exercises for additional information	N/A	N/A	N/A	N/A	N/A

8.4.6 Customer Support in Wildfire and PSPS Emergencies

In this section of the WMP, the electrical corporation must provide an overview of its programs, systems, and protocols to support residential and non-residential customers in wildfire emergencies and PSPS events. The overview for each emergency service must be no more than one page. At a minimum, the overview must cover the following customer emergency services, per Public Utilities Code section 8386(c)(21):

In the event of a major emergency, SCE has a dedicated customer support team to help impacted customers by providing information on available resources. All customer inquiries during major emergencies, such as wildfire, are prioritized. SCE's efforts to reach, engage and support AFN communities, including by developing partnerships with CBOs and providing for AFN needs at CRCs, can be found in SCE's AFN Plan Quarterly Update reports and the AFN Plan filed on January 31, 2023. Please see Section 8.5.3 Engagement with Access and Functional Needs Populations.

SCE has programs available to customers to help them through emergencies. SCE continues to improve communications to promote awareness and provide access to information and resources needed to mitigate the safety and economic impacts customers may face.

SCE utilizes the following programs to provide customer support during wildfire and PSPS emergencies: outage reporting, support for low-income customers, billing adjustments, deposit waivers, extended payment plans, suspension of disconnection and nonpayment fees, repair processing and timing, list and description of community assistance locations and services, medical baseline support services, and access to electrical corporation representatives. These programs are further described below.

8.4.6.1 Customer Protections and Practices During Emergencies

To mitigate customer risks that could arise during and after an emergency, SCE utilizes the following practices and/or enacts customer protections in line with CPUC directives, as appropriate:

Outage reporting

SCE uses best practices to provide customers with the most up-to-date information regarding outages and emergency communications, and to provide resources for reporting outages. SCE.com provides an interactive Outage Map for customers to determine if a customer's service area is affected by an outage, including an outage caused by a wildfire or PSPS event. The website also provides an opportunity for customers to sign up to receive alerts, get tips to help stay safe during an outage, and connect to important resources and support programs available during an outage emergency. Please see Section 8.5.2 and Figure SCE 8-53 for an example of SCE.com displaying outage and community support information.

Support for low-income customers

SCE offers qualifying customers discounted rates on their electricity bill through California Alternate Rate for Energy(CARE)/Family Electric Rate Assistance (FERA) programs. These customer accounts are flagged to bypass program qualification checks of annual verifications and high usage verifications. Customers can enroll in CARE or FERA regardless of whether they are experiencing an emergency related to a wildfire. Customers may also reach out to SCE partner organizations like 211 to receive referral services and in certain circumstances, they may also receive direct assistance such as

transportation, food support or housing accommodations. 211 services to educate, outreach and support customers with Access and Functional Needs before, during, and after a PSPS event. SCE leverages 211's established network to provide customers with personalized safety/emergency plans prior to a PSPS as well as provide direct support during PSPS such as food, transportation, and lodging.

Billing adjustments

Affected customers will not receive estimated bills, and daily minimum charges are halted/adjusted.

Deposit waivers

Waive deposit requirements for small business customers seeking to reestablish service to a new location. SCE does not collect reestablishment deposits from residential customers.

Extended payment plans

Providing affected customers with extended payment plans as needed.

Suspension of disconnection and nonpayment fees

Affected customers are not sent for disconnection due to non-payment, and assessment of non-payment fees are eliminated.

Repair processing and timing

Provide access to local planning resources to assist with expediting SCE support for rebuilding and providing up to date information about restoration timing both through the customer contact center and the web for affected customers.

List and description of community assistance locations and services

During PSPS events, SCE uses Community Resource Centers and Community Crew Vehicles to provide support to customers in areas most likely to experience shutoffs. These locations provide customers with water, light snacks and, access to restrooms and Wi-Fi. Customers can also obtain updated outage information, sign up for alerts, update their contact information and charge their personal mobile and certain portable medical devices. A list of pre-approved locations can be found here:

https://www.sce.com/sites/default/files/custom-files/Web%20files/G22-046%20Update%20of%20CRC%20List%20for%20Web_WCAG%205-1-22.pdf

Medical Baseline support services

This program is for customers who are reliant on electrically operated medical or mobility equipment. This program provides customers additional electricity per day at a discounted rate, helping to reduce monthly utility costs. MBL customers receive additional program eligibility for SCE's Critical Care Backup Battery Program outlined in Section 8.4.1.2 below if they reside in SCE's HFRA. This program supports customers' ability to utilize their medical equipment in the event of an outage, including an outage propounded by a PSPS event or a wildfire. SCE also works with regional agencies and partners such as 211 to support customer needs before and during PSPS events. Additionally, enrollment in MBL adds protections during PSPS activations and prior to disconnections through an escalated notification process.

Access to electrical corporation representatives

SCE has been utilizing its virtual resource center (SCE.com/disaster-support) and makes information on SCE's disaster support programs available to local assistance centers. In alignment with SCE's COVID-19 protocols, SCE will continue its practice of providing in-person staff to county and local government assistance centers during disasters and other events. During PSPS events, and in alignment with SCE's COVID-19 protocols, SCE staff are deployed to CRCs and CCVs to support customers. Furthermore, as needed, SCE may direct staff and resources to county and local government assistance centers during disasters and other events to provide in-person support to assist with information and consumer protections.

8.4.6.2 Critical Care Backup Battery Program (PSPS-2)

The Critical Care Battery Backup (CCBB) program supports all customers enrolled in Medical baseline (MBL) that reside in a HFRA to provide a battery-powered portable backup solution to operate critical medical equipment during power outages due to PSPS events or other emergencies. Between January 2022 and December 2022, SCE deployed over 3,400 free portable backup batteries to eligible customers. SCE will continue to offer the CCBB program to newly identified eligible customers, deploy backup batteries to all eligible customers who choose to participate in the program, and adjust the program outreach and strategy as needed to serve eligible customers who choose to participate.

8.4.6.3 Portable Power Station Rebate Program and Portable Generator Rebate Program (PSPS-3)

The Portable Power Station Rebate Program, previously called Residential Battery Station Rebates, provided up to five \$75 rebates to customers for purchasing a portable power station for their general home or small business resiliency needs. As of September 1, 2022, the rebate amount increased up to \$150 per portable power station. The Portable Power Station Rebate Program is available to all SCE customers residing in a HFRA or served by circuits passing through HFRA that are impacted by PSPS. As of December 31, 2022, SCE issued 2,152 Portable Power Station rebates. SCE will continue to review and update the program offerings that offer the most impact to SCE customers.

The Portable Generator Rebate program, previously called the Well Water Generator Incentive program, was developed to assist customers by offsetting the cost of purchasing a portable generator. SCE targets customers living in HFRA communities or surrounding communities that receive their power from a circuit fed from a HFRA circuit, whose electrical needs may extend beyond the limited power supply offered by a portable power station. SCE launched the program in June 2020 by offering a \$300 rebate on the purchase of a qualified portable generator, and further enhanced the rebate amount to \$500 for income-qualified customers (e.g., those enrolled in California Alternate Rates for Energy (CARE) or Family Electric Rate Assistance (FERA)). In July 2021, SCE revised the program eligibility requirements and rebate amounts, based on customer survey feedback. The water-pumping dependency eligibility requirement was removed, and the eligibility requirement of MBL program enrollment was added to increase accessibility to the higher rebate amounts. The rebate was reduced from \$300 to \$200 to support the set budget while allowing the added MBL program customers participation that now qualified for the higher rebate. As of September 1, 2022, the rebate amount increased up to \$600 for

income-qualified and MBL-enrolled customers that reside in a HFRA. As of December 31, 2022, SCE issued 993 Portable Generator rebates.

8.4.6.4 Disability Disaster and Access Resources (DDAR) Program

The Disability Disaster and Access Resource program provides support to customers with AFN prior to and during PSPS events, to mitigate customer impacts associated with PSPS. Prior to PSPS events, DDAR will help customers with AFN prepare for PSPS by helping them develop emergency resiliency plans, including procuring backup power, and support them in enrolling in applicable customer care and bill support programs (e.g., SCE's medical baseline allowance program). During PSPS events, DDAR will assist customers with in-event battery backup needs, obtaining food vouchers, and finding accessible transportation and accessible hotel accommodations. SCE will evaluate the expansion of DDAR to support customers prior to and during significant non-PSPS outage events.

8.4.6.5 In-Event Battery Loan Pilot

The In-Event Battery Loan Pilot supports customers with AFN who live in a HFRA and utilize a medical device or assistive technology for independence, health, or safety; customers who participate in the pilot are those who would not otherwise be eligible or have yet to apply for CCBB. The pilot provides in-event support to customers that escalate a need for SCE to accommodate the provision of temporary power for a medical device or assistive technology during a PSPS activation.

8.4.6.6 Customer-Side Generator

SCE retains portable generator units during the PSPS season to provide to customers. SCE will continue to deploy temporary portable generators for critical facilities to assist maintaining electric service for essential safety and public services emergencies.

8.4.6.7 eMobility Phase 2

The PSPS OIR Phase 2 Decision (D.20-05-051) required the IOUs to implement pilot projects to investigate the feasibility of mobile and deployable electric vehicle Level 3 fast charging for areas impacted by PSPS events. SCE investigated the commercial availability of mobile electric vehicle chargers (MEVC) and found that no off-the-shelf MEVC existed that met SCE needs. A request for information (RFI) and subsequent request for qualifications (RFQ) were released and awarded in 2021 for the development of a custom solution to pilot and test safe and reliable mobile electric vehicle charging in areas impacted by PSPS events.

SCE issued a purchase order in October 2021 for the design and development of a MEVC capable of charging electric vehicles at a rate up to 50kW that is legally transportable on all public roads by a standard shipping container trailer. The MEVC is expected to be fully delivered by Q1 2023, following which SCE will begin pre-deployment testing. Pending successful testing, the MEVC will be deployed as a

pilot at select PSPS events from 2023-2026 to determine its feasibility to provide safe and reliable transportation electrification resilience.

8.5 Community Outreach and Engagement

8.5.1 Overview

In accordance with California Public Utilities Code section 8386(c)(19)(B) each electrical corporation must provide its plans for community outreach and engagement before, during, and after a wildfire. The electrical corporation must also provide its plans for outreach and engagement related to PSPS, outages from protective equipment and device settings, and vegetation management.

In this section, the electrical corporation must identify objectives for the next 3- and 10-year periods, targets, and performance metrics related to the following community outreach and engagement mitigation initiatives:

- *Public outreach and education awareness for wildfires, PSPS, outages from protective equipment and device settings, and vegetation management*
- *Public engagement in the WMP decision-making process*
- *Engagement with AFN populations, local governments, and tribal communities*
- *Collaboration on local wildfire mitigation and planning*
- *Best practice sharing with other electrical corporations from within and outside of California*

8.5.1.1 Objectives

Each electrical corporation must summarize the objectives for its 3-year and 10-year plans for implementing and improving its community outreach and engagement.²⁶⁰ These summaries must include the following:

- *Identification of which initiative(s) in the WMP the electrical corporation is implementing to achieve the stated objective, including Utility Initiative Tracking IDs*
- *Reference(s) to applicable codes, standards, and best practices/guidelines and an indication of whether the electrical corporation exceeds an applicable code, standard, or regulation*
- *Method of verifying achievement of each objective*
- *A completion date for when the electrical corporation will achieve the objective*

²⁶⁰ Annual information included in this section must align with Tables 1 and 12 of the QDR.

- *Reference(s) to the WMP section(s) or appendix, including page numbers, where the details of the objective(s) are documented and substantiated*

This information must be provided in Table 8-53 for the 3-year plan and Table 8-54 for the 10- year plan. Examples of the minimum acceptable level of information are provided below.

Below is a summary of SCE’s 3-year Community Outreach and Engagement objectives.

Table 8-53 - Community Outreach and Engagement Initiative Objectives (3-year plan)

Objectives for Three Years (2023–2025)	Applicable Initiative(s), Tracking ID(s)	Applicable Regulations, Codes, Standards, and Best Practices (See Note)	Method of Verification (i.e., program)	Completion Date	Reference (section & page #)
Actively collaborating with stakeholder networks and partnerships to better understand customer, community and stakeholder specific needs and develop tailored solutions, including AFN.	Public Outreach and Education Awareness Program and Section (8.5.2) Engagement with Access and Functional Needs Populations (8.5.3)	N/A	See Table 8-44 and Table 8-59	on-going	Section 8.5.2 Public Outreach and Education Awareness Program, pp. 583-602; and Section 8.5.3 Engagement with Access and Functional Needs Populations, pp. 601-605
Meet at least quarterly to provide updates on PSPS enhancement efforts and solicit input for improvement areas in how SCE approaches PSPS overall and provides a forum for stakeholders to propose ways to improve all aspects of PSPS	PSPS Advisory Board Meetings (Public Outreach and Education Awareness Program (8.5.2))	PSPS OIR Phase 2 D.20-05-051 ²⁶¹	CPUC Quarterly Update Report Post-meeting surveys	on-going	Section 8.5.2 Public Outreach and Education Awareness Program, pp. 583-602

Note: An asterisk indicates that the electrical corporation exceeds a particular code, regulation, standard, or best practice. The electrical corporation must provide a reference to the appendix section and page providing further documentation, justification, and substantiation.

²⁶¹ <https://docs.cpuc.ca.gov/PublishedDocs/Published/G000/M339/K524/339524880.PDF>

Below is a summary of SCE’s 10-year Community Outreach and Engagement objectives.

Table 8-54 - Community Outreach and Engagement Initiative Objectives (10-year plan)

Objectives for Ten Years (2026–2032)	Applicable Initiative(s), Tracking ID(s)	Applicable Regulations, Codes, Standards, and Best Practices (See Note)	Method of Verification (i.e., program)	Completion Date	Reference (section & page #)
Refine stakeholder engagement capabilities through tailored approaches for outreach, engagement and information exchange with customers, communities, and stakeholders	DEP-1 and DEP-4	N/A	Activity Reporting	on-going	Section 8.5.2 Public Outreach and Education Awareness Program, pp. 583-602
Continue to look for ways to expand engagement with agencies outside of CA, including supporting IWRMC's efforts to expand utility membership base and appoint leaders to its Executive Steering Group	Best Practice Sharing with Other Electrical Corporations (8.5.5)	N/A	Engagements with outside agencies	on-going	Section 8.5.5 Best Practice Sharing with Other Electrical Corporations, pp. 606-610

Note: An asterisk indicates that the electrical corporation exceeds a particular code, regulation, standard, or best practice. The electrical corporation must provide a reference to the appendix section and page providing further documentation, justification, and substantiation.

8.5.1.2 Targets

Initiative targets are forward-looking quantifiable measurements of activities identified by each electrical corporation in its WMP. Electrical corporations will show progress toward completing targets in subsequent reports, including QDRs and WMP Updates.

The electrical corporation must list all targets it will use to track progress on its community outreach and engagement for the three years of its Base WMP. Energy Safety's Compliance Assurance Division and third parties must be able to track and audit each target.²⁶² For each initiative target, the electrical corporation must provide the following:

- *Utility Initiative Tracking IDs.*
- *Projected targets for each of the three years of the Base WMP and relevant units.*
- *Quarterly, rolling targets for 2023 and 2024 (PSPS outreach only).*
- *The expected "x% risk impact" for each of the three years of the Base WMP. The expected x% risk impact is the expected percentage risk reduction per year, as described in Section 7.2.2.2.*
- *Method of verifying target completion.*

The electrical corporation's targets must provide enough detail to effectively inform efforts to improve the performance (i.e., reduction in ignition probability or wildfire consequence) of the electrical corporation's community outreach and engagement initiatives.

Table 8-55 and Table 8-56 provide examples of the minimum acceptable level of information.

²⁶² Annual information included in this section must align with Tables 1 and 12 of the QDR.

Below is a summary of SCE’s Community Outreach and Engagement targets by year.

Table 8-55 - Community Outreach and Engagement Initiative Targets by Year

Initiative Activity	Tracking ID	2023 Target & Unit	x% Risk Impact 2023	2024 Target & Unit	x% Risk Impact 2024	2025 Target & Unit	x% Risk Impact 2025	Method of Verification
Wildfire Safety Community Meetings	DEP-1	SCE will host at least four wildfire community safety meetings by region in targeted HFRA communities based on the impact of 2022 PSPS events and ongoing wildfire mitigation activities	N/A	Continue or revise – determined based on the outcome of 2023	N/A	Continue or revise – determined based on the outcome of 2023-2024	N/A	Link to the SCE.com site for meeting conducted and recordings posted
Customer Research and Education	DEP-4	SCE plans to conduct at least five PSPS-related customer studies in 2023	N/A	SCE plans to conduct at least three PSPS-related customer studies in 2024	N/A	SCE plans to conduct at least three PSPS-related customer studies in 2025	N/A	Detailed list of surveys with supporting information

Below is a summary of SCE’s Community Outreach and Engagement targets by quarter.

Table 8-56 - Community Outreach and Engagement Initiative Targets by Year

Initiative Activity	Tracking ID	Target End of Q2 2023 & Unit	Target End of Q3 2023 & Unit	End of Year Target 2023 & Unit	x% Risk Impact 2023	Target End of Q2 2024 & Unit	Target End of Q3 2024 & Unit	End of Year Target 2024 & Unit	x% Risk Impact 2024	Target 2025 & Unit	x% Risk Impact 2025	Method of Verification
Wildfire Safety Community Meetings	DEP-1	4	4	SCE will host at least four wildfire community safety meetings by region in targeted HFRA communities based on the impact of 2022 PSPS events and ongoing wildfire mitigation activities	N/A	TBD	TBD	Continue or revise – determined based on the outcome of 2023	N/A	Continue or revise – determined based on the outcome of 2023-2024	N/A	Link to the SCE.com site for meeting conducted and recordings posted
Customer Research and Education	DEP-4	1	3	SCE plans to conduct at least five PSPS-related customer studies in 2023	N/A	1	2	SCE plans to conduct at least three PSPS-related customer studies in 2024	N/A	SCE plans to conduct at least three PSPS-related customer studies in 2025	N/A	Detailed list of surveys with supporting information

8.5.1.3 Performance Metrics Identified by the Electrical Corporation

Performance metrics indicate the extent to which an electrical corporation's Wildfire

Mitigation Plan is driving performance outcomes. Each electrical corporation must:

- *List the performance metrics the electrical corporation uses to evaluate the effectiveness of its community outreach and engagement in reducing wildfire and PSPS risk²⁶³*

For each of those performance metrics listed, the electrical corporation must:

- *Report the electrical corporation's performance since 2020 (if previously collected)*
- *Project performance for 2023-2025*
- *List method of verification*

The electrical corporation must ensure that each metric's name and values are the same in its WMP reporting as its QDR reporting (specifically, QDR Table 2 and QDR Table 3). Metrics listed in this section that are the same as performance metrics required by Energy Safety and reported in QDR Table 2 (Performance Metrics)²⁶⁴ must match those reported in QDR Table 2. Metrics listed in this section that are not the same as any of the performance metrics identified by Energy Safety and reported in QDR Table 2 must match those reported in QDR Table 3.

The electrical corporation must:

- *Summarize its self-identified performance metric(s) in tabular form*
- *Provide a brief narrative that explains trends in the metrics*

Table 8-57 provides an example of the minimum acceptable level of information.

²⁶³ There may be overlap between the performance metrics the electrical corporation uses and performance metrics required by Energy Safety. The electrical corporation must list these overlapping metrics in this section in addition to any unique performance metrics it uses.

²⁶⁴ The performance metrics identified by Energy Safety are included in Energy Safety's Data Guidelines.

Below is a summary of SCE’s Community Outreach and Engagement metrics by year.

Table 8-57 - Community Outreach and Engagement Performance Metrics Results by Year

Performance Metrics	2020	2021	2022	2023 Projected	2024 Projected	2025 Projected	Method of Verification (e.g., third-party evaluation, QDR)
Customer recall of SCE wildfire and preparedness communications (Service Area / HFRA-Only) <i>Units reflect % of customers recalling</i>	56 / 65	51 / 56	48 / 56	48 / 56	48 / 56	48 / 56	In-Language Wildfire Mitigation / PSPS Communications Effectiveness Survey, QDR Table 3

One way SCE evaluates the effectiveness of its community outreach and engagement activities is by measuring customer awareness of SCE’s wildfire messaging and customer wildfire and PSPS programs and services. Since 2020, SCE has surveyed customers through its In-Language Wildfire Mitigation / PSPS Communications Effectiveness Survey. This mandated survey is performed twice annually, once toward the start of Q3 and once toward the end of Q4 – and it is offered in English and 19 other languages. The metrics that SCE provides in Table reflect the Q4 survey results from each year, for customers systemwide and within HFRA. The figures in this table represent the percentage of surveyed customers who responded that they recalled communications from SCE about the threat of wildfire and how they can prepare for them. SCE performs this survey across its service area, and therefore provides figures for both its entire service area and HFRA-only.

SCE’s In-Language Survey generally sees higher awareness in the Q4 update than earlier in the year before the fire season begins. This trend is likely due to increased outreach and heightened awareness of PSPS-related activities later in the year. Generally, the overall awareness has declined slightly year over year in the limited data set which is likely due to several reasons (e.g., intensity of summer, reduction in frequency of PSPS events, scale of PSPS communications and outreach activities). SCE will continue to monitor and track awareness of wildfire and preparedness communications through the In-language Survey previously described.

The projections provided in Table 8-57 are estimates and subject to change. For purposes of this table, SCE's customer recall projections align with the Q4 2022 awareness data to match similar communications efforts and activities levels from previous years. Communication and outreach will include efforts such as a PSPS newsletter, PSPS notifications, community outreach such as safety fairs, and customer surveys. SCE expects these metrics to remain generally consistent over time to align with consistent levels of marketing anticipated from year to year. Some fluctuation is expected to occur due to varying levels of PSPS related notifications and activity based on weather events.

8.5.2 Public Outreach and Education Awareness Program

The electrical corporation must provide a high-level overview of its public outreach and education awareness program(s) for wildfires; outages due to wildfires, PSPS events, and protective equipment and device settings; service restoration before, during, and after the incidents (as required by Public Utilities Code section 8386[c][19][B]); and vegetation management. This includes outreach efforts in English, Spanish, Chinese (including Cantonese, Mandarin, and other Chinese languages), Tagalog, and Vietnamese, as well as Korean and Russian where those languages are prevalent within the service territory.

At a minimum, the overview must include the following:

- *A description of the purpose and scope of the program(s).*
- *References to the Utility Initiative Tracking ID where appropriate.*

SCE holds a variety of meetings and workshops to inform and educate stakeholders and customers about SCE's Grid Hardening activities, wildfire, PSPS, customer programs, and resources available to assist customers with emergency preparedness.

Customers and communities require information to become better prepared for SCE's wildfire mitigation work and PSPS events, and to build resilience. To service this need, SCE performs the following public outreach and educational awareness efforts:

- Every year, in advance of fire season, we send informational materials to every local and tribal government in HFRA to update them on WMP activities and PSPS protocols. In this outreach, we request emergency contact updates and feedback on Community Resource Center locations and services. Additionally, we offer to meet with every local and tribal government in HFRA to review the information in person.
- Every year, in advance of fire season, we meet with County Operational Areas to review PSPS protocols and decision-making factors, AFN outreach, and other types of emergencies including fires and storms. SCE also solicits feedback on how we can build on our partnerships with the Operational Areas.
- We conduct regional quarterly regional Working Group meetings with local governments, critical infrastructure providers, and organizations serving the AFN community to review best practices and lessons learned related to wildfire, PSPS, and outage management.
- We conduct workshops with critical infrastructure customers as identified by the CPUC (including hospitals, telecommunications providers, etc.) to provide an overview of PSPS and wildfire mitigation and how they can enhance their resiliency in a PSPS event.
- We have proactively participated in safety fairs in HFRA communities to help customers prepare for potential PSPS. At these fairs, we update customer contact information, enroll customers in SCE's outage alert notifications, and share information on SCE's resiliency programs, as well as other community resources.

- We mail a PSPS Newsletter annually to all customers in both HFRA and non-HFRA with tailored content. The HFRA version of the newsletter highlights SCE's wildfire mitigation efforts and what we are doing to reduce the impacts of PSPS events. Customer care programs and resources are prominently featured. The Non-HFRA version of the newsletter focuses on outage safety tips and how customers can prepare for emergencies. It also includes an update on SCE's wildfire mitigation efforts. Call Center phone numbers and website links are included and electronic copies of both newsletter versions in the 19 languages (Arabic, Armenian, Chinese Mandarin, Chinese Cantonese, Farsi, French, German, Japanese, Khmer, Korean, Punjabi, Russian, Spanish, Tagalog, Vietnamese, Portuguese, Hindi, Hmong, and Thai) plus English, prevalent in SCE's service territory can be accessed via SCE's Wildfire Communications Center on SCE.com.

SCE continues to partner with an extensive network of Community Based Organizations (CBOs) enlisted to conduct in-language wildfire safety/PSPS preparedness customer education and outreach throughout its service territory, with particular emphasis on high fire risk areas.

- SCE launched incentivized partnerships with CBOs that have a strong reach in communities and demonstrate the ability to partner with SCE to help educate and increase awareness around Wildfire and Safety Preparedness. Together, the CBOs and SCE share information about SCE's wildfire mitigation plan and the importance of building resiliency plans for when emergencies occur. Other important topics regularly shared are helpful programs like MBL, CARE/FERA, rate options and important rebates and incentives available to our customers. CBOs also regularly exchange and share healthcare communications on programs and services through social media, newsletters, e-blasts, blog posts, and direct stakeholder engagement efforts like digital webinars.
- All the Tier 1 CBOs (SCE contracted CBOs for ongoing incentivized partnerships) are required to track their outreach and engagement efforts and submit this information via monthly reports. These metrics are used to evaluate CBO performance, program effectiveness, and identify areas of improvement.
- Together, the CBOs and SCE share information about customer care programs for PSPS, such as portable power station and generation rebates, battery storage, Critical Care Backup Battery and Medical Baseline program, along with other wildfire and safety preparedness resources. CBOs regularly exchange and share information on these programs through their social media channels, newsletters, emails, blog posts, and direct stakeholder engagement efforts, either through CBO-facilitated webinars or in-person events (when permitted). Some of these resources are also provided in multiple languages at the CBOs' request.

Each year, SCE sends a bi-lingual letter and flyer requesting master-metered customers (i.e., landlord/property owner) to educate their sub-metered tenants about wildfire/PSPS information including steps they can take to prepare in advance and stay safe during a PSPS outage. Electronic copies of the flyer in English, Spanish, Chinese, Vietnamese, Korean and Tagalog are also accessible via SCE's Wildfire Communications Center on sce.com.

SCE sends periodic letters to customers most frequently impacted by PSPS to provide important updates regarding SCE's efforts to strengthen the grid and reduce the number of PSPS outages.

SCE conducts annual pre- and post-season surveys to evaluate the effectiveness of its wildfire safety and preparedness communications and outreach to customers in general. These pre- and post-season surveys are offered to customers in 19 languages as well as English.

SCE's ongoing marketing campaign, which includes radio, digital, social media, newspaper and search ads, and direct customer mailings, seeks to educate customers and the public on PSPS, including the conditions that trigger a PSPS, how to prepare for a PSPS, what SCE has done and continues to do to mitigate the risk of wildfires, how to prepare for emergencies, and customer programs and resources for impacted customers. In 2023, SCE will create new digital ads on these themes to ensure continued customer engagement. The digital banner ads will continue to be available in 19 languages plus English. SCE will also continue to track total impressions of these ads.

In 2023, SCE will implement a customer-centric, integrated communications strategy to deliver consistent and cohesive messaging across traditional and digital channels to drive Wildfire/PSPS customer education and preparedness behavior. SCE will place customers into specific segments and design journeys that are relevant to each segment before, during and after a PSPS outage. PSPS preparedness messaging will also be amplified through inclusions and cross promotions in other integrated communications as appropriate.

SCE is exploring ways to prevent customers from receiving conflicting messaging, by improving coordination between our PSPS notification system and standard customer communications system to exclude customers from marketing campaigns who are experiencing PSPS de-energizations.

8.5.2.1 Community Meetings (DEP-1)

SCE holds wildfire safety community meetings throughout SCE's service area, prioritizing HFRA, to share information about SCE's wildfire mitigation plan, grid hardening updates, PSPS, and emergency preparedness, and an additional focus on SCE's programs, services, and resources. These meetings offer participants a chance to ask questions of SCE staff and share feedback and concerns.

For 2023, SCE will host a minimum of four virtual wildfire community safety meetings prioritizing HFRA counties, grouping all counties by region (North, South, East and West), and in-person targeted communities based on the impact of 2022 PSPS events and ongoing wildfire mitigation activities.

8.5.2.2 Marketing Campaign

SCE's multilingual marketing campaign, which includes radio, digital, print, social media, search ads, and direct customer mailings, seeks to educate customers and the public on PSPS, including the conditions that trigger a PSPS, how to prepare for a PSPS and emergencies in general, what SCE has done and continues to do to mitigate the risk of wildfires, and programs and resources SCE offers to impacted customers.

The marketing campaign seeks to educate customers about PSPS and emergency preparedness and reduce the impact of a PSPS or a wildfire primarily through three methods: (1) advertising campaign, (2) social media, and (3) direct customer mailings.

- **Advertising Campaign:** The advertising campaign aims to convey key messages that collectively help educate customers about PSPS and emergency preparedness. These advertisements run on a variety of channels including print/newspaper, digital banners, digital video, connected TV, social media, search, digital audio, and broadcast radio. The 2022 advertising campaign centered the following themes: Emergency Preparedness, PSPS Definition/Condition, Wildfire Mitigation, Alert Sign-Up, MBL Program, and Customer Resources and Support. The 2022 ad campaign generated about 832 million total impressions. In 2023, SCE will run its in-language and English advertisements concurrently service area-wide.
- **Social Media:** SCE uses social media as part of its marketing campaign with paid and organic posts informing customers about PSPS, emergency preparedness tips, how to sign up for PSPS alerts, and information on SCE’s wildfire mitigation efforts. Also, information about SCE’s CCVs and CRCs is shared on Facebook, Twitter, Instagram, and Nextdoor.
- **Direct Customer Mailings:** As part of the direct customer mailing strategy, SCE mails a PSPS Newsletter. Please refer to Section 8.5.2.

For 2023, SCE will launch new ads that will focus on SCE’s wildfire mitigation efforts and emergency preparedness tips for customers.

8.5.2.3 Customer Research and Education (DEP-4)

SCE seeks to improve its understanding of how to reduce impacts of wildfires, PSPS, and wildfire mitigation work for its customers. SCE develops surveys to capture customer feedback on SCE’s wildfire mitigation initiatives with a special emphasis on PSPS activities. Specific activities as part of this customer research and education initiative are detailed below:

- The PSPS Tracker is an annual survey conducted at the end of wildfire season to assess and understand customer awareness, experience, and opinions of SCE’s PSPS and wildfire mitigation activities, focusing on customers affected by PSPS events. Five customer segments are targeted:
 - Customers not notified but de-energized
 - Customers notified and de-energized
 - Customers notified but not de-energized
 - Customers not notified and not de-energized
 - Customers who do not live in a HFRA
- Wildfire safety community meeting surveys conducted among attendees of the meetings to receive feedback on their experience and the information provided.
- CRC/CCV visitor surveys conducted among customers who visited a CRC/CCV during a PSPS event to receive feedback on their experience, and the resources and support provided.

- In-Language Wildfire Mitigation Communications Effectiveness Surveys that measured the communications and outreach effectiveness prior to and coincident with the wildfire seasons by prevalent language.

For 2023, SCE will continue to conduct surveys to bolster the assessment of customer attitudes, perceptions, and behaviors towards wildfire mitigation programs and PSPS events.

A brief narrative followed by a tabulated list of all the different target communities it is trying to reach across the electrical corporation's service territory. The target communities list must include AFN and other vulnerable or marginalized populations, but they may also include other target populations, such as communities in different geographic locations (e.g., urban areas, rural areas), age groups, language and ethnic groups, transient populations, or Medical Baseline customers. In addition, the electrical corporation must summarize the interests or concerns each community may have before, during, or after a wildfire or PSPS event to help inform outreach and education awareness needs. Table 8-58 provides an example of the minimum acceptable level of information.

A tabulated list of community partners the electrical corporation is working with or intends to work with to support its community outreach and education programs. Table 8-59 provides an example of the minimum acceptable level of information.

A table of the various outreach and education awareness programs (i.e., campaigns, informal education, grant programs, participatory learning) that the electrical corporation implements before, during, and after wildfire, vegetation management, and PSPS events, including efforts to engage with partners in developing and exercising these programs. In addition, the electrical corporation must describe how it implements its overall program, including staff and volunteer needs, other resource needs, method for implementation (e.g., industry best practice, latest research in methods for risk communication, social marketing), long-term monitoring and evaluation of each program's success, need for improvement, etc. The narrative for this section is limited to two to three pages. The electrical corporation must also provide the information on its outreach and education awareness programs a in tabulated format. Table 8-58 provides an example of the minimum acceptable level of information.

SCE implements an integrated communications strategy to provide effective communications with the public before, during, and immediately following major outages and emergencies, including PSPS. SCE coordinates with various entities and key stakeholders on education, outreach, and feedback in preparation for emergency events. This preparedness extends to overall customer resiliency; and while it has initially been directed to address PSPS, many of the efforts are also broadly applicable to other extended outages or emergencies.

Whole Community Communications

In advance of potential outages that may affect them, SCE informs state agencies, public safety partners, critical infrastructure and facilities providers, and all customers (including populations from the Disabilities and Access and Functional Needs community) through multiple programs and procedures.

SCE uses the following definition of disabilities and access and functional needs (AFN):

- Populations whose members may have additional needs before, during, and after an incident in

functional areas, including but not limited to maintaining independence and the ability to perform the activities of daily living, communication, transportation, supervision, and medical care.

- Individuals in need of additional response assistance may include those who have disabilities, who live in institutionalized settings, who are elderly, who are children, who are from diverse cultures, who have limited English proficiency or are non-English speaking, or who are transportation disadvantaged.
- The population of people experiencing homelessness.

Emergency Communications

SCE delivers notifications in numerous ways and intervals, including via voice and/or email according to the recipient's preference. Before, during, and immediately following a major outage SCE disseminates information to customers using the call center, as well as radio, television, and electronic communications, and in-person contact.

SCE's layered approach to communication avoids exclusive reliance on online strategies. SCE employs the following methods for communication:

- Interactive Voice Response (IVR) and direct access to SCE Energy Advisors through the Customer Contact Center
- Automated notifications including via voice, and/or email, and TTY formats according to the recipient's preference
- SCE.com website with outage map showing all types of outages
- Community Resource Centers
- Social media
- Coordination through Public Safety Partners and their notification systems

SCE maintains Community Crew Vehicles (CCVs) to assist with communication, engage with the community, and provide support to the public. SCE has designed and outfitted these vehicles with the required equipment and technology to enable SCE staff to transport and distribute water, snacks, and resiliency kits to communities potentially impacted by a PSPS event.

During incident response, SCE's Emergency Operations Center (EOC) is responsible for ensuring information sharing across all internal and external stakeholders. The EOC typically serves as the interface between SCE, public sector emergency management, regulatory agencies, and elected officials.

Incident Communications Team/One Voice Messaging

One-voice messaging is developed by the Public Information Officer (PIO), in coordination with key members of the Incident Management Team and/or Incident Support team and approved by the Incident Commander prior to release. This is inclusive messaging that is led, developed, and managed by the PIO and distributed during a crisis to stakeholders throughout the company to utilize.

Talking Points and Media Statements

Talking points and media statements are developed by the PIO to be used by company spokespeople to communicate with their respective stakeholders/audiences using established channels of communications (e.g., social media, phone call briefings, employee intranet, press release, press conference, teleconference, one-on-one media interviews, e-mail or written notification, and website content with videos).

The talking points and media statements enable scalable timely media coordination before, during and after a major outage, including estimated restoration times and potential safety hazards.

SCE.com

Online communication on SCE.com updates customers with the current status of outages. In the event of an incident, the website contains an outage map where customers can access outage details, including the projected restoration time. During Public Safety Power Shutoffs, there are two types of information on this page:

Dynamic information relating to current notifications, de-energizations, re-energizations, and locations of Community Crew Vehicles (CCVs) and Community Resource Centers (CRCs).

Static information explaining the PSPS process and necessity, including links for more information, notification sign-ups, additional languages, and FAQs.

Figure SCE 8-53 below provides an example of SCE.com displaying outage and Community Support information.

Figure SCE 8-53 - Example of SCE.com

The screenshot displays the SCE.com website's Power Outage Awareness Map. At the top, the URL is <https://www.sce.com/outage-center/check-outage-status>. The page features the Edison logo and a search bar. The main content area is titled "Power Outage Awareness Map" and includes a breadcrumb trail: Home > Outage Center > Power Outage Awareness Map.

Power Outages
 Search by: Address Outage Number Meter Number
 Search by address, city, county or ZIP

Current Outages
 31 Outages | 1,292 Customers Impacted

Upcoming Scheduled Outages
 410 Outages Scheduled | 22,422 Customers Possibly Impacted

Public Safety Power Shutoff (PSPS)
 Search for an address to see specific PSPS details or see county-level details [below](#).

Not Seeing Your Outage? [Report](#)
 Last Updated: 12/5/2022 - 12:52 PM PST

Outage Alerts
 Stay informed about unplanned repair and planned maintenance outages. [Get Alerts >](#)

Community Support

Resource Centers Crew Vehicles Further Assistance

SCE Community Resource Centers are available to support customers during a Public Safety Power Shutoffs... [More](#) v

There are currently none available.

[View All Community Resource Centers](#)

Legend:

- Outage
- Upcoming Scheduled Outage
- PSPS
- PSPS Active
- PSPS Power Shutoff Warning
- High Fire Risk Area
- Downstream Circuit(s)
- Major Outage
- Rotating Outage Group
- EV Charging Station
- Resource Center
- Crew Vehicle

Customer Communications

Customer communications refers to any communications, such as letters, email, text or phone calls, developed and delivered to SCE customers. It consists of: (1) any communications during an unplanned incident, which is derived from one-voice messaging developed by the PIO, in coordination with the IMT/IST and approved by the Incident Commander and tailored towards SCE customers; and (2) customized information pre-developed and automated for specific customers, homes, and businesses based on location and utilized for automated messaging for planned events (i.e., PSPS, construction or maintenance).

Critical Care Customers

SCE annually sends all its medical baseline customers a letter to raise awareness of outages and requests their most current contact information preferences. Messaging includes a call-to-action for customers to update their contact information either by phone or on SCE.com. Knowing that outages can impact customers at any time, this campaign encourages plans for resiliency during all types of power outages.

Critical Facilities and Infrastructure

SCE engages with public safety partners to identify critical facilities and infrastructure that may be impacted by potential outages, as outlined in the CPUC guidance, and other facilities that our public safety partners identify as important. SCE continually assesses the customer contact information for all critical infrastructure and facilities by periodically reaching out to these customers by phone and email, and actively working to update any missing or inaccurate contact information. An annual communication is sent to request updated contact information and back up generation status. SCE has created a page in SCE.com Critical Infrastructure customers may also go into and update contact information.

All Other Customers

- SCE attempts to verify customer contact information is up to date through various sources and channels.
- SCE's Customer Contact Center procedures include confirmation and updating customer contact information when speaking with our customers.
- SCE.com has enabled with a persistent prompt to remind customers to upgrade their contract information with a link that quickly navigates them to the update page.
- SCE continues community meetings where representatives are available to update customer contact information.
- Requests for customers to update contact information are included on printed material and bill inserts.

- Business customer account managers complete an annual contact certification for all critical infrastructure and government and industrial customers. While this is a normal course of business throughout the year, if update or verification has not occurred, specific outreach is made to update contact information.
- The request to update information is included in radio spots and media interviews.
- SCE is addressing messages that fail to deliver to a device by removing the incorrect information and verifying the correct information.

Below is a summary of Target Communities and their interests/concerns before, during, or after a wildfire or PSPS event

Table 8-58 - List of Target Communities

Target Community	Interests or Concerns Before, During, and After Wildfire and PSPS events
Individuals who have developmental or intellectual disabilities	<ul style="list-style-type: none"> • Access to electrically powered durable medical equipment or assistive technology used for health, safety, and independence (e.g., Augmentative and Alternative Communication devices) • Access to information that can be understood • Access to transportation on demand (e.g., paratransit or accessible transportation) <p>Examples of offerings to mitigate impact:</p> <ul style="list-style-type: none"> • SCE offers battery and generator rebates for assistive technology or other devices. Additionally, SCE offers batteries free of charge to customers enrolled in the MBL who reside in HFRA. • SCE offers notification/alerts in English (translated into prevalent languages) and address level alerts that can be used by anyone, including caregivers. • SCE is partnering with a third-party vendor to translate notifications/alerts in American Sign Language with English voice over and text that is accessible via screen readers and Braille readers. • SCE has partnered with 211 CA Network to connect customers to transportation. Additionally, SCE is exploring expanding

Target Community	Interests or Concerns Before, During, and After Wildfire and PSPS events
	<p>partnerships with paratransit providers.</p> <ul style="list-style-type: none"> • SCE partners with Community Based Organizations that serve individuals with AFN to help with wildfire safety education and outreach.
Individuals who have physical disabilities	<ul style="list-style-type: none"> • Access to electrically powered durable medical equipment or assistive technology used for health, safety, and independence (e.g., motorized scooter) • Access to information that can be understood (e.g., American Sign Language) • Access to transportation on demand (e.g., paratransit or accessible transportation) <p>Examples of offerings to mitigate impact:</p> <ul style="list-style-type: none"> • SCE offers battery and generator rebates for assistive technology or other devices. Additionally, SCE offers batteries free of charge to customers enrolled in the MBL who reside in HFRA. • SCE offers notification/alerts in English (translated into prevalent languages) and address level alerts that can be used by anyone, including caregivers. • SCE is partnering with a third-party vendor to translate notifications/alerts in American Sign Language with English voice over and text that is accessible via screen readers and braille readers. • SCE has partnered with 211 CA Network to connect customers to transportation. Additionally, SCE is exploring expanding partnerships with paratransit providers. • SCE partners with Community Based Organizations that serve individuals with AFN to help with wildfire safety education and outreach.
Individuals who have chronic	<ul style="list-style-type: none"> • Access to electrically powered durable medical equipment or assistive technology used for health, safety, and independence

Target Community	Interests or Concerns Before, During, and After Wildfire and PSPS events
<p>conditions, injuries, or enrolled in the medical baseline program</p>	<p>(e.g., durable medical equipment used for breathing purposes)</p> <p>Examples of offerings to mitigate impact</p> <ul style="list-style-type: none"> • SCE offers battery and generator rebates for assistive technology or other devices. Additionally, SCE offers batteries free of charge to customers enrolled in the MBL who reside in HFRA. • SCE partners with Community Based Organizations that serve individuals with AFN to help with wildfire safety education and outreach. • SCE takes additional steps to ensure that MBL and Life Support customers are receiving notifications advising them about a potential PSPS. When SCE does not receive confirmation that these customers received proactive alerts and notifications, SCE will conduct follow-up calls and messages, and finally, send a representative to attempt in-person contact (doorbell ring).
<p>Limited English proficiencies</p>	<ul style="list-style-type: none"> • Limited access to understand electrical corporation wildfire hazards and risks, specific actions that can be taken to reduce risk, and awareness of emergency services, resources, etc. <p>Examples of offerings to mitigate impact</p> <ul style="list-style-type: none"> • SCE offers notification/alerts in plain English (translated into prevalent languages) • SCE partners with Community Based Organizations that serve individuals with AFN to help with wildfire safety education and outreach.
<p>Children</p>	<ul style="list-style-type: none"> • Access to information that can be understood <p>Examples of offerings to mitigate impact</p> <ul style="list-style-type: none"> • SCE partners with Community Based Organizations that serve individuals with AFN, including youth-based groups, to help with wildfire safety education and outreach.

Target Community	Interests or Concerns Before, During, and After Wildfire and PSPS events
<p>People living in institutionalized settings</p>	<ul style="list-style-type: none"> • Access of information pertaining to wildfire hazards and risks, specific actions that can be taken to reduce risk, and awareness of emergency services, resources, etc. <p>Examples of offerings to mitigate impact</p> <ul style="list-style-type: none"> • SCE provides advance notifications to Public Safety Partners and critical infrastructure and keeps them informed of the PSPS • SCE offers individuals with access to address level alerts for PSPS. Any individual can enroll to receive these alerts even if they are not the customer of record.
<p>People who are low income or enrolled in income qualified programs</p>	<ul style="list-style-type: none"> • Access to resources and food support during a PSPS <p>Examples of offerings to mitigate impact</p> <ul style="list-style-type: none"> • SCE partnered with 211 California Network to assist customers with food needs during and immediately after a PSPS. • SCE is expanding partnerships with local food banks to provide customers affected by PSPS with a food box during or immediately after a PSPS.
<p>People experiencing homelessness</p>	<ul style="list-style-type: none"> • Access of information pertaining to wildfire hazards and risks, specific actions that can be taken to reduce risk, and awareness of emergency services, resources, etc. • Access to power and cell signal for their mobile devices <p>Examples of offerings to mitigate impact</p> <ul style="list-style-type: none"> • SCE provides advance notifications to Public Safety Partners and critical infrastructure and keeps them informed of the PSPS. • SCE offers individuals with access to address level alerts for PSPS. Any individual can enroll to receive these alerts even if they are not the customer of record.

Target Community	Interests or Concerns Before, During, and After Wildfire and PSPS events
<p>People who are transportation disadvantaged, including but not limited to, those who are dependent on public transit</p>	<ul style="list-style-type: none"> • Access of on-demand transportation for evacuation, or relocation purposes • Access of on-demand transportation to visit community resource centers or community crew vehicles <p>Examples of offerings to mitigate impact</p> <ul style="list-style-type: none"> • SCE partnered with 211 California Network to assist customers with transportation needs. • SCE provides advance notifications to Public Safety Partners and critical infrastructure (transportation sector is identified as a critical infrastructure) and keeps them informed of the PSPS.
<p>People who are pregnant or nursing babies</p>	<ul style="list-style-type: none"> • Access to electrically powered durable medical equipment or assistive technology used for health, safety, independence and nursing (e.g., breast pump, air conditioner, or refrigeration for medication, formulas, or breast milk) <p>Examples of offerings to mitigate impact</p> <ul style="list-style-type: none"> • SCE offers battery and generator rebates for assistive technology or other devices. Additionally, SCE offers batteries free of charge to customers enrolled in the MBL who reside in HFRA. • Customers who have refrigeration needs for medication, formulas, or breastmilk can get a small thermal bag and ice voucher at any CRC/CCV that are operating during PSPS.

Below is a list of community partners the electrical corporation is working with or intends to work with to support its community outreach and education programs.

Table 8-59 - List of Community Partners

This table is provided in full within the supporting documents folder at:

<https://www.sce.com/safety/wild-fire-mitigation>

Community Partners	County	City
AMERI CARE ENTERPRISES INCORP	LOS ANGELES	INGLEWOOD
ASA CHARTER SCHOOL	SAN BERNARDINO	SAN BERNARDINO
ASSISTANCE LEAGUE OF SANTA ANA	ORANGE	SANTA ANA
Full table is included within the supporting documents folder at https://www.sce.com/safety/wild-fire-mitigation .		

Below lists information on SCE’s community outreach and education programs.

Table 8-60 - Community Outreach and Education Programs

Core Activity	Event Type	Period of Application (Before, During, After Incident)	Name of Outreach or Education Program	Description of Program	Target Audience	Reference/ Link
Advertising Campaign	PSPS and Emergency Events	Before	Emergency Preparedness, PSPS Definition /Condition, Wildfire Mitigation, Alert Sign-Up, MBL Program, and Customer Resources and Support	The advertising campaign aims to convey key messages that collectively help educate customers about PSPS, wildfire mitigation and emergency preparedness. These advertisements run on a variety of channels including print/newspaper, digital banners, digital video, connected TV, social media, search, digital audio and broadcast radio.	General public, AFN population, limited English proficiency (LEP) population	N/A
Traditional Media	PSPS, Wildfire, and Emergency Events	Before, During and After	PSPS, emergency preparedness tips, PSPS alerts, wildfire mitigation, in event information	The dedicated media team conducts outreach to outlets ahead of the height of PSPS and wildfire season to educate reporters and share resources. During events they conduct active outreach to outlets covering affected areas and after events they continue responding to inquiries and providing information.	TV, radio, print, news websites	N/A
Social Media	PSPS, Wildfire, and Emergency Events	Before, During and After	PSPS, emergency preparedness tips, PSPS alerts, wildfire mitigation, CCV and CRC information	SCE uses social media with paid and organic posts informing customers about a variety of emergency preparedness information shared through Facebook, Twitter, Instagram and Nextdoor	General public	N/A
Direct Customer Mailings	PSPS, Wildfire, and Emergency Events	Before	PSPS Newsletter	As part of the direct customer mailing strategy, SCE sent the 2022 PSPS Newsletter to all SCE customers in both HFRA and non-HFRAs The HFRA PSPS newsletter highlighted SCE’s wildfire mitigation efforts and what we are doing to reduce the impacts of PSPS events. Customer Care resources were also prominently featured. A QR code was included to facilitate quick access to SCE’s PSPS decision-making video and information related to the performance of SCE-funded fire-suppression helitankers. The Non-HFRA PSPS newsletter focused on outage safety	General public	https://edisonintl.sharepoint.com/:b:/t/Public/MCRR/english/Efaq2EDHvMtAqHrYJbVuULUBiJrF3pVMBXuNmibYiHrLDg?e=ESGerl https://edisonintl.sharepoint.com/:b:/t/Public/MCRR/english/EUAI71A2pN5MjJX2UqoSvY8BqpNmp6-jTTf3oNdEjP_vlg?e=cjA0jL

Core Activity	Event Type	Period of Application (Before, During, After Incident)	Name of Outreach or Education Program	Description of Program	Target Audience	Reference/ Link
				tips and how customers can prepare for emergencies. It also included an update on SCE's wildfire mitigation efforts. Translated versions of the HFRA and non-HFRA PSPS Newsletters in all 19 prevalent languages were made accessible to customers via SCE's Wildfire Communications Center on SCE.com.		https://download.newsroom.edison.com/create_memory_file/?f_id=620fe9b4b3aed34b1cc770f3&content_verified=True
Direct Customer Mailings	Wildfire and PSPS	Before	Letters and flyers to SCE mastered-metered property owners/landlords	These letters and flyers were mailed on June 9, 2022 and requested landlord/property owners' assistance with educating their sub-metered tenants about wildfire and PSPS, including steps they can take to plan, prepare and stay safe in advance and during a PSPS outage, in addition to requesting that landlords post the provided flyers for tenant awareness. The flyer included a QR code to help drive signups for PSPS Address Level Alerts. The letter and the flyer are bilingual (English/Spanish). Translated versions of the flyer in Chinese, Vietnamese, Korean and Tagalog (in addition to Spanish) were made accessible for download via SCE's Wildfire Communications Center webpage.	General public	https://www.sce.com/sites/default/files/custom-files/Web%20files/Master%20Meter%20PSPS%202022%20Flyer_English_WCAG.pdf
News and Public Storytelling	Wildfire and PSPS	Before	Energized by Edison	News stories and videos about SCE wildfire mitigation and PSPS efforts	General public	https://energized.edison.com/wildfire-safety
Direct Customer Mailing	Vegetation Management – Routine	Prior to inspections	Vegetation Management Routine Inspections	Intended to make property owners aware that their trees will be inspected by SCE and trimmed/mitigated as needed.	Property owners whose property contains one or more trees in our inventory.	N/A
Email Messaging	Vegetation Management – Routine	Prior to inspections	Vegetation Management Routine Inspections	Intended to make property owners aware that their trees will be inspected by SCE and trimmed/mitigated as needed.	Property owners whose property contains one or more trees in our inventory.	N/A

Core Activity	Event Type	Period of Application (Before, During, After Incident)	Name of Outreach or Education Program	Description of Program	Target Audience	Reference/ Link
Direct Customer Mailing	Vegetation Management Palm Inspections	Prior to inspections of palms	Vegetation Management Palm Strategy	Intended to make property owners aware that their palms will be inspected by SCE and trimmed/mitigated as needed.	Property owners whose property contains one or more palms in our inventory.	N/A
Direct Customer Mailing & Email Messaging	Fast Curve Pilot Circuits	Prior and during changes made to the 15 circuits with the faster-acting pilot settings	Fast curve settings	Informed local government city managers and staff in HFRA about the changes SCE is making to its fast curve settings strategy, which has been implemented since 2018. Informed Medical Baseline and critical infrastructure customers on the 15 circuits with faster-acting pilot settings to prepare for potential outages by providing links to resources as well as a link to the fast curve fact sheet.	HFRA city managers and staff; Medical Baseline and critical infrastructure customers on the 15 faster-acting pilot settings	N/A

8.5.3 Engagement with Access and Functional Needs Populations

In this section, the electrical corporation must provide an overview of its process for understanding, evaluating, designing, and implementing wildfire and PSPS risk mitigation strategies, policies, and procedures specific to AFN customers across its territory. The electrical corporation must also report, at a minimum, on the following:

- *Summary of key AFN demographics, distribution, and percentage of total customer base.*

Based on 2022 data, SCE estimates that it has over 1.5 million unique customer accounts with AFN, which equates to approximately 32% of total customer accounts. SCE uses an approach consistent with other IOUs to identify and track customers with AFN. See Section 5.4.3.1 Individuals at Risk from Wildfire for a map showing the Distribution of AFN across SCE service territory.

SCE aggregates unique customer accounts enrolled in the following programs to determine the annual number of customers and percentage of accounts:

- California Alternate Rates for Energy (CARE) or Family Electric Rate Assistance (FERA): The annual number of income-qualified customers is calculated as the total number of service accounts enrolled in SCE's income qualified programs such as CARE/FERA.
- Medical Baseline Allowance Program: The annual number of MBL customers is calculated as the total number of customers enrolled in SCE's MBL program.
- Life-Support (Critical Care): Critical Care customers are a subset of the MBL population. The annual number of Critical Care customers is calculated as the total number of customers who have been identified to use medical equipment for life support purposes, meaning that the customer cannot be without life support equipment for at least two hours.
- Customers who receive their utility bill in an alternate format (e.g., Braille; large font).
- Customers who have identified their preferred language as a language other than English: Limited English proficiency is calculated based on the total number of customers who have self-certified with SCE as their primary language is other than English.
- Older adults/seniors: Customers who have certified as being 65 years or older
- Customers who self-certify SCE appends information on customer accounts for households that self-certify as having someone in their household with a condition that can be significantly affected by the interruption of power during a PSPS event or a disconnection for non-payment of a bill. The benefit of self-certification, which is good for 90 days, is that in the event of a disconnection, SCE will attempt to reach the customer through their preferred method of contact (email, text, or voice call) to notify them of the outage. If SCE cannot reach the customer through their preferred method, a field service representative will attempt to make in-person contact at the customer's home address to deliver the message regarding the disconnection.

SCE launched an AFN Self-Identification pilot in 2022 to further identify customers and household members with access and functional needs, above and beyond customers enrolled in the Medical Baseline Allowance Program. The pilot was conducted among all residents on SCE circuit frequently impacted by PSPS. In 2023, it will be expanded to a full campaign to reach all account holders residing in HFRAs.

New customer information gathered through the survey will enable SCE to provide further tailored support to customers who:

- Rely on electrically powered medical equipment
- Need heating and cooling for body temperature regulation
- Rely on assistive technology
- Need refrigeration for a medical purpose
- Need accessible transportation
- Cannot leave home without difficulty
- Are 65 and older
- Have a household member with a disability
- Have language preferences

For other AFN categories not currently tracked in our data system, SCE uses data from Acxiom, a third-party vendor providing census-based data. Acxiom supplies data to SCE for each residential service account on an annual basis. However, it is important to note that the data available on AFN individuals does not cover all categories (e.g., individuals experiencing homelessness or transient populations, or transportation disadvantaged).

SCE's efforts to reach, engage and support AFN communities, including developing partnerships with CBOs and providing for AFN needs at CRCs, can be found in the 2023 AFN Plan filed on January 30, 2023.

Evaluation of the specific challenges and needs during a wildfire or PSPS event of the electrical corporation's AFN customer base.

Every year, SCE conducts an annual PSPS Tracker Survey, which asks customers who had been in scope of a PSPS in the prior year about their experience and knowledge surrounding PSPS. In 2022, SCE included AFN demographics questions to the survey to better understand the experience of PSPS specific to customers who have disabilities and other access and functional needs. Challenges and needs as highlighted in the Survey include:

- Concerns on alternate sources of power and the challenges of financial barriers to building resiliency.
- Concerns on the negative impacts to households, including the challenges associated with the inability to use or charge adjustable hospital beds, electric scooters, nebulizers, air conditioners, and Continuous Positive Airway Pressure (CPAP) machines.

Further details on the results and insights gained from this survey are provided in SCE's 2023 Annual AFN Plan filed to the CPUC on January 30, 2023.²⁶⁵

In Q4 2022, SCE launched a study to gain a deeper understanding of the accessibility of engaging with SCE.com, including the Outage Center and dedicated AFN PSPS landing page, for customers with sensory disabilities. This valuable customer experience feedback will be used to evaluate improvements to SCE.com.

Additionally, during PSPS events, SCE opens Community Resource Centers (CRCs) and deploys Community Crew Vehicles (CCVs) in areas near the impacted area to provide customers a safe place to

²⁶⁵ AFN Plan available at <https://docs.cpuc.ca.gov/PublishedDocs/Efile/G000/M501/K654/501654066.PDF>

charge their personal devices and obtain resiliency items. SCE encourages customers who visit our CRCs and CCVs to complete a survey about their experience and captures direct feedback from all customers, including those with AFN.

Plans to address specific needs of the AFN customer base throughout the service territory specific to the unique threats that wildfires and PSPS events may pose for those populations before, during, and after the incidents. This should include high-level strategies, policies, programs, and procedures for outreach, engagement in the development and implementation of the AFN-specific risk mitigation strategies, and ongoing feedback practices.

Pursuant to the CPUC Decision in Phase Two and Phase Three of Rulemaking 18-12-005, SCE submits an annual AFN Plan for PSPS Support.²⁶⁶ The AFN Plan focuses on mitigating the impacts of a power shutoff on individuals with AFN who depend on electricity. Quarterly updates are also submitted that measure progress on implementing that plan.

This plan is focused on the specific approach for serving individuals with AFN leading to and during PSPS. It summarizes the research, feedback, and external input that has shaped the support strategy for populations with AFN, the programs that serve these individuals, the preparedness outreach approaches focused on populations with AFN, and the in-event customer communications, which serve populations with AFN.

Reference the Utility Initiative Tracking ID where appropriate.

8.5.4 Collaboration on Local Wildfire Mitigation Planning

In this section, the electrical corporation must provide a high-level overview of its plans, programs, and/or policies for collaborating with communities on local wildfire mitigation planning (e.g., wildfire safety elements in general plans, community wildfire protection plans, local multi-hazard mitigation plans) within its service territory. The narrative must be no more than one page.

As discussed in Section 8.4.1 Overview SCE's All Hazards Plan (AHP) articulates the operations and policies that guide how the company prepares for, responds to and recovers from emergency electrical incidents using the utility-specific Incident Command Structure. It is designed to facilitate safe and efficient restoration of outages caused by outside forces, through the development of accurate situational awareness and the sharing of critical information during an incident. The AHP outlines the communications strategy and notification procedures that SCE utilizes to communicate with its customers, the public, appropriate government agencies, essential service providers, critical care customers, and other important stakeholders in the restoration process. It also outlines how SCE will collaborate with the communities it serves in preparing for and responding to emergency events, which may include activities such as pre-positioning of field resources or equipment in advance of forecasted weather events.

An important component to the AHP is the California Standardized Emergency Management System (SEMS). The SEMS is a structure for coordination between the government and local emergency response organizations. It provides and facilitates the flow of emergency information and resources within and between the organizational levels of field response, local government, operational areas, regions, and state emergency management. SCE has integrated SEMS into its emergency plans and response structure.

²⁶⁶ *Ibid.*

During an incident, SCE aligns its response with affected agencies. Coordination with affected agencies requires SCE to engage stakeholders for collaborative planning prior to an incident (e.g., storm, wildfire, PSPS), creating a process to request agency representation during an incident or event, and implementing an IMT structure to manage an incident. SEMS incorporates:

- Incident Command System - A field-level emergency response system based on management by objectives.
- Multi/Inter-agency coordination - Affected agencies working together to coordinate allocations of resources and emergency response activities.
- Mutual Aid - A system for obtaining additional emergency resources from non-affected jurisdictions.
- Operational Area Concept - County and its sub-divisions to coordinate damage information, resource requests and emergency response.

In addition, the electrical corporation must provide the following information in tabular form, providing no more than one page of tabulated information in the main body of the WMP and the full table in an Appendix as needed.

- *List of county, city, and tribal agencies and non-governmental organizations (e.g., nonprofits, fire safe councils) within the service territory with which the electrical corporation has collaborated or intends to collaborate on local wildfire mitigation planning efforts (i.e., non-wildfire emergency planning activities)*
 - *For each entity, the local wildfire mitigation planning program/plan/document, level of collaboration (e.g., meeting attendance, verbal or written comments), and date the electrical corporation provided its last feedback. Table 8-61 provides an example of the minimum acceptable level of information. Reference the Utility Initiative Tracking ID where appropriate.*
- *In a separate table, the electrical corporation must provide a list of current gaps and limitations in its collaboration efforts with local partners on local wildfire planning efforts. Where gaps or limitations exist, the electrical corporation must indicate proposed means and methods to increase collaborative efforts. Table 8-62 provides an example of the minimum acceptable level of information.*

Below SCE lists information on collaboration with community partners.

Table 8-61 - Collaboration in Local Wildfire Mitigation Planning
Please see Appendix F: Supplemental Information for the complete table

Name of County, City, or Tribal Agency or Civil Society Organization (e.g., nongovernmental organization, fire safe council)	Program, Plan, or Document	Last Version of Collaboration	Level of Collaboration
Acton Town Council	General WMP Plan and PSPS Protocols	6/27/2022	Acton Town Council Wildfire Mitigation Update Completed
Acton Town Council	General WMP Plan and PSPS Protocols	6/17/2022	Acton Town Council Concerned About Uptick in Emergency Outages
Adelanto	General WMP Plan and PSPS Protocols	6/9/2022	City of Adelanto Reliability Report and WMP/PSPS Briefing Meeting
Agoura Hills	General WMP Plan and PSPS Protocols	6/21/2022	Wildfire
Full table is included in Appendix F: Supplemental Information			

Below SCE lists information on gaps and limitations in collaborating with community partners.

Table 8-62 - Key Gaps and Limitations in Collaborating on Local Wildfire Mitigation Planning

Subject of Gap or Limitation	Brief Description of Gap or Limitation	Strategy for Improvement
Community engagement feedback	Received recommendations on: <ul style="list-style-type: none"> • Expanding marketing and promotion of meetings • Refining messages and channels based on performance data 	SCE is working on expanding outreach efforts to additional social media platforms and continuing to develop ad with relevant messaging. <ul style="list-style-type: none"> • Target timeline: ongoing

8.5.5 Best Practice Sharing with Other Electrical Corporations

In this section, the electrical corporation must provide a high-level overview of its policy for sharing best practices and collaborating with other electrical corporations on technical and programmatic aspects of its WMP program. The narrative must be no more than one page.

SCE continues to seek improvements to its wildfire mitigation approaches and further reduce wildfire risk by increasing opportunities to collaborate and exchange ideas with other utilities, technology developers, communities and governmental agencies. This includes memberships in industry organizations, outreach to commercial customers with national accounts, participation in technical forums and meeting regularly with electric utilities nationally and abroad.

For example, SCE has regular check-ins with other utilities through the International Wildfire Risk Management Consortium (IWRMC). IWRMC's mission is to facilitate a system of working and networking channels between members of the global utility community to support ongoing sharing of data, information, technology, and practices, and proactively address the wildfire issue through learning, innovation, analysis, and collaboration. SCE, along with SDG&E and PG&E in the United States and Powercor and AusNet Services in Australia, is a founding member and participant in the IWRMC Executive Steering Group. Today, over a dozen other utilities facing significant wildfire risks currently participate in the IWRMC, with members hailing from the United States, Canada, South America, and Australia.

IWRMC member companies address wildfire issues through participation in tactical working groups, quarterly best practice sharing webinars, and direct discussions with their peers. Through this arrangement, the consortium is designed to accelerate learning and improve existing models and approaches by providing access to more and better data while allowing for swift re-orientation and prioritization of issues as the industry adapts to the unique set of issues that arise each year. The IWRMC is oriented around four strategic areas: 1) risk management, 2) asset management, 3) vegetation management, and 4) operations & protocols. In 2021, dedicated sessions were also held that focused on Data Governance and Stakeholder Engagement. IWRMC working groups routinely conduct member surveys on specific topic areas to supplement and enhance the direct discussions that occur during working group meetings.

In addition, the electrical corporation must provide a list in tabular form of relevant electrical corporations and other entities it has shared or collaborated, or intends to continue to share or collaborate or begin sharing or collaborating, with on best practices for technical or programmatic aspects of its WMP program.

For each entity, the best practice subject, date(s) of collaboration, whether the collaboration is technical or programmatic, list of electrical corporation partners, a description of the best practice sharing/collaborative activity with a reference, and any outcomes from that sharing or activity.

Reference the Utility Initiative Tracking ID where appropriate.

The overview and table must be no longer than two pages in the main body of the WMP. The full table can be included as an appendix as needed.

Table 8-63 provides an example of the minimum acceptable level of information.

Please note that Table 8-63 is labeled as 8-64 in the OEIS Final Technical Guidelines, and the table below will be labeled as 8-64 to be consistent with the guidelines

Below SCE lists information on best practice sharing and collaboration with other electric partners.

Table 8-63 - Best Practice Sharing with Other Electrical Corporations

Best Practice Subject	Dates of Collaboration (YYYY-YYYY)	Technical or Programmatic	Electrical Corporation Partners	Description of Best Practice Sharing or Collaborating	Outcome
Risk Modeling Working Group	2022 – Ongoing	Technical	SDG&E, PG&E, Bear Valley, PacifiCorp, and Liberty	Working group meetings included information gathering and comparing risk modeling methodologies of the subject utilities.	Future working group meetings moving to understanding best practices and towards consistency on utility approaches to risk modeling.
Covered Conductor Working Group	2021 – ongoing	Technical	SDG&E, PG&E, Bear Valley, PacifiCorp, and Liberty	SCE conducts regular meetings with the joint IOUs regarding the effectiveness of covered conductor. These include meetings on estimated effectiveness, recorded effectiveness, laboratory testing, benchmarking, alternatives to covered conductor, new technologies, maintenance and inspection practices, PSPS impacts, and costs. In these meetings, the utilities share data, practices, methodologies, testing results, and future plans.	<ul style="list-style-type: none"> Confirmed effectiveness of covered conductor to prevent ignitions from contact-from-object and wire-to-wire slapping. Establishing workshops in 2023 to identify maintenance and inspection best practices, assess testing results, develop a methodology to calculate the estimated effectiveness of a combination of mitigations, assess the results of PSPS studies, and to assess each utilities' estimated effectiveness of new technologies
Vegetation Line Clearances Working Group	2022 – ongoing	Technical and Programmatic	SDG&E and PG&E	Increase alignment amongst California electrical corporations related to line clearing data collection practices and record keeping of tree-caused risk events.	PG&E, SDG&E, and SCE chose a third-party consultant to establish the data collection standards, create the cross-utility database, and study the relationship between enhanced vegetation clearances and tree-caused risk events.
Wildfire Mitigation	2021 – ongoing	Technical and Programmatic	Varies depending on engagement	SCE engages and shares best practices with industry trade associations and agencies, as well as other utilities by participating in conferences and other external events.	<p>Participating in industry conferences and other forums as well as engaging with peer utilities provide regular opportunities to share best practices on topics pertaining to wildfire mitigation, including PSPS. In 2022, SCE participated in the following external engagements, including but not limited to:</p> <ul style="list-style-type: none"> Electric Utility Consultants, Inc.'s (EUCI) "Wildfire Season Recap Summit" Conference Edison Electric Institute (EEI) FERC Transmission – Annual CEO Meetings Western Energy Institute (WEI) Wildfire Conference Western Electricity Coordinating Council (WECC) Summer Readiness

Best Practice Subject	Dates of Collaboration (YYYY-YYYY)	Technical or Programmatic	Electrical Corporation Partners	Description of Best Practice Sharing or Collaborating	Outcome
					<p>Webinar</p> <ul style="list-style-type: none"> • Institute of Electrical and Electronics Engineers (IEEE) Panels on Fire Mitigation & Grid Resiliency and Undergrounding • EEI Transmission, Distribution, Metering and Mutual Assistance Conference • North American Transmission Forum (NATF) • Tour of SCE’s Emergency Operations Center for Portland General
Risk Spend Efficiency (RSE)	2021 – 2022 (Ongoing with SDG&E and PG&E)	Technical	SDG&E, PG&E, Bear Valley, PacifiCorp, and Liberty	Working group meetings focus on utility inputs and calculations used in RSE calculations with the aim of developing a standardized approach.	Continue to interpret RSE guidelines as provided in the WMP, including effectiveness of mitigation programs. Benchmarking feedback is reviewed and adjustments to RSE calculations are considered.
EPSS	2021 – 2022	Technical and Programmatic	SDG&E and PG&E	Engagements with west coast utilities to discuss protective device settings in order to mitigate utility equipment caused wildfire ignitions.	The use of fast trip settings has been widely among peer utilities and utilities continue to look at new technologies to implement into their systems.
PSPS	2021 – ongoing	Programmatic	SDG&E and PG&E	Discussion of various aspects of PSPS community outreach and engagement.	Ongoing
Distribution Aerial Resources	Q2 2022 – Ongoing	Technical and Programmatic	SDG&E, PG&E, Duke Energy, Southern Company	Discussion of programmatic and technical aspects of distribution aerial inspections, including size and scope of program, image capture and processing, and future plans.	Ongoing

8.5.6 Maturity Advancement

SCE continually seeks alignment with government and industry organizations and practices and continues to look for opportunities to improve community outreach maturity over time.

The activities discussed in this section could lead to Community Outreach and Engagement advancements. Below is a summary of broader anticipated maturity improvements over the WMP period that supplement the objectives outlined at the beginning of the Section.

Table SCE 8-17 - Community Outreach Maturity Improvements

Capability Name	Projected Maturity Improvements
Engagement with AFN and Socially Vulnerable Populations	Improvements include hosting meetings with AFN and MBL groups on effectiveness of engagements, and to update program activities based on this feedback. Other improvements are establishing working relationships with at least one community partner for each AFN, MBL and socially vulnerable groups at the county level.

9 PUBLIC SAFETY POWER SHUTOFF

9.1 Overview

In Sections 9.1–9.5 of the WMP,²⁶⁷ the electrical corporation must:

- *Provide a high-level overview of key PSPS statistics*
- *Identify circuits that have been frequently de-energized and provide measures for how the electrical corporation will reduce the need for, and impact of, future PSPS implementation on those circuits*
- *Describe expectations for how the electrical corporation’s PSPS program will evolve over the next 3 and 10 years*
- *Describe any lessons learned for PSPS events occurring since the electrical corporation’s last WMP submission*
- *Describe the electrical corporation’s protocols for PSPS implementation*

9.1.1 Key PSPS Statistics

In this section, the electrical corporation must include a summary table of PSPS event data. These data must be calculated from the same source used in the GIS data submission (i.e., they should be internally consistent). If it is not possible to provide these data from the same source, the electrical corporation must explain why. Table 9-1 provides an example of the minimum acceptable level of information for a summary of PSPS event data.

SCE provides key PSPS event statistics by calendar year in Table 9-1. In previous WMPs, SCE provided data by fire season to better reflect data that corresponds to SCE’s tools and practices, which are updated and implemented ahead of each fire/PSPS season and revised post-season. For this WMP, SCE provides the information by calendar year pursuant to Energy Safety direction.

²⁶⁷ Annual information included in the following sections must align with Table 10 of the QDR.

Table 9-1 - PSPS Event Statistics²⁶⁸

	No. of Events²⁶⁹	Total Circuits De-energized	Total Customers²⁷⁰ Impacted	Total Customer Minutes of Interruption
Jan 1 – Dec 31 2018 ²⁷¹	2	6	148	228,227
Jan 1 – Dec 31 2019	7	267	198,826	316 million
Jan 1 – Dec 31 2020	10	424	229,800	268 million
Jan 1 – Dec 31 2021	8	232	179,502	222 million
Jan 1 – Dec 31 2022	3	13	15,784	7 million

9.1.2 Identification of Frequently De-energized Circuits

Public Utilities Code section 8386(c)(8) requires the “[i]dentification of circuits that have frequently been de-energized pursuant to a PSPS event to mitigate the risk from wildfire and the measures taken, or planned to be taken, by the electrical corporation to reduce the need for, and *impact of, future PSPS of those circuits, including, but not limited to, the estimated annual decline in circuit PSPS and PSPS impact on customers, and replacing, hardening, or undergrounding any portion of the circuit or of upstream transmission or distribution lines.*” To comply, the electrical corporation is required to populate Table 9-2 and provide a map showing the frequently de-energized circuits.

²⁶⁸ SCE’s PSPS data management capabilities and the CPUC’s PSPS reporting guidelines have continuously evolved since the inception of the PSPS program in 2018, with a significant shift in 2021 when the CPUC issued a standardized PSPS post-event reporting template and SCE transitioned to a largely automated Central Data Platform (CDP) to better manage its PSPS data. Given the differences in source data systems, data quality and methodology, SCE’s PSPS data for the 2018 through 2020 time period may not be directly comparable to data reported for 2021 and later PSPS events. Notwithstanding these differences, there has been a clear downward trend in PSPS customer impacts from 2020 to the present. Data for 2021 and 2022 has been updated to align with the methodology used in SCE’s PSPS-related reports which provide total unique customers and unique circuits de-energized per PSPS event. SCE will align its QDR submission to this methodology going forward.

²⁶⁹ The number of events includes only de-energization events (no circuits or customers are de-energized during high-threat events).

²⁷⁰ Here, “customers” is customer accounts. The electrical corporation may use electric meters as a proxy for customers.

²⁷¹ This includes data from the de-energization event that occurred on 1/1/19 as that event started in 2018.

The map must show the following:

- All circuits listed in Table 9-2, colored or weighted by frequency of PSPS
- HFTD Tiers 2 and 3 contour overlay

Examples of the minimum acceptable level of information are provided in Table 9-2.

Table 9-2 - Frequently De-energized Circuits

Entry #	Circuit ID	Name of Circuit	Dates of Outages	Number of Customers Served by Circuit	Number of Customers Affected	Measures Taken, or Planned to Be Taken, to Reduce the Need for and Impact of Future PSPS of Circuit
SCE provides the tabulated data for Table 9-2 in Appendix F: Supplemental Information.						

Note: Once populated, if this table is longer than two pages, the electrical corporation must append the table.

SCE provides the tabulated data for Table 9-2 in Appendix due to the size of the table. Figure SCE 9-01 below shows a map of the frequently de-energized circuits. SCE has provided spatial data for the frequently de-energized circuits, which can be found on SCE’s website.

Figure SCE 9-01 - Frequently De-Energized Circuits²⁷²

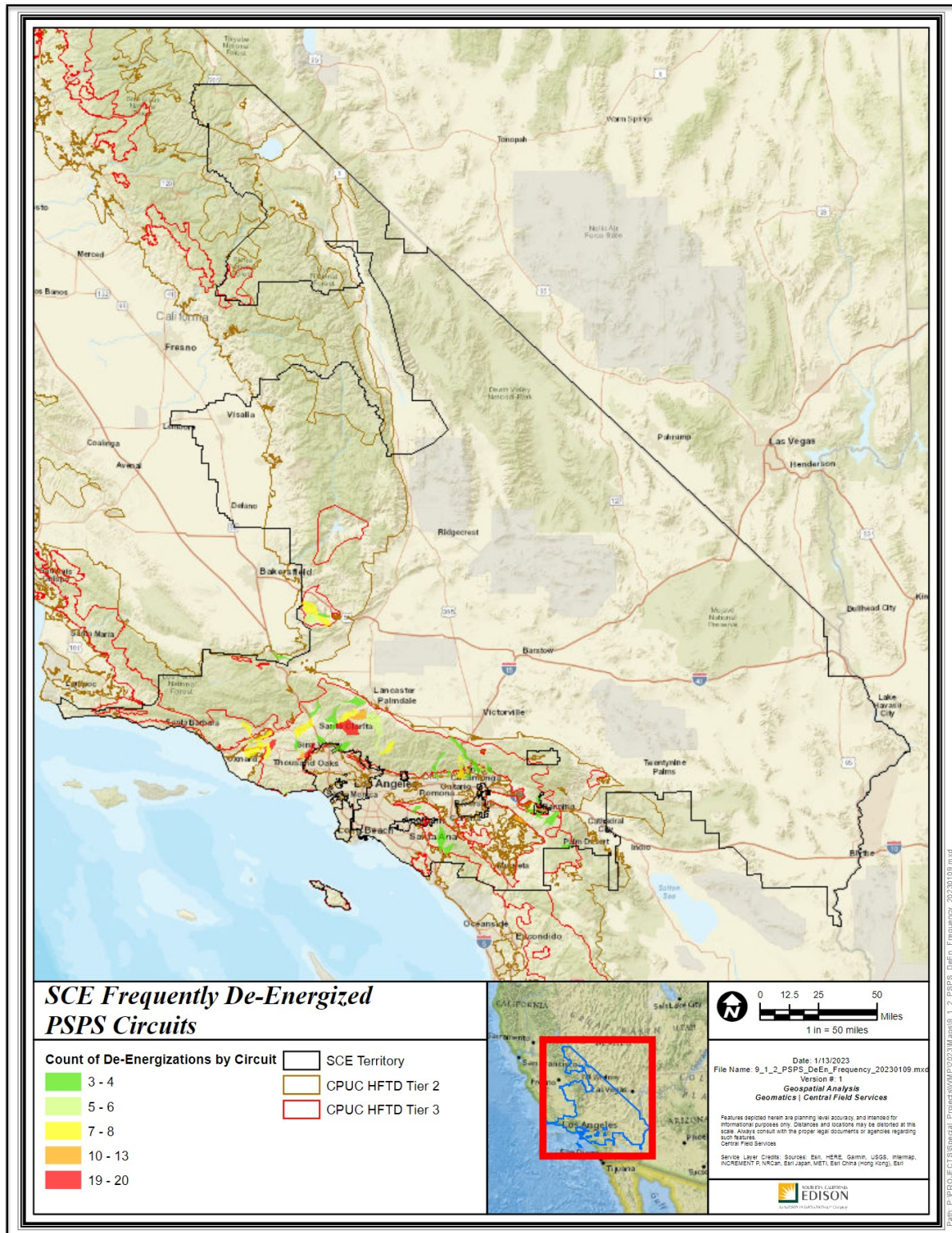

²⁷² Map as of 01/09/2023. SCE has provided the spatial data of the frequently de-energized circuits. Please see <https://www.sce.com/safety/wild-fire-mitigation>.

9.1.3 Objectives

Each electrical corporation must summarize the objectives for its 3-year and 10-year plans to reduce the scale, scope, and frequency of PSPS events.²⁷³ These summaries must include the following:

- Identification of which initiative(s) in the WMP the electrical corporation is implementing to achieve the stated objective, including Utility Initiative Tracking IDs
- Reference(s) to applicable codes, standards, and best practices/guidelines and an indication of whether the electrical corporation exceeds an applicable code, standard, or regulation
- Method of verifying achievement of each objective
- A completion date for when the electrical corporation will achieve the objective
- Reference(s) to the WMP section(s) or appendix, including page numbers, where the details of the objective(s) are documented and substantiated

This information must be provided in Table 9-3. Example of PSPS Objectives (3-year plan) for the 3-year plan and Table 9-4. Example of PSPS Objectives (10-year plan) for the 10-year plan. Examples of the minimum acceptable level of information are provided below.

SCE provides PSPS objectives for its 3-year plan in Table 9-3 and 10-year plan in Table 9-4. The objectives included in these tables focus on activities that can help to reduce the scope, duration, and frequency of PSPS events. To the extent mitigation initiatives discussed in other WMP Sections support these objectives, SCE identifies those initiative in these tables.

²⁷³ Annual information included in this section must align with Table 12 of the QDR.

Table 9-3 - PSPS Objectives (3-year plan)

Objectives for Three Years (2023–2025)	Applicable Initiative(s) & Tracking ID(s)	Applicable Regulations, Codes, Standards, and Best Practices (See Note)	Method of Verification (i.e., program)	Completion Date	Reference (section & page #)
Re-evaluate existing PSPS windspeed thresholds using engineering-based analysis that considers, among other factors, the effectiveness of covered conductor	N/A	Best Practices	Documentation demonstrating adjustments (if any) to SCE’s PPS decision-making criteria as a result of the threshold re-evaluation	Ongoing	Appendix D: Areas for Continued Improvement, ACI SCE-22-25 Increasing PPS Thresholds on Hardened Circuits, p. 784-788; ACI SCE-22-26 PPS System Damage in Consequence Modeling p. 787
Perform additional grid sectionalization and automation, paired with weather stations, to reduce the scope of PPS events	SH-5	Best practices	Grid sectionalization work is reflected in SCE’s completed work orders and will be discussed in future WMP updates	Ongoing; see annual targets outlined in Table 9-5	Section 8.1.2.8 Installation of Syst. Aut. Equipment, pp. 271-273
Evaluate emerging technology for potential incorporation into PPS protocols	REFCL (SH-17, SH-18)	Best practices	Discussion will be included in future WMP updates	Ongoing	Section 8.1.2.6 Emerging Grid Hardening Tech, pp. 266-269
Continue to increase situational awareness and improve precision of weather forecasting to help optimize the scope of PPS events	SA-1, SA-3, SA-8, SA-10	Best practices	Discussion will be included in future WMP updates WMP updates	Ongoing; see annual targets outlined in Table 9-5	Section 8.3 Situational Awareness and Forecasting, pp. 445-520

Note: An asterisk indicates that the electrical corporation exceeds a particular code, regulation, standard, or best practice. The electrical corporation must provide a reference to the appendix section and page providing further documentation, justification, and substantiation.

Table 9-4 - PSPS Objectives (10-year plan)

Objectives for Ten Years (2026–2032)	Applicable Initiative(s) & Tracking ID(s)	Applicable Regulations, Codes, Standards, and Best Practices (See Note)	Method of Verification (i.e., program)	Completion Date	Reference (section & page #)
Sufficiently harden HFRA circuits to reduce potential PSPS impacts by up to 90% ²⁷⁴	SH-1, IWMS Framework	Best Practices	Circuit threshold change log, examination of PSPS de-energization conditions	2026 - 2032	Section 8.1.2 Grid Design and Syst. Hardening pp. 250-277
Incorporate successful emerging technologies into PSPS protocols to optimize scale, scope and frequency of PSPS	REFCL (SH-17, SH-18)	Best Practices	Revised operational protocols	2026 - 2032	Section 8.1.2.6 Emerging Grid Hardening Tech, pp. 266-269

Note: An asterisk indicates that the electrical corporation exceeds a particular code, regulation, standard, or best practice. The electrical corporation must provide a reference to the appendix section and page providing further documentation, justification, and substantiation.

²⁷⁴ This analysis assumes an average PSPS threshold of 31mph sustained winds or 46mph wind gusts for bare, non-hardened circuits, and compares the average exceedance of that control point versus an average threshold of 40mph sustained winds or 58mph wind gusts for circuits with full covered conductor. Based on historical wind speed and FPI, the average circuit across SCE’s service territory breaches the approximated hardened threshold about 90% less.

9.1.4 Targets

Initiative targets are forward-looking quantifiable measurements of activities identified by each electrical corporation in its WMP. Electrical corporations will show progress toward completing targets in subsequent reports, including QDRs and WMP Updates.

The electrical corporation must list all targets it uses to track progress on reducing the scope, scale, and frequency of PSPS for the three years of the Base WMP. Energy Safety's Compliance Assurance Division and third parties must be able to track and audit each target.²⁷⁵ For each initiative target, the electrical corporation must provide the following:

- *Utility Initiative Tracking IDs.*
- *Projected targets for the three years of the Base WMP and relevant units.*
- *The expected "x% risk impact" for each of the three years of the Base WMP. The expected x% risk impact is the expected percentage risk reduction per year, as described in Section 7.2.2.2.*
- *Method of verifying target completion.*

The electrical corporation's targets must provide enough detail to effectively inform efforts to improve the performance of the electrical corporation's initiatives aimed at reducing the scope, scale, and frequency of its PSPS events.

SCE provides its targets for the next three years (2023-2025) in Table 9-5. These targets focus on initiatives that reduce the scope, duration, and frequency of PSPS events, and due to their broader benefits, are also represented in prior Sections of this WMP. Targets that support reducing customer impacts from PSPS can be found in Section 8.4.

SCE's 2023 target specific to the reduction of the scale, scope, and frequency of PSPS events is the projected reduction of customer minutes of interruption due to applying SCE's 2023 mitigation scope based on the actual PSPS de-energization locations (driven by historical weather and fuel conditions) of 2020-2022. Because exact locations of mitigations impacting PSPS have not been finalized for 2024 and 2025, SCE's targets for those years assume the same reduction as 2023 and may be updated in the future to reflect actual mitigation scope.

SCE's strive targets of customer minutes of interruption in 2023, 2024, and 2025 are contingent upon weather and fuel conditions, which are factors beyond its control. SCE's strive targets assume that weather and fuel conditions will match the average of the prior three years; to the extent such conditions are worse than the average, SCE's strive targets will no longer be meaningful.

²⁷⁵ Annual information included in this section must align with Tables 1 and 12 of the QDR.

Table 9-5 - PSPS Targets

Initiative Activity	Tracking ID	2023 Target & Unit	x% Risk Impact 2023	2024 Target & Unit	x% Risk Impact 2024	2025 Target & Unit	x% Risk Impact 2025	Method of Verification
Covered Conductor	SH-1	Install 1,100 circuit miles of covered conductor in SCE’s HFRA SCE will strive to install up to as many as 1,200 circuit miles of covered conductor in SCE’s HFRA, subject to resource constraints and other execution risks	See risk impact in Table 8-3	Install 1,050 circuit miles of covered conductor in SCE’s HFRA SCE will strive to install up to as many as 1,200 circuit miles of covered conductor in SCE’s HFRA, subject to resource constraints and other execution risks	See risk impact in Table 8-3	Install 700 circuit miles of covered conductor in SCE’s HFRA SCE will strive to install up to as many as 850 circuit miles of covered conductor in SCE’s HFRA, subject to resource constraints and other execution risks	See risk impact in Table 8-3	Completed work orders
Remote Controlled Automatic Reclosers Setting Update	SH-5	SCE will install 6 RAR/RCS sectionalizing devices subject to 2022 PSPS analysis and subject to change SCE will strive to install 17 RAR/RCS sectionalizing devices subject to 2022 PSPS analysis, resource constraints and other execution risks	See risk impact in Table 8-3	SCE will install 5 RAR/RCS sectionalizing devices subject to 2022 PSPS analysis and subject to change SCE will strive to install 17 RAR/RCS sectionalizing devices subject to 2022 PSPS analysis, resource constraints and other execution risks	See risk impact in Table 8-3	SCE will install 5 RAR/RCS sectionalizing devices subject to 2022 PSPS analysis and subject to change SCE will strive to install 17 RAR/RCS sectionalizing devices subject to 2022 PSPS analysis, resource constraints and other execution risks	See risk impact in Table 8-3	Completed work orders
Weather Stations	SA-1	Install 85 weather stations in SCE's HFRA SCE will strive to install up to 95 weather stations in SCE's HFRA, subject to resource and execution constraints	See risk impact in Table 8-23	Install 50 weather stations in SCE's HFRA SCE will strive to install up to 55 weather stations in SCE's HFRA, subject to resource and execution constraints	See risk impact in Table 8-23	Install 15 weather stations in SCE's HFRA SCE will strive to install up to 20 weather stations in SCE's HFRA, subject to resource and execution constraints	See risk impact in Table 8-23	List and location of installed weather stations
Weather & Fuels Modeling	SA-3	Equip 500 weather station locations with machine learning capabilities SCE will strive to equip up to 600 weather station locations with machine learning capabilities, subject to resource and execution constraints	See risk impact in Table 8-23	Equip 200 weather station locations with machine learning capabilities SCE will strive to equip up to 300 weather station locations with machine learning capabilities, subject to resource and execution	See risk impact in Table 8-23	Implement machine learning at remaining weather station locations that meet eligible criteria, and for additional variables deemed necessary to improve PSPS planning	See risk impact in Table 8-23	List and location of weather stations equipped with machine learning capabilities

Initiative Activity	Tracking ID	2023 Target & Unit	x% Risk Impact 2023	2024 Target & Unit	x% Risk Impact 2024	2025 Target & Unit	x% Risk Impact 2025	Method of Verification
				constraints				
Fire Spread Modeling	SA-8	Complete analytics report summarizing assessment of historical consequence data for improved fire spread modeling	See risk impact in Table 8-23	Provide vendor with analytics report and work with the vendor to complete a plan on future improvements	See risk impact in Table 8-23	Provide recommendation for how consequence metrics can be used for PSPS Decision-Making	See risk impact in Table 8-23	Final analytics report
High Definition (HD) Cameras	SA-10	Install 10 HD Cameras SCE will strive to install up to 20 HD Cameras, subject to resource and execution constraints	See risk impact in Table 8-23	Install 10 HD Cameras SCE will strive to install up to 20 HD Cameras, subject to resource and execution constraints	See risk impact in Table 8-23	No planned installs. Additional installs will be based on reassessment in 2024	See risk impact in Table 8-23	List and location of installed HD cameras
PSPS	PSPS.NonInitiative.01	<p>SCE will reduce PSPS scope, frequency, and duration by 14.9M minutes of customer interruption, based on applying SCE's 2023 mitigation scope to the actual PSPS de-energization locations (driven by historical weather and fuel conditions) of 2020-2022.</p> <p>While predicting the exogenous factors that drive future PSPS impacts is not reasonably possible, SCE will strive to keep 2023 PSPS impacts to less than 150.6M customer minutes of interruption.</p>	N/A	<p>Because exact locations of mitigations impacting PSPS have not been finalized for 2024, SCE targets a reduction of 14.9M minutes of customer interruption assuming the same reduction as 2023; SCE may update this value in the future to reflect actual mitigation scope.</p> <p>While predicting the exogenous factors that drive future PSPS impacts is not reasonably possible, SCE will strive to keep 2024 PSPS impacts of 135.7M customer minutes of interruption.</p>	[N/A]	<p>Because exact locations of mitigations impacting PSPS have not been finalized for 2025, SCE targets a reduction of 14.9M minutes of customer interruption assuming the same reduction as 2023; SCE may update this value in the future to reflect actual mitigation scope.</p> <p>While predicting the exogenous factors that drive future PSPS impacts is not reasonably possible, SCE will strive to keep 2025 PSPS impacts to less than 120.8M customer minutes of interruption.</p>	N/A	Review of year-end PSPS event data.

9.1.5 Performance Metrics Identified by the Electrical Corporation

Performance metrics indicate the extent to which an electrical corporation's Wildfire Mitigation

Plan is driving performance outcomes. Each electrical corporation must:

- *List the performance metrics the electrical corporation uses to evaluate the effectiveness of reducing reliance on PSPS²⁷⁶*

For each of these performance metrics listed, the electrical corporation must:

- *Report the electrical corporation's performance since 2020 (if previously collected)*
- *Project performance for 2023-2025*
- *List method of verification*

The electrical corporation must ensure that each metric's name and values are the same in its WMP reporting as its QDR reporting (specifically, QDR Table 2 and QDR Table 3). Metrics listed in this section that are the same as performance metrics required by Energy Safety and reported in QDR Table 2 (Performance Metrics)²⁷⁷ must match those reported in QDR Table 2. Metrics listed in this section that are not the same as any of the performance metrics identified by Energy Safety and reported in QDR Table 2 must match those reported in QDR Table 3.

The electrical corporation must:

- *Summarize its self-identified performance metric(s) in tabular form*
- *Provide a brief narrative that explains trends in the metrics*

In addition to the table, the electrical corporation must provide a narrative (two pages maximum) explaining its method for determining its projected performance on these metrics (e.g., PPS consequence modeling, retrospective analysis).

SCE provides its the performance metrics that it uses to help evaluate the goal of reducing the scope, duration and frequency of PPS in Table 9-6. The table includes recorded performance metrics for 2020, 2021 and 2022 and projected performance metrics for 2023, 2024, and 2025.

Number of CPUC reportable ignitions, wire downs, and outages in HFRA: Although these metrics benefit from the effective use of PPS, they are driven by efforts much broader than SCE's use of PPS. As such, SCE includes these metrics in the table below for completeness and provides a more detailed discussion of these three metrics and associated trends in Section 8.1.

²⁷⁶ *There may be overlap between the performance metrics the electrical corporation uses and performance metrics required by Energy Safety. The electrical corporation must list these overlapping metrics in this section in addition to any unique performance metrics it uses.*

²⁷⁷ *The performance metrics identified by Energy Safety are included in Energy Safety's Data Guidelines.*

Trends in Frequency, Scope, Duration, and Customers Impacted by PSPS Events (total)

From 2020 to 2022, SCE has experienced a general decline in frequency, scope, duration, and customers impacted by PSPS events. As reported in the 2022 WMP Update, PSPS impacts declined by a notable amount from 2020 to 2021 largely attributable to SCE's proactive PSPS mitigations and new event management tools, as well as annual variations in weather and fuel conditions. Principal among these mitigations was the expedited grid hardening performed on 72 of SCE's frequently impacted circuits. This work included the installation of covered conductor, new automated switches, approving circuit exceptions to raise PSPS thresholds or eliminated them altogether, and providing mobile generators to keep power on at some or all locations during PSPS events. PSPS impacts continued to decline from 2021 to 2022, with reductions attributable to the same factors identified above. The mitigations applied from 2021 to 2022 included targeted grid hardening plans consisting of the installation and acceleration of covered conductor scope, installation of new automated switches, and approval of new circuit exceptions to raise PSPS thresholds.

Development of Projections for Frequency, Scope, Duration, and Customers Impacted by PSPS Events (total)

To determine the 2023 projected performance metrics for scope, duration, and number of customers impacted by PSPS Events, SCE used an average of the performance metrics for 2020, 2021, and 2022, then applied a forecast reduction of expected performance improvements from targeted grid hardening work, which is 6% for scope, 9% for duration, and 15% for customers impacted by PSPS events. These percentage improvements were then extrapolated out from the 2023 projections to determine projected performance metrics for 2024 and 2025.

With regard to the performance metric for frequency of PSPS events, SCE does not project a reduction in frequency from the 2020 – 2022 average. SCE's forecast reduction is much more likely to reduce the number of circuits de-energized in its PSPS events than it is to eliminate all circuits from those events.

It is important to note that while the projected performance metrics for 2023, 2024, and 2025 are based on the recorded metrics for 2020, 2021 and 2022, the recorded metrics for 2020, 2021, and 2022 were driven by the weather and fuel conditions experienced in those years. Actual performance metrics for future years will be determined in part by as-yet unknown weather and fuel conditions in those future years and may vary from projected figures.

Table 9-6 - PSPS Performance Metrics Results by Year

Performance Metrics	2020	2021	2022	2023 Projected	2024 Projected	2025 Projected	Method of Verification (e.g., third-party evaluation, QDR)
Frequency of PSPS Events (total) ²⁷⁸	10	8	3	7	7	7	QDR, Tables 3 and 10
Scope of PSPS Events (total) ²⁷⁹	424	232	13	210	197	185	QDR, Tables 3 and 10
Duration of PSPS events (total) ²⁸⁰	4,455,936	3,700,254	112,274	2,508,101	2,282,372	2,076,958	QDR, Tables 3 and 10
Number of customers impacted by PSPS ²⁸¹	229,800	179,502	15,784	120,441	102,375	87,019	QDR, Tables 3 and 10
Number of CPUC reportable ignitions in HFRA	50	48	40	39	38	37	QDR, Tables 2 and 3
Number of wire downs in HFRA	379	468	316	361	360	361	QDR, Tables 2 and 3
Number of outages in HFRA	2,824	2,356	2,404	2,018	1,946	1,892	QDR, Tables 2 and 3

²⁷⁸ Frequency of PSPS Events definition: Number of instances where utility operating protocol requires de-energization of a circuit or portion thereof to reduce ignition probability, per year. Only include events in which de-energization ultimately occurred.

²⁷⁹ Scope of PSPS Events definition: Circuit-events, measured in number of events multiplied by number of circuits de-energized per year.

²⁸⁰ Duration of PSPS events definition: Customer hours per year.

²⁸¹ Number of customers impacted by PSPS definition: Number of customers impacted by PSPS (if multiple PSPS events impact the same customer, count each event as a separate customer).

9.2 Protocols on PSPS

The electrical corporation must describe its protocols on PSPS implementation including:

- *Risk thresholds (e.g., wind speed, FPI, etc.) and decision-making process that determine the need for a PSPS. Where the electrical corporation provides this information in another section of the WMP, it must provide a cross-reference here rather than duplicating responses.*

SCE deploys wildfire mitigation measures to reduce the probability of ignitions associated with electrical infrastructure in HFRA. These activities include grid hardening measures such as installation of covered conductor, repair or replacement of equipment on poles (e.g., crossarms, transformers), and installation of protective devices (e.g., fast acting fuses).²⁸² In addition, SCE has implemented operational practices including enhanced inspections, vegetation management, and fire climate zone operating restrictions²⁸³ in high fire risk areas. Certain protective measures such as fast curve settings and fire climate zone operating restrictions are applied to a majority of high fire risk circuits and are typically in effect for the duration of the fire season; other activities such as covered conductor are permanent and in place year-round.

SCE's PSPS wind speed thresholds are higher for circuits or isolatable circuit segments that are fully hardened with covered conductor, thereby potentially limiting the frequency, duration and number of customers affected by PSPS during fire weather events. However, during severe conditions, there is heightened risk of ignitions at higher windspeeds primarily due to the possibility of infrastructure damage which can cause wind-driven foreign objects or airborne vegetation coming into contact with and damaging SCE's equipment. Under these circumstances, the deployment of covered conductor may not sufficiently mitigate wildfire and public safety risk, and PSPS is necessary as a last resort mitigation measure to prevent ignitions that may lead to significant wildfires.

Leading up to and during a PSPS event, SCE utilizes real-time weather station data and, if available, information from SCE field observers on the ground for enhanced situational awareness to forecast and monitor prevailing environmental conditions (e.g., wind gusts) that can lead to potential damage to equipment or the potential for airborne vegetation or flying debris to contact and damage equipment, to inform de-energization decisions. For circuits that are in scope, SCE also conducts pre-patrols to visually inspect the entire length of each circuit or circuit segment to find any imminent hazards or equipment vulnerabilities that require immediate remediation and to provide additional intelligence on field conditions. If concerns are discovered on a circuit in scope, they are addressed before the impending wind event, if possible.

²⁸² Fast curve settings reduce fault energy release by increasing the speed with which a protective relay reacts to most fault currents. Fast curve settings can reduce heating, arcing, and sparking for many faults compared to conventional protection equipment settings. Please see Sections 8.1.2.8.2 and 8.3.3.1.2.4 Protective Relays—Fast Curves for more details on fast curve settings technology.

²⁸³ SCE's System Operating Bulletin No. 322 includes provisions for enabling fast curve settings on distribution reclosers and circuit breakers, recloser blocking, line patrols and requirements for personnel to be physically present when operating air-break switching devices.

SCE makes every effort to limit the scope, duration and impacts of PSPS for as many customers as possible. This includes adjusting wind speed thresholds higher for circuits or segments that have covered conductor installed and leveraging sectionalization equipment to switch some customers to adjacent circuits not impacted by PSPS or otherwise remove them from scope.

SCE's PSPS decisions are based on quantitative analyses while accounting for qualitative factors such as the impacts to emergency services. SCE uses preset thresholds for dangerous wind conditions that create increased fire potential (including wind speeds, humidity, fuel moisture levels and other factors as the basis for PSPS decision-making, as described in SCE's technical paper²⁸⁴). These thresholds are set individually for each of the circuits in SCE's HFRA.

All circuits have an activation threshold, defined by the FPI and the wind speed at which they are considered at risk. Activation thresholds are computed for each circuit.

FPI is based on weather and fuel (e.g., vegetation) conditions which include sustained wind speed, dew point depression (dryness of the air), the state of green-up or curing of the annual grasses, live fuel moisture, and dead fuel moisture. The FPI also considers fuel loading, which is the amount of vegetation on the ground. Please see Section 8.3.6 where FPI is covered in detail.

For each PSPS event, every circuit also has a de-energization threshold. De-energization thresholds are determined separately for each circuit to prioritize circuits for de-energization based on the specific risks of the event. This is particularly important for large events where many circuits must be evaluated simultaneously. There are a handful of circuits that have legacy thresholds below the National Weather Service (NWS) advisory level because they have a history of local circuit outages at lower wind speeds.

De-energization thresholds account for circuit health, including any pending maintenance issues or other concerns identified through patrols, and are also informed by a consequence score that estimates the potential impact of an ignition on communities. The higher the score, the greater the risk to a particular location from wildfires. The method for calculating this score is described in detail in Section 6.2.2.2. SCE's process for determining de-energization thresholds is outlined below.

²⁸⁴ SCE's technical paper titled "Quantitative and Qualitative Factors for PSPS Decision-Making" is available at https://download.newsroom.edison.com/create_memory_file/?f_id=609d61cbb3aed37d0f3d5f6a&content_verified=True.

Figure SCE 9-02 - PSPS Decision Making Flowchart / Diagram

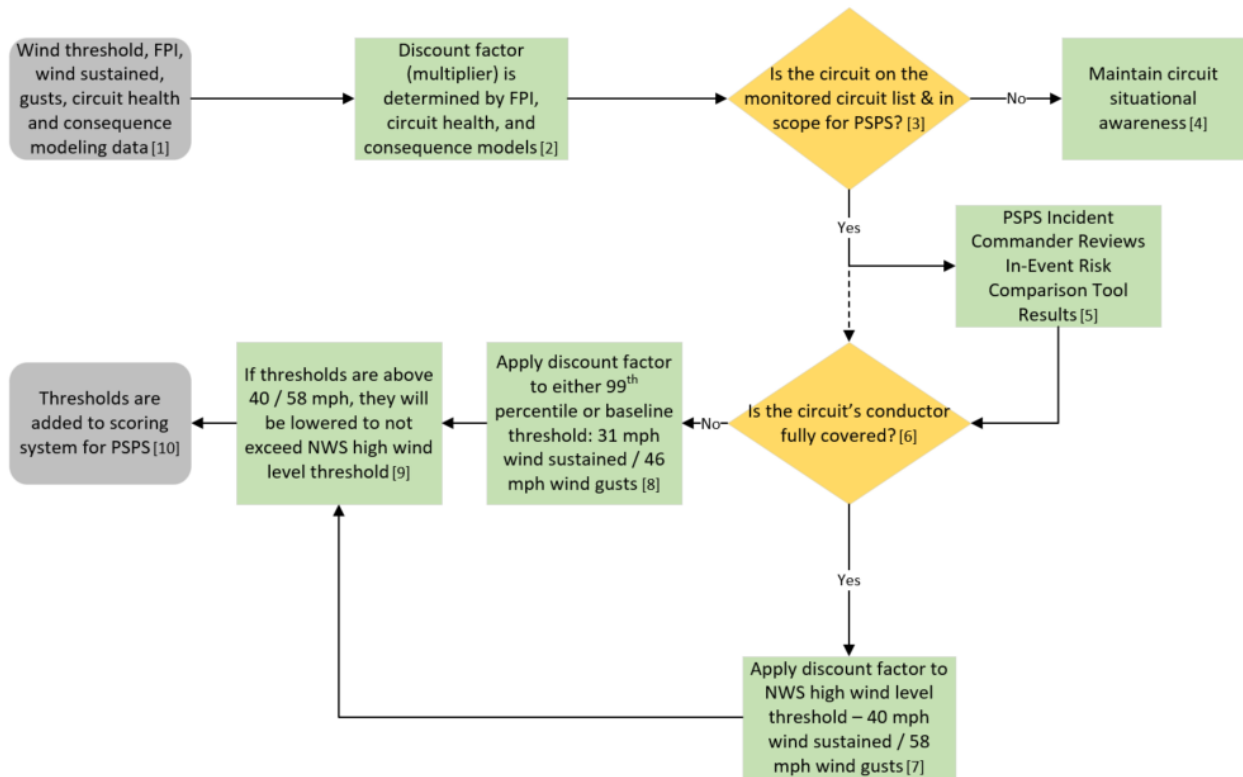

Figure SCE 9-02 shows the PSPS decision-making flowchart. The detailed flowchart steps are outlined below:

- Box 1: Data related to wind threshold, FPI, and circuit health, and consequence modeling data are gathered from various sources.
- Box 2: A discount factor may be applied based on FPI, circuit health, and consequence models to circuits which are considered to be a higher wildfire risk, or in large scale events when many circuits are under consideration for shutoffs. This discount factor will lower the threshold for potential de-energization.
- Box 3: This decision box provides direction based on whether the circuit in question is on the monitored circuit list and in scope for PSPS.
- Box 4: If the circuit is not on the monitored circuit, the IMT maintains situational awareness for increased wind speeds and risk of wildfire.
- Box 5: If the circuit is on the monitored circuit list and in scope, the Incident Commander reviews the in-event risk comparison tool results for the circuit, which compares estimated wildfire risks against potential PSPS impacts. This information helps inform the Incident Commander's decision to de-energize.
- Box 6: This decision box provides direction based on whether a circuit's conductor is fully covered.

- Box 7: If the circuit's conductor is fully covered, the discount factor (identified in box 2) is applied to the NWS high wind level threshold.
- Box 8: If the circuit's conductor is not fully covered, the discount factor (identified in box 2) is applied to either the 99th percentile or baseline threshold of 31 / 46 mph.
- Box 9: If the discounted thresholds are above the current NWS high wind level threshold of 40 / 58 mph, the thresholds will be lowered to not exceed the NWS high wind level threshold to ensure the NWS high wind level threshold is the upper threshold limit.
- Box 10: The circuit threshold outcome from this process is added to the scoring system for the PSPS event.

If actual conditions suggest more wildfire risk, or in large-scale events when many circuits are under consideration for shutoffs, the de-energization thresholds may be lowered (discounted), meaning power on a circuit will be turned off at lower wind speeds. This step prioritizes the circuits that represent the highest risk to be evaluated for de-energization before circuits at lower risk. Conversely, de-energization thresholds are raised for circuits or isolatable circuit segments that have had covered conductor installed. The de-energization threshold for segments with covered conductor is 40 mph sustained/58 mph gusts, which aligns with the NWS high wind warning level for windspeeds at which infrastructure damage may occur. Once SCE's in-house meteorologists confirm forecasts show an upcoming breach of FPI and circuit-specific wind speed thresholds, SCE activates its PSPS IMT and begins preparations for the upcoming event.

The IMT begins notifications to First Responders, Public Safety Partners, local governments, tribal governments and critical infrastructure providers in the 72-48 hour window from the anticipated start of the period of concern when possible. Notifications to all other customers are initiated 48 hours-24 hours prior to anticipated de-energization when possible. We continue to provide additional notifications as well as notifications of imminent de-energization as information becomes available during the PSPS events.

SCE also takes proactive measures to reduce the likelihood and impact of the pre-emptive de-energization of a transmission line. Since SCE's transmission lines in HFRA can transport large amounts of power to load centers (i.e., distribution networks) and are interconnected with adjacent utilities, transmission line outages have the potential to cause significant impacts to public safety and electric system reliability. To address these factors, SCE implemented PSPS protocols for transmission lines that traverse HFRAs. These operating protocols have been created to gauge the reliability risks associated with the pre-emptive de-energization of transmission lines including analyzing forecasted fire weather conditions, identifying hazardous field conditions, performing reliability risk assessments based on expected grid conditions during a PSPS event, and developing mitigation plans to address such events. Any operating conditions and assessments requiring mitigation plans to reduce potential impacts are communicated and coordinated with the CAISO so that resources and expected actions are performed in advance of a PSPS event.

Additional protocols are designed to prevent re-energizing transmission lines after a fault, when live field monitoring is taking place on a distribution line that is within one mile of a

transmission line. When a transmission line is within the one-mile boundary of a monitored distribution line, the transmission line has operating restrictions placed into effect to prevent an automated or manual re-energization if the transmission line was to relay. If the transmission line relayed, it would require a patrol of the HFRA to ensure the line is safe, prior to being re-energized.

- *Method used to compare and evaluate the relative consequences of PSPS and wildfires.*

Twenty-four hours before the onset of the period of concern, SCE assesses and compares potential public safety risks associated with proactive de-energization (PSPS risk) and simulated wildfire risk (PSPS benefit in avoiding a wildfire) for all circuits in scope, using its PSPS In-Event Risk Comparison Tool (Tool).²⁸⁵ Inputs into this tool include in-event weather, wildfire simulation models, as well as circuit-specific data. The results of the analysis are displayed in the Central Data Platform (CDP) shown below, Figure SCE 9-03 and are used by SCE Incident Commanders to inform de-energization decisions, in conjunction with other quantitative and qualitative factors as described above. Incident commanders consider the output of the Tool to assess the risk versus the benefit of de-energization on a circuit-by-circuit basis. CDP is discussed in further detail in Section 8.3.3.5.2.

Figure SCE 9-03 - View of In-Event Risk Comparison Tool in CDP

Circuit	MCL /WL	All Customers	Population	AFN NRCI Multiplier	Firecast Acres	Firecast Buildings	Firecast Population	PspS Risk	Wildfire Risk	FireCast Output (100%)
ROTEC	MCL	1742	5226	1.04	154.86	5	8	0.00036	0.00082	2.26
SONOMA	MCL	1778	5334	1.19	306.54	46	66	0.00037	0.00485	12.95

²⁸⁵ Pursuant to Ordering Paragraph 2 of the Order Instituting Investigation on the Commission’s Own Motion on the Late 2019 Public Safety Power Shutoff Events decision issued in June 2021 (D.21-06-014, OP 2, p. 284), SCE developed its In-Event Risk Comparison Tool. This tool was used starting with the PSPS event in September 2021 and is detailed in each of SCE’s subsequent post-event reports.

The comparative PSPS and wildfire risk estimates are based on the following circuit-specific criteria and information:

1. PSPS Risk: Customers served, estimated population, and the relative ranking of the circuits in scope by the percentage of Access and Functional Needs (AFN) and Non-Residential Critical Infrastructure (NRCI) customers.
2. Wildfire Risk: Wildfire simulations (using Technosylva FireCast²⁸⁶ modeling) for potential ignitions based on dynamic, in-event weather and wind conditions in proximity to the circuits in scope for de-energization. These conditions are used to determine the extent of an estimated fire footprint (or fire shed). The risk of a wildfire is calculated based on the number of structures, population, and acres potentially threatened within the simulated fire shed. This information is used to calculate potential Safety, Financial, and Reliability impacts (or attributes) of: (1) a wildfire and (2) a proactive de-energization event, as summarized in the table below:

Table SCE 9-01 - Wildfire and PSPS Consequences

Risk Attribute	Wildfire Consequences	PSPS Consequences
Safety	SCE calculates the estimated number of fatalities and serious injuries based on a forecast of impacted population within the Technosylva wildfire consequence simulation. This number, in turn, is converted into the Safety index.	SCE leverages epidemiological studies and information drawn from past widespread power outage events including the 2003 Northeast Blackout, the 2011 Southwest Blackout, and the IOUs' 2019 PSPS post-event reports. ²⁸⁷ The resulting estimates of fatalities and serious injuries per customer minutes interrupted (CMI) are intended to approximate potential safety consequences due to the power outage, such as illnesses resulting from food spoilage or exacerbation of existing underlying health conditions. SCE enhanced the PSPS safety attribute through the application of a circuit-specific AFN/NRCI multiplier. This multiplier represents the relative ranking of each circuit based on the number of AFN and NRCI customers on the circuit.
Reliability	SCE assumes 24 hours without power per customer on each circuit in scope due to wildfire. This duration was used to maintain consistency with Technosylva fire propagation simulation, as well as the PSPS impact duration.	SCE estimates the total CMI due to proactive de-energization on a circuit. It is the product of the number of customers on a circuit and the total number of minutes of estimated interruption. SCE assumes 1,440 CMI per customer (24 hours x 60 minutes) to represent de-energization over a 24-hour period.

²⁸⁶ Technosylva is a suite of wildfire simulation models or tools. While relying on a similar underlying fire propagation engine, each model is designed to support a unique use case. FireCast is specifically designed to forecast ignition risk associated with electric utility assets over a 3-day horizon based on expected short-term weather conditions.

²⁸⁷ See, e.g., Anderson, G.B., Bell, M.B (2012). Lights Out: Impact of the August 2003 Power Outage on Mortality in New York, NY, *Epidemiology* 23(2) 189-193. doi: 10.1097/EDE.0b013e318245c61c.

Risk Attribute	Wildfire Consequences	PSPS Consequences
Financial	SCE calculates the financial impact of wildfire by assigning a dollar value to the buildings and acres within the fire shed potentially threatened by wildfire. For buildings, SCE uses a system average replacement value assumption. For acres, SCE uses assumed costs of suppression and restoration. ²⁸⁸	SCE conservatively assumes \$250 ²⁸⁹ per customer, per de-energization event to quantify potential financial losses for the purpose of comparing PSPS risk to wildfire risk. The figure represents potential customer losses, such as lost revenue/income, food spoilage, cost of alternative accommodations, and equipment/property damage. This value is based on a Value of Lost Load (VoLL), which is a widely accepted industry methodology to estimate a customer’s willingness to accept compensation for service interruption. VoLL is dependent on many factors, including the type of customer, the duration of the outage, the time of year, the number of interruptions a customer has experienced. SCE’s VoLL estimate is consistent with academic and internal studies to estimate VoLL for a single-family residential customer for a 24-hour period.

SCE quantifies the resulting PSPS risks and wildfire risks using natural unit consequences for each risk type or attribute—structures impacted, acres burned, customer minutes interrupted, serious injuries and fatalities, etc. “Safety” risk is expressed as an index, “Reliability” risk is measured in terms of CMI, and “Financial” risk is measured in dollar amounts.

SCE then applies a MARS framework to convert these natural unit consequences to unitless risk scores—one score for PSPS risks and one score for wildfire risks.²⁹⁰ These risk scores are compared to each other by dividing the wildfire risk score (i.e., the potential benefit of PSPS) by the PSPS risk score (i.e., the potential public harm of PSPS), yielding a benefit/risk ratio for each circuit in scope of the PSPS event. If the resulting ratio is equal to 1, the risks are equivalent. If the ratio is greater than one, the wildfire risk exceeds the PSPS risk (the higher the resulting number, the more the wildfire risk outweighs the PSPS risk). If the ratio is less than 1, the PSPS risk outweighs the wildfire risk.

²⁸⁸ Suppression costs are based on a five-year average of California’s reported wildfire suppression costs from 2016-2020. Restoration costs are assumed to be \$1,227/acre based on research papers published by the Bureau of Land Management.

²⁸⁹ SCE utilizes \$250 per customer, per de-energization event to approximate potential financial losses on average, recognizing that some customers may experience no financial impact, while other customers’ losses may exceed \$250. The \$250 value is a conservative assumption used for the limited purpose of estimating the potential financial consequences of PSPS as one of many inputs into SCE’s PSPS In-Event Risk Comparison Tool. It is not an acknowledgment that any given customer has or will incur losses in this amount, and SCE reserves the right to argue otherwise in litigation and other claim resolution contexts, as well as in CPUC regulatory proceedings.

²⁹⁰ MARS is SCE’s version of MAVF and is further described in Section 6.1.1.

- *Outline of the strategic decision-making process for initiating a PSPS (e.g., a decision tree). Where the electrical corporation provides this information in another section of the WMP, it must provide a cross-reference here rather than duplicating responses.*

SCE considers PSPS when weather and fire experts forecast dangerous conditions including strong winds, very dry vegetation and low humidity. Combined, these create the risk that flying debris or other damage to wires and equipment could cause a fire with the potential to spread rapidly. SCE's strategic decision-making process for initiating a PSPS de-energization event is described below.

At up to 72 hours before a forecast potential PSPS event (event), SCE meteorologists and fire scientists continue to review weather conditions, using both internal and external weather models and National Weather Service forecasts, alerts, and warnings. The PSPS Incident Management Team (IMT) is activated and develops a list of circuits that could potentially be impacted by a PSPS event based on the forecast and predictive modeling. If the weather report is inconclusive, SCE will wait for additional weather reports or field assessments before notifying customers. SCE confers with the National Geographic Area Coordination Center (GACC) about fire danger risks. Additionally, the PSPS IMT reviews options for supplying customers with power from alternate circuits to keep them energized.

Field crews are deployed in advance of the potential event to look for factors that could increase the risk of fire such as damage or other hazards to poles and wires. SCE also deploys live field observers (LFOs),²⁹¹ who provide critical situational awareness during the event to inform PSPS decision-making. These observers can identify flying debris, and other hazardous conditions that may be present at the impacted area. SCE also uses drones, when feasible, to provide aerial patrols of overhead lines associated with PSPS events and supplement traditional patrol methods—via truck, foot, and/or helicopter—to help identify ignition risks such as vegetation contacting lines before fire weather conditions materialize (pre-patrol).

At 48 hours before an event, the IMT looks at the daily weather report to see if the weather pattern has shifted. As the forecast becomes more precise, the IMT will update the list of circuits that might be impacted. If the weather pattern has weakened or shifted outside of high fire risk areas, the IMT will cancel the PSPS event.

At 24 hours before an event, the IMT looks at the twice-daily weather report to see if the weather pattern has shifted and updates the list of circuits that might be impacted. Additionally, the In-Event Risk Comparison Tool is run once to compare the risk of de-energization against the risk of wildfire. The Firecast does not come into play if the established FPI (discussed in section 9.2.1) does not warrant de-energization.

At 3-6 hours before winds are forecasted to breach PSPS thresholds, the IMT monitors field weather stations. A team, including experts in grid operations, meteorology and fire science, advise the Incident Commander, who will make the final decisions to shut off power. The team has access to more than 1,620 SCE weather stations to monitor changing conditions. As the winds increase, field crews provide mobile weather reports from hand-held weather and wind-speed meters and report flying debris or other hazards.

²⁹¹ Please see Section 8.3.2.1.4 for additional details on LFOs.

During the period of concern, weather station readings are routinely updated for each circuit. This near real-time information allows meteorologists to identify weather trends that could affect decisions. Based on these in-event weather readings and field observations, the Operations Section Chief recommends shutting off power to a circuit or segment when wind speeds are about to hit or exceed their pre-determined threshold for unsafe conditions, or field crews advise of an urgent hazard in the field. This recommendation is made to the incident commander, who reviews the recommendation and asks follow-up questions, if necessary, before approving the decision to de-energize.

After concerning weather conditions have abated, SCE dispatches crews to patrol all circuits that have been de-energized for PSPS to check for damage to equipment or lines and that it is safe to restore power. Drones may also be used to survey overhead lines. For multiday events, with gaps of even a few hours, field crews will attempt to restore customers before the second period of concern begins. If there is no damage to the lines, electricity will be restored to all customers when safe to do so.

SCE also describes its decision-making process in a decision-making fact sheet, in SCE's technical paper titled "Quantitative and Qualitative Factors for PSPS Decision-Making," and in its PSPS decision-making video, which are all available at <https://energized.edison.com/psps-decision-making>.

- *Protocols for mitigating the public safety impacts of PSPS, including impacts on first responders, health care facilities, operators of telecommunications infrastructure, and water electrical corporations/agencies.*

SCE offers assistance to Critical Facility and Infrastructure (CFI) customers who may require additional assistance and advanced planning to ensure resiliency and continuity during de-energization events. SCE conducts various outreach activities throughout the year.

SCE also works collaboratively with local governments, first responders and essential service providers to provide awareness of PSPS and to educate them on the importance of developing a resiliency plan that addresses backup power needs for facilities that provide critical life and safety functions. Many of these customers are required by law or industry standards to have backup generation in place to sustain critical operations in the event of a power outage, regardless of outage type. Other customers that are not required to have backup generation are still encouraged to consider adding this capability if they feel they have critical needs that must continue in a power outage.

In 2022, SCE conducted workshops for water agencies, communications sector, food banks, healthcare sector, school districts, chemical, sub-transmission level customers, and primary-metered customers. In these workshops, the importance of having a resiliency plan, potentially including backup generation, was discussed in preparation of the wildfire season. If essential service providers do not have the ability to sustain critical life and safety operations during an extended power outage, SCE will consider requests to provide temporary portable backup generation on a case-by-case basis. SCE typically coordinates these requests with its county emergency management agency partners to identify and prioritize backup generation needs requested by the county. Please see Section 8.5 for additional details on community engagement and outreach.

SCE fosters strong relationships with Public Safety Partners at the local and State levels to effectively coordinate and manage emergency events, including PSPS events. Section 8.4.1 discusses near and long-term objectives for emergency planning and preparedness. To continue to strengthen these relationships, SCE is working to improve engagement, help ensure timely and accurate data sharing, proactively and quickly address issues, and simplify information shared with local and State Emergency Management, first responders and Public Safety Partn

ers during PSPS events. SCE also performs surveys and in-person (or virtual) after-action reviews after PSPS events and shares the results of these surveys with partners and the CPUC to measure improvement.

In addition, a key tool used to foster this coordination and emergency event management is SCE's Public Safety Partner Portal, which was launched in June 2021 to improve situational awareness during PSPS events for first responders and operators of critical facilities and communications systems. It features near real-time PSPS information not publicly available on sce.com. Data on the Portal is also fed through SCE's PSPS representational state transfer (REST) service. Subject to appropriate confidentiality measures, expanded information is provided to enable better coordination of event response between SCE and Public Safety Partners. To gain access to the Portal, partners register, review a user agreement, and set up multi-factor authentication. The Portal is a single destination to find information regarding PSPS planning (pre-event) and active PSPS events, and to access to an archive of post-PSPS event data. SCE conducted a benchmarking review with SDG&E and PG&E concerning their experiences with a similar portal and leveraged this review to develop SCE's Portal.

Subscribers can access the following information on the Public Safety Partner Portal:

- Planning Information (Pre-Event): information for planning purposes when there is no active PSPS event. The information available will include:
 - PSPS planning interactive map (GIS layers, KMZ, Shapefile, File Geodatabase, GeoJSON), which includes outage areas and impacted circuits
 - Planning files for Outage areas and impacted circuits in various downloadable formats and API to allow integration with third-party systems.
 - Planning Reports in tabular format including summary of potentially impacted customers, Critical facilities and identified MBL and critical care customer counts.
- Circuit to zip code mapping files.
- Critical Facility and infrastructure (CFI) customers can view their own contact information.
- Event Information: active PSPS event information and certain archived PSPS event information. The information available will include:
 - PSPS event interactive map, which includes outage areas, impacted circuits, and locations of Community Resource Centers and Community Crew Vehicles.

- Event-specific files, which includes outage areas and impacted circuits in various downloadable formats and API to allow integration with third-party systems.
- Event-specific reports including summary of impacted customers, Critical facilities and identified MBL and critical care customer counts.
- Also available in various downloadable formats and API on the Portal are the following:
 - Reports including situational awareness and data.
 - Archive of certain information from past events.

SCE continues to assess additional functionalities for the Public Safety Partner Portal, including those suggested by partners. Updated functionality is communicated to partners through office hour meetings and direct briefings. For example, SCE has recently added transmission line layers to the Portal mapping tool based on feedback received from partners. SCE continues to solicit feedback in multiple forums, including benchmarking with other utilities, and seeks to continue to enhance the Portal for its Public Safety Partner community.

9.3 Communication Strategy for PSPS

In Section 8.4.4 of the WMP, the electrical corporation must discuss all public communication strategies for wildfires, outages due to wildfires and PSPS, and service restoration. Thus, in this section, the electrical corporation is only required to provide a cross-reference to Section 8.4.4 and any other section of the WMP providing details of the emergency public communication strategy for PSPS implementation.

Section 8.4.5 describes SCE’s emergency public communication strategy for PSPS.

9.4 Key Personnel, Qualifications, and Training for PSPS

In Section 8.4.2.2 of the WMP, the electrical corporation must discuss all key personnel planning, qualifications, and training for wildfires, outages due to wildfires, and PSPS, and service restoration. Thus, in this section, the electrical corporation is only required to provide a cross-reference to Section 8.4.2.2 and any other section of the WMP providing details of key personnel, qualifications, and training for PSPS implementation.

Section 8.4.2.2 describes SCE’s key personnel planning, qualifications, and training for wildfires, outages due to wildfires, and PSPS, and service restoration.

9.5 Planning and Allocation of Resources for Service Restoration due to PSPS

In Section 8.4.5.2 of the WMP, the electrical corporation must address planning of appropriate resources (e.g., equipment, specialized workers) and allocation of those resources to assure the safety of the public during service restoration. Thus, in this section, the electrical corporation is only required

to provide a cross-reference to Section 8.4.5.2 and any other section of the WMP providing details of resource planning for PSPS implementation.

Section 8.4.6.2 describes SCE's planning of appropriate resources and allocation of those resources to assure the safety of the public during service restoration.

10 LESSONS LEARNED

An electrical corporation must use lessons learned to drive continuous improvement in its WMP. Electrical corporations must include lessons learned due to ongoing monitoring and evaluation initiatives, collaboration with other electrical corporations and industry experts, and feedback from Energy Safety and other regulators.

The electrical corporation must provide a summary of new lessons learned since its most recent WMP submission, and any ongoing improvements to address existing lessons learned. This must include a brief narrative describing the new key lessons learned and a status update on any ongoing improvements due to existing lessons learned. The narrative should be limited to two pages.

SCE provides detail, status updates, and implementation plans for various existing and new lessons learned in Table 10-01 below. In Table SCE 4-01 of its 2022 WMP, SCE identified several lessons learned across WMP categories that were in flight. SCE summarizes a few of these lessons learned as well as progress made in advancing them below.

Resource Allocation – Risk Spend Efficiency: SCE had endeavored to create additional RSEs for activities to help inform our decision-making process. SCE has continued this effort since its 2022 WMP by advancing the development of RSEs for its WMP initiatives and emerging technologies. For example, SCE developed additional RSEs for emerging technologies since our last WMP. Additional information can be found in Appendix D under the ‘SCE-22-23 RSE Estimates of Emerging Initiatives’ section. In addition, SCE engages an independent third-party to evaluate our RSE development process and calculations. Further information can be found in Appendix D under the ‘SCE-22-23 Third Party Confirmation of RSE Estimates’ section.

Risk Assessment and Mapping: In 2021-2022, SCE developed a new framework to identify locations in which the wildfire risk is not fully captured by ignition simulations alone. SCE has finalized this framework in 2022, which SCE refers to as the Integrated Wildfire Mitigation Strategy Risk Framework (IWMS Risk Framework or IWMS) in this 2023 WMP. The strategy entails identifying risk tranches within SCE’s HFRA based on consequence to customers and communities in the event of an ignition. The highest risk locations, categorized as Severe Risk Areas, considers risk factors such as egress route constraints, historical fire frequency, ignitions with potential to develop into large fires, as well as locations likely to exceed PSPS thresholds even with covered conductor installed. While SCE initially used this framework to prioritize and scope grid hardening work, we have since expanded its application into Vegetation Management and Asset Inspections & Remediations areas in this WMP. SCE describes these efforts in Section 5 and 6, as well as in the relevant areas of Section 8.

Grid Design and System Hardening: In 2021, 30% of CPUC-reportable ignitions involved secondary conductors across SCE’s service territory, with 25% of these ignitions occurring within HFRA. To mitigate these high-risk secondary conductor locations, SCE added questions to the inspection survey during the 3rd quarter of 2021 as well as provided additional training not only on the form but on the specific issues to look for during the inspection, such as damaged secondaries. Additional information can be found in Appendix D under “SCE-22-17 Address Secondary Conductor Issues.”

Asset Management and Inspections: To reduce customer and environmental impacts, improve notification identification and safety as well as overall efficiency, SCE piloted a new approach to perform ground and aerial inspections at the same time (aka “360 inspections”) for overhead distribution (33 kV and below) in HFRA instead of performing them separately. SCE rolled out this pilot for distribution inspections during Q2 2022. Based on the results of this pilot, in 2023, SCE is expanding this approach for its HFRA distribution detailed inspections. Additional information can be found within Section 8.1.3.1 for Asset Inspections.

Stakeholder Cooperation and Community Engagement: In 2021 and 2022, the quick reaction force (QRF) of aerial resources was effective at suppressing fire activity based on performance reports and feedback from local fire agencies. The partnership with local fire agencies, which began in 2019, funds up to four aerial firefighting helicopters, support personnel as well as equipment to bolster firefighting capabilities. These resources are capable of being rapidly deployed in SCE’s service area and have proven to be extremely effective during an extended attack phase, reducing the area burned and number of structures damaged or destroyed. In 2023, SCE has entered into an agreement to fund aerial suppression resources for the entire year, instead of over a 5-6-month period as in years past. This will allow these resources to be available during what has become a year-round fire season. Additional information on this can be found within Section 8.4.3.3.1 for Emergency Preparedness.

The electrical corporation must also provide a summary of how it continuously monitors and evaluates its wildfire mitigation efforts to identify lessons learned. This must include various policies, programs, and procedures for incorporating feedback to make improvements.

SCE’s wildfire mitigation efforts have continued to grow and advance to mitigate the threat of wildfires in HFRA. SCE continuously evaluates its wildfire mitigation initiatives based on execution experience, internal analysis, stakeholder feedback, benchmarking, customer surveys and post-event PSPS reports. This evaluation process includes monitoring the implementation of WMP initiatives along with the effectiveness of those WMP initiatives. SCE also provides detail on its Corrective Action Program within Section 11 which includes discussion on how we investigate, learn from, and develop mitigations for risk events.

At a high level, SCE, as applicable, leverages a lesson learned process as depicted in Figure SCE 10-01 below.

Figure SCE 10-01 - Lessons Learned Process

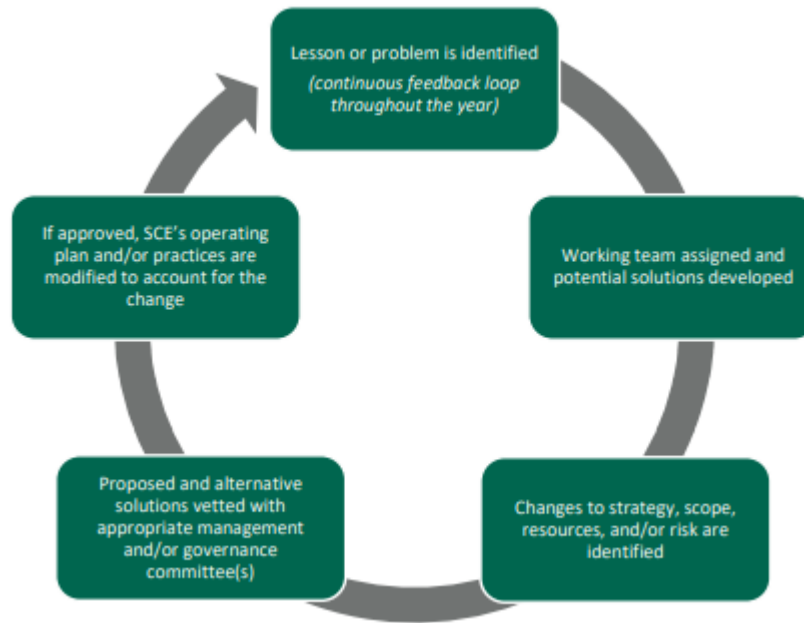

Lessons learned can be divided into the three main categories: (1) internal monitoring and evaluation, (2) external collaboration with other electrical corporations, and (3) feedback from Energy Safety or other authoritative bodies. The following are examples of specific potential sources of lessons learned:

- *Internal monitoring and evaluation initiatives:*
 - *Tracking of risk events*
 - *Findings from root cause analyses and after-action reviews*
 - *Drills and exercises*
 - *Feedback from community engagement*
 - *PSPS events*
- *Feedback from Energy Safety or other authoritative bodies:*
 - *Areas for continued improvement identified by Energy Safety in the previous WMP evaluation period*
 - *Findings from wildfire investigations*
 - *Findings from Energy Safety Compliance Division assessments*
 - *Collaborations with other electrical corporations*

In addition to the above potential sources of lessons learned, the electric corporation must detail lessons learned from any and each catastrophic wildfire ignited by its facilities or equipment in the past 20 years,

as listed in Section 5.3.2. The electric corporation must also detail specific mitigation measures implemented as a result of these lessons learned and demonstrate how the mitigation measures are being integrated into the electric corporation's wildfire mitigation strategy.

Please see Section 5.3.2 where SCE addresses this prompt.

For each lesson learned, the electrical corporation must identify the following in Table 10-1:

- *Year the lesson learned was identified*
- *Subject of the lesson learned*
- *Specific type or source of lesson learned (as identified in the bullet lists above)*
- *Brief description of the lesson learned that informed improvement to the WMP*
- *Brief description of the proposed improvement to the WMP and which initiative(s) or activity(s) the electrical corporation intends to add or modify*
- *Estimated timeline for implementing the proposed improvement*
- *Reference to the documentation that describes and substantiates the need for improvement including:*
 - *Where relevant, a hyperlinked section and page number in the appendix of the WMP*
 - *Where relevant, the title of the report, date of report, and link to the electrical corporation web page where the report can be downloaded*
 - *If any lessons learned were derived from quantifiable data, visual/graphical representations of these lessons learned in the supporting documentation*

Table 10-1 provides an example of the minimum acceptable level of information.

Table 10-1 - Lessons Learned

ID #	Year of Lesson Learned	Subject	Type or Source of Lesson Learned	Description of Lesson Learned	Proposed WMP Improvement	Timeline for Implementation	Reference
1	2022	Tracking of risk events	Finding from current tracking method for the Fire Investigation team	There is a need for better capture of event information including reviewing more events to identify fire incidents.	<ul style="list-style-type: none"> Evaluation of all repair order data to identify potential ignitions in our system. Maintenance Performance/Failure Report (MPFR) form to have information coming in from field personnel who have eyes on the events taking place. 	<ul style="list-style-type: none"> Repair Order Review implemented and being evaluated by Q1 2023 	See WMP Ch 11, pages 650-652 (i.e. SCE's FIPA process)
2	2022	Root cause analysis	Findings from fire root cause analysis are discussed and evaluated with Asset Performance	Process to identify trends/upcoming concerns and translate to mitigation strategies can be improved to streamline identification.	<ul style="list-style-type: none"> Dashboards and committee meeting setup to identify and present upcoming issues that can be converted to a detailed view into potential mitigations. 	<ul style="list-style-type: none"> Committee for review of identified trends/analysis setup and begin projects 12/2023. 	See WMP Ch 11, pages 650-652 (i.e. SCE's FIPA process)
3	2019	Internal monitoring and evaluating initiatives	Drills and exercises	SCE continues to mature its training and exercises based on lessons learned from after action reports from exercises and real-world incidents.	<ul style="list-style-type: none"> SCE's training and exercise program continually updates and improves training and exercises to incorporate changes to procedures and tools used for activations. SCE will conduct a PSPS Full-Scale Exercise in 2023, increasing complexity from the 2022 Functional Exercise. 	<ul style="list-style-type: none"> All PSPS Readiness Exercises must be conducted by July 1 annually. 	2023 WMP Section 8.4.2.2 (Emergency Responder Training)

ID #	Year of Lesson Learned	Subject	Type or Source of Lesson Learned	Description of Lesson Learned	Proposed WMP Improvement	Timeline for Implementation	Reference
4	2022	Internal monitoring and evaluating initiatives	After-action reviews	After action reports are conducted after all PSPS exercises and real-world events to evaluate lessons learned and areas of improvement. These are then translated into formal corrective actions that are tracked and monitored through completion.	<p>Notifications:</p> <ul style="list-style-type: none"> • SCE is in the process of auto-enrolling all customers that live in the High Fire Risk Areas but are not currently enrolled to ensure they receive PSPS alerts. • In December 2022, discontinued the customer opt-out feature for PSPS alerts and begin auto-enrolling customers during account sign-up. • Initiate enhanced outreach to the customers that previously opted out to confirm their contact information and enroll them in PSPS notifications. • Evaluate process for sending imminent restoration notifications to identify possible opportunities to reduce end-to-end processing time. • Evaluate process for sending cancellation notices to customers on circuit segments removed from scope to reduce end-to-end processing time in situations where segment-level (and sub-segment level) decision making is necessary to minimize customer impacts. <p>Technology:</p> <ul style="list-style-type: none"> • SCE will continue refining its PSPS event management capabilities to improve timeliness and accuracy of notifications. 	<ul style="list-style-type: none"> • After Action reports are produced after the completion of IMT activations and exercises. PSPS Post Event reports incorporate lessons learned and are available in the docket of R.18-12-005, posted on SCE’s website and distributed to impacted public safety partners. 	After Action Reports and PSPS Post Event Reports

ID #	Year of Lesson Learned	Subject	Type or Source of Lesson Learned	Description of Lesson Learned	Proposed WMP Improvement	Timeline for Implementation	Reference
5	2022	Internal monitoring and evaluating initiatives	Feedback from community engagement	Received recommendation to expand marketing and promotion of meetings. Refine messages and channels based on 2022 performance data	<ul style="list-style-type: none"> Expand outreach to additional social media platforms. Continue to develop ads with relevant messages. 	<ul style="list-style-type: none"> Ongoing 	Based on SCE's internal assessment, not a specific report per se.
6	2022	Internal monitoring and evaluating initiatives	Performance of mitigation initiatives: Customer Care Programs	In 2022, the WMP compliance targets for the Customer Service activities (namely PSPS-2.A: Critical Care Battery Back-Up Enrollments and PSPS-2.B: Customer Care Portable Power Station & Generator Rebates) were set based on 2021 historical program performance and assumed 2022 would have more PSPS events and customers de-energized. With fewer PSPS events in 2022, and even fewer customers de-energized, the need for customer resiliency products greatly diminished.	<ul style="list-style-type: none"> Given this shift, the compliance targets for future years will pivot focus from an enrollment / rebate target which is heavily dependent on a customer's need for resiliency products and will instead focus on timely issuance of batteries / rebates. 	<ul style="list-style-type: none"> 2023 	See 2023 targets for activities PSPS-2 and PSPS-3 in Table 8-35.
7	2020	Collaboration with other electrical corporations	Risk modeling working group	Wildfire risk models can be improved to establish standard weather and vegetative coverage scenarios, as well as extreme-event conditions,	<ul style="list-style-type: none"> Continue ongoing engagement in wildfire risk modeling working group. 	<ul style="list-style-type: none"> Ongoing 	Weblink to wildfire risk modeling working group and summary report

ID #	Year of Lesson Learned	Subject	Type or Source of Lesson Learned	Description of Lesson Learned	Proposed WMP Improvement	Timeline for Implementation	Reference
				for design purposes and long-term contingency planning.			
8	2022	Collaboration with other electrical corporations	International Wildfire Risk Management Consortium (IWRMC)	Hazard tree definition, assessment, risk analysis, and mitigation techniques, in addition to regulatory controls and budget treatment, all vary widely across member utilities	<ul style="list-style-type: none"> SCE will serve as the lead utility of the joint Hazard/Strike Tree Benchmarking and Best Practices Study to be conducted in 2023. Lessons learned and best practices are anticipated to influence future activities and/or programs related to hazard tree mitigation and will be included, as applicable, in future WMP submittals. 	<ul style="list-style-type: none"> Draft report by 12/2023 Final report by 2/2024 	This lesson learned is not documented in a specific report; it arose from verbal discussions within the working group.
9	2022	Collaboration with other electrical corporations	SCE regularly collaborates with the other California utilities on covered conductor, new technologies, and enhanced vegetation management practices	Please see the IOU working groups reports in Appendix F for descriptions of lessons learned.	<ul style="list-style-type: none"> As a result of laboratory testing of covered conductor, SCE has increased its estimated effectiveness of covered conductor from approximately 67% to 72%. SCE will be further collaborating with the joint utilities in 2023 and conducting workshops on further assessing the covered conductor testing results, M&I practices, new technologies and other items. The results of these workshops could lead to improved practices. 	<ul style="list-style-type: none"> SCE has implemented the change in estimated effectiveness of covered conductor in its risk-based decision making. 	See the Joint IOU CC Working Group Report in Appendix F for further details
10	2021	San Jose State University's (SJSU) Wind Profiler Project	Wind profiling pilot project using LiDAR technology	Desire to continue evaluation of ability to use LiDAR to accurately predict surface-level winds during PSPS events.	<ul style="list-style-type: none"> SCE will continue the pilot project through the 2023 fire season to make a final determination on if this effort will add value to the de-energization decision process during PSPS events. 	<ul style="list-style-type: none"> Funds are expected to run out in 2023 and thus the project will be completed by 2024 	See WMP 8.3.2.3.1 (Remote Sensing)

ID #	Year of Lesson Learned	Subject	Type or Source of Lesson Learned	Description of Lesson Learned	Proposed WMP Improvement	Timeline for Implementation	Reference
11	2022	SJSU's Wildfire Interdisciplinary Research Center	A membership with SJSU allows for voting privileges to decide what potential projects will be funded.	Projects are underway; lessons yet to be learned.	<ul style="list-style-type: none"> University collaboration is ongoing and future research will allow for continuous improvement. 	<ul style="list-style-type: none"> Ongoing Next project cycle begins in 2023. Continued membership through 2025. 	See WMP 8.3.2.1.3 (Fire Science Enhancements)
12	2022	University of Colorado Boulder Vegetation Build-Up Index	Development of the vegetation build-up index which will systematically and objectively help determine areas of high fire potential.	An index that identifies elevated areas of vegetation vulnerability to wildfire would support SCE's efforts for mitigation selection and prioritization.	<ul style="list-style-type: none"> SCE will continue to work with the University of Colorado, Boulder, to create an algorithm that will use remote sensing observations of vegetation to determine areas of vulnerability on the landscape. 	<ul style="list-style-type: none"> Ongoing Algorithm completion by 2024 Product support through 2025 	See WMP 8.3.2.3.1 (Remote Sensing)
13	2022	Cal Poly San Luis Obispo's Wildland Urban Interface Fire Information Research and Education Institute (WUI FIRE Institute)	SCE sponsors this program through a financial commitment of \$110k per year.	Projects are underway; lessons yet to be learned.	<ul style="list-style-type: none"> University collaboration is ongoing and future research will allow for continuous improvement. 	<ul style="list-style-type: none"> Ongoing Continued membership through 2023. 	See WMP 8.3.2.1.3 (Fire Science Enhancements)
14	2022	Collaboration with industry trade associations	Industry collaboration and engagement	Share and gain insights on best practices on utility wildfire mitigation and response by engaging with industry trade associations, including but not limited to Electric Utility Consultants, Inc. (EUCI), Western Energy Institute (WEI), Institute of Electrical and Electronics	<ul style="list-style-type: none"> Continue to share best practices and engage with industry trade associations and utilities by participating in industry conferences and events. 	<ul style="list-style-type: none"> Ongoing 	There was not a specific report that recommended SCE to perform this activity. It is understood as a best practice generally and an expectation from OEIS.

ID #	Year of Lesson Learned	Subject	Type or Source of Lesson Learned	Description of Lesson Learned	Proposed WMP Improvement	Timeline for Implementation	Reference
				Engineers (IEEE) and Western Electricity Coordinating Council (WECC)			
15	2022	Collaboration with other electrical corporations	Vegetation Line Clearances Working Group	Increase alignment amongst California electrical corporations related to line clearing data collection practices and record keeping of tree-caused risk events.	<ul style="list-style-type: none"> PG&E, SDG&E, and SCE chose a third-party consultant to establish the data collection standards, create the cross-utility database, and study the relationship between enhanced vegetation clearances and tree-caused risk events. 	<ul style="list-style-type: none"> Contract with third-party evaluator to conclude in 2025 	Third-party evaluator will issue a report on its findings and a joint database for all participating utilities.
16	2022	Collaboration with other electrical corporations	Risk Modeling Working Group	Information gathering from utilities and comparing risk modeling methodologies.	<ul style="list-style-type: none"> Upcoming 2023 discussions will move to understanding best practices and towards consistency on utility approaches to risk modeling. 	<ul style="list-style-type: none"> Ongoing 	Conducted per OEIS direction. https://efiling.energysafety.ca.gov/Lists/DocketLog.aspx?docketnumber=risk-model-group
17	2022	Collaboration with other electrical corporations	Joint IOU PPS Working Group	Increase alignment amongst California electrical corporations related to PPS lessons learned and best practices.	<ul style="list-style-type: none"> For example, PG&E, SDG&E and SCE are collaborating to enhance the process for identifying and notifying shared customers²⁹² during PPS events. 	<ul style="list-style-type: none"> Ongoing 	In compliance with D. 21-06-014. Joint Working Group Reports are filed in R.18-12-005 and can be found in the docket.
18	2021	Feedback from Frontline Workers	Safety Culture Assessment	Enhance feedback loop and communications with frontline workers and supervisors and leaders.	<ul style="list-style-type: none"> Update current safety leader activities to address issues noted by the workforce concerning wildfire communications, roles, and decisions. 	<ul style="list-style-type: none"> While initial completion is anticipated in Q1 2023, SCE will continue to engage and obtain feedback from the workforce on an ongoing basis. 	SCE 2022 Q4 WMP Quarterly Notification Letter

²⁹² A shared customer is defined as a customer whose electrical distribution circuit is sourced by a utility other than the one billing that customer.

ID #	Year of Lesson Learned	Subject	Type or Source of Lesson Learned	Description of Lesson Learned	Proposed WMP Improvement	Timeline for Implementation	Reference
19	2022	Feedback from Energy Safety or other authoritative bodies	Independent Third-Party Evaluation	Improvements can be explored for non-exempt equipment replacements on HFRA hardened circuits.	<ol style="list-style-type: none"> 1. Continue working with Cal Fire and the Board of Forestry for unique product testing for exemption status and California Codes and Regulations updates for exemption classifications. 2. Continue tracking opportunities to replace material by bundling with other work. 3. Make improvements to SCE standards for guidance on exempt material use and replacement and evaluate/ improve training for inspectors. 	<ol style="list-style-type: none"> 1. Ongoing 2. Ongoing 3. Complete 12/31/22 	The need for improvement was communicated to SCE by Filsinger Energy Partners, who were brought in on behalf of the Governor's Office to provide oversight and potential enhancement opportunities for SCE's wildfire mitigation strategies. SCE understands a report was provided to the Governor.
20	2022	Feedback from Energy Safety or other authoritative bodies	Independent Third-Party Evaluation	Restrictive permitting potentially increases wildfire risk because Vegetation Management activities to address wildfire risk occur on lands administered by State and Federal agencies.	<ol style="list-style-type: none"> 1. Continue working with the LA Department of Regional Planning (LADRP) to prioritize and process local coastal permits. Continue ongoing regular communication with LADRP. 2. Improve efficient use of the Forest Service Master Special Use Permit (MSUP) to facilitate SCE's work by increasing external engagement with agency leadership. 3. Continue using Instruction Memorandum with Bureau of Land Management (BLM) to decrease agency permitting time. 4. Continue working on finalizing an Operations and Maintenance Plan with BLM that can be used more broadly within the agency once completed. 5. Increase targeted external engagement with BLM leadership through executive 	<ol style="list-style-type: none"> 1. Ongoing 2. Ongoing 3. Complete 4. Pilot Q4 2023 	Section 8.2

ID #	Year of Lesson Learned	Subject	Type or Source of Lesson Learned	Description of Lesson Learned	Proposed WMP Improvement	Timeline for Implementation	Reference
					<p>stakeholder working groups; focus on our activities in or near wilderness areas.</p> <p>6. Increase external engagement and communication to share priorities, wildfire risk concerns, and mitigation strategies with the California Department of Fish and Wildlife.</p> <p>7. Increase external engagement with Department of Water Resources (DWR) related to work permitting within their right of way. Engagement is ongoing on a monthly basis and has resulted in a dedicated DWR staff member to prioritize and process SCE encroachment permits and temporary entry permits.</p>	<p>5. Ongoing</p> <p>6. Ongoing</p> <p>7. Ongoing</p>	
21	2022	Feedback from Energy Safety or other authoritative bodies	Independent Third-Party Evaluation	A high volume of environmental holds could impede wildfire mitigation work.	<ol style="list-style-type: none"> 1. Explore the adjustment of work management processes in SCE Environmental 2. Pursue incidental take permits for greater operational flexibility in key regions. 3. Apply for a Master Streambed Alteration Agreement (MSAA) for work in jurisdictional waters. 4. Benchmark with other IOUs to ascertain best practices in environmental hold processes. 	<ol style="list-style-type: none"> 1. Initial implementation Q1 2023 2. Yosemite Toad and Arroyo Toad complete; Pacific Fisher, San Bernardino Kangaroo Rat, and Santa Catalina Island Fox ongoing 3. Estimated permit approval in 2024 4. Ongoing 	See comments in item #19.

ID #	Year of Lesson Learned	Subject	Type or Source of Lesson Learned	Description of Lesson Learned	Proposed WMP Improvement	Timeline for Implementation	Reference
22	2022	Feedback from Energy Safety or other authoritative bodies	Independent Third-Party Evaluation	Clarity of written checklist for long span length and slack inspection work could be improved.	<ol style="list-style-type: none"> 1. Review existing survey questions and responses to ensure alignment with long span requirements, making changes to survey and updating Long Span standards as necessary. 2. Review cancelled long span notifications to ensure remediations are not required. 	<ol style="list-style-type: none"> 1. In progress; target completion Q2 2023 2. In progress; target completion Q2 2023 	See comments in item #19.
23	2022	Feedback from Energy Safety or other authoritative bodies	Independent Third-Party Evaluation	A significant number of questions on the inspection form address asset inventory rather than ignition/wildfire risk reduction.	<ol style="list-style-type: none"> 1. Evaluate survey questions to identify opportunities to streamline unnecessary questions; implement survey question updates as identified. 2. Explore feasibility of adjusting to a time-based or work-based data capture approach for asset inventory questions. 3. Investigate long term solutions for optimizing inspection survey completion for asset inventory, including potential use of drone pictures and AI/ML to automate survey completion. 	<ol style="list-style-type: none"> 1. Q2 2023 2. Q2 2023 3. Q4 2023 	See comments in item #19.
24	2022	Feedback from Energy Safety or other authoritative bodies	Independent Third-Party Evaluation	Decision-making criteria for PSPS thresholds could be more transparent in terms of how thresholds are set and updated and how covered conductor and Priority 2 conditions inform and influence thresholds.	<ul style="list-style-type: none"> • Engage a third-party vendor expert to assess methodology for wind speed threshold development. 	<ul style="list-style-type: none"> • Target completion Q3 2023 	See comments in item #19.

ID #	Year of Lesson Learned	Subject	Type or Source of Lesson Learned	Description of Lesson Learned	Proposed WMP Improvement	Timeline for Implementation	Reference
25	2022	Feedback from Energy Safety or other authoritative bodies	Independent Third-Party Evaluation	Improvements can be explored to improve quality assurance and quality control of equipment inspections.	<ol style="list-style-type: none"> 1. Review the inspection questionnaire related to compliance, safety, and reliability. 2. Incorporate data capture conditions into the current QC program to ensure a QC finding is identified whenever a data capture notification is not generated by the inspector. 3. Pilot then implement QC improvements to address exempt/non-exempt equipment status. 4. Identify opportunities to better align QC with evolving risk mitigation strategies. 	<ol style="list-style-type: none"> 1. Complete 2. Q2 2023 3. Q2 2023 4. Q1 2023 	See comments in item #19.
26	2022	Feedback from Energy Safety or other authoritative bodies	Independent Third-Party Evaluation	Opportunities may exist to integrate and improve vegetation management programs to reduce potential wildfire risk.	<ol style="list-style-type: none"> 1. Continue with SCE plan to integrate the vegetation line clearing, dead and dying tree, and hazard tree management plan vegetation programs. 2. Continue with SCE plan to transition from grid-based vegetation management work to a circuit-based approach. 3. Explore then implement opportunities to improve post-work verification, including documentation updates and process enhancements. 4. Identify opportunities to improve pre-inspection quality in order to reduce tree trimming prescription changes by contractors. 	<ol style="list-style-type: none"> 1. Q2 2023 2. Q4 2025 3. Q1 2023 4. Q2 2023 	See Section 8.2 for further discussion on these items

ID #	Year of Lesson Learned	Subject	Type or Source of Lesson Learned	Description of Lesson Learned	Proposed WMP Improvement	Timeline for Implementation	Reference
					<p>5. Improve contractor field coordination with SCE Environmental Services to improve efficiency when working in Environmentally Sensitive Areas (ESA).</p> <p>6. Address timeliness of vegetation constraint resolution by clarifying Priority 1 criteria in HFRA to mitigate emergency conditions and develop plans to reduce non-emergency encroachment work volume.</p> <p>7. Please see Section 8.2 for further discussion on these items.</p>	<p>5. Issue field guidance and embed field monitors 3/31/23; implement Environmental Field Support Scheduling Model throughout 2023</p> <p>6. Partially complete with full implementation of new plans 6/30/23</p>	

11 CORRECTIVE ACTION PROGRAM

In this section, the electrical corporation must describe its corrective action program. The electrical corporation must present a summary description of the relevant portions of its existing procedures.

The electrical corporation must report on how it maintains a corrective action program to track formal actions and activities undertaken to:

- *Prevent recurrence of risk events*
- *Address findings from wildfire investigations (both internal and external)*
- *Address findings from Energy Safety's Compliance Assurance Division (i.e., audits and notices of defect and violation)*
- *Address areas for continued improvement identified by Energy Safety as part of the WMP evaluation*

SCE has multiple corrective action programs to identify issues, address findings, and evaluate efforts to prevent recurrence of those issues. These include:

- **Repair Order Review Process:** Evaluates repair orders and considers opportunities to prevent the recurrence of risk events.
- **Fire Investigation Preliminary Analysis (FIPA):** Investigates ignitions, reviews findings from external wildfire investigations, and considers opportunities to improve mitigation strategies
- **Compliance Review of Audits and Notices of Defect and Violation:** Tracks and addresses findings from Energy Safety's Compliance Assurance Division (i.e., audits and notices of defect and violation)
- **Internal Audit Services and Compliance and Quality Departments:** Assesses WMP implementation independent of the responsible operating unit, conducts risk-informed audits of wildfire mitigation programs, and develops QA and QC processes.

SCE details these efforts below. Please see Appendix D: Areas for Continued Improvement for a full discussion for how SCE is addressing the Areas for Continued Improvement identified by Energy Safety as part of its 2022 WMP Decision. Finally, beyond these programs listed above, the crews that implement the mitigation work are trained to execute the work in accordance with established construction methods and standards. If crews identify any issues or opportunities for improvement, they are encouraged to share these as applicable to inform continuous improvement opportunities.

Repair Order Review Process (Prevent recurrence of risk events)

SCE expanded the process for its Fire Investigation team to now review all repair orders as of March of 2022 and to avoid missing those for which the key words were not present.²⁹³ In this review, engineers evaluate the description of the event that occurred by viewing pictures taken by responders and gathering other geographic and equipment related information. If further information needs to be

²⁹³ A repair order is a document written up to initiate repairs on our distribution system.

collected to assess if an ignition took place, the engineers reach out to the responders to get clarification on the event and details pertaining to the ignition. Data collected can be flagged as an ignition event which will feed into SCE's FIPA review process, detailed below, where further information is documented on the ignition. The intent of this review is to promptly obtain information on the event from the field personnel who observed and/or reported it. Prompt discussion with field personnel²⁹⁴ is necessary to help ensure all the facts and observations are captured. The information obtained through discussions with field personnel as well as the engineering reviews of repair orders is then used to assess wildfire mitigation options, asset management and performance improvement opportunities, and near-miss analysis and proactive remediation.

Fire Investigation Preliminary Analysis (Address findings from wildfire investigations (both internal and external))

In April 2019, SCE launched the FIPA process to perform more in-depth investigations into all ignitions that occur in connection with SCE facilities.²⁹⁵ The FIPA process has been continuously improving since inception to enhance efficiency of the investigation process related to ignitions and other data pertaining to near-miss events, such as wire downs and underground equipment failures.

SCE currently accounts for risk events in several databases:

- Wire Down Database - Monitors wire-downs based on wire-down calls and repair orders across the entire SCE service area.
- ODRM - Monitors distribution, substation, and transmission unplanned outages that affect a single line transformer or more on SCE's grid.
- FIPA Database - Collects and annually reports information that would be useful in identifying operational and/or environmental trends relevant to fire-related events.

The FIPA process has three levels of investigation, depending on the complexity of the ignitions, including factors such as the potential severity of the situation, the extent of condition, and what is already known of the event. A brief description of the actions taken for each level are listed below:

- Level 1 - May include a review of pictures, telephone interviews, and repair orders.
- Level 2 - In addition to Level 1, may include site visits and fault analysis.
- Level 3 - In addition to Level 2, may include evaluating the equipment/material by an engineer.

As part of the FIPA process, SCE also evaluates existing maintenance notifications as well as other asset and circuit level data associated with the equipment under evaluation such as circuit topology, circuit loading at location, weather, reliability, and operational history. SCE is conducting pilots to expand investigation methods and failure types.

SCE monitors ignition information for its entire service area. Although SCE prioritizes incidents that

²⁹⁴ Field personnel in this Repair Order process includes Troublemakers who respond to incidents or "trouble" on the system. They identify any concerns on our system and write up a Repair Order identifying the issue and equipment that needs to be replaced/repaired.

²⁹⁵ This is exclusive of attorney-directed investigations into ignitions which potentially involve SCE facilities.

occur in HFRA, SCE also collects information in non-HFRA because there may be common failure modes that occur throughout the service area. SCE can then use this information to target risk mitigations where needed.

SCE has expanded its FIPA team and refined the tools and processes used. In 2022, the FIPA team updated its Repair Order (document written up to initiate repairs on our distribution system) Review Process to analyze all repair order events taking place in our system. This extended review beyond recorded ignition events allows engineers to better capture additional ignition events. In reviewing within a day, if the engineers do not have clear images or information to determine an ignition happened, they reach out to interview the field personnel to get additional insights. In 2022, the FIPA team analyzed roughly 1000 ignition events as well as about 16,000 repair orders.

Through this plan period, SCE will enhance its post failure data collection tools and processes to make data collection more consistent, relevant, and efficient. For 2023, SCE will update its database for storing this information and its processes for root cause analysis. SCE is updating the failure event database to include wire-down, underground equipment failures and ignitions to assist in identifying related failures in a single database. For example, an underground equipment failure may cause an ignition that burns a pole that in turn may result in a wire-down. Currently, these are recorded as three separate events. Under the new structure, all three events will be related and analyzed as a single incident. SCE is also incorporating additional transmission outage data as an improvement to its outage reporting.²⁹⁶ SCE is working towards aligning pre-failure inspection data with post-failure data which would give a holistic view of overall asset health. We anticipate these dataset alignments to be completed in 2023.

For 2024 and 2025, SCE will continue to make improvements based on lessons learned including modeling of failures and ignitions, utilization of machine learning, and root cause analyses.

SCE documents and analyzes risk event data to gain insights and gather lessons learned to help mitigate risks by reducing or preventing risk events from occurring. Previously, data collection on fault and failure events were captured on multiple forms that did not collect data in a standardized electronic format, resulting in inconsistent data capture and the need for linguistic analysis to capture trend data from free text responses.

SCE has also begun to roll out an electronic form called the Material Performance Failure Report (MPFR) that allows for dynamic data collection from failures of the electric grid. The MPFR addresses two previous issues with respect to ignition data collection and storage, providing a centralized location allowing incoming ignition data to be more efficiently captured and improvements to the robustness of the ignition data for more in-depth analysis and trending.

Compliance Review of Audits and Notices of Defect and Violation (Address findings from Energy Safety's Compliance Assurance Division (i.e., audits and notices of defect and violation))

SCE documents audit findings and notices of defect and violations. SCE reviews and provides a response to any audit finding and enters them in a database for tracking any lessons learned and as needed track and implement corrective actions.

Energy Safety instituted a new process for identifying their field inspection instances of non-compliance.

²⁹⁶ Historical reporting has been revised to reflect the additional Transmission outage data.

Energy Safety may issue the following notices:

- **Notices of violation (NOVs)** identify instances in which an electrical corporation is non-compliant with its approved WMP or any law, regulation, or guideline within Energy Safety's authority
- **Notices of defect (NODs)** identify deficiencies, errors, or conditions that increase the risk of ignition posed by electrical lines and equipment requiring correction.

This new process also provides the electric corporations the right to request a written hearing if the electrical corporation does not agree with any violation or defect.

SCE reviews all notices of defects and violations to determine whether to correct the noncompliance within the established²⁹⁷ corrective action timeline or to request a written hearing. SCE tracks all violations and defects until OEIS officially closes them out. For any violation or defect that needs to be corrected, SCE notifies its field crews to correct these within the established timeline. See Section 12 Table 12-1 for a list of open violations or defects.

SCE continues to look for ways to prevent future occurrences of these violations and/or defects. SCE's field inspections (both ground and aerial) are a detective control used to identify items that need to be remediated. Additionally, SCE is performing quality control reviews of completed construction in HFAs using a risk-based approach, which includes increased sampling levels in higher risk areas. The reviews occur for construction in general, but also addresses projects within the scope of the WMP, such as covered conductor. These quality control reviews help drive continuous improvement by identifying non-conformances with SCE standards, determining causes of non-conformance, and/or driving corrective actions to improve performance. If performance falls below certain thresholds, SCE will require corrective actions.

Internal Audit Services and Compliance and Quality Departments: SCE's Audit Services Department (ASD) assesses WMP implementation independent of the responsible operating unit. Audits are determined via a risk assessment informed by SCE's Board of Directors (Board), senior management and regulatory requirements. ASD has conducted risk-informed audits of SCE's system hardening and operations, inspection, maintenance, and vegetation management programs and WMP-related Compliance and Quality (C&Q) processes. These audits are conducted through desktop reviews and, in some instances, field inspections of assets to provide reasonable assurance that mitigations are deployed according to plan, that SCE facilities are appropriately inspected, and that identified conditions are timely remediated according to applicable requirements. ASD documents audit tasks and monitors corrective actions using industry standard auditing software in accordance with the International Standards for the Professional Practice of Internal Auditing.

In addition, the C&Q group develops QC and QA processes to help ensure that mitigation activities are proceeding as planned. C&Q performs testing and assessment of wildfire and non-wildfire activities to measure conformance and drive continuous improvement throughout the organization. Section 8.1.6 provides an overview of its QA/QC activities for asset management and inspections. Section 8.2.5 provides an outline of its QA/QC activities for vegetation management.

²⁹⁷ See Energy Safety Compliance Process issued October 13, 2021

The electrical corporation must report on how it reviews each improvement area in accordance with its corrective action program. At a minimum, the electrical corporation must:

- ***Identify insufficient occurrence and response:*** *Identify targeted corrective actions for areas where the event occurrence, response, or feature was insufficient.*

SCE performs an investigation for each ignition on its system, determines if mitigations were in place that did not perform as intended, and identifies opportunities for correcting insufficiencies with mitigations or adopting new practices to prevent further recurrence. These efforts are performed through collaborative process involving SCE's FIPA engineers and asset management organization through a framework that seeks to continuously improve SCE's asset performance.

The FIPA process for individual ignitions was described above. The following steps describe SCE's efforts to use this data to evaluate trends or issues on the system.

- **Documenting Events and Trends:** SCE tracks asset failures, ignition events, wire-downs, and underground equipment failures through material performance failure reports and internal databases. SCE also captures data from its various inspection programs, including findings and responses to inspection survey questions. The data serves as the basis for the evaluation of asset performance and trends.
- **Evaluation of Events and Trends:** SCE evaluates the risk event by reviewing the data captured in the failure reports and databases, perform additional engineering studies, research the occurrence of similar risk events in the past to identify trends and potential systemic issues, evaluate the condition of the associated asset(s) against equipment and manufacturer performance standards, etc. This may also include a review of past inspection and maintenance trends associated with the asset.
- **Consult Stakeholders on Findings and Determine Solution or Mitigation Approach:** The engineering review team consolidates its failure and trend analysis for review and calibration with a broader stakeholder group. This will generally involve reviewing the identified asset performance issue and any associated trends, including failures (e.g., ignitions, wire downs, faults and underground explosions) and inspection findings. Based on this collective understanding, SCE will evaluate mitigation opportunities and develop an engineering solution and/or mitigation strategy to prevent recurrence of the event in the future.
- **Mitigation Deployment and Evaluation:** If necessary, SCE implements a new solution and mitigation strategy, then evaluates its performance post-implementation. This can involve updating SCE standards or equipment specifications, training, deploying proactive infrastructure replacement programs, performing subsequent ad hoc inspections, modifying maintenance & inspection programs, and evaluating the asset performance over time to determine effectiveness of mitigation strategy.

SCE seeks to continuously improve this general process to further refine the evaluation and mitigation of risk events on SCE's system. SCE identifies specific additional actions taken to reduce recurrence of risk events in the section below.

- **Identify actions to reduce recurrence:** *Identify improvement actions (as applicable) to reduce the likelihood of recurrence, improve response/mitigation actions, or improve operational procedures or practices.*

SCE identifies various improvement actions taken to reduce the likelihood of recurrence, improve mitigation actions, and improve operational procedures and practices below. Below, SCE lists several examples of actions taken because of this process.

- **Secondaries** – SCE’s FIPA analysis identified a growing trend in ignitions associated with secondary conductors related to: (1) open, bare, and aged conductor; (2) animal contact with unprotected secondary/service connectors; (3) tree abrasion; (4) overloading due to illegal growth; and (5) secondary overloading given the record level heat waves experienced in 2022. To address issues on secondary conductors related to strain and abrasion, SCE modified its inspection form with new questions to capture information around these issues. SCE is also replacing secondary/service conductor concurrent with replacement of primary covered conductor. In addition, SCE has instituted new work methods governing how field personnel cover secondary/service connectors to prevent animal contact.
- **Aerial Inspections** – In another example, a small fire (<1 acre) occurred in 2019 associated with SCE equipment, due to degradation occurring at the top of a crossarm. In response to this evaluation, SCE began inspecting transmission and distribution structures both from the ground and aerially, to develop a 360-degree inspection of the structure. This has served as the basis for SCE’s asset inspection programs which are detailed in Section 8.1.3
- **C-Hooks** – SCE’s former C-Hooks Replacement initiative (formerly SH-13) was included in SCE’s 2021 and 2022 WMP Updates to address the potential for a C-Hook to fail and lead to downed high voltage wire, which could pose wildfire and public safety risks. While SCE had no historical incidents or records of failed C-Hooks in its service area, given the inability to ascertain the hardware condition visually²⁹⁸ and the lessons learned from the 2018 Camp Fire which was believed to have been started by the failure of a C-Hook, SCE decided to proactively remove all C-Hooks on its system to remove this risk.
- **Track implementation:** *Track the improvement action plan and schedule in the electrical corporation’s action tracking system.*

SCE describes the processes used to track the identified improvements for risk events, fire investigations, and notices of violation or defect below.

- **Risk events:** After SCE performs an analysis of each risk event, it will identify opportunities to address the root cause of that risk event in the form of new work procedures, modifications to equipment used, etc. To the extent these improvement opportunities are identified, the risk event analysis team will work with the requisite asset management, new technology, planning and operational organizations to review, gain approval for, and implement the identified improvement opportunities.

²⁹⁸ Due to their small size, C-Hooks are also difficult to inspect for degradation, even using aerial inspections, which increases the uncertainty of the probability of failure.

- **Fire investigations:** The fire investigation team reviews repair orders for any sign in description or pictures of an ignition taking place. They reach out to field personnel, review repair order details, and review incident log sheets to identify an ignition. From there, the identified ignition is tracked in a database and a deeper analysis into the cause of the ignition is performed. This includes system studies, equipment characteristics, weather conditions at time of event, etc. This is all captured and tracked for analysis and trending purposes.
- **NOV/NODs:** As noted above, SCE reviews all notices of defects and violations to determine whether to correct the noncompliance within the established corrective action timeline or to request a written hearing. SCE tracks all violations and defects until OEIS officially closes them out. For any violation or defect that needs to be corrected, SCE notifies its field crews to correct these within the established timeline. SCE's evaluation and efforts to address the issue are intended to prevent re-occurrence, and if needed, will update processes or procedures. See Section 12, Table 12-1 for a list of open violations or defects and planned corrective actions.
- **Improve external communication:** *For areas where weaknesses were identified in the response of external agencies, develop a communication plan to share the information and conclusion with the responsible agency. The completion of this action and the agency's response must be documented.*

SCE has established a Standardized Emergency Management System (SEMS), National Incident Management System (NIMS) and Incident Command System (ICS) compliant incident management structure built around Incident Management Teams (IMTs). Using this framework, during PSPS events and other emergencies, SCE engages with its emergency management partners at the county and state level by hosting daily coordination calls with impacted agencies.

In addition, SCE also conducts daily personalized PSPS outreach and engagement calls for both critical infrastructure providers and the AFN community. For the 2023 season, SCE will evaluate its current strategy for conducting multiple daily operational briefings to identify opportunities and to optimize engagement with public safety partners while reducing possible redundancy.

SCE communicates with OEIS on NOVs and NODs regarding issues OEIS has found and how SCE can improve. Furthermore, SCE works with CalFire, the CPUC/and the California Governor's Office of Emergency Services to respond to their findings, feedback, and identify appropriate responses.

In advance of fire season, SCE partners closely with local and tribal governments to identify and secure locations for Community Resource Centers (CRCs) and Community Crew Vehicles (CCVs). Although SCE has preestablished optimal locations for CRC/CCV deployments in most communities, there are still a few areas where preestablished locations have not been determined. In advance of the 2023 fire season, SCE will work with local and tribal governments and Community Based Organizations to identify pre-established locations for these communities.

More broadly, SCE describes its collaboration and partnerships with external agencies in Section 8.4 SCE values these opportunities to partner with local, state and federal agencies, particularly in the response to wildfire and PSPS risk events and will continue to seek opportunities to improve and refine our communication, emergency response, and restoration efforts to help ensure the safety of our customers and the reliability of our electric system.

- ***Integrate lessons learned from across the industry:*** Identify applicable generic lessons learned to improve the overall effectiveness of the electrical corporation WMP.

Please see SCE's response to Section 10 which details numerous lessons learned and opportunities that SCE and its stakeholder partners have identified, and for which SCE is planning to implement going forward.

SCE engages utilities across California and the rest of the country to share best practices, mitigation strategies, and approaches for mitigating wildfire and PSPS risk. These collaborations can result in the ideation of new and/or more effective ways of planning for and implement the WMP. This includes understanding how other utilities identify, evaluate, and determine appropriate mitigation options for risk events, fire ignitions, and other issues on the system. Additional topical areas that are discussed to identify lessons learned typically include:

- Risk modeling, including understanding how and why utilities use different inputs, data sources, calculations, etc., and how the risk modeling results inform mitigation strategies;
- Execution of work, including resourcing strategies and execution processes;
- Engineering standards and construction methods, particularly for new technologies and mitigations being deployed in the field

SCE also appreciates the guidance and feedback from Energy Safety throughout the WMP process and incorporates that feedback into our WMP to make it more effective with each successive submission.

- ***Share lessons learned with others:*** Identify and communicate any significant generic lessons learned that should be disseminated broadly (i.e., to other electrical corporations and responsible regulatory authorities, such as Energy Safety or CAL FIRE).

Please see SCE's response to Section 10, which details numerous lessons learned and opportunities that SCE and its stakeholder partners have identified.

12 NOTICES OF VIOLATION AND DEFECT

Within a Notice of Violation (NOV) or Notice of Defect (NOD), Energy Safety directs an electrical corporation to correct a violation or defect within a specific timeline, depending on the risk category of the violation or defect. The electrical corporation has 30 days to respond to the NOV or NOD and provide a plan for corrective action. Following completion of the corrective action, the electrical corporation must provide Energy Safety with documentation validating the resolution or correction of the identified violation or defect. Energy Safety includes the electrical corporation's response and the resolution status of any violations or defects in the summaries it provides to the CPUC.

In Table 12-1 of the WMP, the electrical corporation must provide a list of all open violations and defects as of January 1, 2023.

The WMP should not include detailed corrective action plans for each risk event, finding, and/or improvement area. However, this documentation must be made available to Energy Safety upon request.

Table 12-1 provides a list of all open violations and defects as of January 1, 2023. Corrective actions are planned and scheduled for all of these.

Table 12-1 - List of Open Compliance Violations and Defects

Report ID	Type	Severity	Date of Notice	Date of Response	Summary Description of Violation/Defect	Estimated Completion Date	Summary Description of Correction
NOV_SCE_EDC_20211207-01	Violation	Minor	3/23/22	5/20/2022	Vibration Damper - Missing	3/23/23	Install Vibration Damper
NOV_SCE_IAG_20211117-02	Violation	Minor	4/22/22	5/23/2022	Vibration Damper - Missing	4/22/23	Install Vibration Damper
NOD_SCE_ATJ_20211208-01	Defect	Moderate	3/23/22	4/25/2022	Anchor Guy - Loose/Broken	5/23/22	Correct Anchor Guy - Loose/Broken
NOV_SCE_ATJ_20211208-01	Violation	Minor	3/23/22	4/25/2022	Connector Cover - Loose/Missing	3/23/23	Correct Connector Cover - Loose/Missing
NOV_SCE_EDC_20211208-01	Violation	Minor	4/22/22	5/23/2022	Vibration Damper - 6" of Insulator	4/22/23	Install Vibration Damper - 6" of Insulator
NOV_SCE_ATJ_20211130-01	Violation	Minor	2/24/22	5/9/2022	Vibration Damper - Missing	2/24/23	Install Vibration Damper
NOV_SCE_ATJ_20211207-01	Violation	Minor	2/24/22	3/28/2022	Vibration Damper - Missing	2/24/23	Install Vibration Damper
NOV_SCE_ATJ_20211201-01	Violation	Minor	3/23/22	4/22/2022	Vibration Damper - Missing	3/23/23	Install Vibration Damper
NOV_SCE_IAG_20211117-03	Violation	Minor	4/22/22	5/23/2022	Vibration Damper - Missing	4/22/23	Install Vibration Damper
NOV_SCE_ATJ_20211117-01	Violation	Minor	3/23/22	4/25/2022	Vibration Damper - Missing	3/23/23	Install Vibration Damper
NOV_SCE_EDC_20211117-01	Violation	Minor	3/23/22	4/25/2022	Vibration Damper - Missing	3/23/23	Install Vibration Damper
NOV_SCE_ATJ_20211118-01	Violation	Minor	2/24/22	5/9/2022	Fiberglass Guy Strain Insulator - Missing	2/24/23	Install Fiberglass Guy Strain Insulator -
NOD_SCE_ATJ_20211115-01	Defect	Minor	2/24/22	3/28/2022	Anchor Guy - Loose/Broken	2/24/23	Correct Anchor Guy that is Loose/Broken
NOD_SCE_ATJ_20211130-01	Defect	Minor	2/24/22	3/28/2022	Anchor Guy - Loose/Broken	2/24/23	Correct Anchor Guy that is Loose/Broken
NOD_SCE_ATJ_20220622-01	Defect	Minor	7/22/22	8/22/2022	Anchor Guy - Buried	7/22/23	Correct Anchor Guy - Buried
NOV_SCE_IAG_20211117-01	Violation	Minor	4/22/22	5/23/2022	Vibration Damper - Missing	4/22/23	Install Vibration Damper
NOD_SCE_ATJ_20211209-01	Defect	Minor	2/24/22	3/28/2022	Conductor - Frayed/Broken	2/24/23	Correct Conductor that is Frayed/Broken
NOV_SCE_MYU_20220224-01	Violation	Minor	4/22/22	5/23/2022	Vibration Damper - Missing	4/22/23	Install Vibration Damper
NOV_SCE_CAC7_20220224-01	Violation	Minor	4/22/22	5/23/2022	Vibration Damper - Missing	4/22/23	Install Vibration Damper
NOV_SCE_ATJ_20211202-01	Violation	Minor	3/23/22	5/20/2022	Vibration Damper - Missing	3/23/23	Install Vibration Damper
NOV_SCE_ATJ_20211116-01	Violation	Minor	3/23/22	4/25/2022	Vibration Damper - Missing	3/23/23	Install Vibration Damper
NOV_SCE_EDC_20211116-01	Violation	Minor	3/23/22	4/25/2022	Vibration Damper - Missing	3/23/23	Install Vibration Damper
NOV_SCE_IAG_20211116-01	Violation	Minor	3/23/22	4/25/2022	Asset - Mislabeled/Misidentified	3/23/23	Correct Asset that is Mislabeled/Misidentified
NOV_SCE_ATJ_20220405-01	Violation	Minor	7/22/22	8/22/2022	Vibration Damper - Missing	7/22/23	Install Vibration Damper
NOV_SCE_ATJ_20211115-01	Violation	Minor	2/24/22	3/28/2022	Vibration Damper - Missing	2/24/23	Install Vibration Damper
NOV_SCE_IAG_20211117-05	Violation	Minor	4/22/22	5/23/2022	Vibration Damper - Missing	4/22/23	Install Vibration Damper
NOV_SCE_ATJ_20220406-01	Violation	Minor	7/22/22	8/22/2022	Vibration Damper - Missing	7/22/23	Install Vibration Damper
NOD_SCE_ATJ_20211118-01	Defect	Minor	2/24/22	3/28/2022	Anchor Guy - Loose/Broken	2/24/23	Correct Anchor Guy that is Loose/Broken
NOV_SCE_MYU_20220406-01	Violation	Minor	7/28/2022	8/24/2022	Vibration Damper - Missing	7/28/23	Install Vibration Damper
NOD_SCE_ATJ_20211202-01	Defect	Minor	3/23/22	4/25/2022	Conductor - Bird Caging	3/23/23	Correct Conductor - Bird Caging
NOD_SCE_ATJ_20220406-01	Defect	Minor	7/22/22	8/22/2022	Avian Protection Cover - Loose/Missing	7/22/23	Correct Avian Protection Cover - Loose/Missing
NOD_SCE_GCA_20211118-01	Defect	Minor	4/22/22	5/23/2022	Veg - Anchor Guy Contact Above Insulator	4/22/23	Correct Veg - Anchor Guy Contact Above Insulator
NOD_SCE_GCA_20211116-01	Defect	Minor	5/11/22	6/10/2022	Conductor - Bird Caging	5/11/23	Correct Conductor - Bird Caging
NOV_SCE_IAG_20211117-04	Violation	Minor	4/22/22	5/23/2022	Vibration Damper - Missing	4/22/23	Install Vibration Damper

APPENDIX A: DEFINITIONS

Unless otherwise expressly stated, the following words and terms, for the purposes of these Guidelines, have the meanings shown in this chapter.

Terms Defined in Other Codes

Where terms are not defined in these Guidelines and are defined in the Government Code, Public Utilities Code, or California Public Resources Code, such terms have the meanings ascribed to them in those codes.

Terms Not Defined

Where terms are not defined through the methods authorized by this section, such terms have ordinarily accepted meanings such as the context implies.

Definition of Terms

Term	Definition
Access and functional needs population (AFN)	Individuals, including, but not limited to, those who have developmental or intellectual disabilities, physical disabilities, chronic conditions, or injuries; who have limited English proficiency or are non-English speaking; who are older adults, children, or people living in institutionalized settings; or who are low income, homeless, or transportation disadvantaged, including, but not limited to, those who are dependent on public transit or are pregnant. (California Government Code 8593.3(f)(1))
Asset (utility)	Electric lines, equipment, or supporting hardware.
At-risk species	See “high-risk species.”
Benchmarking	A comparison between one electrical corporation’s protocols, technologies used, or mitigations implemented, and other electrical corporations’ similar endeavors.

Term	Definition
Calibration	Adjustment of a set of code input parameters to maximize the resulting agreement of the code calculations with observations in a specific scenario. ¹
Catastrophic wildfire	A fire that caused at least one death, damaged over 500 structures, or burned over 5,000 acres.
Circuit miles	The total length in miles of separate transmission and/or distribution circuits, regardless of the number of conductors used per circuit (i.e., different phases).
Consequence	The adverse effects from an event, considering the hazard intensity, community exposure, and local vulnerability.
Contact by object ignition likelihood	The likelihood that a non-vegetative object (such as a balloon or vehicle) will contact utility-owned equipment and result in an ignition.
Contact by vegetation ignition likelihood	The likelihood that vegetation will contact utility-owned equipment and result in an ignition.
Contractor	Any individual in the temporary and/or indirect employ of the electrical corporation whose limited hours and/or time-bound term of employment are not considered “full-time” for tax and/or any other purposes.
Critical facilities and infrastructure	Facilities and infrastructure that are essential to public safety and that require additional assistance and advance planning to ensure resiliency during PSPS events. These include the following: Emergency services sector: Police stations Fire stations Emergency operations centers

¹ Adapted from T. G. Trucano, L. P. Swiler, T. Igusa, W. L. Oberkamp, and M. Pilch, 2006, “Calibration, validation, and sensitivity analysis: What’s what,” *Reliability Engineering and System Safety*, vol. 91, no. 10–11, pp. 1331– 1357.

Term	Definition
	<ul style="list-style-type: none"> • Public safety answering points (e.g., 9-1-1 emergency services) <p>Government facilities sector:</p> <ul style="list-style-type: none"> • Schools • Jails and prisons <p>Health care and public health sector:</p> <ul style="list-style-type: none"> • Public health departments • Medical facilities, including hospitals, skilled nursing facilities, nursing homes, blood banks, health care facilities, dialysis centers, and hospice facilities (excluding doctors' offices and other non-essential medical facilities) <p>Energy sector:</p> <ul style="list-style-type: none"> • Public and private utility facilities vital to maintaining or restoring normal service, including, but not limited to, interconnected publicly owned electrical corporations and electric cooperatives <p>Water and wastewater systems sector:</p> <ul style="list-style-type: none"> • Facilities associated with provision of drinking water or processing of wastewater, including facilities that pump, divert, transport, store, treat, and deliver water or wastewater <p>Communications sector:</p> <ul style="list-style-type: none"> • Communication carrier infrastructure, including selective routers, central offices, head ends, cellular switches, remote terminals, and cellular sites <p>Chemical sector:</p> <ul style="list-style-type: none"> • Facilities associated with manufacturing, maintaining, or distributing hazardous materials and chemicals (including Category N-Customers as defined in D.01-06- 085) <p>Transportation sector:</p>

Term	Definition
	<ul style="list-style-type: none"> • Facilities associated with transportation for civilian and military purposes: automotive, rail, aviation, maritime, or major public transportation <p>(D.19-05-042 and D.20-05-051)</p>
Customer hours	Total number of customers, multiplied by average number of hours (e.g., of power outage).
Danger tree	Any tree located on or adjacent to a utility right-of-way or facility that could damage utility facilities should it fall where (1) the tree leans toward the right-of-way, or (2) the tree is defective because of any cause, such as: heart or root rot, shallow roots, excavation, bad crotch, dead or with dead top, deformity, cracks or splits, or any other reason that could result in the tree or main lateral of the tree falling. (California Code of Regulation Title 14 § 895.1)
Data cleaning	Calibration of raw data to remove errors (including typographical and numerical mistakes).
Dead fuel moisture content	Moisture content of dead vegetation, which responds solely to current environmental conditions and is critical in determining fire potential.
Detailed inspection	In accordance with General Order (GO) 165, an inspection where individual pieces of equipment and structures are carefully examined, visually and through routine diagnostic testing, as appropriate, and (if practical and if useful information can be so gathered) opened, and the condition of each is rated and recorded.
Disaster	A serious disruption of the functioning of a community or a society at any scale due to hazardous events interacting with conditions of exposure, vulnerability, and capacity, leading to one or more of the following: human, material, economic, and environmental losses and impacts. The effect of the disaster can

	<p>be immediate and localized but is often widespread and could last a long time. The effect may test or exceed the capacity of a community or society to cope using its own resources. Therefore, it may require assistance from external sources, which could include neighboring jurisdictions or those at the national or international levels. (United Nations Office for Disaster Risk Reduction [UNDRR].)</p>
--	--

Term	Definition
Discussion-based exercise	Exercise used to familiarize participants with current plans, policies, agreements, and procedures or to develop new plans, policies, agreements, and procedures. Often includes seminars, workshops, tabletop exercises, and games.
Electrical corporation	Every corporation or person owning, controlling, operating, or managing any electric plant for compensation within California, except where the producer generates electricity on or distributes it through private property solely for its own use or the use of its tenants and not for sale or transmission to others.
Emergency	Any incident, whether natural, technological, or human caused, that requires responsive action to protect life or property but does not result in serious disruption of the functioning of a community or society. (FEMA/UNDRR.)
Enhanced inspection	Inspection whose frequency and thoroughness exceed the requirements of a detailed inspection, particularly if driven by risk calculations.
Equipment ignition likelihood	The likelihood that utility-owned equipment will cause an ignition through either normal operation (such as arcing) or failure.
Exercise	An instrument to train for, assess, practice, and improve performance in prevention, protection, response, and recovery capabilities in a risk-free environment. (FEMA.)

Term	Definition
Exposure	The presence of people, infrastructure, livelihoods, environmental services and resources, and other high-value assets in places that could be adversely affected by a hazard.
Fire ecology	A scientific discipline concerned with natural processes involving <u>fire</u> in an <u>ecosystem</u> and its <u>ecological</u> effects, the interactions between fire and the abiotic and biotic components of an ecosystem, and the role of fire as an ecosystem process.
Fire Potential Index (FPI)	Landscape scale index used as a proxy for assessing real-time risk of a wildfire under current and forecasted weather conditions.
Fire season	The time of year when wildfires are most likely for a given geographic region due to historical weather conditions, vegetative characteristics, and impacts of climate change. Each electrical corporation defines the fire season(s) across its service territory based on a recognized fire agency definition for the specific region(s) in California.
Frequency	The anticipated number of occurrences of an event or hazard over time.
Frequent PSPS events	Three or more PSPS events per calendar year per line circuit.
Fuel density	Mass of fuel (vegetation) per area that could combust in a wildfire.
Fuel management	Removal or thinning of vegetation to reduce the potential rate of propagation or intensity of wildfires.
Fuel moisture content	Amount of moisture in a given mass of fuel (vegetation), measured as a percentage of its dry weight.
Full-time employee (FTE)	Any individual in the ongoing and/or direct employ of the electrical corporation whose hours and/or term of

Term	Definition
	employment are considered “full-time” for tax and/or any other purposes.
Game	A simulation of operations that often involves two or more teams, usually in a competitive environment, using rules, data, and procedures designed to depict an actual or assumed real-life situation.
Goals	The electrical corporation’s general intentions and ambitions.
GO 95 nonconformance	Condition of a utility asset that does not meet standards established by GO 95.
Grid hardening	Actions (such as equipment upgrades, maintenance, and planning for more resilient infrastructure) taken in response to the risk of undesirable events (such as outages) or undesirable conditions of the electrical system to reduce or mitigate those events and conditions, informed by an assessment of the relevant risk drivers or factors.
Grid topology	General design of an electric grid, whether looped or radial, with consequences for reliability and ability to support PSPS (e.g., ability to deliver electricity from an additional source).
Hazard	A condition, situation, or behavior that presents the potential for harm or damage to people, property, the environment, or other valued resources. ³
Hazard tree	See danger tree
High Fire Threat District (HFTD)	Areas of the state designated by the CPUC as having elevated wildfire risk, where each utility must take additional action (per GO 95, GO 165, and GO 166) to mitigate wildfire risk. (D.17-01-009.)
High Fire Risk Area (HFRA)	Areas that the electrical corporation has deemed at high risk from wildfire, independent of HFTD designation.

Term	Definition
Highly rural region	In accordance with 38 CFR 17.701, area with a population of less than seven persons per square mile, as determined by the United States Bureau of the Census. For purposes of the WMP, “area” must be defined as a census tract.
High-risk species	Species of vegetation that (1) have a higher risk of either coming into contact with powerlines or causing an outage or ignition, or (2) are easily ignitable and within close proximity to potential arcing, sparks, and/or other utility equipment thermal failures. The status of species as “high-risk” must be a function of species-specific characteristics, including growth rate; failure rates of limbs, trunk, and/or roots (as compared to other species); height at maturity; flammability; and vulnerability to disease or insects.
High Wind Warning (HWW)	Level of wind risk from weather conditions, as declared by the National Weather Service (NWS). For historical NWS data, refer to the Iowa State University archive of NWS watches/warnings. ²
HWW overhead (OH) circuit mile day	Sum of OH circuit miles of utility grid subject to a HWW each day within a given time period, calculated as the number of OH circuit miles under a HWW multiplied by the number of days those miles are under said HWW. For example, if 100 OH circuit miles are under a HWW for one day, and 10 of those miles are under the HWW for an additional day, then the total HWW OH circuit mile days would be 110.
Ignition consequence	The total anticipated adverse effects from an ignition at each location in the electrical corporation service territory. This considers the likelihood that an ignition will transition into a wildfire (wildfire spread likelihood) and the consequences that the wildfire will have on each community it reaches (wildfire consequence).

² <https://mesonet.agron.iastate.edu/request/gis/watchwarn.phtml>.

Term	Definition
Ignition likelihood	The total anticipated annualized number of ignitions resulting from utility-owned assets at each location in the electrical corporation service territory. This considers probabilistic weather conditions, type and age of equipment, and potential contact of vegetation and other objects with utility assets.
Ignition probability	The relative possibility that an ignition will occur, quantified as a number between 0 percent (impossibility) and 100 percent (certainty). The higher the probability of an event, the more certainty there is that the event will occur. (Often informally referred to as likelihood or chance.)
Ignition risk	The total anticipated annualized impacts from ignitions at a specific location. This considers the likelihood that an ignition will occur, the likelihood the ignition will transition into a wildfire, and the potential consequences – considering hazard intensity, exposure potential, and vulnerability – the wildfire will have on each community it reaches.
Impact/consequence of ignition	The effect or outcome of a wildfire ignition upon objectives that may be expressed by terms including, although not limited to, maintaining health and safety, ensuring reliability, and minimizing economic and/or environmental damage.
Incident command system (ICS)	A standardized on-scene emergency management construct. It is specifically designed to provide an integrated organizational structure that reflects the complexity and demands of single or multiple incidents, without being hindered by jurisdictional boundaries. The ICS is the combination of facilities, equipment, personnel, procedures, and communications operating within a common organizational structure, designed to aid in the management of resources during incidents.
Initiative	Measure or activity, either proposed or in process, designed to reduce the consequences and/or probability of wildfire or PSPS.

Term	Definition
Integrated public alert warning system (IPAWS)	System allowing the President to send a message to the American people quickly and simultaneously through multiple communications pathways in a national emergency. IPAWS also is available to United States federal, state, local, territorial, and tribal government officials to alert the public via the Emergency Alert System (EAS), Wireless Emergency Alerts (WEA), National Oceanic and Atmospheric Administration (NOAA) Weather Radio, and other NWS dissemination channels; the internet; existing unique warning systems; and emerging distribution technologies.
Invasive species	A species (1) that is non-native (or alien) to the ecosystem under consideration and (2) whose introduction causes or is likely to cause economic or environmental harm or harm to human health.
Level 1 finding	In accordance with GO 95, an immediate safety and/or reliability risk with high probability for significant impact.
Level 2 finding	In accordance with GO 95, a variable safety and/or reliability risk (non-immediate and with high to low probability for significant impact).
Level 3 finding	In accordance with GO 95, an acceptable safety and/or reliability risk.
Limited English proficiency (LEP) population	Population with limited English working proficiency based on the International Language Roundtable scale.
Line miles	The number of miles of transmission and/or distribution conductors, including the length of each phase and parallel conductor segment.
Live fuel moisture content	Moisture content within living vegetation, which can retain water longer than dead fuel.

Term	Definition
Locally relevant	In disaster risk management, generally understood as the scale at which disaster risk strategies and initiatives are considered the most effective at achieving desired outcomes. This tends to be the level closest to impacting residents and communities, reducing existing risks, and building capacity, knowledge, and normative support. Locally relevant scales, conditions, and perspectives depend on the context of application.
Match-drop simulation	Wildfire simulation method forecasting propagation and consequence/impact based on an arbitrary ignition.
Memorandum of Agreement (MOA)	A document of agreement between two or more agencies establishing reciprocal assistance to be provided upon request (and if available from the supplying agency) and laying out the guidelines under which this assistance will operate. It can also be a cooperative document in which parties agree to work together on an agreed-upon project or meet an agreed objective.
Mitigation	Activities to reduce the loss of life and property from natural and/or human-caused disasters by avoiding or lessening the impact of a disaster and providing value to the public by creating safer communities.
Model uncertainty	The amount by which a calculated value might differ from the true value when the input parameters are known (i.e., limitation of the model itself based on assumptions). ³
Multi-attribute value function (MAVF)	Risk calculation methodology introduced during CPUC's Safety Model Assessment Proceedings (S-MAP) and Risk Assessment and Mitigation Phase (RAMP) proceedings. This methodology is established in D.18-12-014 but may be subject to change pursuant to R.20-07-013.

³ Adapted from SFPE, 2010, "Substantiating a Fire Model for a Given Application," *Society of Fire Protection Engineers Engineering Guides*.

Term	Definition
Mutual aid	Voluntary aid and assistance by the provision of services and facilities, including but not limited to electrical corporations, communication, and transportation. Mutual aid is intended to provide adequate resources, facilities, and other support to electrical corporations whenever their own resources prove inadequate to cope with a given situation.
National Incident Management System (NIMS)	A systematic, proactive approach to guide all levels of government, nongovernment organizations, and the private sector to work together to prevent, protect against, mitigate, respond to, and recover from the effects of incidents. NIMS provides stakeholders across the whole community with the shared vocabulary, systems, and processes to successfully deliver the capabilities described in the National Preparedness System. NIMS provides a consistent foundation for dealing with all incidents, ranging from daily occurrences to incidents requiring a coordinated federal response.
Near miss	Term previously used for an event with probability of ignition (now “Risk event”).
Objectives	Specific, measurable, achievable, realistic, and timely outcomes for the overall WMP strategy, or mitigation initiatives and activities that a utility can implement to satisfy the primary goals and subgoals of the WMP program.
Operations-based exercise	Type of exercise that validates plans, policies, agreements, and procedures; clarifies roles and responsibilities; and identifies resource gaps in an operational environment. Often includes drills, functional exercises (FEs), and full-scale exercises (FSEs).
Overall utility risk	The comprehensive risk due to both wildfire and PSPS incidents across a utility’s territory; the aggregate potential of adverse impacts to people, property, critical infrastructure, or other valued assets in society.

Term	Definition
Overall utility risk, ignition risk	See Ignition risk.
Overall utility risk, PSPS risk	See PSPS risk.
Parameter uncertainty	The amount by which a calculated value might differ from the true value based on unknown input parameters. (Adapted from Society of Fire Protection Engineers [SFPE] guidance.)
Patrol inspection	In accordance with GO 165, a simple visual inspection of applicable utility equipment and structures designed to identify obvious structural problems and hazards. Patrol inspections may be carried out in the course of other company business.
Performance metric	A quantifiable measurement that is used by an electrical corporation to indicate the extent to which its WMP is driving performance outcomes.
Population density	Population density is calculated using the American Community Survey (ACS) one-year estimate for the corresponding year or, for years with no such ACS estimate available, the estimate for the immediately preceding year.
Preparedness	A continuous cycle of planning, organizing, training, equipping, exercising, evaluating, and taking corrective action in an effort to ensure effective coordination during incident response. Within the NIMS, preparedness focuses on planning, procedures and protocols, training and exercises, personnel qualification and certification, and equipment certification.
Priority essential services	Critical first responders, public safety partners, critical facilities and infrastructure, operators of telecommunications infrastructure, and water electrical corporations/agencies.
Property	Private and public property, buildings and structures, infrastructure, and other items of value that may be destroyed

Term	Definition
	by wildfire, including both third-party property and utility assets.
Protective equipment and device settings	The electrical corporation’s procedures for adjusting the sensitivity of grid elements to reduce wildfire risk, other than automatic reclosers (such as circuit breakers, switches, etc.). For example, PG&E’s “Enhanced Powerline Safety Settings” (EPSS).
PSPS consequence	The total anticipated adverse effects of a PSPS for a community. This considers the PSPS exposure potential and inherent PSPS vulnerabilities of communities at risk.
PSPS event	The period from notification of the first public safety partner of a planned public safety PSPS to re-energization of the final customer.
PSPS exposure potential	The potential physical, social, or economic impact of a PSPS event on people, property, critical infrastructure, livelihoods, health, local economies, and other high-value assets.
PSPS likelihood	The likelihood of a PSPS being required by a utility given a probabilistic set of environmental conditions.
PSPS risk	The total anticipated annualized impacts from a PSPS event at a specific location. This considers the likelihood a PSPS event will be required due to environmental conditions exceeding design conditions and the potential consequences – considering exposure potential and vulnerability – of the PSPS event for each affected community.
Public safety partners	First/emergency responders at the local, state, and federal levels; water, wastewater, and communication service providers; community choice aggregators (CCAs); affected publicly owned electrical corporations/electrical cooperatives; tribal governments; Energy Safety; the Commission; the California Office of Emergency Services; and CAL FIRE.

Term	Definition
Red Flag Warning (RFW)	Level of wildfire risk from weather conditions, as declared by the NWS. For historical NWS data, refer to the Iowa State University archive of NWS watches/warnings. ⁴
RFW OH circuit mile day	Sum of OH circuit miles of utility grid subject to RFW each day within a given time period, calculated as the number of OH circuit miles under RFW multiplied by the number of days those miles are under said RFW. For example, if 100 OH circuit miles are under RFW for one day, and 10 of those miles are under RFW for an additional day, then the total RFW OH circuit mile days would be 110.
Risk	A measure of the anticipated adverse effects from a hazard considering the consequences and frequency of the hazard occurring. ⁵
Risk component	A part of an electric corporation’s risk analysis framework used to determine overall utility risk.
Risk evaluation	The process of comparing the results of a risk analysis with risk criteria to determine whether the risk and/or its magnitude is acceptable or tolerable. (ISO 31000:2009.)
Risk event	An event with probability of ignition, such as wire down, contact with objects, line slap, event with evidence of heat generation, or other event that causes sparking or has the potential to cause ignition. The following all qualify as risk events: <ul style="list-style-type: none"> • Ignitions • Outages not caused by vegetation • Outages caused by vegetation

⁴ <https://mesonet.agron.iastate.edu/request/gis/watchwarn.phtml>.

⁵ Adapted from D. Coppola, 2020, “Risk and Vulnerability,” *Introduction to International Disaster Management*, 4th ed.

Term	Definition
	<ul style="list-style-type: none"> • Wire-down events • Faults • Other events with potential to cause ignition
Risk management	Systematic application of management policies, procedures, and practices to the tasks of communication, consultation, establishment of context, and identification, analysis, evaluation, treatment, monitoring, and review of risk. (ISO 31000.)
Rule	Section of Public Utilities Code requiring a particular activity or establishing a particular threshold.
Rural region	In accordance with GO 165, area with a population of less than 1,000 persons per square mile, as determined by the U.S. Bureau of the Census. ⁶ For purposes of the WMP, “area” must be defined as a census tract.
Seminar	An informal discussion, designed to orient participants to new or updated plans, policies, or procedures (e.g., to review a new external communications standard operating procedure).
Sensitivity analysis	Process used to determine the relationships between the uncertainty in the independent variables (“input”) used in an analysis and the uncertainty in the resultant dependent variables (“output”). (SFPE guidance.)
Slash	Branches or limbs less than four inches in diameter, and bark and split products debris left on the ground as a result of utility vegetation management. (This definition is consistent with California Public Resources Code section 4525.7.)
Span	The space between adjacent supporting poles or structures on a circuit consisting of electric lines and equipment. "Span level" refers to asset-scale granularity.

⁶ https://www.cpuc.ca.gov/gos/GO95/go_95_rule_18.htm

Term	Definition
Tabletop exercise (TTX)	A discussion-based exercise intended to stimulate discussion of various issues regarding a hypothetical situation. Tabletop exercises can be used to assess plans, policies, and procedures or to assess types of systems needed to guide the prevention of, response to, or recovery from a defined incident.
Target	A forward-looking, quantifiable measurement of work to which an electrical corporation commits to in its WMP. Electrical corporations will show progress toward completing targets in subsequent reports, including QDRs and WMP Updates.
Trees with strike potential	Trees that could either “fall in” to a power line or have branches detach and “fly in” to contact a power line in high-wind conditions.
Uncertainty	The amount by which an observed or calculated value might differ from the true value. For an observed value, the difference is “experimental uncertainty”; for a calculated value, it is “model” or “parameter uncertainty.” (Adapted from SFPE guidance.)
Urban region	In accordance with GO 165, area with a population of more than 1,000 persons per square mile, as determined by the U.S. Bureau of the Census. For purposes of the WMP, “area” must be defined as a census tract.
Utility-related ignition	See reportable ignition.
Validation	Process of determining the degree to which a calculation method accurately represents the real world from the perspective of the intended uses of the calculation method without modifying input parameters based on observations in a specific scenario. (Adapted from ASTM E 1355.)
Vegetation management (VM)	Trimming and removal of trees and other vegetation at risk of contact with electric equipment.

Term	Definition
Verification	Process to ensure that a model is working as designed, that is, that the equations are being properly solved. Verification is essentially a check of the mathematics. (SFPE guidance.)
Vulnerability	The propensity or predisposition of a community to be adversely affected by a hazard, including the characteristics of a person, group, or service and their situation that influences their capacity to anticipate, cope with, resist, and recover from the adverse effects of a hazard.
Wildfire consequence	The total anticipated adverse effects from a wildfire on a community that is reached. This considers the wildfire hazard intensity, the wildfire exposure potential, and the inherent wildfire vulnerabilities of communities at risk.
Wildfire exposure potential	The potential physical, social, or economic impact of wildfire on people, property, critical infrastructure, livelihoods, health, environmental services, local economies, cultural/historical resources, and other high-value assets. This may include direct or indirect impacts, as well as short- and long-term impacts.
Wildfire intensity	The potential intensity of a wildfire at a specific location within the service territory given a probabilistic set of weather profiles, vegetation, and topography.
Wildfire mitigation strategy	Overview of the key mitigation initiatives at enterprise level and component level across the electrical corporation's service territory, including interim strategies where long-term mitigation initiatives have long implementation timelines. This includes a description of the enterprise-level monitoring and evaluation strategy for assessing overall effectiveness of the WMP.
Wildfire risk	See Ignition risk.
Wildfire spread likelihood	The likelihood that a fire with a nearby but unknown ignition point will transition into a wildfire and will spread to a location

Term	Definition
	in the service territory based on a probabilistic set of weather profiles, vegetation, and topography.
Wildland-urban interface (WUI)	The line, area, or zone where structures and other human development meet or intermingle with undeveloped wildland or vegetation fuels (National Wildfire Coordinating Group). Enforcement agencies also designate the WUI as the area at significant risk from wildfires, established pursuant to Title 24, Part 2, Chapter 7A.
Wire down	Instance where an electric transmission or distribution conductor is broken and falls from its intended position to rest on the ground or a foreign object.
Work order	A prescription for asset or vegetation management activities resulting from asset or vegetation management inspection findings.
Workshop	Discussion that resembles a seminar but is employed to build specific products, such as a draft plan or policy (e.g., a multi- year training and exercise plan).

Definitions of Initiatives by Category

Category	Section #	Initiative	Definition
Overview of the Service Territory	5.4.5	Environmental compliance and permitting	Development and implementation of process and procedures to ensure compliance with applicable environmental laws, regulations, and permitting related to the implementation of the WMP.
Risk Methodology and Assessment	6	Risk Methodology and Assessment	Development and use of tools and processes to assess the risk of wildfire and PSPS across an electrical corporation's service territory.
Wildfire Mitigation Strategy Development	7	Wildfire Mitigation Strategy Development	Development and use of processes for deciding on a portfolio of mitigation initiatives to achieve maximum feasible risk reduction and that meet the goals of the WMP.
Grid Design, Operations, and Maintenance	8.1.2.1	Covered conductor installation	Installation of covered or insulated conductors to replace standard bare or unprotected conductors (defined in accordance with GO 95 as supply conductors, including but not limited to lead wires, not enclosed in a grounded metal pole or not covered by: a "suitable protective covering" (in accordance with Rule 22.8), grounded metal conduit, or grounded metal sheath or shield). In accordance with GO 95, conductor is defined as a material suitable for: (1) carrying electric current, usually in the form of a wire, cable or bus bar, or (2) transmitting light in the case of fiber optics; insulated conductors as those which are surrounded by an insulating material (in accordance with Rule 21.6), the dielectric strength of which is sufficient to withstand the

			<p>maximum difference of potential at normal operating voltages of the circuit without breakdown or puncture; and suitable protective covering as a covering of wood or other non-conductive material having the electrical insulating efficiency (12kV/in. dry) and impact strength (20ft.-lbs) of 1.5 inches of redwood or other material meeting the requirements of Rule 22.8-A, 22.8-B, 22.8-C or 22.8-D.</p>
Grid Design, Operations, and Maintenance	8.1	Undergrounding of electric lines and/or equipment	<p>Actions taken to convert overhead electric lines and/or equipment to underground electric lines and/or equipment (i.e., located underground and in accordance with GO 128).</p>
Grid Design, Operations, and Maintenance	8.1.2.3	Distribution pole replacements and reinforcements	<p>Remediation, adjustments, or installations of new equipment to improve or replace existing distribution poles (i.e., those supporting lines under 65kV), including with equipment such as composite poles manufactured with materials reduce ignition probability by increasing pole lifespan and resilience against failure from object contact and other events.</p>
Grid Design, Operations, and Maintenance	8.1.2.4	Transmission pole/tower replacements and reinforcements	<p>Remediation, adjustments, or installations of new equipment to improve or replace existing transmission towers (e.g., structures such as lattice steel towers or tubular steel poles that support lines at or above 65kV).</p>
Grid Design, Operations, and Maintenance	8.1.2.5	Traditional overhead hardening	<p>Maintenance, repair, and replacement of capacitors, circuit breakers, cross-arms, transformers, fuses, and connectors (e.g., hot line clamps) with the intention of minimizing the risk of ignition.</p>

Grid Design, Operations, and Maintenance	8.1.2.6	Emerging grid hardening technology installations and pilots	Development, deployment, and piloting of novel grid hardening technology.
Grid Design, Operations, and Maintenance	8.1.2.7	Microgrids	Development and deployment of microgrids that may reduce the risk of ignition, risk from PSPS, and wildfire consequence. "Microgrid" is defined by Public Utilities Code section 8370(d).
Grid Design, Operations, and Maintenance	8.1.2.8	Installation of system automation equipment	Installation of electric equipment that increases the ability of the electrical corporation to automate system operation and monitoring, including equipment that can be adjusted remotely such as automatic reclosers (switching devices designed to detect and interrupt momentary faults that can reclose automatically and detect if a fault remains, remaining open if so).
Grid Design, Operations, and Maintenance	8.1.2.9	Line removals (in HFTD)	Removal of overhead lines to minimize the risk of ignition due to the design, location, or configuration of electric equipment in HFTDs.
Grid Design, Operations, and Maintenance	8.1.2.10	Other grid topology improvements to minimize risk of ignitions	Actions taken to minimize the risk of ignition due to the design, location, or configuration of electric equipment in HFTDs not covered by another initiative.
Grid Design, Operations, and Maintenance	8.1.2.11	Other grid topology improvements to mitigate or reduce PSPS events	Actions taken to mitigate or reduce PSPS events in terms of geographic scope and number of customers affected not covered by another initiative.

Grid Design, Operations, and Maintenance	8.1.2.12	Other technologies and systems not listed above	Other grid design and system hardening actions which the electrical corporation takes to reduce its ignition and PSPS risk not otherwise covered by other initiatives in this section.
Grid Design, Operations, and Maintenance	8.1.3.1	Asset inspections	Inspections of overhead electric transmission lines, equipment, and right-of-way.
Grid Design, Operations, and Maintenance	8.1.4	Equipment maintenance and repair	Remediation, adjustments, or installations of new equipment to improve or replace existing connector equipment, such as hotline clamps.
Grid Design, Operations, and Maintenance	8.1.5	Asset management and inspection enterprise system(s)	Operation of and support for centralized asset management and inspection enterprise system(s) updated based upon inspection results and activities such as hardening, maintenance, and remedial work.
Grid Design, Operations, and Maintenance	8.1.6	Quality assurance / quality control	Establishment and function of audit process to manage and confirm work completed by employees or contractors, including packaging QA/QC information for input to decision-making and related integrated workforce management processes.
Grid Design, Operations, and Maintenance	8.1.7	Open work orders	Actions taken to manage the electrical corporation's open work orders resulting from inspections that prescribe asset management activities.
Grid Design, Operations, and Maintenance	8.1.8.1	Equipment Settings to Reduce Wildfire Risk	The electrical corporation's procedures for adjusting the sensitivity of grid elements to reduce wildfire risk.
Grid Design, Operations, and Maintenance	8.1.8.2	Grid Response Procedures and Notifications	The electrical corporation's procedures it uses to respond to faults, ignitions, or other issues detected on its grid that may result in a wildfire.

Grid Design, Operations, and Maintenance	8.1	Personnel Work Procedures and Training in Conditions of Elevated Fire Risk	Work activity guidelines that designate what type of work can be performed during operating conditions of different levels of wildfire risk. Training for personnel on these guidelines and the procedures they prescribe, from normal operating procedures to increased mitigation measures to constraints on work performed.
Grid Design, Operations, and Maintenance	8.1.9	Workforce Planning	Programs to ensure that the electrical corporation has qualified asset personnel and to ensure that both employees and contractors tasked with asset management responsibilities are adequately trained to perform relevant work.
Vegetation Management and Inspection	8.2.2.1	Vegetation inspections	Inspections of vegetation around and adjacent to electrical facilities and equipment that may be hazardous by growing, blowing, or falling into electrical facilities or equipment.
Vegetation Management and Inspection	8.2.3.1	Pole clearing	Plan and execution of vegetation removal around poles per Public Resources Code section 4292 and outside the requirements of Public Resources Code section 4292 (e.g., pole clearing performed outside of the State Responsibility Area).
Vegetation Management and Inspection	8.2.3.2	Wood and slash management	Actions taken to manage all downed wood and “slash” generated from vegetation management activities.
Vegetation Management and Inspection	8.2.3.3	Clearance	Actions taken after inspection to ensure that vegetation does not encroach upon electrical equipment and facilities, such as tree trimming.
Vegetation Management and Inspection	8.2.3.4	Fall-in mitigation	Actions taken to identify and remove or otherwise remediate trees that pose a high risk of failure or fracture that could potentially strike electrical equipment.

Vegetation Management and Inspection	8.2.3.5	Substation defensible space	Actions taken to reduce ignition probability and wildfire consequence due to contact with substation equipment.
Vegetation Management and Inspection	8.2.3.6	High-risk species	Actions taken to reduce the ignition probability and wildfire consequence attributable to high-risk species of vegetation.
Vegetation Management and Inspection	8.2.3.7	Fire-resilient rights-of-way	Actions taken to promote vegetation communities that are sustainable, fire-resilient, and compatible with the use of the land as an electrical corporation right-of-way.
Vegetation Management and Inspection	8.2.3.8	Emergency response vegetation management	Planning and execution of vegetation activities in response to emergency situations including weather conditions that indicate an elevated fire threat and post-wildfire service restoration.
Vegetation Management and Inspection	8.2.4	Vegetation management enterprise system	Operation of and support for centralized vegetation management and inspection enterprise system(s) updated based upon inspection results and activities such as hardening, maintenance, and remedial work.
Vegetation Management and Inspection	8.2.5	Quality assurance / quality control	Establishment and function of audit process to manage and confirm work completed by employees or contractors, including packaging QA/QC information for input to decision-making and related integrated workforce management processes.
Vegetation Management and Inspection	8.2.6	Open work orders	Actions taken to manage the electrical corporation's open work orders resulting from inspections that prescribe vegetation management activities.

Vegetation Management and Inspection	8.2.7	Workforce planning	Programs to ensure that the electrical corporation has qualified vegetation management personnel and to ensure that both employees and contractors tasked with vegetation management responsibilities are adequately trained to perform relevant work.
Situational Awareness and Forecasting	8.3.2	Environmental monitoring systems	Development and deployment of systems which measure environmental characteristics, such as fuel moisture, air temperature, and velocity.
Situational Awareness and Forecasting	8.3.3	Grid monitoring systems	Development and deployment of systems that checks the operational conditions of electrical facilities and equipment and detects such things as faults, failures, and recloser operations.
Situational Awareness and Forecasting	8.3.4	Ignition detection systems	Development and deployment of systems which discover or identify the presence or existence of an ignition, such as cameras.
Situational Awareness and Forecasting	8.3.5	Weather forecasting	Development methodology for forecast of weather conditions relevant to electrical corporation operations, forecasting weather conditions and conducting analysis to incorporate into utility decision-making, learning and updates to reduce false positives and false negatives of forecast PSPS conditions.
Situational Awareness and Forecasting	8.3.6	Fire potential index	Calculation and application of a landscape scale index used as a proxy for assessing real-time risk of a wildfire under current and forecasted weather conditions.
Emergency Preparedness	8.4.2	Emergency preparedness plan	Development and integration of wildfire- and PSPS-specific emergency strategies, practices, policies, and procedures into the electrical corporation's overall emergency plan based on the minimum standards described in GO 166.

Emergency Preparedness	8.4.3	External collaboration and coordination	Actions taken to coordinate wildfire and PSPS emergency preparedness with relevant public safety partners including the state, cities, counties, and tribes.
Emergency Preparedness	8.4.5	Public emergency communication strategy	Development and integration of a comprehensive communication strategy to inform essential customers and other stakeholder groups of wildfires, outages due to wildfires, and PSPS and service restoration, as required by Public Utilities Code section 768.6.
Emergency Preparedness	8.4.6	Preparedness and planning for service restoration	Development and integration of the electrical corporation's plan to restore service after an outage due to a wildfire or PSPS event.
Emergency Preparedness	8.4.6	Customer support in wildfire and PSPS emergencies	Development and deployment of programs, systems, and protocols to support residential and non-residential customers in wildfire emergencies and PSPS events.
Community Outreach and Engagement	8.5.2	Public outreach and education awareness program	Development and deployment of public outreach and education awareness program(s) for wildfires; outages due to wildfires, PSPS events, and protective equipment and device settings; service restoration before, during, and after the incidents and vegetation management.
Community Outreach and Engagement	8.5.3	Engagement with access and functional needs populations	Actions taken understand, evaluate, design, and implement wildfire and PSPS risk mitigation strategies, policies, and procedures specific to access and functional needs customers.

Community Outreach and Engagement	8.5.4	Collaboration on local wildfire mitigation planning	Development and integration of plans, programs, and/or policies for collaborating with communities on local wildfire mitigation planning, such as wildfire safety elements in general plans, community wildfire protection plans, and local multi-hazard mitigation plans.
Community Outreach and Engagement	8.5.5	Best practice sharing with other utilities	Development and integration of an electrical corporation's policy for sharing best practices and collaborating with other electrical corporations on technical and programmatic aspects of its WMP program.

APPENDIX B: SUPPORTING DOCUMENTATION FOR RISK METHODOLOGY AND ASSESSMENT

Note: As part of its 2023-2025 WMP, the electrical corporation is required to provide the “Summary Documentation” as defined by this appendix. For all other requirements in this appendix, the electrical corporation must be readily able to provide the defined documentation in response to a data request by Energy Safety or designated stakeholders.

The risk modeling and assessment in the main body of these Guidelines and electrical corporation’s WMP are focused on providing a streamlined overview of the electrical corporation risk framework and key findings from the assessment necessary to understand the wildfire mitigation strategy presented in Section 7.

The focus of this appendix is to provide additional information pertaining to the risk modeling approach used by the electrical corporation. This includes the following:

- *Additional detail on model calculations supporting the calculation of risk and risk components*
- *Additional detail on the calculation of risk and risk components*
- *More detailed presentation of the risk findings*

The following sections establish the reporting requirements for the approaches used by the electrical corporation to calculate each risk and risk component. These have been synthesized and adapted from guidance documents on model quality assurance developed by many agencies, with a focus on guidance related to machine learning, artificial intelligence, and fire science and engineering. These guidance documents include those from the Institute of Electrical and Electronics Engineers (IEEE),²⁹⁹ the Society of Fire Protection Engineers (SFPE),³⁰⁰ the American Society for Testing and Materials (ASTM International),³⁰¹ the U.S. Nuclear Regulatory Commission (NRC),³⁰² the Electric Power Research Institute

²⁹⁹ IEEE, 2022, “P2841/D2: Draft Framework and Process for Deep Learning Evaluation.”

³⁰⁰ SFPE, 2010, “Substantiating a Fire Model for a Given Application,” *Engineering Guides*.

³⁰¹ ASTM, 2005, “ASTM E1472: Standard Guide for Documenting Computer Software for Fire Models,” ASTM International.

ASTM, 2005, “ASTM E1895: Standard Guide for Determining Uses and Limitations of Deterministic Fire Models,” ASTM International.

ASTM, 2005, “ASTM E1355: Standard Guide for Evaluating the Predictive Capability of Deterministic Fire Models,” ASTM International.

³⁰² U.S. NRC, EPRI, Jensen Hughes, NIST, 2016, “NUREG-1824: Verification and Validation of Selected Fire Models for Nuclear Power Plant Applications. Supplement 1.”

U.S. NRC, EPRI, Hughes Associates, Inc., NIST, California Polytechnic State University, Westinghouse Electric Company, University of Maryland, Science Applications International Corporation, ERIN Engineering, 2012, “NUREG-1934: Nuclear Power Plant Fire Modeling Application Guide.”

(EPRI),⁵² the National Institute of Standards and Technology (NIST),³⁰³ and the International Organization for Standardization (ISO).³⁰⁴

Summary Documentation

The electrical corporation must provide high-level information on the calculation of each risk and risk component used in its risk analysis.

High-level bow tie schematic showing the inputs, outputs, and interaction between risk components in the format shown in Figure SCE B-01. An example is provided below.

High-level calculation procedure schematic in the format shown in Figure SCE B-02 This schematic must show the logical flow from input data to outputs, including separate items for any intermediate calculations in models or sub-models and any input from subject matter experts.

High-level narrative describing the calculation procedure in a concise executive summary. This narrative must include the following:

- Purpose of the calculation/model
- Assumptions and limitations
- Description of the calculation procedure shown in the bow tie and high-level schematics
- Description of how outputs will be characterized and presented (e.g., visualization) to decision makers
- Concise description and timeline of planned changes to the calculation procedure over the triennial WMP cycle, including any key improvements from the Energy Safety Wildfire Risk Modeling Working Group and plans to align with the consensus Risk Modeling Requirements by January 1, 2024.

³⁰³ NIST, 1981, "NBS SP 500-73: Computer Model Documentation Guide."

³⁰⁴ ISO, 2013, "ISO/TR 16730:2013: Fire Safety Engineering: Assessment, Verification and Validation of Calculation Methods."

ISO, 2021, "ISO/IEC TR 24027:2021: Information Technology: Artificial Intelligence (AI) – Bias in AI Systems and AI Aided Decision Making."

ISO, 2021, "ISO/IEC TR 24029:2021: Artificial Intelligence (AI): Assessment of the Robustness of Neural Networks."

R1: Overall Utility Risk

Figure SCE B-01 - SCE's Overall Utility Risk Bow Tie Schematic

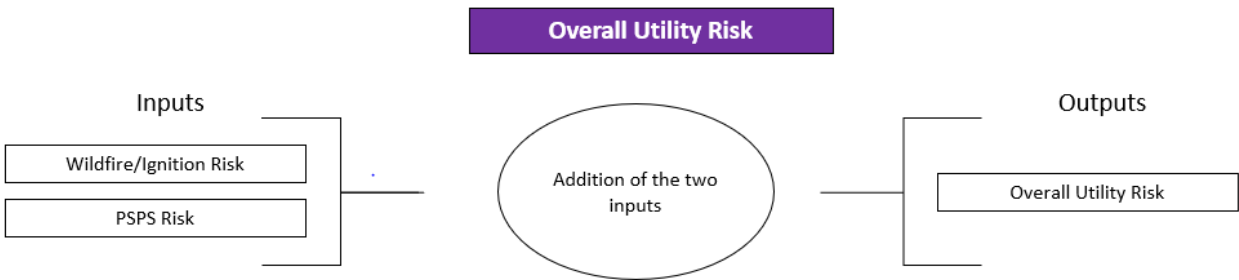
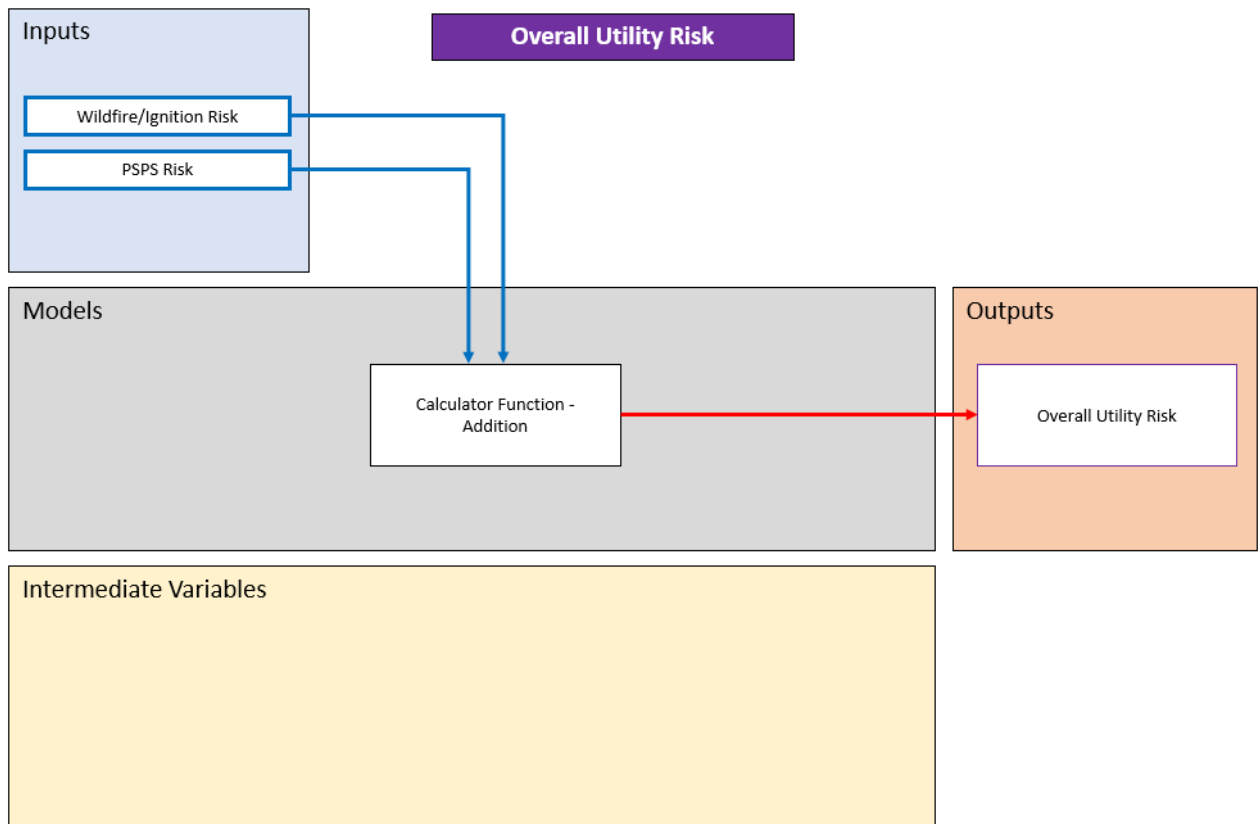

Figure SCE B-02 - SCE's Overall Utility Risk Calculation Procedure Schematic



Purpose of the calculation/model

Overall Utility Risk calculates the overall risk, based on its two sub-components; Wildfire/Ignition Risk and PSPS Risk.

Assumptions and limitations

The risk calculation is based on assumptions and limitations from more granular sub-components (e.g., Likelihood of Ignition, Wildfire Consequences, etc.).

Description of the calculation procedure shown in the bow tie and high-level schematics

Overall Utility Risk is a summation of the Wildfire and PSPS Risk components.

Description of how outputs will be characterized and presented (e.g., visualization) to decision makers

Overall Utility Risk can be broken down into its two components (Wildfire/Ignition Risk and PSPS Risk) and shown in aggregate or individually, depending on the purpose of the presentation.

Concise description and timeline of planned changes to the calculation procedure over the triennial WMP cycle, including any key improvements from the Energy Safety Wildfire Risk Modeling Working Group and plans to align with the consensus Risk Modeling Requirements by January 1, 2024.

Overall Utility Risk is a composite of all the individual sub-components. Please refer to the individual sub-components for description and timeline of key improvements.

R2: Ignition Risk

Figure SCE B-03 - SCE's Ignition Risk Bow Tie Schematic

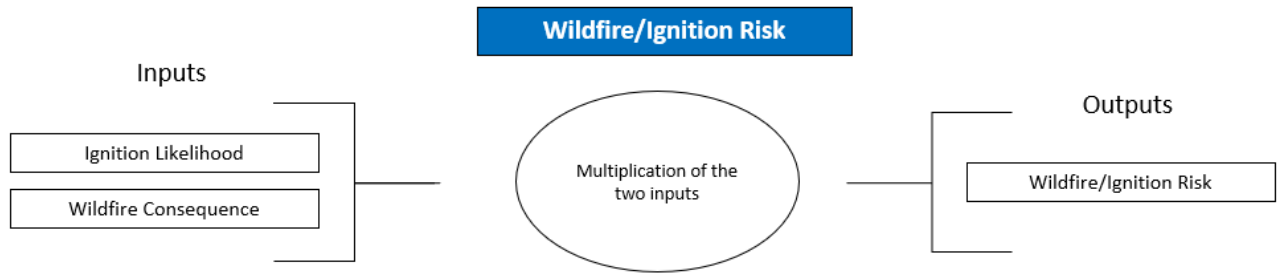
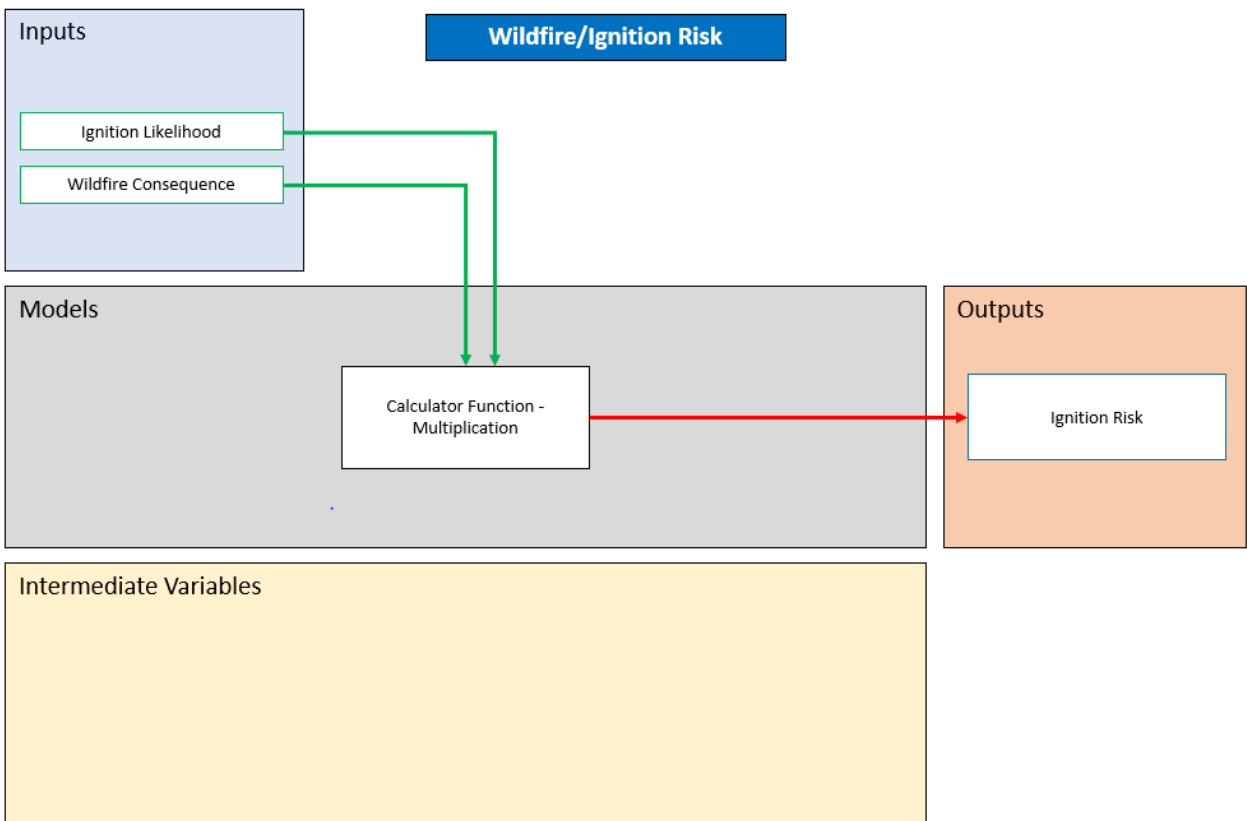

Figure SCE B-04 - SCE's Ignition Risk Calculation Procedure Schematic



Purpose of the calculation/model

SCE considers Ignition Risk synonymous with Wildfire Risk, which is based on its two sub-components, Ignition Likelihood (IRC1) and Wildfire Consequence (IRC3).

Assumptions and limitations

The risk calculation is based on assumptions and limitations from more granular sub-components (e.g., Likelihood of Ignition, Wildfire Consequences, etc.)

Description of the calculation procedure shown in the bow tie and high-level schematics

Ignition or Wildfire Risk is a multiplication of the Ignition Likelihood (IRC1) and Wildfire Consequence (IRC3).

Description of how outputs will be characterized and presented (e.g., visualization) to decision makers

Ignition or Wildfire Risk can be broken down into its two components (Ignition Likelihood (IRC1) and Wildfire Consequence (IRC3) and can be further broken down into the subcomponents (e.g. Equipment or Contact from Object Likelihood), depending on the purpose of the presentation.

Concise description and timeline of planned changes to the calculation procedure over the triennial WMP cycle, including any key improvements from the Energy Safety Wildfire Risk Modeling Working Group and plans to align with the consensus Risk Modeling Requirements by January 1, 2024.

Ignition Risk is a composite of the individual sub-components. Please refer to the individual sub-components for description and timeline of key improvements.

IRC2: Wildfire Likelihood

Please see Section 6.2.1 for SCE's approach to this risk component.

IRC1: Ignition Likelihood

Figure SCE B-05 - SCE's Ignition Likelihood Bow Tie Schematic

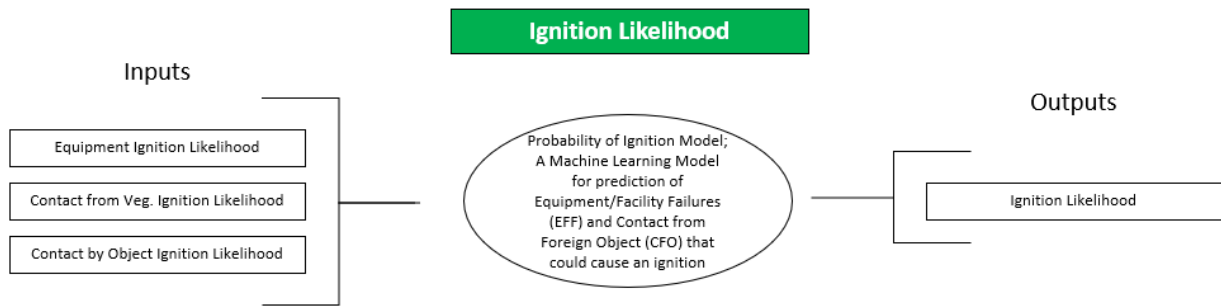
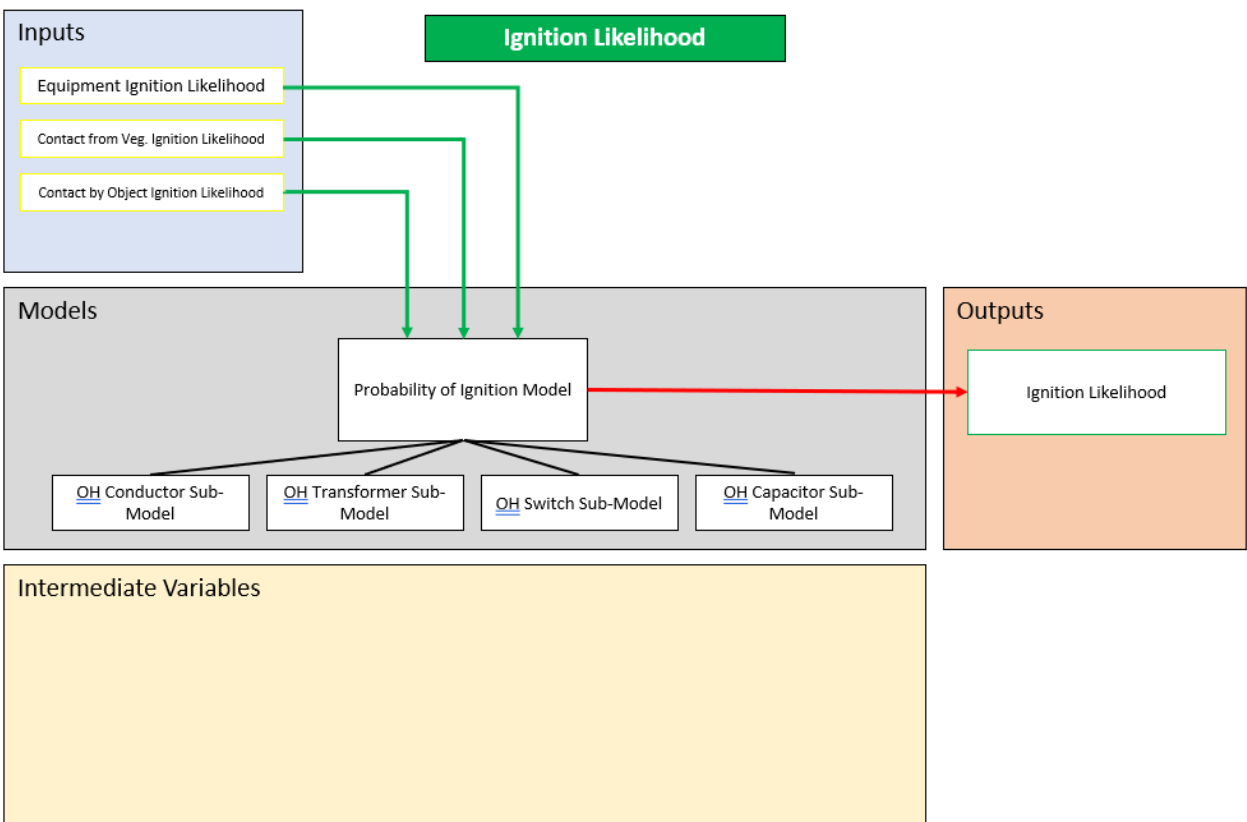

Figure SCE B-06 - SCE's Ignition Likelihood Calculation Procedure Schematic



Purpose of the calculation/model

SCE considers Ignition Likelihood (IRC1) to be synonymous with Probability of Ignition (POI), which is based on inputs of the sub-component likelihood models (Equipment Likelihood of Ignition (FRC1), Contact from Vegetation Likelihood (FRC2), and Contact from Object Likelihood)

Assumptions and limitations

The probability of ignition is a probabilistic assessment of each asset's pre-mitigated ignition likelihood prior to mitigation deployment. SCE does not differentiate between Ignition Likelihood and Wildfire Likelihood. As described in Section 6.1.1, SCE models potential fire behavior and spread from individual utility asset locations.

Description of the calculation procedure shown in the bow tie and high-level schematics

POI is the sum of the ignition component probabilities at that location (i.e., Equipment Ignition Likelihood (FRC1), Contact from Vegetation Ignition Likelihood (FRC2), and Contact by Object Ignition Likelihood (FRC3).

Description of how outputs will be characterized and presented (e.g., visualization) to decision makers

Ignition Likelihood can be broken down into its components (i.e., Equipment Ignition Likelihood (FRC1), Contact from Vegetation Ignition Likelihood (FRC2), and Contact by Object Ignition Likelihood (FRC3) and can be further broken down into the subdrivers (e.g. EFF - Transformers, CFO – Balloon, CFO – Animal, CFO – Vehicles, etc.), depending on the purpose of the presentation.

Concise description and timeline of planned changes to the calculation procedure over the triennial WMP cycle, including any key improvements from the Energy Safety Wildfire Risk Modeling Working Group and plans to align with the consensus Risk Modeling Requirements by January 1, 2024.

Ignition Likelihood is a key component in the calculation of the Ignition Risk. As described in Section 6.7, SCE will develop and evaluate an additional predictive model for secondary conductor as an enhancement to the OH Conductor model to more obtain more granular data for equipment related failures for secondary conductor that contributes to POI sub-drivers. This will ideally provide more accuracy in our asset models between primary and secondary failures for both EFF and CFO subdrivers.

FRC1: Equipment Likelihood of Ignition

Figure SCE B-07 - SCE's Equipment Likelihood of Ignition Bow Tie Schematic

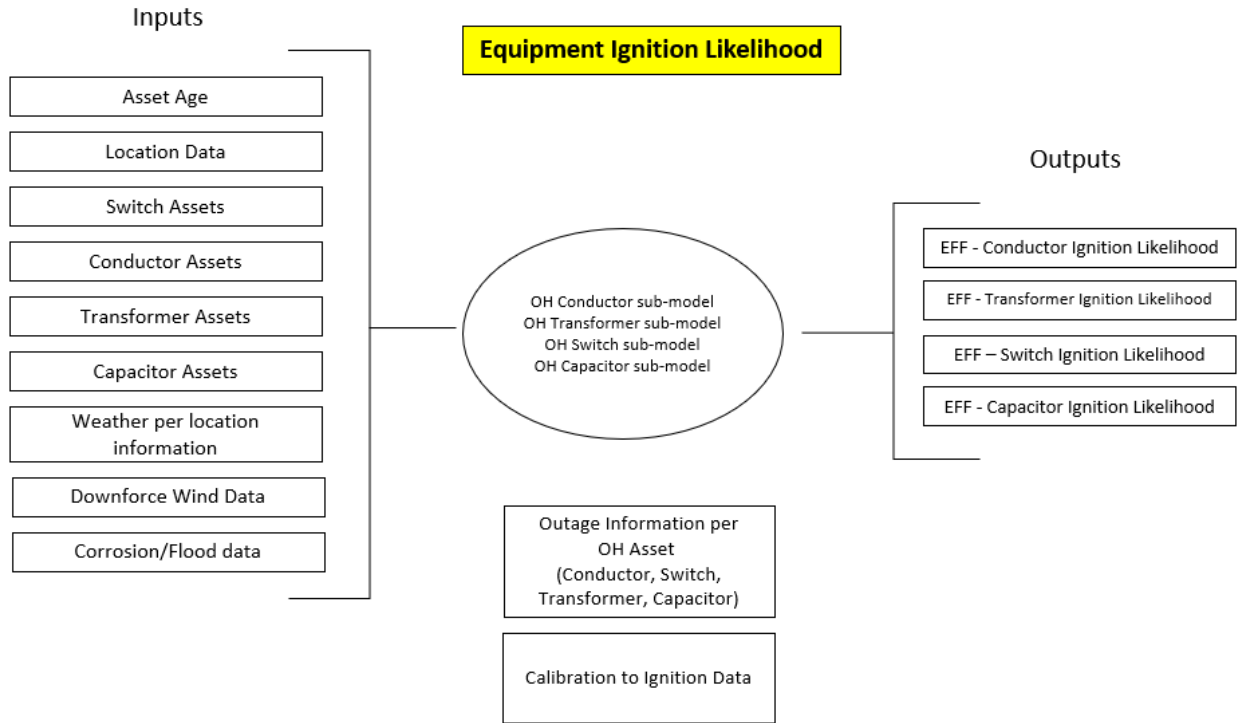
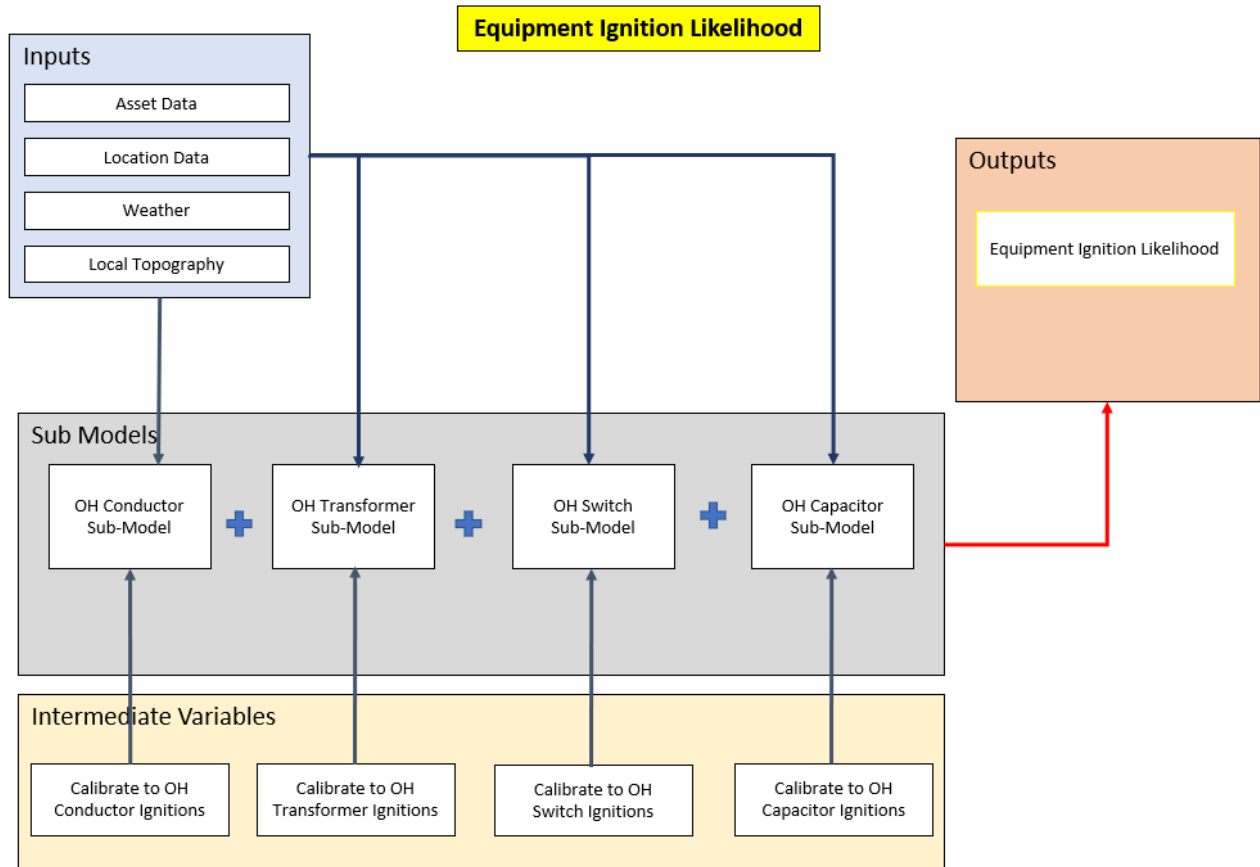

Figure SCE B-08 - SCE's Equipment Likelihood of Ignition Calculation Procedure Schematic



Purpose of the calculation/model

Equipment Ignition Likelihood (FRC1), a subcomponent of Ignition Likelihood (IRC1), calculates the likelihood that electrical corporation-owned equipment will cause an ignition either through normal operation (such as arcing) or through failure.

Assumptions and limitations

The probability of ignition of an Equipment/Facility Failure (EFF POI) is a probabilistic assessment of each asset's pre-mitigated ignition likelihood prior to mitigation deployment.

Description of the calculation procedure shown in the bow tie and high-level schematics

EFF POI is the sum of the ignition component probabilities at that location of the ignition component sub models (e.g. conductor POI, transformer POI, switch POI, capacitor POI). These subcomponent asset models utilize machine learning (ML) algorithms to assess the relevance of ignition drivers relevant to that subcomponent type. Each EFF related subcomponent model uses historical asset outage data, current asset condition (e.g., age, voltage, inspection results, etc.) and relevant environmental attributes (e.g. historical wind, asset loading, number of customers, temperature, relative humidity, etc.). Each model is calibrated with associated outage data for the OH asset type and ignition data.

Description of how outputs will be characterized and presented (e.g., visualization) to decision makers

Equipment Ignition Likelihood can be broken down into its subcomponents for each asset model or shown in aggregate for overall SCE system EFF POI depending on the purpose of the presentation.

Concise description and timeline of planned changes to the calculation procedure over the triennial WMP cycle, including any key improvements from the Energy Safety Wildfire Risk Modeling Working Group and plans to align with the consensus Risk Modeling Requirements by January 1, 2024.

In addition to the improvements listed in Section 6.7, SCE will review feedback from the Wildfire Risk Modeling Working group and other stakeholder forums to assess key improvements or changes.

FRC2: Contact from Vegetation Likelihood

Figure SCE B-09 - SCE's Contact from Vegetation Likelihood Bow Tie Schematic

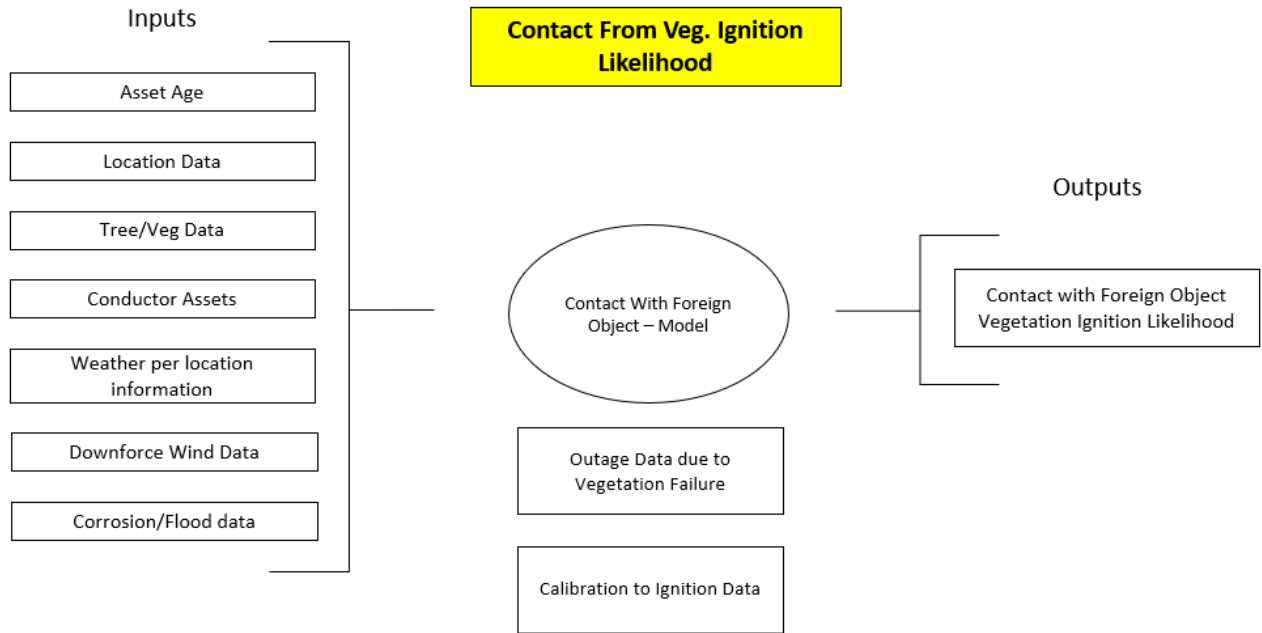
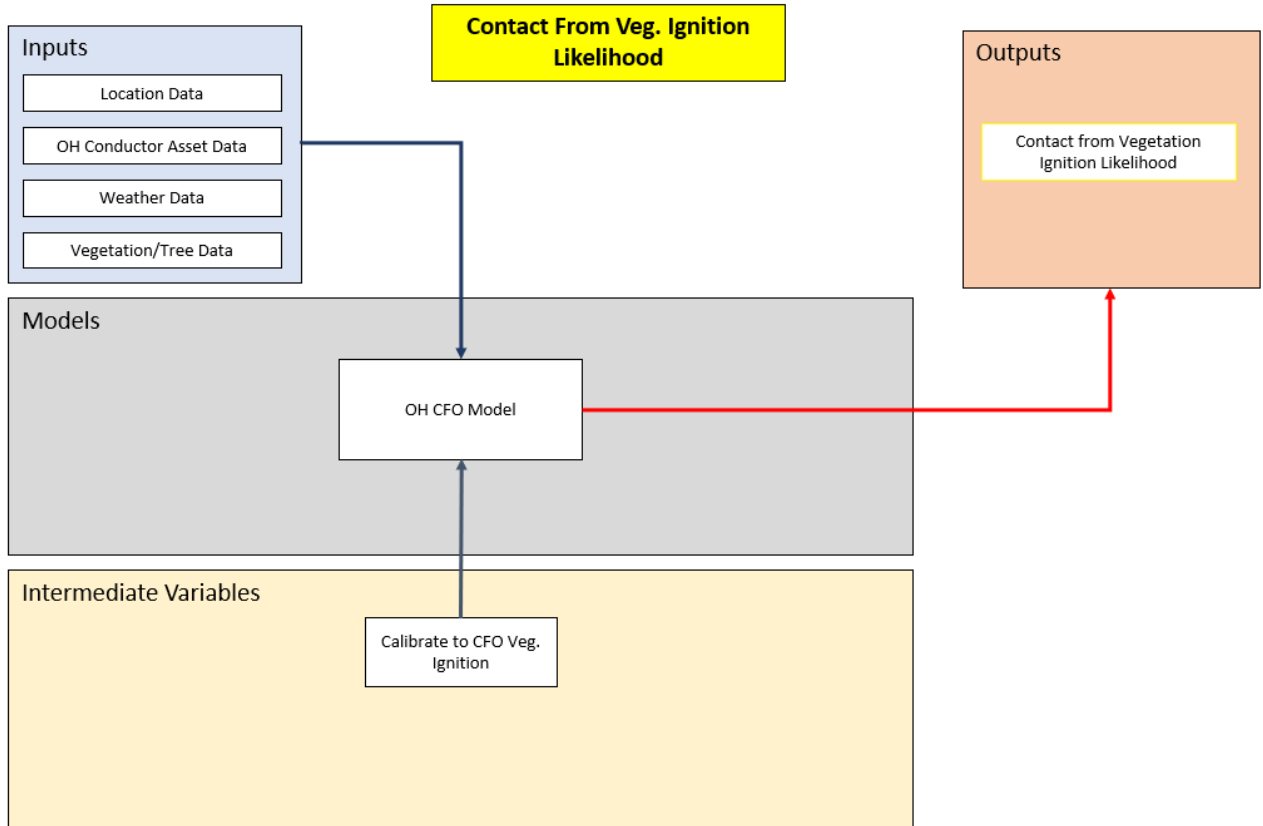

Figure SCE B-10 - SCE's Contact from Vegetation Likelihood Calculation Procedure Schematic



Purpose of the calculation/model

Contact from Vegetation Ignition Likelihood (FRC2), a subcomponent of Ignition Likelihood (IRC1), calculates the likelihood that vegetation will contact electrical corporation-owned equipment and cause an ignition either through a fault or arcing event at a given location.

Assumptions and limitations

The probability of ignition of a Contact from Foreign Object - Vegetation (CFO-Veg POI) is a probabilistic assessment of each asset's pre-mitigated ignition likelihood prior to mitigation deployment.

Description of the calculation procedure shown in the bow tie and high-level schematics

CFO-Veg POI is the output of the Contact from Foreign Object model that utilizes machine learning (ML) algorithms to assess the relevance of ignition subdrivers relevant to vegetation subdrivers. The CFO model uses historical asset outage data, current asset condition (e.g., age, voltage, inspection results, etc.) and relevant environmental attributes (e.g. historical wind, asset loading, number of customers, temperature, relative humidity, etc.). The model is calibrated with associated outage data and ignition data.

Description of how outputs will be characterized and presented (e.g., visualization) to decision makers

Contact from Vegetation Ignition Likelihood is a subcomponent of the CFO Model and is typically shown in conjunction with other CFO subdrivers (as detailed in Contact by Object Likelihood (FRC3)).

Concise description and timeline of planned changes to the calculation procedure over the triennial WMP cycle, including any key improvements from the Energy Safety Wildfire Risk Modeling Working Group and plans to align with the consensus Risk Modeling Requirements by January 1, 2024.

In addition to the improvements listed in Section 6.7, SCE will review feedback from the Wildfire Risk Modeling Working group and other stakeholder forums to assess key improvements or changes.

FRC3: Contact from Object Likelihood

Figure SCE B-11 - SCE's Contact from Object Likelihood Bow Tie Schematic

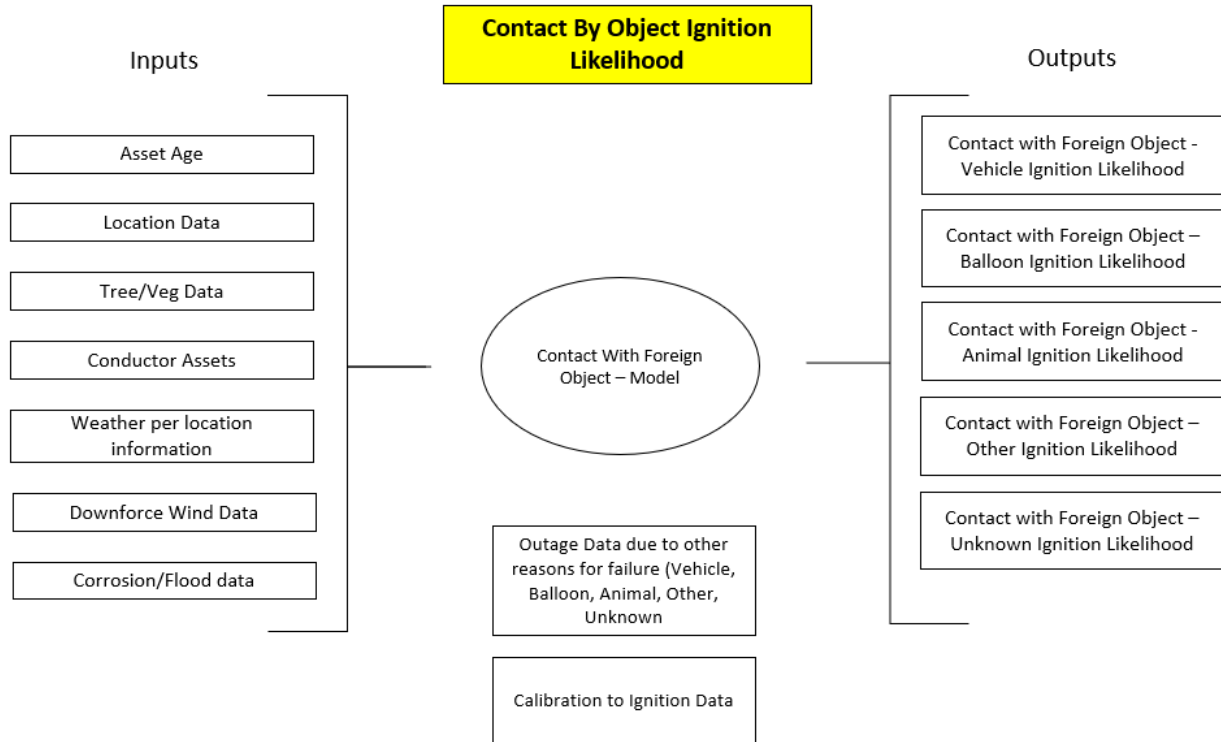
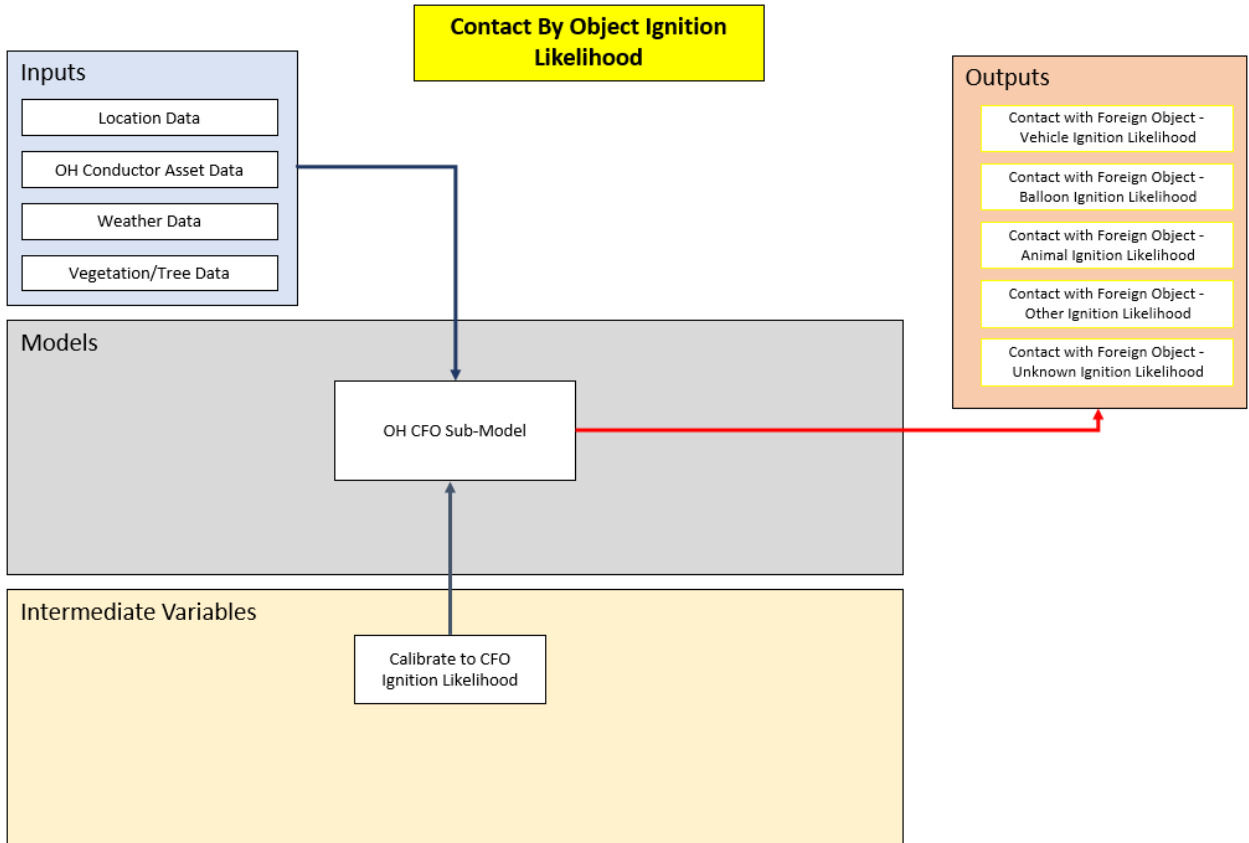

Figure SCE B-12 - SCE's Contact from Object Likelihood Calculation Procedure Schematic



Purpose of the calculation/model

Contact by Object Ignition Likelihood (FRC3), a subcomponent of Ignition Likelihood (IRC1), calculates the likelihood that a non-vegetative object (e.g., vehicle, balloon, animal, other, unknown) will contact electrical corporation-owned equipment and cause an ignition either through a fault or arcing event at a given location.

Assumptions and limitations

The probability of ignition of a Contact from Foreign Object (CFO POI) is a probabilistic assessment of each asset's pre-mitigated ignition likelihood prior to mitigation deployment.

Description of the calculation procedure shown in the bow tie and high-level schematics

CFO POI is the output of the Contact from Foreign Object model that utilizes machine learning (ML) algorithms to assess the relevance of ignition subdrivers relevant to non-vegetative subdrivers (e.g. vehicle, balloon, animal, other, unknown). The CFO model uses historical asset outage data, current asset condition (e.g., age, voltage, inspection results, etc.) and relevant environmental attributes (e.g. historical wind, asset loading, number of customers, temperature, relative humidity, etc.). The model is calibrated with associated outage data for each subdriver and ignition data.

Description of how outputs will be characterized and presented (e.g., visualization) to decision makers

Contact by Object Ignition Likelihood are subcomponents of the CFO Model and is typically shown in conjunction with other CFO subdrivers (as detailed in Contact from Vegetation Likelihood (FRC2)).

Concise description and timeline of planned changes to the calculation procedure over the triennial WMP cycle, including any key improvements from the Energy Safety Wildfire Risk Modeling Working Group and plans to align with the consensus Risk Modeling Requirements by January 1, 2024.

In addition to the improvements listed in Section 6.7, SCE will review feedback from the Wildfire Risk Modeling Working group and other stakeholder forums to assess key improvements or changes.

FRC4: Burn Probability

Please see Section 6.2.1 for SCE's approach to this risk component.

IRC3: Wildfire Consequence

Figure SCE B-13 - SCE's Wildfire Consequence Bow Tie Schematic

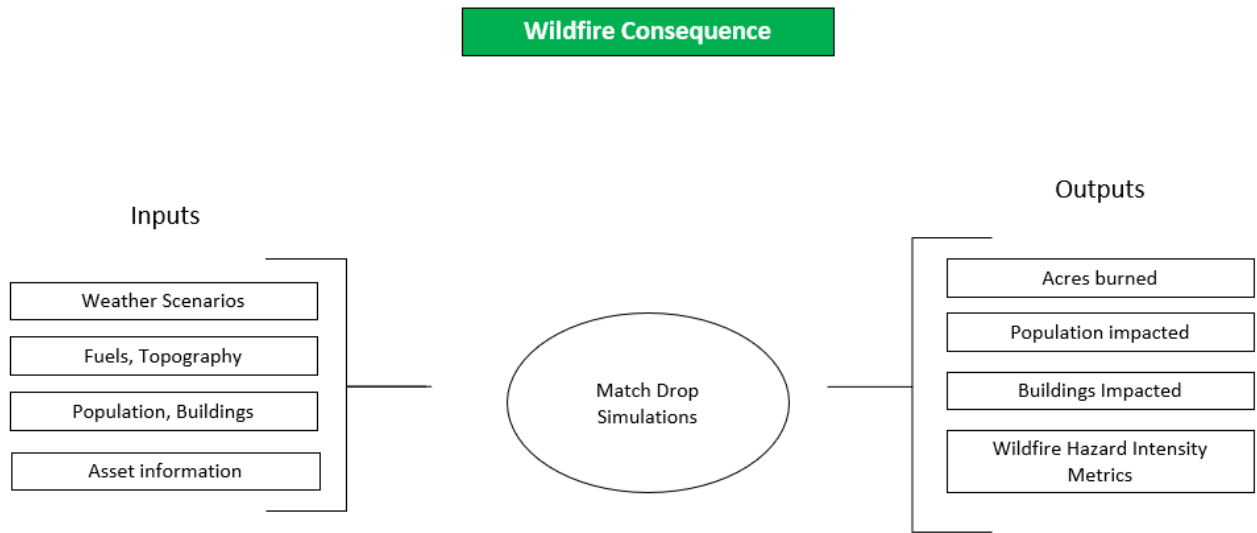
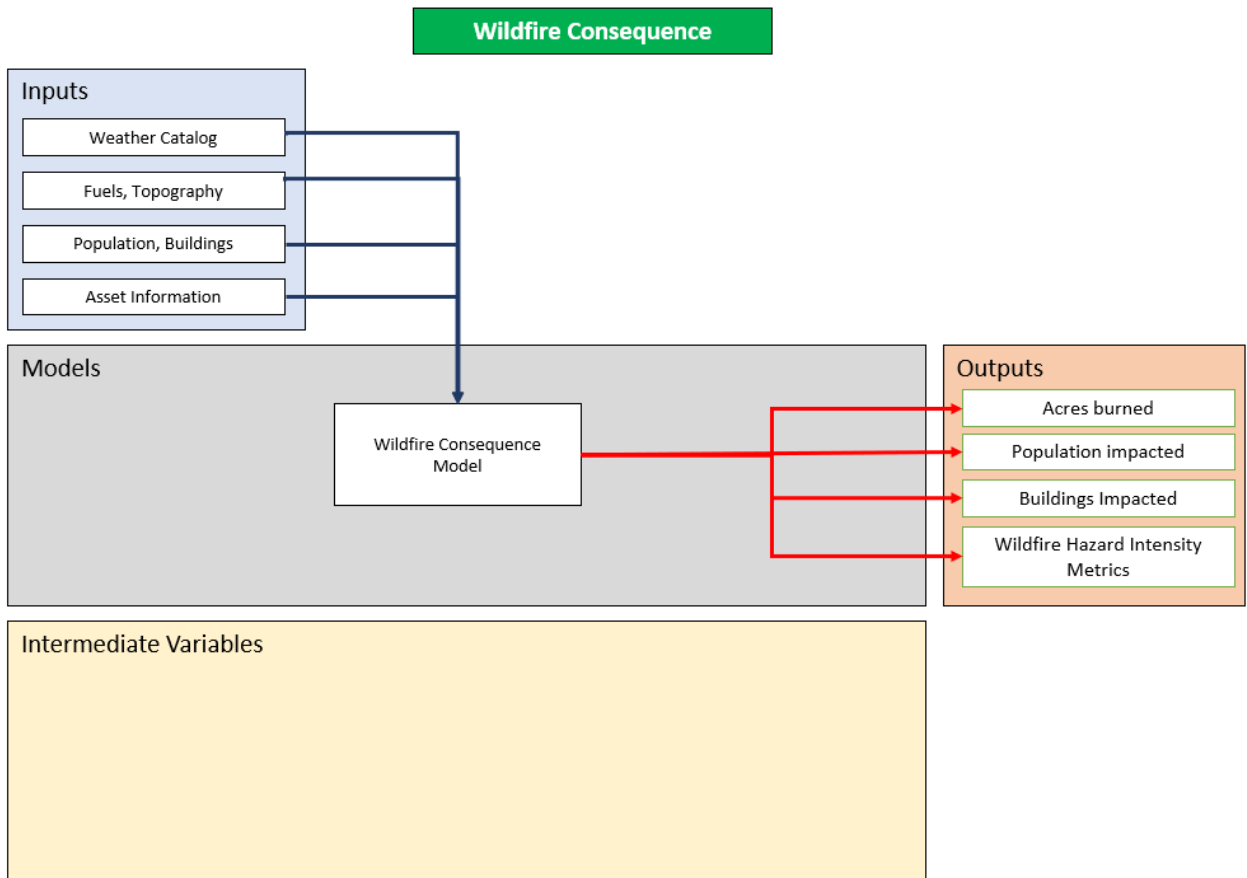

Figure SCE B-14 - SCE's Wildfire Consequence Calculation Procedure Schematic



Purpose of the calculation/model

Wildfire Consequence is used, in conjunction with Wildfire Vulnerability, to assess the impact of potential consequences associated with an ignition event in proximity to overhead assets.

Assumptions and limitations

SCE assumes an eight-hour, unsuppressed burn time for all ignition events. These simulations are representative of a deterministic maximum first burning period. These simulations are intended to provide a relative comparison of the wildfire risk across the landscape in proximity to overhead utility assets.

Description of the calculation procedure shown in the bow tie and high-level schematics

SCE estimates Wildfire Consequences (e.g., acres burned, structures impacted, population impacted) and their associated safety and financial impacts for a given set of deterministic match drop simulations for all overhead assets in SCE's HFTD across 444 weather scenarios using a 2030 fuel projection.

Description of how outputs will be characterized and presented (e.g., visualization) to decision makers

SCE utilizes these natural unit consequences to estimate risk reduction using SCE's MARS Risk Framework (see Section 6.4), as well as to categorize risk within the context of SCE's IWMS Risk Framework.

In the IWMS Risk Framework, SCE categorizes simulated wildfires based on three definitions:

Significant Fires are simulated fires that, at 8 hours after ignition, burned more than 10,000 acres or had at least one fatality or had at least 50 structures impacted

Destructive Fires are simulated fires that, at 8 hours after ignition, burned between 300 acres and 10,000 acres with zero fatalities and/or had fewer than 50 structures impacted

Small Fires are simulated fires that, at 8 hours after ignition, burned less than 300 acres with zero fatalities and no structures impacted

These three categories inform the risk tranches of Severe Risk Areas (Significant Fires), High Consequence Areas (Destructive Fires), and Other HFRA (Small Fires) that SCE uses to determine mitigation selection, prioritization, and scope deployment. Please see the description of the IWMS methodology in Section 6.2.1 for additional factors considered such as egress and burn-in buffer.

Concise description and timeline of planned changes to the calculation procedure over the triennial WMP cycle, including any key improvements from the Energy Safety Wildfire Risk Modeling Working Group and plans to align with the consensus Risk Modeling Requirements by January 1, 2024.

In addition to the improvements listed in Section 6.7, SCE will review feedback from the Wildfire Risk Modeling Working group and other stakeholder forums to assess key improvements or changes.

FRC5: Wildfire Hazard Intensity

Please see Section 6.2.1 for SCE's approach to this risk component.

FRC6: Wildfire Exposure Potential

Please see Section 6.2.1 for SCE's approach to this risk component.

R3: PSPS Risk

Figure SCE B-15 - SCE's PSPS Risk Bow Tie Schematic

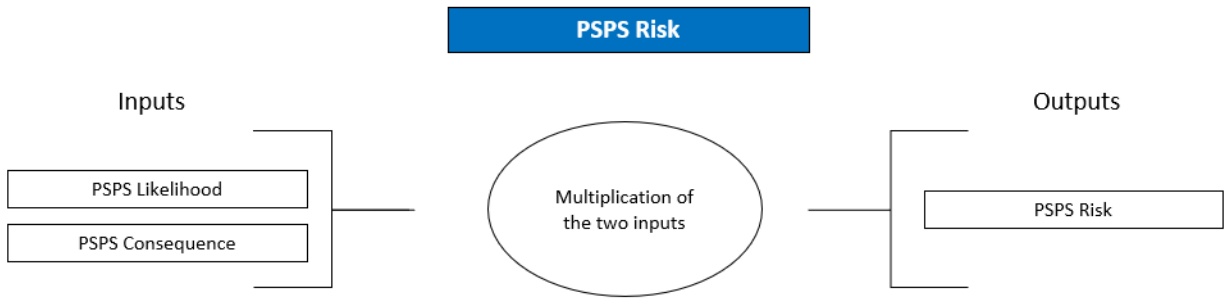
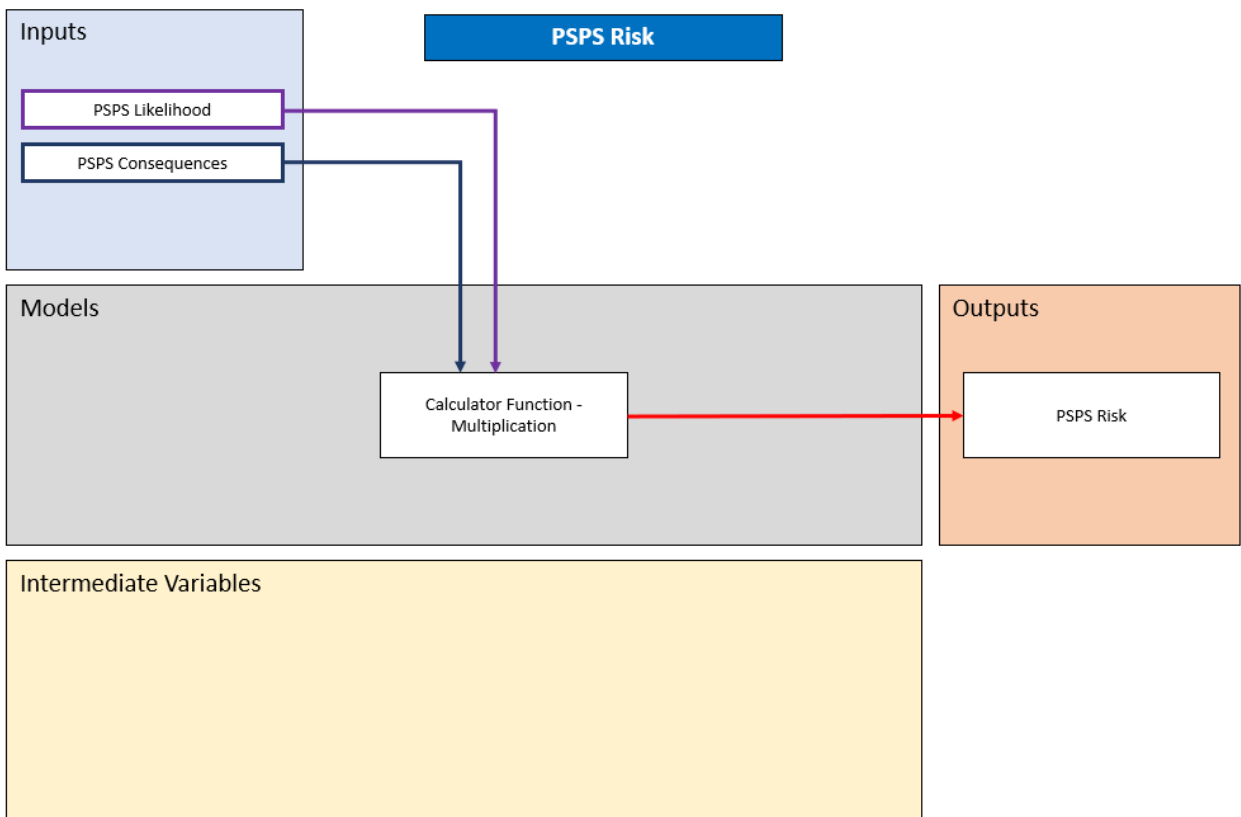

Figure SCE B-16 - SCE's PSPS Risk Calculation Procedure Schematic



Purpose of the calculation/model

PSPS Risk (R3) calculates the overall PSPS risk, based on two inputs – PSPS Likelihood (IRC4) and PSPS Consequences (IRC5).

Assumptions and limitations

The risk calculation is based on assumptions and limitations from more granular sub-components – PSPS Likelihood and PSPS Consequences.

Description of the calculation procedure shown in the bow tie and high-level schematics

PSPS Risk is a product of PSPS Likelihood and PSPS Consequences.

Description of how outputs will be characterized and presented (e.g., visualization) to decision makers

PSPS Risk components (likelihood and consequences) can be shown individually or shown as a single risk score per circuit, depending on the purpose of the presentation.

Concise description and timeline of planned changes to the calculation procedure over the triennial WMP cycle, including any key improvements from the Energy Safety Wildfire Risk Modeling Working Group and plans to align with the consensus Risk Modeling Requirements by January 1, 2024.

PSPS Risk is a composition of the individual sub-components. Please refer to the individual sub-components for description and timeline of key improvements.

IRC4: PSPS Likelihood

Figure SCE B-17 - SCE's PSPS Likelihood Bow Tie Schematic

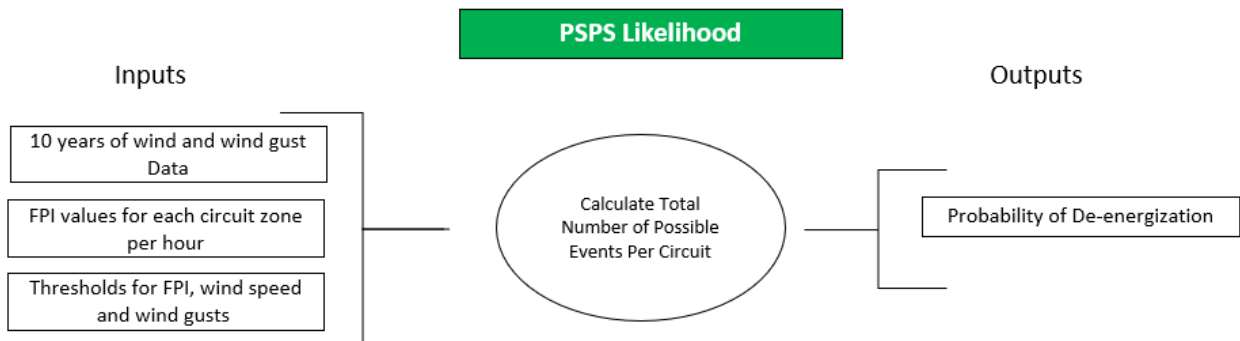
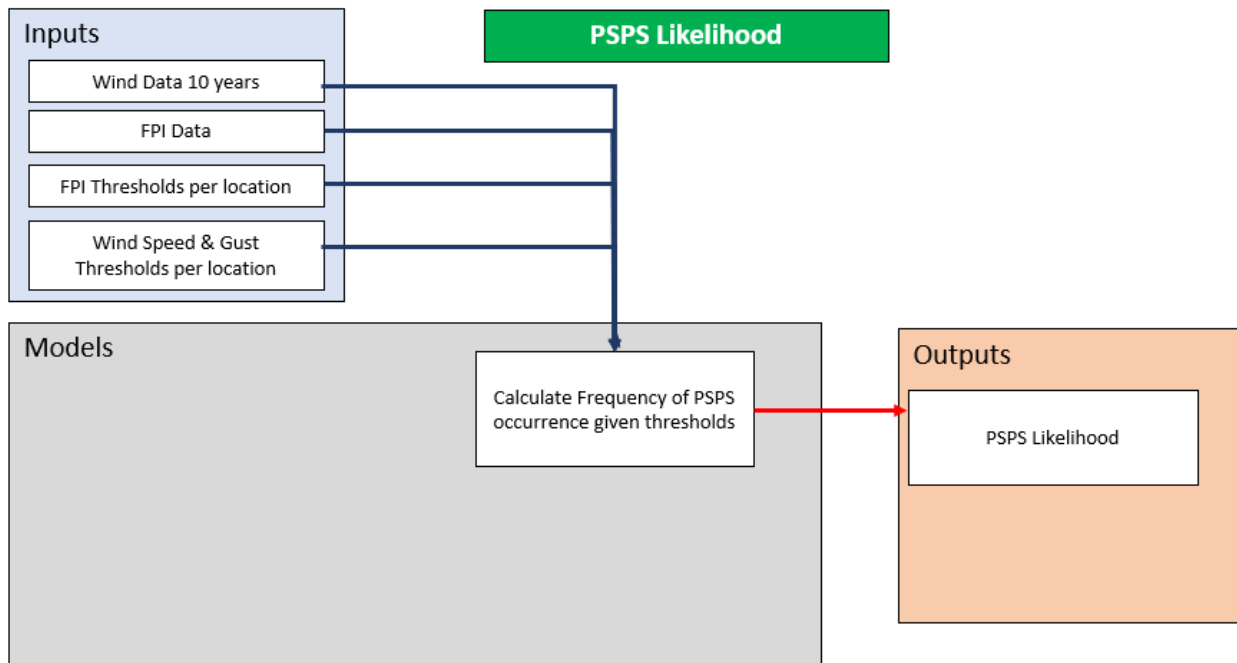

Figure SCE B-18 - SCE's PSPS Likelihood Calculation Procedure Schematic



Purpose of the calculation/model

SCE considers PSPS Likelihood as synonymous with Probability of De-energization (POD). POD is used to estimate the projected frequency and duration of future PSPS events.

Assumptions and limitations

SCE assumes future wind conditions will resemble past conditions. Additionally, SCE assumes current de-energization thresholds will remain in place.

Description of the calculation procedure shown in the bow tie and high-level schematics

Depending on the current state of grid hardening on each individual circuit, the Probability of De-energization is based on the frequency and duration estimates in terms of total annual hours for each circuit. SCE utilizes de-energization thresholds based on historical wind speed, and wind gusts conditions and hourly FPI values to approximate the likely frequency and duration of PSPS events for both harden and unhardened circuits. See De-energization Thresholds in Table SCE-B-01 below.

Description of how outputs will be characterized and presented (e.g., visualization) to decision makers

Table SCE B-01 provides the de-energization thresholds of harden and unhardened circuits. The hardened or unhardened calculated exceedance will determine the projected frequency and duration of future PSPS events

Table SCE B-01 - De-energization Thresholds

Unhardened Thresholds)	FPI > 12 AND Wind (Sustained) > 31 mph OR Wind (Gust) > 46 mph
Hardened Thresholds	FPI > 13 in all Fire Climate Zones (FCZs) except Zone 1 “Coastal” where FPI > 12 is used AND Wind (Sustained) > 40 mpg OR Wind (Gust) > 58 mph.

Concise description and timeline of planned changes to the calculation procedure over the triennial WMP cycle, including any key improvements from the Energy Safety Wildfire Risk Modeling Working Group and plans to align with the consensus Risk Modeling Requirements by January 1, 2024.

In addition to the improvements listed in Section 6.7, SCE will review feedback from the Wildfire Risk Modeling Working group and other stakeholder forums to assess key improvements or changes.

IRC5: PSPS Consequence

Figure SCE B-19 - SCE's PSPS Consequence Bow Tie Schematic

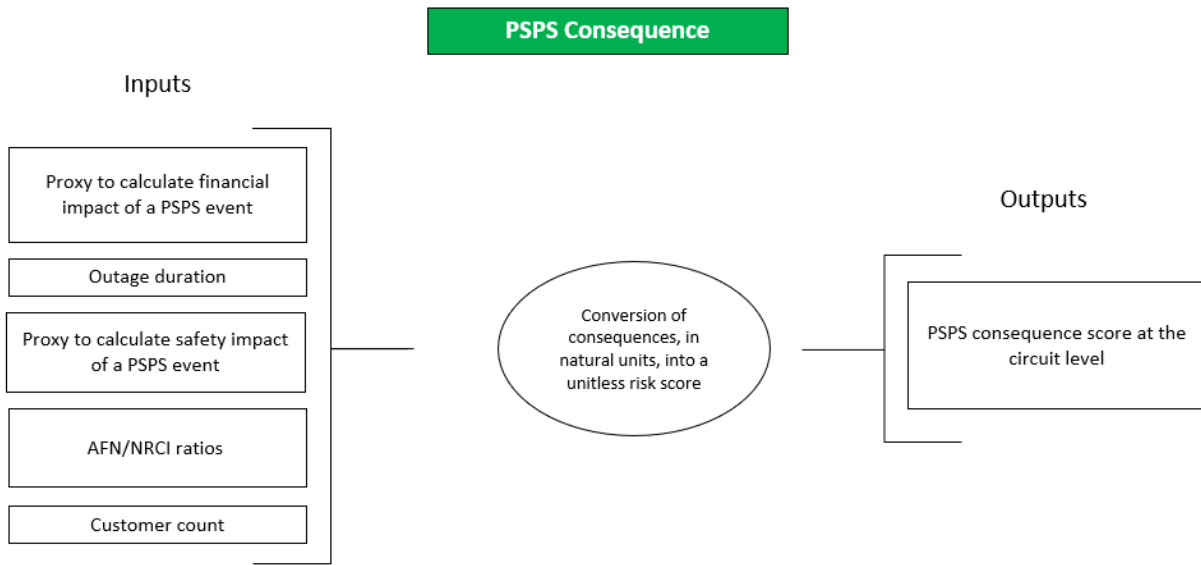
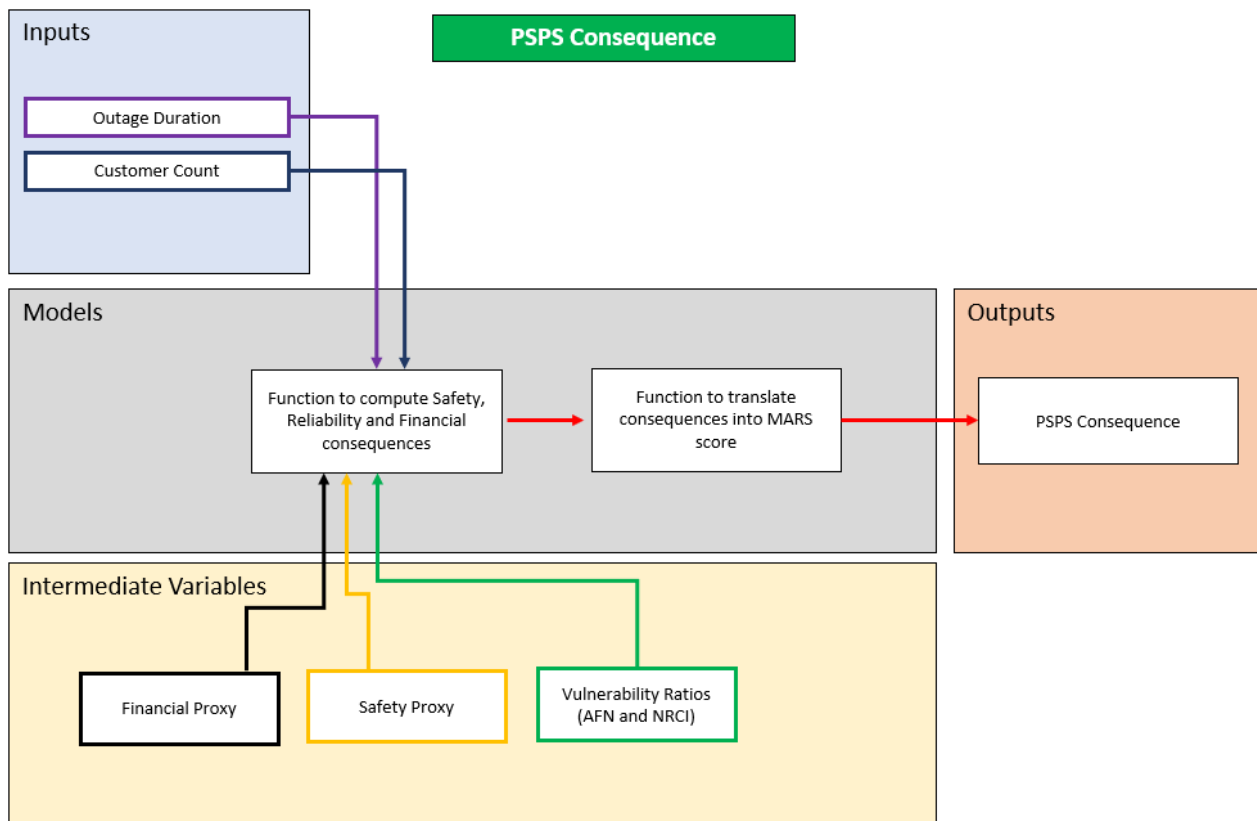

Figure SCE B-20 - SCE's PSPS Consequence Calculation Procedure Schematic



Purpose of the calculation/model

PSPS Consequences (IRC5) calculates the consequence components (Safety, Reliability, and Financial) from a PSPS event and then translates it into a MARS score.

Assumptions and limitations

This component assumes an 8-hour outage duration, which was chosen to be consistent with the duration of the wildfire simulation. In addition, SCE developed proxies to convert customers' outage duration into financial and safety consequences. Limitations can include using a singular proxy value for safety and especially financial consequences, acknowledging that there can be a broad range of outcomes.

Description of the calculation procedure shown in the bow tie and high-level schematics

SCE takes two inputs, number of customers and outage duration, in combination with the financial and safety proxies to compute safety, reliability and financial consequences as described in Section 6.2.2. A PSPS vulnerability multiplier is applied to the safety component to factor in access and functional needs customers. The last step is to translate the consequences, in natural units of measurement, to a unitless MARS risk score using the MAVF framework.

Description of how outputs will be characterized and presented (e.g., visualization) to decision makers

The consequence components of safety, reliability and financial can be presented individually or in aggregate at the circuit level.

Concise description and timeline of planned changes to the calculation procedure over the triennial WMP cycle, including any key improvements from the Energy Safety Wildfire Risk Modeling Working Group and plans to align with the consensus Risk Modeling Requirements by January 1, 2024.

In addition to the improvements listed in Section 6.7, SCE will review feedback from the Wildfire Risk Modeling Working group and other stakeholder forums to assess key improvements or changes.

FRC7: Wildfire Vulnerability

Figure SCE B-21 - SCE's Wildfire Vulnerability Bow Tie Schematic

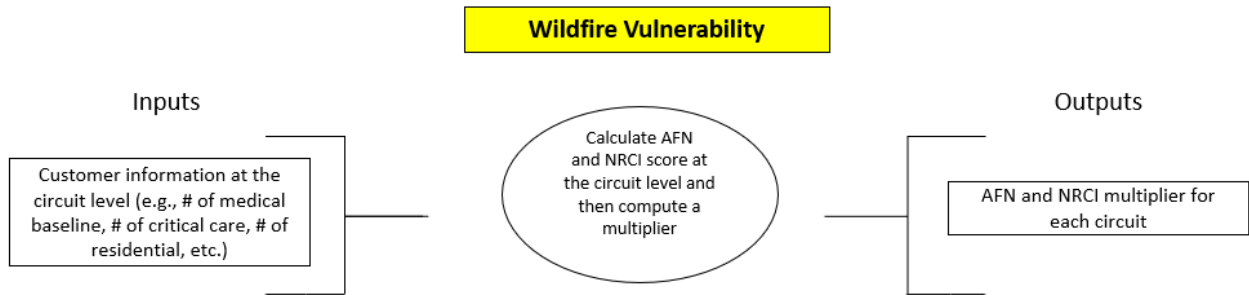
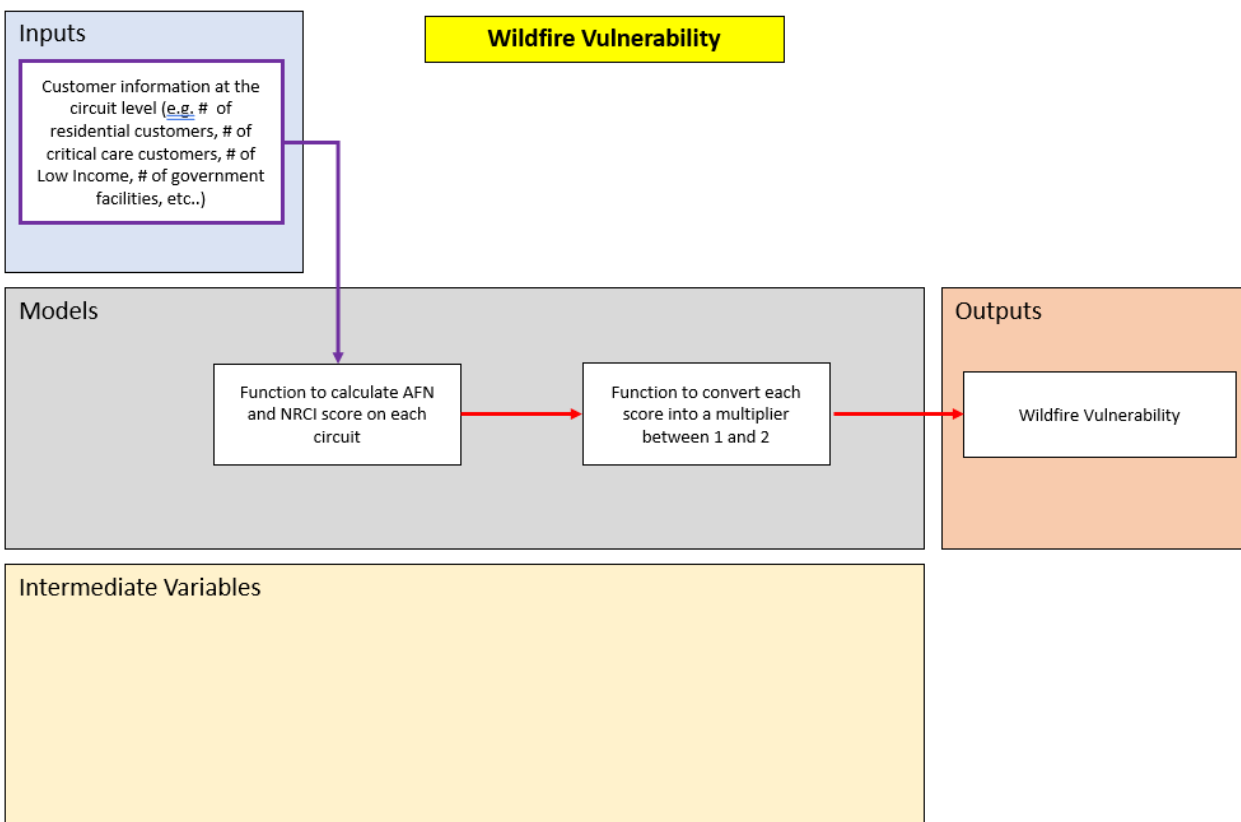

Figure SCE B-22 - SCE's Wildfire Vulnerability Calculation Procedure Schematic



Purpose of the calculation/model

Wildfire Vulnerability (FRC7) calculates the AFN/NRCI multiplier to be used as an amplifier to the Wildfire Safety consequence.

Assumptions and limitations

SCE assumes certain weightings for AFN characteristics (# of critical care, # of medical baseline, etc.) in its formulation of a composite score at the circuit level. Limitations may include availability to the latest data or data lag.

Description of the calculation procedure shown in the bow tie and high-level schematics

The methodology to calculate the multiplier is described in Section 6.2.2.2. SCE takes the composite score on each circuit and develops a multiplier for each circuit based on the calculation below:

$$AFN_{CircuitMultiplier} = 1 + \frac{AFN_{Score_circuit}}{AFN_{Score_MAX}}$$

A similar framework is used to develop the NRCI multiplier.

Description of how outputs will be characterized and presented (e.g., visualization) to decision makers

The output is a multiplier that is used to amplify the Wildfire Safety Consequences. It is not viewed directly by decision makers because it is an intermediate calculation.

Concise description and timeline of planned changes to the calculation procedure over the triennial WMP cycle, including any key improvements from the Energy Safety Wildfire Risk Modeling Working Group and plans to align with the consensus Risk Modeling Requirements by January 1, 2024.

In addition to the improvements listed in Section 6.7 , SCE will review feedback from the Wildfire Risk Modeling Working group and other stakeholder forums to assess key improvements or changes.

FRC8: PSPS Exposure Potential

Please see Section 6.2.1 for SCE's approach to this risk component.

FRC9: PSPS Vulnerability

Figure SCE B-23 - SCE's PSPS Vulnerability Bow Tie Schematic

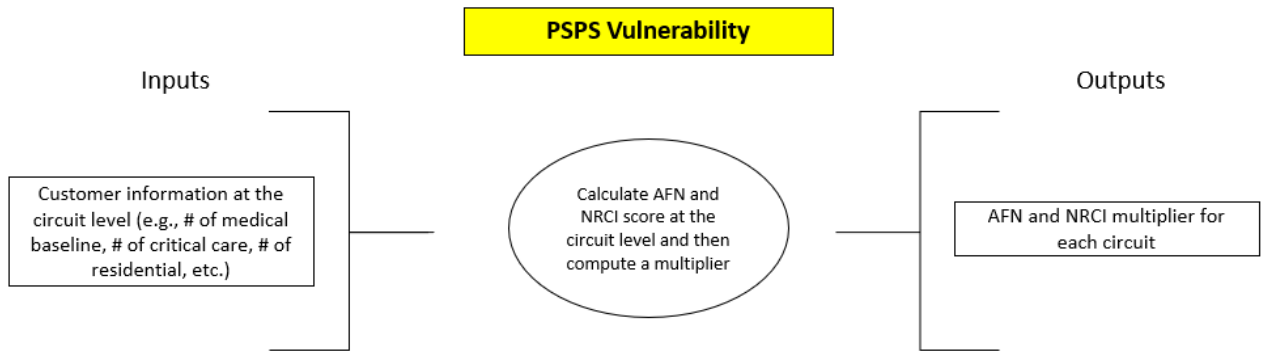
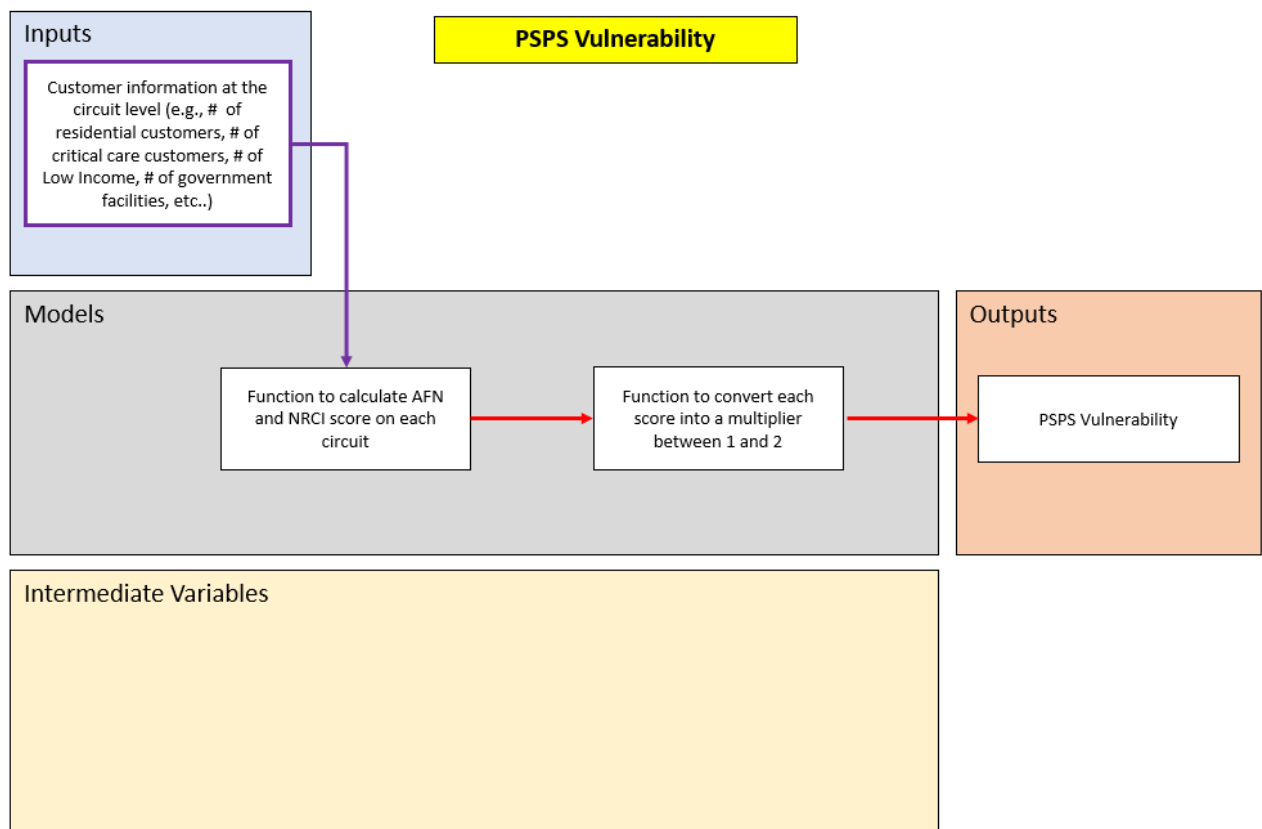

Figure SCE B-24 - SCE's PPS Vulnerability Calculation Procedure Schematic



Purpose of the calculation/model

PSPS Vulnerability (FRC9) calculates the AFN/NRCI multiplier to be used as an amplifier to the PSPS Safety consequence.

Assumptions and limitations

SCE assumes certain weightings for AFN characteristics (# of critical care, # of medical baseline, etc.) in its formulation of a composite score at the circuit level. Limitations may include availability to the latest data or data lag.

Description of the calculation procedure shown in the bow tie and high-level schematics

The methodology to calculate the multiplier is described in Section 6.2.2.2. SCE takes the composite score on each circuit and develops a multiplier for each circuit based on the calculation below:

$$AFN_{CircuitMultiplier} = 1 + \frac{AFN_{Score_circuit}}{AFN_{Score_MAX}}$$

A similar framework is used to develop the NRCI multiplier.

Description of how outputs will be characterized and presented (e.g., visualization) to decision makers

The output is a multiplier that is used to amplify the PSPS Safety Consequences. It is not viewed directly by decision makers because it is an intermediate calculation.

Concise description and timeline of planned changes to the calculation procedure over the triennial WMP cycle, including any key improvements from the Energy Safety Wildfire Risk Modeling Working Group and plans to align with the consensus Risk Modeling Requirements by January 1, 2024.

In addition to the improvements listed in Section 6.7, SCE will review feedback from the Wildfire Risk Modeling Working group and other stakeholder forums to assess key improvements or changes.

APPENDIX C: ADDITIONAL MAPS

In this appendix, the electrical corporation must provide the additional maps required by the Guidelines. As stated in the General Directions, if any additional maps needed for clarity (e.g., the scale is insufficiently large to show useful detail), the electrical corporation must either provide those additional maps in this appendix or host applicable geospatial layers on a publicly accessible web viewer. If the electrical corporation chooses the latter option, it must refer to the specific web address in appropriate places throughout its WMP. Additionally, the electrical corporation must host these layers until the submission of its 2026-2028 WMP or until otherwise directed by Energy Safety. The electrical corporation may not modify these publicly available layers without cause or without notifying Energy Safety.

SCE provides additional maps for the following Section in the pages that follow.

Section	Section Title
5.1	Catastrophic Wildfire History

SCE provides spatial data in the zip file “WMP_2023_GIS_Layers.zip”, which can be found at <https://www.sce.com/safety/wild-fire-mitigation>, for the following Section(s):

Section	Section Title	File Name
5.1	Service Territory	WMP_2023_5_1_Customer_Density
0	Individuals at Risk from Wildfire	WMP_2023_5_4_3_1_AFN_Customer_Density
5.4.4	Critical Facilities and Infrastructure at Risk from Wildfire	WMP_2023_5_4_4_Critical_Facilities_Density
6.4.1.1	Geospatial Maps of Top-Risk Areas within the HFRA	WMP_2023_6_4_4_1_Wildfire_Risk_Ranking_CONFIDENTIAL
9.1.2	Identification of Frequently De-energized Circuits	WMP_2023_9_1_2_PSPS_Frequently_DeEnergized_Circuits

SCE provides confidential spatial data in the zip file “WMP_2023_GIS_Layers_Confidential.zip” for the following Section(s):

Section	Section Title	File Name
6.4.1.1	Geospatial Maps of Top-Risk Areas within the HFRA	WMP_2023_6_4_4_1_Wildfire_Risk_Ranking_CONFIDENTIAL

5.3.2 Catastrophic Wildfire History

In addition to the catastrophic wildfires map provided in Section 5.3.2, SCE provides 12 maps reflecting individual catastrophic wildfire below. The source data for the 12 maps are from data CAL Fire and Resource Assessment Program (FRAP) GIS Database (<https://frap.fire.ca.gov/mapping/gis-data/>)

Figure SCE C-01 - Catastrophic Wildfire History Map (Ranch Fire)

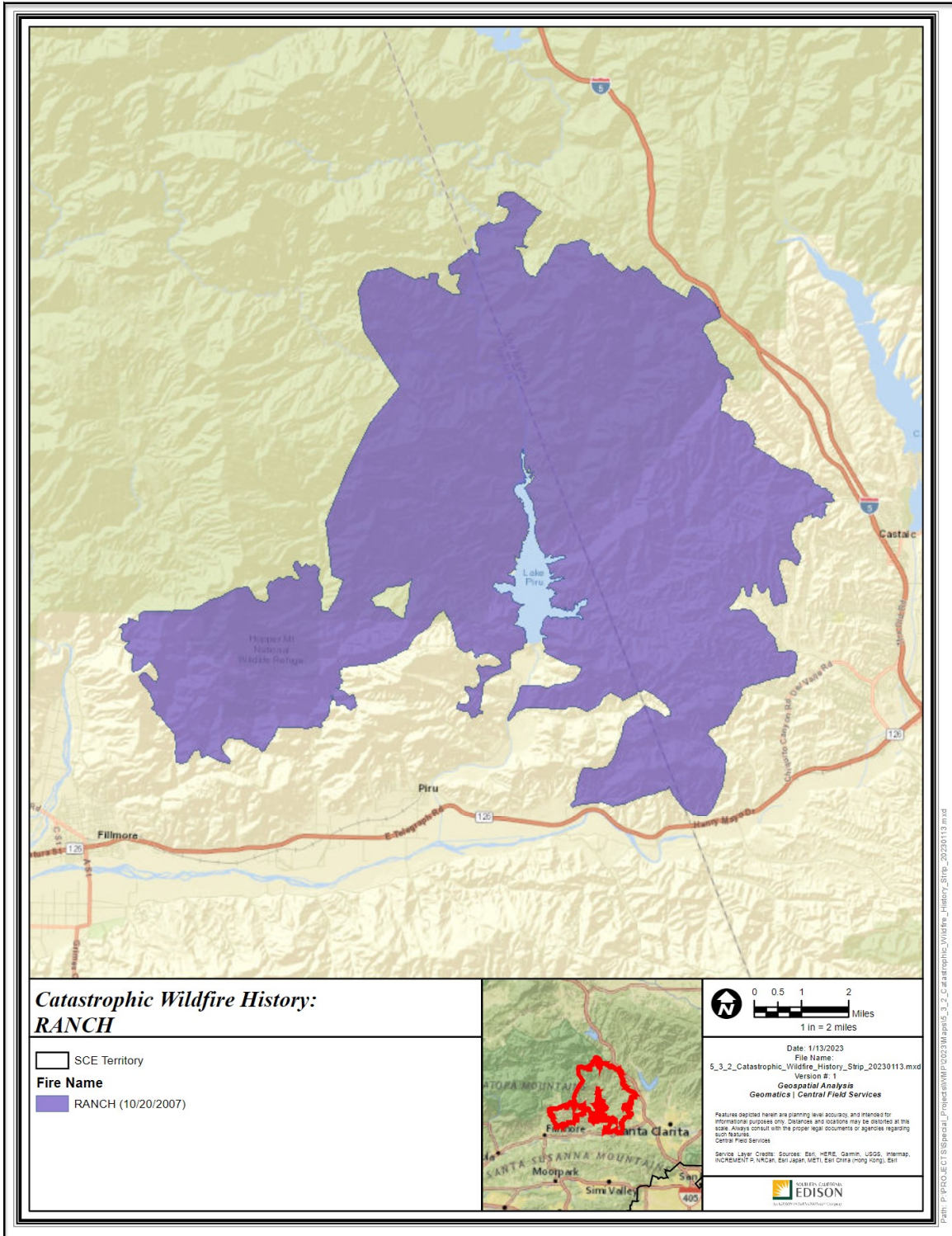

Figure SCE C-02 - Catastrophic Wildfire History Map (Sayre Fire)

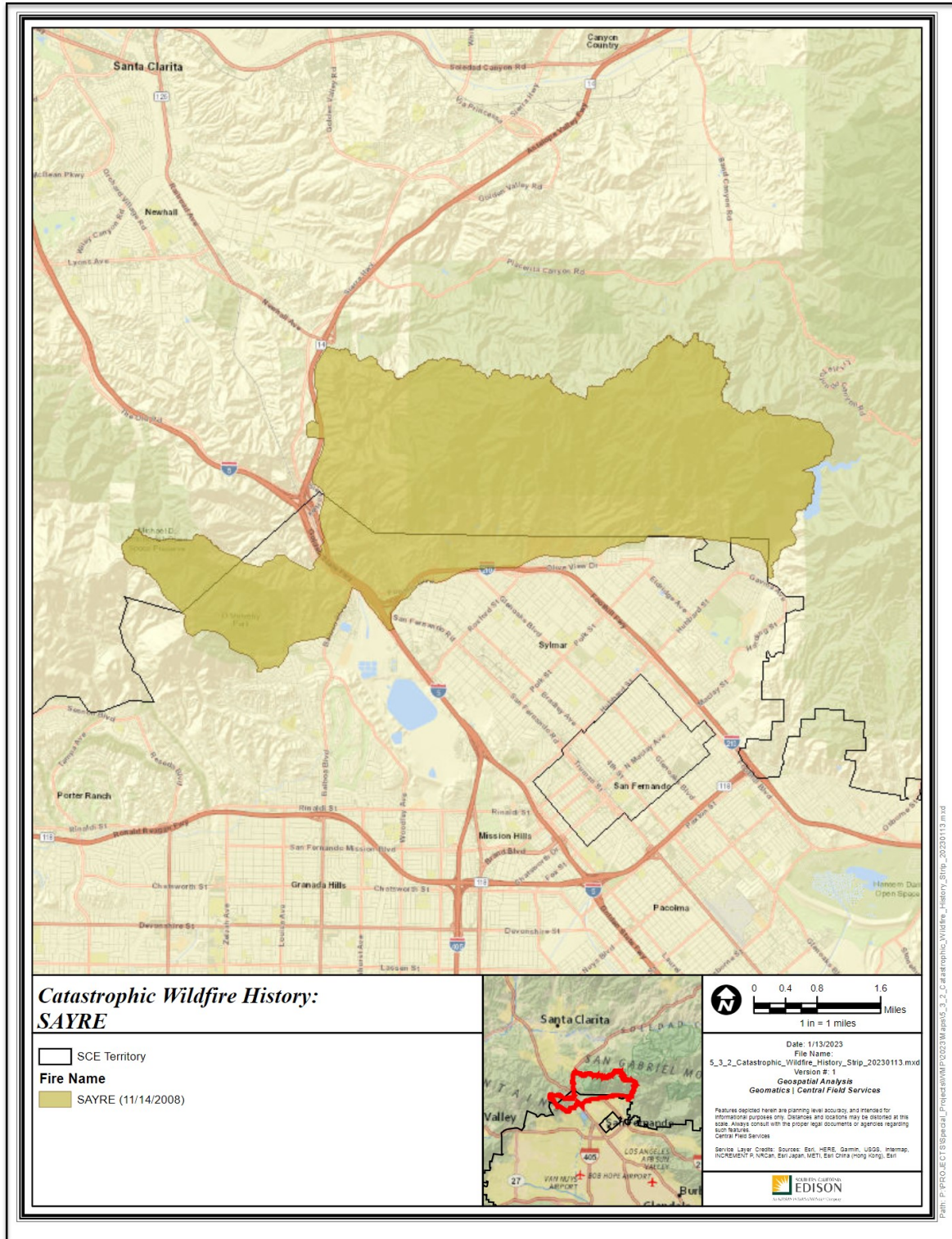

Figure SCE C-03 - Catastrophic Wildfire History Map (Round Fire)

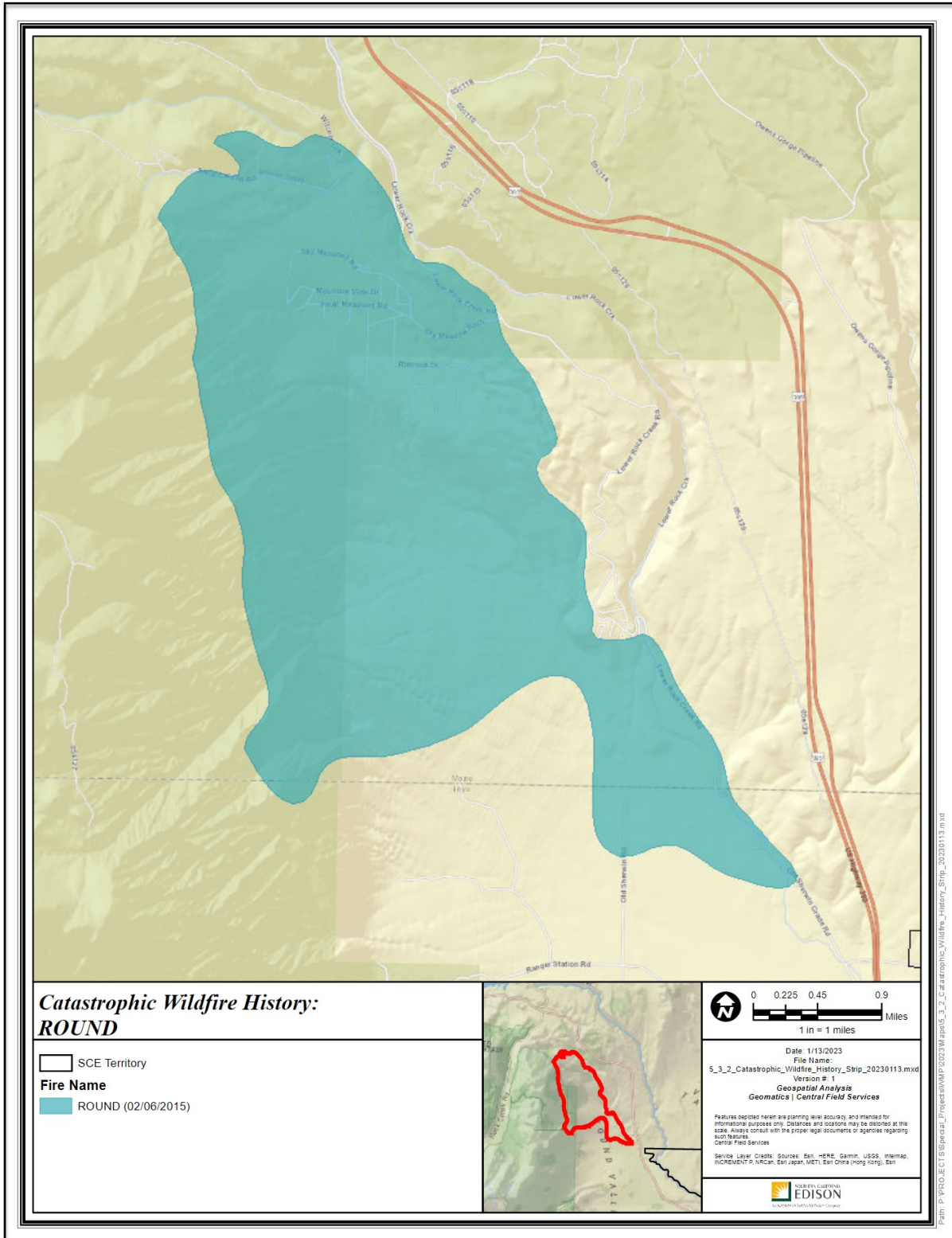

Figure SCE C-04 - Catastrophic Wildfire History Map (Rey Fire)

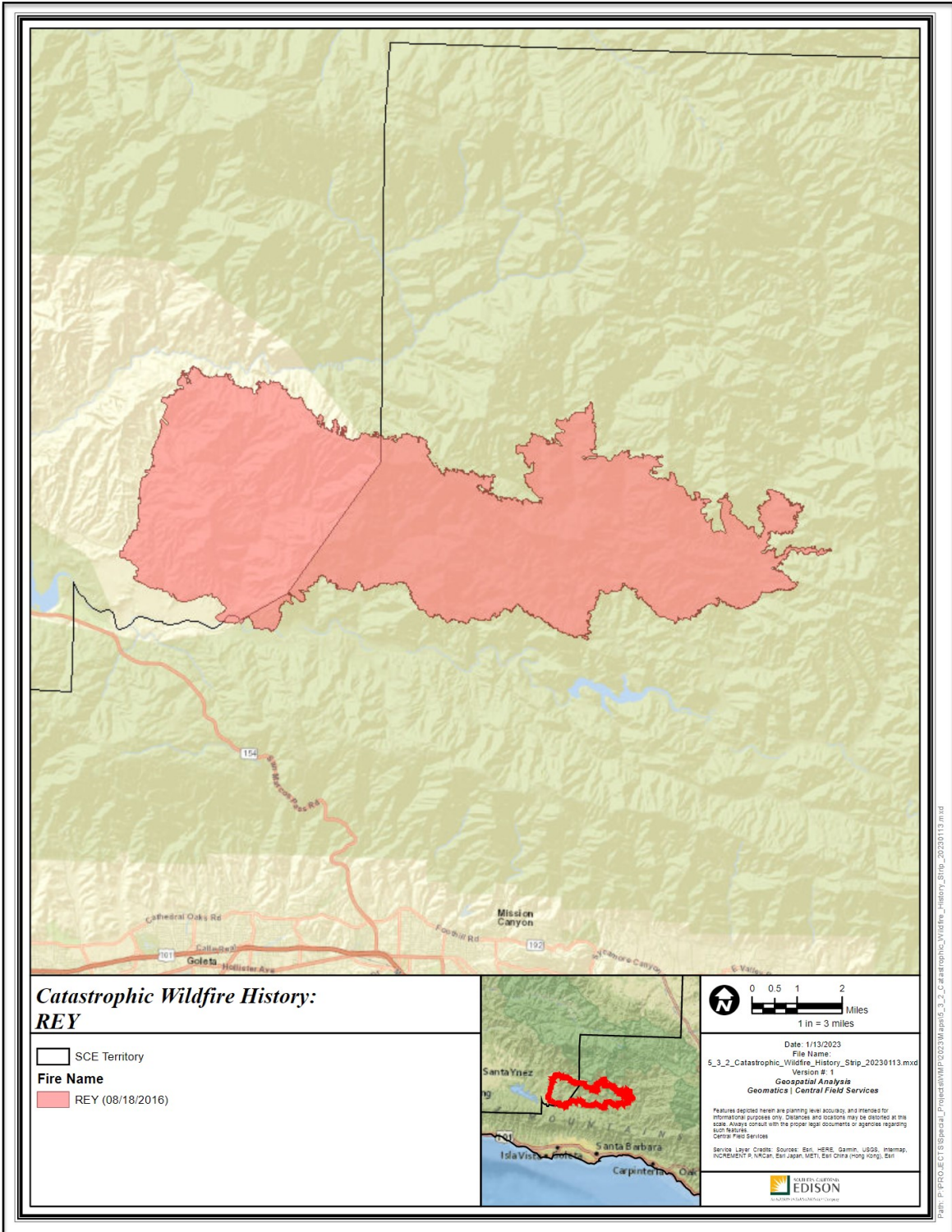

Figure SCE C-05 - Catastrophic Wildfire History Map (Thomas/Koenigstein Fire)

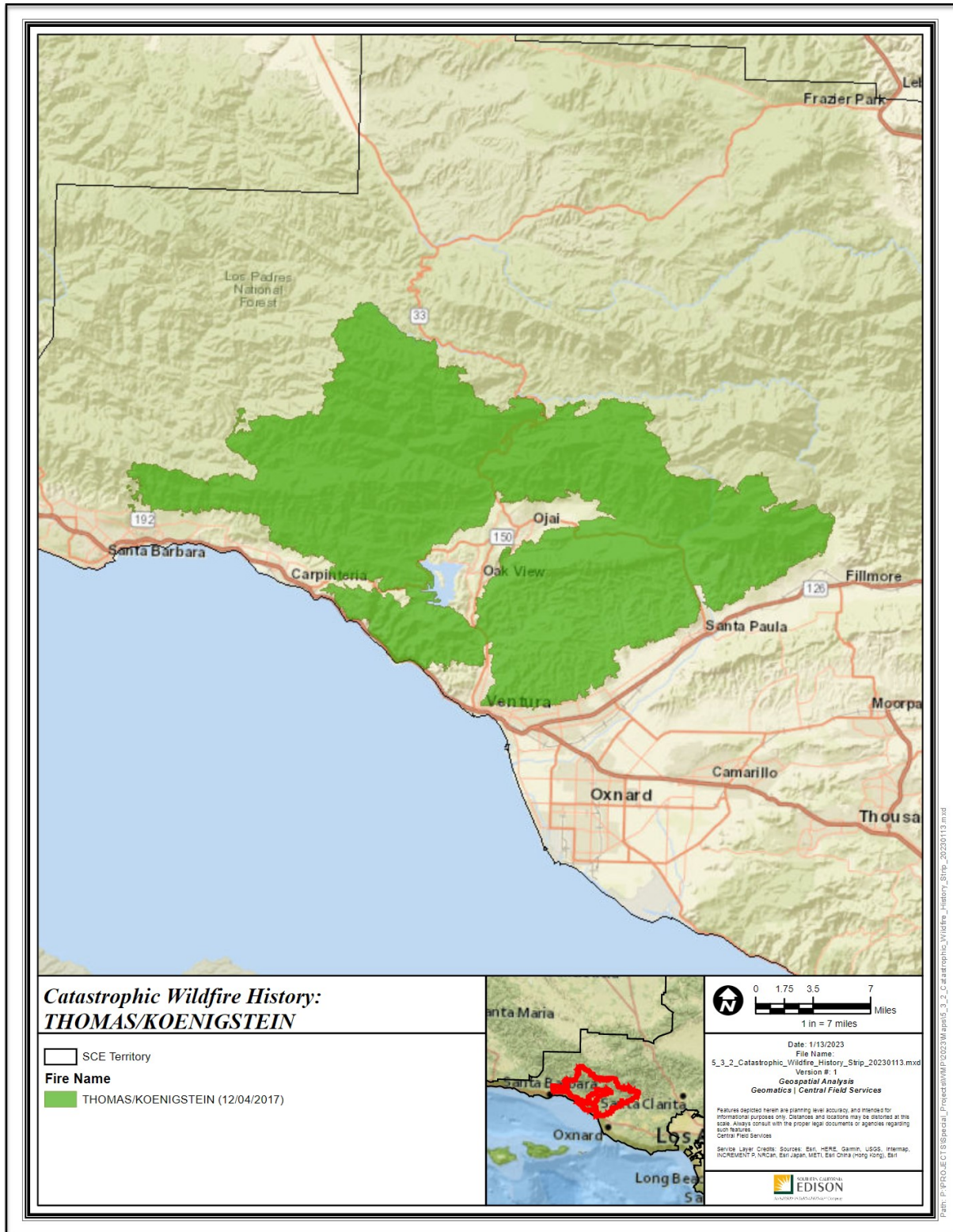

Figure SCE C-06 - Catastrophic Wildfire History Map (Creek Fire)

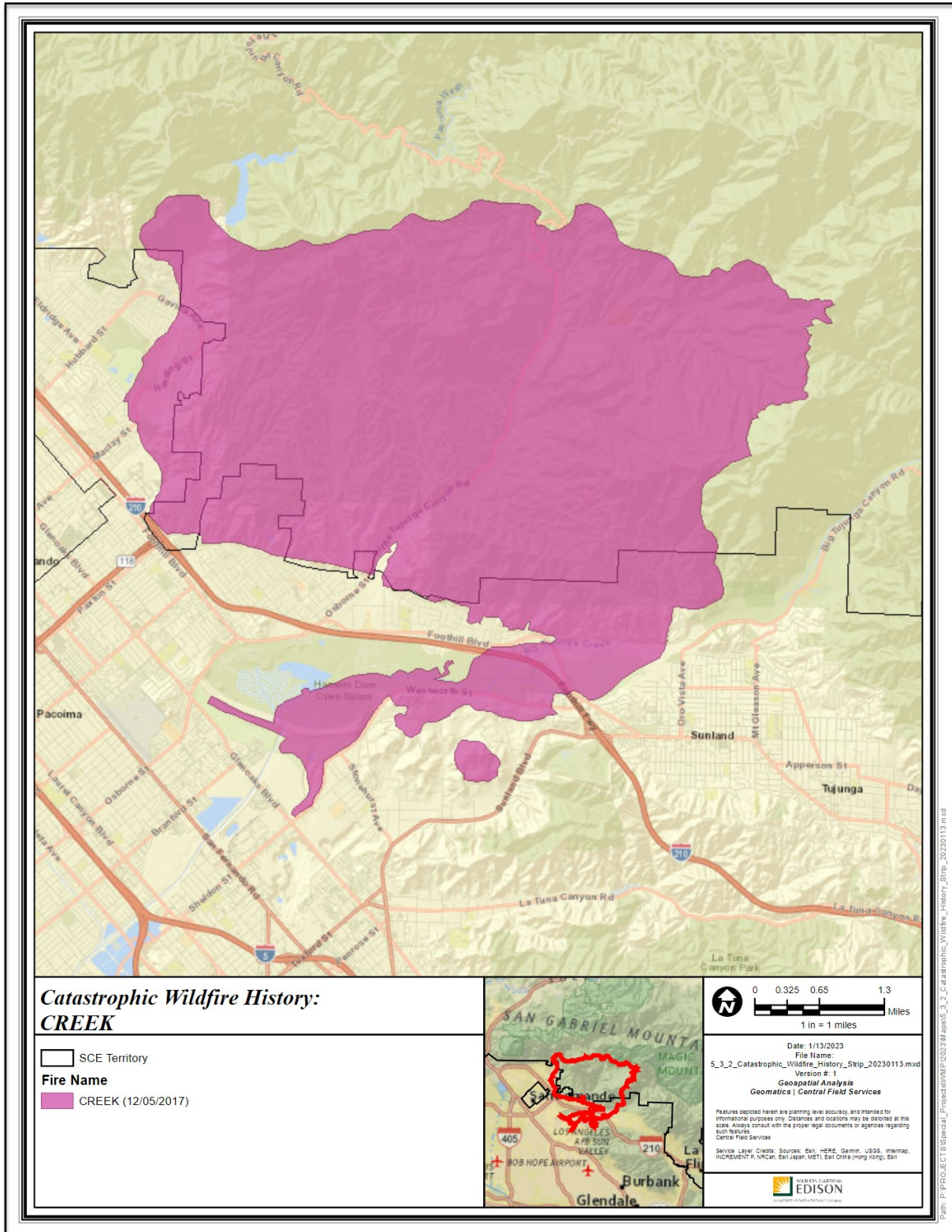

Figure SCE C-07 - Catastrophic Wildfire History Map (Rye Fire)

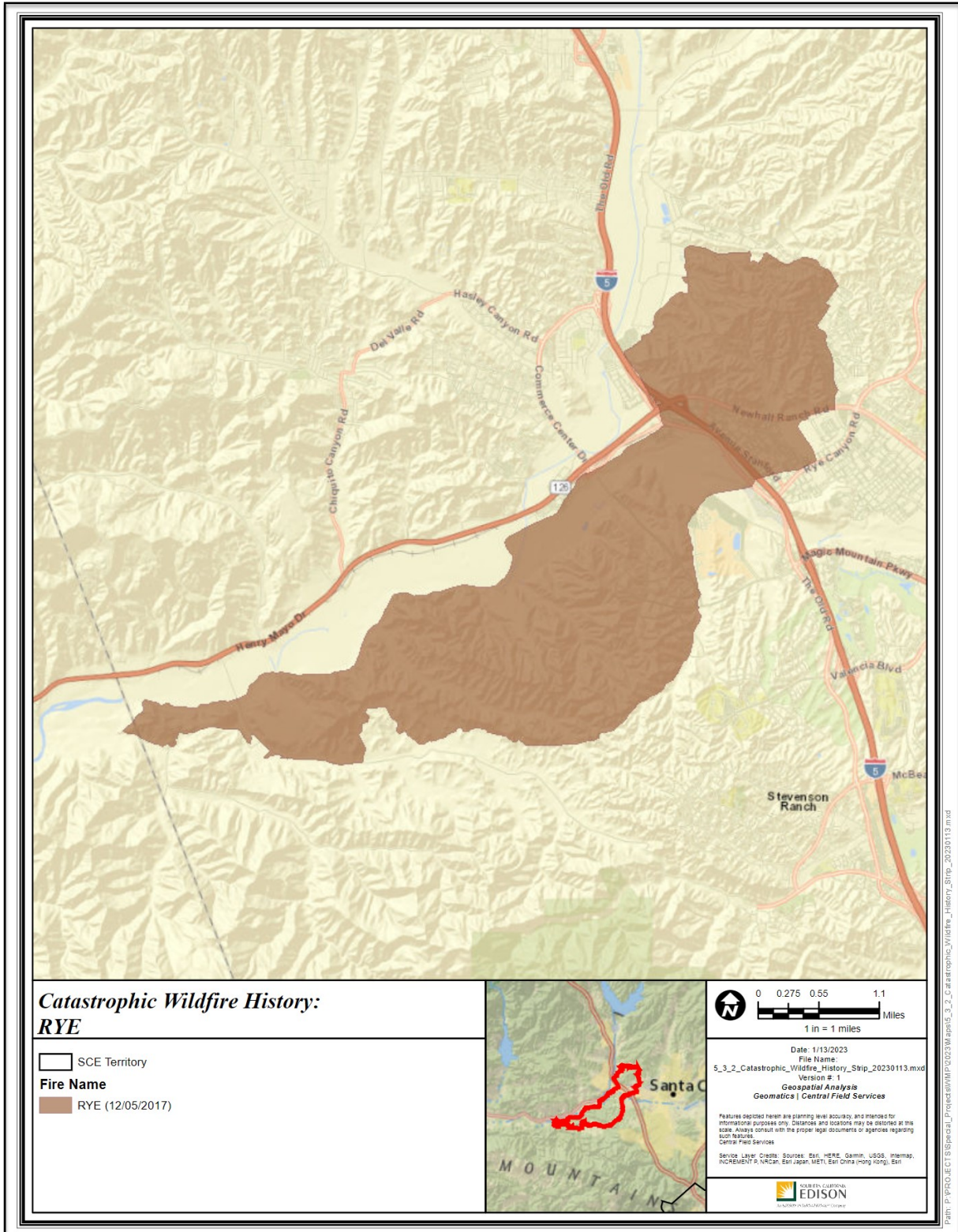

Figure SCE C-08 - Catastrophic Wildfire History Map (Woolsey Fire)

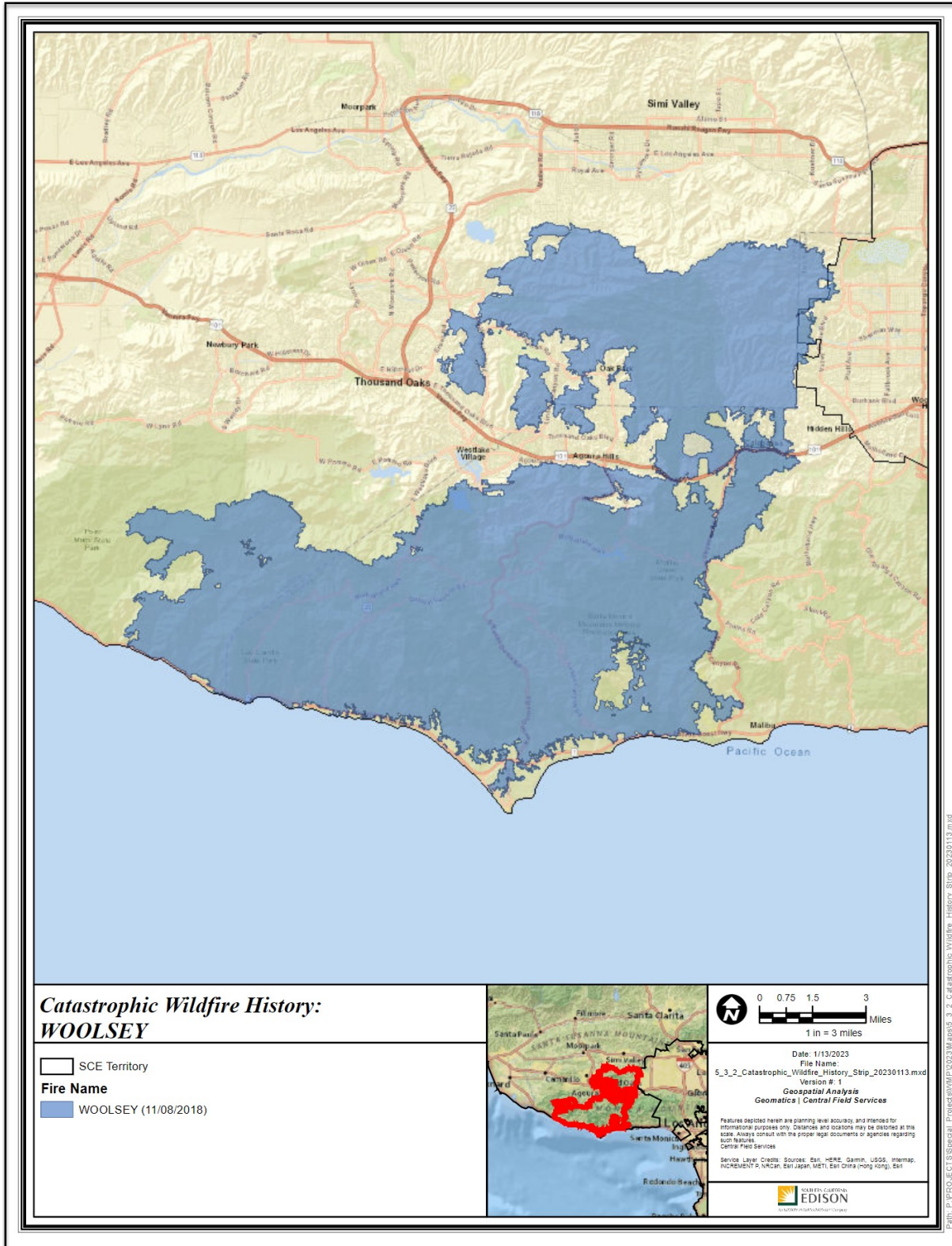

Figure SCE C-09 - Catastrophic Wildfire History Map (Saddle Ridge Fire)

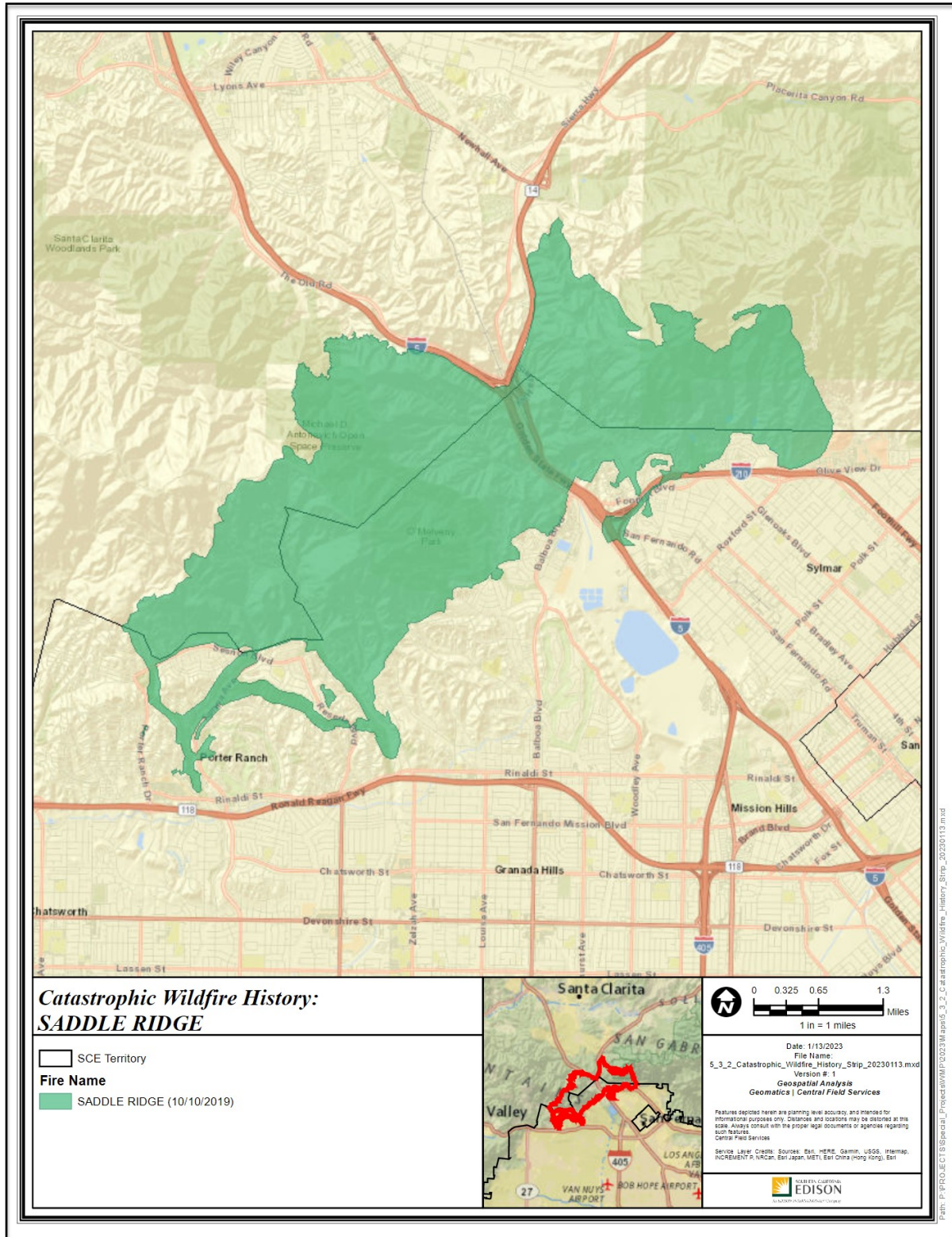

Figure SCE C-10 - Catastrophic Wildfire History Map (Bobcat Fire)

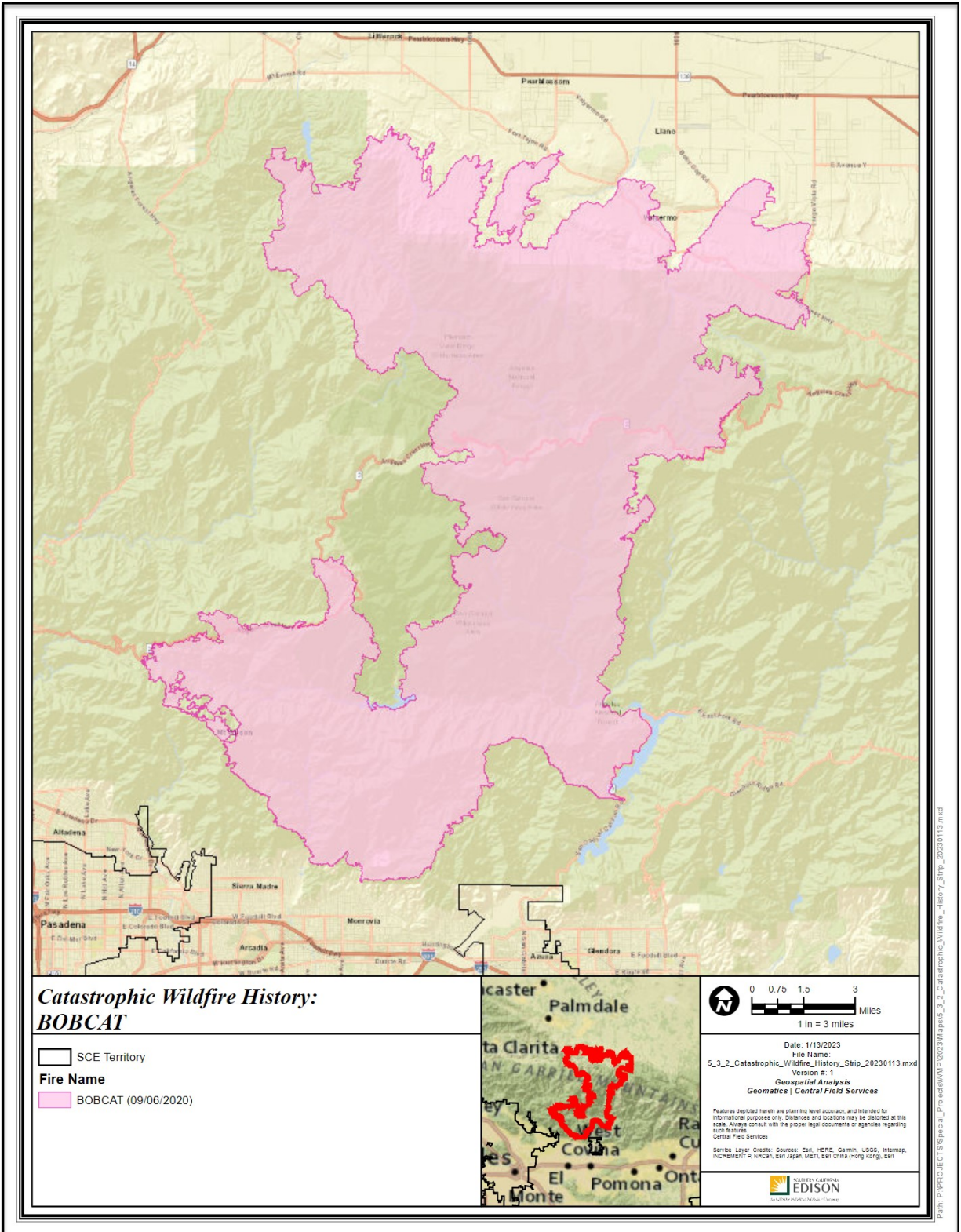

Figure SCE C-11 - Catastrophic Wildfire History Map (Silverado Fire)

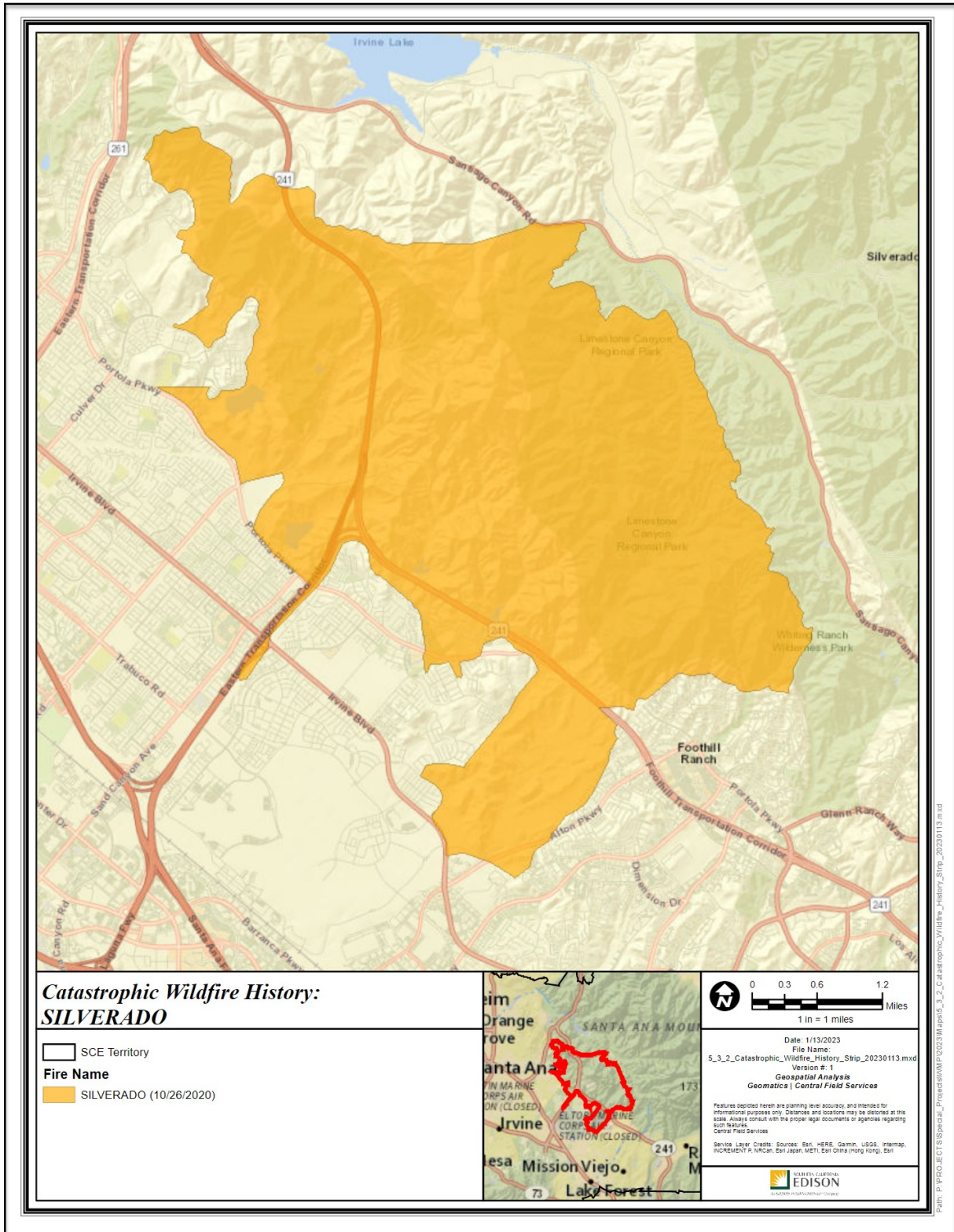
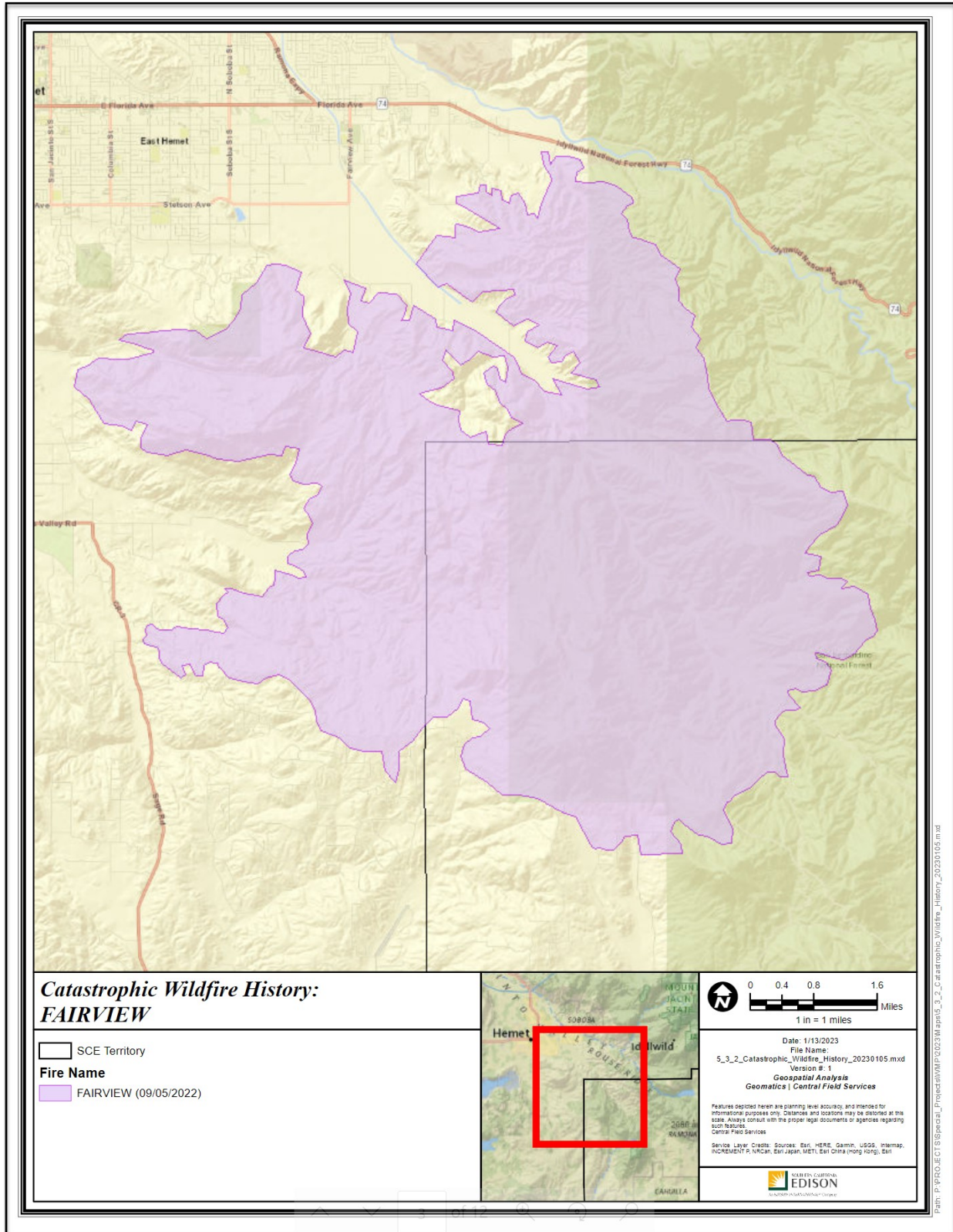

Figure SCE C-12 - Catastrophic Wildfire History Map (Fairview Fire)



APPENDIX D: AREAS FOR CONTINUED IMPROVEMENT

In this appendix, the electrical corporation must provide responses to its areas for continued improvement as identified in the Decisions on the 2022 WMP Updates in the following format: Code and Title; Description; Required Progress; [Electrical Corporation] Response.

SCE-22-01 Prioritized List of Wildfire Risks and Drivers

Description: *Currently, SCE's prioritized list of wildfire risks and drivers (Table 4-6) weights the risk drivers by average outage multiplied by ignition rate; it does not account for the likelihood of the ignition to cause a catastrophic wildfire.*

Required Progress: *In its 2023 WMP, SCE must further refine its prioritized list of wildfire risks and drivers. It must do so by weighting each risk driver by likelihood of causing a catastrophic wildfire (e.g., does this ignition tend to happen in high wildfire risk areas identified by SCE's risk models, including the HFTD).*

SCE's Response

As described in Section 6 and Appendix B, SCE's Probability of Ignition (POI) model uses advanced predictive analytics and machine learning techniques to model and forecast potential ignitions at thousands of unique utility asset locations. This model includes asset-specific failure modes and predicts ignition probabilities using three-years historical data.

The potential for ignitions to develop into a catastrophic wildfire is primarily determined by local conditions at the point of ignition, such as vegetation, moisture, topography, and wind. SCE's Wildfire Consequence model uses this data, along with an extensive data set of 444 historical weather days, to model how an ignition might progress given a unique assumed starting point.

SCE is not able to control external environmental factors, such as moisture, topography, wind, and suppression response, which drive fire propagation and development into catastrophic wildfire. SCE also cannot control the deployment, timing, and scale of fire suppression, which also factors into the growth of fires. However, SCE can influence the potential of ignitions started from SCE lines and equipment by performing grid hardening, such as covered conductor and targeted undergrounding, to reduce the likelihood of sparks and ignitions associated with SCE's infrastructure.

SCE notes that its POI model uses both historical ignition and asset failure information, along with machine learning. First, the machine learning models build probability of failure (POF) models for various drivers that may lead to equipment failures and subsequently lead to ignitions. Next a calibration of the POF to POI based on how often an asset failure may transition into an ignition.

SCE's approach considers unique, asset-specific failure modes, the potential for those failures to develop into ignitions, and then a highly localized fire spread model. For those reasons, SCE believes that its ignition and wildfire consequence modeling appropriately accounts for the potential for ignitions to develop into catastrophic wires.

SCE-22-02 Collaboration and Research in Best Practices in Relation to Climate Change Impacts and Wildfire Risk & Consequence Modeling

Description: *SCE and the other large IOUs are currently pursuing their own efforts at integrating the potential impacts of climate change in their risk and consequence modeling. They are not actively collaborating with each other on these efforts nor taking advantage of the existing climate change modeling expertise of state agencies and academic institutions.*

Required Progress: *Prior to the submission of their 2023 WMPs, all electrical corporations (not including independent transmission operators) must participate in an Energy Safety-led scoping meeting to discuss how utilities can best learn from each other, external agencies, and outside experts. In addition, the climate change and risk modeling scoping meeting will identify future topics to explore regarding climate change modeling and impacts relating to wildfire risk. This scoping meeting may result in additional meetings or workshops or the formation a working group. Energy Safety will provide additional details on the specifics of this scoping meeting in due course.*

SCE's Response

As of this writing, SCE has engaged and participated in all Energy Safety workshops and activities related to this topic, including the Risk Model Working Group (RMWG).

SCE-22-03 Three-Year Objectives and Supporting Programs' Performance Targets

Description: *SCE's 2022 Update did not include any quantitative targets for WMP mitigation measures that would contribute to reaching its stated three-- year objectives.*

Required Progress: *SCE must include the near-term and three-year objectives related program performance targets, whether quantitative or qualitative, into Table 5.3-1 (or its successor in the 2023 Guidelines). This integration must include program performance targets through the end of 2025.*

SCE's Response:

SCE has provided all tables related to this ACI in its 2023-2025 WMP:

- WMP Plan Objective (Section 4.2)
- and 10 year objectives (see Sections 8 and 9)
- Program Targets (see Sections 8 and 9)

SCE-22-04 Inclusion of Community Vulnerability in Consequence Modeling

Description: *SCE does not adequately include the impacts of wildfire on communities, including considerations of community vulnerability, within consequence modeling.*

Required Progress: *Prior to the submission of their 2023 WMPs, all electrical corporations (not including independent transmission operators) must participate in an Energy Safety-led scoping meeting to discuss how to best learn from each other, external agencies and outside experts. In addition, the community vulnerability scoping meeting will identify future topics to explore regarding integration of community vulnerability into consequence modeling and impacts relating to wildfire risk. This scoping meeting may result in an additional meetings or workshops or the formation of a working group. Energy Safety will provide additional details on the specifics of this scoping meeting in due course.*

SCE's Response

SCE is awaiting details on the scoping meeting from Energy Safety and will engage when those details have been released.

Please also see the response to ACI SCE-22-02 regarding SCE's participation in Risk Model RMWG meetings.

Finally, please see Section 6.2.1 and 6.2.2, which describes how SCE models the risk components of Wildfire Vulnerability and PSPS Vulnerability.

SCE-22-05 Fire Suppression Considerations

Description: *SCE's fire spread modeling does not currently factor in fire suppression effects (e.g., fire department efforts).*

Required Progress: *Prior to the submission of its 2023 WMP, SCE must work with other utilities to evaluate how to best account for, quantify, and model suppression effects on wildfire spread. Further guidance will be determined and covered during the risk model working group meetings established by Energy Safety's 2021 WMP Action Statements, including participation from CAL FIRE.*

SCE's Response

As noted in the response to SCE-22-03, SCE continues to actively participate in the Risk Model Working Group (RMWG), which SCE understands will address this topic.

SCE-22-06 Ignition Risk Reduction

Description: From 2020 to 2021, SCE reported an increase in total ignition rates, particularly from wire-to-wire contacts.

Required Progress: In SCE's 2023 WMP, SCE must:

- Analyze root causes and trends for the increases in ignitions broken down by sub-driver, including wire-to-wire contacts.
- Provide SCE's plans to address increases in ignition rates broken down by risk drivers and sub-drivers, including efforts to address the root cause(s) outside of routine or program-level WMP initiatives.
- Describe and quantify how SCE anticipates covered conductor and undergrounding initiatives will impact expected ignitions due to conductor damage or failure.

Required Progress #1:

Analyze root causes and trends for the increases in ignitions broken down by sub-driver, including wire-to-wire contacts.

SCE's Response:

As part of its Fire Investigation Preliminary Analysis (FIPA) process, SCE engineers evaluate causes and risk drivers for ignition events within SCE's service territory. Since the launch of SCE's FIPA process, SCE has improved the process and the information collected. For more information on and improvements made to the FIPA process see Section 11.

The two charts below present SCE's current analysis of trends at the sub-driver level within SCE's HFRA. *Figure ACI-06-01* shows data for Equipment and Facility Failure (EFF), while *Figure ACI 06-02* presents data for Contact from Object (CFO) including wire-to-wire (W2W) as a sub-driver under this category.

SCE notes that year-to-year changes in ignitions may be due to external conditions that are independent from SCE's wildfire mitigation activities. As a hypothetical example, a relatively dry year may feature more ignitions because of fuel receptivity, and thus may not necessarily indicate inherent deficiencies in mitigation activities or other utility practices. SCE performs robust ignition analysis to better understand and improve its understanding of wildfire risk and mitigation development but notes that indicators such as acres burned, and structures are more appropriate for medium and longer-term evaluations.

Ignitions caused by switches saw a slight increase since 2021 in most part due to installation-related issues. To mitigate, SCE has been working on a more stringent process in order to assure all pieces of the switch mechanism are properly inspected prior to completing the installation. Switches have many components that are essential to operation, and these need additional scrutiny when assessing if the equipment is seated correctly and constructed properly. Additionally, SCE is in the process of incorporating lessons learned from the switch failures into its High Fire Risk Informed Inspection form to add more clarity to the inspectors on potential failure modes of switches.

Figure ACI-06-01 - Annual Ignition Counts by EFF Sub-Drivers (HFRA only), 2019-2022

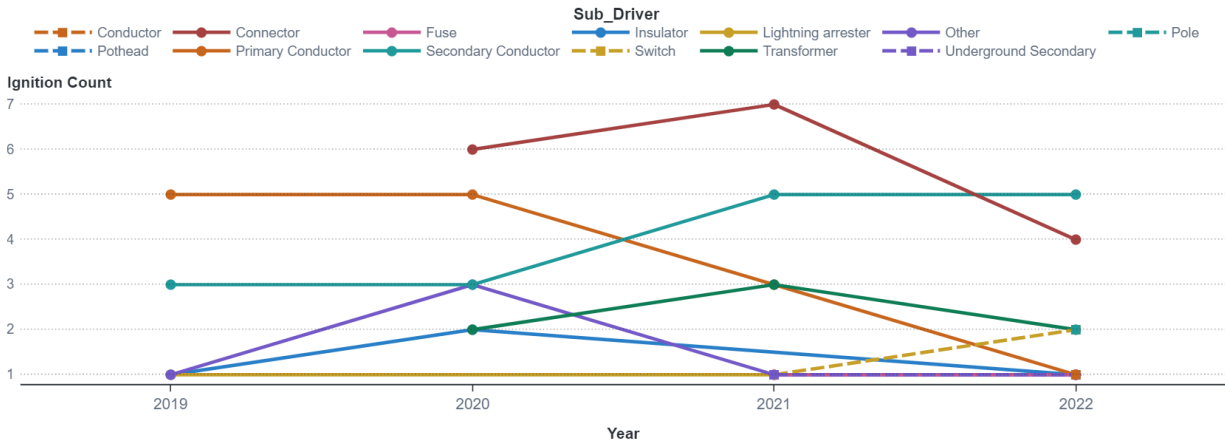

Regarding Figure ACI-06-022, for CFO caused ignitions, as noted above, ignitions may vary year over year for factors outside of SCE’s control. SCE notes that balloon, W2W, and animal caused ignitions have decreased since 2020, which appears to be primarily driven by SCE’s covered conductor program.

Figure ACI-06-02 - Annual Ignition Counts by CFO Sub-Drivers (HFRA only), 2019-2022

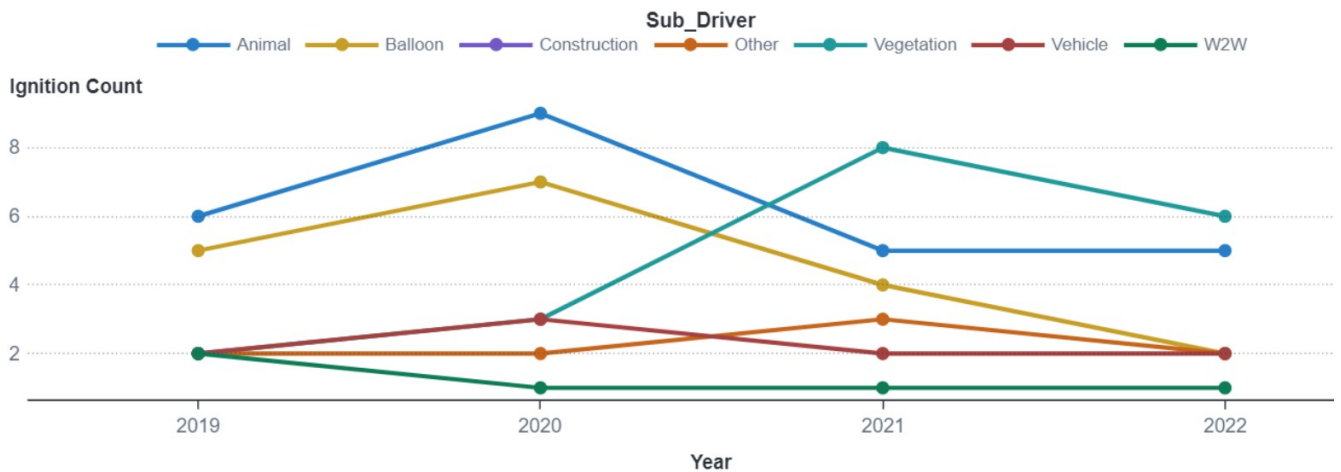

Required Progress #2:

Provide SCE’s plans to address increases in ignition rates broken down by risk drivers and sub-drivers, including efforts to address the root cause(s) outside of routine or program-level WMP initiatives.

SCE’s Response

Regarding wire-to-wire related ignitions, although there has not been an increase as shown above in Figure ACI-06-02, SCE has continued with the installation of covered conductor, as well as the long span initiative Please see section 8.1.2.5.2 for more information on the long span initiative.

Figure ACI-06-01 above shows that connector-related ignitions have had a small increase from six in 2020 to seven in 2021 followed by a decrease to three in 2022. SCE’s mitigation approaches towards reducing connector-related ignitions include: (1) covered conductor, which replaces existing connectors during the installation, (2) infrared scanning of overhead facilities, which identifies connectors with elevated temperatures for replacement, and (3) new technology evaluation of Early Fault Detection

(EFD), which identify degraded connections that produce radio frequency emissions, for replacement.

Transformer caused ignitions increased in 2022 when compared to 2021 and earlier. This is mainly due to the extended heat wave during the summer of 2022, which lasted for approximately two weeks and required transformers to maintain consistently high loading with minimal opportunities for cooling due to persistently high temperatures. SCE continues to evaluate this issue and potential mitigations.

The CFO sub-driver chart shown in Figure ACI-06-02 above demonstrates that vehicle-caused ignitions remain flat from year to year, with vegetation-related ignitions relatively stable when comparing 2022 to 2021. Balloon-related ignitions dropped from previous years, partly due to covered conductor installations.

SCE has seen an increasing trend of animal-related ignitions, which have been mainly driven by nesting birds. SCE is evaluating options to obtain expedited environmental clearances to address bird nesting issues and the deployment of nesting platforms which will move the bird nest to a location off the utility structure.

Required Progress #3:

Describe and quantify how SCE anticipates covered conductor and undergrounding initiatives will impact expected ignitions due to conductor damage or failure.

Response to SCE-22-06 Required Progress #3:

SCE performed an analysis of covered conductor installations from 2019 to 2022. This analysis indicates that covered conductor experiences approximately 70% fewer ignitions per mile relative to bare conductor. The methodology utilized for the analysis includes comparing ignition incidents per mile of bare conductor and covered conductor.

Furthermore, based on SME judgment, SCE estimates undergrounding is approximately 95% effective at mitigating ignition risk relative to bare conductor. Collectively, we expect covered conductor and underground initiatives to help reduce ignitions. Please also see Section 7.1.4, which describes SCE's mitigation selection process, including evaluations of mitigation effectiveness.

SCE-22-07 Wildfire Consequence Modeling Improvements

Description: *SCE does not use its wildfire consequence modeling as a tool to model potential ignitions in near real-time as faults/outages occur in the HFTD*

Required Progress: *In its 2023 WMP, SCE must discuss how it explored the use of its wildfire consequence modeling and/or developed processes to prioritize, and respond to the locations of faults/outages in the HFTD as they happen.*

SCE's Response

In 2022, SCE implemented a system in its Distribution Operations Centers to prioritize responding to hazards and outages in HFRA. As hazards and outages occur on SCE's system, an algorithm cross references meter data with its associated transformer to verify its location in HFRA. SCE's Distribution Operations Centers use this information to prioritize dispatching troublemen to hazards and outages in HFRA. Dispatchers also have HFTD tier information to further prioritize responses, if necessary.

SCE is considering the use of more granular consequence modeling and incorporating it into an automated system like HERMES. However, the cost-benefit of such a solution is unclear, given that SCE already prioritizes responding to hazards and outages in HFRA.

SCE-22-08 Weather Station Improvements

Description: *SCE weather station observation intervals are not reported as frequently as peer utilities.*

Required Progress: *SCE must improve its weather station observation intervals to collect weather data more frequently than six times per hour. In its 2023 WMP SCE must improve the frequency that data is collected from its weather station network to match that of its peers. If unable to increase the data collection from its weather station network to that of its peers, SCE must present a plan to develop that functionality in its 2023 WMP.*

SCE's Response

SCE can receive 30-second (effectively real time) reads on a portion of its weather station network, and piloted this functionality during PSPS events in 2022. Stations with this capability must have cellular communication modems (currently 866 stations out of 1,620 as of January 2023).

SCE anticipates adding approximately 85 stations with the ability to relay data via cellular communications and retrofit approximately 400 satellite-only stations into dual communication stations in 2023, pending cellular network availability at those sites, providing these stations with the capability to receive more frequent reads. Not every satellite station will be able to be converted to dual communications due to a lack of cellular reception. SCE will conduct an analysis at the end of 2023 to determine how many of the remaining stations can be converted.

When SCE tested the 30 second read functionality during PSPS activations in 2022, and within the scope of the weather stations utilized, it did not encounter major technical challenges with the ability of the weather stations to provide 30 second data.

In 2023, SCE plans on continuing to test more frequent reads during PSPS activations to test how the data can be used in varying event sizes. SCE will also assess whether the increased data reads can help SCE improve its decision-making regarding when to de-energize customers, improve its assessment of real time field conditions, and enhance re-energization timeline and process. SCE will also evaluate if its systems are able to process and analyze the increased data load.

In the interim, SCE plans to continue to read data at 10-minute intervals. The World Meteorological Organization recommends measuring the wind gust speed as a 3-second maximum during a 10-minute sampling period for accurate wind gust measurement

(<https://www.ncbi.nlm.nih.gov/pmc/articles/PMC5948875/>).

SCE-22-09 Joint Covered Conductor Lessons Learned

Description: SCE has yet to provide goals and timelines for implementing lessons learned from the covered conductor joint effectiveness study.

Required Progress: In its 2023 WMP, SCE must:

- Provide a concrete list of goals with planned dates of implementation for any lessons learned in the covered conductor effectiveness joint study.
- Provide a table indicating which WMP sections include changes (compared to its 2021 and 2022 Updates) as a result of the covered conductor effectiveness joint study. This should include, but not be limited to:
 - Changes made to covered conductor effectiveness calculations.
 - Changes made to initiative selection based on effectiveness and benchmarking across alternatives.
 - Inclusion of rapid earth fault current limiter (REFCL), open phase detection (OPD), early fault detection (EFD), and distribution fault anticipation (DFA) as alternatives, including for PSPS considerations.
 - Changes made to cost impacts and drivers.
 - An update on data sharing across utilities on measured effectiveness of covered conductor in-field and pilot results, including collective evaluation.

Required Progress #1

Provide a concrete list of goals with planned dates of implementation for any lessons learned in the covered conductor effectiveness joint study.

SCE's Response

SCE is leading the Joint IOU Covered Conductor Effectiveness Working Group and the utilities continue to make progress on the objectives. The utilities progress on these efforts is described in the Joint IOU Working Group Report in Appendix F. The utilities have set forth a plan for 2023 to conduct several workshops to assess covered conductor testing results, maintenance and inspection practices, new technologies, and other items. As discussed below, the primary lessons learned resulting from the study thus far has been the increase in effectiveness of covered conductor, which SCE has incorporated into its risk analysis for this WMP.

Please see Appendix F for the progress report on the Joint IOU Covered Conductor Effectiveness Group that addresses lessons learned.

Required Progress #2

Provide a table indicating which WMP sections include changes (compared to its 2021 and 2022 Updates) as a result of the covered conductor effectiveness joint study. This should include, but not be limited to:

- Changes made to covered conductor effectiveness calculations.
- Changes made to initiative selection based on effectiveness and benchmarking across alternatives.
- Inclusion of rapid earth fault current limiter (REFCL), open phase detection (OPD), early fault detection (EFD), and distribution fault anticipation (DFA) as alternatives, including for PSPS considerations.

- *Changes made to cost impacts and drivers.*
- *An update on data sharing across utilities on measured effectiveness of covered conductor in-field and pilot results, including collective evaluation.*

SCE's Response

As a result of the testing SCE conducted with Exponent in collaboration with PG&E and SDG&E, and in addition to more granular analysis, SCE made changes to its estimated effectiveness of covered conductor increasing it from approximately 67% to approximately 72%. As noted in the Joint IOU Covered Conductor Working Group Report, testing results will be further discussed in 2023 through meetings and workshops to determine any additional potential lessons learned. Additionally, and as part of the Joint IOU CC Working Group, SCE has provided its 2022 cost per mile for CC which has increased compared to its 2021 cost per mile. The utilities also continue to share data regarding recorded effectiveness and, in 2023, will further evaluate several covered conductor-related subject areas including M&I practices, new technologies, and a framework for calculating the effectiveness of the combination of mitigations.

Please see below for current status on items mentioned under “Required Progress” for ACI SCE-22-09.

Effectiveness Calculations

SCE reviewed mitigation effectiveness for all activities and where appropriate, updated the underlying analysis based on available data. In addition, SCE continued its shift toward data-driven inputs to inform mitigation effectiveness. Additionally, the independent 3rd party study led by Exponent demonstrated an increase in mitigation effectiveness at the contact from object – vegetation contact and vehicle contact driver level. This additional data input increased the overall effectiveness of CC. Please see Table SCE 7-12 and Appendix F: Supplemental Information for further details.

Initiative Selection

SCE has not materially changed its approach to prioritization and selection of covered conductor as a wildfire mitigation. The Exponent study on the effectiveness of covered conductor validated our understanding of the mitigation effectiveness for covered conductor, which served to further validate covered conductor as a selected initiative in our mitigation portfolio. Please see Section Mitigation Selection Process and Section 8.1.2.1 for further details. As part of the joint study, SCE will continue to evaluate the physical and performance characteristics of covered conductor.

REFCL, OPD, EFD, and DFA as CC alternatives (including for PSPS considerations)

SCE does not consider OPD (either for distribution or transmission), EFD, or DFA as alternatives to covered conductor or as a basis to increase PSPS wind speed thresholds. However, these mitigations can be understood as complementary to covered conductor and part of SCE's overall mitigation portfolio and selection strategy.

As discussed in Section 7.1.4 in some cases, a combination of REFCL and covered conductor may be viable as an alternative to undergrounding. However, REFCL mitigation effectiveness needs to be field validated over the coming years, and at this point in time SCE does not see REFCL as an alternative to covered conductor or as a basis for increased PSPS wind speed thresholds.

Cost Impacts and Drivers

In Table 11 of SCE's Wildfire Mitigation Data Tables, SCE includes an updated cost forecast for its Wildfire Covered Conductor Program over the 2023 – 2025 WMP period. This cost forecast is based on the volume of miles SCE anticipates installing over the WMP period and the estimated cost per mile to perform the work. While the Joint Covered Conductor Effectiveness Working Group did not directly drive the unit cost used by SCE to develop SCE's WCCP forecast, the discussions pertaining to covered conductor costs across utilities were informative and provided insights into the various costs associated with covered conductor across utilities.

SCE-22-10 Covered Conductor Inspection and Maintenance

Description: *SCE must evaluate and update its covered conductor inspection and maintenance program.*

Required Progress: *All electrical corporations (not including independent transmission operators) must work to share and determine best practices for inspecting and maintaining covered conductor, including either augmenting existing practices or developing new programs. This should be considered as a continuation of the covered conductor study established by Energy Safety's 2021 WMP Action Statements. The study will continue to be utility-led, with the expectation for Energy Safety to be included as a participant.*

SCE's Response

Please see the Joint IOU Covered Conductor Effectiveness Working Group Report included in Appendix F that describes the efforts of the joint utilities to share and determine best practices for inspecting and maintaining covered conductor.

SCE-22-11 New Technologies Evaluation and Implementation

Description: *SCE needs to work and benchmark with other utilities to further evaluate new technologies and share progress on pilots and implementation.*

Required Progress: *All electrical corporations must collaborate to evaluate the effectiveness of new technologies that support grid hardening and situational awareness such as REFCL and DFA/EDF, particularly in combination with other initiatives. Utilities must also share practices and evaluate implementation strategies for these new technologies.*

SCE's Response

Please see the Joint IOU Covered Conductor Effectiveness Working Group Report included in Appendix F which describes the efforts of the joint utilities to evaluate the effectiveness of new technologies that support grid hardening and situational awareness, such as REFCL and DFA/EDF, particularly in combination with other initiatives. Additionally, SCE meets regularly with IOUs to discuss practices, studies, performance, and technical matters related to REFCL. These meetings generally occur monthly and include both domestic and international companies to share best practices and lessons learned.

SCE-22-12 Residual Risk Reduction Associated with Covered Conductor

Description: *SCE is deploying a suite of mitigations under CC++ that should be seen as temporary solutions. SCE must strive to find more permanent solutions to address the remaining ignition risk.*

Required Progress: *In the 2023 WMP filing, SCE must:*

- *Provide SCE’s plan and timeline for moving forward with REFCL, including mileage and risk addressed.*
- *Provide SCE’s plan and timeline for moving forward with additional pilot technologies, such as DFA and EFD.*
- *Include effectiveness evaluations of added mitigation measures for CC++ in comparison to undergrounding when determining initiative selection.*

SCE’s Response

SCE seeks to clarify that CC++ is not a temporary solution. As discussed in Section 7.1.4, CC++ is SCE’s preferred and long-term solution for High Consequence Areas as defined by its IWMS Framework. Please also refer to Section 7.2.3 where SCE discusses interim mitigation strategies.

REFCL

At the end of 2023, SCE expects to have REFCL on three substations covering 847 miles of circuitry of which 373 miles is in HFRA. In 2024, we expect to increase that to 1,321 circuit miles of which 650 miles are in HFRA. SCE will complete its analysis of installations at the end of 2022 to inform plans for 2025 as described in Section 8.1.2.11.3.

DFA

DFA and EFD technologies both offer capabilities for situational awareness of incipient fault and undesirable conditions. However, SCE does not have further plans to deploy additional DFA after further evaluation of the technology and determining the technology is not yet mature.

EFD

Between October 2020 to the end of 2021, SCE evaluated 10 instances where the EFD technology (SA – 11) detected undesirable, degraded, or pre-failure system conditions where repairs have subsequently been completed. SCE will target 50 installations of EFD in each year of 2023 and 2024 and 200 installations of EFD in 2025. Additional information about EFD and the timeline for planned installations may be found in Section 8.3.3.

These new installations will test next generation EFD equipment, which is intended to increase sampling rates, and improve the signal-to-noise ratio in comparison to current EFD equipment. Installations will focus on testing the use of the new generation hardware, and further installations on sub-transmission system voltages. New installations in both Distribution and Transmission are expected to expand application capabilities for different line construction configurations, such as horizontal or vertical. SCE also intends to further explore different EFD detection capabilities, by completing staged testing to simulate vegetation grow-in and bridging of covered conductor phases.

Undergrounding Compared to CC++

In addition to Table SCE 7-06, which provides effectiveness values for SCE's initiatives, please also see Table SCE 7-07 that indicates risk reduction assessments for CC++ along with REFCL/CC++ and targeted undergrounding on a standalone basis. As noted above, SCE considers CC++ as a preferred mitigation approach for High Consequence Areas, and as such has not scoped or modeled "added mitigation measures" incremental to CC++. However, in Severe Risk Areas, SCE intends to scope REFCL in addition to more frequent asset inspections.

SCE-22-13 Remaining Severe Risk Areas

Description: SCE does not have 36.36% of its self-defined severe risk areas accounted for within its grid hardening scope.

Required Progress: In the 2023 WMP filing, SCE must:

- Provide a plan, including timeline, for scoping and addressing the remaining severe risk areas by the end of the 2023-25 WMP cycle.
- Provide a plan for addressing the near-term risk in the remaining 36% of severe risk areas in the interim.

Required Progress #1

Provide a plan, including timeline, for scoping and addressing the remaining severe risk areas by the end of the 2023-25 WMP cycle.

SCE's Response

The 36% was derived using 2022 WMP Table SCE 7-3 (below), which stated that 700 of 1,925 miles were not yet scoped at the time of submission of the 2022 WMP:

Table SCE 7-3

Category	Currently Hardened	Currently Unhardened		Total
		In-Flight CC Scope	Not Currently Scoped	
Severe Risk Areas Miles <ul style="list-style-type: none"> • Egress Areas • Burn-in-Buffer • Exceptionally High Standard Consequence Areas • Extreme High Wind Areas 	725	500	700	1,925
High Consequence Segments Miles <ul style="list-style-type: none"> • 300 Acres at 8 hours⁹⁸ 	1,700	1,350	2,025	5,075
Other HFRA Miles	475	550	1,675	2,700
Total	2,900	2,400	4,400	9,700

SCE submitted its 2022 Risk Assessment Mitigation Phase (RAMP) to the CPUC on May 13, 2022 and stated its intention to scope the remaining unhardened overhead circuit miles in Severe Risk Areas by 2028 (see 2022 RAMP, Ch 4, page 11, Table I-1).

Table I-1
2025-2028 Scope of WCCP and TUG for Proposed Plan

	Estimated Unhardened Overhead Circuit Miles by end of 2024	2025 - 2028 Scope (Circuit Miles)	
		Wildfire Covered Conductor Program	Targeted Undergrounding
Severe Risk Areas	580	0	580
High Consequence Segments plus Buffer	1,400	1,250	0
Total	1,980	1,250	580

As of the end of 2022, SCE has hardened approximately 4,400 miles with covered conductor and undergrounding. As discussed in Section 8.1, SCE anticipates undergrounding 75 miles of overhead lines in Severe Risk Areas between 2023 and 2025. This includes 11, 16, and 48 miles for years 2023, 2024, and 2025, respectively. SCE will strive to complete up to 20, and 60 miles in 2024, and 2025, respectively. As seen in the RAMP table above, of the estimated 580 unhardened overhead circuit miles in Severe Risk Areas by the end of 2024, SCE will strive to complete 60 miles in 2025. SCE anticipates completing the remaining 520 miles between 2026 and 2028 to have fully hardened the 580 miles by the end of SCE’s GRC period.

Please also see Section 7.1.4 for discussion of SCE’s continued commitment to targeted undergrounding as the preferred mitigation for Severe Risk Areas. Details on SCE’s mitigation scoping and planning process, including for mitigations with long lead times, such as undergrounding are discussed in Section 7.1.4.3. SCE notes that the scoping and planning process is a multi-year effort, and that all undergrounding prioritization and scoping decisions are manually reviewed by an expert team within SCE to consider factors, such as risk, constructability, potential to bundle work, line routing, and overall schedule priority. In some cases, specific terrain or local issues may require alternatives, such as covered conductor with supplementary mitigations. While projects are scoped and awaiting construction, SCE considers interim mitigations to reduce risk, as further discussed in Section 7.2.3

Required Progress #2

Provide a plan for addressing the near-term risk in the remaining 36% of severe risk areas in the interim.

SCE’s Response

Please see Section 7.2.3 for SCE’s discussion of interim mitigation strategies for mitigations with long lead times such as undergrounding.

SCE-22-14 Evaluation of Vibration Dampers

Description: SCE is scaling back on its vibration dampers retrofitting for installed covered conductor.

Required Progress: In its 2023 WMP, SCE must:

- Provide a description of the analysis performed to determine local wind conditions that lead to Aeolian vibrations.
- Provide further justification for why SCE is scaling back vibration damper installation for covered conductor retrofits.
- Explain why it has not performed similar analysis for all covered conductor installations.

Required Progress #1:

Provide a description of the analysis performed to determine local wind conditions that lead to Aeolian vibrations.

SCE Response:

Aeolian vibrations may occur when smooth, non-turbulent wind passes across the conductor. Wind speeds that induce Aeolian vibrations range from 2 to 15 mph. Aeolian vibrations are more likely to occur in flat and open terrain. Based on these criteria, SCE used terrain and wind conditions to analyze vibration susceptibility of covered conductor installations. SCE focused on installations 3,000 feet and below, which is consistent with SCE’s standard vibration damper requirements under the GO95 definition of light loading areas (e.g., no weight from snow anticipated). SCE used three categories for vibration susceptibility (high, medium, and low).

SCE used wind data from its weather stations and performed an analysis based on factors including the average daily duration of wind speeds from 2 to 15 mph and the wind direction. SCE accounted for wind direction and only counted durations when the wind was flowing perpendicular to the conductor.

For terrain, SCE used terrain categories defined in CIGRE³⁰⁵ 273: Overhead Conductor Safe Design Tensions with Respect to Aeolian Vibration. The terrain categories are defined as follows:

Table ACI 14-01 – Aeolian Vibration Terrain Categories

Category	Description
Terrain 1	Near large bodies of water or flat desert. No obstruction.
Terrain 2	Flat farmland. Small agriculture is fine. No obstruction (limited number of buildings, etc.). If building is not an obstruction & there is perpendicular wind path to circuit, this is fine.
Terrain 3	Flat open land with few obstacles. Undulating terrain with no obstacles. Hilly area, but line is at top of hill with clear perpendicular with path.
Terrain 4	Residential suburbs, small town, some trees and obstacles, small buildings, woodland.

SCE conducted a mapping review and assigned a terrain category at the covered conductor locations

³⁰⁵ Global International Council on Large Electric Systems for sharing of end-to-end power system expertise. The community features thousands of professionals from over 90 countries and 1250 member organizations.

based on satellite and street view images.

A combination of the average daily duration of wind speeds between 2-15 mph and terrain categories were used to determine the vibration susceptibility. The table below provides the guidelines used. Wind condition is defined as the average daily duration of wind speeds from 2 to 15 mph flowing perpendicular to the conductor.

Table ACI 14-02 – Aeolian Vibration Susceptibility Categories

Rank	Terrain	Wind Frequency (Average Daily Duration)
High	Terrain 1	All Wind Condition
	Terrain 2	Wind Condition \geq 20%
	Terrain 3	Wind Condition $>$ 60%
Medium	Terrain 2	Wind Condition $<$ 20%
	Terrain 3	$20 <$ Wind condition $<$ 60%
	Terrain 4	Wind Condition $>$ 80%
Low	Terrain 3	Wind Condition $<$ 20%
	Terrain 4	Wind Condition $<$ 80%

Required Progress #2

Provide further justification for why SCE is scaling back vibration damper installation for covered conductor retrofits.

SCE’s Response

SCE has not reduced vibration damper installations and continues to prioritize areas most susceptible to Aeolian vibrations for targeted retrofit installations. SCE does not consider its risk-based approach as equivalent to generally “scaling back” the program. Consistent with many mitigation programs, SCE is focusing its efforts on the highest-value areas and uses cases, which is prudent and appropriate from the perspectives of wildfire mitigation and cost effectiveness.

For retrofits, SCE prioritizes spans ranked as either “high” or “medium.” In new line installations, dampers will be installed in all high, medium, and low categories, which are defined above, except in most cases above 3,000 ft, which can be subject to added weight from snow and in reduced tension spans, which have limited potential for Aeolian vibration.

Required Progress #3

Explain why it has not performed similar analysis for all covered conductor installations.

SCE’s Response

SCE has performed similar engineering analysis to establish the criteria detailed above for new covered conductor construction. To evaluate all other spans would not be fruitful as the methodology described above is effective in prioritizing and identifying areas and conditions in which Aeolian vibration may be a concern.

SCE-22-15 Targets Relating to Addressing Inspection Findings

Description: *SCE's increased inspections (performed to exceed existing GO requirements and better address wildfire risk) resulted in a backlog of repairs*

Required Progress: *In its 2023 WMP, SCE must:*

- Identify which open work orders directly present ignition risks and provide a plan to prioritize repairs that address the highest risk. This plan should cover a time period up to the end of 2023.*
- Provide quantitative targets for addressing repairs for infractions found during inspections, broken down by severity level of the finding.*

SCE's Response

As part of SCE's standard operating procedure, any notification that may result in an imminent ignition risk (P1) is made safe within 24 hours and the remediation is started within 72 hours, and thus P1s do not contribute to the scope of notifications past their compliance due date. As a result, SCE limited the scope of its response to its backlog of repairs stemming from P2 notifications, as this focuses on the next level of risk after P1s.

P2 notifications in elevated (Tier 2) and extreme (Tier 3) high fire risk areas are generally remediated within 12 months or six months respectively. SCE did not include P3s in this scope because they are low risk and/or do not pose an ignition risk. As part of SCE's internal process for notifications, if a P2 or P3 notification was created and an imminent safety hazard discovered (i.e., via inspections or patrols), SCE would treat it as a P1 and take immediate action to make the condition safe.

The scope for the backlog of notifications used is based on a snapshot in time (October 26, 2022). This baseline starting point allowed SCE to develop a plan to work down its backlog of notifications. SCE is continually improving its inspection programs to identify issues based on field and engineering lessons learned, which may result in increases in notifications created (similar to what occurred when the Enhanced Overhead Inspection program first launched). Additionally, SCE strives to complete its HFRA inspections prior to peak fire season which can have the side effect of larger populations of notifications due around the same time.

- Identify which open work orders directly present ignition risks and provide a plan to prioritize repairs that address the highest risk. This plan should cover a time period up to the end of 2023.*

In response to this prompt, SCE will explain how it: (1) identified the scope of notifications within its backlog that could potentially present an ignition and risk, and (2) created a prioritization method which may inform SCE's plan to work down the backlog in 2023.

1. Scope

SCE identified the scope of its backlog by focusing on asset notifications that pose a potential ignition risk³⁰⁶ that are past their compliance due date from a specific snapshot in time. The total backlog

³⁰⁶ A notification is classified as an ignition risk if the identified issue has the potential to cause a fire. An example of an ignition risk is an active deteriorated pole that is in a forested area. A notification is not considered an ignition risk if the issue has no potential to cause a fire. An example of a non-ignition risk is a customer attaching a mailbox to an SCE pole that is close to the ground or grading in an area with no surrounding vegetation.

included approximately 11,100 transmission and distribution asset notifications that pose a potential ignition risk that were not closed by their targeted completion date and considered priority 2 notifications. Each day, notifications are opened, closed, and a small number invariably become past due. Thus, this static population represents a baseline for SCE to track progress against.

SCE grouped the ~11,100 asset notifications into four categories. Each category represents a key driver for delays in work order remediation. These categories are: Pending Late, GO 95 Exceptions, Notify Third Party, and Inactive Equipment and/or FLOC³⁰⁷. Notify Third Party and Inactive Equipment and/or FLOC are included here for completeness, however, may not have ignition risk due to their underlying characteristics as described below.

SCE notes that the majority of notifications falling into the Pending Late and GO 95 Exception categories are on structures with lower risk based on SCE's preliminary analysis of their combined probability of ignition and wildfire consequence scores.

Scope Category (1 of 4): Pending Late

A pending late notification signifies a notification that is past due and does not fall within the other scope categories defined below (i.e., GO 95 exception, notify third-party, or inactive equipment and/or FLOC issues).

Scope Category (2 of 4): GO 95 Exceptions

A General Order 95 (GO 95) exception applies when an external constraint prevents a utility from completing work within a compliance timeframe. There are several scenarios which qualify for the GO 95 exceptions: (1) permitting, (2) third party refusal, (3) no access, and (4) system-wide emergency. For GO 95 exceptions, SCE evaluated all its notifications within the GO 95 Exceptions category to assess whether the notification was still constrained and could be remediated. While resolution of GO 95 exceptions is largely outside of SCE's control, for transparency SCE will include GO 95 exception details as part of its backlog reporting.

Scope Category (3 of 4): Notify Third Party

A "notify third party" notification occurs when SCE finds that a third party (either customer or a communication infrastructure provider) has created an issue that requires remediation on an SCE asset, most commonly a pole. Although SCE cannot force the third party to remediate, SCE notifies them of the outstanding issue. Examples of unauthorized alterations include incorrect attachments (e.g., wrong type of guywire utilized by a communication infrastructure provider), reduced clearances (e.g., broken communication lashing wire that could contact SCE conductors), unauthorized attachments (e.g., basketball hoop attached to a pole, unauthorized signage), etc.

Scope Category (4 of 4): Inactive Equipment and/or FLOC

SCE found that part of its notification backlog was caused by a latency in updating the system of record related to: (1) inactive equipment or FLOC; and/or (2) reject notifications. While this category may pose a lower ignition risk than other categories, SCE will strive to streamline its operating procedures across organizations to address these notifications.

Inactive Equipment or FLOC: This scenario stems from errors with dispositioning inactive equipment or

³⁰⁷ FLOC stands for Functional Location of Overhead Conductor.

FLOCs in our system of records. For example, when poles and equipment are replaced or deactivated in the system of record during emergency conditions such as storm work or fire restoration, open notifications may not be promptly updated once the asset is re-activated or replaced.

Reject Notifications: This type of scenario occurs when a notification is no longer needed because the issue has been resolved, but the notification is not yet closed in the system of record. This may occur if a notification is kept open for visibility while the underlying condition is remediated by another program.

Figure ACI-15-01 and Figure ACI-15-02 below provide a breakdown of the total count of notifications for transmission and distribution. Each chart provides the total notification counts by scope category as of 10/26 (Total (as of 10/26)). Each chart then delineates of that total, how many notifications are closed, scheduled to be closed by the end of the first quarter of 2023, open (not closed), and those that are either externally or internally constrained.

Figure ACI-15-01 - Transmission Notification Backlog Scope Breakdown

Category	Details	Transmission Total Counts				
		Total (as 10/26)	Closed	Close by Q1 2023	Not Closed	Constrained
Pending Late	Repair notification pending late with no documented exception, and work is SCE responsibility	340	160	0	10	170
GO 95 Exceptions	Repair Notification Pending Late with documented exception per GO 95 Rule 18 (e.g., third party refusals, no access, permits required), and work is SCE responsibility	1,815	135	80	515	1,085
Notify Third Party	Notification requires SCE to work with a third party to correct issue	10	0	0	10	0
Inactive Equipment / FLOC	Notification is pending on inactive equipment/FLOC or is rejected and not yet flagged for deletion	950	725	225	0	0
		3,115	1,020	305	535	1,255

Figure ACI-15-02 - Distribution Notification Backlog Scope Breakdown

Category	Details	Distribution Total Counts				
		Total (as 10/26)	Closed	Close by Q1 2023	Not Closed	Constrained
Pending Late	Repair notification pending late with no documented exception, and work is SCE responsibility	1,190	640	0	285	265
GO 95 Exceptions	Repair Notification Pending Late with documented exception per GO 95 Rule 18 (e.g., third party refusals, no access, permits required), and work is SCE responsibility	1,390	290	0	0	1,100
Notify Third Party	Notification requires SCE to work with a third party to correct issue	2,880	750	215	1,915	0
Inactive Equipment /FLOC	Notification is pending on inactive equipment/FLOC or is rejected and not yet flagged for deletion	2,565	0	1,835	730	0
		8,025	1,680	2,050	2,930	1,365

2. Plan to Prioritize and Work Down Notification Backlog

SCE has historically prioritized notifications based on the severity of the finding and the associated compliance deadline based on HFTD location (i.e., HFRA Tier 2, HFRA Tier 3, or Non-HFRA). In 2020, SCE introduced a notification prioritization algorithm to accelerate the timing for completion of remediation in AOCs on the FLOCs with the highest risk notifications. In Q4 2022, after considering existing risk processes and incorporating lessons learned, SCE expanded on the AOC prioritization methodology to inform its plan to work down the backlog.

SCE’s notification backlog prioritization methodology assigns weights to multiple factors (Technosylva consequence, how long the notification has been in place since identified, probability of ignition, and problem statement), and normalizes each factor to have values between 0 and 1, which is aggregated to result in a percentile ranking scale. Figure ACI-15-03 below is an illustration of the calculation utilized to prioritize the backlog of notifications. The algorithm is run for transmission and distribution notifications separately to prioritize for each program. Additionally, to manage the individual categories more closely, each scope category within the T&D programs was prioritized, depicted in Figure ACI-15-01 and Figure ACI-15-02 above. The higher the score, the higher the risk.

Figure ACI-15-03 - Notification Backlog Prioritization Methodology

$$\left(\frac{TS}{3}\right) + \left(\frac{TPD}{3}\right) + \left(\frac{0.5 \times (POI + PS)}{3}\right)$$

Key Terms

- TS: Technosylva
- TPD: Time Past Due
- POI: Probability of Ignition
- PS: Problem Statement Score

This new prioritization method allowed SCE to rank each notification based on risk in order to accomplish the various 2023 quantitative targets discussed in the following section.

- *Provide quantitative targets for addressing repairs for infractions found during inspections, broken down by severity level of the finding. This should include a description of SCE’s methodology for reaching these quantitative targets and preventing the occurrence of past due work orders.*

In June of 2022, SCE had approximately 17,500 pending notifications which were past due (approximately 12,700 for distribution; 4,800 for transmission). Since then, SCE has made significant progress by reducing the backlog by approximately 9,200 as of December 31, 2022 and expects to close another 2,400 past-due notifications by end of Q1 2023 of the backlog scope. Of the remaining past-due notifications, SCE is committed to the various quantitative targets depending on the scope category, which are discussed below.

SCE continues to work both the backlog discussed and all open notifications in tandem. Furthermore, SCE will investigate how to utilize its new prioritization methodology, which risk ranked all of its notifications in the backlog, to inform the order in which issues are remediated in 2023.

3. Quantitative Targets

Pending Late

From the static list of pending late notifications, SCE achieved completion of approximately 75% (800 out of 1,095 notifications across transmission and distribution) of its total unconstrained scope in the category by January 2023. SCE used its prioritization method to risk rank its notifications in this category. SCE’s initial objective was to remediate all unconstrained³⁰⁸ ignition risk notifications. However, some of these notifications had operational constraints, such as unavailability of materials, that made it difficult to close by a defined date.

SCE will strive to substantially complete the static list of unconstrained notifications by the end of Q3 in 2023.

GO 95 Exceptions

External parties, such as the government agencies or other third parties constraining work are outside of SCE’s control, SCE will continue to work with external parties to address notifications held due to GO95 exceptions. SCE is interested in partnering with Energy Safety to develop ways to establish a better feedback loop for notifications with GO95 exceptions, which would involve agencies notifying utilities when constraints are lifted or provide a firm timeline for responding to requests to expedite these matters to conclusion. Additionally, SCE is interested in working with Energy Safety on updating the GO 95 remediation compliance timelines to be more risk informed.

From the static list of GO 95 exception notifications, SCE successfully closed approximately 13% (425 out of 3,250 total notifications across transmission and distribution) of this category as of January 2023. Since these issues are externally constrained, SCE cannot commit to a specific target for when this scope category will be closed. In 2023, SCE will continue to monitor and drive the remaining GO 95 exception notifications to closure as expeditiously as possible.

Notify Third Party

³⁰⁸ A notification is constrained if there is an external reason (such as GO 95 exception) or an internal reason (such as a lack of necessary resources, such as wood for a pole installation).

From the static list of notify third-party notifications, SCE successfully closed 25% (750 out of 2,890 notifications across transmission and distribution) of this category by January 2023. Additionally, of the remaining open notifications, SCE has sent letters notifying third parties of the issue they have created on SCE assets. While this action technically satisfies SCE's obligation with respect to these issues, SCE will continue to monitor these notifications and request the third parties remediate the identified issues.

It is difficult to create a quantitative target for this scope category when remediation is dependent upon an external third-party. However, SCE will continue to strive for closure by notifying third parties of the issues they've created on SCE assets.

Inactive FLOC and/or Equipment

From the static list of inactive FLOC and/or equipment notifications, SCE was able to close 20% (725 out of 3,515 total notifications across transmission and distribution) of this category as of January 2023. Given that the repairs have been completed, this type of notification represents the lowest ignition risk of the categories.

SCE's initial analysis revealed that both Inactive Equipment or FLOC and Reject Notification populations can generally be remediated via desktop review and without field resources. Thus, SCE will continue to perform quality checks on remaining notifications and take appropriate action as needed to work the backlog down. SCE commits to closure of the static list of approximately 1,800 distributions notifications by the end of the first quarter of 2023. For those notifications in which a desktop review will not suffice, SCE will deploy field crews to assess whether the issues still remain, or the notification should be closed in the system of record.

4. Preventing the Occurrence of Past-Due Notifications

SCE is working diligently to address the current backlog and prevent the occurrence of new past-due notifications by implementing new processes and resources. As discussed in this response, there are factors that may lead to past due notifications in the future. While SCE is committed to remediating issues within the required timelines, we are also focused on remediating the highest risk items first. Accordingly, SCE will analyze how it can prioritize all open notifications in a risk-informed manner. In 2023, SCE plans to update its prioritization methodology for its backlog and apply it to all open notifications. SCE will also investigate the possibility of informing open notification prioritization methodology with additional factors such as PSPS and AOCs. Similarly, SCE will investigate how it can deprioritize low-risk notifications while balancing compliance requirements to reduce the backlog and continue to prioritize higher ignition risk open notifications.

SCE-22-16 Increases in Equipment Related Ignitions

Description: SCE’s equipment-related ignitions outside of the HFRA have increased, particularly those related to conductor damage and failures.

Required Progress: In its 2023 WMP, SCE must:

- Provide failure mode, event, and trend analyses relating to recent increases in ignitions from equipment failures, including conclusions, root cause analysis, and lessons learned.
- Provide a plan to specifically address ignitions in high-risk areas caused by conductor, transformer, and connection device damages and failure.

Required Progress #1

Provide failure mode, event, and trend analyses relating to recent increases in ignitions from equipment failures, including conclusions, root cause analysis, and lessons learned.

SCE’s Response

The following table provides annual ignition counts over 2019 through 2022 for the sub-drivers that collectively represent equipment failure (EFF):

Figure ACI-16-01 - Annual Ignition Counts by EFF Sub-Drivers (Non-HFRA), 2019-2022

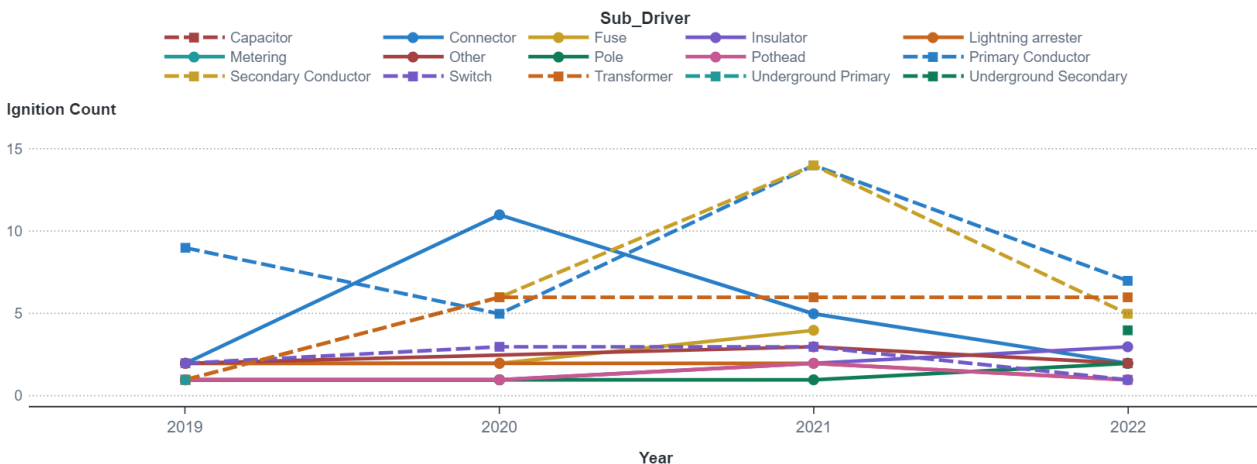

As stated previously in the response to ACI.22.06, external factors such as moisture, fuel load, and wind are likely to influence ignition trends, and hence variations from one year to the next may not necessarily indicate meaningful trends. SCE analyzes ignition events from the perspective of distinguishing factors that may be linked to short-term or unique external conditions from factors that may be indicative of more inherent issues that are less linked to short-term or external conditions that vary from one year to the next. Below SCE provides its analysis of EFF ignitions by sub-driver.

In 2022, SCE expanded the process for its Fire Investigation team to review all repair orders to avoid missing some potential ignitions, which may have caused an increase in events in 2022, for more information please see Section 11. Even with this additional review, almost all EFF ignition drivers decreased in 2022 outside of HFRA. This has been driven in part by SCE’s Overhead Conductor Program

(OCP) addressing conductor related failures³⁰⁹. Moreover, as noted in ACI SCE-22-17, below, SCE modified its inspection form to add more details concerning secondary conductors.

Regarding underground cable, SCE has seen a slight increase from 2019 to 2022 in part due to overloading caused by recent heat waves that SCE's service territory has experienced. Lessons learned include increasing trends regarding underground related ignitions which is SCE is currently evaluating potential solutions to mitigate against future.

From 2019 to 2021, SCE saw over a 200% increase in ignitions from secondary conductor. Please see SCE's response to ACI SCE-22-17, which provides data on secondary conductor, including SCE's plan to mitigate and reduce secondary conductor ignitions in the future.

Required Progress #2:

Provide a plan to specifically address ignitions in high-risk areas caused by conductor, transformer, and connection device damages and failure.

SCE's Response

Conductor: Please see Section 7.1.4 for SCE's discussion of conductor-related mitigations, such as covered conductor and undergrounding. In addition, SCE's response to ACI SCE-22-17 details SCE approach to addressing secondary conductor-related ignitions.

Transformer: SCE is in the process of replacing mineral oil-filled transformers with ester fluid-filled transformers. Envirotemp FR3 Fluid, or ester fluid, is a derivative of renewable vegetable oil, and has a higher flash point rating than mineral oil. This decreases the likelihood that the fluid and/or fluid vapors will ignite and stay lit during a catastrophic event. This in turn reduces the chance of igniting surrounding brush and/or other flammable material surrounding the pole and transformer. Also, distribution transformers that are filled with ester fluid can operate at higher temperatures than mineral oil-filled transformers, and still have the same life as the mineral oil-filled transformer. This increases the transformer kVA capacity. This added kVA capacity will prolong the life of the transformer's internal insulation system and improve summer heat storm performance.

Starting in 2018, all standard pole-type transformers supplied to SCE are filled with ester fluid. Ester fluid transformers are installed to support new constructions, as well as transformers replacements driven by inspections and maintenance programs, load growth and voltage cutover programs, and other activities. Because transformer replacements will occur through these programs over time, the full benefits and reduced ignition risks for distribution transformers is expected to increase over time as the percentage of FR-3 filled transformers on the system rises.

Connection Device Damages and Failure: SCE's covered conductor and undergrounding programs address this by replacing or eliminating connection devices. SCE's mitigation approaches towards reducing connector-related ignitions include: (1) covered conductor, which replaces existing connectors during the installation, (2) infrared scanning of overhead facilities, which identifies connectors with elevated temperatures for replacement, and (3) new technology evaluation of Early Fault Detection (EFD), which identifies degraded connections that produce radio frequency emissions, for replacement.

³⁰⁹ SCE's OCP is focused in reducing Contact with Energized Equipment risk and the reduction of wire down events, and does provide a secondary benefit in reducing ignitions caused by conductor failure, connectors and splices.

SCE-22-17 Address Secondary Conductor Issues

Description: SCE has a high percentage of ignitions from secondary conductor, and a high find rate for findings relating to secondary conductor during inspections' QA/QC.

Required Progress: In its 2023 WMP, SCE must:

- Provide its plan to mitigate and reduce secondary conductor ignitions in the future, including a timeline and status for the plan it provided in its 2022 Update.
- Demonstrate a decrease in the percentage of QA/QC findings relating to secondary conductor.

Required Progress #1:

Provide its plan to mitigate and reduce secondary conductor ignitions in the future, including a timeline and status for the plan it provided in its 2022 Update.

SCE's Response:

From 2019 to 2021, SCE saw over a 200% increase in ignitions from overhead secondary conductor as shown below in Figure ACI-17-01, as well as a high number of QC findings regarding overhead secondary/service conductor conditions. In 2022, the main driver of secondary ignitions was Equipment/Facility Failure (EFF) (approximately 70%) followed by Contact Foreign Object (CFO) (approximately 15%) as shown below in Figure ACI-17-02.

SCE added questions to the inspection survey in Q2 of 2021 (e.g., copper vise connector, no non-exempt connector present), which is utilized in the field by the inspector (who is an Electric System Inspector (ESI)) who performs a comprehensive inspection survey. Additional training was provided to the ESIs not only on the form but on the specific issues to look for while performing the inspections, such as damaged secondaries. These changes have resulted in an increase in inspection repair notifications from 4,502 to 8,322 in 2021 to 2022, respectively relate to secondary conductors.

Figure ACI-17-01 - Ignition Trends for Overhead Secondary

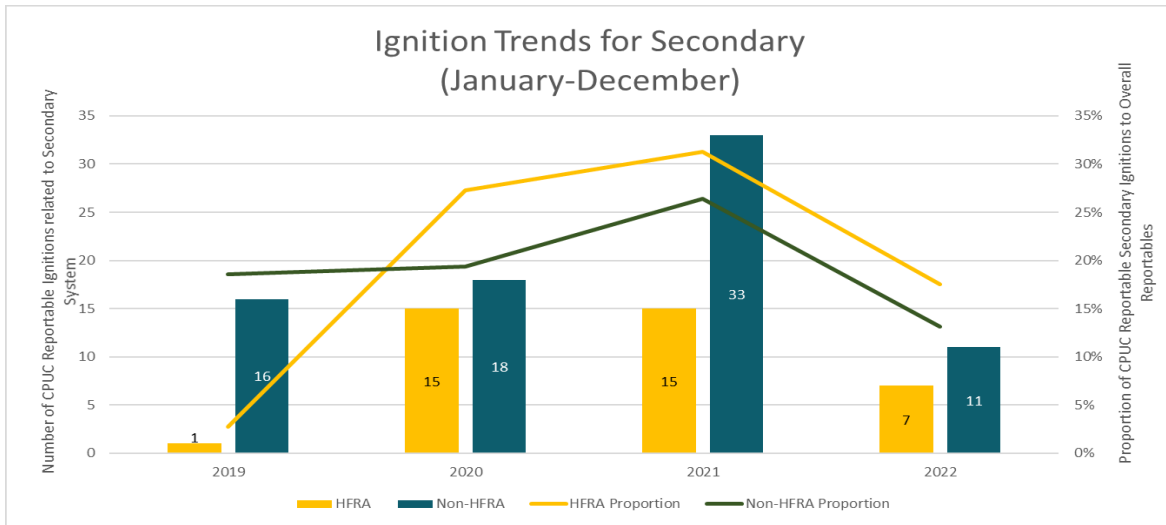
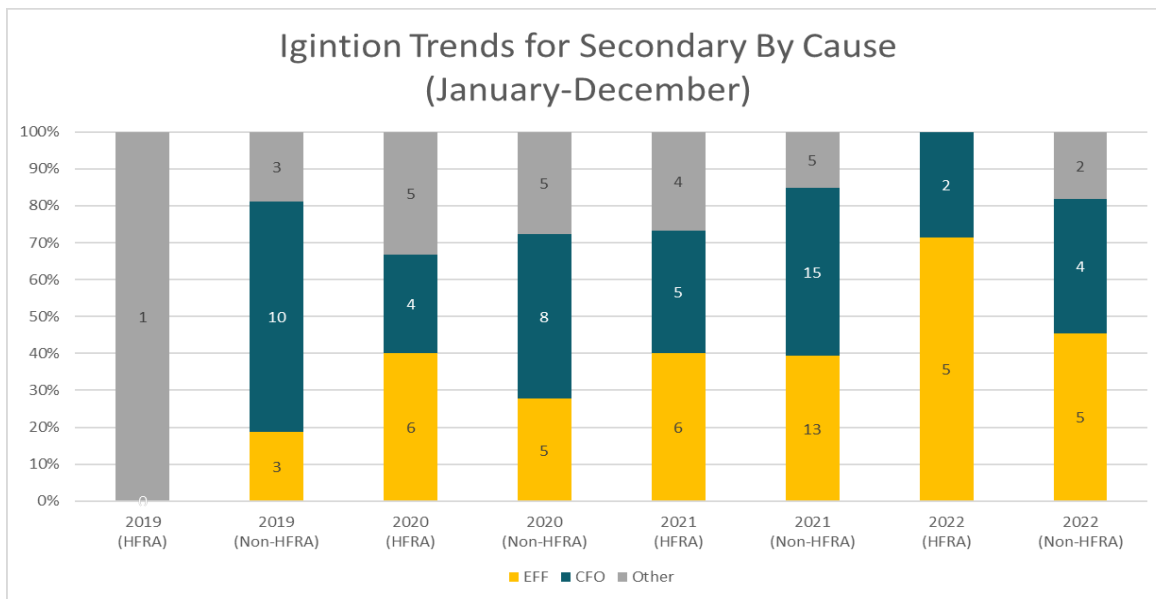

Figure ACI-17-02 - Ignition Trends for Overhead Secondary by Cause



In addition, in 2022, SCE inspected and trimmed vegetation around approximately 700 secondary structures and taped connectors on approximately 3,000 secondary structures in SCE’s HFRA. In 2023, SCE will continue vegetation management work by inspecting approximately 1,000 secondary structures and perform trimming as necessary. SCE is also developing a secondary connection covering to replace temporary taping and evaluating a breakaway that disconnects and de-energizes service and secondary connector at predetermined mechanical load, which prevents ignitions if the wires fall due to fallen trees or excessive winds. Notifications were created to replace all identified high fire open-wire bare secondaries with multiplex conductor within a three-year timeframe. Lastly, SCE has seen a reduction in reportable ignitions caused by secondary conductors from 30% in 2021 to 20% in 2022.

Required Progress #2:

Demonstrate a decrease in the percentage of QA/QC findings relating to secondary conductor.

SCE's Response

SCE clarifies that a Quality Control (QC) inspection is “conducted by evaluating the results of a sample of completed inspections after the fact” while a Quality Assurance (QA) review “evaluates the process and supporting evidence to provide reasonable assurance to management that the WMP goals/activities have been met.” In addition, SCE further clarifies that QA is “process oriented” to focus on preventing future defects, while QC is “product oriented” and focuses on identifying each defect.

In 2021, 1.4% of structures had a QC finding (Priority 1 and/or Priority 2 condition not identified during an inspection) related to secondary/service conductor damaged/clearance issues. In 2022, 0.6% of structures had a QC finding related to secondary/service conductor damaged/clearance issues. This represents a 57% reduction in secondary/service conductor findings per structure, which SCE attributes to the process improvements noted above concerning form enhancements and improved inspector training.

SCE's pass rate (percentage of inspections for which a QC finding was not identified) for its QA/QC of overhead detailed inspections within high-fire areas improved from 92 percent in 2021 to 94 percent in 2022, in part due to the reduction of QC secondary findings. The increase in repair notifications identified by SCE inspectors as well as a corresponding decrease in QC findings related to damaged secondary conductors can be attributed in part to the recent improvements to the inspection form.

SCE-22-18 Progression of Joint Effectiveness of Enhanced Clearances Study

Description: *The 2021 Action Statements required the Large IOUs to conduct a study assessing the effectiveness of enhanced clearances. Progress has been made in the study; however, the study must continue to progress.*

Required Progress: *By the submission of the 2023 WMPs, SDG&E, along with PG&E and SCE, must (1) standardize the data collection process for the cross-utility database of tree-caused risk events, (2) determine where and in what form the database will exist, (3) examine, to the best of their ability, whether the correlation between enhanced clearances and the lower number of tree-caused outage events may be attributable to other factors beyond clearances, such as the management of hazard trees and the installation of covered conductor. Energy Safety expects the large IOUs to make incremental progress and update their analyses with each WMP submission through at least 2025.*

2023 – 2025 WMP

Areas for Continued Improvement and Required Progress of the IOUs' 2022 WMP Update Progression of Effectiveness of Enhanced Clearances Joint Study

Response:

The utilities have prepared a joint response to this Area for Continued Improvement.

SDG&E, PG&E, and SCE (jointly, investor-owned utilities or IOUs) have continued collaboration on the vegetation clearance study. Bi-weekly meetings occurred throughout 2022 with attendees from the IOUs and Energy Safety attending.

The IOUs are focused on addressing the required progress of this study, which include:

- Standardize the data collection process for the cross-utility database of tree-caused risk events
- Determine where and in what form the database will exist
- Examine, to the best of our ability, whether correlation between enhanced clearances and the lower number of tree-caused outage events may be attributable to other factors beyond clearances, such as the management of hazard trees and the installation of covered conductor

In order to achieve the results of the study most effectively, the IOUs chose to hire a third-party to establish the data collection standards, create the cross-utility database, and study the relationship between enhanced vegetation clearances and tree-caused risk events. A third-party vendor to assist with the study will provide both experience in data analysis and an independent review of the data and conclusions.

To select a qualified vendor for this multi-year engagement the IOUs nominated potential bidders for the work, and SDG&E led a Request for Information (RFI) event that was sent to eight different vendors to understand their capabilities in performing this study. The RFI was distributed in February, with responses due back in early March. After reviewing and scoring the information received from the vendors, three were then invited to participate in a Request for Proposal (RFP). The documentation for

the RFP was prepared and distributed to the vendors in early June and responses were received in July. The RFP materials were scored, and negotiations began with the selected vendor in August. The completed and signed contract was completed in October and the vendor began attending the joint IOU meetings and beginning data collection for the study. Progress on each of the required areas is provided below:

The EPRI research team is implementing a phased approach to the study consisting of 1) Database Evaluation, 2) Database Development, and 3) Data Analysis. The first step has been for EPRI to request a sample set of data from each of the participating IOUs. This data includes information from relevant vegetation, outage, GIS, weather, and related data sets. The data samples are currently under review and a meeting with the research team and the IOUs is planned for Q1 of 2023 to discuss the data fields. After this discussion, a larger sample of data will be requested from each of the IOUs, including relevant metadata, and including historical data. These will be pulled together into a combined database, and jointly evaluated. The EPRI team will consider how best to combine the three separate groups of data into a single database. This will begin the second phase of the study: Database Development. The database will exist on the EPRI Server. The three phases are described in more detail below.

The database will exist on the EPRI Server, and outage data will be pushed to EPRI at a time step discussed over the course of the project, likely weekly. Vegetation, weather, GIS, and other datasets will also be pushed to the database at selected, regular intervals. The outage data will include outages that are not vegetation related. EPRI will query the freeform notes to extract possible tree related outages that were coded erroneously. EPRI will examine and put the utility data into a common format and create a new database of the combined utility data. This data will be accessible for queries by the participants. If all the participants agree, the data can also be available for downloading, and can be obfuscated to the degree necessary by the providing utility prior to transfer.

This will be done by first examining a selection of each IOU's databases including weather, vegetation management, GIS, Outage Management Systems (OMS), and other related databases. This review will first include a review of the datasets, the frequency of collection, the quality of the data, the confidence in the data, historical data available from each IOU, the metadata, variables, definitions, and identify a data steward from each company. Using this information from the sample selection, and a second request for larger dataset, we will create a data dictionary. After reviewing the samples of each utility, and during the immersive discussions described below, we will develop the joint database. The fields and coding systems in the joint database will be designed with the utilities and using the experience of the vendor in similar projects. The EPRI Data Science Platform will be able to integrate data of various formats and types, facilitating the data analysis described below.

The study intends to create the joint database across the three utilities which would be able to establish uniform data collection standards, focus on tree-caused risk events, incorporate both biotic and abiotic factors, and assess the effectiveness of enhanced clearances. Once the database is created, there is an opportunity for researchers and practitioners to gain deep insight on the causes of ignition events and the potential vegetation management options to mitigate them.

The following steps will be implemented between January 2023 and June 2024.

1) Database Evaluation:

a. First, to evaluate existing data, and recognizing that each IOU's database has some common fields and other fields that are not common across all IOUs, a sample of each database will be evaluated, and then a larger section of the data will be evaluated. This will be to review existing data and guidelines for data collection and determine if the current structures allow the key research questions for this project to be addressed. To that end, and to help ensure that the data curated can acceptably inform the questions to be answered, EPRI plans to have immersive discussions with each IOU's respective vegetation management and outage management teams to better understand what data is currently curated and to evaluate the level of quality and certainty of data contained in the database fields. The purpose of the immersive discussions is to understand the current database structures used by each utility, the method of recording data, the type of historical records available, the definitions of specific tree-pruning activities, the differences in the outage management systems, and other information that may vary from utility to utility.

b. Parallel or after the individual meetings, the research team and SMEs from each of the three IOUs will attend a follow up workshop to be hosted by SDG&E, or one of the participating utilities. This is scheduled for February 6-7. During this meeting, we will discuss the key questions raised at the individual meetings and discuss organizing outage cause codes into common groupings to best capture the information needed to perform a meaningful study, including sharing ideas regarding additional data fields. As a team (research team and utility SMEs) we will decide on the design of a consolidated database structure to be used moving forward.

c. Third, once outage cause codes are determined, a survey/coding workshop will be developed describing scenarios that should be coded. This survey will be administered to all employees that input cause codes in the outage management system (OMS). While the survey will capture the initial inputs, the survey will also present the user with the desired coding based upon the decisions made in the group workshop.

2) Database Development:

a. EPRI will base the database development on previous experience with cross utility databases such as the industry wide databases for T&D asset performance, inspections, and maintenance. Before defining the final database structure, EPRI will follow a phased approach. Initially, EPRI will investigate each utility's data individually. Then, they will look at the lessons learned to assess the broader applicability. At that stage, EPRI can initiate the development of a cross utility database by designing the criteria around how the common database is set up and populated, as well as the data management lifecycle criteria.

3) Data Analysis:

a. In addition to a single-unified database structure and the data to support that structure that allows IOUs to understand every vegetation contact with the lines, there is a need to drill down to understand vegetation treatments and their effectiveness. Assuming adequate history on circuits that have data before and after enhanced clearance work was performed, we would conduct statistically valid and defensible analyses on that group of circuits. The general objective of the data analysis would be to understand the effect of enhanced vegetation clearances on outage performance. The results would likely lead to other insightful analyses and comparison with other treatment approaches and to different weather conditions. Depending on the type of data received, its granularity, the temporal scale, length of time that enhanced vegetation management has been implemented in the circuits, and how many

variations the utility has used, there are many different directions of analysis. For example, if the circuit characteristics and approaches are substantially different from one another (circuit to circuit or utility to utility) a self-benchmarking or baseline extrapolation might be possible if sufficient historical data is also provided. Similarly, other data analysis possibilities exist that will be determined as the scope of the data becomes available.

b. EPRI will share the results of Data Analysis in a technical memo which will include data, graphs, charts, and narrative text. This information can be used to share results with joint IOU stakeholders, including agencies, and the general public, regarding results of the data analysis and any insights regarding the potential links between enhanced vegetation clearing, outages, and ignition risk.

Separate from the joint IOU database study on enhanced clearances, each of the large IOUs have completed work to understand the effectiveness of enhanced clearances within their respective service territories. Details on these efforts are described below.

SDG&E

San Diego Gas & Electric (SDG&E) has implemented several initiatives within its Vegetation Management program to reduce power outages and mitigate the risk of wildfire. These initiatives include covered conductor, undergrounding, enhanced inspection processes, and enhanced line clearance. To assess the impact of the Enhanced Clearance Vegetation Management program, which was launched in 2019, we conducted an analysis. Our goal was to understand the effectiveness of this program in reducing outages and potential wildfire.

According to the California Public Utilities Commission (CPUC) General Order 95, Rule 35, distribution voltage lines in California must have a minimum clearance of 18 inches. In the High Fire Threat District (HFTD) region of the state, the minimum clearance is 4 feet for distribution lines. For the purposes of this analysis, "enhanced clearance" refers to trees that were trimmed to a height above 11 feet. In 2019, SDG&E increased the percentage of trees managed at enhanced clearance distances (11 feet or higher) to 25% of its inventory and saw a reduction in power outages. The graph below illustrates the percentage of inventory trees that were managed at enhanced clearance distances versus not enhanced from 2006 to 2022.

Distribution of Tree Inventory Line Clearance Distance

Percentage of Trees Enhanced vs. Non Enhanced 2006-2022

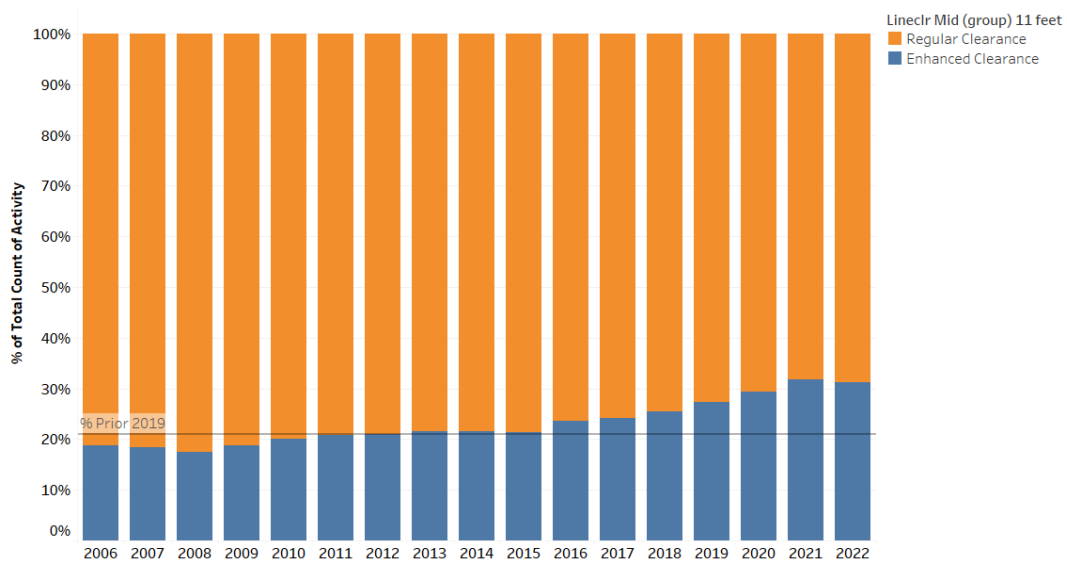

Historical Vegetation related Outage Count

Vegetation related Outages 2006-2022

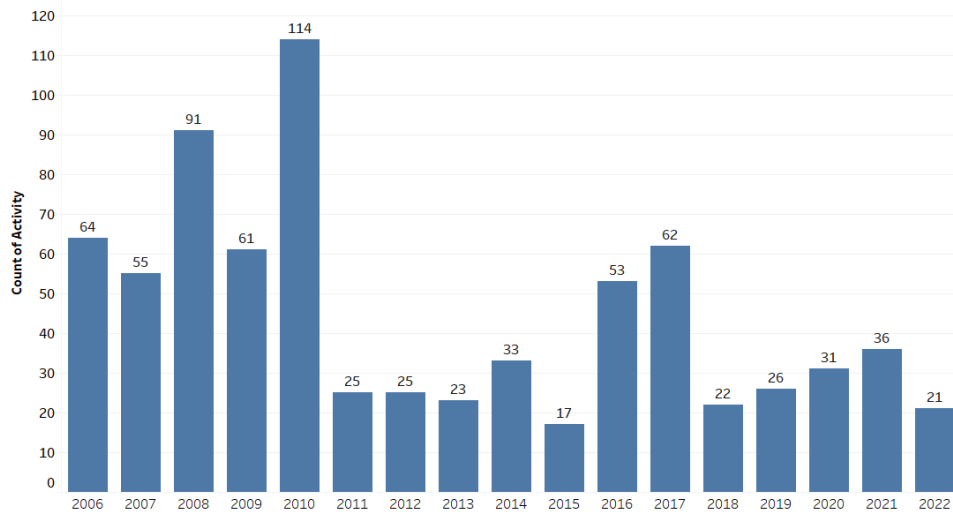

To understand its outage reduction over recent years, SDG&E analyzed historical data. When comparing the years 2019-2022 to 2014-2018, SDG&E observed approximately a 20% improvement in outages.

Year	Group	Count of FACILITYIDs	Outage Count	Outage Rate (Outage Count/Count of FACILITYIDs)	% of FACILITYIDs less or equal to 11 feet	% of FACILITYIDs greater than 11 feet	Avg % of FACILITYIDs greater than 11 feet	% Change	Average Outage Count	Outage Improvement (count)	Outage Improvement (% change)	Average Outage Rate	Outage Rate Improvement	Outage Rate Improvement (% change)
2014	Prior EVM (14-18)	393,217	33	0.008%	78.4%	21.6%								
2015	Prior EVM (14-18)	388,903	17	0.004%	78.6%	21.4%								
2016	Prior EVM (14-18)	383,351	53	0.014%	76.3%	23.7%								
2017	Prior EVM (14-18)	379,431	62	0.016%	75.8%	24.2%								
2018	Prior EVM (14-18)	381,170	22	0.006%	74.6%	25.4%	23.2%		37.4			0.010%		
2019	EVM (19-YTD 22)	377,554	26	0.007%	72.7%	27.3%								
2020	EVM (19-YTD 22)	377,919	31	0.008%	70.7%	29.3%								
2021	EVM (19-YTD 22)	384,613	36	0.009%	68.2%	31.9%								
2022	EVM (19-YTD 22)	372,472	24	0.006%	68.8%	31.2%	29.9%	6.67%	29.3	8	21.8%	0.008%	0.0020%	20.7%

To determine the contribution of the enhanced clearance initiative to the observed improvement in outages, we employed a machine learning model (logistic regression) to analyze the relationship between line clearance distance and the probability of tree-caused power outages. The logistic regression model considered various variables that may impact outage probability, and we conducted a sensitivity analysis to examine the effect of line clearance distance on outages while holding other factors constant.

SDG&E analyzed all activities from 2014 to 2022 to understand the relationship between line clearance distance and the probability of tree-caused power outages. We linked each outage event to its corresponding inspection or trim activity to determine the most recent line clearance distance before the outage occurred. The variable "outage" served as the flag variable that was predicted in the model.

The following features were included in the model:

- Species
- Line Clearance Distance
- Enhanced Clearance (yes or no)
- Tree Height
- Diameter at Breast Height (DBH)

To evaluate the performance of the model, the entire dataset was split into training and test data sets. The training set was used to build the model, and the test set was used to evaluate the model's performance on unseen data. Once we understood the model's performance, we altered the line clearance distance in the sensitivity analysis to understand its effect on the predicted probability of outages for each activity.

The sensitivity analysis reduced the line clearance distance of all activities with a line clearance distance above 11 feet (enhanced clearance level) to 11 feet. We then reran these activities through the model using the same threshold value to make predictions. We assumed that the new distribution of activities would have the same performance distribution as the actual data, allowing us to determine the number of outages that were potentially prevented for these trees.

By altering the line clearance distance value, but holding other factors constant, we were able to evaluate the impact of line clearance on tree-related outages. Our results revealed that reducing line clearance from enhanced levels (>11 ft) to regular levels (11 ft) led to an increase in the number of predicted tree-caused outages. Specifically, the model predicted a reduction in tree-related outages by approximately 12% attributed to enhanced clearances.

PG&E

Pacific Gas & Electric (PG&E) launched the Enhanced Vegetation Management (EVM) program in response to changing environmental conditions and based on our best view of risk mitigation at the time. Since launching EVM in 2019, PG&E's wildfire capabilities have continued to evolve and mature; we now have solutions that provide more effective and efficient wildfire risk reduction such as Public Safety Power Shutoff (PSPS), Enhanced Powerline Safety Settings (EPSS), System Hardening and other operational mitigations. We are also evaluating additional operational mitigations, including partial voltage detection, downed conductor detection, and breakaway connectors, each of which will further

reduce the risk of catastrophic wildfires. The data below shows the 2022 non-MED (Major Event Days) Outages performance compared to the 3 Year Average and 2021 has slightly declined.

The good measure is to compare the outages reduction because ignitions are impacted due to other wildfire reduction mitigation.

Data in the table below is not Normalized for Non-MED Outages (i.e., there are more non-MED in 2022 compared to 2021).



Vegetation Outages Review

2022 VEG Outages Compared with 2021 and 3-Year Average

Year	All Outages	Non-MED Outages
2021	7520	3173
3 Year Average (2019-2021)	6567	3355
2022	3850	3524

- 2022 Performance compared to the 3 Year Average and 2021 has slightly declined/slipped.
- There were fewer Major Event Days in 2022.

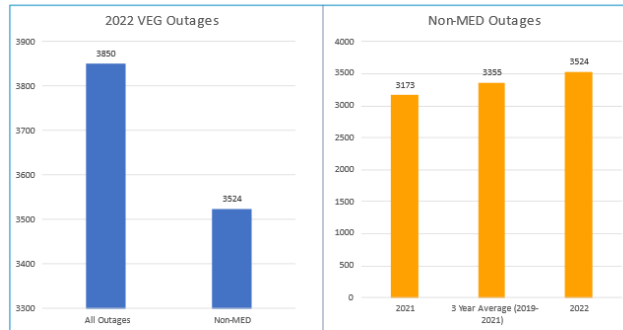

Internal



Dashboard Non-MED Outage Running Total

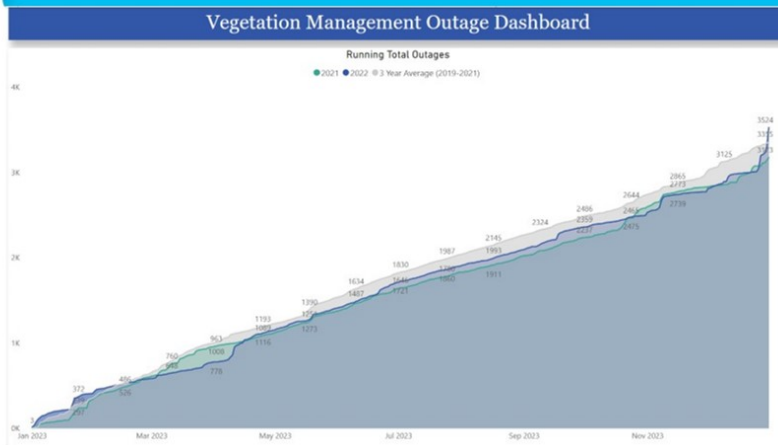



Dashboard All Outage Running Total

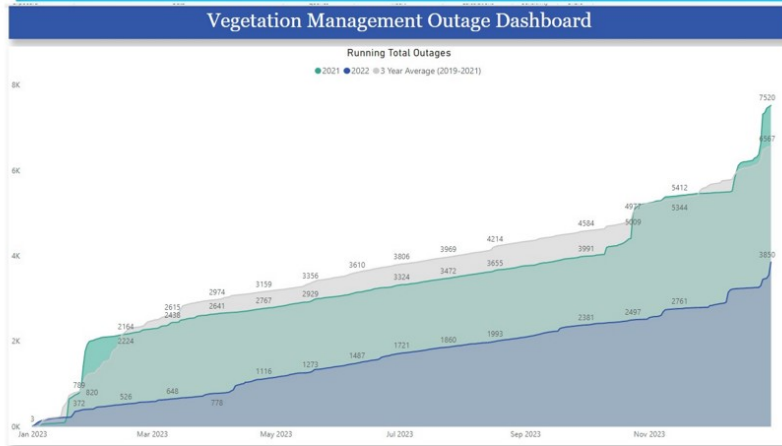

Total Vegetation Outages 2016-2022

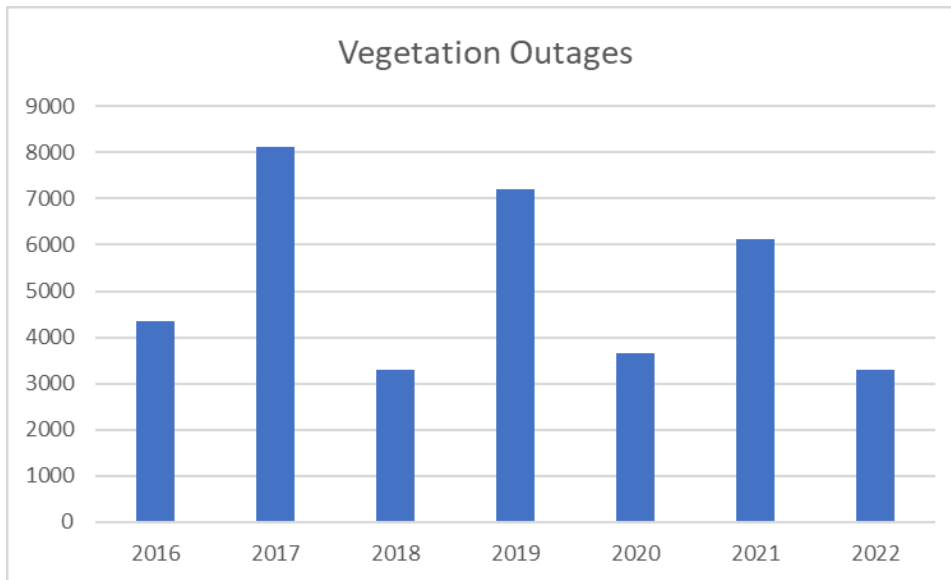

SCE

Beginning in late 2018, SCE began implementing enhanced clearance programs to achieve greater trimming distances consistent with D.17-12-024, which amended GO 95 to increase recommended clearance distances at time of trimming in HFTD. SCE believes that tree-caused circuit interruption (TCCI) data serves as an appropriate data point to use in assessing the impact of SCE’s enhanced clearance programs on reducing the risk of wildfires.

Outage data in Table 1 represents TCCIs on SCE’s distribution system as confirmed through SCE field verification. The data shows a significant decline of 53% in the average annual number of TCCI’s between the pre-enhanced clearance period of 2017 through 2019 compared to 2022. In the pre-enhanced clearance period in SCE’s HFRA, SCE experienced an annual average of approximately 141 TCCIs, while in 2022, the annual number of TCCIs is currently 66, a reduction of approximately 53%.

As of Q4 2022, there were no reported events on SCE’s transmission circuits.

Table 1: Average Events Pre & Post Enhanced Clearances¹

Average Events Pre and Post Enhanced Clearances	Pre-Enhanced Clearances	Post Enhanced Clearances ²	Difference
	Avg of Annual TCCIs (2015-2019)	Annual TCCIs (2022 ³)	
HFTD	141	66	-53%
Non-HFTD	320	160	-50%
All	461	226	-51%

- Notes:** 1) SCE’s TCCI data categorization in this table is grow-in, blow-in and fall-in events with six total fault type categories: Grow-In, Blow-In, Fall-In, Human Caused, No Cause/Not tree related, and Uncategorized. This data excludes Human Caused and No Cause/Not tree related recorded events. SCE has maintained data for annual outages since 2015 and for enhanced clearances since 2020.
 2) While SCE began implementing enhanced clearances in 2019, “post-enhanced” is focused on 2022, in consideration of the time required to execute and advance expanded clearance work across SCE’s HFTD.
 3) December 2022 data is subject to change pending final verification.

Though SCE has tracked TCCIs since 2015, advancements in its work management system have allowed SCE to associate specific outage events with the specific tree(s) in its inventory since 2021. With this consideration, SCE’s analysis is currently looking at correlation and expects that more robust regression analysis may be possible in future years. Starting in 2021, SCE’s legacy outage data was updated to newer data collection standards and inputted into Fulcrum, one of SCE’s data collection tools. This additional functionality helps further SCE’s insight into outage events and potentially informs future mitigation strategy.

Additionally, SCE has enhanced the functionality of its outage dashboard to facilitate a more holistic view of TCCIs across the system. The dashboard provides insight into TCCI trending as well as factors that may affect outage frequencies, such as at-risk species, time of year, and related weather events. SCE has actively participated in this joint IOU working group, and appreciates the partnership with all stakeholders involved. Over the next few years, SCE anticipates this effort will yield additional evidence of the impact enhanced clearances have on the reduction of tree-related events.

SCE-22-19 Participation in Vegetation Management Best Management Practices Scoping Meeting

Description: *Vegetation management processes and protocols for the reduction of wildfire risk are not uniform across electrical corporations*

Required Progress: *SCE and all other electrical corporations (not including independent transmission operators) must participate in an Energy Safety-led scoping meeting to discuss how utilities can best learn from each other and future topics to explore regarding vegetation management best management practices for wildfire risk reduction.*

SCE's Response

SCE has participated in a pre-scoping meeting with Energy Safety in advance of the scoping meeting and looks forward to collaborating with Energy Safety and other stakeholders in this effort.

SCE-22-20 Protective Device Settings Sensitivity Impacts

Description: *Although SCE estimates reduced reliability impacts from new sensitivity setting for protective devices, SCE has not performed full analysis on reliability and related public safety impacts for changes to its FCS*

Required Progress: - *Analyze any reliability impacts associated with changes in sensitivity of protective device settings, including a lookback for 2022 performance compared to 2021.*
- *Describe mitigations implemented to reduce reliability impacts of FCS if noticeable impacts are observed.*

SCE's Response:

SCE began its fast curve program in 2018. To measure the reliability impacts from the fast curve program, SCE compares reliability prior to and after fast curve settings (FC settings) have been implemented. For this analysis, SCE used 2015-2017 outage data to create a baseline reliability performance when FC settings were not implemented and compared those data against circuits that had FC settings capabilities as of June 1, 2022. The circuit data from 2015-2017 versus 2022 data was compared between the months of June and October when elevated fire conditions typically require enablement of FC settings across SCE's HFRA. SCE then examined results at the circuit level.

SCE's analysis shows that overall, fast curve installations have not had any significant impact on customer reliability. SCE is further studying the data to understand any anomalies in reliability data occurring at the circuit level; for example, if year-to-year fluctuations in circuit performance are due to asset conditions and other externalities. SCE also believes that wildfire mitigations such as covered conductor and branch line fusing have had positive impacts to circuit outages as circuits with these mitigations generally experience fewer outages compared to pre-mitigation levels.

There has been an increase in customer outage duration from 2020 onward, which has been due to changes in SCE's operating protocols during elevated fire conditions (i.e., recloser blocking and circuit patrols) and not associated with fast curve setting installations. SCE has since implemented changes to these protocols to help mitigate the length of the outages caused by these protocols.

The table below shows the comparison of outage performance from 2018 to 2022 when compared to the annual average from 2015-2017. Performance was also based on the outages seen on the circuits that had FC settings installed by June 1st of their respective year. Performance was also based on the outages seen on the circuits that had FC settings installed by June 1 of their respective year. System level data below on fast curve enabled circuits do not show any drastic changes in outage counts since installation; however, there is an increase seen in duration due to SCE's change in operating protocols in 2020 during elevated fire conditions.

Table ACI 22-01 – Outage Data on Circuits with Fast Curve Enabled

System-Level June to October Data on Circuits where Fast Curve was Enabled						
Category	2015 – 2017 Annual Avg	2018	2019	2020	2021	2022
Outages	781	256	360	536	569	757
Circuits	956	533	757	779	793	956
Outages Per Circuits	0.85	0.50	0.48	0.69	0.72	0.79
Customers Interrupted Per Outage	1,265	1,464	1,484	1,366	1,517	1,540
Customer Minutes of Interruption (CMI) per Outages	58,669	102,332	99,096	160,684	133,212	147,436
CAIDI	46	70	67	118	88	96

By enabling fast curve settings during elevated fire conditions, SCE has not seen an increase in outage impacts. Further, when comparing the fault to ignition ratios for circuits with fast curve enabled to the circuits without fast curves, SCE has seen a significant decrease in the fault to ignition ratios. To measure wildfire ignition risk reduction, SCE evaluated fault-to-ignition ratios from June to October in 2021 and 2022 with the analysis indicating approximately a ~54% reduction between circuits with fast curve enabled (FC Circuits) versus circuits with without fast curve (Non-FC Circuit) as provided through the chart below.

Table ACI 22-02 – Fault to Ignition Ratio Comparison

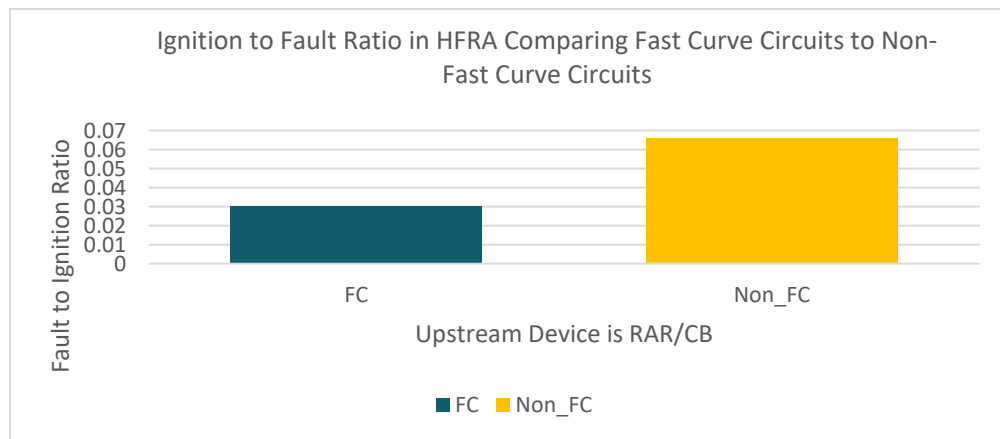

SCE will continue to monitor the performance on circuits with FC settings enabled and perform analysis to understand the reliability impacts and the mitigation effectiveness of the activity in mitigating potential ignitions.

SCE-22-21 Documentation of Models

Description: *SCE does not provide sufficiently detailed information on models*

Required Progress: *SCE's 2023 WMP submission must follow the appropriate template provided in the 2023 WMP Guidelines for the metrics and underlying data section when documenting the models described in section 7.3.7.3 of its 2022 Update submission*

SCE's Response

SCE has followed the appropriate templates provided in the 2023 WMP guidelines related to the documentation of our models. This information can be largely found in Section 6 and Appendix B of this WMP, which requires SCE to provide details on risk frameworks, components, scenarios, QA/QC procedures, and calculation methodologies. SCE is committed to adhering to Energy Safety guidelines and providing straightforward and transparent information on its risk models and approaches. SCE will continue to partner with Energy Safety and stakeholders, especially through forums such as the Risk Modeling Working Group.

SCE-22-22 Third Party Confirmation of RSE Estimates

Description: *SCE does not confirm its RSE estimates with independent experts or other utilities in California*

Required Progress: *In its 2023 WMP, SCE must show that its RSE estimates are confirmed by a third party or detail an action plan and associated timeline for third party confirmation of all RSE estimates.*

SCE's Response

SCE performed a competitive solicitation to select an independent third-party expert to confirm its RSE estimates. Exponent was selected following the solicitation.

Exponent reviewed SCE's RSE process, including inputs, calculations, and results for reasonableness and accuracy. Exponent attended challenge sessions in which SCE management reviewed and validated RSE assumptions and preliminary results for all scored mitigation activities.

Additionally, Exponent performed validation of RSE accuracy by independently calculating the RSEs for comparison to SCE's results. Exponent provided SCE with its findings and recommendations for potential improvements related to RSE data, assumptions, processes, and methodologies, as applicable.

SCE has incorporated Exponent's findings to the extent feasible and will continue to evaluate longer-term recommendations for ongoing improvement of the overall RSEs.

SCE-22-23 RSE Estimates of Emerging Initiatives

Description: SCE does not calculate RSE estimates for emerging initiatives

Required Progress: In its 2023 WMP, SCE must detail an action plan for calculating RSE estimates for emerging initiatives.

SCE's Response

RSE is a tool to compare the benefits and costs across mitigation activities. The purpose of a pilot or emerging technology program is to evaluate activities and technologies in which the benefits are unknown or uncertain. Hence, it is challenging to develop risk reduction and cost estimates with a meaningful level of confidence.

Nevertheless, SCE provides RSEs for its emerging initiatives, which can serve as one of many factors to inform SCE's implementation. Instead of laying out an action plan for calculating RSE estimates for emerging initiatives, SCE has developed RSE estimates for the emerging initiatives found in its 2023 – 2025 WMP.

Table ACI 22-01 below contains a list of emerging initiatives and the resulting RSE.

Initiative	2023-2025 RSE ³¹⁰	WMP Reference
Transmission Open Phase Detection (TOPD): SH-8	1,795	8.3.3.1.2.1; 8.1.8.1.3.2
Distribution Open Phase Detection (DOPD)	1,994	8.3.3.1.2.2; 8.1.8.1.3.3
High Impedance (Hi-Z) Relays	6,210	8.3.3.1.2.3; 8.1.8.1.3.1
FR Wrap Retrofit	95	8.1.2.3.2
Early Fault Detection (EFD): SA-11	5,778	8.3.3.1.1
Satellite and Other Imaging Technology for Fire Spotting (part of SA-10)	40	8.3.4.1.2

³¹⁰ RSEs are a point in time estimate and may be updated to reflect changes in scope, cost and effectiveness based on new information.

SCE-22-24 RSE Estimates Used for Capital Allocation

Description: *SCE does not use RSE estimates as a factor for determining capital allocation across its portfolio of mitigation measures (e.g., prioritizing between vegetation management and grid hardening)*

Required Progress: *In its 2023 WMP, SCE must show that it is using RSE estimates to determine capital allocation across its portfolio of mitigation measures or detail an action plan and associated timeline for using RSE estimates to determine portfolio-level periodization.*

SCE's Response

RSE represents a relative measure of estimated cost-effectiveness for actions a utility takes to mitigate a specific risk. RSE scores may offer certain insights into how effective a mitigation appears to be in reducing risk at a system or portfolio level, while providing guidance on how effective new mitigations may appear to be.

RSEs continue to be an important factor in SCE's decision-making process for how to allocate scarce resources across its portfolio of mitigation measures. As is evident from SCE's response to SCE-22-22 and SCE-22-23, SCE has increased the scope of RSE measurement since its 2022 WMP and has taken definitive steps to further validate and refine its approach to RSE development and evaluation through the use of a third-party, independent evaluator.

It is important to recognize that RSEs are not and should not be the only factor used to develop a proposed risk mitigation plan. The RSE metric does not take into account certain operational realities, resource constraints, and other factors that SCE must consider in developing its mitigation plan. For example, if one were to consider PSPS as an ignition mitigation that hypothetically had a very high RSE score, there are critical practical and regulatory limits to how much PSPS can be deployed. SCE tries to minimize the use of PSPS given the hardships they cause for our customers. The California Public Utilities Commission expressly prescribes that PSPS should be used "as a last resort" despite any relatively high RSE.³¹¹

Accordingly, to address the most pressing safety risks facing SCE, SCE develops a comprehensive and balanced mitigation plan with activities that will collectively reduce the greatest amount of risk in the shortest amount of time, considering RSE, as well as various regulatory, operational, resource, and cost constraints. To do otherwise would not be prudent. For example, it would be inappropriate to implement a comprehensive wildfire risk mitigation plan based solely on RSEs, which would likely lead to significant parts of the system and potentially significant risk issues being left unaddressed.

SCE developed RSEs to help inform the portfolio of mitigation initiatives in SCE's 2023-2025 WMP, but notes that RSE values were not the sole barometer when making operational decisions and prioritizing mitigation efforts. SCE discusses its risk-informed decision-making process in more detail in Section 7 of this WMP.

Use of RSEs in Development of SCE's 2023 – 2025 WMP

SCE made meaningful progress incorporating RSEs into the capital allocation process for its 2023 – 2025 WMP. First, SCE refreshed and refined the inputs used to calculate RSEs for mitigations with existing RSEs, including driver and sub-driver data, consequence impacts, scope and cost forecasts, and other

³¹¹ See D.21-06-034, p. 17, *citing* D.19-05-042, Appendix A at A1; D. 20-05-051, Appendix A at 9.

factors. Second, SCE developed new RSEs for mitigation initiatives not previously scored or new for considered into SCE's 2023 – 2025 WMP. The development of RSE input data was led by SCE's engineering and technical experts and generally based first on data and analytics from system and asset operations, and then supplemented by technical expertise.

SCE then calibrated and challenged the RSEs developed by these experts in a series of challenge sessions with SCE management, where the overall RSE scores and assumptions were evaluated, and action items were taken to further analyze and improve RSE scores. To enhance this evaluation, SCE developed a dashboard to visually display RSE information and enhance information sharing across relevant internal stakeholders. This dashboard allowed stakeholders to compare and contrast input data, assumptions, mitigation effectiveness factors, risk reduction, and several other data points to better understand and pressure-test the RSE scores. In addition, this tool was made available to business line planning teams to help inform their portfolio planning discussions.

As RSEs were refined, they were presented to senior leadership during various executive leadership scope and strategy sessions for final review and approval. As part of those discussions, management requested operational teams to further review scope/implementation plans for select mitigations based on the RSE to ensure appropriate portfolio optimization.

As Energy Safety notes in its final Technical Guidelines for the 2023 – 2025 WMPs, the California Public Utilities Commission is in the process of re-evaluating the appropriate metric to use to evaluate the efficiency and effectiveness of mitigation initiatives. SCE will modify its use of RSEs in accordance with the developments of that process, which may likely result in a change to how the RSE is calculated, and how it is ultimately used. SCE intends to build upon its efforts for this WMP to use RSEs to help inform capital allocation across our 2023 – 2025 wildfire mitigation portfolio in concert with those changes.

SCE-22-25 Increasing PSPS Thresholds on Hardened Circuits

Description: SCE indicated it will gradually include the benefits of hardened circuits as inputs to its PSPS consequence model. However, SCE included no specific timeframe for when it will raise thresholds.

Required Progress: In its 2023 WMP, SCE must report on whether higher PSPS thresholds were adopted as a result of grid hardening measures. If so, SCE should confirm which circuits benefited and provide details on the extent to which PSPS thresholds were raised.

SCE must clarify in its 2023 WMP whether higher PSPS thresholds were adopted prior to September 30, 2022, for potential use during the time of year when dry, windy weather conditions, combined with a heightened fire risk, are most often forecasted to drive need for PSPS events. If it has not raised thresholds, SCE must explain why and by when it will include raised thresholds.

SCE's Response

SCE may elect to raise individual circuit or circuit segment thresholds when sufficient grid hardening (primarily covered conductor) has been installed or through the circuit exception process.³¹² In these instances, SCE may raise wind speed thresholds to 40mph sustained winds or 58mph gusts, which aligns with the National Weather Service high wind warning level for wind speeds at which infrastructure damage may occur. SCE is considering the creation of a new modeling criteria that would change how and where elevated thresholds are set. See SCE-22-26 for more detail.

As a result of SCE's grid hardening efforts and exception process, which are both targeted to reduce PSPS impacts, SCE raised wind speed thresholds to the higher National Weather Service High Wind Warning values on part or all of the following circuits as of September 30, 2022:

- Acosta
- Ambercrest
- Anaconda

³¹² SCE removes circuit segments from PSPS protocols in situations where persistent or prevalent wildfire risk associated with these segments are temporarily abated or no longer exist, through a circuit exception process. While the potential for reducing PSPS based on circuit exceptions is much more limited than grid hardening activities, the exception process does not require installation or replacement of assets and, therefore, analysis and application of this option can typically be performed quicker than grid hardening activities when the latest information supports such exceptions. The circuit exception review process begins when SCE personnel identify a line segment which—despite being located in HFRA—might currently pose a very low risk for wildfire ignition or fire spread. For example, a portion of a circuit found to be traversing over a recent burn scar may be a candidate for circuit exception. Circuit segments can be identified as candidates for exception review as SCE begins preparing detailed designs for grid hardening activities, or through specific feedback received from field personnel. This process requires current and local knowledge of changing conditions to inform the circuit review process. Identified circuit segments are reviewed by SCE's PSPS operations, fire science, and risk management experts evaluating the circuit segment's unique characteristics (e.g., construction type, outage history) and location characteristics (e.g., fuel quantity, fuel type, fuel dryness, fuel age, history of fires in the area) to determine if that circuit segment can be exempt from PSPS monitoring and de-energization due to low wildfire risk.

- Angus
- Anton
- Arlene
- Avanti
- Balcom
- Barrington
- Big Rock
- Bouquet
- Calstate
- Campanula
- Cassidy
- Coachella
- Cobra
- Conejo
- Condor
- Cuddeback
- Dartmouth
- Duke
- Dysart
- Easter
- Echo
- Fingal
- Frozen
- Galena
- Green River
- Gunsite
- Hillfield
- Mckevett
- Mettler

- Middle Road
- Pheasant
- Python
- Rainbow
- Ranier
- Shovel
- Sand Canyon
- Steel
- Stores
- Tejon Peak
- Vargas
- Vera Cruz
- Whizzin
- Zone

Since September 30, 2022, SCE has also raised wind speed thresholds to the higher NWS High Wind Warning values on part or all of the following four circuits:

- Enchanted
- Jeep
- Julius
- Kickapoo Trail

SCE was also able to raise thresholds on at least 22 other circuits (or segments thereof) prior to the height of the 2022 fire season by either validating the installation of covered conductor upgrades outside of PSPS-Driven Grid Hardening work (formerly SH-7) or through the circuit exception process.

SCE-22-26 PSPS System Damage in Consequence Modeling

Description: *In 2021 field personnel inspecting lines prior to restoring power after PSPS events found 46 incidents of wind-related damage. This damage was on lines de-energized during PSPS events that potentially could have caused ignitions. SCE has not performed consequence modeling based on these damage points to better understand potential incidents that the shutoffs may have prevented.*

Required Progress: *In its 2023 WMP Update, SCE must report on progress to include observed PSPS event damage points as data input into its PSPS consequence models*

SCE's Response

SCE is expecting to solicit proposals this year from external technical firms to develop a defensible methodology for more predictive, risk-driven modeling that can derive wind speed thresholds down to the circuit segment level. This solution may include machine learning (ML) and artificial intelligence (AI) inputs to guide probability of failure determinations as prominent factors for de-energization thresholds. SCE's intention is to include data points from actual historical damage to SCE assets by type, associated wind speed, and more.

SCE's intention is that combining predictive modeling inputs with known historical failures should allow SCE to develop wind speed thresholds that are informed by the conditions that caused PSPS event damage points previously. SCE will develop this new methodology in 2023.

SCE is also evaluating the potential consequences should an ignition have occurred in the 46 incidents in 2021 in which wind-related damage was found after PSPS events. This analysis is underway but not yet complete as SCE is working to make sure that historical conditions for the 46 incidents are correctly accounted for in the consequence modeling. Barring unexpected challenges with the historical data or modeling calculations, SCE plans to complete the analysis by the end of Q2, 2023.

SCE-22-27 Lessons Learned from PSPS Implementation

Description: As identified by SCE in its lessons learned from implementing 2021 PSPS events, SCE noted deficiencies regarding operations in the face of rapidly escalating events. Deficiencies were in the areas of notification and stakeholder engagement, restoration planning, resource availability, customer engagement, communication cadence, and improving forecasting models to improve communications.

Required Progress: In its 2023 WMP Update, SCE must report on progress in the following areas:

- 1) Refining weather forecasting capabilities to improve ability to estimate wind speeds at specific locations where PSPS events have occurred most frequently.
- 2) Using updated air operations training protocols for timely inspections to improve restoration times.
- 3) Addressing gaps in logistics processes through additional staffing resources and other approaches for community resource center/community care vehicle supplies.
- 4) Providing customers more specific and accurate restoration time notification messages.
- 5) Providing sufficient notice for customers to prepare for potential de-energizations without notifying customers who are unlikely to be de-energized (over-notifying vs. under-notifying).
- 6) Refining its weather models to inform customers more accurately of potential de-energization ahead of time.

SCE's Response

1) Refining weather forecasting capabilities to improve ability to estimate wind speeds at specific locations where PSPS events have occurred most frequently.

SCE is in the process of adding machine learning capabilities that incorporate weather station observations to correct bias and improve model forecasts at point locations. SCE selected 64 locations in 2021, adding 500 locations in 2022, with plans to add approximately 600 in 2023. The locations have been prioritized by the frequency of reaching or exceeding PSPS wind speed criteria during low relative humidity conditions. The locations chosen must also have at least six months of observations available in order to train the new models. Please also see SCE's response to ACI SCE-22-08 (Weather Station Improvements) and Section 8.3 (Situational Awareness) for additional details on weather forecasting improvements.

2) Using updated air operations training protocols for timely inspections to improve restoration times.

In 2022, SCE created a PSPS Task Force Job Aid for Rules of Engagement (Job Aid), which includes operations training protocols for inspections to improve restoration time. SCE updated the PSPS Task Force Operations Section Chief and Task Force Unit Leader appendices of this Job Aid to add a protocol to work with the Air Operations Branch Director and Task Force Unit Leader to determine the strategy in positioning air resources (e.g., considering pre-placing aircraft to be closer to de-energized areas) as needed in support of expediting anticipated and/or actual restoration activities. The appendices were also edited to expand on reviewing the staffing strategy utilized before or during Medium and Large

events³¹³, such as requiring additional Task Force Units to be activated to focus on restoration activities and considering whether to activate an Electrical Service IMT Restoration Branch Director to assist with resource procurement and management to aid the Restoration Task Force Unit in restoration.

3) Addressing gaps in logistics processes through additional staffing resources and other approaches for community resource center/community care vehicle supplies.

Community resource center (CRC) and community care vehicle (CCV) logistics gaps have been addressed through: 1) reducing lead time for restocking some items where possible, 2) providing teams with lead times for restocking to inform timely restock ordering, and 3) placing supplies in three separate service centers. SCE has also addressed staffing concerns by establishing a fully rostered field staff and will grow the roster of resources by continuing to recruit for additional resources.

4) Providing customers more specific and accurate restoration time notification messages.

In 2022, SCE started the process to provide more dynamic restoration information on sce.com. Several steps were completed in 2022, including creating notification templates for both customers and public safety partner notifications, creating templated language for sce.com, and creating process flowcharts. However, the complete process was not fully available during the 2022 fire season as SCE continued to automate the restoration data and data flows between the operations and external engagement actions.

The ability to provide more dynamic restoration information is currently limited by technical constraints including a lack of historical predictive data, technical limitations in coordinating individual estimated restoration time (ERT) notifications at the circuit or circuit-segment level given the potential number of circuit segments involved, translation requirements for ad hoc messaging, and due to PSPS outages requiring patrol of the entire length of every de-energized circuit by truck, helicopter, or on foot. In large events, due to the potential size of sustained damage, it is difficult to forecast as time is required not only to patrol the circuits impacted but to remediate any hazards/damages. Additionally, larger events also often involve crews needing to patrol multiple circuits.

5) Providing sufficient notice for customers to prepare for potential de-energizations without notifying customers who are unlikely to be de-energized (over-notifying vs. under-notifying).

SCE continues to enhance operational plans to remove more customers from scope in advance of events, which also reduces over-notification to the customers who are not ultimately switched off of impacted circuits. In 2022, SCE improved weather modeling with the addition of 500 new machine learning models (see response #6 below). Additionally, we have created a program to pre-segment certain circuits in which not all segments are typically impacted similarly to PSPS events. This should remove over-notification on some frequently impacted circuits by allowing us to notify at the circuit-segment level on these circuits.

6) Refining its weather models to inform customers more accurately of potential de-energization ahead of time.

In 2022, a total of 500 new machine learning model forecast locations were developed to improve wind

³¹³ SCE defines small events as less than 25 circuits; medium events as 25 to 75 circuits; large events as 75 or more circuits.

speed and wind gust forecasts at select point locations. These more accurate forecasts will help better identify which customers may be subject to potential proactive de-energizations ahead of a PSPS event. The new machine learning capabilities also provide probabilistic forecasts, which allow SCE to better plan around forecast uncertainties and are intended to lead to better notification accuracy through advanced lead time. SCE will continue to prioritize the development of new machine learning forecasts in 2023 with between 500 - 600 new forecast locations expected based on available data. Even though SCE runs multiple sophisticated weather models and has added new machine learning capabilities, no forecast is perfect due to limitations in the science of numerical weather prediction and the uncertainty of weather. The California Public Utilities Commission has recognized the impact of weather forecasting limitations on the IOUs' ability to provide advance notifications. See, e.g., D.19-05-042, pp. 86, A7-A8, which states, "Recognizing that there may be times when advance notice is not possible due to emergency conditions beyond the electric investor-owned utilities' control, the electric investor-owned utilities must, whenever possible, provide advance notification"; "Electric investor-owned utilities should, whenever possible, adhere to the [] minimum notification timeline" (emphasis added).

APPENDIX E: REFERENCED REGULATIONS, CODES, AND STANDARDS

In this appendix, the electrical corporation must provide in tabulated format a list of referenced codes, regulations, and standards. An example follows.

Name of Regulation, Code, or Standard	Brief Description
14 C.F.R. § 107, et seq.	FAA certification for Unmanned Aircraft Systems & pilots
14 C.F.R. § 133, et seq.	Rotorcraft External-Load Operations
14 C.F.R. § 61, et seq.	FAA Certification: Pilots, Flight Instructors, and Ground Instructors
14 C.F.R. § 91, et seq.	General Operating and Flight Rules
16 U.S.C. § 1362 et seq. (Marine Mammal Protection Act (MMPA))	Protects endangered marine mammals
16 U.S.C. § 1451 et seq. (Federal Coastal Zone Management Act)	Bureau of Ocean Energy Management- protection, management, and development of the coastal zone
16 U.S.C. § 1451 et seq. (Federal Coastal Zone Management Act)	protect the coastal environment from growing demands associated with residential, recreational, commercial, and industrial uses
16 U.S.C. § 668 et seq. (Bald and Golden Eagle Protection Act (BGEPA))	prohibits anyone from "taking" bald or golden eagles, including their parts, including feathers, nests, or eggs.
16 U.S.C. § 703 et seq. (Migratory Bird Treaty Act (MBTA))	Outlaws the taking, killing, or possessing migratory birds
16 U.S.C. §§ 1531-1544 (Federal Endangered Species Act of 1973(ESA))	provide a means whereby the ecosystems upon which endangered species and threatened species may be conserved
16 U.S.C. §§ 470aa–470mm (Archaeological Resources Protection Act (ARPA))	Protection of archaeological resources and sites which are on public lands and Indian lands
16 U.S.C. §§ 470aaa-470aaa-11 (Paleontological Resources Preservation Act (PRPA))	provides specific mandates for administering paleontological resource research and collecting permits and the curation of fossil specimens in museum collections
25 U.S.C. § 3001 et seq. (Native American Graves Repatriation Protection Act (NAGRPA))	Gives rights of Indian tribes to obtain repatriation of human remains, funerary objects, sacred objects, and objects of cultural patrimony from federal agencies and museums.
33 U.S.C. §§ 1251-1388 (Federal Clean Water Act (CWA))	establishes the basic structure for regulating discharges of pollutants into the waters of the United States and regulating quality standards for surface waters.
42 U.S.C § 4321 et seq. (National Environmental Policy Act (NEPA))	policy to encourage harmony between man and his environment; promote efforts to prevent or eliminate damage to the environment; stimulate health and welfare of man; enrich understanding of ecological systems and natural resources; and to establish a Council on Environmental Quality
54 U.S.C. §§ 300101-307108 (National Historic Preservation Act (NHPA))	Preservation policy for historic property

Name of Regulation, Code, or Standard	Brief Description
54 U.S.C.§§ 320301-320303 (Antiquities Act of 1906)	provide general legal protection of cultural and natural resources of historic or scientific interest on Federal lands
A.22-05-013	Risk Assessment Mitigation Phase Proceeding (RAMP)
AB 1054 (2019)	Rules for reviewing and setting of HFTD boundaries every year
AB 2911 (2018)	Identification of fire districts without a secondary egress route that are at significant fire risk
AB 52 (2014)	California Assembly bill requiring that a project with an effect that may cause a substantial adverse change in the significance of a tribal cultural resource and requires consultation with Native American under CEQA
California Code of Regulations, Title 13, §§ 2450 - 2465	Portable Equipment Registration Program (PERP) and Portable Engine Airborne Toxic Control Measure
California Code of Regulations, Title 14, § 15268(d)	Definition of “ministerial projects”
California Code of Regulations, Title 14, § 15381	Definition of “responsible agency”
California Code of Regulations, Title 14, §§ 1250 - 1258	provide specific exemptions from: electric pole and tower firebreak clearance standards, electric conductor clearance standards and to specify when and where the standards apply.
California Environmental Quality Act (CEQA)	requires public agencies to “look before they leap” and consider the environmental consequences of their discretionary actions
California Fish and Game Code §§ 1600 - 1616	Protection and conservation of the fish and wildlife resources in lakes and streams
California Fish and Game Code § 2050 et seq. (California Endangered Species Act (CESA))	Legislation to conserve, protect, restore, and enhance any endangered species or any threatened species and its habitat
California Fish and Game Code § 2080 et seq.	California Endangered Species Act - prohibition of trading endangered or threatened species
California Fish and Game Code § 3503	Prohibits destruction of bird nests and eggs
California Fish and Game Code § 3503.5	Prohibits possession or destruction of birds-of-prey
California Fish and Game Code § 3511	Prohibits possession of fully protected birds without a license
California Fish and Game Code § 3513	Prohibits possession of migratory nongame bird as designated in the Federal Migratory Bird Treaty Act (16 U.S.C. Sec. 703 et seq.)
California Fish and Game Code § 3800	Definition of nongame birds and mining regulation affecting same
California Fish and Game Code § 4700	Definition of fully protected mammals
California Fish and Game Code § 5050	Protection of reptiles and amphibians
California Fish and Game Code § 5515	Definition of fully protected fish and possession prohibition
California Fish and Game Code §§ 1900-1913 (Native Plant Protection Act)	Preservation, protection and enhancement of endangered or rare native plants of California

Name of Regulation, Code, or Standard	Brief Description
California Fish and Game Code §§ 5650 - 5652	Prohibit the deposition, passage of, or disposal of deleterious materials into the waters of the state, or within 150 feet of the highwater mark of waters of the state
California Food and Agriculture Code §§ 80001-80201 (California Desert Native Plants Act)	Protection of native plants from unlawful harvesting on both public and privately owned lands
California Government Code § 8593.3(f)(1)	Definition of access and functional population
California Health and Safety Code §§ 39000 - 44474	Protection of ambient air quality, control, and maintenance
California Public Resources Code § 21069	Definition of “responsible agency,” “ministerial projects” and the Endangered Species Act
California Public Resources Code § 21080.3.2	California Environmental Quality Act permits mitigation measures capable of lessening impacts to a tribal cultural resource
California Public Resources Code § 30000, et seq. (California Coastal Act)	California Coastal Commission rules including delegation of Local Coastal Programs (LCPs) to cities and counties and guides how the land along the coast of California is developed, or protected from development
California Public Resources Code § 4290.5	Identification of fire districts without a secondary egress route that are at significant fire risk
California Public Resources Code § 4291	defensible space requirement for land covered in flammable material
California Public Resources Code § 4292	Clearance requirements around structures
California Public Resources Code § 4293	maintain a clearance of the respective distances which are specified in this section in all directions between all vegetation and all conductors which are carrying electric current; Mitigation requirement of hazards posed by dead trees or significantly compromised and maintenance of clearance of the respective distances from power lines
California Public Utilities Code § 326(a)(2)	Meaning of “maximum feasible”
California Public Utilities Code § 8386(a)	Electrical corporation’s duty to minimize catastrophic wildfires
California Water Code § 13000, et seq. (California Porter-Cologne Water Quality Control Act)	Conservation, control, and utilization of the water resources of the state, and quality protection. Water Quality Control Board including multiple Regional Water Quality Control Boards
D.12-01-032	Decision adopting regulations to reduce fire hazards associated with overhead power lines and communication facilities; and decision approving the work plan for the development of fire map 1
D.12-04-024	Decision re Electric Investor Owned Utilities reporting requirements for Resolution ESRB-8 Extending De-Energization Reasonableness, Notification, Mitigation.

Name of Regulation, Code, or Standard	Brief Description
D.14-01-010	Decision adopting regulations to reduce fire hazards associated with overhead power lines and communication facilities; and decision approving the work plan for the development of fire map 1
D.15-05-006	Decision modifying HFTD boundaries in SCE's territory
D.17-12-024	Decision adopting regulations to enhance fire safety in the HFTD
D.18-12-014	Adoption of 2018 Safety Model Assessment Proceeding (S-MAP)
D.19-05-042	PSPS Order Instituting Rulemaking (OIR) Phase 1
D.20-05-051	PSPS Order Instituting Rulemaking (OIR) Phase 2
D.20-05-051	Implementation of pilot projects to investigate the feasibility of mobile EV Level 3 fast charging for areas impacted by PSPS events.
D.20-05-051	quarterly meetings to provide updates on PSPS enhancement efforts and solicit input for improvement areas in how SCE approaches PSPS overall and provides a forum for stakeholders to propose ways to improve all aspects of PSPS
D.20-08-046	Climate Adaptation Vulnerability Assessment: utilities to study climate risks to their assets, operations, and services and to file the assessment results one year before their GRC to enable the results of the assessment to inform GRC requests
D.20-12-030	Decision modifying the high fire-threat district boundaries in SCE service territory
D.21-06-014	PSPS Order Instituting Investigation
D.21-06-034	PSPS Order Instituting Rulemaking (OIR) Phase 3
GO 128	Rules for construction of underground electric supply and communication systems.
GO 165	Inspection Requirements for Electric Distribution and Transmission Facilities
GO 166	Standards for Operation, Reliability, and Safety during Emergencies and Disasters
GO 167-B	Enforcement of Maintenance and Operation Standards for Electric Generating Facilities.
GO 174	Rules for Electric Utility Substations, governing standards for substation inspection and management
GO 95	Public Utilities Commission Rules for Overhead Electric Line Construction
GO 95 Rule 37	Minimum Clearances of Wires above Railroads, Thoroughfares, Buildings, Etc.
GO 95, Appendix E	Specifies increased time-of-trim clearances between bare-line conductors and vegetation.
GO 95, Rule 18	Prioritization of maintenance utilizing a three-tier priority maintenance system

Name of Regulation, Code, or Standard	Brief Description
GO 95, Rule 18A	Requires electric utilities to place a high priority on the correction of significant fire hazards.
GO 95, Rule 22.8-A, 22.8-B, 22.8-Cor22.8-D	Meaning of "Protective Covering, Suitable" and minimum standards for ground/bond wire, supply conductor, bolt covers, insulated flexible conduit
GO 95, Rule 31.1	Design, Construction and Maintenance of overhead lines
GO 95, Rule 35	Mitigation requirement of hazards posed by dead trees or significantly compromised. Mandate for removal of dead trees that overhang or lean toward a supply line; Mandates vegetation management to prevent encroachment into Clearance Zones
GO 95, Rule 35 Appendix E	Specifies vegetation management expanded clearances, Grid Resiliency Clearance Distance (GRCD)
GO 95, Rule 35, Table 1, Case 14	requires increased radial clearances between bare-line conductors and vegetation in high fire-threat areas of Southern California.
GO 95, Rule 44.2	Ad hoc inspections through IPI program
GO 95, Rules 31.2, 80.1A and 90.1B	sets the minimum frequency for inspections of aerial communication facilities located in close proximity to power lines.
GO 95, Sections V, VI, VII, VIII, X & XI	Height of Electrical Equipment in the Service Territory
I.14-03-004	Order Instituting Investigation on the Commission's Own Motion into the Operations and Practices of SCE Regarding the Acacia Avenue Triple Electrocution Incident in San Bernardino County and the Windstorm of 2011
Material Specifications 454	SCE's inspection and treatment of wood poles in service. Details on how to do intrusive inspection and the criteria for passing/failing of poles
R.08-11-005	Decision adopting regulations to reduce fire hazards associated with overhead power lines and communication facilities; and decision approving the work plan for the development of fire map 1
R.08-11-005	Order Instituting Rulemaking to Revise and Clarify Commission Regulations Relating to the Safety of Electric Utility and Communications Infrastructure Provider Facilities.
R.15-05-006	Order Instituting Rulemaking to Develop and Adopt Fire-Threat Maps and Fire-Safety Regulations.
R.18-04-019	Order Instituting Rulemaking to Consider Strategies and Guidance for Climate Change Adaptation
R.19-09-009	Order Instituting Rulemaking Regarding Microgrids Pursuant to Senate Bill 1339 and Resiliency Strategies
R.20-07-013	CPUC Order Instituting Rulemaking to Further Develop a Risk-Based Decision-Making Framework

Name of Regulation, Code, or Standard	Brief Description
	for Electric and Gas Utilities
R.20-07-013	Order Instituting Rulemaking to Further Develop a Risk-Based Decision-Making Framework for Electric and Gas Utilities
Resolution ESRB-4	Mitigation requirement of hazards posed by dead trees or significantly compromised. Directs Investor Owned Electric Utilities to take remedial measures to reduce the likelihood of fires started by or threatening utility facilities.
Resolution ESRB-8	Resolution Extending De-Energization Reasonableness, Notification, Mitigation, and Reporting Requirements in Decision 12-04-024 to All Electric Investor Owned Utilities
Resolution SED-5 and SED-5A	Resolution approving administrative consent order and agreement of the Safety and Enforcement Division and SCE regarding the 2017/2018 Southern California fires pursuant to Resolution M-4846
SB 901 (2018)	Senate bill requiring IOUs to file Wildfire Mitigation Plans.
Substation Construction and Maintenance; Maintenance and Inspection Manual	Policies and procedures for substation inspections and maintenance
System Operating Bulletin 21	System Emergency Response Plan
System Operating Bulletin 322	SCE's Standard Operating Bulletin criteria for FCZ, FWT, HFRA, PSPS & TT
Various Encroachment Permits	Permitting governed by CA Dept. of Transportation, CA Dept. Water Resources

APPENDIX F: SUPPLEMENTAL INFORMATION

F1: Continuation of Section 5 - Overview of Service Territory

Below is a list of the WMP Guidelines sections which require additional graphs or maps:

Section Number	Section Title
5.3.4.1 General Climate Conditions	General Climate Conditions
5.3.4.2 Climate Change Phenomena and Trends	Climate Change Phenomena and Trends

Below are the additional graphs.

5.3.4.1 General Climate Conditions

SCE provides graphs for 11 fire climate zones (FCZ) on the “Temperature & Precipitation”. Figure 5-2 in Section 0 provides the temperature and precipitation from 1980 to 2021. The additional ten figures reflecting this information are provided below. Figures are as of 10/26/2022 and the data source is from the 40-year internal dataset. Data source is from SCE’s 40-year internal dataset which was generated by third party vendor, Atmospheric Data Solutions (ADS) by downscaling the Climate Forecast System Reanalysis (CFSR) data which comes from the National Center for Atmospheric Research (NCAR).

Figure 5-2-1 - Annual Mean Climatology for SCE Service Territory (FCZ 2 - Inland Valleys)

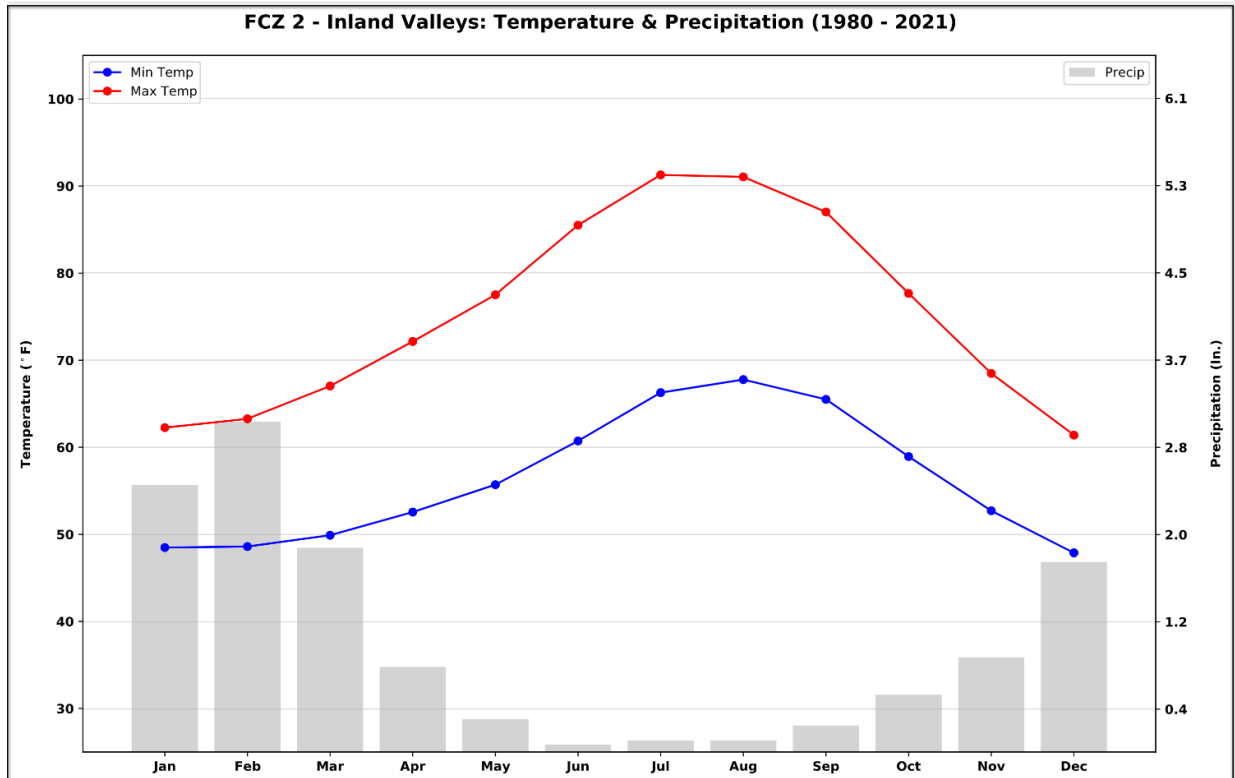

Figure 5-2-2 - Annual Mean Climatology for SCE Service Territory (FCZ 3- Western Mountains)

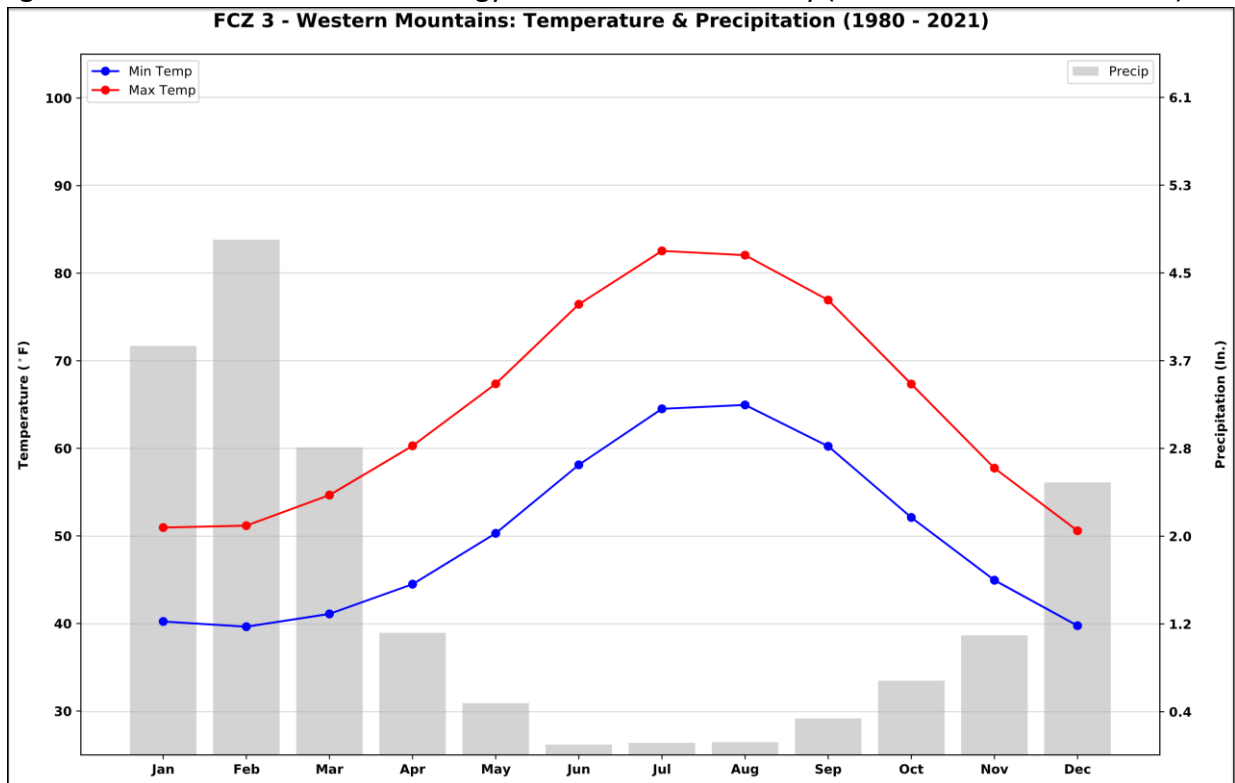

Figure 5-2-3 - Annual Mean Climatology for SCE Service Territory (FCZ 4 - Eastern Mountains)

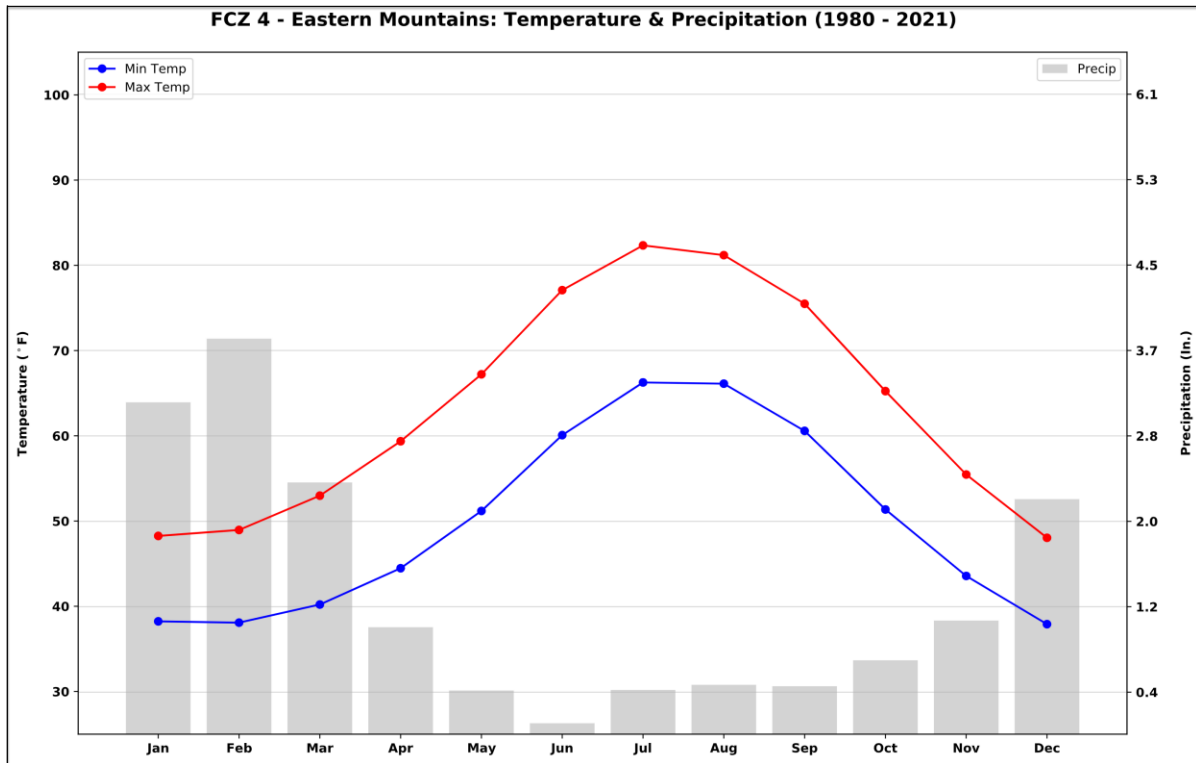

Figure 5-2-4 - Annual Mean Climatology for SCE Service Territory (FCZ 5 - Eastern Desert)

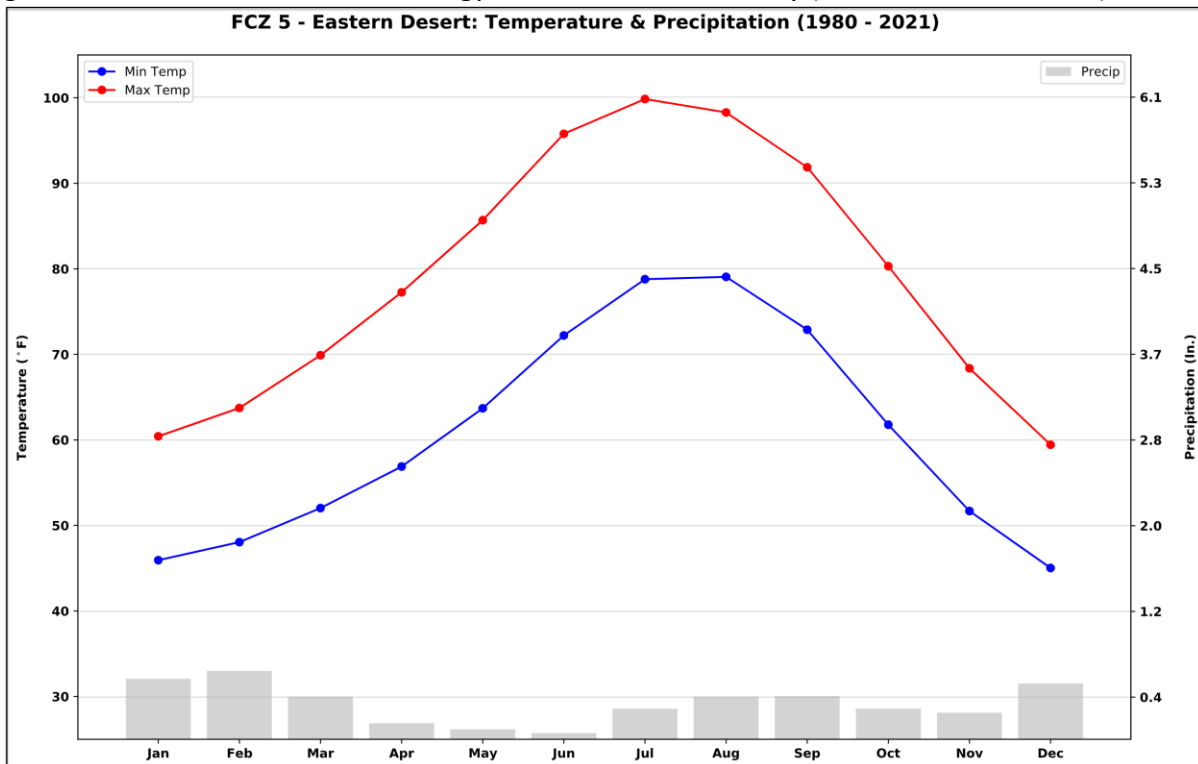

Figure 5-2-5 - Annual Mean Climatology for SCE Service Territory (FCZ 6 - Upper Desert)

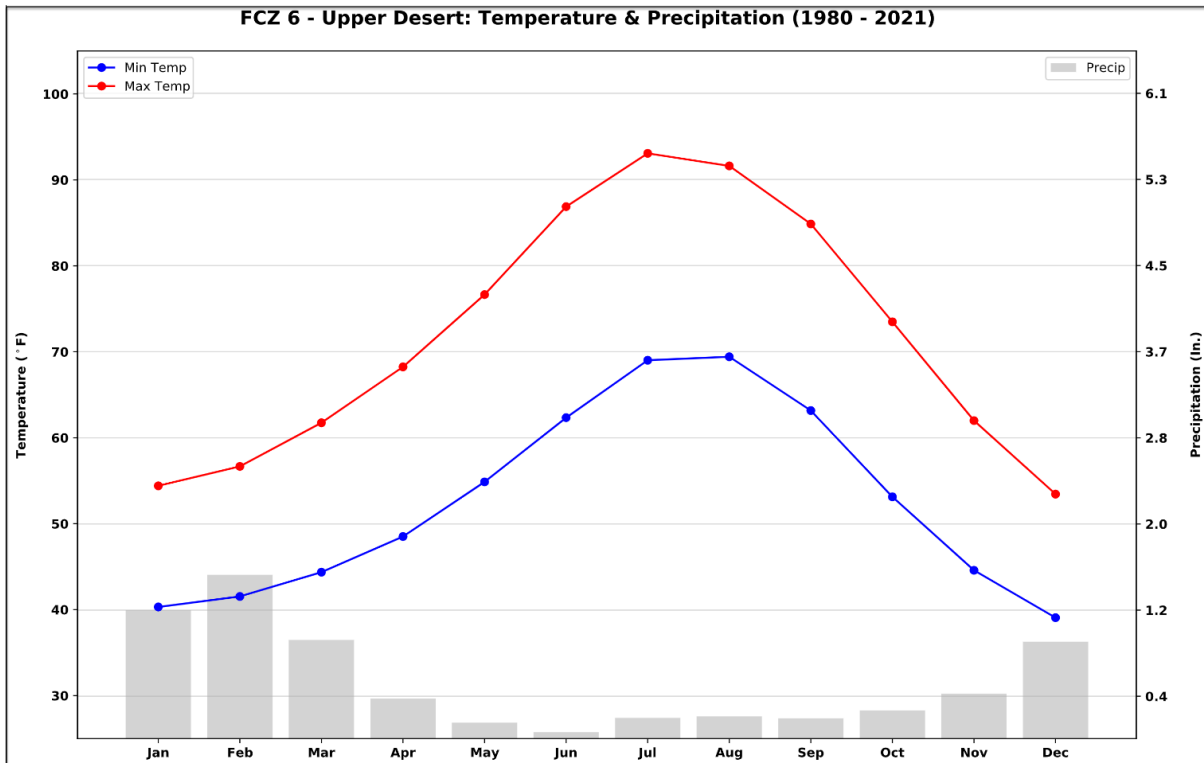

Figure 5-2-6 - Annual Mean Climatology for SCE Service Territory (FCZ 7 - Mojave)

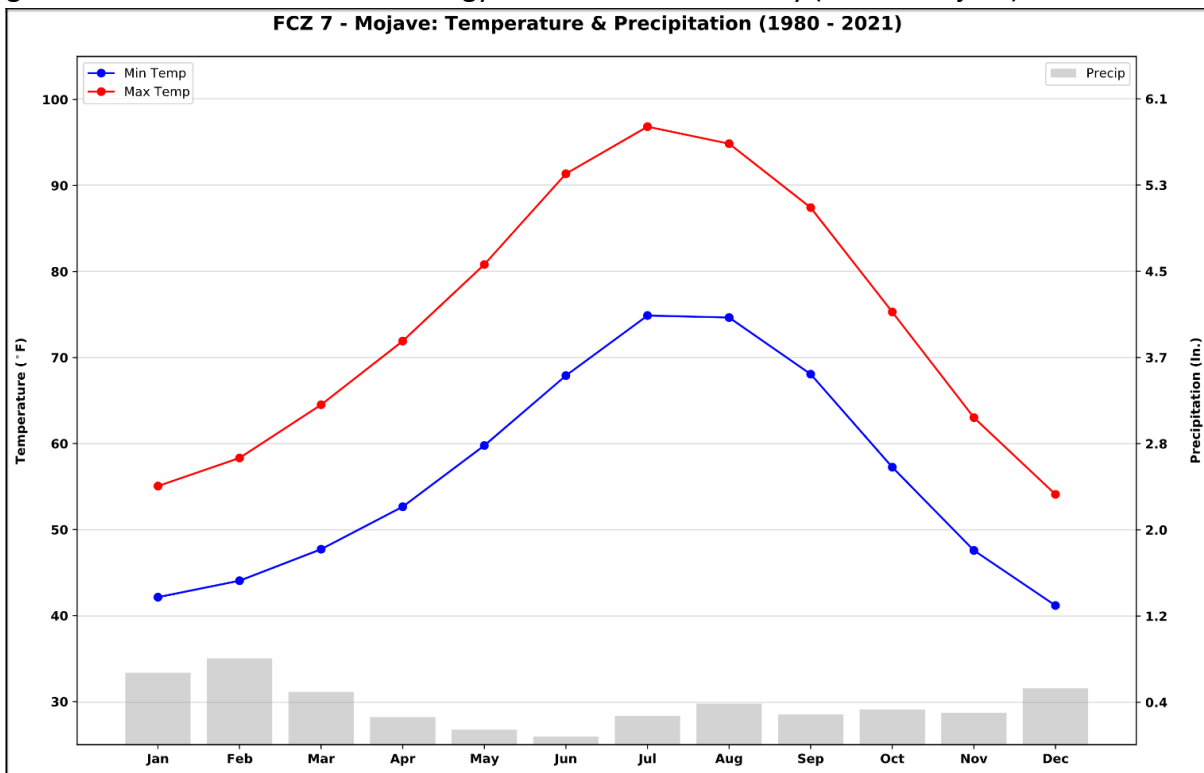

Figure 5-2-7 - Annual Mean Climatology for SCE Service Territory (FCZ 8 – Northern Desert)

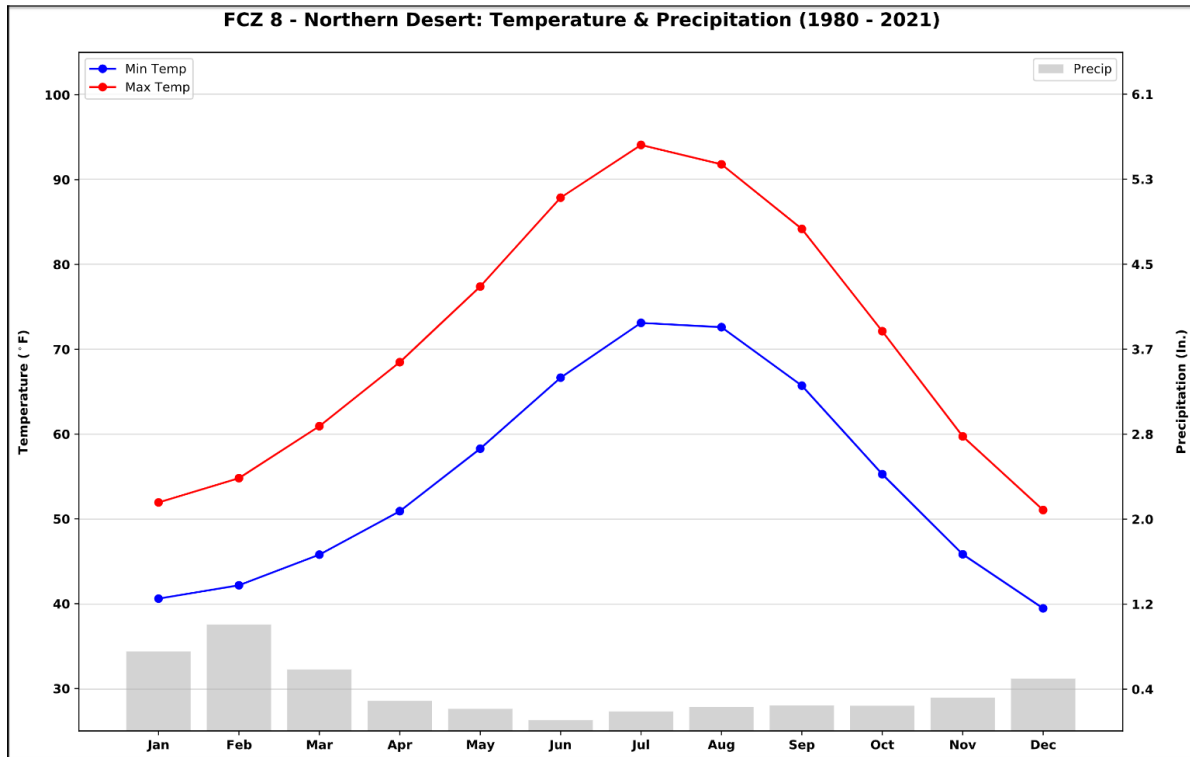

Figure 5-2-8 - Annual Mean Climatology for SCE Service Territory (FCZ 9 – Inyo)

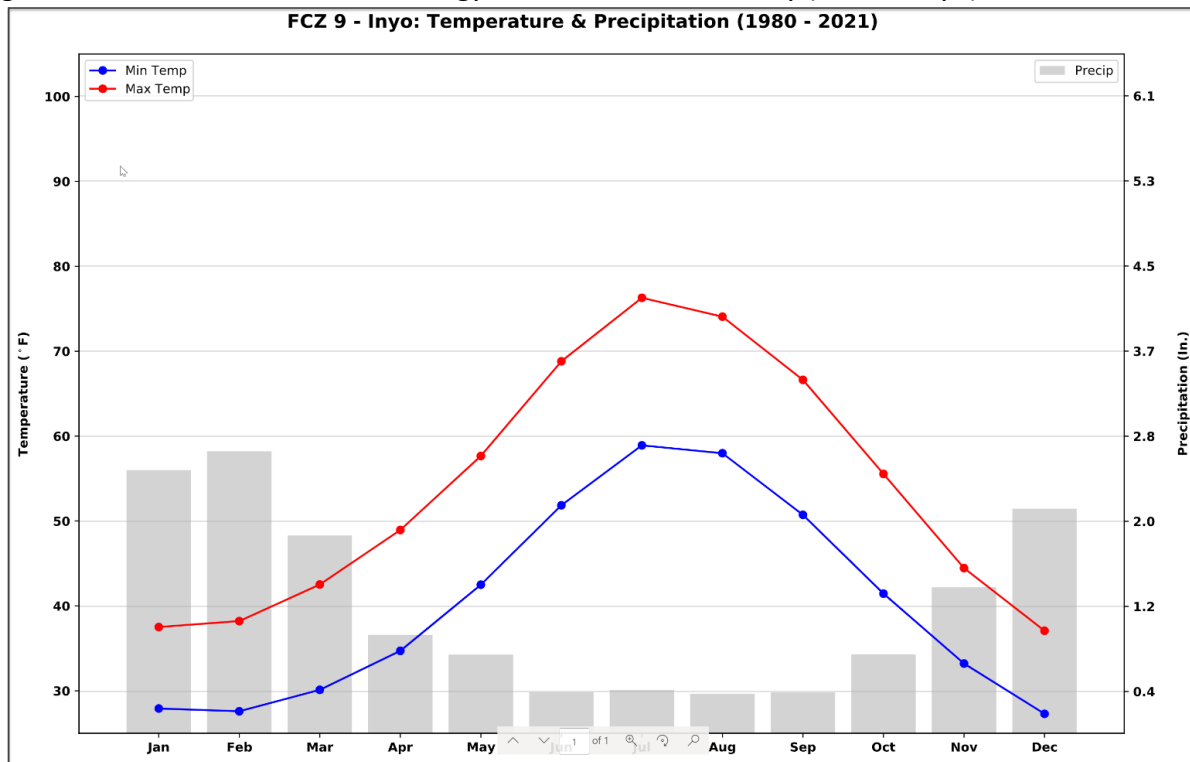

Figure 5-2-9 - Annual Mean Climatology for SCE Service Territory (FCZ 10 – Sierra)

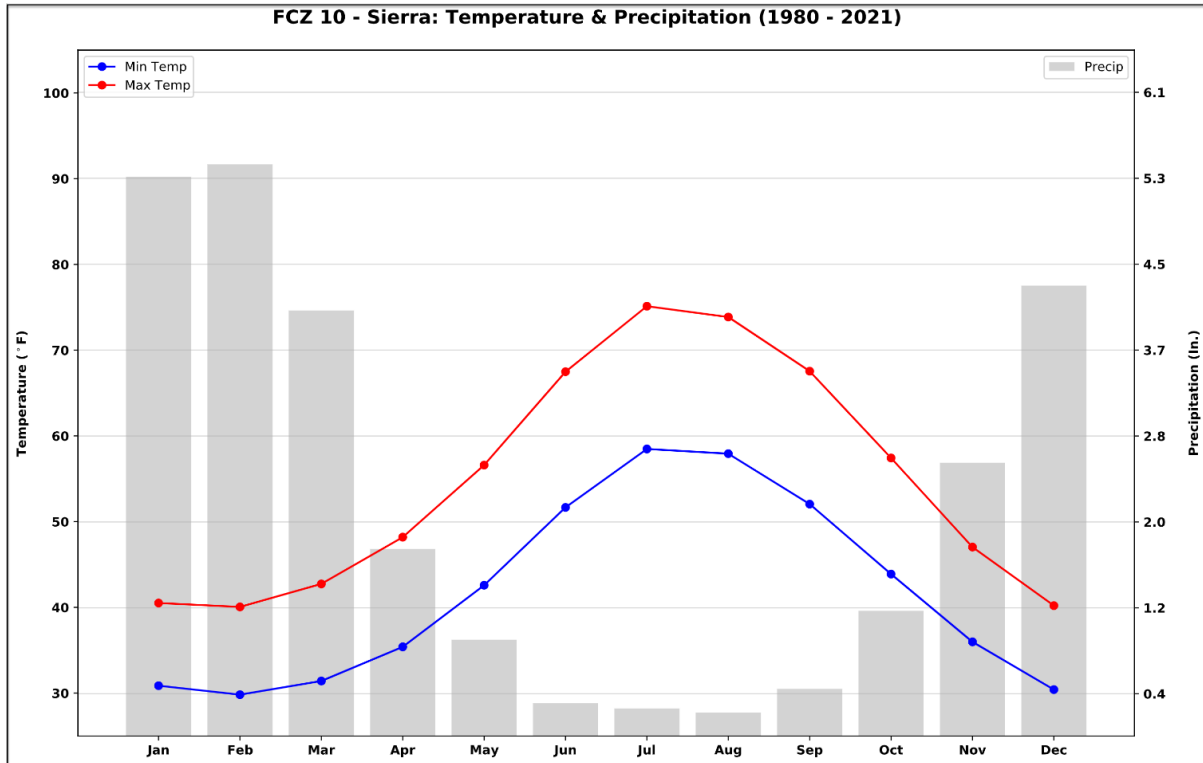

Figure 5-2-10 - Annual Mean Climatology for SCE Service Territory (FCZ 11 – San Joaquin)

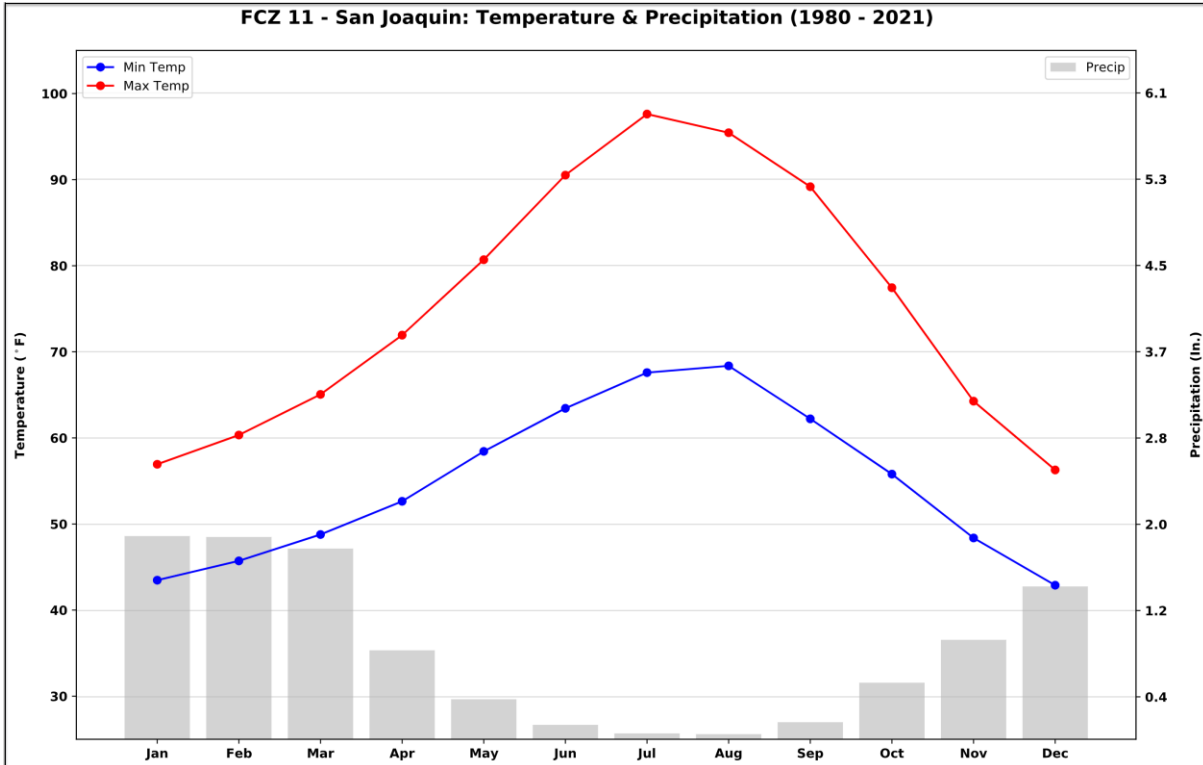

Figure 5-5 in Section

5.3.4.2 Climate Change Phenomena and Trends presents average daily maximum and minimum temperatures values observed and projected across each of SCE’s 11 Fire Climate Zones using data from California’s 4th Climate Change Assessment. Additional 10 Figures reflecting this information are provided below. These daily average maximum and minimum values are calculated as 365-day rolling averages. Fire Climate Zones are defined at regions in which SCE observes similar climatic conditions related to fire weather conditions.

Figure 5-5-1 - Annual Mean Climatology for SCE Service Territory (FCZ 2 - Inland Valleys)

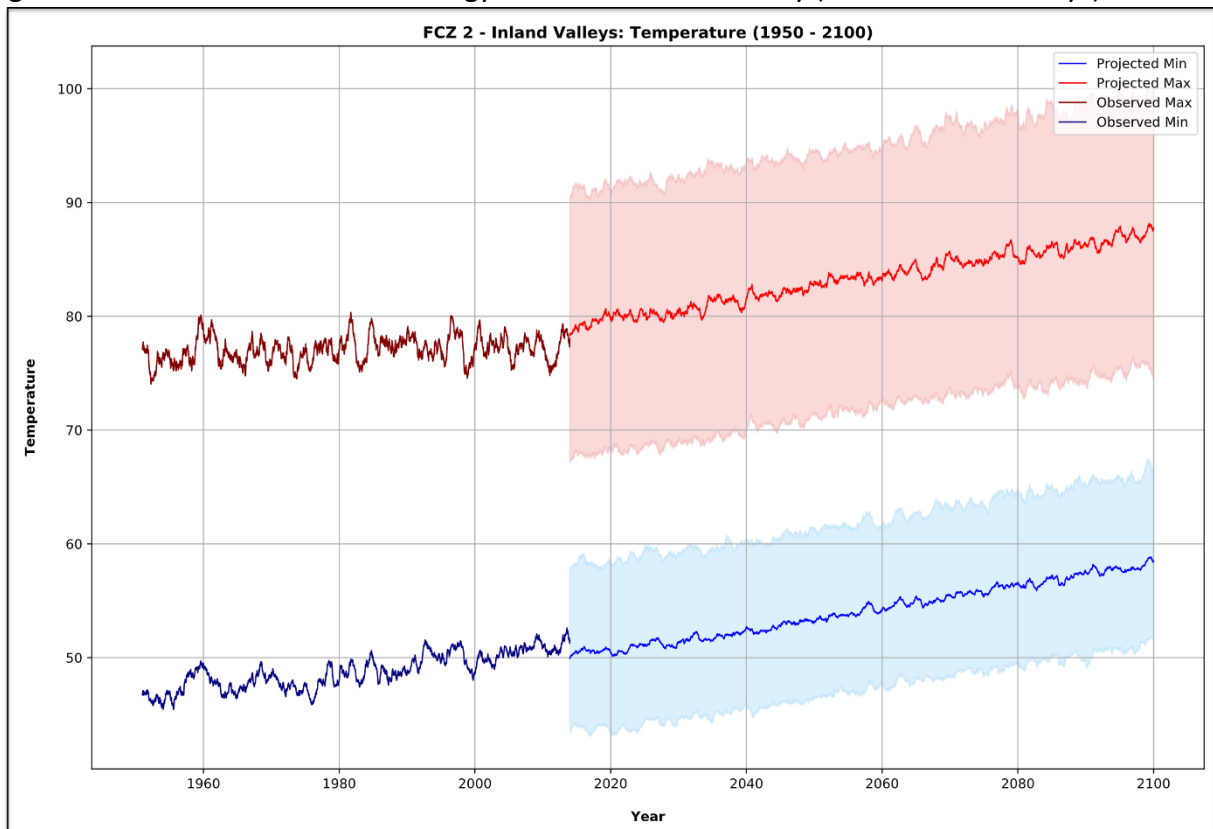

Figure 5-5-2 - Annual Mean Climatology for SCE Service Territory (FCZ 3- Western Mountains)

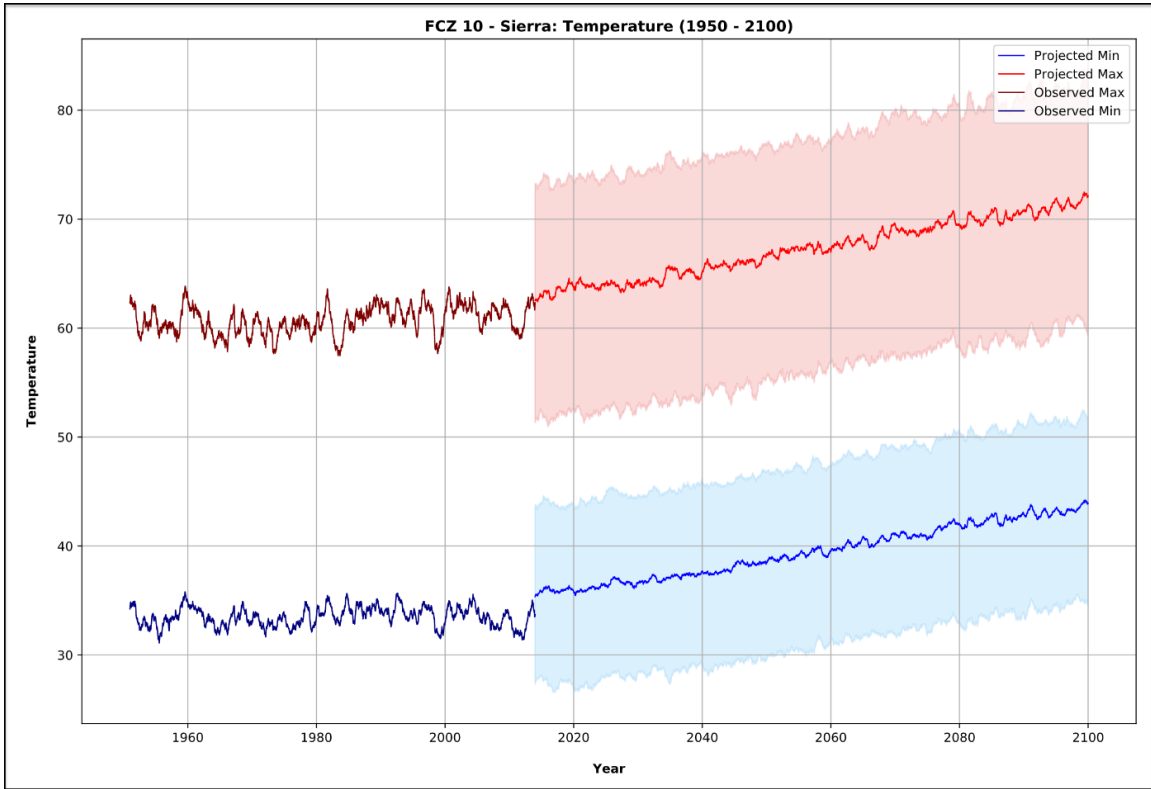

Figure 5-5-3 - Annual Mean Climatology for SCE Service Territory (FCZ 4 - Eastern Mountains)

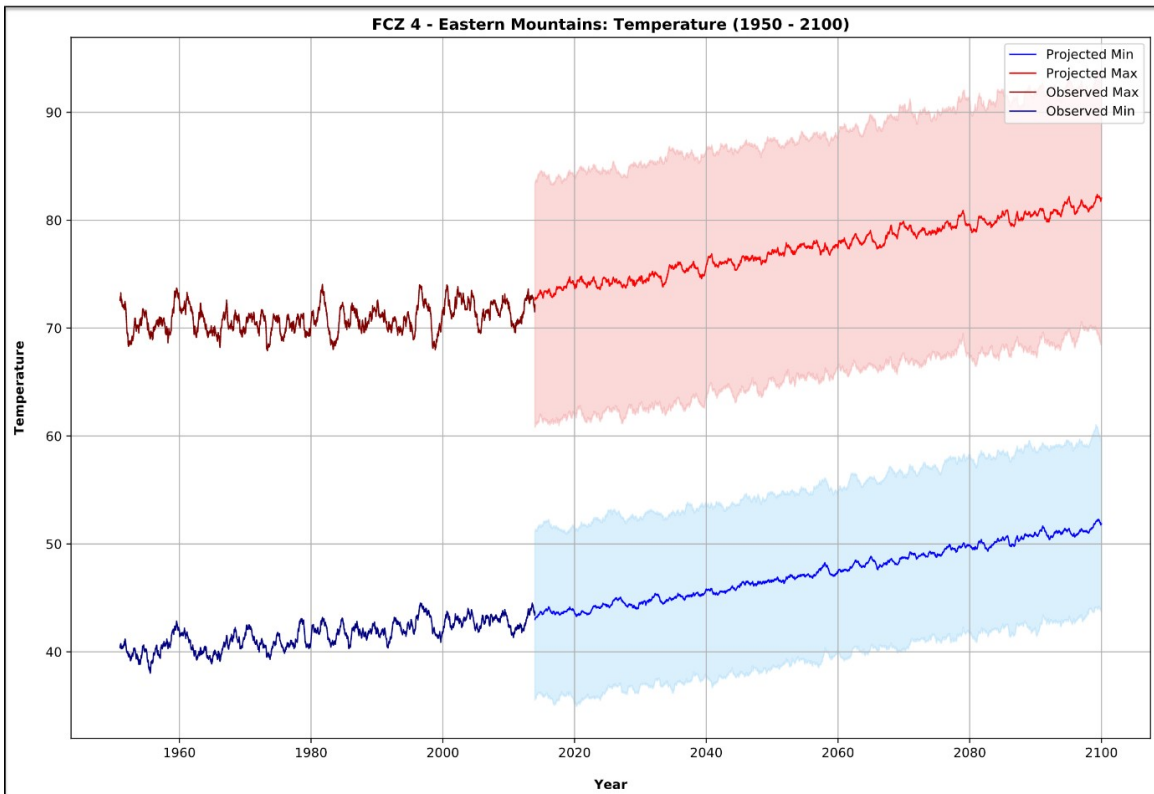

Figure 5-5-4 - Annual Mean Climatology for SCE Service Territory (FCZ 5 - Eastern Desert)

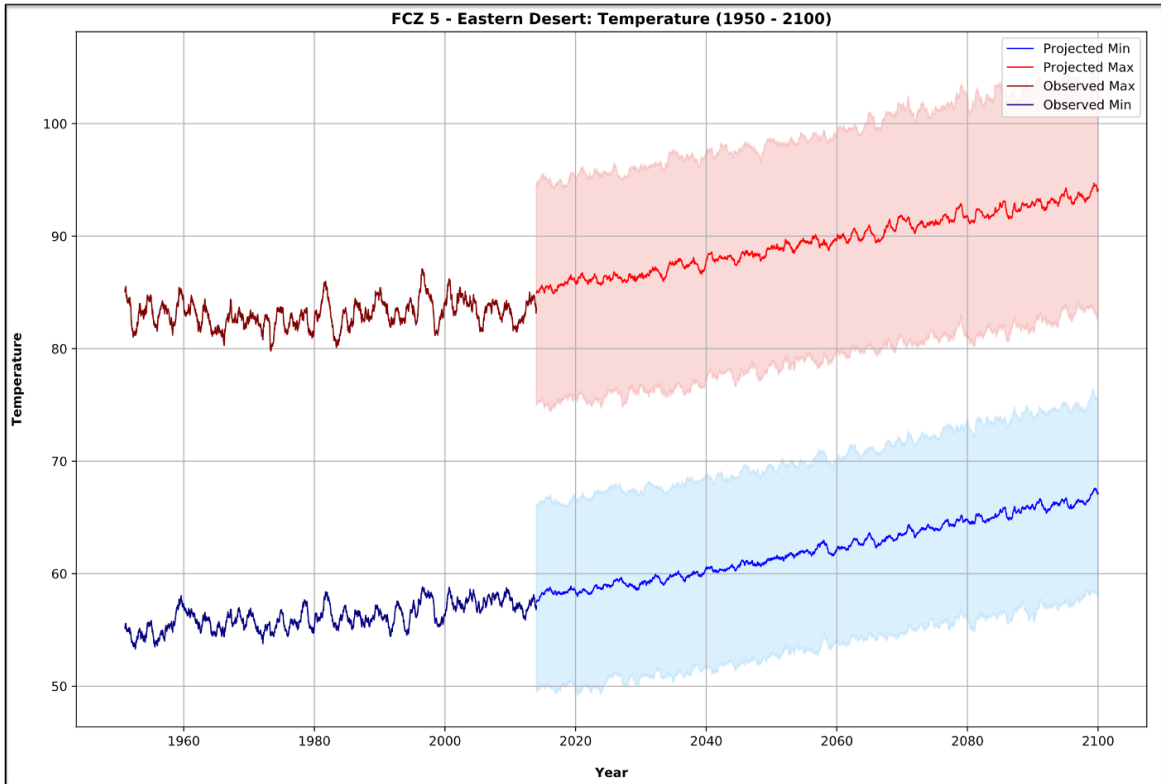

Figure 5-5-5 - Annual Mean Climatology for SCE Service Territory (FCZ 6 - Upper Desert)

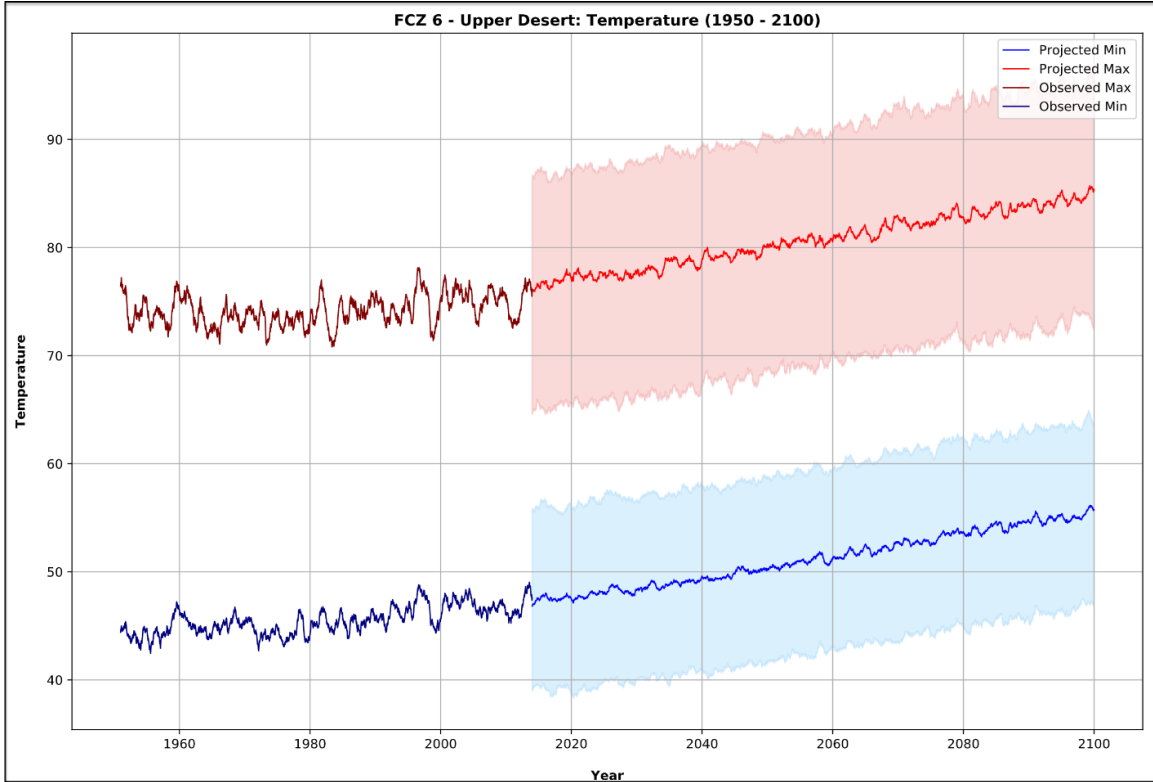

Figure 5-5-6 - Annual Mean Climatology for SCE Service Territory (FCZ 7 - Mojave)

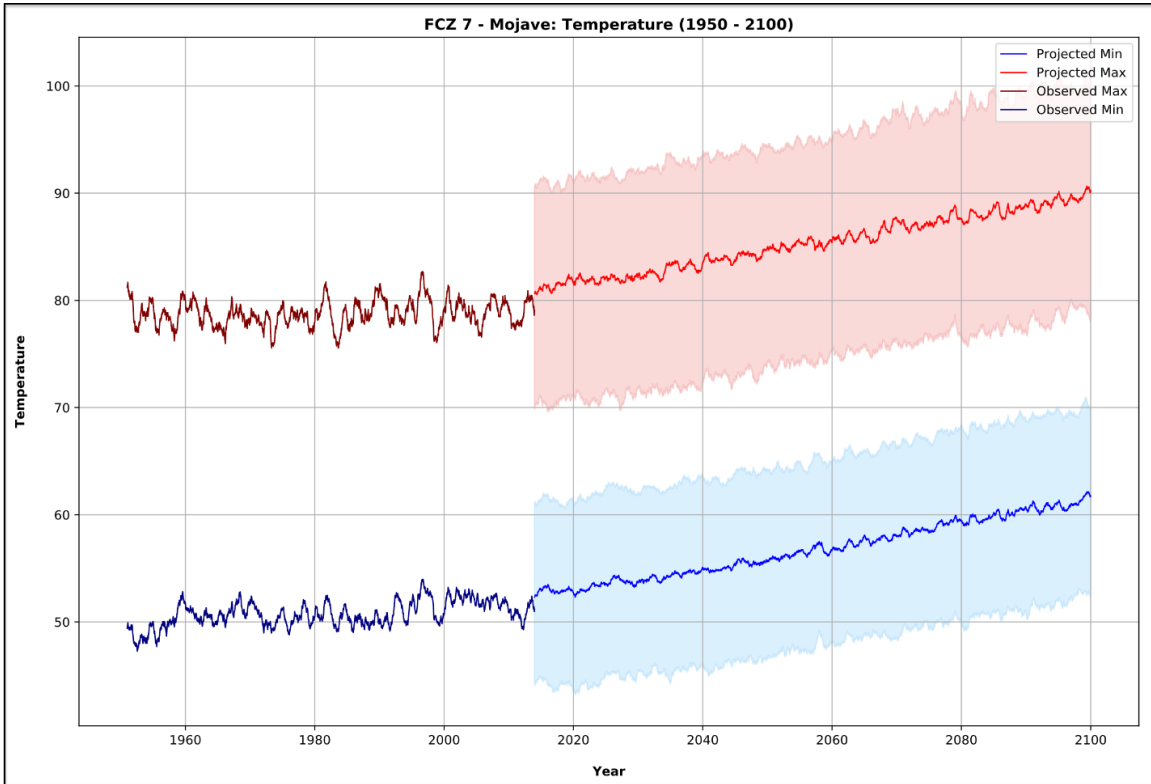

Figure 5-5-7 - Annual Mean Climatology for SCE Service Territory (FCZ 8 – Northern Desert)

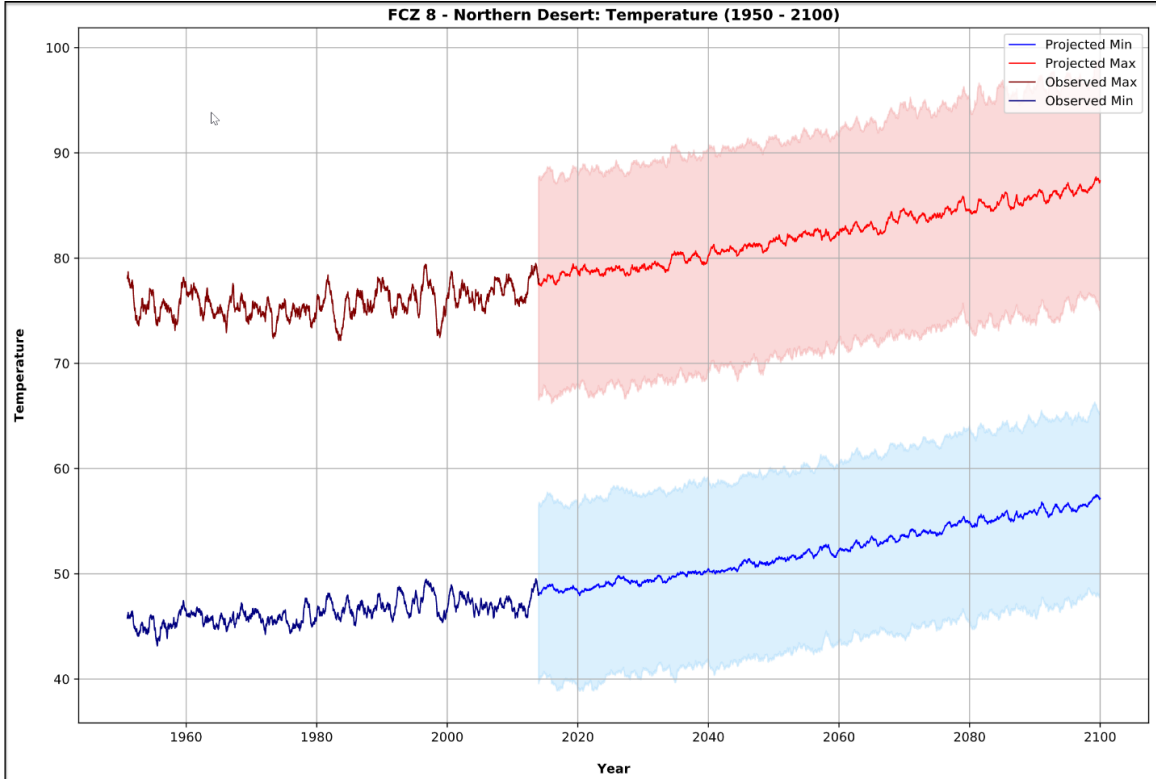

Figure 5-5-8 - Annual Mean Climatology for SCE Service Territory (FCZ 9 – Inyo)

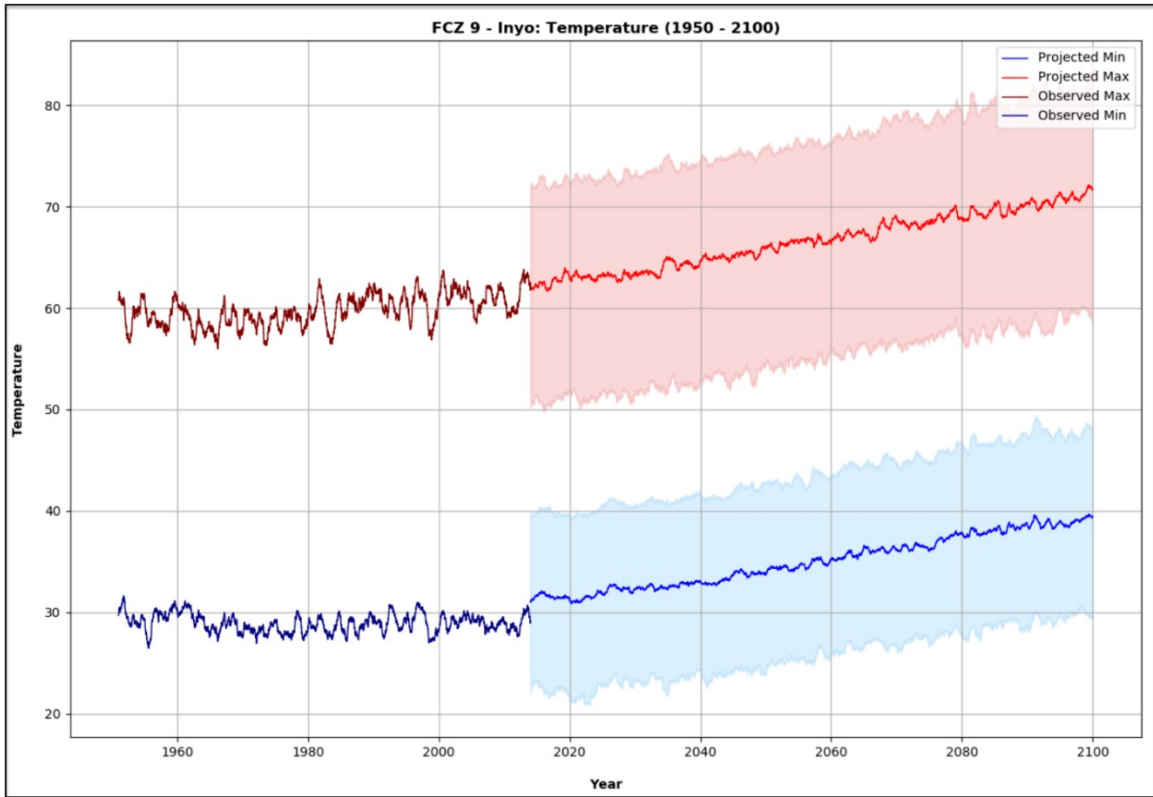

Figure 5-5-9 - Annual Mean Climatology for SCE Service Territory (FCZ 10 – Sierra)

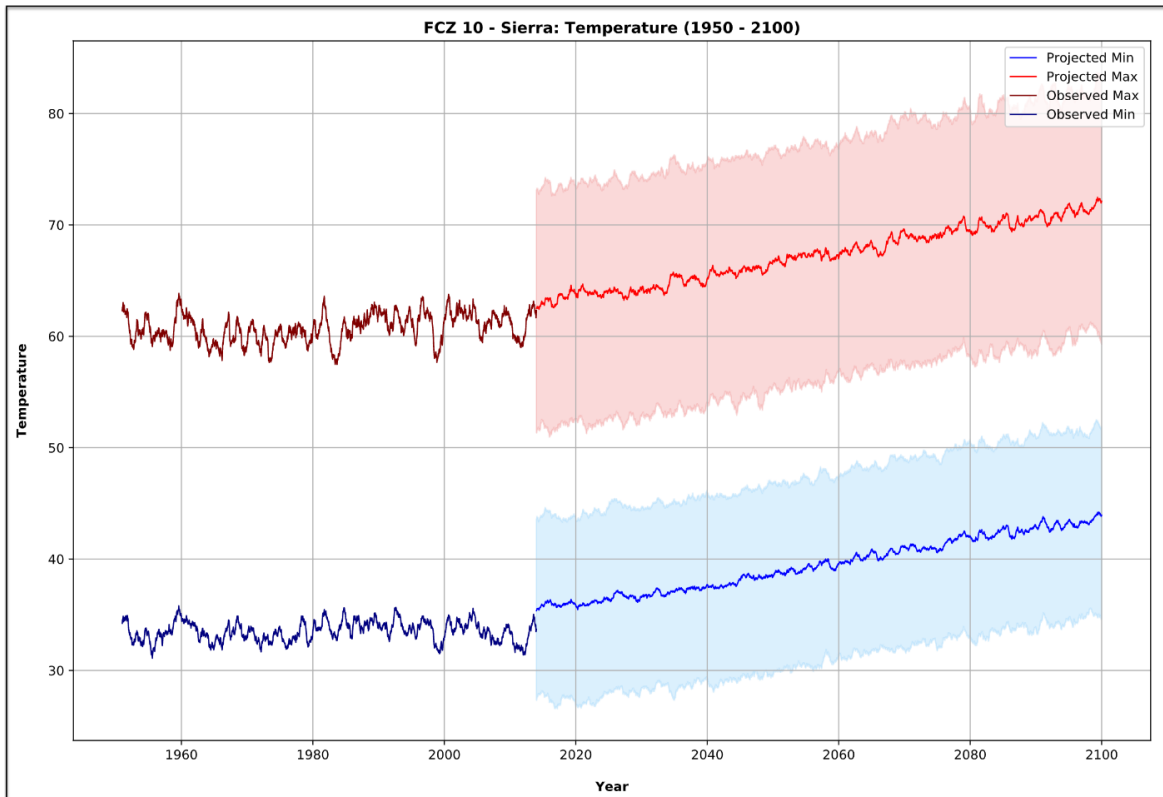
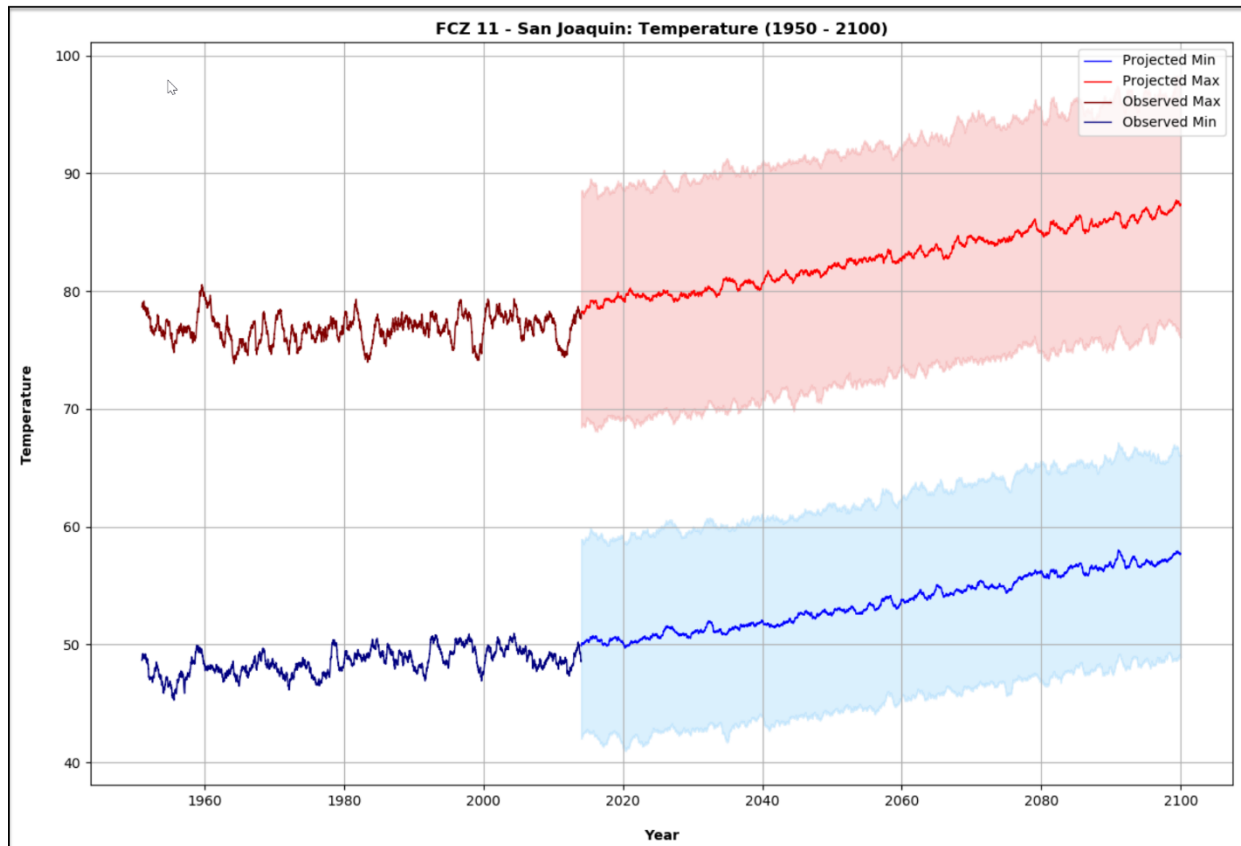

Figure 5-5-10 - Annual Mean Climatology for SCE Service Territory (FCZ 11 – San Joaquin)



Extreme fire weather day frequency is expected to increase across all SCE counties during most seasons and fuel moisture is expected to generally decrease. The largest increases in extreme fire weather days are forecast for Inyo and Mono County during the summer months. Data source is from climatetoolbox.org. Figure 5-6 in Section 5.3.4.2 Climate Change Phenomena and Trends shows the historical and projection of fuel moisture for Fresno County and the remaining additional fifteen figures are provided below.

Figure 5-6-1 - Projected Changes in Average Fuel Moisture and Average Number of Days of Extreme Fire Danger for Winter/Spring and Summer/Fall Periods for SCE Service Territory Based on Global Climate Model Outputs (Imperial County)

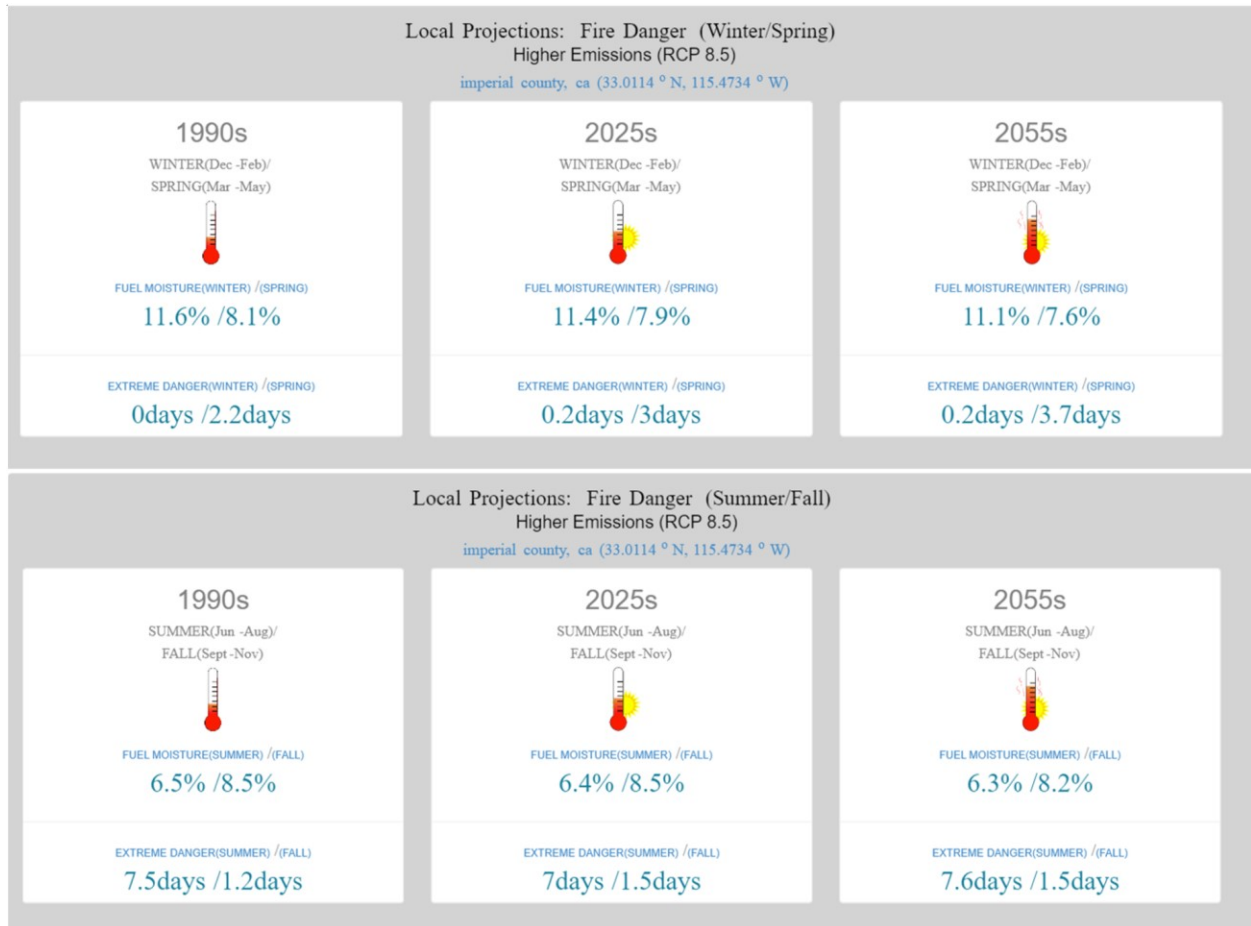

Figure 5-6-2 - Projected Changes in Average Fuel Moisture and Average Number of Days of Extreme Fire Danger for Winter/Spring and Summer/Fall Periods for SCE Service Territory Based on Global Climate Model Outputs (Inyo County)

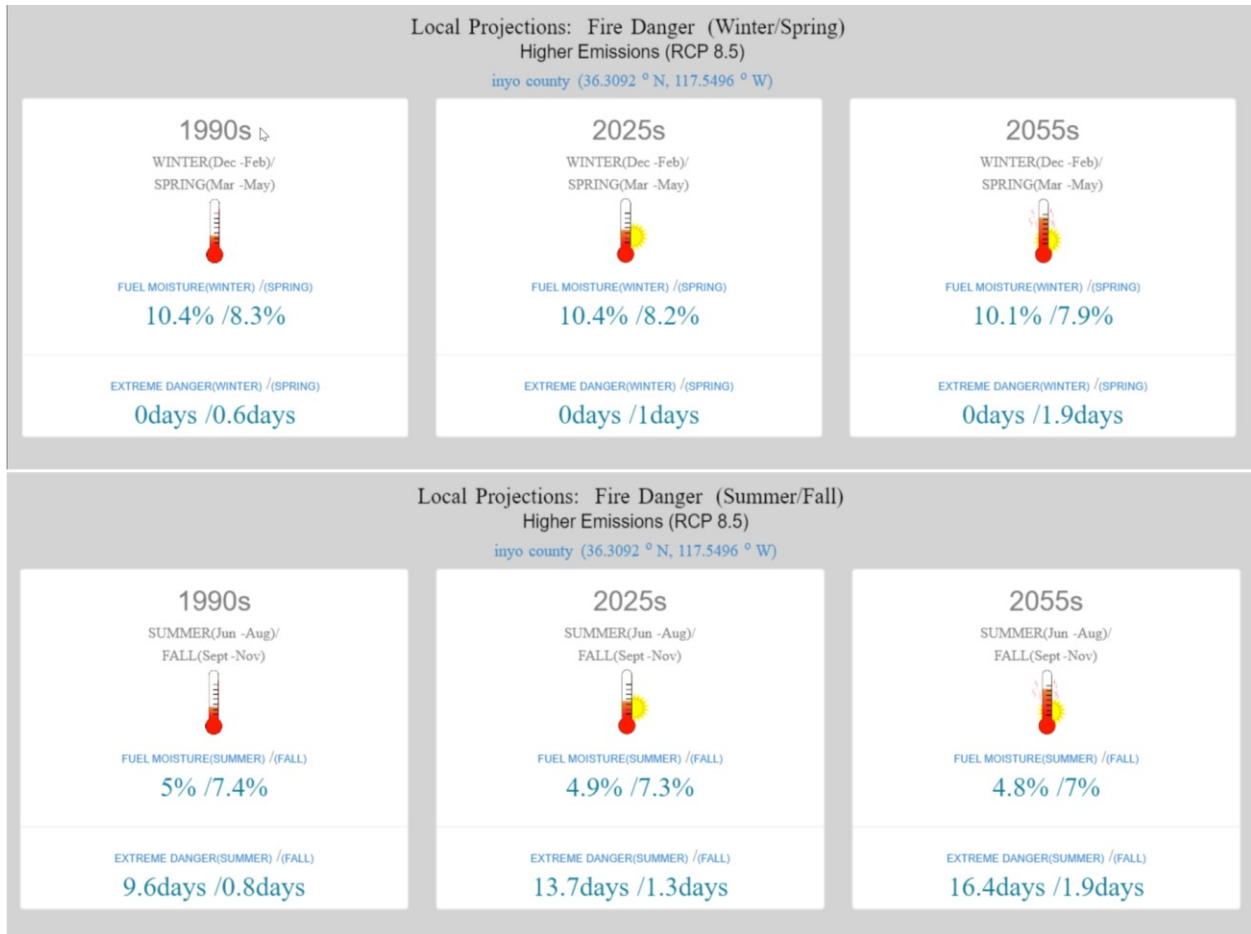

Figure 5-6-3 - Projected Changes in Average Fuel Moisture and Average Number of Days of Extreme Fire Danger for Winter/Spring and Summer/Fall Periods for SCE Service Territory Based on Global Climate Model Outputs (Kern County)

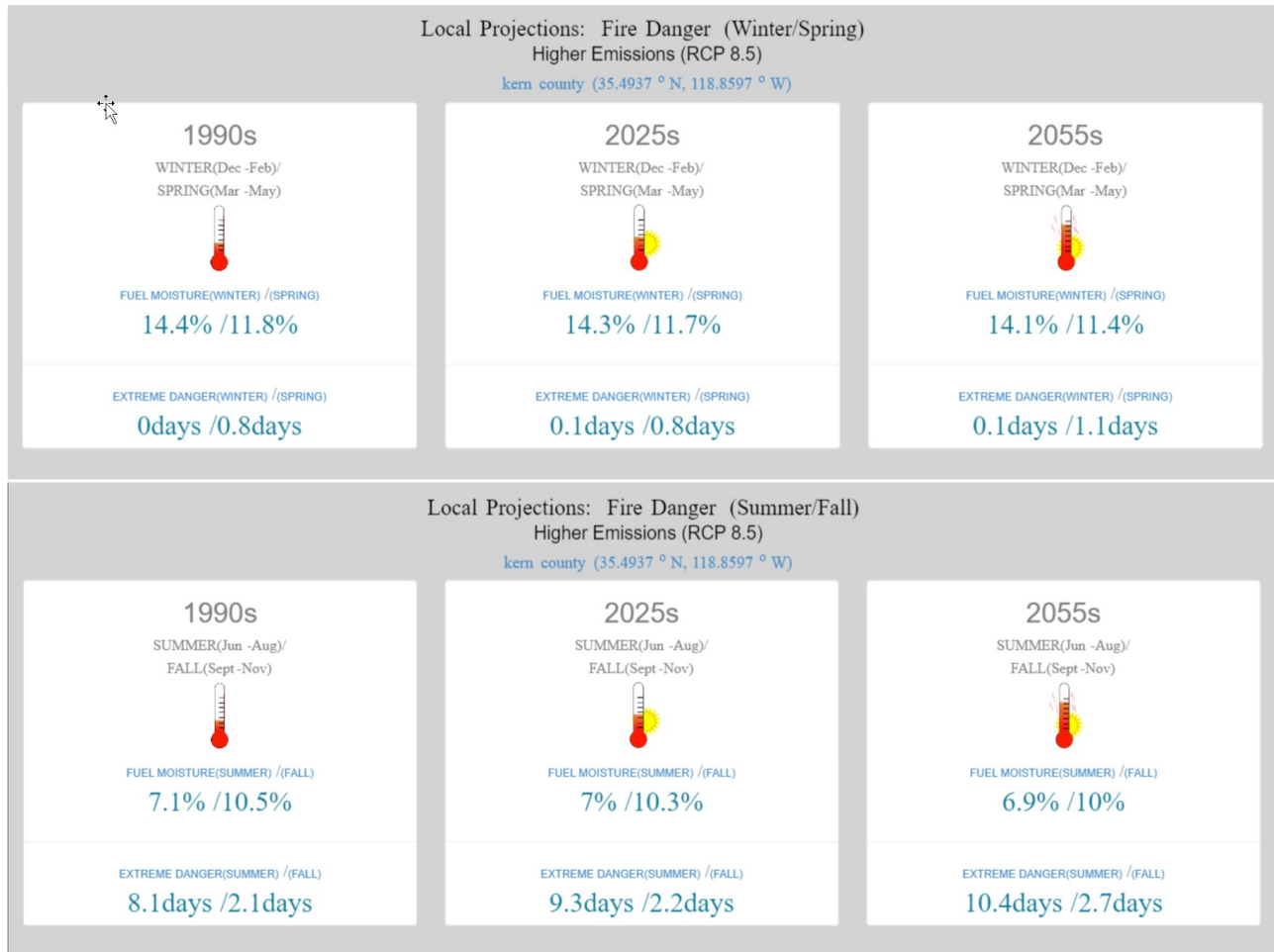

Figure 5-6-4 - Projected Changes in Average Fuel Moisture and Average Number of Days of xtreme Fire Danger for Winter/Spring and Summer/Fall Periods for SCE Service Territory Based on Global Climate Model Outputs (Kings County)

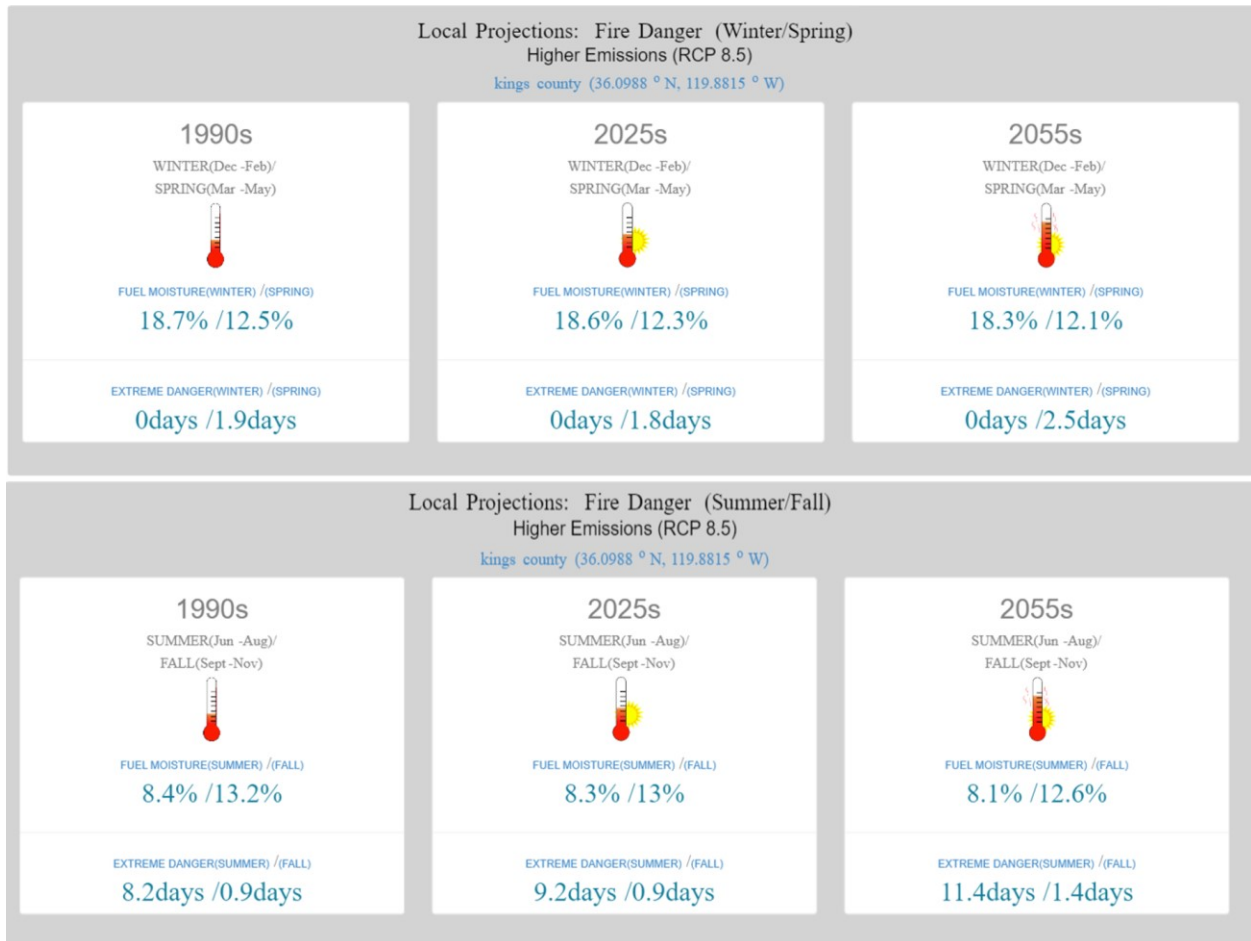

Figure 5-6-5 - Projected Changes in Average Fuel Moisture and Average Number of Days of Extreme Fire Danger for Winter/Spring and Summer/Fall Periods for SCE Service Territory Based on Global Climate Model Outputs (Los Angeles County)

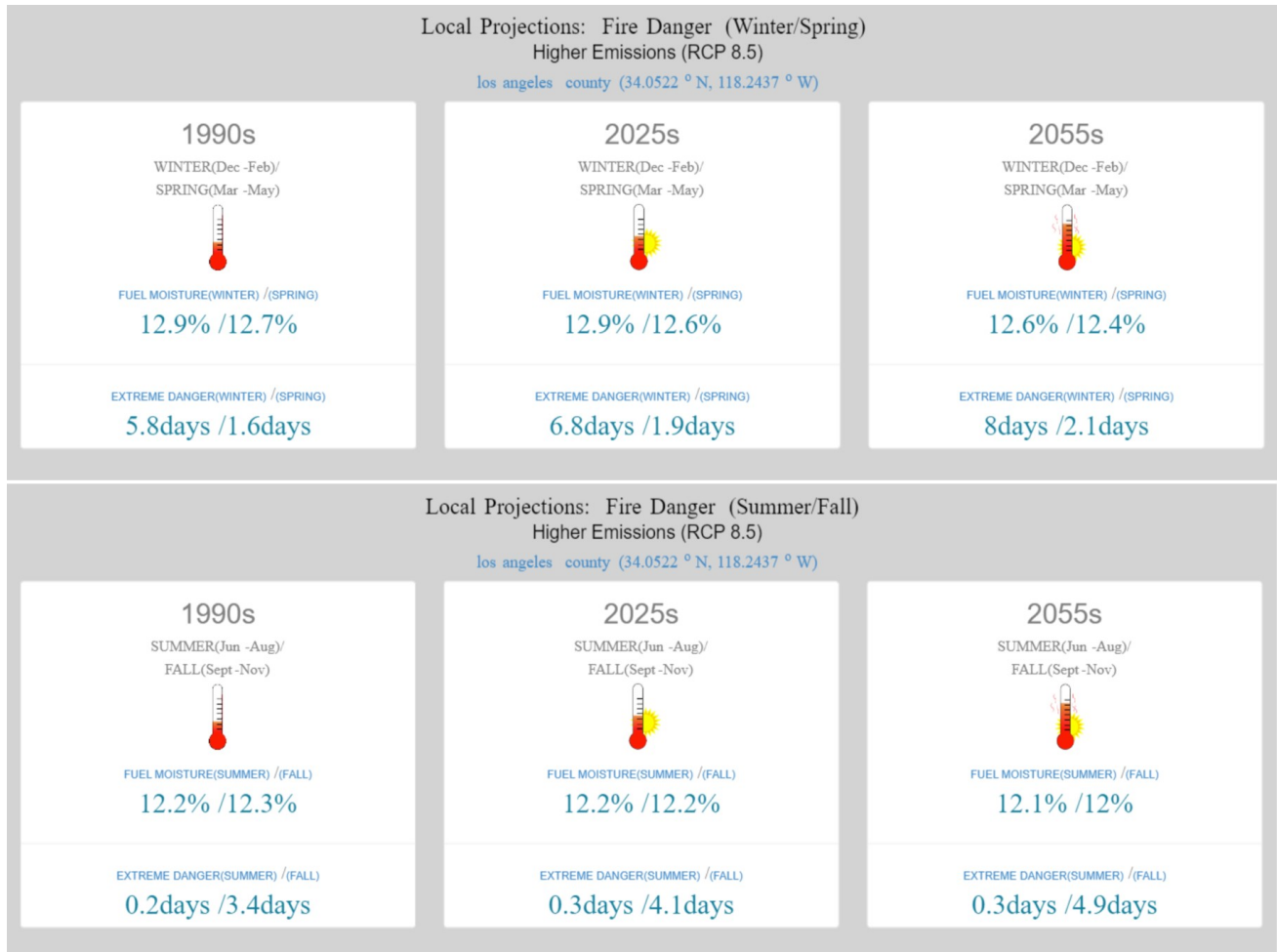

Figure 5-6-6 - Projected Changes in Average Fuel Moisture and Average Number of Days of Extreme Fire Danger for Winter/Spring and Summer/Fall Periods for SCE Service Territory Based on Global Climate Model Outputs (Madera County)

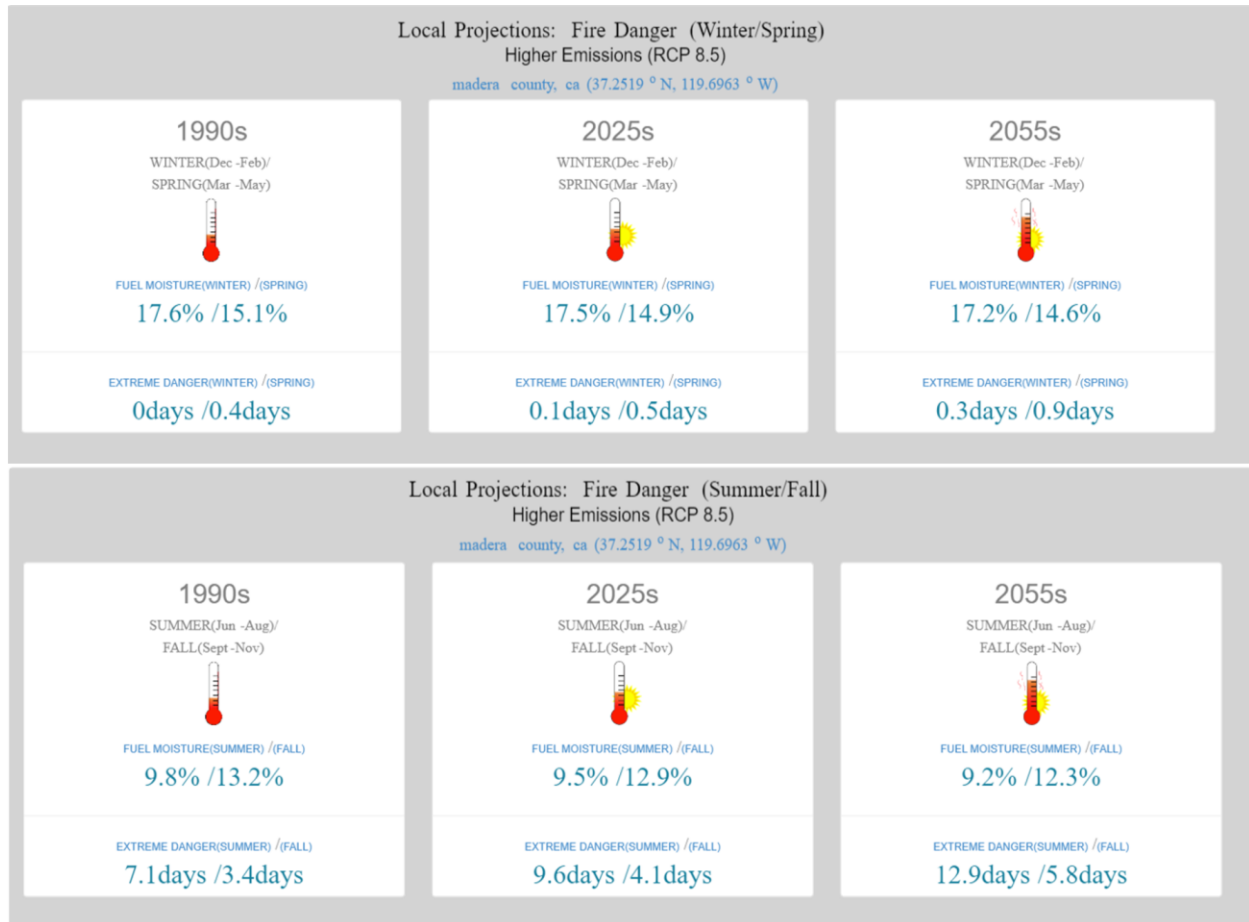

Figure 5-6-7 - Projected Changes in Average Fuel Moisture and Average Number of Days of Extreme Fire Danger for Winter/Spring and Summer/Fall Periods for SCE Service Territory Based on Global Climate Model Outputs (Mono County)

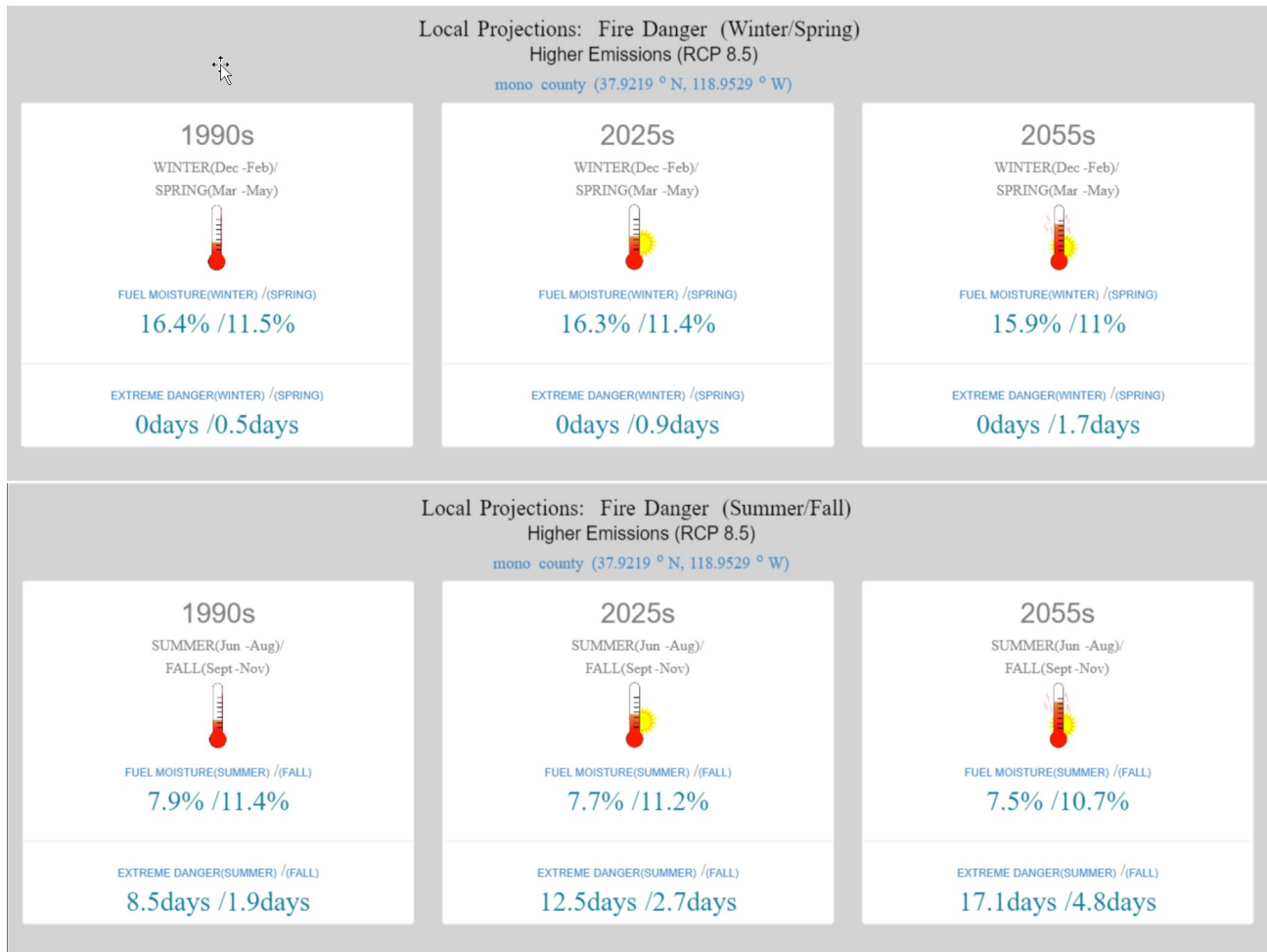

Figure 5-6-8 - Projected Changes in Average Fuel Moisture and Average Number of Days of Extreme Fire Danger for Winter/Spring and Summer/Fall Periods for SCE Service Territory Based on Global Climate Model Outputs (Orange County)

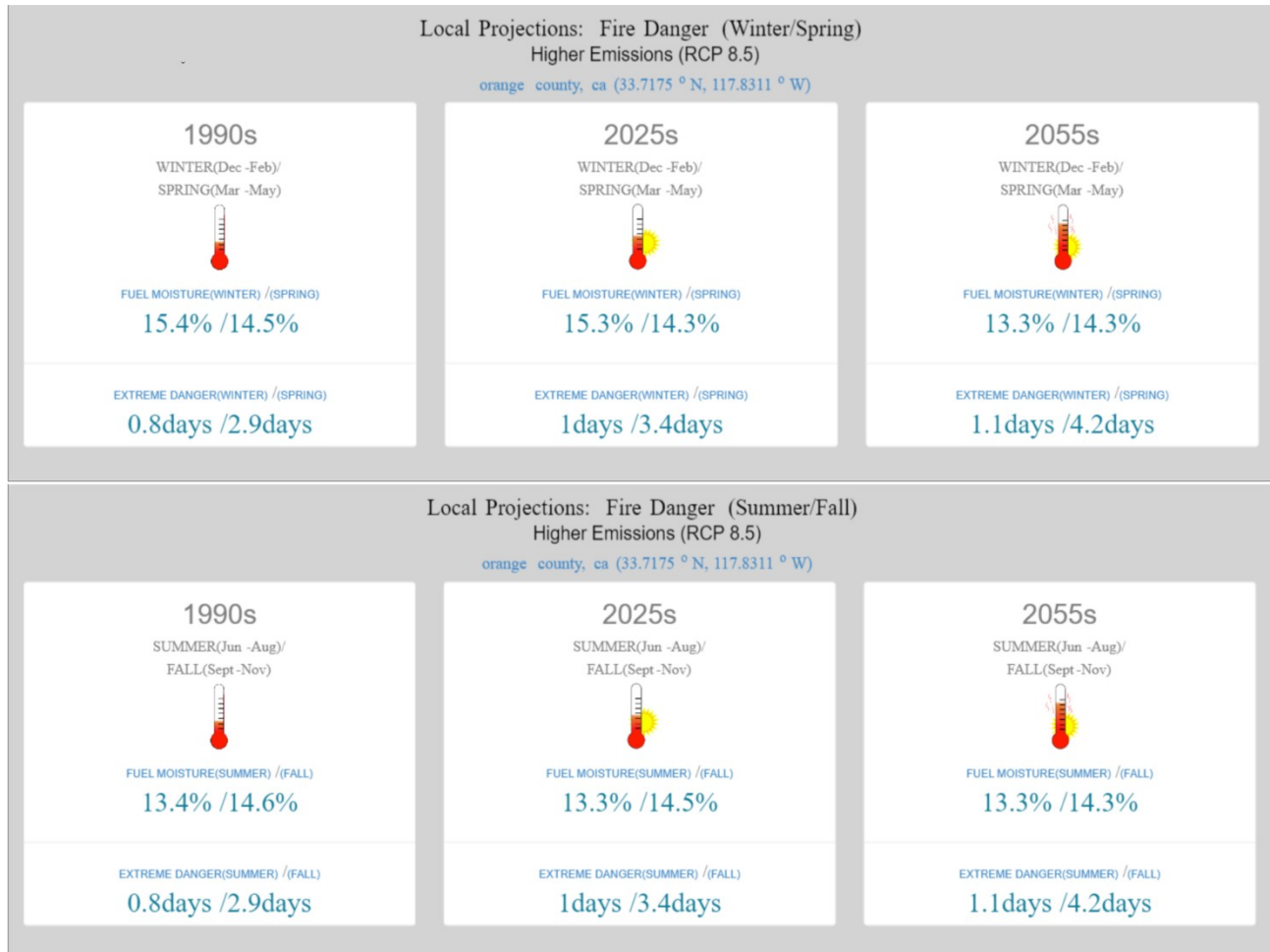

Figure 5-6-9 - Projected Changes in Average Fuel Moisture and Average Number of Days of Extreme Fire Danger for Winter/Spring and Summer/Fall Periods for SCE Service Territory Based on Global Climate Model Outputs (Riverside County)

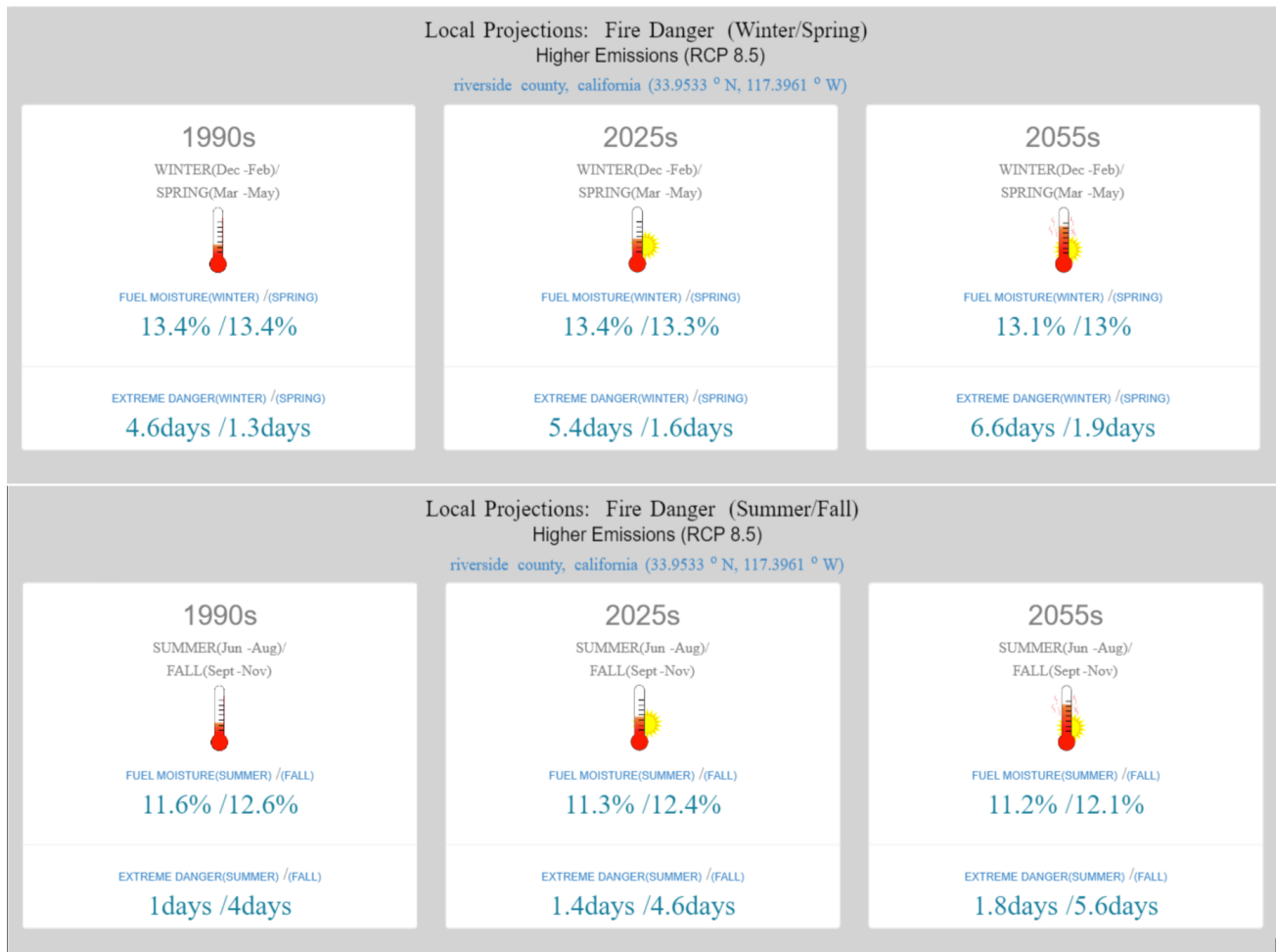

Figure 5-6-10 - Projected Changes in Average Fuel Moisture and Average Number of Days of Extreme Fire Danger for Winter/Spring and Summer/Fall Periods for SCE Service Territory Based on Global Climate Model Outputs (San Bernardino County)

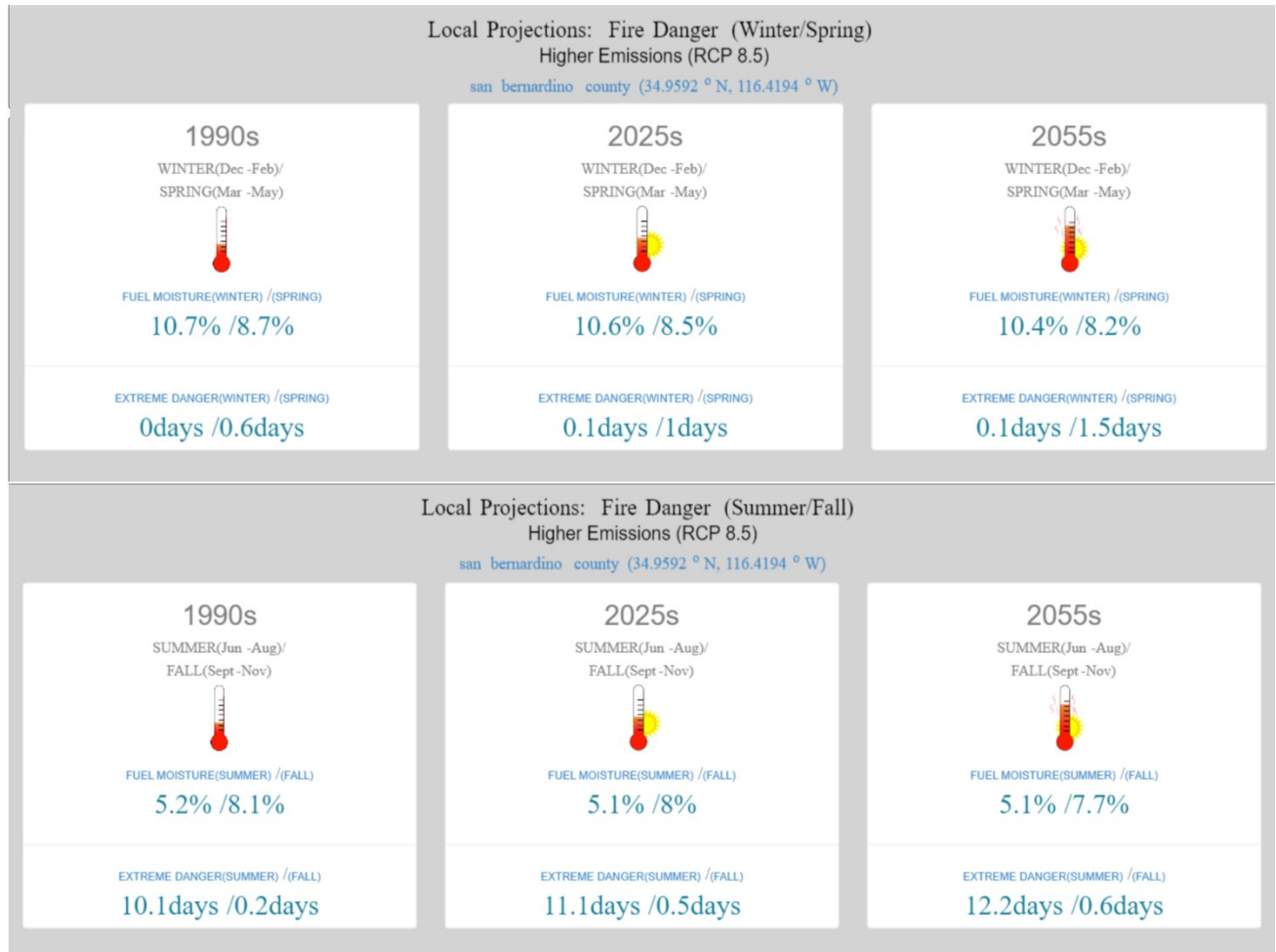

Figure 5-6-11 - Projected Changes in Average Fuel Moisture and Average Number of Days of Extreme Fire Danger for Winter/Spring and Summer/Fall Periods for SCE Service Territory Based on Global Climate Model Outputs (San Diego County)

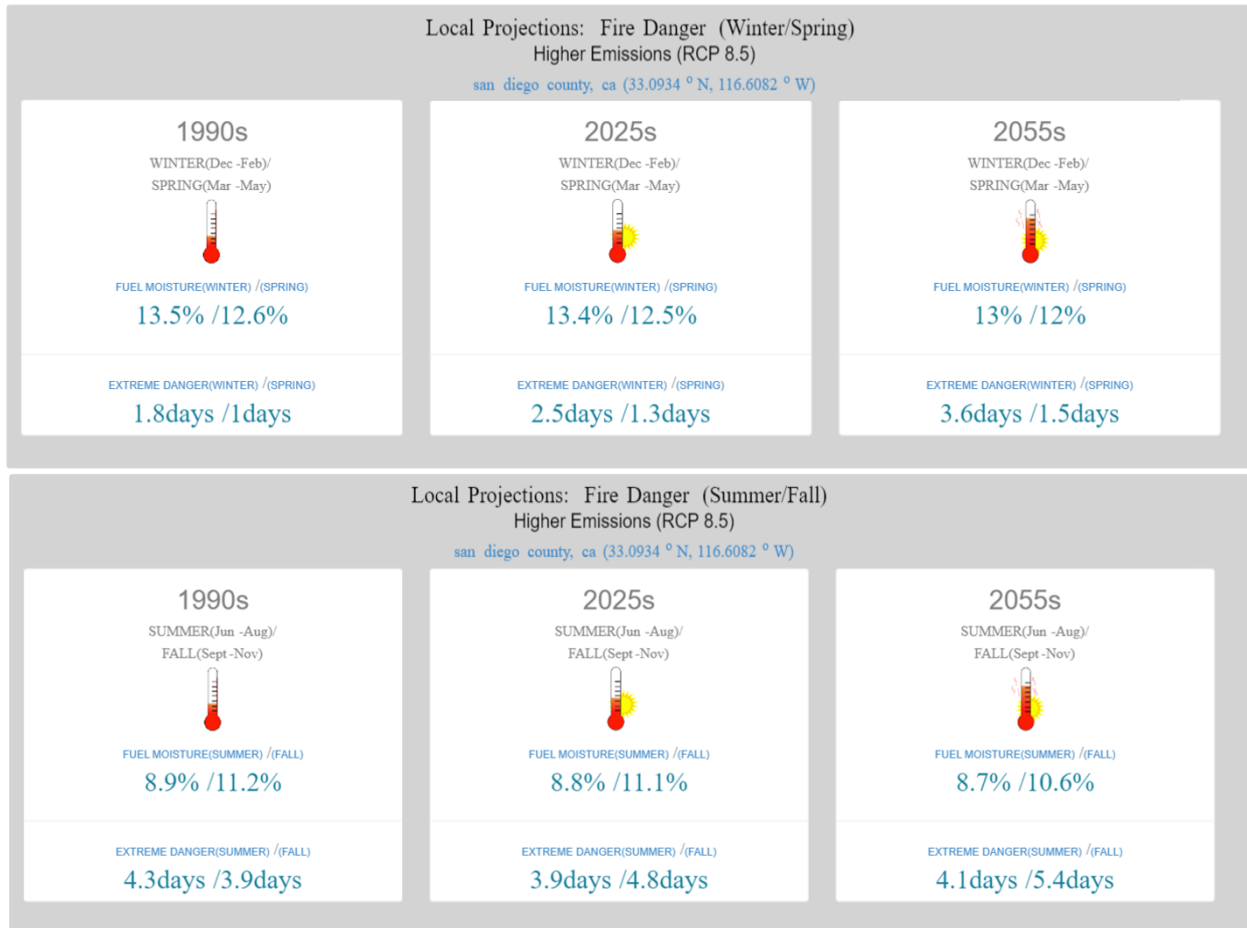

Figure 5-6-12 - Projected Changes in Average Fuel Moisture and Average Number of Days of Extreme Fire Danger for Winter/Spring and Summer/Fall Periods for SCE Service Territory Based on Global Climate Model Outputs (Santa Barbara County)

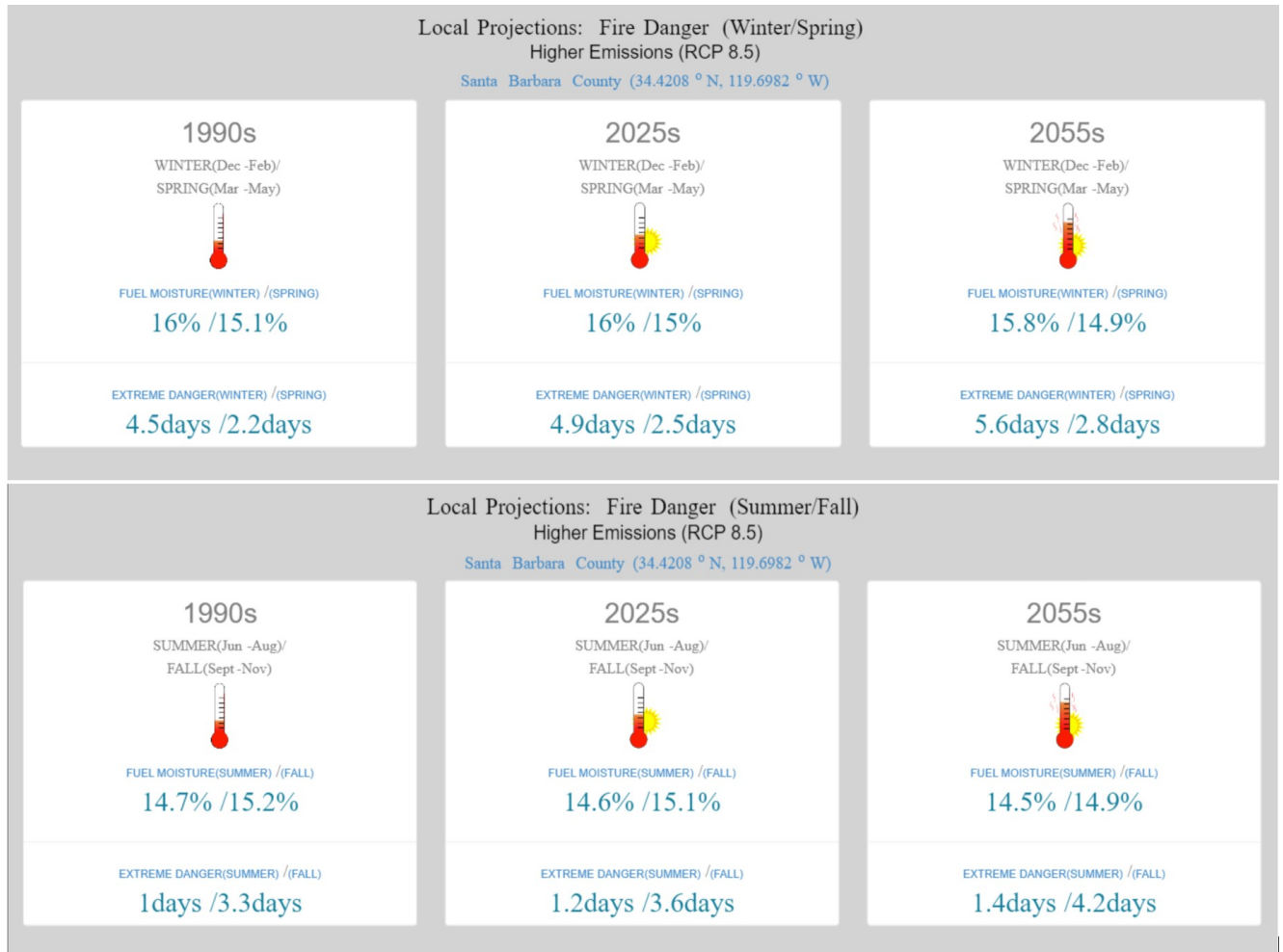

Figure 5-6-13 - Projected Changes in Average Fuel Moisture and Average Number of Days of Extreme Fire Danger for Winter/Spring and Summer/Fall Periods for SCE Service Territory Based on Global Climate Model Outputs (Tulare County)

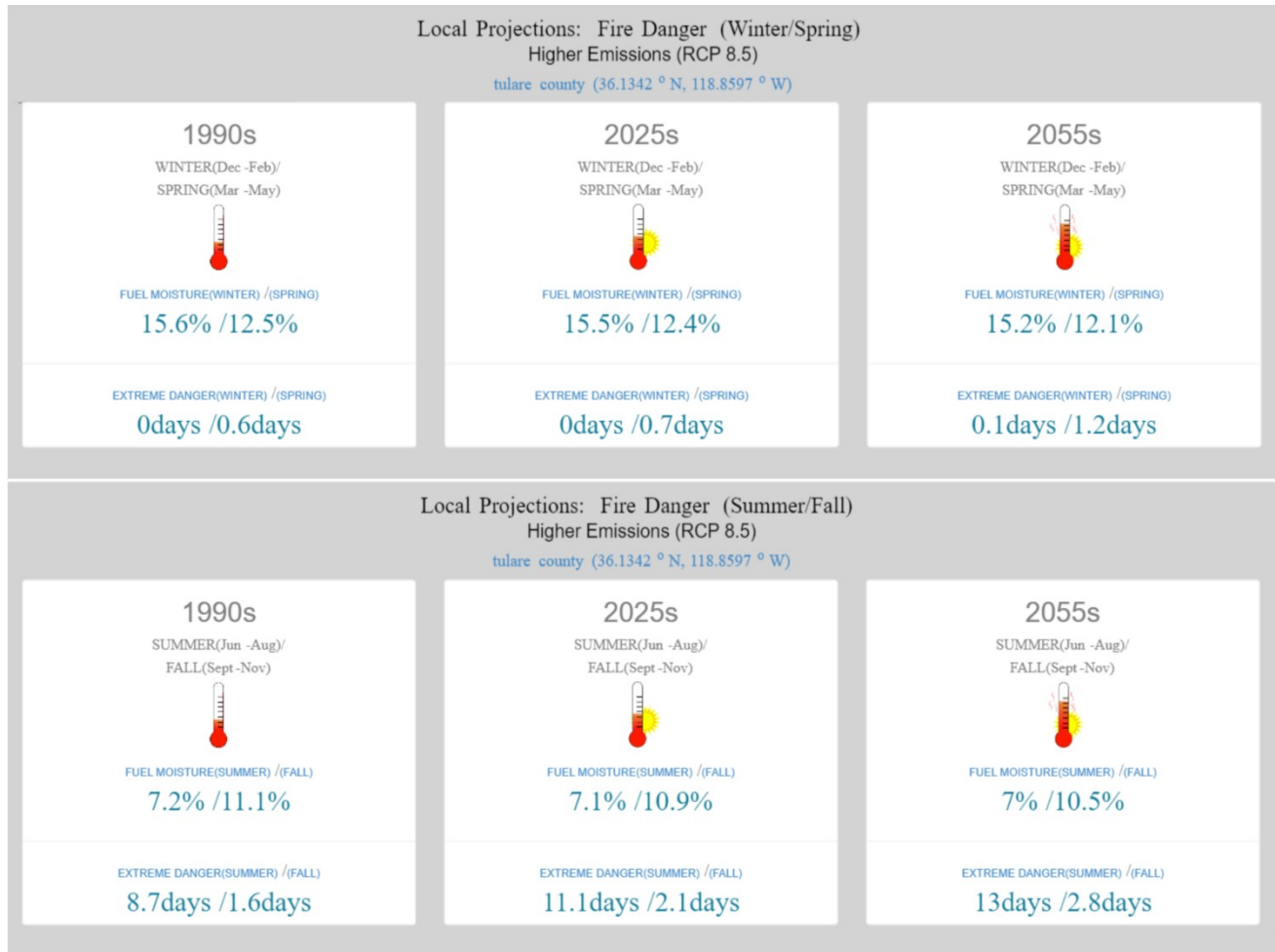

Figure 5-6-14 - Projected Changes in Average Fuel Moisture and Average Number of Days of Extreme Fire Danger for Winter/Spring and Summer/Fall Periods for SCE Service Territory Based on Global Climate Model Outputs (Tuolumne County)

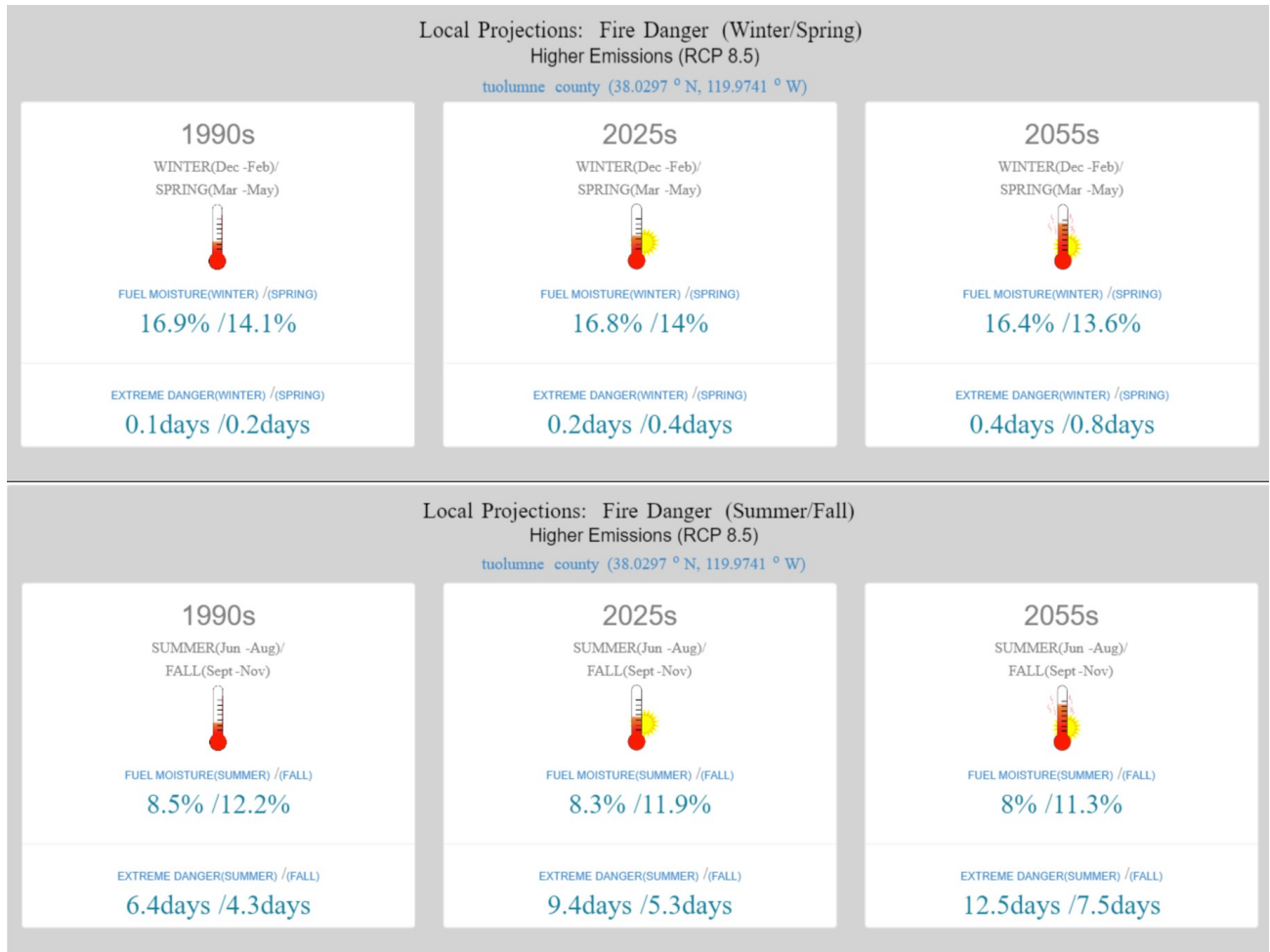
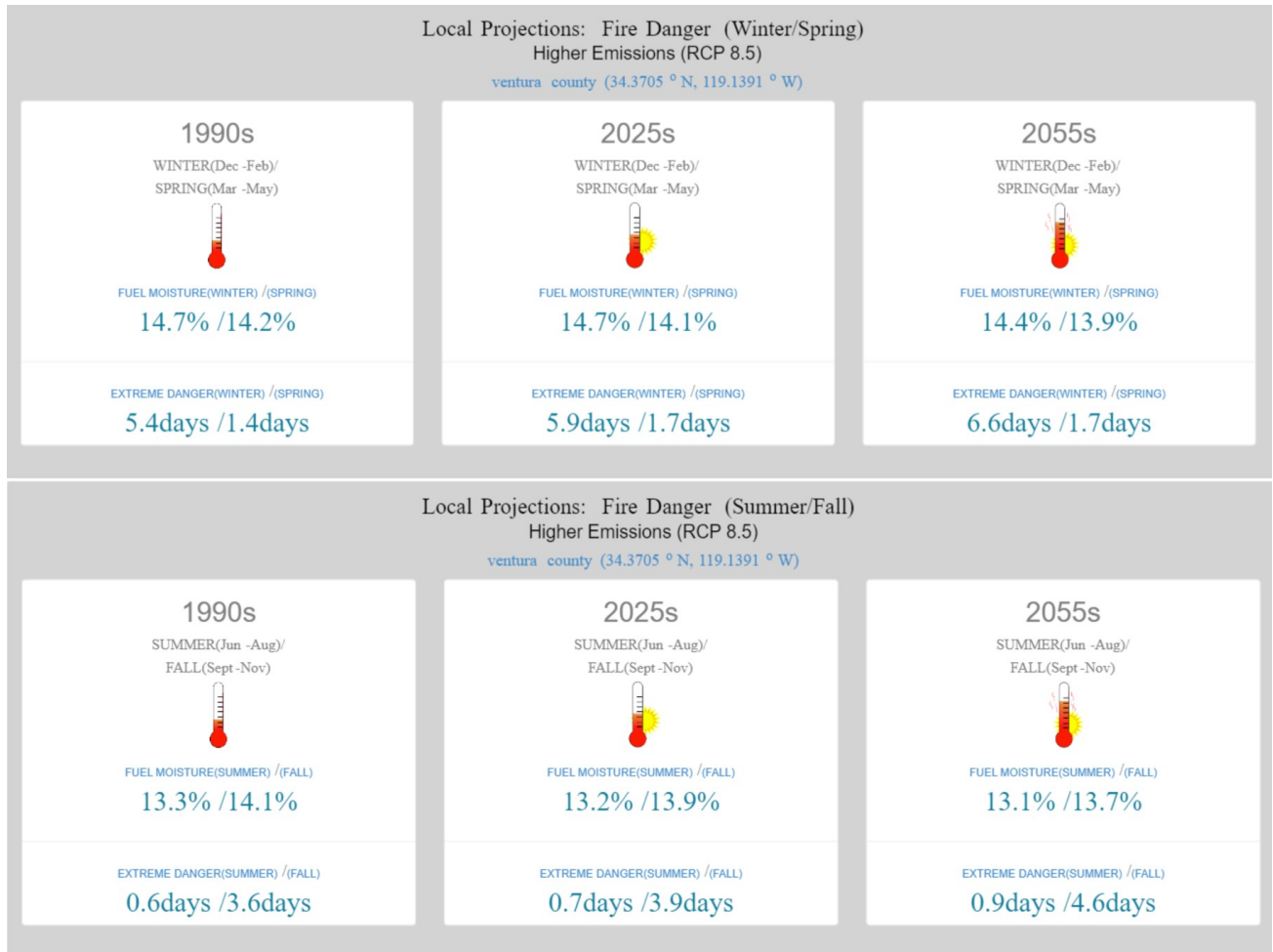

Figure 5-6-15 - Projected Changes in Average Fuel Moisture and Average Number of Days of Extreme Fire Danger for Winter/Spring and Summer/Fall Periods for SCE Service Territory Based on Global Climate Model Outputs (Ventura County)



F2: Continuation of Section 7 - Wildfire Mitigation Strategy Development

Wildfire and PSPS Mitigation Effectiveness Details

SCE provides mitigation effectiveness values for its mitigation initiatives in the tables that follow. Mitigation effectiveness percentages are based on a combination of data analysis, testing, independent, third-party engineering assessment, and SCE expert judgement. Where available, SCE uses a data driven approach that leverages historical fault and ignition data to weigh the mitigation's effectiveness at a subdriver level. SCE expert judgement, which typically involves multiple experts, is based on data and knowledge collected through benchmarking, testing, evaluation of risk in the field, calibration across mitigations, and other sources to determine reasonable mitigation effectiveness. Mitigation effectiveness percentages are also evaluated in a series of robust challenge sessions with internal experts and management to help ensure accuracy and reasonableness. For mitigations that do not target a category of risk drivers, SCE has listed "N/A" (e.g., mitigations only targeting distribution ignition risk subdrivers show N/A for all transmission subdrivers). SCE refines mitigation effectiveness values based on updated data and new information over time. The data included in this workpaper reflect updates as of January 2023.

Appendix F – Mitigation Effectiveness Values

WMP ID	SH-1	SH-2	SH-4	SH-5	SH-6	SH-10	SH-14	SH-15	SH-16*	SH-17	SH-18
Mitigation Name	Covered Conductor (including Fire-Resistant Poles)	Undergrounding Overhead Conductor	Branch Line Protection	Remote Controlled Automatic Reclosers Settings	Circuit Breaker with Fast Curve Settings	Tree Attachments Remediation	Long Span Initiative	Vertical Switches	Vibration Damper Retrofit	Rapid Earth Fault Current Limiters (REFCL)-Ground Fault Neutralizer (GFN)	Rapid Earth Fault Current Limiters (REFCL)-Grounding Conversions
Useful Life	45	45	15	25	65	45	15	30	45	40	40

Drivers	Driver Type	Subdriver Type	Mitigation Effectiveness	Mitigation Effectiveness	Mitigation Effectiveness	Mitigation Effectiveness	Mitigation Effectiveness	Mitigation Effectiveness	Mitigation Effectiveness	Mitigation Effectiveness	Mitigation Effectiveness	Mitigation Effectiveness	Mitigation Effectiveness
1	Distribution-Contact From Object	Veg. contact	71%	100%	5%	40%	40%	7%	8%	0%	60%	50%	50%
2	Distribution-Contact From Object	Animal contact	65%	99%	5%	40%	40%	31%	4%	0%	65%	90%	90%
3	Distribution-Contact From Object	Balloon contact	99%	99%	5%	40%	40%	0%	6%	0%	99%	50%	50%
4	Distribution-Contact From Object	Vehicle contact	82%	95%	5%	40%	40%	0%	15%	0%	57%	20%	20%
5	Distribution-Contact From Object	Unknown contact	81%	99%	5%	40%	40%	11%	12%	0%	77%	50%	50%
6	Distribution-Unknown	Unknown	65%	97%	5%	40%	40%	0%	0%	0%	0%	50%	50%
7	Distribution-Contact From Object	Other contact from object	77%	100%	5%	40%	40%	0%	5%	0%	77%	50%	50%
8	Distribution-Wire-To-Wire	Wire-to-wire contact / contamination	99%	100%	5%	40%	40%	0%	97%	0%	99%	0%	0%
9	Distribution-Equipment/Facility Failure	Anchor / guy damage or failure	0%	100%	5%	40%	40%	0%	0%	0%	0%	70%	70%
10	Distribution-Equipment/Facility Failure	Conductor damage or failure	90%	100%	5%	40%	40%	90%	25%	0%	90%	50%	50%

WMP ID	SH-1	SH-2	SH-4	SH-5	SH-6	SH-10	SH-14	SH-15	SH-16*	SH-17	SH-18
Mitigation Name	Covered Conductor (including Fire-Resistant Poles)	Undergrounding Overhead Conductor	Branch Line Protection	Remote Controlled Automatic Reclosers Settings	Circuit Breaker with Fast Curve Settings	Tree Attachments Remediation	Long Span Initiative	Vertical Switches	Vibration Damper Retrofit	Rapid Earth Fault Current Limiters (REFCL)-Ground Fault Neutralizer (GFN)	Rapid Earth Fault Current Limiters (REFCL)-Grounding Conversions
Useful Life	45	45	15	25	65	45	15	30	45	40	40

Drivers	Driver Type	Subdriver Type	Mitigation Effectiveness	Mitigation Effectiveness	Mitigation Effectiveness	Mitigation Effectiveness	Mitigation Effectiveness	Mitigation Effectiveness	Mitigation Effectiveness	Mitigation Effectiveness	Mitigation Effectiveness	Mitigation Effectiveness	Mitigation Effectiveness
11	Distribution-Equipment/Facility Failure	Connection device damage or failure	90%	97%	5%	40%	40%	90%	6%	0%	90%	50%	50%
12	Distribution-Equipment/Facility Failure	Connector damage or failure	90%	100%	5%	40%	40%	90%	6%	0%	90%	50%	50%
13	Distribution-Equipment/Facility Failure	Crossarm damage or failure	50%	100%	5%	40%	40%	5%	4%	75%	50%	30%	30%
14	Distribution-Equipment/Facility Failure	Fuse damage or failure	2%	89%	99%	0%	0%	0%	0%	0%	0%	30%	30%
15	Distribution-Equipment/Facility Failure	Insulator and bushing damage or failure	90%	100%	5%	40%	40%	9%	6%	0%	90%	50%	50%
16	Distribution-Equipment/Facility Failure	Lightning arrester damage or failure	0%	100%	5%	40%	40%	0%	0%	0%	0%	50%	50%
17	Distribution-Equipment/Facility Failure	Other	15%	99%	5%	40%	40%	0%	0%	0%	0%	50%	50%
18	Distribution-Equipment/Facility Failure	Pole damage or failure	0%	100%	5%	40%	40%	0%	0%	0%	0%	40%	40%
19	Distribution-Equipment/Facility Failure	Recloser damage or failure	5%	100%	0%	40%	40%	0%	0%	2%	0%	5%	5%
20	Distribution-Equipment/Facility Failure	Splice damage or failure	90%	100%	5%	40%	40%	90%	6%	0%	90%	50%	50%

WMP ID	SH-1	SH-2	SH-4	SH-5	SH-6	SH-10	SH-14	SH-15	SH-16*	SH-17	SH-18
Mitigation Name	Covered Conductor (including Fire-Resistant Poles)	Undergrounding Overhead Conductor	Branch Line Protection	Remote Controlled Automatic Reclosers Settings	Circuit Breaker with Fast Curve Settings	Tree Attachments Remediation	Long Span Initiative	Vertical Switches	Vibration Damper Retrofit	Rapid Earth Fault Current Limiters (REFCL)-Ground Fault Neutralizer (GFN)	Rapid Earth Fault Current Limiters (REFCL)-Grounding Conversions
Useful Life	45	45	15	25	65	45	15	30	45	40	40

Drivers	Driver Type	Subdriver Type	Mitigation Effectiveness	Mitigation Effectiveness	Mitigation Effectiveness	Mitigation Effectiveness	Mitigation Effectiveness	Mitigation Effectiveness	Mitigation Effectiveness	Mitigation Effectiveness	Mitigation Effectiveness	Mitigation Effectiveness	Mitigation Effectiveness
21	Distribution-Equipment/Facility Failure	Tie wire damage or failure	0%	100%	5%	40%	40%	0%	0%	0%	0%	50%	50%
22	Distribution-Equipment/Facility Failure	Voltage regulator / booster damage or failure	0%	100%	0%	40%	40%	0%	0%	0%	0%	50%	50%
23	Distribution-Contamination	Contamination	0%	100%	5%	40%	40%	0%	0%	0%	0%	30%	30%
24	Distribution-Equipment/Facility Failure	Capacitor bank damage or failure	0%	89%	0%	0%	0%	0%	0%	0%	0%	1%	1%
25	Distribution-Equipment/Facility Failure	Switch damage or failure	2%	100%	5%	40%	40%	50%	0%	99%	0%	0%	0%
26	Distribution-Equipment/Facility Failure	Transformer damage or failure	20%	89%	0%	0%	0%	90%	0%	0%	0%	85%	85%
27	Distribution-Equipment/Facility Failure	Tap damage or failure	0%	100%	5%	40%	40%	0%	0%	0%	0%	50%	50%
28	Distribution-Equipment/Facility Failure	Sectionalizer damage or failure	0%	100%	0%	40%	40%	0%	0%	18%	0%	70%	70%
29	Distribution-Other	All Other	0%	97%	0%	0%	0%	0%	0%	0%	0%	50%	50%
30	Distribution-Utility Work	Utility work / Operation	0%	0%	0%	0%	0%	0%	0%	47%	0%	25%	25%
31	Distribution-Vandalism	Vandalism / Theft	0%	80%	5%	40%	40%	0%	0%	0%	0%	1%	1%
32	Transmission-Contact From Object	Veg. contact	N/A	N/A	N/A	N/A	N/A	N/A	N/A	N/A	N/A	N/A	N/A

WMP ID	SH-1	SH-2	SH-4	SH-5	SH-6	SH-10	SH-14	SH-15	SH-16*	SH-17	SH-18
Mitigation Name	Covered Conductor (including Fire-Resistant Poles)	Undergrounding Overhead Conductor	Branch Line Protection	Remote Controlled Automatic Reclosers Settings	Circuit Breaker with Fast Curve Settings	Tree Attachments Remediation	Long Span Initiative	Vertical Switches	Vibration Damper Retrofit	Rapid Earth Fault Current Limiters (REFCL)-Ground Fault Neutralizer (GFN)	Rapid Earth Fault Current Limiters (REFCL)-Grounding Conversions
Useful Life	45	45	15	25	65	45	15	30	45	40	40

Drivers	Driver Type	Subdriver Type	Mitigation Effectiveness	Mitigation Effectiveness	Mitigation Effectiveness	Mitigation Effectiveness	Mitigation Effectiveness	Mitigation Effectiveness	Mitigation Effectiveness	Mitigation Effectiveness	Mitigation Effectiveness	Mitigation Effectiveness	Mitigation Effectiveness
33	Transmission-Contact From Object	Animal contact	N/A	N/A	N/A	N/A	N/A	N/A	N/A	N/A	N/A	N/A	N/A
34	Transmission-Contact From Object	Balloon contact	N/A	N/A	N/A	N/A	N/A	N/A	N/A	N/A	N/A	N/A	N/A
35	Transmission-Contact From Object	Vehicle contact	N/A	N/A	N/A	N/A	N/A	N/A	N/A	N/A	N/A	N/A	N/A
36	Transmission-Contact From Object	Other contact from object	N/A	N/A	N/A	N/A	N/A	N/A	N/A	N/A	N/A	N/A	N/A
37	Transmission-Contamination	Contamination	N/A	N/A	N/A	N/A	N/A	N/A	N/A	N/A	N/A	N/A	N/A
38	Transmission-Vandalism	Vandalism / Theft	N/A	N/A	N/A	N/A	N/A	N/A	N/A	N/A	N/A	N/A	N/A
39	Transmission-Wire-To-Wire	Wire-to-wire contact / contamination	N/A	N/A	N/A	N/A	N/A	N/A	N/A	N/A	N/A	N/A	N/A
40	Transmission-Equipment/Facility Failure	Anchor / guy damage or failure	N/A	N/A	N/A	N/A	N/A	N/A	N/A	N/A	N/A	N/A	N/A
41	Transmission-Equipment/Facility Failure	Capacitor bank damage or failure	N/A	N/A	N/A	N/A	N/A	N/A	N/A	N/A	N/A	N/A	N/A
42	Transmission-Equipment/Facility Failure	Conductor damage or failure	N/A	N/A	N/A	N/A	N/A	N/A	N/A	N/A	N/A	N/A	N/A
43	Transmission-Equipment/Facility Failure	Connection device damage or failure	N/A	N/A	N/A	N/A	N/A	N/A	N/A	N/A	N/A	N/A	N/A

WMP ID	SH-1	SH-2	SH-4	SH-5	SH-6	SH-10	SH-14	SH-15	SH-16*	SH-17	SH-18
Mitigation Name	Covered Conductor (including Fire-Resistant Poles)	Undergrounding Overhead Conductor	Branch Line Protection	Remote Controlled Automatic Reclosers Settings	Circuit Breaker with Fast Curve Settings	Tree Attachments Remediation	Long Span Initiative	Vertical Switches	Vibration Damper Retrofit	Rapid Earth Fault Current Limiters (REFCL)-Ground Fault Neutralizer (GFN)	Rapid Earth Fault Current Limiters (REFCL)-Grounding Conversions
Useful Life	45	45	15	25	65	45	15	30	45	40	40

Drivers	Driver Type	Subdriver Type	Mitigation Effectiveness	Mitigation Effectiveness	Mitigation Effectiveness	Mitigation Effectiveness	Mitigation Effectiveness	Mitigation Effectiveness	Mitigation Effectiveness	Mitigation Effectiveness	Mitigation Effectiveness	Mitigation Effectiveness	Mitigation Effectiveness
44	Transmission-Equipment/Facility Failure	Connector damage or failure	N/A	N/A	N/A	N/A	N/A	N/A	N/A	N/A	N/A	N/A	N/A
45	Transmission-Equipment/Facility Failure	Crossarm damage or failure	N/A	N/A	N/A	N/A	N/A	N/A	N/A	N/A	N/A	N/A	N/A
46	Transmission-Equipment/Facility Failure	Fuse damage or failure	N/A	N/A	N/A	N/A	N/A	N/A	N/A	N/A	N/A	N/A	N/A
47	Transmission-Equipment/Facility Failure	Insulator and brushing damage or failure	N/A	N/A	N/A	N/A	N/A	N/A	N/A	N/A	N/A	N/A	N/A
48	Transmission-Equipment/Facility Failure	Lightning arrester damage or failure	N/A	N/A	N/A	N/A	N/A	N/A	N/A	N/A	N/A	N/A	N/A
49	Transmission-Equipment/Facility Failure	Other	N/A	N/A	N/A	N/A	N/A	N/A	N/A	N/A	N/A	N/A	N/A
50	Transmission-Equipment/Facility Failure	Recloser damage or failure	N/A	N/A	N/A	N/A	N/A	N/A	N/A	N/A	N/A	N/A	N/A
51	Transmission-Equipment/Facility Failure	Splice damage or failure	N/A	N/A	N/A	N/A	N/A	N/A	N/A	N/A	N/A	N/A	N/A
52	Transmission-Equipment/Facility Failure	Switch damage or failure	N/A	N/A	N/A	N/A	N/A	N/A	N/A	N/A	N/A	N/A	N/A
53	Transmission-Equipment/Facility Failure	Transformer damage or failure	N/A	N/A	N/A	N/A	N/A	N/A	N/A	N/A	N/A	N/A	N/A

WMP ID	SH-1	SH-2	SH-4	SH-5	SH-6	SH-10	SH-14	SH-15	SH-16*	SH-17	SH-18
Mitigation Name	Covered Conductor (including Fire-Resistant Poles)	Undergrounding Overhead Conductor	Branch Line Protection	Remote Controlled Automatic Reclosers Settings	Circuit Breaker with Fast Curve Settings	Tree Attachments Remediation	Long Span Initiative	Vertical Switches	Vibration Damper Retrofit	Rapid Earth Fault Current Limiters (REFCL)-Ground Fault Neutralizer (GFN)	Rapid Earth Fault Current Limiters (REFCL)-Grounding Conversions
Useful Life	45	45	15	25	65	45	15	30	45	40	40

Drivers	Driver Type	Subdriver Type	Mitigation Effectiveness	Mitigation Effectiveness	Mitigation Effectiveness	Mitigation Effectiveness	Mitigation Effectiveness	Mitigation Effectiveness	Mitigation Effectiveness	Mitigation Effectiveness	Mitigation Effectiveness	Mitigation Effectiveness	Mitigation Effectiveness
54	Transmission-Equipment/Facility Failure	Voltage regulator / booster damage or failure	N/A	N/A	N/A	N/A	N/A	N/A	N/A	N/A	N/A	N/A	N/A
55	Transmission-Equipment/Facility Failure	Pole damage or failure	N/A	N/A	N/A	N/A	N/A	N/A	N/A	N/A	N/A	N/A	N/A
56	Transmission-Equipment/Facility Failure	Sectionalizer damage or failure	N/A	N/A	N/A	N/A	N/A	N/A	N/A	N/A	N/A	N/A	N/A
57	Transmission-Equipment/Facility Failure	Tap damage or failure	N/A	N/A	N/A	N/A	N/A	N/A	N/A	N/A	N/A	N/A	N/A
58	Transmission-Equipment/Facility Failure	Tie wire damage or failure	N/A	N/A	N/A	N/A	N/A	N/A	N/A	N/A	N/A	N/A	N/A
59	Transmission-Other	All Other	N/A	N/A	N/A	N/A	N/A	N/A	N/A	N/A	N/A	N/A	N/A
60	Transmission-Unknown	Unknown	N/A	N/A	N/A	N/A	N/A	N/A	N/A	N/A	N/A	N/A	N/A

Wildfire Consequence	Mitigation Effectiveness	Mitigation Effectiveness	Mitigation Effectiveness	Mitigation Effectiveness	Mitigation Effectiveness	Mitigation Effectiveness	Mitigation Effectiveness	Mitigation Effectiveness	Mitigation Effectiveness	Mitigation Effectiveness	Mitigation Effectiveness	Mitigation Effectiveness
<i>Safety</i>	N/A	N/A	N/A	N/A	N/A	N/A	N/A	N/A	N/A	N/A	N/A	N/A
<i>Reliability</i>	N/A	N/A	N/A	N/A	N/A	N/A	N/A	N/A	N/A	N/A	N/A	N/A
<i>Financial</i>	N/A	N/A	N/A	N/A	N/A	N/A	N/A	N/A	N/A	N/A	N/A	N/A

PSPS Consequence	Mitigation Effectiveness	Mitigation Effectiveness	Mitigation Effectiveness	Mitigation Effectiveness	Mitigation Effectiveness	Mitigation Effectiveness	Mitigation Effectiveness	Mitigation Effectiveness	Mitigation Effectiveness	Mitigation Effectiveness	Mitigation Effectiveness	Mitigation Effectiveness
<i>Safety</i>	N/A	N/A	N/A	N/A	N/A	N/A	N/A	N/A	N/A	N/A	N/A	N/A
<i>Reliability</i>	N/A	N/A	N/A	N/A	N/A	N/A	N/A	N/A	N/A	N/A	N/A	N/A

WMP ID	SH-1	SH-2	SH-4	SH-5	SH-6	SH-10	SH-14	SH-15	SH-16*	SH-17	SH-18
Mitigation Name	Covered Conductor (including Fire-Resistant Poles)	Undergrounding Overhead Conductor	Branch Line Protection	Remote Controlled Automatic Reclosers Settings	Circuit Breaker with Fast Curve Settings	Tree Attachments Remediation	Long Span Initiative	Vertical Switches	Vibration Damper Retrofit	Rapid Earth Fault Current Limiters (REFCL)-Ground Fault Neutralizer (GFN)	Rapid Earth Fault Current Limiters (REFCL)-Grounding Conversions
Useful Life	45	45	15	25	65	45	15	30	45	40	40

Drivers	Driver Type	Subdriver Type	Mitigation Effectiveness	Mitigation Effectiveness	Mitigation Effectiveness	Mitigation Effectiveness	Mitigation Effectiveness	Mitigation Effectiveness	Mitigation Effectiveness	Mitigation Effectiveness	Mitigation Effectiveness	Mitigation Effectiveness	Mitigation Effectiveness
		<i>Financial</i>	N/A	N/A	N/A	N/A	N/A	N/A	N/A	N/A	N/A	N/A	N/A

*Vibration dampers help maintain the useful life of covered conductor and therefore mirrors the covered conductor effectiveness

WMP ID	IN-1.1	IN-1.2a	IN-1.2b	IN-3	IN-4	IN-5	IN-9a	IN-9b
Mitigation Name	Distribution High Fire Risk-Informed (HFRI) Inspections & Remediations	Transmission High Fire Risk-Informed (HFRI) Inspections & Remediations (Ground)	Transmission High Fire Risk-Informed (HFRI) Inspections & Remediations (Aerial)	Infrared of Distribution electrical lines & equipment	Infrared of Transmission electrical lines & equipment	Generation High Fire Risk-Informed Inspections and Remediations in HFRA	Transmission Conductor & Splice Assessment (Spans1 with LineVue)	Transmission Conductor & Splice Assessment (Splices2 with Xray)
Useful Life	30	30	30	30	30	30	30	30

Drivers	Driver Type	Subdriver Type	Mitigation Effectiveness	Mitigation Effectiveness	Mitigation Effectiveness	Mitigation Effectiveness	Mitigation Effectiveness	Mitigation Effectiveness	Mitigation Effectiveness	Mitigation Effectiveness
1	Distribution-Contact From Object	Veg. contact	36%	N/A	N/A	0%	N/A	36%	N/A	N/A
2	Distribution-Contact From Object	Animal contact	66%	N/A	N/A	0%	N/A	62%	N/A	N/A
3	Distribution-Contact From Object	Balloon contact	0%	N/A	N/A	0%	N/A	0%	N/A	N/A
4	Distribution-Contact From Object	Vehicle contact	0%	N/A	N/A	0%	N/A	0%	N/A	N/A
5	Distribution-Contact From Object	Unknown contact	0%	N/A	N/A	0%	N/A	0%	N/A	N/A
6	Distribution-Unknown	Unknown	12%	N/A	N/A	0%	N/A	0%	N/A	N/A
7	Distribution-Contact From Object	Other contact from object	96%	N/A	N/A	0%	N/A	96%	N/A	N/A
8	Distribution-Wire-To-Wire	Wire-to-wire contact / contamination	0%	N/A	N/A	0%	N/A	0%	N/A	N/A
9	Distribution-Equipment/Facility Failure	Anchor / guy damage or failure	96%	N/A	N/A	0%	N/A	96%	N/A	N/A
10	Distribution-Equipment/Facility Failure	Conductor damage or failure	78%	N/A	N/A	0%	N/A	76%	N/A	N/A
11	Distribution-Equipment/Facility Failure	Connection device damage or failure	0%	N/A	N/A	0%	N/A	0%	N/A	N/A

WMP ID	IN-1.1	IN-1.2a	IN-1.2b	IN-3	IN-4	IN-5	IN-9a	IN-9b
Mitigation Name	Distribution High Fire Risk-Informed (HFRI) Inspections & Remediations	Transmission High Fire Risk-Informed (HFRI) Inspections & Remediations (Ground)	Transmission High Fire Risk-Informed (HFRI) Inspections & Remediations (Aerial)	Infrared of Distribution electrical lines & equipment	Infrared of Transmission electrical lines & equipment	Generation High Fire Risk-Informed Inspections and Remediations in HFRA	Transmission Conductor & Splice Assessment (Spans1 with LineVue)	Transmission Conductor & Splice Assessment (Splices2 with Xray)
Useful Life	30	30	30	30	30	30	30	30

Drivers	Driver Type	Subdriver Type	Mitigation Effectiveness	Mitigation Effectiveness	Mitigation Effectiveness	Mitigation Effectiveness	Mitigation Effectiveness	Mitigation Effectiveness	Mitigation Effectiveness	Mitigation Effectiveness
12	Distribution-Equipment/Facility Failure	Connector damage or failure	86%	N/A	N/A	22%	N/A	97%	N/A	N/A
13	Distribution-Equipment/Facility Failure	Crossarm damage or failure	94%	N/A	N/A	0%	N/A	91%	N/A	N/A
14	Distribution-Equipment/Facility Failure	Fuse damage or failure	81%	N/A	N/A	1%	N/A	81%	N/A	N/A
15	Distribution-Equipment/Facility Failure	Insulator and bushing damage or failure	94%	N/A	N/A	0%	N/A	92%	N/A	N/A
16	Distribution-Equipment/Facility Failure	Lightning arrestor damage or failure	95%	N/A	N/A	11%	N/A	95%	N/A	N/A
17	Distribution-Equipment/Facility Failure	Other	0%	N/A	N/A	0%	N/A	0%	N/A	N/A
18	Distribution-Equipment/Facility Failure	Pole damage or failure	95%	N/A	N/A	0%	N/A	94%	N/A	N/A
19	Distribution-Equipment/Facility Failure	Recloser damage or failure	97%	N/A	N/A	0%	N/A	97%	N/A	N/A
20	Distribution-Equipment/Facility Failure	Splice damage or failure	97%	N/A	N/A	97%	N/A	97%	N/A	N/A
21	Distribution-Equipment/Facility Failure	Tie wire damage or failure	0%	N/A	N/A	0%	N/A	0%	N/A	N/A
22	Distribution-Equipment/Facility Failure	Voltage regulator / booster	48%	N/A	N/A	72%	N/A	48%	N/A	N/A

WMP ID	IN-1.1	IN-1.2a	IN-1.2b	IN-3	IN-4	IN-5	IN-9a	IN-9b
Mitigation Name	Distribution High Fire Risk-Informed (HFRI) Inspections & Remediations	Transmission High Fire Risk-Informed (HFRI) Inspections & Remediations (Ground)	Transmission High Fire Risk-Informed (HFRI) Inspections & Remediations (Aerial)	Infrared of Distribution electrical lines & equipment	Infrared of Transmission electrical lines & equipment	Generation High Fire Risk-Informed Inspections and Remediations in HFRA	Transmission Conductor & Splice Assessment (Spans1 with LineVue)	Transmission Conductor & Splice Assessment (Splices2 with Xray)
Useful Life	30	30	30	30	30	30	30	30

Drivers	Driver Type	Subdriver Type	Mitigation Effectiveness	Mitigation Effectiveness	Mitigation Effectiveness	Mitigation Effectiveness	Mitigation Effectiveness	Mitigation Effectiveness	Mitigation Effectiveness	Mitigation Effectiveness
		damage or failure								
23	Distribution-Contamination	Contamination	0%	N/A	N/A	0%	N/A	0%	N/A	N/A
24	Distribution-Equipment/Facility Failure	Capacitor bank damage or failure	56%	N/A	N/A	0%	N/A	50%	N/A	N/A
25	Distribution-Equipment/Facility Failure	Switch damage or failure	64%	N/A	N/A	26%	N/A	53%	N/A	N/A
26	Distribution-Equipment/Facility Failure	Transformer damage or failure	40%	N/A	N/A	1%	N/A	34%	N/A	N/A
27	Distribution-Equipment/Facility Failure	Tap damage or failure	0%	N/A	N/A	0%	N/A	0%	N/A	N/A
28	Distribution-Equipment/Facility Failure	Sectionalizer damage or failure	0%	N/A	N/A	0%	N/A	0%	0%	0%
29	Distribution-Other	All Other	89%	N/A	N/A	0%	N/A	86%	0%	0%
30	Distribution-Utility Work	Utility work / Operation	0%	N/A	N/A	0%	N/A	0%	0%	0%
31	Distribution-Vandalism	Vandalism / Theft	0%	N/A	N/A	0%	N/A	0%	0%	0%
32	Transmission-Contact From Object	Veg. contact	N/A	36%	36%	N/A	0%	N/A	0%	0%
33	Transmission-Contact From Object	Animal contact	N/A	82%	88%	N/A	0%	N/A	0%	0%
34	Transmission-Contact From Object	Balloon contact	N/A	0%	0%	N/A	0%	N/A	0%	0%

WMP ID	IN-1.1	IN-1.2a	IN-1.2b	IN-3	IN-4	IN-5	IN-9a	IN-9b
Mitigation Name	Distribution High Fire Risk-Informed (HFRI) Inspections & Remediations	Transmission High Fire Risk-Informed (HFRI) Inspections & Remediations (Ground)	Transmission High Fire Risk-Informed (HFRI) Inspections & Remediations (Aerial)	Infrared of Distribution electrical lines & equipment	Infrared of Transmission electrical lines & equipment	Generation High Fire Risk-Informed Inspections and Remediations in HFRA	Transmission Conductor & Splice Assessment (Spans1 with LineVue)	Transmission Conductor & Splice Assessment (Splices2 with Xray)
Useful Life	30	30	30	30	30	30	30	30

Drivers	Driver Type	Subdriver Type	Mitigation Effectiveness	Mitigation Effectiveness	Mitigation Effectiveness	Mitigation Effectiveness	Mitigation Effectiveness	Mitigation Effectiveness	Mitigation Effectiveness	Mitigation Effectiveness
35	Transmission-Contact From Object	Vehicle contact	N/A	0%	0%	N/A	0%	N/A	0%	0%
36	Transmission-Contact From Object	Other contact from object	N/A	29%	38%	N/A	0%	N/A	0%	0%
37	Transmission-Contamination	Contamination	N/A	97%	97%	N/A	0%	N/A	0%	0%
38	Transmission-Vandalism	Vandalism / Theft	N/A	0%	0%	N/A	0%	N/A	96%	0%
39	Transmission-Wire-To-Wire	Wire-to-wire contact / contamination	N/A	0%	0%	N/A	0%	N/A	0%	0%
40	Transmission-Equipment/Facility Failure	Anchor / guy damage or failure	N/A	89%	94%	N/A	0%	N/A	0%	0%
41	Transmission-Equipment/Facility Failure	Capacitor bank damage or failure	N/A	0%	0%	N/A	0%	N/A	0%	0%
42	Transmission-Equipment/Facility Failure	Conductor damage or failure	N/A	67%	82%	N/A	31%	N/A	0%	0%
43	Transmission-Equipment/Facility Failure	Connection device damage or failure	N/A	0%	0%	N/A	0%	N/A	0%	0%
44	Transmission-Equipment/Facility Failure	Connector damage or failure	N/A	0%	97%	N/A	97%	N/A	0%	0%
45	Transmission-Equipment/Facility Failure	Crossarm damage or failure	N/A	88%	96%	N/A	0%	N/A	0%	0%

WMP ID	IN-1.1	IN-1.2a	IN-1.2b	IN-3	IN-4	IN-5	IN-9a	IN-9b
Mitigation Name	Distribution High Fire Risk-Informed (HFRI) Inspections & Remediations	Transmission High Fire Risk-Informed (HFRI) Inspections & Remediations (Ground)	Transmission High Fire Risk-Informed (HFRI) Inspections & Remediations (Aerial)	Infrared of Distribution electrical lines & equipment	Infrared of Transmission electrical lines & equipment	Generation High Fire Risk-Informed Inspections and Remediations in HFRA	Transmission Conductor & Splice Assessment (Spans1 with LineVue)	Transmission Conductor & Splice Assessment (Splices2 with Xray)
Useful Life	30	30	30	30	30	30	30	30

Drivers	Driver Type	Subdriver Type	Mitigation Effectiveness	Mitigation Effectiveness	Mitigation Effectiveness	Mitigation Effectiveness	Mitigation Effectiveness	Mitigation Effectiveness	Mitigation Effectiveness	Mitigation Effectiveness
46	Transmission-Equipment/Facility Failure	Fuse damage or failure	N/A	0%	0%	N/A	0%	N/A	0%	0%
47	Transmission-Equipment/Facility Failure	Insulator and brushing damage or failure	N/A	93%	96%	N/A	14%	N/A	0%	96%
48	Transmission-Equipment/Facility Failure	Lightning arrestor damage or failure	N/A	0%	0%	N/A	0%	N/A	0%	0%
49	Transmission-Equipment/Facility Failure	Other	N/A	79%	88%	N/A	24%	N/A	0%	0%
50	Transmission-Equipment/Facility Failure	Recloser damage or failure	N/A	0%	0%	N/A	0%	N/A	0%	0%
51	Transmission-Equipment/Facility Failure	Splice damage or failure	N/A	97%	97%	N/A	97%	N/A	0%	0%
52	Transmission-Equipment/Facility Failure	Switch damage or failure	N/A	0%	0%	N/A	0%	N/A	0%	0%
53	Transmission-Equipment/Facility Failure	Transformer damage or failure	N/A	0%	0%	N/A	0%	N/A	0%	0%
54	Transmission-Equipment/Facility Failure	Voltage regulator / booster damage or failure	N/A	0%	0%	N/A	0%	N/A	0%	0%
55	Transmission-Equipment/Facility Failure	Pole damage or failure	N/A	96%	96%	N/A	0%	N/A	0%	0%

WMP ID	IN-1.1	IN-1.2a	IN-1.2b	IN-3	IN-4	IN-5	IN-9a	IN-9b
Mitigation Name	Distribution High Fire Risk-Informed (HFRI) Inspections & Remediations	Transmission High Fire Risk-Informed (HFRI) Inspections & Remediations (Ground)	Transmission High Fire Risk-Informed (HFRI) Inspections & Remediations (Aerial)	Infrared of Distribution electrical lines & equipment	Infrared of Transmission electrical lines & equipment	Generation High Fire Risk-Informed Inspections and Remediations in HFRA	Transmission Conductor & Splice Assessment (Spans1 with LineVue)	Transmission Conductor & Splice Assessment (Splices2 with Xray)
Useful Life	30	30	30	30	30	30	30	30

Drivers	Driver Type	Subdriver Type	Mitigation Effectiveness	Mitigation Effectiveness	Mitigation Effectiveness	Mitigation Effectiveness	Mitigation Effectiveness	Mitigation Effectiveness	Mitigation Effectiveness	Mitigation Effectiveness
56	Transmission-Equipment/Facility Failure	Sectionalizer damage or failure	N/A	0%	0%	N/A	0%	N/A	0%	0%
57	Transmission-Equipment/Facility Failure	Tap damage or failure	N/A	0%	0%	N/A	0%	N/A	0%	0%
58	Transmission-Equipment/Facility Failure	Tie wire damage or failure	N/A	0%	0%	N/A	0%	N/A	0%	0%
59	Transmission-Other	All Other	N/A	73%	89%	N/A	0%	N/A	0%	0%
60	Transmission-Unknown	Unknown	N/A	0%	0%	N/A	0%	N/A	0%	0%

Wildfire Consequence	Mitigation Effectiveness	Mitigation Effectiveness	Mitigation Effectiveness	Mitigation Effectiveness	Mitigation Effectiveness	Mitigation Effectiveness	Mitigation Effectiveness	Mitigation Effectiveness	Mitigation Effectiveness
Safety	N/A	N/A	N/A	N/A	N/A	N/A	N/A	N/A	N/A
Reliability	N/A	N/A	N/A	N/A	N/A	N/A	N/A	N/A	N/A
Financial	N/A	N/A	N/A	N/A	N/A	N/A	N/A	N/A	N/A

PSPS Consequence	Mitigation Effectiveness	Mitigation Effectiveness	Mitigation Effectiveness	Mitigation Effectiveness	Mitigation Effectiveness	Mitigation Effectiveness	Mitigation Effectiveness	Mitigation Effectiveness	Mitigation Effectiveness
Safety	N/A	N/A	N/A	N/A	N/A	N/A	N/A	N/A	N/A
Reliability	N/A	N/A	N/A	N/A	N/A	N/A	N/A	N/A	N/A
Financial	N/A	N/A	N/A	N/A	N/A	N/A	N/A	N/A	N/A

WMP ID	SA-1	SA-3	SA-8	SA-10a
Mitigation Name	Weather Stations	Weather and Fuels Modeling System	Fire Science	High Definition Cameras
Useful Life	10	1	1	7

Wildfire Consequence	Mitigation Effectiveness	Mitigation Effectiveness	Mitigation Effectiveness	Mitigation Effectiveness
<i>Safety</i>	N/A	N/A	N/A	5%
<i>Reliability</i>	N/A	N/A	N/A	5%
<i>Financial</i>	N/A	N/A	N/A	5%

PSPS Consequence	Mitigation Effectiveness	Mitigation Effectiveness	Mitigation Effectiveness	Mitigation Effectiveness
<i>Safety</i>	32%	3%	2%	1%
<i>Reliability</i>	32%	3%	2%	1%
<i>Financial</i>	32%	3%	2%	1%

WMP ID	VM-1	VM-2	VM-3	VM-4	VM-7	VM-8
Mitigation Name	Hazard Tree Management Program	Structure Brushing	Expanded Clearances for Legacy Facilities	Dead and Dying Tree Removal	Expanded Line Clearing (Distribution)	Expanded Line Clearing (Transmission)
Useful Life	60	1	3	60	1	1

Drivers	Driver Type	Subdriver Type	Mitigation Effectiveness	Mitigation Effectiveness	Mitigation Effectiveness	Mitigation Effectiveness	Mitigation Effectiveness	Mitigation Effectiveness
1	Distribution-Contact From Object	Veg. contact	63%	0%	37%	52%	37%	N/A
2	Distribution-Contact From Object	Animal contact	0%	0%	0%	0%	0%	N/A
3	Distribution-Contact From Object	Balloon contact	0%	0%	0%	0%	0%	N/A
4	Distribution-Contact From Object	Vehicle contact	0%	0%	0%	0%	0%	N/A
5	Distribution-Contact From Object	Unknown contact	0%	0%	0%	0%	0%	N/A
6	Distribution-Unknown	Unknown	0%	0%	0%	0%	0%	N/A
7	Distribution-Contact From Object	Other contact from object	0%	0%	0%	0%	0%	N/A
8	Distribution-Wire-To-Wire	Wire-to-wire contact / contamination	0%	0%	0%	0%	0%	N/A
9	Distribution-Equipment/Facility Failure	Anchor / guy damage or failure	0%	0%	0%	0%	0%	N/A
10	Distribution-Equipment/Facility Failure	Conductor damage or failure	0%	0%	0%	0%	0%	N/A
11	Distribution-Equipment/Facility Failure	Connection device damage or failure	0%	39%	39%	0%	0%	N/A
12	Distribution-Equipment/Facility Failure	Connector damage or failure	0%	39%	39%	0%	0%	N/A
13	Distribution-Equipment/Facility Failure	Crossarm damage or failure	0%	39%	39%	0%	0%	N/A
14	Distribution-Equipment/Facility Failure	Fuse damage or failure	0%	39%	39%	0%	0%	N/A
15	Distribution-Equipment/Facility Failure	Insulator and bushing damage or failure	0%	39%	39%	0%	0%	N/A

WMP ID	VM-1	VM-2	VM-3	VM-4	VM-7	VM-8
Mitigation Name	Hazard Tree Management Program	Structure Brushing	Expanded Clearances for Legacy Facilities	Dead and Dying Tree Removal	Expanded Line Clearing (Distribution)	Expanded Line Clearing (Transmission)
Useful Life	60	1	3	60	1	1

Drivers	Driver Type	Subdriver Type	Mitigation Effectiveness	Mitigation Effectiveness	Mitigation Effectiveness	Mitigation Effectiveness	Mitigation Effectiveness	Mitigation Effectiveness
16	Distribution-Equipment/Facility Failure	Lightning arrestor damage or failure	0%	39%	39%	0%	0%	N/A
17	Distribution-Equipment/Facility Failure	Other	0%	39%	39%	0%	0%	N/A
18	Distribution-Equipment/Facility Failure	Pole damage or failure	0%	0%	0%	0%	0%	N/A
19	Distribution-Equipment/Facility Failure	Recloser damage or failure	0%	39%	0%	0%	0%	N/A
20	Distribution-Equipment/Facility Failure	Splice damage or failure	0%	0%	0%	0%	0%	N/A
21	Distribution-Equipment/Facility Failure	Tie wire damage or failure	0%	0%	0%	0%	0%	N/A
22	Distribution-Equipment/Facility Failure	Voltage regulator / booster damage or failure	0%	39%	39%	0%	0%	N/A
23	Distribution-Contamination	Contamination	0%	0%	0%	0%	0%	N/A
24	Distribution-Equipment/Facility Failure	Capacitor bank damage or failure	0%	39%	39%	0%	0%	N/A
25	Distribution-Equipment/Facility Failure	Switch damage or failure	0%	39%	39%	0%	0%	N/A
26	Distribution-Equipment/Facility Failure	Transformer damage or failure	0%	39%	39%	0%	0%	N/A
27	Distribution-Equipment/Facility Failure	Tap damage or failure	0%	0%	0%	0%	0%	N/A
28	Distribution-Equipment/Facility Failure	Sectionalizer damage or failure	0%	39%	39%	0%	0%	N/A
29	Distribution-Other	All Other	0%	0%	0%	0%	0%	N/A

WMP ID	VM-1	VM-2	VM-3	VM-4	VM-7	VM-8
Mitigation Name	Hazard Tree Management Program	Structure Brushing	Expanded Clearances for Legacy Facilities	Dead and Dying Tree Removal	Expanded Line Clearing (Distribution)	Expanded Line Clearing (Transmission)
Useful Life	60	1	3	60	1	1

Drivers	Driver Type	Subdriver Type	Mitigation Effectiveness	Mitigation Effectiveness	Mitigation Effectiveness	Mitigation Effectiveness	Mitigation Effectiveness	Mitigation Effectiveness
30	Distribution-Utility Work	Utility work / Operation	0%	0%	0%	0%	0%	N/A
31	Distribution-Vandalism	Vandalism / Theft	0%	0%	0%	0%	0%	N/A
32	Transmission-Contact From Object	Veg. contact	63%	N/A	N/A	52%	N/A	37%
33	Transmission-Contact From Object	Animal contact	0%	N/A	N/A	0%	N/A	0%
34	Transmission-Contact From Object	Balloon contact	0%	N/A	N/A	0%	N/A	0%
35	Transmission-Contact From Object	Vehicle contact	0%	N/A	N/A	0%	N/A	0%
36	Transmission-Contact From Object	Other contact from object	0%	N/A	N/A	0%	N/A	0%
37	Transmission-Contamination	Contamination	0%	N/A	N/A	0%	N/A	0%
38	Transmission-Vandalism	Vandalism / Theft	0%	N/A	N/A	0%	N/A	0%
39	Transmission-Wire-To-Wire	Wire-to-wire contact / contamination	0%	N/A	N/A	0%	N/A	0%
40	Transmission-Equipment/Facility Failure	Anchor / guy damage or failure	0%	N/A	N/A	0%	N/A	0%
41	Transmission-Equipment/Facility Failure	Capacitor bank damage or failure	0%	N/A	N/A	0%	N/A	0%
42	Transmission-Equipment/Facility Failure	Conductor damage or failure	0%	N/A	N/A	0%	N/A	0%
43	Transmission-Equipment/Facility Failure	Connection device damage or failure	0%	N/A	N/A	0%	N/A	0%
44	Transmission-Equipment/Facility Failure	Connector damage or failure	0%	N/A	N/A	0%	N/A	0%
45	Transmission-Equipment/Facility Failure	Crossarm damage or failure	0%	N/A	N/A	0%	N/A	0%

WMP ID	VM-1	VM-2	VM-3	VM-4	VM-7	VM-8
Mitigation Name	Hazard Tree Management Program	Structure Brushing	Expanded Clearances for Legacy Facilities	Dead and Dying Tree Removal	Expanded Line Clearing (Distribution)	Expanded Line Clearing (Transmission)
Useful Life	60	1	3	60	1	1

Drivers	Driver Type	Subdriver Type	Mitigation Effectiveness	Mitigation Effectiveness	Mitigation Effectiveness	Mitigation Effectiveness	Mitigation Effectiveness	Mitigation Effectiveness
46	Transmission-Equipment/Facility Failure	Fuse damage or failure	0%	N/A	N/A	0%	N/A	0%
47	Transmission-Equipment/Facility Failure	Insulator and brushing damage or failure	0%	N/A	N/A	0%	N/A	0%
48	Transmission-Equipment/Facility Failure	Lightning arrestor damage or failure	0%	N/A	N/A	0%	N/A	0%
49	Transmission-Equipment/Facility Failure	Other	0%	N/A	N/A	0%	N/A	0%
50	Transmission-Equipment/Facility Failure	Recloser damage or failure	0%	N/A	N/A	0%	N/A	0%
51	Transmission-Equipment/Facility Failure	Splice damage or failure	0%	N/A	N/A	0%	N/A	0%
52	Transmission-Equipment/Facility Failure	Switch damage or failure	0%	N/A	N/A	0%	N/A	0%
53	Transmission-Equipment/Facility Failure	Transformer damage or failure	0%	N/A	N/A	0%	N/A	0%
54	Transmission-Equipment/Facility Failure	Voltage regulator / booster damage or failure	0%	N/A	N/A	0%	N/A	0%
55	Transmission-Equipment/Facility Failure	Pole damage or failure	0%	N/A	N/A	0%	N/A	0%
56	Transmission-Equipment/Facility Failure	Sectionalizer damage or failure	0%	N/A	N/A	0%	N/A	0%
57	Transmission-Equipment/Facility Failure	Tap damage or failure	0%	N/A	N/A	0%	N/A	0%
58	Transmission-Equipment/Facility Failure	Tie wire damage or failure	0%	N/A	N/A	0%	N/A	0%

WMP ID	VM-1	VM-2	VM-3	VM-4	VM-7	VM-8
Mitigation Name	Hazard Tree Management Program	Structure Brushing	Expanded Clearances for Legacy Facilities	Dead and Dying Tree Removal	Expanded Line Clearing (Distribution)	Expanded Line Clearing (Transmission)
Useful Life	60	1	3	60	1	1

Drivers	Driver Type	Subdriver Type	Mitigation Effectiveness	Mitigation Effectiveness	Mitigation Effectiveness	Mitigation Effectiveness	Mitigation Effectiveness	Mitigation Effectiveness
59	Transmission-Other	All Other	0%	N/A	N/A	0%	N/A	0%
60	Transmission-Unknown	Unknown	0%	N/A	N/A	0%	N/A	0%

Wildfire Consequence	Mitigation Effectiveness	Mitigation Effectiveness	Mitigation Effectiveness	Mitigation Effectiveness	Mitigation Effectiveness	Mitigation Effectiveness
<i>Safety</i>	N/A	N/A	N/A	N/A	N/A	N/A
<i>Reliability</i>	N/A	N/A	N/A	N/A	N/A	N/A
<i>Financial</i>	N/A	N/A	N/A	N/A	N/A	N/A

PSPS Consequence	Mitigation Effectiveness	Mitigation Effectiveness	Mitigation Effectiveness	Mitigation Effectiveness	Mitigation Effectiveness	Mitigation Effectiveness
<i>Safety</i>	N/A	N/A	N/A	N/A	N/A	N/A
<i>Reliability</i>	N/A	N/A	N/A	N/A	N/A	N/A
<i>Financial</i>	N/A	N/A	N/A	N/A	N/A	N/A

WMP ID	PSPS-2	PSPS-3	DEP-5
Mitigation Name	Customer Care Programs (Critical Care Backup Battery (CCBB) Program)	Customer Care Programs (Portable Power Station and Generator Rebates)	Aerial Suppression
Useful Life	3	3	1

Wildfire Consequence	Mitigation Effectiveness	Mitigation Effectiveness	Mitigation Effectiveness
<i>Safety</i>	N/A	N/A	2.4%
<i>Reliability</i>	N/A	N/A	2.4%
<i>Financial</i>	N/A	N/A	2.4%

PSPS Consequence	Mitigation Effectiveness	Mitigation Effectiveness	Mitigation Effectiveness
<i>Safety</i>	28%	8%	N/A
<i>Reliability</i>	28%	8%	N/A
<i>Financial</i>	28%	8%	N/A

WMP ID	N/A	N/A	SA-11	SH-8	N/A	SA-10b
Mitigation Name	Distribution Open Phase Detection (DOPD)	High Impedence (Hi-Z) Relays	Early Fault Detection (EFD)	Transmission Open Phase Detection (TOPD)	Fire resistant wrap Retrofit on dead-end poles	Satellite and Other Imaging Technology for Fire Spotting
Useful Life	65	65	20	65	45	7

Drivers	Driver Type	Subdriver Type	Mitigation Effectiveness	Mitigation Effectiveness	Mitigation Effectiveness	Mitigation Effectiveness	Mitigation Effectiveness	Mitigation Effectiveness
1	Distribution-Contact From Object	Veg. contact	2%	2%	7%	N/A	N/A	N/A
2	Distribution-Contact From Object	Animal contact	2%	2%	3%	N/A	N/A	N/A
3	Distribution-Contact From Object	Balloon contact	2%	2%	3%	N/A	N/A	N/A
4	Distribution-Contact From Object	Vehicle contact	2%	2%	0%	N/A	N/A	N/A
5	Distribution-Contact From Object	Unknown contact	2%	2%	0%	N/A	N/A	N/A
6	Distribution-Unknown	Unknown	2%	2%	10%	N/A	N/A	N/A
7	Distribution-Contact From Object	Other contact from object	2%	2%	0%	N/A	N/A	N/A
8	Distribution-Wire-To-Wire	Wire-to-wire contact / contamination	0%	0%	10%	N/A	N/A	N/A
9	Distribution-Equipment/Facility Failure	Anchor / guy damage or failure	2%	2%	0%	N/A	N/A	N/A
10	Distribution-Equipment/Facility Failure	Conductor damage or failure	2%	2%	9%	N/A	N/A	N/A
11	Distribution-Equipment/Facility Failure	Connection device damage or failure	2%	2%	10%	N/A	N/A	N/A
12	Distribution-Equipment/Facility Failure	Connector damage or failure	2%	2%	22%	N/A	N/A	N/A
13	Distribution-Equipment/Facility Failure	Crossarm damage or failure	2%	2%	0%	N/A	N/A	N/A
14	Distribution-Equipment/Facility Failure	Fuse damage or failure	0%	2%	2%	N/A	N/A	N/A
15	Distribution-Equipment/Facility Failure	Insulator and bushing damage or failure	2%	2%	18%	N/A	N/A	N/A
16	Distribution-Equipment/Facility Failure	Lightning arrestor damage or failure	0%	2%	2%	N/A	N/A	N/A
17	Distribution-Equipment/Facility Failure	Other	2%	2%	0%	N/A	N/A	N/A
18	Distribution-Equipment/Facility Failure	Pole damage or failure	2%	2%	0%	N/A	N/A	N/A
19	Distribution-Equipment/Facility Failure	Recloser damage or failure	0%	2%	5%	N/A	N/A	N/A

WMP ID	N/A	N/A	SA-11	SH-8	N/A	SA-10b
Mitigation Name	Distribution Open Phase Detection (DOPD)	High Impedence (Hi-Z) Relays	Early Fault Detection (EFD)	Transmission Open Phase Detection (TOPD)	Fire resistant wrap Retrofit on dead-end poles	Satellite and Other Imaging Technology for Fire Spotting
Useful Life	65	65	20	65	45	7

Drivers	Driver Type	Subdriver Type	Mitigation Effectiveness	Mitigation Effectiveness	Mitigation Effectiveness	Mitigation Effectiveness	Mitigation Effectiveness	Mitigation Effectiveness
20	Distribution-Equipment/Facility Failure	Splice damage or failure	2%	2%	0%	N/A	N/A	N/A
21	Distribution-Equipment/Facility Failure	Tie wire damage or failure	2%	2%	0%	N/A	N/A	N/A
22	Distribution-Equipment/Facility Failure	Voltage regulator / booster damage or failure	0%	2%	5%	N/A	N/A	N/A
23	Distribution-Contamination	Contamination	2%	2%	2%	N/A	N/A	N/A
24	Distribution-Equipment/Facility Failure	Capacitor bank damage or failure	0%	2%	2%	N/A	N/A	N/A
25	Distribution-Equipment/Facility Failure	Switch damage or failure	0%	2%	13%	N/A	N/A	N/A
26	Distribution-Equipment/Facility Failure	Transformer damage or failure	0%	2%	7%	N/A	N/A	N/A
27	Distribution-Equipment/Facility Failure	Tap damage or failure	2%	2%	0%	N/A	N/A	N/A
28	Distribution-Equipment/Facility Failure	Sectionalizer damage or failure	0%	2%	5%	N/A	N/A	N/A
29	Distribution-Other	All Other	2%	2%	5%	N/A	N/A	N/A
30	Distribution-Utility Work	Utility work / Operation	2%	2%	0%	N/A	N/A	N/A
31	Distribution-Vandalism	Vandalism / Theft	2%	2%	0%	N/A	N/A	N/A
32	Transmission-Contact From Object	Veg. contact	N/A	N/A	5%	0%	N/A	N/A
33	Transmission-Contact From Object	Animal contact	N/A	N/A	10%	0%	N/A	N/A
34	Transmission-Contact From Object	Balloon contact	N/A	N/A	2%	0%	N/A	N/A
35	Transmission-Contact From Object	Vehicle contact	N/A	N/A	0%	5%	N/A	N/A
36	Transmission-Contact From Object	Other contact from object	N/A	N/A	0%	5%	N/A	N/A
37	Transmission-Contamination	Contamination	N/A	N/A	2%	0%	N/A	N/A
38	Transmission-Vandalism	Vandalism / Theft	N/A	N/A	0%	80%	N/A	N/A
39	Transmission-Wire-To-Wire	Wire-to-wire contact / contamination	N/A	N/A	10%	0%	N/A	N/A

WMP ID	N/A	N/A	SA-11	SH-8	N/A	SA-10b
Mitigation Name	Distribution Open Phase Detection (DOPD)	High Impedence (Hi-Z) Relays	Early Fault Detection (EFD)	Transmission Open Phase Detection (TOPD)	Fire resistant wrap Retrofit on dead-end poles	Satellite and Other Imaging Technology for Fire Spotting
Useful Life	65	65	20	65	45	7

Drivers	Driver Type	Subdriver Type	Mitigation Effectiveness	Mitigation Effectiveness	Mitigation Effectiveness	Mitigation Effectiveness	Mitigation Effectiveness	Mitigation Effectiveness
40	Transmission-Equipment/Facility Failure	Anchor / guy damage or failure	N/A	N/A	0%	0%	N/A	N/A
41	Transmission-Equipment/Facility Failure	Capacitor bank damage or failure	N/A	N/A	0%	0%	N/A	N/A
42	Transmission-Equipment/Facility Failure	Conductor damage or failure	N/A	N/A	10%	80%	N/A	N/A
43	Transmission-Equipment/Facility Failure	Connection device damage or failure	N/A	N/A	10%	80%	N/A	N/A
44	Transmission-Equipment/Facility Failure	Connector damage or failure	N/A	N/A	10%	80%	N/A	N/A
45	Transmission-Equipment/Facility Failure	Crossarm damage or failure	N/A	N/A	0%	80%	N/A	N/A
46	Transmission-Equipment/Facility Failure	Fuse damage or failure	N/A	N/A	2%	0%	N/A	N/A
47	Transmission-Equipment/Facility Failure	Insulator and brushing damage or failure	N/A	N/A	5%	0%	N/A	N/A
48	Transmission-Equipment/Facility Failure	Lightning arrestor damage or failure	N/A	N/A	2%	0%	N/A	N/A
49	Transmission-Equipment/Facility Failure	Other	N/A	N/A	5%	0%	N/A	N/A
50	Transmission-Equipment/Facility Failure	Recloser damage or failure	N/A	N/A	0%	0%	N/A	N/A
51	Transmission-Equipment/Facility Failure	Splice damage or failure	N/A	N/A	0%	80%	N/A	N/A
52	Transmission-Equipment/Facility Failure	Switch damage or failure	N/A	N/A	10%	0%	N/A	N/A
53	Transmission-Equipment/Facility Failure	Transformer damage or failure	N/A	N/A	0%	0%	N/A	N/A
54	Transmission-Equipment/Facility Failure	Voltage regulator / booster damage or failure	N/A	N/A	0%	0%	N/A	N/A
55	Transmission-Equipment/Facility Failure	Pole damage or failure	N/A	N/A	0%	0%	N/A	N/A
56	Transmission-Equipment/Facility Failure	Sectionalizer damage or failure	N/A	N/A	0%	0%	N/A	N/A
57	Transmission-Equipment/Facility Failure	Tap damage or failure	N/A	N/A	0%	0%	N/A	N/A

WMP ID	N/A	N/A	SA-11	SH-8	N/A	SA-10b
Mitigation Name	Distribution Open Phase Detection (DOPD)	High Impedance (Hi-Z) Relays	Early Fault Detection (EFD)	Transmission Open Phase Detection (TOPD)	Fire resistant wrap Retrofit on dead-end poles	Satellite and Other Imaging Technology for Fire Spotting
Useful Life	65	65	20	65	45	7

Drivers	Driver Type	Subdriver Type	Mitigation Effectiveness	Mitigation Effectiveness	Mitigation Effectiveness	Mitigation Effectiveness	Mitigation Effectiveness	Mitigation Effectiveness
58	Transmission-Equipment/Facility Failure	Tie wire damage or failure	N/A	N/A	0%	0%	N/A	N/A
59	Transmission-Other	All Other	N/A	N/A	5%	0%	N/A	N/A
60	Transmission-Unknown	Unknown	N/A	N/A	10%	0%	N/A	N/A

Wildfire Consequence	Mitigation Effectiveness	Mitigation Effectiveness	Mitigation Effectiveness	Mitigation Effectiveness	Mitigation Effectiveness	Mitigation Effectiveness
<i>Safety</i>	N/A	N/A	N/A	N/A	N/A	3%
<i>Reliability</i>	N/A	N/A	N/A	N/A	42%	3%
<i>Financial</i>	N/A	N/A	N/A	N/A	N/A	3%

PSPS Consequence	Mitigation Effectiveness	Mitigation Effectiveness	Mitigation Effectiveness	Mitigation Effectiveness	Mitigation Effectiveness	Mitigation Effectiveness
<i>Safety</i>	N/A	N/A	N/A	N/A	N/A	N/A
<i>Reliability</i>	N/A	N/A	N/A	N/A	N/A	N/A
<i>Financial</i>	N/A	N/A	N/A	N/A	N/A	N/A

F3: Continuation of Section 8.4 - Emergency Preparedness

Due to its size, SCE provides Figure SCE 8-52a PSPS Flowchart below.

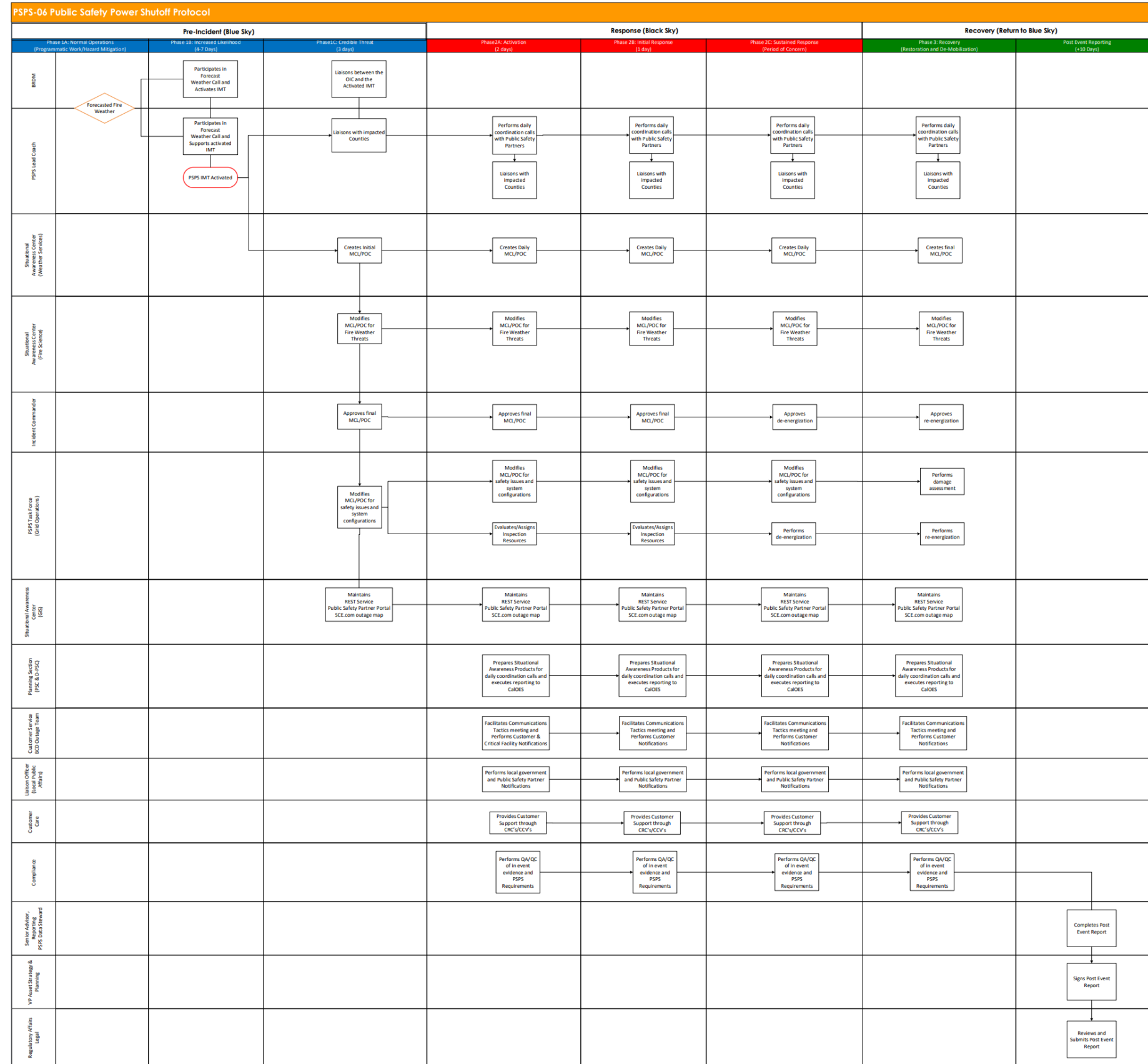

Due to its size, SCE provides PSPS alert and notification schedules below.

PSPS Alert and Notification Schedules

Stakeholder	Advanced Initial	Initial (Alert)	Update (Alert)	Expected (Imminent Shutoff) (Warning) [1]	Shutoff (Statement)	Continued Shutoff (to be sent the following morning at 9:00)	Prep Restore Prepare to Restore (Statement) [2]	All Clear PSPS All Clear - Event Avoided (Statement) [3]	Ended PSPS Ended/Restored & All Clear	Not All Clear PSPS Temporarily Restored; NOT All Clear, PSPS Risk Remains	Language Preference
First/Emergency Responders/Public Safety Partners, local governments, and tribes	72 hours before	48 & 24 hours before	48 & 24 hours before	1-4 hours	When De-Energization Occurs	When de-energization continues overnight, sent to customers the next morning	Before Re-energization Occurs	When circuits are no longer being considered for PSPS and were not de-energized	When circuits were de-energized and have been restored and are no longer being monitored	When circuit is temporarily restored but still at risk for PSPS (usually when there is a break in POC)	Voice Calls - Select number for language preference Emails have re-direct Links to SCE.com for language preference Text has re-direct links to SCE.com for language preference
Critical Infrastructure/Service Providers	72 hours before	48 & 24 hours before	48 & 24 hours before	1-4 hours	When De-Energization Occurs	When de-energization continues overnight, sent to customers the next morning	Before Re-energization Occurs	When circuits are no longer being considered for PSPS and were not de-energized	When circuits were de-energized and have been restored and are no longer being monitored	When circuit is temporarily restored but still at risk for PSPS (usually when there is a break in POC)	Voice Calls - Select number for language preference Emails have re-direct Links to SCE.com for language preference Text has re-direct links to SCE.com for language preference
Customers	N/A	48 hours before	24 hours before	1-4 hours	When De-Energization Occurs	When de-energization continues overnight, sent to customers the next morning	Before Re-energization Occurs	When circuits are no longer being considered for PSPS and were not de-energized	When circuits were de-energized and have been restored and are no longer being monitored	When circuit is temporarily restored but still at risk for PSPS (usually when there is a break in POC)	Voice Calls - Select number for language preference Emails have re-direct Links to SCE.com for language preference Text has re-direct links to SCE.com for language preference

*SCE will target the schedule above to notify customers. Erratic or sudden onset of hazardous conditions that jeopardize public safety may impact SCE's ability to provide advance notice to customers.

[1] SCE will make every attempt to notify customers at the 1-4 hour warning stage. Given the unpredictability of shifting weather during PSPS, implementation of this timeframe may vary.

[2] SCE will attempt to notify customers before re-energization when possible.

[3] SCE needs to send out notification within 2 hours of the MCL/POC is approved by the IC.

F4: Continuation of Section 8.5 – Community Outreach and Engagement

Due to its size, SCE provides Table 8-61 - Collaboration in Local Wildfire Mitigation Planning.

Name of County, City, or Tribal Agency or Civil Society Group (e.g., nongovernment organization, fire safe council)	Program, Plan, or Document	Last Version of Collaboration (Meeting Date)	Level of Collaboration (Subject)
Acton Town Council	General WMP Plan and PSPS Protocols	6/27/2022	Acton Town Council Wildfire Mitigation Update Completed
Acton Town Council	General WMP Plan and PSPS Protocols	6/17/2022	Acton Town Council Concerned About Uptick in Emergency Outages
Adelanto	General WMP Plan and PSPS Protocols	6/9/2022	City of Adelanto Reliability Report and WMP/PSPS Briefing Meeting
Agoura Hills	General WMP Plan and PSPS Protocols	6/21/2022	Wildfire
Agua Caliente Band of Cahuilla Indians	General WMP Plan and PSPS Protocols	5/19/2022	2022 Circuit Reliability Report sent
Agua Dulce Town Council	General WMP Plan and PSPS Protocols	7/13/2022	Agua Dulce Town Council Wildfire Mitigation Update Scheduled
Alhambra	General WMP Plan and PSPS Protocols	6/29/2022	Alhambra: June 2022 Vice Mayor Andrade-Stadler To Attend 6/29 EOC Tour
Aliso Viejo	General WMP Plan and PSPS Protocols	6/30/2022	AV WMP Briefing Follow-Up
Apple Valley	General WMP Plan and PSPS Protocols	6/29/2022	Request for Meeting WMP/Reliability Town of Apple Valley
Arcadia	General WMP Plan and PSPS Protocols	6/9/2022	Arcadia: Public Works Director Attends 2022 SGV Virtual WMP Presentation
Association of California Cities - Orange County (ACCOC)	General WMP Plan and PSPS Protocols	8/25/2022	SCE Presentation to L&R Committee
Avalon	General WMP Plan and PSPS Protocols	5/25/2022	Avalon WMP Briefing
Barstow	General WMP Plan and PSPS Protocols	6/14/2022	City of Barstow Reliability Report and WMP/PSPS Briefing Meeting
Beaumont	General WMP Plan and PSPS Protocols	6/8/2022	WMP Briefing Completed - City of Beaumont
Beverly Hills	General WMP Plan and PSPS Protocols	5/11/2022	Beverly Hills - 2022 Reliability Outreach, Wildfire Presentation and Quarterly Coordination Meeting
Bradbury	General WMP Plan and PSPS Protocols	8/16/2022	Bradbury: August 2022 WMP Council Presentation Held In-Person
Bradbury	General WMP Plan and PSPS Protocols	7/19/2022	Bradbury: July 2022 CM Shares Councilmember Question If City Can Pay for Covered Conductor
Bradbury	General WMP Plan and PSPS Protocols	6/9/2022	Bradbury: City Staff Attended 2022 SGV Virtual WMP Presentation
Bradbury	General WMP Plan and PSPS Protocols	5/3/2022	Bradbury: April 2022 Confirmed CM & Staff Attending 5/3 PSPS-Focused EOC Tour
Brea	General WMP Plan and PSPS Protocols	6/22/2022	2022 Wildfire Mitigation Plan Briefing
Brea	General WMP Plan and PSPS Protocols	6/22/2022	Sharing PSPS customer care program information with city
Calabasas	General WMP Plan and PSPS Protocols	7/7/2022	Wildfire
California Contract Cities Association (CCCA)	General WMP Plan and PSPS Protocols	3/2/2022	CCCA Sacramento Legislative Tour 2022
California Contract Cities Association (CCCA)	General WMP Plan and PSPS Protocols	9/2/2022	6th Annual City Managers' Summit (2022)
California State Senate District 21	General WMP Plan and PSPS Protocols	9/14/2022	Castaic Town Council Complaints About Wildfire Mitigation Road Closures in Val Verde
California State Senate District 21	General WMP Plan and PSPS Protocols	6/22/2022	Outage Update Request from Senator Wilk's Office - Concern about Acton, Medical Customer
Calimesa	General WMP Plan and PSPS Protocols	5/18/2022	WMP Update Briefing - City of Calimesa
Camarillo	General WMP Plan and PSPS Protocols	7/26/2022	Wildfire/Reliability Update
Camarillo	General WMP Plan and PSPS Protocols	2/23/2022	Camarillo City Council Wildfire Mitigation/Rates Update
Canyon Lake	General WMP Plan and PSPS Protocols	6/23/2022	Canyon Lake WMP Meeting
Castaic Area Town Council	General WMP Plan and PSPS Protocols	9/14/2022	Castaic Town Council Complaints About Wildfire Mitigation Road Closures in Val Verde
Cathedral City	General WMP Plan and PSPS Protocols	6/28/2022	Cathedral City - Reliability Report 2022 & Meeting request
Chino	General WMP Plan and PSPS Protocols	8/30/2022	Circuit Reliability & WMP Update City Of Chino 2022
Chino Hills	General WMP Plan and PSPS Protocols	7/26/2022	Wildfire Mitigation Meeting -Chino Hills
Claremont	General WMP Plan and PSPS Protocols	10/11/2022	Claremont 2022 Circuit Reliability Council Presentation
Claremont	General WMP Plan and PSPS Protocols	6/29/2022	Wave 2 - Claremont Circuit Reliability Report

Name of County, City, or Tribal Agency or Civil Society Group (e.g., nongovernment organization, fire safe council)	Program, Plan, or Document	Last Version of Collaboration (Meeting Date)	Level of Collaboration (Subject)
Claremont	General WMP Plan and PSPS Protocols	6/9/2022	2022 WMP/PSPS Email Invite
Claremont	General WMP Plan and PSPS Protocols	5/10/2022	HFRA EOC Tour of May 10
Colton	General WMP Plan and PSPS Protocols	6/20/2022	Colton 2022 Circuit Reliability / Wildfire Update staff presentation
Corona	General WMP Plan and PSPS Protocols	5/31/2022	Corona WMP Meeting
Covina	General WMP Plan and PSPS Protocols	6/9/2022	2022 WMP/PSPS Email Invite
Covina	General WMP Plan and PSPS Protocols	5/10/2022	HFRA EOC Tour
Culver City	General WMP Plan and PSPS Protocols	6/28/2022	Culver City - Wildfire and Reliability Presentation
Desert Hot Springs	General WMP Plan and PSPS Protocols	7/8/2022	Desert Hot Springs - Meeting with Councilmember Gary Gardner
Desert Hot Springs	General WMP Plan and PSPS Protocols	6/30/2022	Desert Hot Springs - WMP Reliability Report 2022 - no meeting needed.
Diamond Bar	General WMP Plan and PSPS Protocols	6/14/2022	Diamond Bar 2022 Circuit Reliability staff presentation
Diamond Bar	General WMP Plan and PSPS Protocols	5/3/2022	HFRA EOC Tour
Diamond Bar	General WMP Plan and PSPS Protocols	6/14/2022	Wave 2 - Diamond Bar Circuit Reliability Report
Duarte	General WMP Plan and PSPS Protocols	6/9/2022	2022 WMP/PSPS Presentation.
Eastvale	General WMP Plan and PSPS Protocols	6/14/2022	Eastvale 2022 Circuit Reliability staff presentation
Exeter	General WMP Plan and PSPS Protocols	6/29/2022	2022 Wildfire Safety Update: City of Exeter
Fillmore	General WMP Plan and PSPS Protocols	6/22/2022	Completed Wildfire Mitigation & Reliability Update for City of Fillmore
Fillmore	General WMP Plan and PSPS Protocols	2/22/2022	City of Fillmore council presentation following PSPS event
Fontana	General WMP Plan and PSPS Protocols	6/30/2022	2022 WMP -Fontana
Fresno County	General WMP Plan and PSPS Protocols	6/2/2022	2022 Wildfire Safety Update: Fresno County
Glendora	General WMP Plan and PSPS Protocols	6/29/2022	Glendora: June 2022 Councilmember Fredendall To Attend 6/29 EOC Tour
Glendora	General WMP Plan and PSPS Protocols	6/9/2022	Glendora: Public Works Director Attends 2022 SGV Virtual WMP Presentation
Glendora	General WMP Plan and PSPS Protocols	5/10/2022	Glendora: April 2022 Confirmed Mayor Davis Attending 5/10 All Hazards-Focused EOC Tour
Grand Terrace	General WMP Plan and PSPS Protocols	6/14/2022	Grand Terrace 2022 Circuit Reliability staff presentation
Greater Irvine Chamber of Commerce (GICC)	General WMP Plan and PSPS Protocols	3/3/2022	GICC March Govt Affairs Committee with Sup Wagner
Hemet	General WMP Plan and PSPS Protocols	6/1/2022	WMP Briefing Completed - City of Hemet
Hesperia	General WMP Plan and PSPS Protocols	6/29/2022	Hesperia 2022 Reliability Report - No meeting needed.
Hidden Hills	General WMP Plan and PSPS Protocols	7/7/2022	Wildfire
Highland	General WMP Plan and PSPS Protocols	6/14/2022	Highland 2022 Circuit Reliability staff presentation
Industry	General WMP Plan and PSPS Protocols	5/3/2022	HFRA EOC Tour
Industry	General WMP Plan and PSPS Protocols	7/14/2022	Industry WMP Communication
Institute for Local Government (ILG)	General WMP Plan and PSPS Protocols	6/23/2022	ILG Webinar - Personal and Organizational Wildfire Preparedness and Prevention.
Inyo County	General WMP Plan and PSPS Protocols	6/6/2022	2022 Wildfire Mitigation Outreach
Inyo County	General WMP Plan and PSPS Protocols	9/7/2022	Inyo County Unified Command - quarterly meeting - multiple agency/stakeholders
Inyo County	General WMP Plan and PSPS Protocols	12/7/2022	Inyo County Unified Command - quarterly meeting - multiple agency/stakeholders
Irvine	General WMP Plan and PSPS Protocols	7/20/2022	Vice Mayor Kuo Wildfire Prevention Event
Irvine	General WMP Plan and PSPS Protocols	6/21/2022	WMP & Reliability Briefing with Irvine Execs
Irvine	General WMP Plan and PSPS Protocols	6/8/2022	Irvine Green Ribbon Committee Presentation
Irvine	General WMP Plan and PSPS Protocols	3/21/2022	Meet & Greet with new City Manager
Irvine	General WMP Plan and PSPS Protocols	6/21/2022	Irvine WMP/Reliability Presentation Request
Irwindale	General WMP Plan and PSPS Protocols	6/29/2022	Tier 3: Irwindale Circuit Reliability Staff Presentation
Irwindale	General WMP Plan and PSPS Protocols	6/9/2022	2022 WMP/PSPS Email Invite
Irwindale	General WMP Plan and PSPS Protocols	5/3/2022	HFRA EOC Tour

Name of County, City, or Tribal Agency or Civil Society Group (e.g., nongovernment organization, fire safe council)	Program, Plan, or Document	Last Version of Collaboration (Meeting Date)	Level of Collaboration (Subject)
Jurupa Valley	General WMP Plan and PSPS Protocols	6/2/2022	WMP Update Briefing City of Jurupa Valley
Kern County	General WMP Plan and PSPS Protocols	6/2/2022	2022 Wildfire Mitigation Outreach
La Canada Flintridge	General WMP Plan and PSPS Protocols	8/2/2022	La Canada Flintridge City Council 2022 Annual Circuit Reliability
La Canada Flintridge	General WMP Plan and PSPS Protocols	6/27/2022	La Canada Flintridge Annual Circuit Reliability city staff presentation
La Canada Flintridge	General WMP Plan and PSPS Protocols	5/3/2022	HFRA EOC Tour
La Canada Flintridge	General WMP Plan and PSPS Protocols	6/9/2022	La Canada Flintridge Wildfire Mitigation Drone Inspections
La Habra	General WMP Plan and PSPS Protocols	6/30/2022	2022 Wildfire Mitigation Plan Briefing
La Habra	General WMP Plan and PSPS Protocols	3/16/2022	PSPS Public Safety Partner Portal
La Habra Heights	General WMP Plan and PSPS Protocols	6/21/2022	La Habra Heights - 2022 Local Reliability/WMP Briefing
La Puente	General WMP Plan and PSPS Protocols	6/9/2022	2022 WMP/PSPS Email Invite
La Verne	General WMP Plan and PSPS Protocols	6/9/2022	2022 WMP/PSPS Email Invite
La Verne	General WMP Plan and PSPS Protocols	5/10/2022	HFRA EOC Tour
Laguna Beach	General WMP Plan and PSPS Protocols	7/6/2022	WMP Briefing, Reliability Review
Laguna Beach	General WMP Plan and PSPS Protocols	2/7/2022	Proposal to ban mylar balloons as wildfire mitigation measure
Lake Elsinore	General WMP Plan and PSPS Protocols	5/9/2022	WMP Update Meeting - Elsinore
Lake Forest	General WMP Plan and PSPS Protocols	8/2/2022	Lake Forest National Night Out
Lake Forest	General WMP Plan and PSPS Protocols	6/10/2022	LF WMP & Reliability Briefing
Lake Forest	General WMP Plan and PSPS Protocols	2/24/2022	Lake Forest/OCFA/OCSD
Lancaster	General WMP Plan and PSPS Protocols	5/9/2022	Lancaster 2022 Reliability Outreach and Quarterly Coordination Meeting
Lindsay	General WMP Plan and PSPS Protocols	6/29/2022	2022 Reliability Outreach: City of Lindsay
Loma Linda	General WMP Plan and PSPS Protocols	6/14/2022	2022 WF/Reliability update for Loma Linda
Los Angeles County	General WMP Plan and PSPS Protocols	10/20/2022	Topanga Emergency Task Force Meeting
Los Angeles County	General WMP Plan and PSPS Protocols	6/21/2022	2022 Reliability Report - LA County Public Works
Los Angeles County	General WMP Plan and PSPS Protocols	6/2/2022	2022 Reliability Report - Supervisor Kuehl Staff
Los Angeles County	General WMP Plan and PSPS Protocols	5/26/2022	2022 Reliability Report - Supervisor Barger Staff
Los Angeles County	General WMP Plan and PSPS Protocols	5/17/2022	Altadena Wildfire Mitigation Presentation
Los Angeles County	General WMP Plan and PSPS Protocols	5/3/2022	Santa Monica Fire Safe Alliance Meeting
Los Angeles County	General WMP Plan and PSPS Protocols	4/20/2022	Topanga Emergency Management Task Force Meeting
Los Angeles County	General WMP Plan and PSPS Protocols	2/2/2022	Santa Monica Mountains Fire Safe Alliance
Los Angeles County	General WMP Plan and PSPS Protocols	1/19/2022	Topanga Emergency Management Task Force
Los Angeles County Business Federation (BizFed)	General WMP Plan and PSPS Protocols	3/1/2022	WMP Update to BizFed Energy & Environment Committee
Madera County	General WMP Plan and PSPS Protocols	6/2/2022	2022 Wildfire Safety Update: Madera County
Malibu	General WMP Plan and PSPS Protocols	7/6/2022	Wildfire-Reliability Update
Malibu	General WMP Plan and PSPS Protocols	6/27/2022	Wildfire
Malibu	General WMP Plan and PSPS Protocols	6/15/2022	Malibu 2022 Wildfire Mitigation Update
Menifee	General WMP Plan and PSPS Protocols	5/31/2022	Menifee WMP Meeting
Mission Viejo	General WMP Plan and PSPS Protocols	7/1/2022	WMP Briefing Request Follow-Up
Mono County	General WMP Plan and PSPS Protocols	11/2/2022	June Lake Citizens Advisory Committee Meeting - Veg. Mgmt. & WMP
Mono County	General WMP Plan and PSPS Protocols	6/3/2022	2022 Wildfire Mitigation Outreach
Mono County	General WMP Plan and PSPS Protocols	9/7/2022	Mono County Unified Command - quarterly meeting - multiple agency/stakeholders
Mono County	General WMP Plan and PSPS Protocols	12/7/2022	Mono County Unified Command - quarterly meeting - multiple agency/stakeholders
Monrovia	General WMP Plan and PSPS Protocols	6/9/2022	2022 WMP/PSPS Presentation.

Name of County, City, or Tribal Agency or Civil Society Group (e.g., nongovernment organization, fire safe council)	Program, Plan, or Document	Last Version of Collaboration (Meeting Date)	Level of Collaboration (Subject)
Montclair	General WMP Plan and PSPS Protocols	6/30/2022	2022 WMP Briefing-Montclair
Moorpark	General WMP Plan and PSPS Protocols	7/6/2022	Wildfire
Moreno Valley	General WMP Plan and PSPS Protocols	8/25/2022	WMP Briefing City of Moreno Valley
Morongo Band of Mission Indians	General WMP Plan and PSPS Protocols	6/1/2022	2022 Tribal Nation PSPS Workshop
Morongo Band of Mission Indians	General WMP Plan and PSPS Protocols	5/24/2022	Circuit Reliability Report Meeting
Morongo Valley Community Services District & Fire Department	General WMP Plan and PSPS Protocols	6/15/2022	Morongo Valley CSD - Board Wildfire Briefing 6/15/2022
Morongo Valley Community Services District & Fire Department	General WMP Plan and PSPS Protocols	5/31/2022	Morongo Valley CSD Wildfire Briefing with Fire Chief and Staff 5/31/22 10 a.m.
Murrieta	General WMP Plan and PSPS Protocols	7/14/2022	WMP Update 2022
Newport Beach	General WMP Plan and PSPS Protocols	6/9/2022	Reliability Review & Wildfire Mitigation / PSPS Briefing
Newport Beach	General WMP Plan and PSPS Protocols	6/9/2022	WMP Briefing, Reliability Review
Norco	General WMP Plan and PSPS Protocols	7/1/2022	Emailed the WMP Briefing - Norco
Ojai	General WMP Plan and PSPS Protocols	6/24/2022	Completed City of Ojai Wildfire Mitigation & Reliability Update
Ontario	General WMP Plan and PSPS Protocols	6/30/2022	Wildfire Mitigation Meeting Req. City of Ontario
Ontario	General WMP Plan and PSPS Protocols	6/14/2022	2022 City of Ontario WMP & Circuit Reliability Briefing
Orange	General WMP Plan and PSPS Protocols	6/6/2022	2022 Wildfire Mitigation Plan Briefing
Orange	General WMP Plan and PSPS Protocols	4/27/2022	PSPS Partner Portal and Notifications
Orange	General WMP Plan and PSPS Protocols	6/6/2022	Maybury HOA Request for PSPS Meeting
Orange Chamber of Commerce	General WMP Plan and PSPS Protocols	4/26/2022	Represented SCE at Eggs & Issues Event
Orange County	General WMP Plan and PSPS Protocols	6/6/2022	Sup Wagner WMP Briefing
Palm Desert	General WMP Plan and PSPS Protocols	6/21/2022	2022 Circuit Reliability Report
Palm Springs	General WMP Plan and PSPS Protocols	7/7/2022	Palm Springs - WMP Engagement 2022
Palmdale	General WMP Plan and PSPS Protocols	5/16/2022	In-Person Coordination Meeting with City of Palmdale, Reliability Report Presented
Palos Verdes Estates	General WMP Plan and PSPS Protocols	6/29/2022	PVE_2022 Local Government Reliability Meeting/Update_Round 3 (City request names/addresses of residents who have had outages in 2022)
Palos Verdes Estates	General WMP Plan and PSPS Protocols	4/26/2022	PVE_2022 Local Government Reliability Meeting/Update_Round 2
Pechanga Band of Luiseno Indians	General WMP Plan and PSPS Protocols	5/19/2022	2022 Circuit Reliability Report sent to Pechanga.
Perris	General WMP Plan and PSPS Protocols	7/1/2022	Emailed WMP Briefing - Perris
Placentia	General WMP Plan and PSPS Protocols	6/13/2022	2022 Wildfire Mitigation Plan/PSPS Briefing
Placentia	General WMP Plan and PSPS Protocols	6/13/2022	Request for emergency response training for Placentia Fire & Police personnel
Pomona	General WMP Plan and PSPS Protocols	6/22/2022	Pomona: 2022 Circuit Reliability Presentation
Pomona	General WMP Plan and PSPS Protocols	5/10/2022	HFRA EOC Tour
Porterville	General WMP Plan and PSPS Protocols	6/7/2022	2022 Reliability Outreach: City of Porterville
Rancho Cucamonga	General WMP Plan and PSPS Protocols	6/14/2022	Rancho Cucamonga 2022 Circuit Reliability staff presentation
Rancho Palos Verdes	General WMP Plan and PSPS Protocols	8/16/2022	RPV_Appeal to DOI over insurance rate increase citing "RVP Has Not Experience a Major Wildfire in Over a Decade"
Rancho Palos Verdes	General WMP Plan and PSPS Protocols	7/21/2022	RPV_Jesse Villalpando's (AGAIN) Emergency Preparedness Committee Meeting_City to implement a "Utilities hardening transmission project" to control SCE's transmission projects
Rancho Palos Verdes	General WMP Plan and PSPS Protocols	7/19/2022	RPV_City plans to install Pano AI wildfire camera system on SCE power poles (ongoing issue)
Rancho Palos Verdes	General WMP Plan and PSPS Protocols	5/4/2022	RPV_2022 Local Government Reliability Meeting/Update

Name of County, City, or Tribal Agency or Civil Society Group (e.g., nongovernment organization, fire safe council)	Program, Plan, or Document	Last Version of Collaboration (Meeting Date)	Level of Collaboration (Subject)
Rancho Palos Verdes	General WMP Plan and PSPS Protocols	2/17/2022	RPV_Jesse Villalpando to abandon pursuing SCE for 1) City to decide SCE wildfire mitigation, 2) Force SCE to underground 1 mile per year
Rancho Palos Verdes	General WMP Plan and PSPS Protocols	2/1/2022	RPV_Council to discuss letter of support for AB 1445, which would require that evacuation route capacity, wildfire risk, and other impacts caused by climate change be considered when developing regional housing need allocations (RHNA)
Rancho Santa Margarita	General WMP Plan and PSPS Protocols	6/21/2022	RSM Wildfire Safety Meeting
Rancho Santa Margarita	General WMP Plan and PSPS Protocols	6/9/2022	RSM Reliability/WMP Briefing
Rancho Santa Margarita	General WMP Plan and PSPS Protocols	5/17/2022	RSM Chamber Roundtable Luncheon
Redlands	General WMP Plan and PSPS Protocols	6/15/2022	Redlands 2022 Circuit Reliability / Wildfire Update staff presentation
Redondo Beach	General WMP Plan and PSPS Protocols	6/9/2022	Redondo Beach - Wildfire Presentation
Rialto	General WMP Plan and PSPS Protocols	7/12/2022	WMP Update-City of Rialto 2022
Riverside	General WMP Plan and PSPS Protocols	6/14/2022	Riverside 2022 Circuit Reliability staff presentation
Rolling Hills	General WMP Plan and PSPS Protocols	5/23/2022	Rolling Hills_2022 Local Government Reliability Meeting/Update (City request SCE to answer reliability questions & install wildfire cameras)_Round 3
Rolling Hills	General WMP Plan and PSPS Protocols	5/9/2022	Rolling Hills_2022 Local Government Reliability Meeting/Update (Council to receive & file)_Round 2
Rolling Hills	General WMP Plan and PSPS Protocols	5/2/2022	Rolling Hills_2022 Local Government Reliability Meeting/Update_Round 1
Rolling Hills Estates	General WMP Plan and PSPS Protocols	5/24/2022	RHE_2022 Local Government Reliability Meeting/Update_Round 2
Rolling Hills Estates	General WMP Plan and PSPS Protocols	5/5/2022	RHE_2022 Local Government Reliability Meeting/Update
Rolling Hills Estates	General WMP Plan and PSPS Protocols	2/22/2022	RHE_City to submit application for the CA Climate Investment Fire Prevention Grant Program
Rural County Representatives of California (RCRC)	General WMP Plan and PSPS Protocols	9/14/2022	RCRC Annual Conference 2022 attended by GRMs Rossi, Thoburn, and Paruolo.
San Bernardino	General WMP Plan and PSPS Protocols	6/14/2022	San Bernardino 2022 Circuit Reliability staff presentation
San Bernardino County	General WMP Plan and PSPS Protocols	6/13/2022	Reliability and WMP briefing with County Public Works Scheduled. 6/13 @ 1:30p
San Bernardino County	General WMP Plan and PSPS Protocols	4/19/2022	San Bernardino County - OES PSPS Briefing
San Dimas	General WMP Plan and PSPS Protocols	6/9/2022	2022 WMP/PSPS Email Invite
San Dimas	General WMP Plan and PSPS Protocols	5/10/2022	HFRA EOC Tour
San Fernando	General WMP Plan and PSPS Protocols	5/4/2022	City of San Fernando Reliability Report Update Completed
San Gabriel	General WMP Plan and PSPS Protocols	5/10/2022	San Gabriel: April 2022 Confirmed PWD and Staff Attending 5/10 All Hazards-Focused EOC Tour
San Jacinto	General WMP Plan and PSPS Protocols	7/1/2022	Emailed WMP Briefing - San Jacinto
San Manuel Band of Serrano Mission Indians	General WMP Plan and PSPS Protocols	5/13/2022	2022 Circuit Reliability Report Meeting
San Manuel Band of Serrano Mission Indians	General WMP Plan and PSPS Protocols	5/6/2022	Completed 2022 Circuit Reliability and Wildfire Mitigation info with San Manuel
Santa Barbara County	General WMP Plan and PSPS Protocols	6/3/2022	2022 Wildfire Mitigation Outreach
Santa Clarita	General WMP Plan and PSPS Protocols	9/27/2022	Santa Clarita City Council Wildfire Mitigation Presentation
Santa Clarita	General WMP Plan and PSPS Protocols	8/2/2022	City Reschedules Resurfacing (again) for Expedited PSPS Circuit - Julius - Reducing Delays, Resulting in Cost Avoidance, and Improving Communications
Santa Clarita	General WMP Plan and PSPS Protocols	7/1/2022	Santa Clarita Agrees to Postpone Repaving, Expedite Permits for Marcus (PSPS) Circuit Wildfire Mitigation Project
Santa Clarita	General WMP Plan and PSPS Protocols	6/10/2022	Santa Clarita Wildfire Mitigation & Reliability Report Presentation - Completed
Santa Clarita	General WMP Plan and PSPS Protocols	3/4/2022	SCE Update on WFM Program and Infrastructure Funding to Santa Clarita Emergency Working Group
Santa Monica	General WMP Plan and PSPS Protocols	6/2/2022	Santa Monica - Wildfire and Reliability Presentation

Name of County, City, or Tribal Agency or Civil Society Group (e.g., nongovernment organization, fire safe council)	Program, Plan, or Document	Last Version of Collaboration (Meeting Date)	Level of Collaboration (Subject)
Santa Paula	General WMP Plan and PSPS Protocols	6/20/2022	Completed Wildfire Mitigation & Reliability Update for City of Santa Paula
Sierra Madre	General WMP Plan and PSPS Protocols	6/9/2022	Sierra Madre: City Manager & Public Works Director Attend 2022 SGV Virtual WMP Presentation
Sierra Madre	General WMP Plan and PSPS Protocols	5/2/2022	Sierra Madre FD Educational Presentation: WMP
Simi Valley	General WMP Plan and PSPS Protocols	6/20/2022	Wildfire
Soboba Band of Luiseño Indians	General WMP Plan and PSPS Protocols	5/19/2022	2022 Circuit Reliability Report sent
South Pasadena	General WMP Plan and PSPS Protocols	6/29/2022	South Pasadena: June 2022 Councilmember & Fire Chief To Attend 6/29 EOC Tour
South Pasadena	General WMP Plan and PSPS Protocols	6/9/2022	South Pasadena: Fire Chief Attends 2022 SGV Virtual WMP Presentation
South Pasadena	General WMP Plan and PSPS Protocols	5/10/2022	South Pasadena: April 2022 Confirmed Mayor Cacciotti Attending 5/10 All Hazards-Focused EOC Tour
South Pasadena Chamber of Commerce	General WMP Plan and PSPS Protocols	3/9/2022	South Pasadena: Mar 2022 Shared 2022 WMP Information with Chamber Legislative Affairs Committee
Southern California Edison (SCE)	General WMP Plan and PSPS Protocols	8/31/2022	2022 EOC Tour for Tribes in High Fire Risk Areas
Southern California Edison (SCE)	General WMP Plan and PSPS Protocols	6/9/2022	2022 SGV WMP Virtual Presentation
Southern California Edison (SCE)	General WMP Plan and PSPS Protocols	5/10/2022	May 10 EOC Tour
Tehachapi	General WMP Plan and PSPS Protocols	6/10/2022	2022 Wildfire Mitigation Outreach
Temecula	General WMP Plan and PSPS Protocols	5/17/2022	Temecula WMP Meeting - 2022
Thousand Oaks	General WMP Plan and PSPS Protocols	7/19/2022	Wildfire and Reliability Updates
Torrance	General WMP Plan and PSPS Protocols	5/3/2022	Torrance_2022 Local Government Reliability Meeting/Update
Tulare County	General WMP Plan and PSPS Protocols	6/8/2022	2022 Reliability Outreach: Tulare County
Tulare County	General WMP Plan and PSPS Protocols	6/2/2022	2022 Wildfire Safety Update: Tulare County
Tule River Tribe	General WMP Plan and PSPS Protocols	6/9/2022	2022 Wildfire Safety Update: Tule River Tribal Council
Tustin	General WMP Plan and PSPS Protocols	7/12/2022	2022 Wildfire Mitigation Plan Briefing
Twentynine Palms	General WMP Plan and PSPS Protocols	7/5/2022	29 Palms Reliability & WMP In Person Briefing 2022
Unincorporated Los Angeles County	General WMP Plan and PSPS Protocols	9/14/2022	Castaic Town Council Complaints About Wildfire Mitigation Road Closures in Val Verde
Upland	General WMP Plan and PSPS Protocols	6/30/2022	2022 Wildfire Mitigation Plan-Upland
Ventura County	General WMP Plan and PSPS Protocols	7/19/2022	Wildfire/Reliability 2022
Victorville	General WMP Plan and PSPS Protocols	6/27/2022	Victorville 2022 Circuit Reliability Report
Villa Park	General WMP Plan and PSPS Protocols	6/23/2022	2022 Wildfire Mitigation Plan Briefing
Visalia	General WMP Plan and PSPS Protocols	5/25/2022	2022 Reliability Outreach: City of Visalia
Walnut	General WMP Plan and PSPS Protocols	6/9/2022	2022 WMP/PSPS Email Invite
Walnut	General WMP Plan and PSPS Protocols	5/3/2022	HFRA EOC Tour
West Covina	General WMP Plan and PSPS Protocols	6/21/2022	West Covina: Circuit Reliability and WMP/PSPS Council Presentation
West Covina	General WMP Plan and PSPS Protocols	6/13/2022	West Covina 2022 Circuit Reliability staff presentation
West Covina	General WMP Plan and PSPS Protocols	5/25/2022	Wave 2 - West Covina Circuit Reliability Report
West Covina	General WMP Plan and PSPS Protocols	5/10/2022	HFRA EOC Tour
West Covina	General WMP Plan and PSPS Protocols	3/12/2022	West Covina 1st Annual Spring Festival
West Hollywood	General WMP Plan and PSPS Protocols	6/9/2022	West Hollywood - Wildfire Presentation
West Hollywood	General WMP Plan and PSPS Protocols	5/12/2022	West Hollywood - 2022 Reliability Outreach and Quarterly Coordination Meeting
Westlake Village	General WMP Plan and PSPS Protocols	7/22/2022	2022 Wildfire/Reliability Update
Whittier	General WMP Plan and PSPS Protocols	6/8/2022	Whittier - Local Reliability & WMP Briefing
Wildomar	General WMP Plan and PSPS Protocols	5/9/2022	WMP Update Meeting - Wildomar

Name of County, City, or Tribal Agency or Civil Society Group (e.g., nongovernment organization, fire safe council)	Program, Plan, or Document	Last Version of Collaboration (Meeting Date)	Level of Collaboration (Subject)
Woodlake	General WMP Plan and PSPS Protocols	6/29/2022	2022 Wildfire Safety Update: City of Woodlake
Yorba Linda	General WMP Plan and PSPS Protocols	6/29/2022	2022 Wildfire Mitigation Plan Briefing
Yorba Linda	General WMP Plan and PSPS Protocols	2/10/2022	EOC Tour
Yucaipa	General WMP Plan and PSPS Protocols	5/11/2022	WMP Update Briefing - City of Yucaipa
Yucca Valley	General WMP Plan and PSPS Protocols	6/7/2022	Yucca Valley - City Council/Staff Briefing Wildfire Mitigation Plan & Reliability 2022

F5: Continuation of Section 9 - PSPS

Due to its size, SCE provides Table 9-02 – Frequently De-energized Circuits below.

Entry #	Circuit ID	Name of Circuit with >2 Inc	Dates of Outages	Number of Customers Served by Circuit	Number of Customers Affected	Measures taken, or planned to be taken, to reduce the need for, and impact of, future PSPS of circuit
1	ED-00108	ACOSTA	10/26/2020	1272	788	Completed: <ul style="list-style-type: none"> Automate 1 existing switch and Implement operational protocol to raise PSPS windspeed thresholds
			11/26/2020		5	
			12/2/2020		5	
			10/10/2019		5	
			10/24/2019		1243	
			10/28/2019		1244	
			10/30/2019		1243	
2	ED-00452	AMETHYST	10/26/2020	1525	630	Completed: <ul style="list-style-type: none"> Replace 1.4 miles of existing overhead wire with new insulated wire Install an additional weather station to improve situational awareness
			11/26/2020		630	
			12/2/2020		629	
			12/7/2020		629	
4	ED-01344	ANTON	11/24/2022	300	51	Completed: <ul style="list-style-type: none"> Replace 25.2 miles of existing overhead wire with new insulated wire Install an additional weather station Install 1 automated switch and implement additional segmentation Implement operational protocol to raise PSPS windspeed thresholds
			11/25/2021		298	
			1/15/2021		139	
			1/17/2021		139	
			1/19/2021		277	
			9/9/2020		117	
			10/16/2020		47	
			10/26/2020		137	
			11/26/2020		117	
			12/2/2020		118	
			12/3/2020		152	
			12/7/2020		138	
			12/19/2020		139	
			12/23/2020		49	
			10/10/2019		49	
			10/24/2019		287	
			10/28/2019		341	
10/30/2019	286					
11/17/2019	49					
5	ED-00705	ARLENE	11/26/2020	1914	1668	Completed: <ul style="list-style-type: none"> Replace all 7.12 miles of existing overhead wire with new insulated wire Updated switching protocols
			12/3/2020		703	
			12/7/2020		703	
			12/23/2020		712	
6	ED-00817	ATENTO	10/26/2020	2883	901	

Entry #	Circuit ID	Name of Circuit with >2 Inc	Dates of Outages	Number of Customers Served by Circuit	Number of Customers Affected	Measures taken, or planned to be taken, to reduce the need for, and impact of, future PSPS of circuit
			11/26/2020		2680	Completed: <ul style="list-style-type: none"> • New insulated wire has already been installed in various places on the circuit. • Plan involves replacing an additional 25.4 miles of bare overhead wire with new insulated wire, to fully cover the circuit outside of the operational protocol area. • Implement operational protocols to raise PSPS windspeed thresholds
			12/2/2020		801	
			12/23/2020		801	
7	ED-00990	BALCO	12/2/2020	1989	359	Completed: <ul style="list-style-type: none"> • Replace 2.6 miles of existing overhead wire with new insulated wire • Implement switching protocols to transfer load to a less affected circuit
			12/7/2020		359	
			12/23/2020		359	
			10/10/2019		2849	
			10/24/2019		1536	
			10/28/2019		1535	
			10/30/2019		1539	
8	ED-01630	BIG ROCK	1/14/2021	3171	119	Completed: <ul style="list-style-type: none"> • Replace 10.2 miles of existing overhead wire with new insulated wire • Install 2 automated switches • Install an additional weather station • Implement operational and switching protocols to transfer load to a less affected circuit
			1/15/2021		2473	
			1/19/2021		119	
			10/26/2020		2839	
			11/26/2020		2841	
			11/27/2020		86	
			12/2/2020		2841	
			12/3/2020		87	
			12/7/2020		2928	
			12/23/2020		119	
9	ED-01832	BLUE CUT	10/26/2020	292	300	Planned Work: <ul style="list-style-type: none"> • Replace 43.2 miles of existing overhead wire with new insulated wire
			11/26/2020		25	
			12/2/2020		25	
10	ED-01954	BOOTLEGGER	9/9/2020	1571	61	Completed: <ul style="list-style-type: none"> • Insulated Wires: Replace 27.8 miles of existing overhead wire with new insulated wire • Implement switching protocol to remove some customers and critical businesses from PSPS
			10/26/2020		1579	
			11/26/2020		1576	
			12/3/2020		1502	
			12/7/2020		62	
			12/23/2020		62	
11	ED-02035	BOUQUET	10/10/2019	747	91	

Entry #	Circuit ID	Name of Circuit with >2 Inc	Dates of Outages	Number of Customers Served by Circuit	Number of Customers Affected	Measures taken, or planned to be taken, to reduce the need for, and impact of, future PSPS of circuit
			10/24/2019		734	Completed: <ul style="list-style-type: none"> Replace 28.9 miles of existing overhead wire with new insulated wire Add temporary generator to serve approx. 250 customers during a PSPS event with minimal outages
			10/30/2019		733	
12	ED-02674	CALGROVE	1/15/2021	1903	24	Under Engineering Review
			1/16/2021		24	
			1/19/2021		24	
13	ED-02751	CALSTATE	10/26/2020	606	605	Completed: <ul style="list-style-type: none"> Replace 3.0 miles of existing overhead wire with new insulated wire
			11/27/2020		614	
			12/3/2020		616	
			12/8/2020		9	
			12/23/2020		10	
			10/10/2019		10	
			10/20/2019		10	
			10/28/2019		617	
			10/24/2019		10	
			10/30/2019	617		
14	ED-02790	CAMP BALDY	10/26/2020	0	154	Completed: <ul style="list-style-type: none"> Install insulated wire
			11/26/2020		154	
			12/7/2020		152	
15	ED-03099	CASMALIA	10/10/2019	2111	665	Completed: <ul style="list-style-type: none"> All existing overhead in HFRA was previously switched to the Impala 12kV
			10/24/2019		2023	
			10/28/2019		2021	
			10/30/2019		1988	
16	ED-04632	CASTRO	12/2/2020	2379	21	Completed: <ul style="list-style-type: none"> Add a new switch to improve segmentation and reduce customer impacts
			12/7/2020		224	
			12/24/2020		20	
			10/10/2019		2379	
			10/23/2019		2395	
			10/28/2019		2298	
			10/30/2019	2291		
17	ED-03714	COBRA	12/2/2020	1712	1705	Completed: <ul style="list-style-type: none"> Replace 0.2 miles of existing overhead wire with new insulated wire Automate 2 existing switches Install an additional weather station
			12/7/2020		1705	
			12/23/2020		1711	
18	ED-03885	CONDOR	11/27/2020	1463	1464	

Entry #	Circuit ID	Name of Circuit with >2 Inc	Dates of Outages	Number of Customers Served by Circuit	Number of Customers Affected	Measures taken, or planned to be taken, to reduce the need for, and impact of, future PSPS of circuit
			12/2/2020		1466	Completed: <ul style="list-style-type: none"> • New insulated wire has already been installed on nearly all existing overhead portions of the circuit • Replace an additional 1.7 miles of existing overhead wire with new insulated wire near the substation
			12/7/2020		1466	
			12/8/2020		34	
			12/23/2020		1463	
			10/10/2019		1463	
			10/24/2019		1464	
			10/29/2019		1464	
19	ED-04495	CUDEBACK	10/10/2019	338	325	Completed: <ul style="list-style-type: none"> • Replace 7.53 miles of existing overhead wire with new insulated wire
			10/24/2019		325	
			10/28/2019		326	
			10/30/2019		326	
20	ED-04526	CUTHBERT	11/21/2021	2397	1129	Completed: <ul style="list-style-type: none"> • Replace 0.8 miles of existing overhead wire with new insulated wire • Implement operational protocols to raise PSPS windspeed thresholds, and transfer load to a less affected circuit • Install 1 automated switch
			11/24/2021		2384	
			1/14/2021		2439	
			1/15/2021		498	
			1/19/2021		76	
21	ED-04706	DAVENPORT	10/26/2020	1454	762	Completed: <ul style="list-style-type: none"> • Replace 17.07 miles of existing overhead wire with new insulated wire
			11/26/2020		452	
			12/2/2020		765	
			12/7/2020		1468	
			10/10/2019		2678	
			10/24/2019		1393	
			10/30/2019		1461	
			10/28/2019		1458	
22	ED-04900	DE MILLE	10/26/2020	0	243	Completed: <ul style="list-style-type: none"> • Replace 6.0 miles of existing overhead wire with new insulated wire • Circuit will be cutover to Lopez 16kV which will have higher PSPS thresholds
			12/3/2020		243	
			12/7/2020		243	
23	ED-05376	DUKE	12/2/2020	1143	1140	Completed: <ul style="list-style-type: none"> • New insulated wire on most overhead portions of the circuit within HFRA • Replace 0.4 miles of remaining bare overhead wire within HFRA with new insulated wire
			12/3/2020		1118	
			12/7/2020		23	
			12/23/2020		23	
24	ED-05483	DYSART	12/2/2020	70	4	
			12/7/2020		75	

Entry #	Circuit ID	Name of Circuit with >2 Inc	Dates of Outages	Number of Customers Served by Circuit	Number of Customers Affected	Measures taken, or planned to be taken, to reduce the need for, and impact of, future PSPS of circuit
			12/23/2020		75	Completed: • Replace 12.9 miles of overhead bare wire with new insulated wire
25	ED-05591	ECHO	10/26/2020	1761	117	Completed: • Replace 2.2 miles of existing overhead wire with new insulated wire
			12/7/2020		1775	
			12/18/2020		117	
26	ED-05930	ENERGY	11/19/2022	1667	29	Completed: • Replace 14.9 miles of existing overhead wire with new insulated wire • Install 3 automated switches and implement additional segmentation • Add temporary generator to serve approx. 120 customers during a PSPS event with minimal outages
			10/11/2021		37	
			10/15/2021		74	
			11/21/2021		37	
			11/24/2021		1702	
			1/14/2021		2495	
			1/18/2021		900	
			10/16/2020		37	
			10/26/2020		849	
			11/26/2020		1861	
			12/2/2020		2664	
			12/7/2020		1857	
			12/19/2020		870	
			12/23/2020		46	
			10/10/2019		625	
			10/24/2019		1809	
			10/30/2019		1811	
10/28/2019	1808					
11/25/2019	36					
27	ED-06065	ESTABAN	12/2/2020	2100	156	Completed: • Replace 13.8 miles of existing overhead wire with new insulated wire
			12/3/2020		93	
			12/7/2020		249	
			12/23/2020		312	
			10/10/2019		2128	
			10/24/2019		2133	
			10/30/2019		1628	
28	ED-06357	FERRARA	10/26/2020	1927	242	Planned Work: • Replace existing overhead wire with new insulated wire
			11/26/2020		242	
			12/7/2020		242	
29	ED-06432	FINGAL	12/2/2020	826	230	Completed: • Replace approximately 35.1 miles of existing overhead wire with new insulated wire
			12/7/2020		1426	
			12/23/2020		232	

Entry #	Circuit ID	Name of Circuit with >2 Inc	Dates of Outages	Number of Customers Served by Circuit	Number of Customers Affected	Measures taken, or planned to be taken, to reduce the need for, and impact of, future PSPS of circuit
30	ED-04170	FROZEN	1/18/2021	0	1	Completed: • Replace < 0.1 miles of existing overhead wire with new insulated wire
			11/16/2020		1	
			12/2/2020		1	
			12/23/2020		1	
31	ED-07382	GNATCATCHER	11/27/2020	1474	1446	Completed: • New insulated wire has already been installed on nearly all existing overhead portions of the circuit • Replace an additional 3.53 miles of existing overhead wire with new insulated wire at various locations
			12/2/2020		1445	
			12/7/2020		1450	
			12/23/2020		1451	
			10/10/2019		1447	
			10/24/2019		1448	
10/29/2019	1446					
32	ED-07742	GUITAR	10/26/2020	250	42	Completed: • Replaced 10.0 miles of existing overhead wire with new insulated wire
			11/27/2020		42	
			12/3/2020		42	
			12/23/2020		42	
			10/10/2019		197	
			10/24/2019		43	
			10/28/2019		255	
			10/30/2019		255	
33	ED-08446	HILLFIELD	10/26/2020	1980	2373	Completed: • Replace 3.6 miles of existing overhead wire with new insulated wire • Automate 3 switches • Update switching protocols • Implement operational protocol for portions of the circuit
			12/7/2020		2373	
			12/23/2020		2057	
34	ED-08795	HUCKLEBERRY	10/10/2019	181	4	Completed: • Replaced 17.8 miles of existing overhead wire with new insulated wire and Implement protocols to transfer load to a less affected circuit
			10/24/2019		173	
			10/27/2019		174	
			10/30/2019		174	
35	ED-08880	ICE HOUSE	10/26/2020	12	12	Planned Work: • Replace existing overhead wire with new insulated wire
			11/26/2020		12	
			12/7/2020		12	
36	ED-08904	IMPALA	11/21/2021	824	463	Completed: • Replace 25.8 miles of existing overhead wire with new insulated wire
			11/24/2021		463	
			11/25/2021		361	
			1/19/2021		776	

Entry #	Circuit ID	Name of Circuit with >2 Inc	Dates of Outages	Number of Customers Served by Circuit	Number of Customers Affected	Measures taken, or planned to be taken, to reduce the need for, and impact of, future PSPS of circuit
			10/26/2020		751	• Existing overhead in HFRA will be fully covered with insulated wire
			11/27/2020		760	
			12/3/2020		764	
			12/7/2020		763	
37	ED-10705	LOPEZ	10/26/2020	1759	168	Completed: • Replace 22.4 miles of existing overhead wire with new insulated wire, and Install a new automated switch
			12/2/2020		49	
			12/3/2020		96	
			12/7/2020		145	
38	ED-10729	LOUCKS	9/9/2020	57	14	Completed: • Replace 3.2 miles of existing overhead wire with new insulated wire
			10/26/2020		55	
			11/26/2020		55	
			12/7/2020		55	
			10/10/2019		56	
			10/24/2019		56	
			10/30/2019		56	
			10/28/2019	52		
39	ED-11500	MCKEVETT	10/10/2019	297	289	Completed: • Implement operational protocol to raise PSPS windspeed thresholds
			10/23/2019		578	
			10/28/2019		289	
			10/30/2019		289	
40	ED-11760	METTLER	11/16/2020	517	8	Completed: • Replace 38.0 miles of existing overhead wire with new insulated wire
			12/2/2020		527	
			12/7/2020		527	
			10/10/2019		514	
			10/24/2019		514	
			10/28/2019		516	
			10/30/2019	516		
41	ED-12485	NAPOLEON	12/2/2020	2935	45	Completed: • Replace 5.8 miles of existing overhead wire with new insulated wire
			12/3/2020		1028	
			12/7/2020		45	
			12/8/2020		527	
			12/23/2020		45	
42	ED-12847	NORTHPARK	11/26/2020	2155	552	Completed: • Replace 18.6 miles of existing overhead wire with new insulated wire • Implement switching protocols to transfer load to a less affected circuit • Automate 2 existing sectionalizing devices
			12/2/2020		550	
			12/18/2020		1101	
			12/23/2020		623	

Entry #	Circuit ID	Name of Circuit with >2 Inc	Dates of Outages	Number of Customers Served by Circuit	Number of Customers Affected	Measures taken, or planned to be taken, to reduce the need for, and impact of, future PSPS of circuit
43	ED-13983	PETIT	10/24/2019	1163	22	Completed: • Implement operational protocols to raise PSPS windspeed thresholds
			10/25/2019		11	
			10/28/2019		1076	
			10/29/2019		42	
			10/30/2019		1074	
			10/31/2019		42	
44	ED-14005	PHEASANT	12/2/2020	176	178	Completed: • Replace 9.3 miles of existing overhead wire with new insulated wire
			12/7/2020		178	
			12/23/2020		178	
45	ED-14603	RACER	12/3/2020	724	722	Completed: • Replace 0.6 miles of existing overhead wire with new insulated wire • Implement operational protocol for portions of the circuit
			12/7/2020		723	
			12/23/2020		723	
46	ED-14645	RAINBOW	12/2/2020	395	180	Completed: • Replace 15 miles of existing overhead wire with new insulated wire
			12/7/2020		180	
			12/23/2020		179	
			10/24/2019		19	
			10/28/2019		343	
			10/30/2019		399	
47	ED-14758	RED BOX	1/19/2021	27	30	Completed: • Install an additional weather station • Adjustments to switching plans and weather station assignments in order to leverage better situational awareness and reduce PSPS use
			9/9/2020		20	
			10/26/2020		20	
			12/2/2020		30	
			12/7/2020		30	
			10/24/2019		29	
			10/30/2019		28	
			10/27/2019		29	
48	ED-15586	RUSTIC	10/26/2020	3098	367	Under Engineering Review
			11/26/2020		41	
			12/3/2020		41	
49	ED-15618	SADDLEBACK	12/2/2020	8	79	Planned Work: • Replace 4.8 miles of existing bare overhead wire with new insulated wire • Add new weather station near end of the circuit to improve situational awareness
			12/7/2020		8	
			12/23/2020		4	
50	ED-15737	SAND CANYON	9/30/2021	2176	9	

Entry #	Circuit ID	Name of Circuit with >2 Inc	Dates of Outages	Number of Customers Served by Circuit	Number of Customers Affected	Measures taken, or planned to be taken, to reduce the need for, and impact of, future PSPS of circuit
			10/15/2021		9	Planned Work: <ul style="list-style-type: none"> • Replace 22.8 miles of existing overhead wire with new insulated wire • Update switching protocols • Implement operational protocol for portions of the circuit
			11/21/2021		9	
			11/24/2021		290	
			1/14/2021		9	
			1/18/2021		9	
			1/19/2021		697	
			9/9/2020		9	
			10/26/2020		144	
			11/17/2020		9	
			11/26/2020		142	
			12/2/2020		9	
			12/3/2020		133	
			12/7/2020		2200	
			12/18/2020		9	
			12/23/2020		61	
			10/10/2019		8	
			10/24/2019		2205	
			10/28/2019		2204	
			10/30/2019		987	
51	ED-16404	SHOVEL	9/9/2020	720	31	
			10/26/2020		52	
			11/17/2020		165	
			11/26/2020		197	
			12/2/2020		525	
			12/7/2020		719	
			10/10/2019		775	
			10/20/2019		165	
			10/24/2019		416	
			10/26/2019		9	
			10/27/2019		9	
			10/29/2019		9	
			10/30/2019		770	
52	ED-16973	STEEL	10/15/2021	37	37	Completed: <ul style="list-style-type: none"> • Update switching protocols to reassign the boundary point between PSPS Segment 1 and Segment 2
			11/21/2021		37	
			11/25/2021		37	
			1/19/2021		37	
			12/2/2020		36	
			12/7/2020		36	

Entry #	Circuit ID	Name of Circuit with >2 Inc	Dates of Outages	Number of Customers Served by Circuit	Number of Customers Affected	Measures taken, or planned to be taken, to reduce the need for, and impact of, future PSPS of circuit
			12/23/2020		2	
			10/10/2019		34	
			10/24/2019		35	
			10/28/2019		34	
			10/30/2019		34	
53	ED-17383	SUTT	10/26/2020	1877	1839	Planned Work: • Implement operational protocol for portions of the circuit
		12/7/2020	27			
		12/18/2020	81			
54	ED-17405	SWEETWATER	1/15/2021	3451	2533	Completed: • Replace 4.9 miles of existing overhead wire with new insulated wire
		1/19/2021	1266			
		1/20/2021	1265			
		10/26/2020	3432			
		12/23/2020	3431			
55	ED-17546	TAHQUITZ	10/10/2019	139	134	Completed: • Add new weather station near in the Mountain Center area to improve situational awareness
		10/24/2019	133			
		10/28/2019	133			
		10/30/2019	133			
56	ED-17529	TANAGER	11/27/2020	1652	1598	Completed: • Replace 28.6 miles of existing overhead wire with new insulated wire • Install 1 new automated switch
		12/2/2020	1597			
		12/7/2020	1597			
		10/10/2019	1532			
		10/24/2019	1541			
		10/30/2019	1543			
57	ED-17548	TAPO	10/26/2020	1377	57	Completed: • Replace 11.7 miles of existing overhead wire with new insulated wire • Implement operational protocol to raise PSPS windspeed thresholds
		11/26/2020	57			
		12/3/2020	518			
		12/7/2020	1370			
58	ED-18243	TUBA	10/24/2019	1173	25	Planned Work: • Add temporary generator to serve approx. 306 customers during a PSPS event with minimal outages • Other: Adjustments to switching plans and weather station assignments in order to leverage better situational awareness and reduce PSPS use
		10/30/2019	25			
		11/25/2019	25			
59	ED-18370	TWIN LAKES	10/26/2020	2296	840	

Entry #	Circuit ID	Name of Circuit with >2 Inc	Dates of Outages	Number of Customers Served by Circuit	Number of Customers Affected	Measures taken, or planned to be taken, to reduce the need for, and impact of, future PSPS of circuit
			11/26/2020		840	Completed: <ul style="list-style-type: none"> • Implement operational protocol to raise PSPS windspeed thresholds • Implement switching protocols to isolate overhead portions and transfer customers to adjacent circuits
			12/2/2020		840	
			12/7/2020		3644	
			12/23/2020		467	
60	ED-01754	VARGAS	10/26/2020	1649	391	Completed: <ul style="list-style-type: none"> • Replace 0.2 miles of existing overhead wire with new insulated wire • Install 1 new automated switch • Implement operational protocol to raise PSPS windspeed thresholds
			11/27/2020		391	
			12/3/2020		391	
			12/7/2020		394	
			12/23/2020		393	
61	ED-18650	VERA CRUZ	10/26/2020	1714	27	Completed: <ul style="list-style-type: none"> • Replace 3.2 miles of existing overhead wire with new insulated wire • Implement switching protocols to update boundary between PSPS segment 1 and segment 2
			12/2/2020		5	
			12/7/2020		5	
			12/23/2020		5	
62	ED-19850	ZONE	12/2/2020	944	56	Planned Work: <ul style="list-style-type: none"> • Replace 23.7 miles of existing overhead wire with new insulated wire • Implement operational protocols to raise PSPS windspeed thresholds near substation • Implement switching protocols to transfer load to a less affected circuit • Install an additional weather station
			12/3/2020		890	
			12/7/2020		946	
			10/10/2019		56	
			10/24/2019		1237	
			10/28/2019		1229	
			10/30/2019		1230	

F6: Acronym Dictionary

ACRONYM / ABBREVIATION	DEFINITION
AAR	After Action Report
AB	Assembly Bill
ACI	Area(s) of Continuous Improvement
AC-DC	Alternate Current – Direct Current
ACSR	Aluminum conductor steel-reinforced cable
ADMS	Advanced Distribution Management System
ADS	Atmospheric Data Solutions
AFN	Access and Functional Need(s)
AHP	All-Hazards Plan
AI	Artificial Intelligence
AMI	Advanced Metering Infrastructure
AOC	Areas of Concern
AR	Automatic Recloser
ARC	Annual Report of Compliance
ARGWT	Asset Risk Governance Working Team
ASC	Arc Suppression Coil
ASD	Audit Services Department
AUC	Area Under Curve
AWS	Amazon Web Services
BES	Bulk Electric System
BGEPA	Bald and Golden Eagle Protection Act
BLF	Branch Line Fuse
BLM	Bureau of Land Management
BR	Business Resiliency
BRDM	Business Resiliency Duty Manager
BTU	British Thermal Unit
C&Q	Compliance & Quality
CAIDI	Customer Average Interruption Duration Index
CAISO	California Independent System Operator
CAL OES	California Office of Emergency Services
Cal Poly SLO	California Polytechnic State University, San Luis Obispo
CALFIRE	California Department of Forestry and Fire Protection
CalPAWS	California Public Alert and Warning System
CAR	Community at Risk
CARE	California Alternate Rates for Energy
CAVA	Climate Adaptation and Vulnerability Assessment
CB	Circuit Breaker
CBM	Condition Based Maintenance

ACRONYM / ABBREVIATION	DEFINITION
CBO	Community Based Organization
CBOLM	Circuit Breaker Online Monitoring
CC	Covered Conductor
CCBB	Critical Care Backup Battery
CCD	Compliance Clearance Distance
CCR	California Code of Regulations
CCV	Community Crew Vehicles
CDC	Centers for Disease Control
CDFW	California Department of Fish and Wildlife
CDP	Centralized Data Platform
CEE	Contact with Energized Equipment
CEFC	Community of Elevated Fire Concern
CEO	Chief Executive Officer
CEQA	California Environmental Quality Act
CFI	Critical Facility and Infrastructure
CFO	Contact from Foreign Object
CFOV	Contact from Object Vegetation
CFR	Code of Federal Regulation
CFSR	Climate Forecast System Reanalysis
cGIS	Comprehensive/Consolidated Geographical Information System
CI	Confidence Interval
CIP	Communication Infrastructure Provider
CL	Confidence Level
CLF	Current-Limiting Fuses
CMC	Crisis Management Council
CMI	Customer Minutes of Interruption
CMS	Consolidated Mobile Solution
ConOps	Concept of Operations
CPUC	California Public Utilities Commission or Commission
CRC	Community Resource Center
CSTI	California Specialized Training Institute
CT	Current Transformer
CUEA	California Utilities Emergency Association
CWA	Clean Water Act
DAP	Distribution Apparatus Construction Standards
DDAR	Disability Disaster and Access Resources
DDS	Distribution Design Standard
DER	Distributed Energy Resource
Det	Deteriorated

ACRONYM / ABBREVIATION	DEFINITION
DFA	Distribution Fault Anticipation
DFR	Digital Fault Recorder
DIMP	Distribution Inspection Maintenance Program
DOH	Distribution Overhead
DOPD	Distribution Open Phase Detection
DRI	Drought Relief Initiative
DUG	Distribution Underground
DVMP	Distribution Vegetation Management Plan
DWR	Department of Water Resources
EAM	Enterprise Asset Management
ECERP	Electrical Corporation's Emergency Response Plan
ECMWF	European Centre for Medium-range Weather Forecasts
ECS	Electrical Construction Station
EDD	Early Damage Detection
EDSW	Electric Design Station Wiring
EDW	Enterprise Data Warehouse
EI	Edison Electric Institute
EFD	Early Fault Detection
EFF	Equipment and Facility Failure
EMI	Emergency Management Institute
EMS	Emergency Management System
EOC	Emergency Operations Center
EOI	Enhanced Overhead Inspections
ERC	Energy Release Component
ERD	Entity Relationship Diagram
ERM	Enterprise Risk Management
ERP	Enterprise Resource Planning
ESA	Federal Endangered Species Act
ESA	Environmentally Sensitive Area
ESD	Environmental Services Department
ESRI	Environmental Systems Research Institute
EUCI	Electric Utility Consultants, inc.
FAA	Federal Aviation Administration
FC	Fast Curve
FCZ	Fire Climate Zone
FEMA	Federal Emergency Management Agency
FERA	Family Electric Rate Assistance
FIPA	Fire Investigation Preliminary Analysis
FL	Flame Length

ACRONYM / ABBREVIATION	DEFINITION
FLOC	Functional Location
FMEA	Failure Modes and Effects Analysis
FPI	Fire Potential Index
FR	Fire Resistant
FRAP	CalFire's Fire Resource Assessment Program
FRC	Fundamental Risk Component
FRP	Fire Resistant Pole
FTE	Full Time Employee
FWT	Fire Weather Threat
FWZ	Fire Weather Zone
GACC	Geographic Area Coordination Center
GCC	Grid Control Center
GCM	Global Climate Model
GCP	Google Cloud Platform
GESW	GE Smallworld
GFN	Ground Fault Neutralizer
GFS	Global Forecast System
GIS	Geographical Information System
GMS	Grid Management System
GO	General Order
GOOES	Geostationary Operational Environmental Satellite
GRC	General Rate Case
GRCD	Grid Resiliency Clearance Distance
GSRP	Grid Safety and Resiliency Program
HD	High Definition
HERMES	Hazard Event Restriction and Management Emergency System
HFRA	High Fire Risk Areas
HFRI	High Fire Risk Informed Inspection
HFTD	High Fire Threat District
Hi-Z	High Impedance Relay
HPCC	High Performance Computing Cluster
HSEEP	Homeland Security Exercise and Evaluation Program
HTMP	Hazard Tree Management Program
HWW	High Wind Warning
IBEW	International Brotherhood of Electrical Workers
IC	Incident Commander
ICS	Incident Command System/Structure
ID	Identification
IEEE	Institute of Electrical and Electronics Engineers

ACRONYM / ABBREVIATION	DEFINITION
IMT	Incident Management Team
IOU	Investor-Owned Utility
iPEMS	Integrated PSPS Event Management System
IPI	Intrusive Pole Inspection
IQCC	Income Qualified Critical Care
IR	Infrared
IRC	Intermediate Risk Component
ISA	International Society of Arboriculture
IST	Incident Support Team
IT	Information Technology
IVM	Integrated Vegetation Management
IVMP	Integrated Vegetation Management Plan
IVR	Interactive Voice Response
IWMS	Integrated Wildfire Mitigation Strategy
IWRMC	International Wildfire Risk Management Consortium
KMZ	Keyhole Markup Language Zipped
kV	Kilovolt
LADRP	Los Angeles Department of Regional Planning
LEP	Limited English Proficiency
LFO	Live Field Observation
LiDAR	Light Detection and Ranging Technology
LOCA	Localized Constructed Analogs
LOPS	limited operating periods
LSA	Lake or Streambed Alteration
LSI	Long Span Initiative
MADEC	Meter Alarming for Downed Energy Conductor
MADIS	Meteorological Observation Database
MARS	Multi Attribute Risk Score (Framework)
MAVF	Multi-Attribute Value Function
MBL	Medical baseline
MBTA	Migratory Bird Treaty Act
MCL	Monitored Circuit List
MDG	Master Data Governance
MIM	Maintenance and Inspection Manual
ML	Machine Learning
MMPA	Marine Mammal Protection Act
MOA	Memorandum of Agreement
MPFR	Material Performance Failure Report
MSUP	Forest Service Master Special Use Permit

ACRONYM / ABBREVIATION	DEFINITION
MYNN	Mellor-Yamada-Nakanishi-Niino
NAICS	North American Industry Classification System
NAM	North American Mesoscale Model
NARR	North American Regional Reanalysis
NASA	National Aeronautics and Space Administration
NATF	North American Transmission Forum
NCEP	National Center for Environmental Prediction
NDVI	Normalized Difference Vegetation Index
NEPA	National Environmental Policy Act
NERC	North American Electric Reliability Corporation
NHPA	National Historic Preservation Act
NIMS	National Incident Management System
NOAA	National Oceanic and Atmospheric Administration
NOD	Notice of Defect
NOV	Notice of Violation
NRCI	Non-Residential Critical Infrastructure
NRE	National Response Event
NRI	National Risk Index
NWS	National Weather Service
OCBA	Oil Circuit Breaker Analysis
OCM	Organizational Change Management
OCM	Overhead Circuit Mile
OCP	Overhead Conductor Program
ODI	Overhead Detail Inspection
ODRM	Outage Database and Reliability Metrics
ODRM	Outage Database Reporting Management System
ODS	Operation GIS Data Store
OEIS	Office of Energy Infrastructure and Safety
OH	Overhead
OII	Order Instituting Investigation
OIR	Order Instituting Rulemaking
OJT	On Job Training
OMS	Outage Management System
OPD	Open Phase Detection
ORCP	Overhead Re-conductor Program
OU	Organizational Unit
OWS	Open Wire Secondary
PAPR	Powered air-purifying respirators
PCB	Polychlorinated Biphenyl

ACRONYM / ABBREVIATION	DEFINITION
PERP	Portable Equipment Registration Program and Portable Engine Airborne Toxic Control Measure
PFM	Petition for Modification
PG&E	Pacific Gas and Electric Company
PIO	Public Information Officer
PLP	Pole Loading Program
PMA	Predictive Maintenance Assessment
POC	Period of Concern
POD	Probability of De-energization
POI	Probability of ignition
PQS	Personnel Qualification Standard
PRC	Public Resources Code
PRPA	Paleontological Resources Preservation Act
PS	Problem Statement Score
PSCAD	Power System Computer-Aided Design
PSPS	Public Safety Power Shut Off
PT	Potential Transformer
PWV	Post-work verification
QA	Quality Assurance
QC	Quality Control
QDR	Quarterly Data Report (Request)
QEW	Qualified Electrical Worker
QRF	Quick Reaction Force
RAMP	Risk Assessment Mitigation Phase
RAR	Remote-Controlled Automatic Reclosers
RCD	Regulation Clearance Distance
RCP	Representative Concentration Pathway
RCS	Remote Controlled Switch(es)
REFCL	Rapid Earth Fault Current Limiter
REST	Representational State Transfer
RFW	Red Flag Warning
RMAG	Regional Mutual Assistance Group
ROC	Receiver Operating Characteristic
ROS	Rate of Spread
ROW	Right-of-Way
RSE	Risk Spend Efficiency
RSR	Remote Sectionalizing Recloser
RTDS	Real Time Digital Simulation
RTTMG	Rapid radiative transfer model

ACRONYM / ABBREVIATION	DEFINITION
SA	Weather Station
SAD	Solution Architecture Document
SAP	Systems, Applications & Products
SC&M	Substation Construction & Maintenance
SCADA	Supervisory Control and Data Acquisition
SCE	Southern California Edison Company
SDG&E	San Diego Gas & Electric Company
SED	Safety Enforcement Division
SEMS	Standardized Emergency Management System
SERP	Substation Equipment Replacement Program
SJSU	San Jose State University
S-MAP	Safety Model and Assessment Proceedings
SME	Subject Matter Expert
SMS	Short Message Service
SOB	Standard/System Operating Bulletin
SOM	Substation Operations and Maintenance Policy and Procedures
SOMS	Self-Organizing Maps
SOP	Standard Operating Procedure
SOW	Statement of Work
SOX	Sarbanes-Oxley Act
SRA	Severe Risk Area
SSP	Senior Specialist
SVI	Social Vulnerability Index
T&D	SCE's Transmission and Distribution Business Unit
T&E	Time & Expense
TBD	To be determined
TCCI	Tree-Caused Circuit Interruption
TGR	Tree Growth Regulator
TIMP	Transmission Inspection and Maintenance Program
TOH	Transmission Overhead
TOPD	Transmission Open Phase Detection
TPD	Time Past Due
TRAQ	Tree Risk Assessment Qualification
TRC	Tree Risk Calculator
TRI	Tree Risk Index
TS	Technosylva
TSP	Tubular Steel Pole
TT	Thunderstorm Threat
TUG	Targeted Undergrounding

ACRONYM / ABBREVIATION	DEFINITION
TV	Television
TVM	Transmission Vegetation Management
TVMP	Transmission Vegetation Management Plan
UAS	Unmanned Aerial Systems
UAT	User Acceptance Testing
UCSB	University of California, Santa Barbara
UCSD	University of California, San Diego
UDDR	Universal Data Descriptor Repository
USDA	United States Department of Agriculture
USFS	United States Forest Service
USZ	Utility Strike Zone
UV	Ultraviolet
UVM	Utility Vegetation Management
Veg	Vegetation
VCFD	Ventura County Fire Department
VHFSZ	Very High Fire Hazard Severity Zone
VM	Vegetation Management
VoLL	Value of Lost Load
WAF	Wind Adjustment Factor
WAL	Weather-Resistant Aluminum
WCAG	Web Content Accessibility Guidelines
WCCP	Wildfire Covered Conductor Program
WDD	Wire Down Database
WDM	Weather Data Mart
WECC	Western Electricity Coordination Council
WEI	Western Electric Institute
WF	Wildfire
WIRC	Wildfire Interdisciplinary Research Center
WisDM	Wildfire Safety Data Mart and Data Management (Portal)
WMP	Wildfire Mitigation Plan
WRF	Weather Research and Forecast(ing)
WRM	Wildlife Risk Model
WRMAG	Western Regional Mutual Assistance Group
WSD	Wildfire Safety Division
WUI	Wildland Urban Interface
WUIx	Wildland Urban Interface intermix
WWZ	Wind Weather Zone

F7: Joint IOU Covered Conductor Working Report

2023 -2025 WMP Joint IOU Covered Conductor Working Group Report

Introduction:

In the 2021 WMP Update Final Action Statements, Energy Safety ordered the Joint IOUs³¹⁴ to coordinate to develop a consistent approach to evaluating the long-term risk reduction and cost-effectiveness of covered conductor (CC) deployment, including 1) the effectiveness of CC in the field in comparison to alternative initiatives and 2) how CC installation compares to other initiatives in its potential to reduce PSPS risk. The utilities thus formed a Joint IOU Covered Conductor Working Group and developed an approach, assumptions, and preliminary milestones to enable the utilities' to better discern the long-term risk reduction effectiveness of CC to reduce the probability of ignition, assess its effectiveness compared to alternative initiatives, and assess its potential to reduce PSPS risk in comparison to other initiatives. The approach consisted of multiple workstreams including: Benchmarking, Testing, Estimated Effectiveness, Recorded Effectiveness, Alternatives Comparison, Potential to Reduce PSPS Risk, and Costs. In the 2022 WMP Update filings, the utilities produced a joint report that provided an update on their progress for each of the workstreams, added efforts, and preliminary plans for 2023.

In the 2022 WMP Update Final Decisions, Energy Safety identified Areas of Continued Improvement and Required Progress (ACI) for all utilities to expand this working group to include: 1) Joint CC Lessons Learned, 2) CC Maintenance and Inspection (M&I) Practices, and 3) New Technologies Implementation. Given these directions, the utilities expanded the Joint IOU Covered Conductor Working Group to include 10 workstreams and began meeting on the new workstreams in Q3/Q4 2022.

Overview:

The information compiled and assessments completed in 2022 continue to indicate CC effectiveness between approximately 60 to 90 percent in reducing the drivers of wildfire risk, consistent with benchmarking, testing and utility estimates. In 2022, laboratory testing on CC has largely been completed with a few tests remaining.

In 2023, the utilities plan to conduct workshops across several workstreams to assess testing results, identify CC M&I best practices, develop a common framework for calculating the effectiveness of a combination of alternatives, assess data and information for effectiveness of new technologies and share practices and implementation strategies, and assess studies to be performed on CC's ability to reduce PSPS impacts amongst other actions. The utilities will also continue to meet to further benchmark efforts, improve methods for estimating and measuring effectiveness, and continue to track and compare unit costs. Below, the utilities describe the progress made on each workstream and steps planned to continue this effort in 2023.

As explained in the 2022 WMP Update report, the current type of CC being installed in each of the utilities' service areas is an extruded multi-layer design of protective high-density or cross-linked polyethylene material. In this report, "covered conductor" or "CC" refers generally to a system installed

³¹⁴ In this progress report, "Joint IOUs," "IOUs," or "utilities" refers to SDG&E, PG&E, SCE, PacifiCorp, BVES, and Liberty.

on cross-arms, in a spacer cable configuration, or as aerial bundled cable (ABC). Distinctions are made

where utilities install CC on cross arms and in a spacer cable configuration. Table CC-1, below, provides an updated snapshot of the approximate amount and types of CC installed in the utilities' service areas through 2022.

Table CC-1
Covered Conductor Type and Approximate Circuit Miles Deployed by Utility

Utility	First covered conductor installation (year)	Type of covered conductor installed	Approx. miles of covered conductor deployed through 2022	Notes
SCE	2018	Covered Conductor	4,400	Includes WCCP and Non-WCCP Pilot
	2022	Spacer Cable	0.15	
	Installed Historically	Tree Wire	50	
	Installed Historically	ABC	64	
PG&E	2018	Covered Conductor	960	Primary distribution overhead only Like for like replacement
	2022	ABC	3	
SDG&E	2020	Covered Conductor	84	
		Tree Wire	2	
		Spacer Cable	6	
Liberty	2019	Covered Conductor	11	
	2019	Spacer Cable	9	
PacifiCorp	2007	Spacer Cable	76	
	2022	Covered Conductor	7	
Bear Valley	2018	Covered Conductor	34	

Testing:

Introduction:

In 2022, the joint IOUs performed Phase 2, or testing of CC, to better understand the advantages, operative failure modes, and current state of knowledge regarding CCs. As explained in the utilities' 2022 WMP Update filings, the utilities contracted with Exponent, Inc. (Exponent) to develop a report for a Phase 1 study. The Phase 1 study consisted of a literature review, discussions with SMEs, a failure mode identification workshop, and a gap analysis comparing expected failure modes to currently available test and field data. The Phase 1 report was completed in December 2021 and was an attachment to the utilities' 2022 WMP Update filings. The outcome of the Phase 1 report identified gaps in previous testing and informed the scope of laboratory testing. For the remainder of 2022, the IOUs executed Phase 2 to perform testing and analyses of CC, which had the following objectives:

Within Phase 2 of the study, SCE, SDG&E, and PG&E all performed specific testing scopes of work, informed by the findings and recommendations of the Phase 1 report issued by Exponent. The three utilities, led by SCE, contracted with Exponent to independently investigate the effectiveness of CC for overhead distribution systems and, in the case of PG&E and SDG&E, executed additional testing plans as

part of this joint effort.³¹⁵ Exponent conducted several testing scenarios that covered various contact-from-object, wire down, system strength, flammability, and water ingress scenarios. PG&E developed an additional test plan to ensure coverage of failure modes and additional CC types. SDG&E's additional test plan included environmental, service life, UV exposure, degradation, and mechanical strength tests. Exponent's investigation included lab-based testing of 15 kV rated 1/0 aluminum conductor, steel reinforced (ACSR) CC provided by SDG&E, 17 kV and 35 kV rated 1/0 ACSR provided by SCE, 22 kV rated 397.5 kcmil all aluminum conductor (AAC) provided by PG&E, and 17 kV rated 2/0 copper CC provided by SCE (corrosion testing only). PG&E's additional testing included 15 kV rated 397.5 AAC and 15 kV rated 1/0 ACSR. SDG&E's additional testing included a 15 kV rated 1/0 ACSR conductor.

SCE's testing began in Q1 2022 and was completed in Q4 2022. Exponent completed its final report in late December 2022.³¹⁶ SDG&E and PG&E began testing in Q2 2022. PG&E completed its testing and finalized its report in December 2022.³¹⁷ SDG&E has not completed all its testing with some tests anticipated to be completed in Q1 and early Q2 2023. All testing is not yet complete; however, the utilities have recently started to collaborate on the results of the tests that have been completed. This report provides a summary of the test results that have been completed. In 2023, the utilities plan to continue discussing the results of the tests as further described below.

Based on all the testing completed as of the end of December 2022, the following high-level conclusions were made:³¹⁸

Summary of Testing Results:

Arc Testing

The purpose of the Arc testing was to understand the effectiveness of CC in mitigating faults and ignition for various contact-from-object scenarios. These tests involved simulating wire-to-wire contact and contact from foreign objects by bridging two conductors, one energized and one grounded. Several permutations of CC, sheath damage, and bare conductors were tested. Overall, CC was successful at mitigating arcing/ignition under all tested conditions at their design voltages. Current flows for CC were recorded to be less than 2.5 mA. In comparison, current flows for bare wire were recorded to be greater than 2,000 mA. For a five-minute contact duration, no arcing, insulation breakdown, or visual damage was observed.

The testing of phase-to-phase contact demonstrates that CC is effective at reducing arcing and the potential for ignitions whenever the insulation is intact, and the operating voltage is within normal ranges. Potential for ignition exists when the insulation is damaged/removed which may occur when objects collide with the CC. This testing also involved energizing the CC at extreme voltages much higher

³¹⁵To distinguish between the results described below, "SCE testing" refers to the joint IOU Exponent testing, "PG&E testing" refers to the testing PG&E conducted, and "SDG&E testing" refers to the testing SDG&E has completed and is still conducting for the Joint IOU effort.

³¹⁶ The joint IOU Exponent report entitled, "Joint-IOU Covered Conductor Testing Cumulative Report 12-22-22" is included in each utility's Supporting Documents.

³¹⁷ The PG&E report entitled, "PGE Covered Conductor Testing-1219" is included in each utility's Supporting Documents.

³¹⁸All tests were performed under controlled conditions. Actual field performance may vary depending on a variety of factors.

than the CC was designed to withstand. At 90 kV, which far exceeds the conductor ratings, there was no insulation breakdown, pinhole formation, or arcing/ignition observed.

These test results illustrate the effectiveness of CC at mitigating ignitions due to contact-from-object events. Future testing may be done to simulate branches or other debris striking the conductor at speed to determine the ability of the insulation to withstand impact. Future testing may also include simulating the effects of long-term object contact.

Simulated Wire-down Testing

The wire-down testing investigated ignition risk posed by CC and bare wire wire-down events. Flaws were introduced to the covering to represent various scenarios during a CC wire-down. These flaws included the full removal of the covering, removing half the thickness of the covering, and having a broken end. The SCE wire-down testing demonstrated that conductors whose covering was still intact upon contacting the dry brush did not result in an ignition. Upon introducing a full thickness flaw into the covering, which exposed the bare conductor, arcing and ignition were observed. PG&E testing showed that individual conductor strands can be exposed from the covering during simulated conductor breaks.

SCE testing was also performed by inserting a half-thickness flaw into the covering which did not result in arcing or ignition; this indicates that the CC can sustain significant damage without exposing the bare conductor and still be effective at mitigating ignitions. This conclusion is also corroborated through testing that showed that the CCs had a minimum of 66% of the insulation rating even with 50% abraded insulation.

Fire risk / Flammability Testing

SCE’s Fire Risk testing subjected a small segment of conductor to local radiant heat to simulate how CCs would react to various magnitudes of wildfires. The magnitude of the heat represents surface fires, brush fires, and crown fires. Crown fires with a long residence time have the highest potential to cause damage to the covering of the conductor. The study noted that the measurements were taken with direct contact of the flame; however, properly maintained vegetation clearances would decrease an overhead primary distribution line’s potential of being in contact with a flame. According to the inverse square law for heat, the intensity of the flame is inversely proportional to the distance squared $X=1/d^2$. Using this equation, we can approximate the amount of radiated heat the conductor might experience at a particular distance away from a flame. The shortest distance that should be expected between vegetation and the conductor would be when there are crowns of trees nearby (6-foot clearance, GO 95). There would be a significantly greater distance between the conductor and vegetation for surface and brush fires. At 6 feet, the heat flux is approximately 30% of what would be felt directly at the flame. At a distance of 6 feet (1.8288m) and utilizing the scenario-based heat fluxes provided, we can approximate the amount of heat the conductor would encounter. See Table CC-2 below that shows the heat flux ranges for direct contact and contact at six feet for the different fire types.

Table CC-2
Heat Flux Ranges by Fire Type

Fire Type	Heat Flux (kW/m ²) Range with Direct Contact	Heat Flux (kW/m ²) Range with Contact at 6 feet (1.8288m)
-----------	--	---

Surface fires	18	77	5	23
Brush fires	97	110	29	33
Crown fires	179	263	54	79

Corrosion Testing

To make electrical and structural connections, some utilities remove the covering of the conductor to expose bare wire. When a bare wire is exposed to the elements, it becomes more susceptible to various types of corrosion. This was a common failure mode that was identified when benchmarking with other utilities. To mitigate this failure mode, some utilities use medium voltage fusion tape (MVFT) on electrical connections to the line. SDG&E utilizes Insulated Piercing Connectors (IPCs) to make electrical connections and a tensioning clamp for structural connections. Water ingress testing was performed by both SCE and PG&E to evaluate the corrosion susceptibility for instances when the covering is removed. SCE varied the test by utilizing a tool specifically designed to remove the covering to expose a length of bare conductor and removing the covering manually without unique tools; they also varied the conductor material to include copper and aluminum. The conductor was then placed vertically with a dedicated reservoir of fluorescent water at the top to simulate moisture intrusion. In all the tests, water was visible at the opposite end of the conductor segment within 5-10 minutes. PG&E's version of the testing was varied to test various types of CC with and without water-blocking agents. PG&E's test was also slightly different because a length of exposed conductor was not left at the top, but rather a clean cut was made on each of the conductors. For the conductors without water-blocking agents, fluorescent water was observed at the opposite ends of the conductor while there was no liquid observed for the conductors with water-blocking.

Although the water ingress testing setup, conducted in a submersible configuration, is not likely to occur in the field, water ingress can lead to accelerated corrosion. Additional preventative actions taken during installation and/or maintenance, such as the use of IPCs, tension clamps, gel wraps/packs, wildlife covers, or MVFT, may help limit moisture ingress and related corrosion effects. For example, PG&E's water immersion test of gel wraps demonstrates this mitigation's ability to prevent water intrusion for splice and other electrical connections. Additionally, corrosion can potentially be mitigated with the use of copper CCs due to copper being less susceptible to corrosion than aluminum in high corrosive areas.

Salt spray testing was performed by SCE to evaluate the susceptibility of exposed ends of CC to corrosion in coastal and industrial environments. This testing utilized a 5% salt solution for 168 hours with a SO₂ solution introduced intermittently. The testing varied like the water intrusion testing, but also added artificial defects to simulate mid-span damage and performed the testing on bare conductors as well. Corrosion was identified on the exposed portion of the CC as well as under the covering. When a conductor had simulated damage, the most severe corrosion occurred. Exponent did identify that a segment of CC was evaluated which utilized an IPC; however, this did not demonstrate corrosion.

PG&E's atmospheric corrosion tests consisted of 1,000 hours of exposure using a 5% salt solution. This test evaluated bare conductor, CC, and splice connections with MVFT or gel packs. PG&E summarized that aluminum CCs are more susceptible to corrosion compared to bare conductor when exposed to a corrosive environment. This ingress is reduced with the application of MVFT and altogether eliminated

with the use of gel packs. It is also important to note that all conductors met the rated breaking strength after the testing was completed.

Aging Susceptibility Testing

PG&E performed UV weathering tests with 1,000 hours of exposure time (ASTM G155-21). Two types of CCs were tested and neither met the tensile or elongation requirements of ANSI/ICEA S-121-733 to be considered resistant to sunlight. The results indicate that the covering is susceptible to degradation and cracking after long-term exposure to UV for the conductors tested.

Exponent, with SDG&E, performed accelerated aging testing by monitoring a segment of the cover at 10% thickness. It is assumed that the rate of change that is observed with a segment at 10% thickness can be used to anticipate the amount of deterioration over 40 years. Three tests were performed at 80C, 110C, and 130C; one test was performed at 80C with 1.60W/m² at 340nm UV. The UV data would then be interpolated with the results of the 110C and 130C samples to test the properties of interest; those include dielectric constant, mechanical strength, chemical changes, and visual changes. The results of this test also indicate that the covering is susceptible to degradation and cracking after long-term exposure to UV.

System Strength Testing

After the salt-spray corrosion testing, Exponent evaluated the tensile testing strength of the various aluminum, copper, and steel strand samples. The results from the individual strands can be used to assess the condition of the whole conductor. They showed that even though the aluminum strands underwent corrosion due to the accelerated aging, there was not a significant loss of strength in the conductor overall. For conductors with IPCs installed, there was a measurable decrease in tensile strength of the conductor strands related to the damage caused by the IPC, the degradation was not due to corrosion. Other utilities that utilize IPC's to make electrical connections have not identified this to be a concern.

PG&E evaluated the tensile strength of the conductors to confirm that they met the rated breaking strength and to evaluate how the conductor and cover would react. Both conductors tested exceeded the rated breaking strength. At the point of fracture, necking occurred but was more significant for the covering than the aluminum and steel wires. Small segments of exposed conductor could be seen protruding from the covering. Because of this, breaks in the conductor could result in phase-to-ground contact, which could lead to an ignition.

SCE's system strength tests included a splice maximum load test, insulator slip test, and a tree fall test. For the splice max load test, all splices met or exceeded specifications. For the insulator slip test and tree fall test, two different types of insulators were used. One experienced deformation of the metal pin while the other showed signs of slippage with no apparent damage. For a simulated tree fall on a dead-end configuration, a failure occurred with smaller sized conductor due to it slipping out of the dead-end shoe. It was noted that the failure likely occurred above the rated strength of the conductor. For larger conductors, the failure point was at the crossarm.

Electrical Properties Testing

PG&E performed leakage current and dielectric withstand tests on the covering and various splice coverings. For the covering tests, two different types and sizes of conductor were used, both with full cover thickness and 50% cover thickness to simulate a flaw. In all the covering test cases, the insulation failed at a voltage level that greatly exceeded its rated value. The splice covers tests consisted of a

compression splice with gel pack, compression splice with MVFT, and a fired wedge connector with a cover. In all cases the splice coverings met or exceeded the ratings of the CC insulation rating.

To understand if CC could be susceptible to tracking damage, inclined plane tracking and erosion tests and tracking resistance with salt fog tests were performed. For the inclined plane and erosion tests, both conductor samples passed; however, one of the conductors showed a greater erosion depth. The tracking resistance with salt fog tests were designed to understand the impacts of long-term vegetation contact. Again, for these tests, both conductors met the passing criteria but, again, the same conductor showed a greater erosion depth.

PG&E tested the damaging effects that lightning might have on the covering. This was a custom test with guidance from IEEE Std. 4 and IEC 60060-1. The conductor samples were subjected to lightning impulses starting at 85 kV and then increased in the magnitude of the voltage until a breakdown occurred. Both of the conductor samples tested experienced breakdowns between 90-110 kV for each of the 5 samples. The conclusion of the lightning tests is that both coverings have the potential to be damaged by lightning; however, damage is expected to be localized and would be unlikely to cause auto-ignition of the covering.

Covering Properties Testing

The thermal properties of conductor layers were tested by PG&E to verify the glass transition temperatures for each layer of two different conductors. One of the conductors exhibited an onset of glass transition in the conductor shield layer at a lower than emergency temperature rating which could indicate possible early covering degradation if exposed to emergency temperatures repeatedly. The other conductor showed no signs of degradation up to the emergency operating temperatures.

Next Steps:

As explained above, several testing results were completed in December 2022 with a few still remaining. The utilities have met to overview the results of some completed tests but have not yet discussed all results nor in detail yet. In 2023, the utilities will conduct meetings and workshops to assess the testing results, determine if any additional tests are needed, determine if any mitigations are warranted (such as changes to materials, construction methods, or inspection practices), and will meet to assess whether changes to effectiveness estimates are warranted. Additionally, and as part of the workshops, the utilities will discuss the testing results in relation to PSPS de-energization thresholds. Below, we present a preliminary schedule for workshops and discussion themes.

Once the utilities finalize the workshop schedule, Energy Safety will be invited. Based on findings from the workshops, additional workshops may be scheduled in 2023. Additionally, the utilities will continue to meet on a biweekly basis. Should the results of the workshops lead to changes in materials, construction practices, effectiveness values, etc., the utilities will establish plans to implement these changes and document as part of lessons learned.

Recorded Effectiveness:

As explained throughout this report, the utilities have continued to implement CC and are using recorded data to help assess its effectiveness in the field. Though the utilities' data is still relatively limited, the outcomes in 2022 in addition to previous years outcomes, as presented below, continue to show CC effectiveness at reducing the risk drivers that can lead to wildfires range between approximately 60 to 90 percent, which is consistent with the utilities' estimated effectiveness values and supported by recent testing results. Below, the utilities provide an update on its 2022 WMP Update report describing data and analyses used to measure recorded effectiveness of CC and plans for 2023 to continue to discuss and share recorded data and methods to measure effectiveness, and document lessons learned.

*Covered Conductor Recorded Effectiveness:*SCE

SCE has continued to refine its data and methods to measure the effectiveness of CC in the field. In 2022, SCE set up a CC dashboard that tracks fault rates on overhead distribution circuits with 100% CC installed, circuits that are partially covered, and circuits with no CC installed (bare wire). The data can be broken down by fault sub-drivers such as CFO, EFF, and Other. The data is based on all circuits that traverse HFTD and includes a breakdown of how many miles fall into the fully covered, partially covered, and not covered categories. The dashboard refreshes daily with updated fault and CC data. Because faults that occur on partially covered circuits are difficult to determine if occurred on the covered or bare portion, SCE has further delineated this data into the following partially covered groups: Less than 25%, 25% to 49%, 50% to 74%, 75% to less than 100%. Furthermore, SCE is now using a faults per mile-day method that factors in how long the circuit was fully or partially covered. In 2022, SCE provided overviews of its dashboard, grouping and methods to this working group. Faults per mile-day data from 2019-2022 are shown in Figure CC-1 below.

Figure CC-1
SCE Faults Per Mile-Day as a Function of Covered Conductor

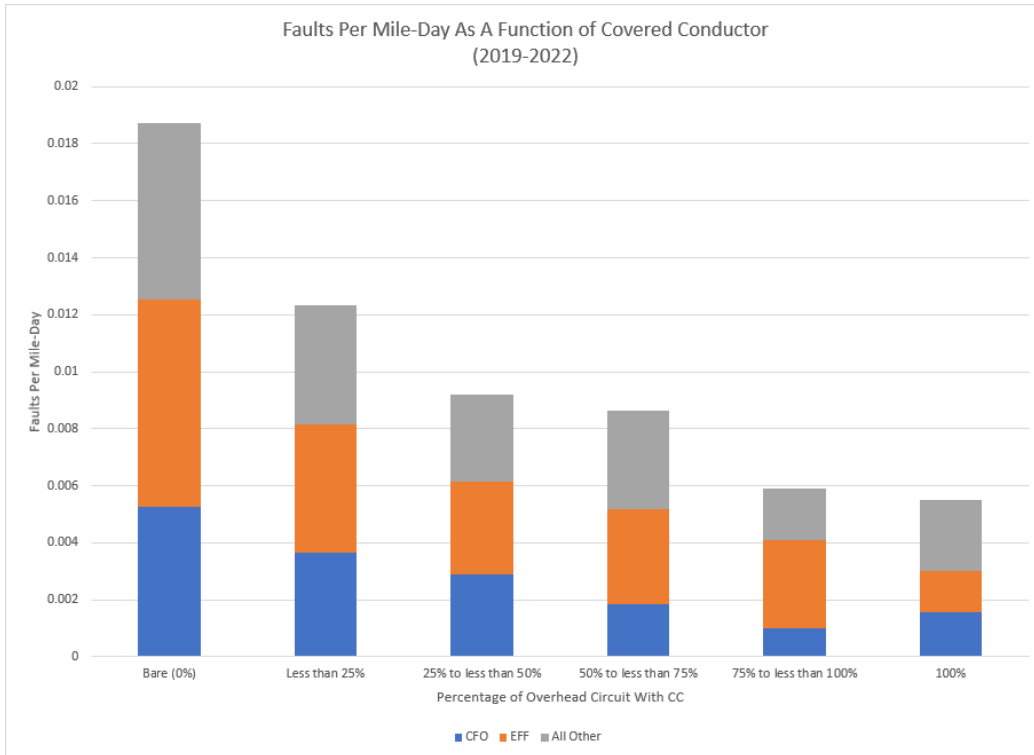

By comparing fault events on fully and partially covered circuits to bare circuits in its HFRA on a per mile-day basis from 2019 to 2022, the data shows that circuits fully covered experience approximately 70% less faults than bare conductor when factoring in all sub-drivers (see Table X below). Additionally, circuits that are in the 75% to less than 100% covered group experience a similar improvement over bare conductor at approximately 69% less faults. The data also shows a predicted trend with an increasing reduction in faults as more of a circuit is covered. Furthermore, on segments where SCE has covered bare wire, there has not been a CPUC-reportable ignition from the drivers that CC is expected to mitigate.

Table CC-3
SCE Fault Events on Fully and Partially Covered Circuits Compared to Bare Circuits

Grouping	Reduction Compared to Bare			
	CFO	EFF	All Other	Total
Bare (0%)	0.0%	0.0%	0.0%	0.0%
Less than 25%	30.6%	38.3%	32.0%	34.1%
25% to less than 50%	45.3%	54.9%	50.7%	50.8%
50% to less than 75%	65.0%	54.0%	43.9%	53.8%
75% to less than 100%	81.0%	57.6%	70.8%	68.5%

100%	70.3%	80.3%	59.2%	70.5%
------	-------	-------	-------	-------

PG&E

As of the end of 2022, the number of ignitions observed on the CC lines does not provide statistically significant data for calculating effectiveness with respect to ignitions. As most distribution outages (momentary and sustained) typically involve a fault condition, PG&E assumes that all distribution outages can potentially result in an ignition, regardless of other prevailing conditions. Therefore, PG&E is measuring the recorded effectiveness of CC by comparing the outages on the circuit segments with CCs to outages on circuit segments with bare conductors.

PG&E’s recorded effectiveness is calculated in three different snapshots. The first snapshot considers all CC installations by the end of 2019 and average yearly outages in 2020-2022. The 2nd snapshot considers the CC installations by the end of 2020 and average yearly outages in 2021-2022. Lastly, all CC installations by the end of 2021 and outages in 2022 are considered in the 3rd snapshot.

PG&E has not included CC installations that were completed in the middle of year 2022. PG&E is only including locations that were completed by end of year (EOY) 2021, so that there is a minimum of 1 year of outage performance data to be able to compare with outage performance in areas with bare conductor.

The comparison was conducted on an outages per year, per mile basis to normalize outage rates pre- and post- CC. Table CC-4 below presents the results of this preliminary recorded effectiveness analysis.

**Table CC-4
PG&E Recorded Effectiveness Snapshots**

Snapshot	Category of OH HFTD circuit segments (downstream of SSDs)	Total CC miles in this category	Total OH HFTD miles in this category	% CC'ed	Average yearly HFTD outages	Outage / Total OH HFTD miles / year	Improvement compared to Category 1
1: CC miles % of total OH miles by the end of 2019	Outages considered: 2020-2022						
	Category 1: not covered at all	0	24,849	0%	9339.7	0.38	-
	Category 2: 1-80% (partial)	27	242	11%	53.7	0.22	41%
	Category 3: 80%+ (mostly)	36	38	95%	4.3	0.11	69%
2: CC miles % of total OH miles by the end of 2020	Outages considered: 2021-2022						
	Category 1: not covered at all	0	24,950	0%	9544	0.38	-
	Category 2: 1-80% (partial)	122	640	19%	157.5	0.25	36%
	Category 3: 80%+ (mostly)	178	185	96%	19.5	0.11	72%
3: CC miles % of total OH miles by the end of 2021	Outages considered: 2022						
	Category 1: not covered at all	0	24,942	0%	5978	0.24	-
	Category 2: 1-80% (partial)	148	877	17%	151	0.17	28%
	Category 3: 80%+ (mostly)	238	248	96%	18	0.07	70%

The calculated outage reduction percentage (used as a measure for the recorded effectiveness) shows that CC sections experience approximately 28-70% fewer faults compared to bare conductor circuit segments.

PG&E’s results are presented in Table CC-4. These results are preliminary due to the following factors:

- Using an averaged per mile rate for the outages inherently omits the granular perspective related to each individual section of the circuits in PG&E’s service area because it does not capture the impact of localized environmental/weather conditions. Hence, this analysis may over or under-represent effectiveness.
- It is assumed that all distribution outages could potentially result in an ignition. It does not factor in if one type of outage is more or less likely to result in an ignition. However, there are several failure modes such as tie-wire failure that have a much lower likelihood of ignition compared to an outage due to a broken conductor.
- The outages in partially covered and mostly covered categories (category 2 and 3) could have occurred on parts of the line that are not covered, which cannot be validated due to lack of exact geospatial information for the outages.

As part of PG&E’s ignition investigation process, it is incorporating additional review of ignition identification that occurs on a CC line to ensure visibility of failures based on observed incidents. Below are some examples related to the effectiveness of CCs in the field that have been observed in PG&E’s service area.

Example 1:

On 5/10/2021, a 125-foot ponderosa pine that was 55-feet away from a pole, failed approximately 40-feet above ground, severing the CC, causing a wire down, and a subsequent CPUC reportable ignition.

Figure CC-2
PG&E Covered Conductor Effectiveness – Example 1



Example 2:

On 5/2/2022, a 120-foot ponderosa pine that was being abated for previously reported structural concerns, fell on a CC line, severing it, and starting a CPUC reportable ignition.

Figure CC-3
PG&E Covered Conductor Effectiveness – Example 2



These two incidents highlight some limitations concerning CC. In both incidents, there were vegetation management inspections and CC deployed. But even with the combined mitigations, it still resulted in an ignition.

Example 3:

On 12/27/2021, two CCs were supporting an entire tree. There was no ignition; however, an electrical outage did occur on the line.

Figure CC-4
PG&E Covered Conductor Effectiveness – Example 3



SDG&E

As CCs become a larger part of the system, the performance indicators that impact the efficacy of this mitigation will continue to be monitored and measured, including the measured effectiveness. As there are approximately 84 miles of CC installed with an average age of less than one year, SDG&E does not have sufficient data yet to draw any conclusions on the recorded effectiveness of CC.

Moving forward, SDG&E will continue to track the mileage, years of service, and faults on all CC circuit segments and will continue to collaborate with this working group to improve methods to measure the effectiveness of its system hardening initiatives. SDG&E's approach is to calculate the risk events per one hundred miles per year on segments that have been covered and compare the risk event rate before and after the installation of CC.

PacifiCorp

PacifiCorp continues to track risk events within each zone of protection (ZOP) with known conductor types and assumes homogenous performance across the ZOP. Current processes do not establish specific locations where fault events occur, but are reconciled to the device that protects the ZOP. To establish the recorded effectiveness, PacifiCorp queried pre- versus post-installation performance with risk event drivers for all ZOPs having CC (specifically spacer cable construction). It was important to recognize that legacy projects were focused on reliability and thus did not require reconductoring of the entire ZOP. As such, the recorded effectiveness calculations accounted for the percentage of the ZOP that wasn't reconductored. The smaller the percentage of the ZOP the less the confidence of the recorded effectiveness, while the higher the percentage of the ZOP the higher the confidence of the calculation.

PacifiCorp has also documented known contact-related events with CC. As shown in Figure CC-5 below, these events did not result in faults, wires down, or ignitions because spacer cable was deployed and provide examples of effectiveness in the field.

Figure CC-5
PacifiCorp Covered Conductor Effectiveness Examples



PacifiCorp will continue to monitor and track all faults on our CC circuits and track performance as compared to bare wire installs. PacifiCorp will also continue to collaborate in this working group to ensure we gather and share information from the other IOUs.

Bear Valley

BVES has approximately 211 circuit miles of overhead conductor between 34.5 kV and 4.16 kV in its system. BVES started a CC pilot program in Q2 2018 and completed it in Q3 2019 using two different type of cover conductor wires (394.5 AAAC Priority wire and 336.4 ACSR Southwire). Then, BVES started the cover conductor WMP in late 2019 with plans to cover 4.3 circuit miles on 34.5 kV over the next 4 years and 8.6 circuit miles on 4.16 kV over the next 10 years. As of end of Dec. 2022, BVES has covered approximately 34 miles between its 34 kV and 4 kV systems.

In Q3 2018, BVES started a new tree-trimming contract with a new tree service contractor. BVES has been very aggressive with its vegetation manage program having up to four tree crews or more at a time to complete its three-year cycle and remediating any issue trees which has helped reduce outages from vegetation contacts. As of end of 2021, BVES has completed its vegetation three-year cycle and in 2022 has started a new three-year cycle vegetation manage program.

As part of its wildfire mitigation efforts, in June 2019, BVES began replacing all explosion fuses in its service area with Trip Savers and Elf Fuses. BVES completed this project in May 2021, which eliminated the potential for ignitions from explosion fuses.

Though 2022, BVES has still not had any outages, wire down, tree limbs and/or ignitions on the lines that have been covered. BVES is still in the early stages of its CC program. As more areas are covered and as more time passes, BVES will compile more recorded data to inform on the effectiveness of CC. The table below provides a simple assessment of recorded outages since 2016 and through 2022.

Table CC-5
BVES Recorded Outages (2016-2022)

Year	# of Outages
2016	75
2017	95
2018	34
2019	26
2020	57
2021	46
2022	52

Liberty

Liberty’s CC program is relatively new, having begun in 2020. Because the program is new, data on the performance of CC effectiveness do not yet demonstrate meaningful recorded effectiveness results based on the limited sample period and the wide variations in weather conditions from year-to-year. In addition, the CC projects completed thus far represent a small percentage of each circuit’s total line miles.

Based on a review of Liberty’s Outage Management System (OMS) data, there have been zero reported outages or ignitions caused by an event on CC spans. The only known event that occurred on a CC span, in a spacer cable configuration, happened during a winter storm in early January 2023. The event did not create an outage or ignition and it was found as a result of a post-storm aerial patrol. In this incident, a tree fell across a spacer cable span that was installed in 2020. The tree pulled down the span and caused three poles to lean significantly; however, the messenger wire held up the tree and prevented a fault and a wire from falling to the ground. The figures below represent this one incident.

Figure CC-6
Liberty Spacer Cable System Preventing a Fault – Viewpoint 1



Figure CC-7
Liberty Spacer Cable System Preventing a Fault – Viewpoint 2



Upon finding the damage, the poles were reset to vertical and the damaged support brackets were replaced. No damage was found related to the conductor.

Liberty intends to continue to monitor CC effectiveness and reinforce the need to collect and highlight any events that occur on CC. As more CC is installed and is in service for a longer period of time, the data collected will become more meaningful.

Next Steps:

In 2023, the utilities will continue meet on a regular basis, provide updates on risk event recorded data, discuss the methods used to measure the effectiveness of CC in the field, and continue to work towards developing consistent methods to measure the effectiveness of CC for better comparability. The utilities also plan to discuss outage data, causation identification and reporting. These efforts will require SME discussions and review of outage, wire-down and ignition data across the utilities. The utilities will also document any lessons learned.

Alternatives:

Overview:

In the 2022 WMP Update filings, the utilities identified a list of viable alternatives to CC and conducted workshops with SMEs that assessed the effectiveness of those alternatives against the same risk drivers that CC is designed to mitigate. In 2022, the utilities focused on the combination of mitigations utilities deploy as it relates to CC and alternatives to CC and discussing a framework to calculate the effectiveness of the combination of mitigations deployed on the same circuit or circuit-segment. Below, we describe these efforts and plans for 2023 to further this workstream.

Combination of Mitigations:

The combination of mitigations refers to the suite of mitigations utilities deploy in relation to CC and alternatives to CC on circuits or circuit-segments to mitigate wildfire risk and/or reduce the impacts of PSPS. For example, all utilities deploy CC and where CC is installed all utilities conduct vegetation management mitigations and asset inspection mitigations. Additionally, circuits that have CC are still in scope for potential PSPS and most utilities also employ fast curve settings on these circuits during elevated fire-weather conditions. Likewise, several utilities deploy undergrounding to mitigate wildfire risk and PSPS impacts and where circuits are undergrounded, vegetation management mitigations are significantly lessened if not eliminated, the potential for PSPS is in most cases eliminated, and asset inspection mitigations can also be reduced. Notwithstanding system configuration, geography, terrain, permitting, costs, the time to deploy, operational/resource constraints, environmental constraints and other considerations, utilities can choose to install CC or other mitigations such as traditional hardening, new bare conductor, undergrounding, a remote grid, and/or new technologies to mitigate wildfire risk and/or reduce the impacts of PSPS. In choosing between CC and alternatives to CC, utilities will also deploy other mitigations. As such, the utilities understand the need to explore methods to assess the effectiveness of a combination of mitigations.

Historically, utilities have largely estimated the effectiveness of mitigations separately. The utilities have discussed methods to calculate the effectiveness of multiple mitigations deployed on the same circuit or circuit-segment. In 2022, the utilities discussed efforts to perform such a combination of mitigations calculation. While PG&E and SDG&E have not yet adopted a framework for this evaluation, SCE shared its preliminary framework (Figure CC-8) to calculate the effectiveness of a combination of mitigations.

Figure CC-8
SCE Preliminary Framework – Calculation of a Combination of Mitigations

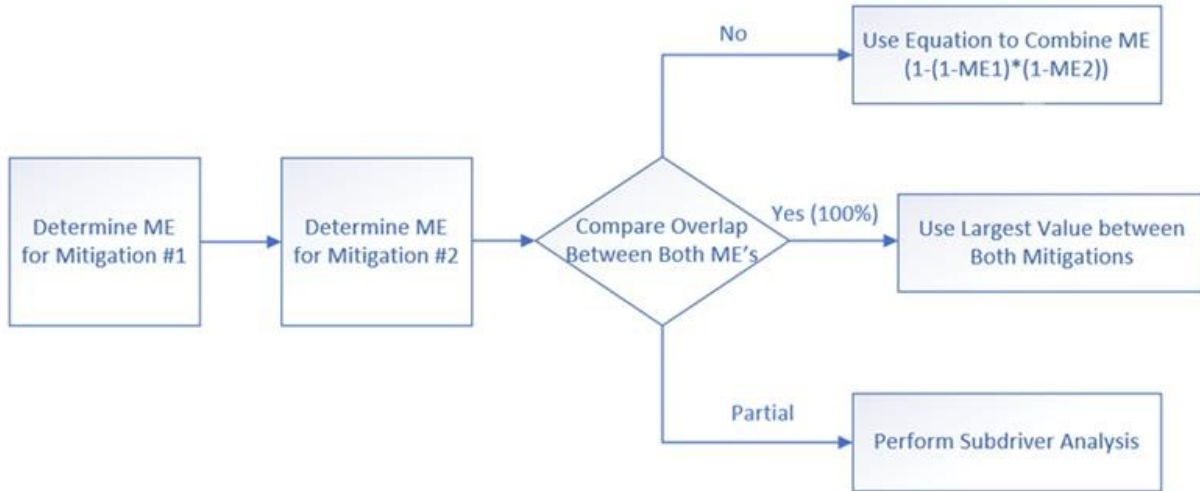

SCE’s preliminary framework includes three prongs given that mitigation measures can target the same or different risk drivers. For example, CC is highly effective at reducing most contact-from-object sub-drivers such as light vegetation contact, animal contact, and metallic balloons. However, CC is not highly effective at reducing faults/ignitions from large trees that can fall into lines. The framework thus distinguishes the overlap of multiple mitigations. In the first prong, if multiple mitigations have no overlap in the risk drivers they mitigate, a standard equation can be used to calculate the combined effectiveness, as seen in Figure X. In the second prong, SCE considers where mitigations directly overlap with one another for a particular risk driver. In these instances, the mitigation with the highest effectiveness would be the combined effectiveness value. In the third prong, SCE considers where mitigations may target the same risk driver but they reduce the risk differently. In these situations, further analysis is needed to determine the incremental effectiveness prior to then combining the effectiveness values. Additionally, once the effectiveness of combined mitigations by driver are calculated, those values then need to be applied to the frequency of the driver risk events. Given that these estimated values are based on calculations and quantitative data can be limited and not always available, the utilities have also discussed discounting the individual estimated mitigation values.

To illustrate this framework, we use a subset of SCE’s CC++ portfolio mitigation strategy. CC++ represents deploying CC, vegetation management, asset inspections, and other mitigations on the same circuit / circuit-segment that work collectively to better address the risk drivers than each by themselves. The tables and descriptions below are based on assessing the combination of CC, asset ground inspections, enhanced line clearing, pole brushing, and SCE’s HTMP. Table X shows independent estimated mitigation effectiveness values for the selected mitigations across selected contact-from-object and equipment failure sub-drivers. For purposes of this illustration, no discounting of individual estimated mitigation values was included.

Table CC-6
SCE Independent Mitigation Effectiveness Values

Risk Driver Description	WCCP	Distr Ground Asset Inspections	VM - Hazard Tree	VM - Expanded Pole Brushing	VM - Expanded Line Clearing
Animal contact- Distribution	65%	48%	0%	0%	0%
Balloon contact- Distribution	99%	0%	0%	0%	0%
Other contact from object - Distribution	77%	0%	0%	0%	0%
Unknown contact - Distribution	80%	0%	0%	0%	0%
Veg. contact- Distribution	71%	77%	64%	33%	36%
Vehicle contact- Distribution	82%	0%	0%	0%	0%
Capacitor bank damage or failure- Distribution	20%	87%	0%	20%	0%
Conductor damage or failure — Distribution	82%	80%	0%	7%	0%
Switch damage or failure- Distribution	2%	76%	0%	20%	0%
Transformer damage or failure - Distribution	20%	66%	0%	20%	0%

Using the risk driver vegetation contact, Table CC-6, above, shows varying estimated effectiveness values for WCCP, asset inspection, HTMP, expanded pole brushing, and expanded line clearing. All these mitigations work together to reduce the risk of vegetation contact causing a fire. For example, though CC addresses vegetation making contact with wires, line clearance and HTMP activities are also necessary to reduce heavy branches or trees falling into lines that CC may not be able to withstand. Asset inspection work assures equipment is in good condition, covers are in place, and if abnormalities are found, these are scheduled for remediation. These inspections also identify where vegetation may be in contact with equipment and conductors. While CC has shown, in the field, that there are times where it can withstand a large limb / tree fall-in and not create an outage and/or ignition, CC is not designed to withstand tree fall-ins. As such, and for purposes of this illustration, it is assumed these two mitigations do not overlap. Using the formula, described above, these two mitigations have an estimated combined mitigation effectiveness of approximately 90% $(1-(1-71%)*(1-64%))$. Asset inspections, expanded pole bushing, and expanded line clearing all have overlaps with CC for mitigating vegetation contact and thus require separate analyses. For purposes of this illustration, we assume these mitigations provide an approximate 9% incremental effectiveness for reducing vegetation contact risk. Combining all these values provides an estimated approximately 99% effectiveness value for risk of vegetation contact when all five mitigations are deployed on the same circuit / circuit-segment.

Following the same process, Table CC-7, below, shows the illustrative combined effectiveness values without considering quality control discounts. Additionally, applying the average annual frequency of historic faults and ignitions for these risk drivers, the table also shows the combined weighted average estimated effectiveness value for the selected mitigations.

Table CC-7
SCE Combined Mitigation Effectiveness Values

Risk Driver Description	Combined Effectiveness	Annual Fault Frequency in HFRA (2015-2020 Avg)	Fault-Weighted Combined Effectiveness	Annual Ignition Frequency in HFRA (2015-2020 Avg)	Ignition-Weighted Combined Effectiveness
Animal contact - Distribution	71%	644	6%	4.8	12%
Balloon contact - Distribution	99%	866	11%	5.0	17%
Other contact from object - Distribution	77%	420	4%	1.7	4%
Unknown contact - Distribution	80%	0	0%	0.0	0%
Veg. contact - Distribution	99%	469	6%	4.7	16%
Vehicle contact - Distribution	82%	550	6%	3.7	10%
Capacitor bank damage or failure - Distribution	92%	382	4%	0.2	1%
Conductor damage or failure - Distribution	85%	2,280	24%	8.3	24%
Switch damage or failure - Distribution	82%	58	1%	0.0	0%
Transformer damage or failure - Distribution	78%	2,334	23%	1.3	4%
Total Estimated Combined Effectiveness			84%		86%

In this illustration, Table X shows that when you combine WCCP with asset inspections, HTMP, expanded pole brushing, and expanded line clearing, the combined estimated effectiveness in mitigating faults and ignitions for the selected risk drivers and without discounting is approximately 84% and 86%, respectively.

Understanding the effectiveness of the combination of mitigations can be a helpful guide in utility decision-making. A common framework could also assist in greater comparability across the utilities. Challenges to developing such calculations include data availability, disaggregating effectiveness below the driver/sub-driver level to determine mitigation overlaps, and limitations in a purely formulaic method.

Next Steps:

In 2023, the utilities will meet regularly to discuss methods to determine effectiveness for the combination of mitigations. This will include building on the preliminary framework described above by detailing examples across the utilities. Because many mitigations overlap with one another and can reduce a driver of a risk event differently, the utilities will also discuss and share available data and analytical methods to determine these differences. Additionally, the utilities will explore the process to develop suites of mitigation measures that include new technologies in continuing to evaluate methods to calculate the effectiveness of a combination of mitigations.

New Technologies:

Introduction:

In the utilities' 2022 WMP Update Action Statements, Energy Safety identified an ACI for all utilities to collaborate to evaluate the effectiveness of new technologies supporting grid hardening and situational awareness such as REFCL and DFA/efd, particularly in combination with other initiatives. The utilities were also ordered to share practices and evaluate implementation strategies and that this effort should be a continuation of the CC study from the 2021 WMP Action Statements, including Energy Safety as a

participant. Below, we outline the utilities' approach, information gathered to date, and 2023 milestones to assess the effectiveness of new technologies and share practices and implementation strategies.

Summary of Approach:

The utilities initiated this workstream in Q4 2022 and have since conducted bi-weekly meetings. The initial meetings focused on identifying utility SMEs, discussing types of alternative technologies employed by the utilities, the status of those technologies, effectiveness values, approaches to sharing practices and implementation strategies and how to meet the ACI requirements, timelines/milestones. Evaluating the effectiveness of the technologies in combination with other mitigations is addressed in the scope for the Alternatives workstream, as described in the section above. Based on these initial discussions, it was first decided to document the various alternative technologies the utilities are employing. As seen below, very few technologies are employed across all utilities. The utilities then generally discussed effectiveness values and whether the new technologies can help reduce the impact of PSPS. It was learned that the majority of new technologies are still undergoing investigation and have limited data regarding effectiveness values. The utilities also discussed practices of how the technologies are being employed and learned that where utilities all employ a technology such as disabling reclosing settings, the practices are not all consistent. These areas of focus are further described below along with 2023 plans to conduct regular meetings and workshops focused on specific technologies. Beyond assessing the new technologies, the utilities also plan to document questions for benchmarking with other utilities and discuss any new research and/or other new technologies that the utilities are made aware of.

New Technologies

The utilities have identified 15 new technologies that one or more utilities employ, are piloting, and/or investigating. These include, for example, disabling reclosing settings, fuse replacements, fast curve settings, RAR/RCS, DFA, EFD, REFCL, and OPD. Table CC-8, below, identifies the new technologies or protection strategies being employed, piloted, and/or investigated to either mitigate wildfire risk and/or reduce the impacts of PSPS.

**Table CC-8
New Technologies By Utility**

New Technology / Protection Strategy	SCE	SDG&E	PG&E	Liberty	BVES	PacifiCorp
Fuse replacement (current limiting fuses, expulsion fuses)	Yes	Yes	Yes	Yes	Yes	Yes
Reclosing Settings (Disabling)	Yes	Yes	Yes	Yes	Yes	Yes
Fast curve settings / EPSS / SRP	Yes	Yes	Yes	Yes	No	Yes
Remote Controlled Automatic Reclosers / Remote Controlled Switches (RAR/RCS)	Yes	Yes	Yes	Yes	Yes	Yes
Distribution Fault Anticipation (DFA)	Yes	Yes	Pilot - Moving to Deployment	Investigating	No	Pilot
Early Fault Detection (EFD)	Yes	Yes	Pilot	No	No	No
Rapid Earth Fault Current Limiter (REFCL)	Pilot - Moving to Deployment	No	Pilot	No	No	No
Open Phase Detection (OPD)	Yes	No	Yes	No	No	No
Falling Conductor Protection (FCP)	No	Yes	Pilot	No	No	No
Smart meter (MADEC)	Yes	Yes	Yes	No	No	No
Household Outlet	Pilot	No	Pilot	No	No	No
Sensitive ground fault detection (relays)	Pilot	Yes	Yes	No	No	No
Electrical Grid Monitoring (EGM)	No	No	No	No	Pilot	No
Thor Hammer	No	No	Pilot	No	No	No
Intumescent wrap / Fire-wrap poles	Yes	No	Yes	No	Yes	Yes

As seen in Table CC-8, there are only three types of new technology or protection strategies employed by all utilities. These include fuse replacements, disabling reclosing settings, and RAR/RCS. The other technologies are either being deployed, piloted, and/or investigated by a few utilities. Two technologies, DFA and REFCL, are moving from a pilot phase to deployment for PG&E and SCE, respectively. The utilities will further discuss the differences of these technologies to understand overlaps and similarities. For example, OPD and FCP have a similar purpose.

Practices and Implementation Strategies

The utilities have started to share practices for the new technologies. For example, while all utilities disable reclosing settings to mitigate wildfire risk, utility practices vary. For instance, SCE, PG&E and Liberty disable reclosing settings on circuits in HFRA during fire season, SDG&E disables settings, also on circuits in HFRA, but does it year-round, and BVES disables from April to October. The utilities believe that focused meetings and workshops on specific technologies are needed to share practices and implementation strategies. As such, the utilities will conduct focused workshops for specific technologies, as described below, to determine if best practices can be identified and will continue to share practices and implementation strategies in bi-weekly meetings.

Effectiveness Values

In many instances, the utilities are still investigating or have limited data as it relates to effectiveness values. The utilities have documented and shared effectiveness values for a few technologies but have not yet discussed these in detail. For example, effectiveness values for fast curve settings (when operating) range from approximately 49% to 100% effective at reducing ignitions (based on limited data

that is not statistically significant). Given the large range, the utilities will conduct a workshop on the effectiveness of fast curve settings to share data and methods. Additionally, the utilities will discuss whether the technologies help reduce the impact of PSPS. As described in the next steps, the utilities have identified certain technologies for workshops and will continue to document estimated effectiveness values and the potential to reduce PSPS across all technologies.

Next Steps:

In 2023, the utilities will continue to document and assess the estimated effectiveness of new technologies where data is available, their ability to reduce PSPS impacts, and will continue to document and share practices and implementation strategies. These objectives will be accomplished through biweekly meetings and a series of workshops. Based on discussions to date, the utilities provide the following preliminary workshop schedule and themes.

Once the utilities finalize the workshop schedule, Energy Safety will be invited. Additional workshops may also be scheduled in Q3/Q4 2023. Should the results of the workshops lead to best practices, the utilities will establish plans to implement the changes and document as part of lessons learned.

M&I Practices:

Introduction:

In the utilities' 2022 WMP Update Action Statements, Energy Safety identified an ACI for all utilities to share and determine best practices for inspecting and maintaining CC, including either augmenting existing practices or developing new programs, to include this effort as part of the Joint IOU Covered Conductor Working Group, and for the IOUs to continue to lead this study and to include Energy Safety as a participant. Below, we outline the utilities' approach, information gathered to date, and 2023 milestones to assess the utilities' CC M&I practices, determine if best practices can be identified, and if best practices can be identified, put in place plans to implement those best practices.

Summary of Approach:

The utilities initiated this workstream in Q4 2022 and have since conducted weekly meetings. The initial meetings focused on identifying utility SMEs, discussing approaches to determine best practices and how to meet the ACI requirements, and timelines and milestones. Based on these initial discussions, the utilities agreed to a common approach that is both broad and focused. The approach includes first capturing information such as each key utility facts (e.g., service area size in HFRA), types of inspections utilities perform on distribution overhead conductor, general M&I practices for distribution overhead conductor, specific practices for CC, general and specific training the utilities conduct, and QA/QC information. Capturing broad information such as the types of inspections utilities perform provides a high-level understanding of how each utility performs inspections, the frequency it performs them at, and other related information. In assessing these sets of information, the utilities believe the determination of best practices will require a series of focused workshops and follow up meetings with SMEs, engineers, inspectors, QA/QC personnel and other resources as needed. Focused workshops are needed to facilitate determining if best practices can be identified. For example, all utilities perform ground and aerial inspections which are generally conducted similarly; however, they are not all performed the same way. Determining a best practice relating to performing a ground and/or aerial

inspection for CC will require detailed discussions focusing on very specific aspects of the resources that do the work, tools and equipment used, the methods used, and other factors, some of which may only be obtained by conducting field observations across the utilities. It is also important to note that while there are differences in practices, determining best practices can take months, if not years, and that a best practice for one utility may not be a best practice for another utility for reasons such as costs, geographic size of the utility, and resource limitations. Given these facts, the utilities will also document any lessons learned that may be helpful for one or more utilities and can be added to existing M&I practices. Beyond assessing existing practices, the utilities also plan to document M&I-related questions for benchmarking with other utilities, learn from the testing workstream (should any CC inspection and/or maintenance practice be recommended from that workstream), and discuss any new research and/or new technologies that the utilities are made aware of as it relates to CC M&I practices.

Key Distribution Data

The joint utilities vary in size and it is important to consider this information when assessing best practices. Table CC-9, below, provides a few data points in HFRA, unless as otherwise noted, regarding the utilities’ service area size, the facilities they maintain, and the average number of distribution inspectors. The figures in the table are approximate values.

**Table CC-9
Key Distribution Data by Utility**

Key Data in HFRA	PG&E	SCE	SDG&E	PacifiCorp	Liberty	BVES
Distribution Overhead Circuit Miles	25,200	9,600	3,400	813	676	211
Distribution Poles	630,000	290,000	81,000	20,378	23,058	8,860
Square Miles	41,000	14,000	2,600	7,155	938	32
Average Number of Ground Inspectors (Systemwide)	203	153	50	5	4	2

As illustrated in Table CC-9 above, PG&E has significantly more square miles, distribution overhead circuit miles, and distribution poles in its HFRA to inspect and maintain. Conversely, BVES has the smallest HFRA square miles and least amount of distribution overhead circuit miles and distribution poles to maintain and inspect. As described more below, due to HFRA size alone, a best practice at PG&E may not be an ideal practice for BVES and vice versa.

Types of Distribution Inspections

The utilities perform several types of inspections on distribution facilities. These include detailed ground inspections, aerial inspections, infrared, patrols, Areas of Concern (AOCs) and LiDAR. These distribution inspection types are designed to meet or exceed GO 95 and GO 165, and also to mitigate wildfire risk. Tables CC-10 and CC-11 below highlight the types of distribution inspections the utilities perform.

**Table CC-10
Types of Distribution Inspections performed by SCE, PG&E and SDG&E**

Types of Distribution Inspections	SCE	PG&E	SDG&E
Detailed - Ground	Every distribution structure inspected between twice a year and up to once every 3 years, and high-risk structures inspected at least every year; Inspectors on the ground can use binoculars and/or cameras when needed	HFTD: Structures inspected every 1-3 years based on wildfire consequence; Top 10% risk structures inspected every year; Non-HFTD: every 5 years Inspectors use binoculars when needed	Every distribution structure inspected every 5 years
Detailed - Aerial	Every distribution structure inspected between twice a year and up to once every 3 years, and high risk structures inspected at least every year; SCE does 360 degree inspection from ground and the air with the same resources (drone) in the same time period	Will cover ~48K distribution structures in 2023 in the highest wildfire consequence areas; Longer-term plan will be developed based on the learnings from 2023 drone program	Drone inspections are performed on high-risk assets each year; Risk assessment performed annually to determine scope of assets to be inspected that year; Approximately 15,000 structures inspected per year.
Infrared	5,100 distribution overhead circuit miles targeted for inspection in 2023; performed on the ground	Conducted at high risk locations on an ad hoc basis	18,000 structures per year; plus ad hoc based on cause-unknown outages; Combination of aerial and ground
Patrol	100% of above ground and subsurface assets inspected annually; Conducted by ground mostly and helicopter/drone if needed (e.g., access issues)	HFTD: 100% of assets that are not inspected each year Non-HFTD: Based on urban/rural designations	100% of assets inspected annually
Areas of Concern (AOCs)	Additional inspections based on area of concern analysis conducted in late spring / early summer	Additional inspections are performed in areas of concern when needed.	See drone inspections - areas of concern determined by risk assessment and these are performed via drone
LiDAR	In 2023, will evaluate the use of this technology for asset-condition assessments; Historically, used for construction, planning, crew access, vegetation, etc.	Utilized to update pole orientation and associated attributes such as communication line, guy, anchor Database is then leveraged to conduct pole loading assessment to identify overloaded poles for replacement	Only utilized for construction planning purposes

Table CC-11
Types of Distribution Inspections performed by PacifiCorp, BVES, and Liberty

Types of Distribution Inspections	PacifiCorp	BVES	Liberty
Detailed - Ground	Every distribution structure inspected every 5 years; Inspections on ground use cameras and binoculars	Every distribution structure inspected every 5 years	Every distribution structure inspected every 5 years
Detailed - Aerial	Every distribution structure is inspected every year in Tier 2/3 areas and every 2 years in non-Tier areas; Inspection is performed from the ground with same resources in the same time period	Contractor performs drone inspections yearly with infrared on 100% of 34 kV and 4 kV distribution circuits	No aerial inspections on distribution at this time.
Infrared	Only when requested	100% of 34 kV and 4 kV distribution circuits per year	No infrared at this time
Patrol	100% of assets inspected annually	100% of assets inspected annually	100% of assets inspected annually
Areas of Concern (AOC)	Additional inspections performed when requested	May complete addition patrol inspection during extreme dry day with possible high fire risk	Additional inspections are performed in areas of concern when needed
LiDAR	Not performed on distribution circuits, but has been used in the past for vegetation	Use yearly for vegetation management (Check to see if vegetation is near lines)	Use for vegetation management

As shown in the tables above, the utilities perform similar types of inspections. Given the requirements of GO 95 and GO 165, this was to be expected. There are differences, however, in some inspection types as well as in some practices. For example, not all utilities conduct detailed ground inspections on high-risk / high consequence structures (and conductor) every year. Being that the focus of this effort is on CC M&I practices, obtaining findings for CC during these inspections and discussing amongst the utilities will help inform if a best practice can be identified and whether that best practice should and can be applied to all utilities. Similarly, some utilities conduct Areas of Concern (AOCs) inspections and SCE is evaluating LiDAR for asset condition assessments, which has historically been used for vegetation clearances and construction-related purposes. The utilities will discuss these types of inspections, focused on CC, and assess how useful they are in maintaining CC to determine if they should and can be utilized across all utilities.

General M&I Practices

Because utilities have performed inspections and remediation on overhead facilities for decades, the utilities have shared and discussed various aspects of what inspectors look for when assessing the condition of overhead conductor, regardless if covered or bare (as most assessments for bare will also

apply to covered). For example, during detailed ground inspections, inspectors will assess (naked eye and/or binoculars) all components and equipment attached to a pole and any materials connected to conductors. These inspections look for deterioration/corrosion, pitting, damage, clearance issues, sagging, loading, alignment issues (e.g., dead-end covers), misconfigurations, conformance with construction standards (e.g., missing covers/guards), exposed sections for splices, connectors, vegetation in immediate need for remediation, and other abnormal conditions. All of these potential issues apply to bare and CC. In large part, many of the methods and potential issues inspectors look for with bare conductor equally apply to CC. Given this fact, it is important to understand the general M&I practices for overhead conductor that utilities use. The utilities will also explore determining abnormal conditions that could cause a safety or fire ignition risk resulting in remediation and how these are prioritized. Additionally, inspectors that perform this work have understanding and knowledge that can inform the assessment of potential best practices and the utilities intend to include these resources in the workshops. The utilities will continue to discuss and document these practices and prepare for workshops to determine if best practices for CC can be determined.

Specific M&I Practices

This category refers to specific M&I practices for CC. SCE has shared its specific M&I practices which include prompts for data accuracy including types of CC and directions CC is installed, construction standard checks including any missing items such as dead-end covers, connector covers, fuse covers, lightning arrestors and covers, and pothead covers, and identifying abnormal conditions such as visible signs of tracking or damage on the outer jacket. Additionally, in 2023, PG&E updated their Detailed Ground Inspection checklist to include prompts for identifying failure modes that are unique to CC such as CC wire jacket cut into and bare conductor exposed, CC exposed and burnt, and dead-end cover misaligned on CC construction. While other utilities may not have tools that have these specific prompts, as part of their training, they look for visible signs of tracking and/or damage on the covering as well as discoloration. As noted above, the majority of M&I practices for bare conductor apply to CC. Because damage to the outer layer of CC may lead to faults/failures, this is an important inspection assessment all utility inspectors perform. Likewise, all utility inspectors are trained on their CC construction standards and thus assess conformance to the construction standard in the field. Most utilities do not collect asset information for data quality checks as some SCE prompts provide for; however, if deficiencies are noted during other utilities' inspections, they can be submitted through their processes. The utilities will assess these details in workshop settings to determine if best practices can be identified. Field observations may also be conducted to capture additional information.

Training

All utility inspectors are trained to understand CC construction standards and maintenance of CC through new inspector training, refresher training, ad hoc training and/or training conducted by the conductor manufacturer or through industry partners. The large utilities have similar types of training including new inspector training, refresher training, and ad hoc training for changes to standards, materials, etc. that may occur. The small utilities have few inspectors and typically are trained linemen with 20+ years' experience. These inspectors are trained on CC through industry organizations and/or the manufacturer as opposed to through a utility-developed training curriculum. For example, BVES has two inspectors that are trained linemen with over 20 years' experience. As such, developing a training curriculum for two inspectors may not be cost-effective when alternative training through the

manufacturer or industry partner is available. The utilities will continue to collect training information

and conduct a workshop to determine any best practices.

QA/QC

All utilities employ a quality assurance / quality check (QA/QC) process for asset inspections as well as construction of CC lines. For example, the large utilities will QA/QC CC as part of their QA/QC program, which are based on sampling methods. BVES and Liberty QA/QC all CC installations. Given the difference in size of utilities, it makes sense that the large utilities use QA/QC sampling methods whereas the small utilities QA/QC all new CC work. The utilities will further discuss and assess each utilities QA/QC practices related to CC in a workshop setting to determine if best practices can be identified.

Next Steps:

In 2023, the utilities will continue to capture general and specific CC M&I practices across the utilities and will conduct workshops to determine if best practices can be identified. Meetings will also be held to follow up on the workshops and set plans to implement any best practices that are identified. Below, the utilities provide a preliminary workshop schedule and themes.

Once the utilities finalize the workshop schedule, Energy Safety will be invited. Additional workshops may also be scheduled if needed. Should the workshops lead to best practices, the utilities will establish plans to implement the changes and document as part of lessons learned.

Estimated Effectiveness:

Overview:

As explained in the 2022 WMP Update report, each utility's CC programs are different due to factors such as location, terrain, and existing overhead facilities. The utilities also have different frequencies of risk drivers. Additionally, the utilities are still at different phases of installing CC as some have limited miles deployed while others have deployed thousands of miles of CC. These features, amongst others, result in data, calculations, and methods of estimating effectiveness that are different. As such, the utilities have been working on understanding differences and discussing methods for better consistency. In 2022, the utilities focused on testing, recorded effectiveness, and the new requirements. The utilities' continue to estimate CC effectiveness from approximately 60 to 90 percent at reducing outages/ignitions and/or the drivers of wildfire risk.

Below, the utilities describe any updates to their data, analyses, and methods used to estimate the effectiveness of CC to mitigate outages/ignitions and/or the drivers of wildfire risk and present their

estimated effectiveness values, and describe next steps to improve consistency of data, calculations and methods.

Covered Conductor Estimated Effectiveness:

SCE:

SCE’s Wildfire Covered Conductor Program (WCCP) consists of replacing bare conductor with CC, the installation fire-resistant poles (FRPs) where applicable, wildlife covers (animal safe construction), lighting arresters, and vibration dampers below 3,000 feet. Additionally, in 2022, SCE modified its CC construction standard to include the replacement of open wire secondary or weather-resistant aluminum (OWS or WAL) with multiplex secondary conductors. Weather resistant aluminum wire on the secondary system are outdated technology and will be updated to the new standard when WCCP is installed. Because this standard update will only affect WCCP installations starting in 2024, and not WCCP completed in 2022 or planned for 2023, This activity is not yet accounted for in determining the overall mitigation effectiveness of SCE’s WCCP.

In 2022, SCE assessed the Joint IOU testing results and mapped the test results to risk drivers and sub-drivers to determine if any changes were warranted. Results from the Wire Down Event Scenarios demonstrate that the bare portion of the conductor must be exposed to lead to an ignition. The System Strength Tests demonstrates that tangent structures will not significantly damage the conductor enough to expose the bare conductor. Tangent structures without equipment do not have any exposed bare conductor or taps (~50% of all structures are tangent). As a result, the current mitigation effectiveness of Vehicle Contacts did not account for the performance of CC on tangent structures, therefore SCE increased the mitigation effectiveness from 50% to 82%. SCE also evaluated phase-to-phase contact and simulated wire-down testing. CCs were 100% effective at preventing arcing and ignition in tested scenarios at rated voltage, consistent Exponent’s Phase I field reporting. Per the testing results, adjustments were also made for vegetation contact and unknown contacts. Below, SCE provides the updated estimated mitigation effectiveness for WCCP. Overall, the estimated mitigation effectiveness for WCCP increased from approximately 67% to 72%.

Table CC-12
SCE Covered Conductor Mitigation Effectiveness Estimate

Driver Type	Sub-Driver/ Consequence Type	% Drivers	Current Driver ME	New Drive ME	Directional Change	Indicative Test Result
D-CFO	Vegetation contact	12%	60%	71%	Increased	Wire Down Events + System Strength
D-CFO	Animal contact	13%	65%	65%	No Change	Wildlife cover test
D-CFO	Balloon contact	13%	99%	99%	No Change	
D-CFO	Vehicle contact	10%	50%	82%	Increased	Wire Down Events + System Strength
D-CFO	Unknown contact	8%	77%	80%	Increased	Aggregate of CFO Result
D-CFO	Other contact from object	3%	77%	77%	No Change	
D-WTW	Wire-to-wire contact / contamination	3%	99%	99%	No Change	
D-EFF	Conductor damage or failure	13%	90%	90%	No Change	Degraded covering
D-EFF	Connection device damage or failure	5%	90%	90%	No Change	
D-EFF	Connector damage or failure	5%	90%	90%	No Change	
D-EFF	Crossarm damage or failure	~0%	50%	50%	No Change	System Strength
D-EFF	Insulator and brushing damage or failure	4%	90%	90%	No Change	
D-EFF	Splice damage or failure	5%	90%	90%	No Change	

PG&E:

PG&E's overhead hardening program consists of primary and secondary CC replacement along with pole replacements, replacement of non-exempt equipment, replacement of overhead distribution line transformers, framing and animal protection upgrades, and vegetation clearing. PG&E understands the focus of this request to be centered on CC, however our efforts to estimate effectiveness include all elements of our Overhead Hardening program, which PG&E believes is more complete.

Determining whether a specific event could result in an ignition depends upon a wide variety of factors, including the nature of the event itself and prevailing environmental conditions (e.g., weather, ground moisture level, time of year). As PG&E does not have complete information to make this determination for each event, estimating overhead hardening effectiveness relies upon the following proxy to derive its estimates. Most distribution outages (momentary and sustained) typically involve a fault condition. Thus, for purposes of estimating overhead hardening effectiveness, it is assumed that all distribution outages could potentially result in an ignition, regardless of other prevailing conditions. This approach aligns with what has been previously stated in PG&E's 2020 WMP as well as its 2020 RAMP filing.

In early 2023, PG&E assessed the Joint IOU testing results to re-evaluate the SME effectiveness designations and adjusted the effectiveness in a few key areas. While this is expected to be an ongoing process, we have refreshed our effectiveness values based on updated designations and the data as follows:

Additionally, PG&E has refreshed our data for estimated effectiveness to include outage data through 2022. Previously, the last PG&E update including outage data was from PG&E's 2023 GRC filing, which had data through 2020.

With the above assumptions from the PG&E's 2020 WMP as well as our 2020 RAMP filing, PG&E updated the estimated effectiveness factor for overhead hardening in 2023, incorporating the 2023 re-evaluated SME effectiveness designations:

**Figure CC-9
PG&E Distribution Outage Database Record**

Circuit	182222102	District	Monterey
Type	Unplanned	Customer Minutes	
Customers	297	Weather	Overcast;32-90 F
Active	NO	Fault Type	Force Out
Interval	Sustained	Action Required	No
EquipID	7835	Construction Type	UG
Equipment Type	Fuse	OIS Outage#	927380, 927970, 927929, 927922, 927971, 927921
Equipment Condition	Transformer (UG), Deteriorated	Targets	
Crew Notified Time		Supervisor Notified	
Equipment Address			
Fault Location	AT T1288		
Previous Switching Details			
Action Description			
Cause	Equipment Failure/Involved, Underground	No Access Reason	
Multi Damage Location	No	# of Operations	
Counter Read		Created By	
Outage Level	Distribution Circuit	Last Updated By	
GPS MA Data		Latitude & Longitude	
Fault Location Info		FNL	
Reviewed By	Not Required	End Date	
Actions			

- **All** = Eliminates likelihood of a certain type of outage occurring resulting in an ignition
- **High** = Reduces likelihood significantly of a certain type of outage occurring resulting in an ignition
- **Medium** = Reduces likelihood moderately of a certain type of outage occurring resulting in an ignition
- **Low** = Reduces likelihood minimally of a certain type of outage occurring resulting in an ignition
- **None** = Will not affect the likelihood of a certain type of outage occurring resulting in an ignition

- **All** = 90%
- **High** = 70%
- **Medium** = 40%
- **Low** = 20%
- **None** = 0%

Table CC-13
PG&E Covered Conductor Mitigation Effectiveness Estimate

Driver	Average Yearly Count of Incident ID	Average of SH_Effect_Pct
Animal	429	75%
D-Line Equipment Failure	2233	69%
Environmental/External	255	42%
Third Party	397	57%
Vegetation	2735	62%
Grand Total	6049	64%

Based on the latest update using outage data through 2022 and repeating the process from PG&E's 2020 WMP filing, the updated estimated effectiveness is 64% where Overhead Hardening has been completed. Therefore, a section of a line that has been hardened is approximately 64% less likely to have an outage of any type. Similarly, a section of a line that has been hardened is approximately 64% less likely to have an outage of each of the drivers. This result is consistent with the previous results that were completed using data for the 2020 WMP.

SDG&E:

SDG&E initially began to examine CC from a personnel safety and reliability standpoint. The three-layered construction showed prospective reduction of injuries to people in the event of an energized wire-down in which the wire contacted a person and/or also might reduce the step potential to people in the vicinity. Outages that result from light momentary contacts (i.e. mylar balloons, birds, palm fronds) also have shown the potential to be reduced. In late 2018, focus was shifted towards using CC as an alternative to SDG&E's traditional overhead hardening program with the primary focus of reducing utility-caused ignitions.

SME's conducted research on the history and use of CC in the industry. Additionally, the SMEs reached out to utilities on the East Coast and internationally to receive their feedback of the effectiveness and work methods for installation purposes.

In addition to other studies/tests that have been and will be performed by SCE and PG&E, as described in the Testing section, SDG&E will have a third-party evaluate the likelihood and effect specific to conductors clashing at various wind speeds. Accelerated aging studies will also be performed to mimic a 40-year service life; after which, the samples will be subjected to tests designed to understand the potential for both mechanical degradation, as well as reduction in dielectric strength. These tests will be performed in accordance with ASTM or other industry recognized standards. Final reports for this testing are expected to be completed in April 2023.

In order to quantify the risk reduction of wildfires that would be achieved by CC, SDG&E evaluated 80 events that resulted in ignitions. SME's weighed in on the likelihood that CC installation would prevent an ignition for the particular type of outage depending on the severity of the incident. As seen in Table X

below, the result is a reduction in ignitions from 60 to 20.6, and a resulting effectiveness estimate of 65.7%.

In 2022, SDG&E has been participating in collaborating with other utilities as part of the Joint IOU working groups in the evaluation of the testing that has been and is currently still being performed. Once all testing has been completed in 2023, SDG&E will perform an analysis based on risk drivers to re-evaluate the estimated efficacy of CC.

Table CC-14
SDG&E Covered Conductor Mitigation Effectiveness Estimate

Fault/Ignition Cause	Number of Ignitions	SME Effectiveness	Post-Mitigation Ignitions
Animal contact	7	90%	0.7
Balloon contact	9	90%	0.9
Vegetation contact	2	90%	0.2
Vehicle contact	8	20%	6.4
Other contact	3	10%	2.7
Other	4	10%	3.6
Equipment - All	26	80%	5.2
Unknown	1	10%	0.9
Total	60	65.7%	20.6

The table above was updated with the number of ignitions occurring between 2017-2021 compared to last year’s report that was based on 2016-2020 data. Updates to SDG&E’s overall effectiveness methodology are anticipated to be completed by December 2023.

PacifiCorp:

Prior to development of the WMP, PacifiCorp historically pursued CC designs and systems due to historical experience with elevated outage count from trees, limbs, and incidental contact (resulting in grow in) throughout its service area. Additionally, access conditions on some of its circuits are extremely difficult in certain times of the year, and those circuits also tend to have elevated outage rates. For the above-mentioned reasons, when siting its historic CC pilot projects, PacifiCorp tended to focus its deployment on circuit-segments that had above average vegetation and/or animal outage rates in conjunction with difficult access. Now, as part of the company’s line rebuild program to install CC and mitigate wildfire risk, PacifiCorp is actively pursuing both CC and spacer cable systems. Most projects

completed so far as part this program have leveraged a spacer cable system, which primarily includes CC, a structural member (messenger), and specialized attachment brackets. Therefore, the effectiveness examples and estimations were determined for spacer cable.

As an example of how to assess the effectiveness of newly installed spacer cable, PacifiCorp compared two circuits, one with bare wire and one with spacer cable installed. Both circuits are in the same general geographic area and shown in Figure CC-10 below. Additionally, the circuits are in a HFTD, with the spacer cable partially located in a tier 3 area near Mt. Shasta and the bare conductor located completely within a tier 2 area, though it is still located within a few miles of the tier 3 boundary.

Figure CC-10
PacifiCorp Map Showing the Two Circuits Plotted with the HFTD Overlay

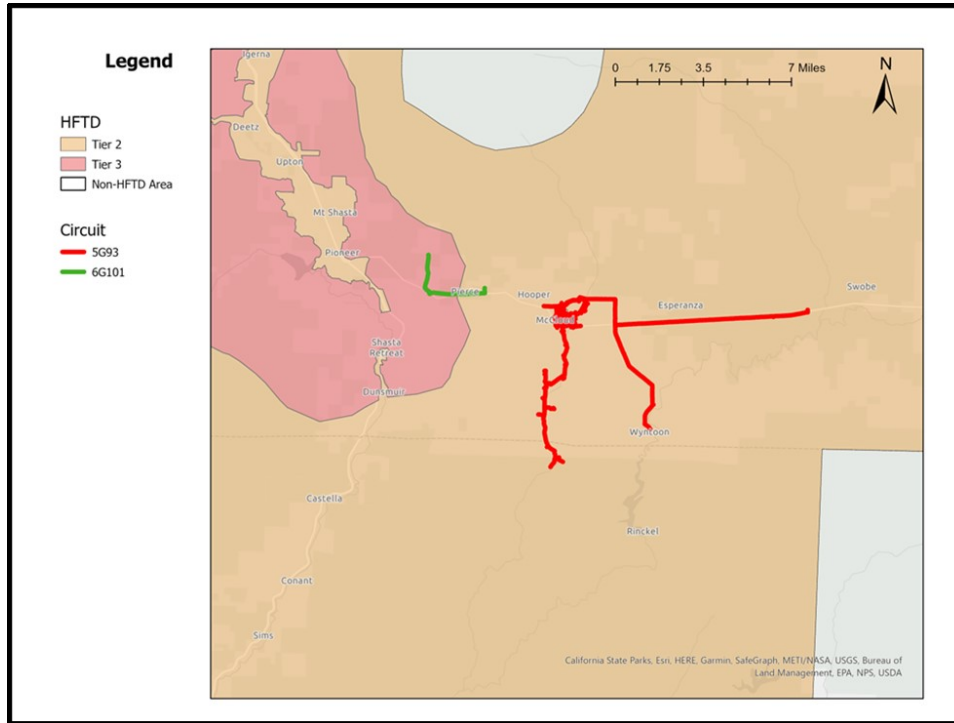

To begin characterizing outage frequency variation prior to and after the installation of spacer cable, 18 years of outage data (2005-present) for both circuits was reviewed and is summarized in Table CC-15, below.

Table CC-15
PacifiCorp Outage Frequency for Bare Wire and Spacer Cable Circuits (2005 – present; Asterisk (*) indicates the year spacer cable was installed)

Year:	Outages - Bare Wire Circuit:	Outages - Spacer Cable Circuit (Q4 2021):
2005	8	0
2006	6	2
2007	2	2
2008	10	10
2009	0	0
2010	6	12
2011	42	18
2012	6	4
2013	10	2
2014	2	0

2015	2	2
2016	2	2
2017	2	4
2018	0	0
2019	4	2
2020	4	0
2021	2	4 *
2022	8	0
2023	4	0

Generally, the data demonstrates that outage frequency can significantly vary year over year. Additionally, in this example, the bare wire circuit has historically experienced either an equivalent or higher frequency of outages than the circuit the spacer cable was installed, except in 2010. While many factors can impact outages and reliability, this general trend is expected given the significant differences in circuit length. This same data was then normalized based on circuit mile and summarized in Table X below.

In both tables, the data generally shows that for the spacer cable installation (completed in Q4 2021), there was a reduction in outages in all years following the rebuild project (0 for 2022 and 2023 so far). Additionally, the nearby bare wire circuit experienced a total of 12 outage events in 2022 and 2023 (as of January 2023). While certainly not conclusive or representative of a clear trend, the data does support that potential impact spacer cable can have on outage frequency.

A further analysis into outage causes for each circuit at the time of spacer cable installation was performed and included in Table CC-16 below. The table shows the spacer cable experienced 0 outages in 2022 and 2023 (as of January 2023) for all risk drivers. However, for the bare wire circuit, there was a total of 12 outages across all risk drivers, with trees being the main driver in 2022.

Table CC-16
PacifiCorp Risk Drivers for Bare Wire and Spacer Cable Circuits (2021 – present; Asterisk (*) indicates the year spacer cable was installed)

Year:	Risk Drivers:	Bare Wire Circuit:	Spacer Cable Circuit (Q4 2021):
2021	TREES	2	0 *
2021	LOSS OF SUPPLY	0	4 *
2022	TREES	4	0
2022	INTERFERENCE	2	0
2022	PLANNED	2	0
2023	TREES	2	0
2023	WEATHER	2	0

While promising, this analysis is neither conclusive nor representative of a clear trend. Additionally, this individual analysis may not be representative of macro trends. The circuit that has the spacer cable is

installed on only 6.1 miles which serves only 12 customers and has been in place since Q4 2021. Furthermore, PacifiCorp believes that determining the long-term effectiveness of CC, both in its ability to reduce wildfire risk and PSPS impacts, requires additional data and time. At a minimum, a longer history of outage data would be necessary to fully understand the impacts of the spacer cable.

BVES

BVES has approximately 211 circuit miles of overhead conductor between 34.5 kV and 4.16 kV in its system. BVES started a CC pilot program in Q2 2018 and completed it in Q3 2019 using two different types of cover conductor wires (394.5 AAAC Priority wire and 336.4 ACSR Southwire). Then BVES started the cover conductor WMP in late 2019 with a plan to cover 4.3 circuit miles on 34.5kV over the next 5 years and 8.6 circuit miles on 4.16 kV over the next 10 years. As of the end of Dec. 2021, BVES has covered approximately 21.1 miles between its 34 kV and 4 kV systems. BVES’ average span length is approximately 150 feet and installing CC on cross arms. As part of its CC program when there are spliced locations, BVES installs premade cold shrink kits (3M) and installs avian protection (raptor protection/wildlife guard).

Based on benchmarking with other utilities’ estimated effectiveness against ignition risks, discussions with its CC supplier, and the short amount of time that it has installed CC, BVES continues to believe that the estimate of effectiveness on ignition risk drivers in its service area is approximately 90%. As BVES installs more CC and gathers more historical data, it will continue to assess the estimate of effectiveness. BVES presents its estimated effectiveness in Table CC-17 below.

**Table CC-17
BVES Covered Conductor Mitigation Effectiveness Estimate**

Ignition Risk Driver	Percent Reduction	Discussion (Contacts on Cover Conductor cable)
Vegetation Contact	90% +	Vegetation contact on 1, 2, 3 phase and/or neutral wire.
Animal Contact	90% +	Animal contact on 1, 2, 3 phase and/or neutral wire.
Balloon Contact	90% +	Balloon contact on 1, 2, 3 phase and/or neutral wire.
Wire down contact	90% +	Due to the following: tree/tree limb fallen on line, car hit pole, wind gust, etc.
Vehicle Contact	90% +	Vehicle Contact due to wire down on vehicle.
Wire to Wire Contact	90% +	Due to the wind gust forces causing tree/tree limb fall on line or just wire to wire contact.

Splice location contact	90% +	BVES installs Avian protection/raptor protection/wildlife guards and uses premade cold shrink kits (3M) on splice locations.
Vandalism/Theft	90% +	In BVES' service area there is a low risk of conductor theft as well as vandalism. If vandalism occurs, Ex. damage from "gunshot" to the conductor covering installed.
Lightning Contact	90% +	During raining seasons, sometimes encounter a good amount of lightning strikes in BVES' service area. BVES using priority covered conductor (flame resistant) cable.
Third Party	90% +	Third party including contact from joint use, boom arms, etc. should be mostly mitigated with covered conductor cable.
Flame Propagation along the covered conductor	90% +	Caused by Lightning or other.
Flame particle dripping	90% +	Caused by Lightning or other.

Liberty

The CC mitigation estimated effectiveness values for the various ignition risk drivers in 2023 remain unchanged from values in Liberty's 2022 WMP report update. The estimated effectiveness ranges from 95% for vegetation contact risk driver to 15% for lightning risk driver.

Next Steps:

As detailed above, the utilities estimate the effectiveness of CC between approximately 60 and 90 percent. In 2023, the utilities will continue to meet on a regular basis to discuss estimated effectiveness methods, data and calculations. The utilities will learn from the testing, and recorded results and collaborate to improve each utilities' understanding and approach to estimate effectiveness. The utilities will also discuss opportunities to align data and methods for greater comparability and will document any lessons learned.

PSPS:

Introduction:

In the 2022 WMP Update report, the utilities described their general PSPS approach and how a CC system can reduce PSPS impacts, and provided an assessment of alternatives and their ability to reduce PSPS impacts compared to CC. As described in the 2022 WMP Update report, only SCE has increased PSPS thresholds for fully-isolatable circuit-segments that are covered in comparison to bare conductor. Other utilities, such as SDG&E, informed that circuits with CC could likely withstand higher wind speed tolerances; however, more real-world experience and studies would be required prior to increasing PSPS thresholds. As SDG&E completes construction and obtains this data, it will inform wind-speed tolerances

for PSPS. Below, the utilities describe its efforts to better understand the ability of CC and alternatives to reduce the impacts of PSPS as well as plans for 2023 to further this effort.

Summary:

In 2022, the utilities continued to meet and discuss CC and its ability to reduce the impact of PSPS. No utility made changes, per descriptions in last year's report, to their general PSPS practices and thresholds in 2022. The utilities did discuss studies being considered to further assess CC and other mitigations in their ability to reduce the impact of PSPS. Additionally, the utilities have recently discussed the testing results in relation to reducing the impact of PSPS. For example, SCE described how the testing results can provide boundary conditions/limits that enable more granular analysis. While other data such as improved understanding of local hazards are needed to fully inform of potential changes to PSPS thresholds, the testing results can help enable analyses that could provide additional benefits like changes in PSPS de-energization thresholds. SCE and SDG&E will be conducting studies to investigate different aspects and conditions of CC and local conditions to further inform potential changes to PSPS de-energization thresholds. Additionally, and as identified in the Testing workstream, the utilities will discuss the results of the testing in relation to PSPS de-energization thresholds in the testing workshops.

Next Steps:

In 2023, the utilities will assess new technologies in their ability to reduce PSPS impacts as part of the New Technology workstream. Additionally, the utilities will discuss the testing results to further inform PSPS de-energization thresholds as part of the testing workshops. The utilities will also regularly meet to assess the status of related studies and discuss any changes to PSPS practices. If changes to PSPS de-energization thresholds are made and/or to general PSPS practices, the utilities will document any lessons learned.

Benchmarking:

In 2021, the utilities benchmarked with utilities around the world to improve its understanding of CC deployment and applications. A survey was sent to over 150 utilities around the globe. In total, 19 utilities participated in the benchmarking survey. The survey consisted of 24 questions that focused on CC usage, performance metrics, conductor applications, and system protection. While a limited number of utilities responded (compared to the outreach), the benchmarking survey provided helpful information on CC deployment and performance metrics. This information supported the utilities understanding of the benefits of CC including reliability and safety improvements and wildfire risk reduction. The utilities did not conduct additional benchmarking outside of this joint IOU effort in 2022. In 2023, the utilities will develop a new survey that accounts for results from the testing workstream, learnings from the M&I best practices and new technologies workstreams, and other information that becomes available. The utilities will deploy a new survey in Q3/Q4 2023. Based on the results of the survey and the collaboration and learnings from the other workstreams, the utilities will look to continue to benchmark over this WMP period.

Costs:

Introduction:

In the 2022 WMP Update filings, the utilities presented an initial capital cost per circuit mile comparison of installation of CC and described the types of costs incurred, cost accounting methods, and the factors

that can drive CC costs higher or lower. The utilities demonstrated that based on each utilities' CC / system hardening program, costs are relatively comparable taking into account each utilities' resources, scope, and operational constraints. Since the 2022 WMP Update, the utilities have continued to meet and discuss CC unit costs and undergrounding unit costs. Below, the utilities provide an updated CC capital cost per circuit mile, initial undergrounding unit costs, and plans for 2023.

Updated Covered Conductor Capital Cost Per Circuit Mile:

The utilities have prepared an updated capital cost per circuit mile comparison of the installation of CC. To construct this unit cost comparison, the utilities used the same six cost categories presented in the 2022 WMP Update filings including labor, material, contract, overhead, other, and financing.³¹⁹ These cost categories are intended to capture the total capital cost per circuit mile of CC installations. For purposes of this report, the utilities obtained recorded and/or estimated costs for construction that occurred during 2022. Table CC-18, below, shows the current CC capital unit cost per circuit mile comparison across the six utilities.

Table CC-18
IOU Comparison of Covered Conductor Capital Costs Per Circuit Mile

Cost Components	SCE		PG&E		SDG&E		Liberty		PacifiCorp		BVES	
	Cost per Circuit Mile	%	Cost per Circuit Mile	%	Cost per Circuit Mile	%	Cost per Circuit Mile	%	Cost per Circuit Mile	%	Cost per Circuit Mile	%
Labor (Internal)	\$ 9,000	1%	\$ 130,000	16%	\$ 321,000	22%	\$ 117,000	10%	\$ 18,000	2%	\$ 18,000	2%
Materials	\$ 132,000	19%	\$ 151,000	18%	\$ 84,000	6%	\$ 73,000	6%	\$ 218,000	28%	\$ 360,000	49%
Contractor	\$ 383,000	56%	\$ 394,000	48%	\$ 303,000	21%	\$ 857,000	70%	\$ 446,000	57%	\$ 300,000	41%
Overhead (division, corporate, etc.)	\$ 141,000	20%	\$ 140,000	17%	\$ 355,000	24%	\$ 163,000	13%	\$ 50,000	6%	\$ 60,000	8%
Other	\$ 14,000	2%	\$ 3,000	0%	\$ 317,000	22%		0%	\$ 25,000	3%		0%
Financing Costs	\$ 9,000	1%	\$ 8,000	1%	\$ 71,000	5%	\$ 10,000	1%	\$ 21,000	3%		0%
2022 Total	\$ 688,000	100%	\$ 826,000	100%	\$1,451,000	100%	\$ 1,220,000	100%	\$ 777,000	100%	\$ 738,000	100%

As illustrated in Table CC-18, the 2022 CC capital cost per circuit mile ranges from approximately \$688 thousand to approximately \$1.45 million. While not a true comparison, because the figures are in nominal dollars, the 2022 unit cost range is similar to the 2021 unit cost range of approximately \$565 thousand to approximately \$1.5 million. As discussed in the 2022 WMP Update report, the capital cost per circuit mile for CC can vary due to multiple factors such as type of CC system and components installed, terrain, access limitations, permitting, environmental requirements and restrictions, construction method (e.g., helicopter use), amount of poles/equipment replaced, degree of site

³¹⁹ Labor represents internal utility resources, such as field crews, that charge directly to a project work order. Materials include conductor, poles, etc. that get installed as part of a project. Contract represents all contractors, such as field crews and planners, and consultants utilities use as part of their CC programs. Overhead represents costs, such as engineers, project managers and administrative and general, that get allocated to project work orders. Other represents costs such as land fees, permit fees and costs not assignable to the other categories. Financing represents allowance for funds used during construction (AFUDC) which is the estimated cost of debt and equity funds that finance utility plant construction and is accrued as a carrying charge to work orders.

clearance and vegetation management needed, and economies of scale. Below, the utilities describe any changes to their cost make-up and the factors that contribute to the cost changes from 2021.

Initial Undergrounding Capital Cost Per Circuit Mile:

PG&E, SCE and SDG&E have prepared an initial capital cost per circuit mile comparison of the conversion of overhead conductor to underground. Liberty and BVES are not installing undergrounding as part of their wildfire mitigations. PacifiCorp has only installed one half of a mile so does not have sufficient recorded data to add; however, PacifiCorp is installing undergrounding projects over this WMP period and thus unit cost data will be assembled once more undergrounding is installed. Similar to the construction of the CC unit cost comparison, the utilities organized their capital costs (and/or estimates) into the same six cost categories. These cost categories are intended to capture the total capital cost per circuit mile of undergrounding. For purposes of this report, the utilities obtained recorded and/or estimated costs for construction that occurred during 2022. Table CC-19, below, shows the initial undergrounding capital unit cost per circuit mile comparison across the three large utilities.

Table CC-19
SCE, PG&E and SDG&E Comparison of Undergrounding Capital Costs Per Circuit Mile

Cost Components	SCE		PG&E		SDG&E	
	Cost per Circuit Mile	%	Cost per Circuit Mile	%	Cost per Circuit Mile	%
Labor (Internal)	\$ 25,000	1%	\$ 231,000	9%	\$ 45,000	2%
Materials	\$ 417,000	19%	\$ 271,000	11%	\$ 165,000	7%
Contractor	\$ 1,201,000	56%	\$ 1,665,000	66%	\$ 1,754,000	71%
Overhead (division, corporate, etc.)	\$ 438,000	20%	\$ 247,000	10%	\$ 417,839	17%
Other	\$ 35,000	2%	\$ 63,000	3%	\$ 14,654	1%
Financing Costs	\$ 29,000	1%	\$ 31,000	1%	\$ 77,756	3%
Total	\$ 2,145,000	100%	\$ 2,508,000	100%	\$ 2,474,739	100%

As illustrated in Table CC-19, the 2022 undergrounding capital cost per circuit mile ranges from approximately \$2.03 million to approximately \$2.51 million. The capital cost per circuit mile for undergrounding across the three utilities is remarkably consistent given that undergrounding costs typically have a much larger cost range than CC. Similar to CC, undergrounding costs vary due to multiple factors such as type of undergrounding system and conductor, terrain, access limitations, route changes, permitting, environmental requirements and restrictions, construction methods, and economies of scale. Below, SCE, SDG&E and PG&E describe the make-up of their undergrounding capital costs and the factors that contribute to the cost differences.

SCE

CC Unit Cost Make Up:

The 2022 CC costs are based on work completed in 2022. Some projects completed in 2022 have incurred costs from prior years. SCE's unit cost is based on the average cost of nine different regions within SCE's service area. SCE's unit costs are typically presented as direct costs only (exclude corporate overheads and financing costs). For purposes of this report, SCE has added corporate overheads (to the overhead cost category) and financing costs to its direct unit cost for comparison with the other utilities. SCE continues to use two CC designs, a 17 kV and 35 kV CC with multiple ACSR and copper conductor sizes.

In 2022, SCE did make a change to its WCCP construction standard by adding the replacement of open wire secondary or weather-resistant aluminum (OWS or WAL) with multiplex secondary conductors; however, this change is not anticipated to show up in the unit costs until 2024. No CC projects completed in 2022 included replacement of secondaries. SCE estimates, on average, replacing secondaries will cost approximately \$60 thousand per circuit mile.

CC 2022 Cost Changes:

Using the nominal amounts of the 2021 and 2022 unit costs, SCE experienced an approximate 16% increase. The primary drivers of this increase include a combination of a larger percentage of work in the Rural region, e.g., the Arrowhead District, and contractor rate increases. Work in higher elevations in rugged areas tend to take longer, increasing contract labor costs. This increase coupled with higher contractor rates were the main cost drivers. Additionally, SCE experienced material and supply price increases. Also, in 2022, SCE began to use SCE labor in some regions.

Undergrounding Cost Make up:

The 2022 undergrounding costs are based on work completed in 2022. Projects completed in 2022 have incurred costs from prior years. SCE's unit cost is based on approximately 14 miles of undergrounding. The 14 miles of undergrounding had a low level of difficulty and did not include secondaries or services. A low difficulty level means the terrain was relatively flat, there was less civil construction due to existing infrastructure, and there were none to minimal re-routing required. SCE anticipates higher costs in future unit cost assessments because the projects will have a mix of low to high difficulty.

Undergrounding Cost Drivers:

For undergrounding projects, SCE leverages its Integrated Wildfire Mitigation Strategy consequence model, which defines the most severe locations in SCE's HFRA. These are locations that meet one or more of the following characteristics: 1) egress constrained, 2) burn-in buffer, 3) 10,000+ acres burned at 8 hours, 4) extreme high wind areas, and 5) communities of elevated fire concern. The costs to underground in these areas can vary significantly. Below, SCE describes several cost drivers that could lead to increased costs.

Construction – in various types of terrain, geography, topography, and population density. Different levels of difficulty in construction can significantly impact the costs. For example, a low difficulty level project that includes straight/minimal bends and minimal re-routing will likely be a lower cost compared to a high difficulty level project, which can have rocky, hilly terrain requiring significant re-routing.

Additionally, any unanticipated changes in design after release can impact costs. For example, sometimes, during construction, a trench is not able to be constructed due to other infrastructure already there (an outcome of outdated basemaps). In this type of circumstance, the planning department would re-design the route including seeking agency feedback which would take additional time to complete and impact schedule and costs.

Permitting and environmental clearances – acquiring permits, resolving land rights and agency requirements, and curing cultural discoveries can be a lengthy process. The number of permits, the types of permits, the amount of land right issues that need to be resolved, and the types of cultural discoveries can increase the costs of a project.

Labor type and resource availability – Both civil crews and QEW electrical crews are required and using internal SCE labor versus contract labor may impact costs.

Additionally, delays can occur due to weather (e.g., rain/snow, RFW days, etc.), supply chain constraints, permit requirements, and environmental constraints (e.g., nesting birds), which can also increase costs.

PG&E

CC Unit Cost Make Up:

PG&E's unit cost analysis is based on completed projects. Projects are defined by circuit and span. Costs are recorded using SAP software. Of the 335 miles used to analyze the unit cost, these were projects that were marked completed in 2022. Some of the mileage may have been constructed in previous years. Five of the miles were fire rebuild, which typically have a lower unit cost. 329 miles completed were regular system hardening work and one mile was classified as other.

Costs were organized per the six main categories agreed upon with the other utilities. 200 miles were constructed using external crews, categorized as Contract and 135 miles were constructed using Internal labor, categorized as Labor.

PG&E's Overhead Hardening (CC Installation) scope achieves risk reduction through these foundational elements: bare primary and secondary conductor replacement with covered equivalent, pole replacements, non-exempt equipment replacement, overhead distribution line transformer replacement, framing (composite crossarms and insulators) and animal protection, and vegetation clearing.

CC Cost Drivers:

PG&E's CC installation costs are driven by these key contributors:

CC Cost and Impact Driver changes for 2022:

For PG&E, unit costs have steadily decreased for the Overhead System Hardening program, that includes CC, into 2022. Major cost drivers include a decreased volume of vegetation impacts on overhead hardened lines and unit cost RFPs (request for proposals) to stabilize contract pricing.

It is likely that these unit costs have mostly leveled off and will only increase due to inflation and economic pressures as this program continues.

Continued costs for PG&E are labor costs, both internal and external (contractor) costs.

For impact drivers to CCs, PG&E is continuing to utilize a combination of undergrounding and microgrids as the primary system hardening effort to reduce wildfire risks. Where these efforts are less feasible,

PG&E may use CC as a wildfire mitigation tool for Overhead System Hardening. As PG&E continues undergrounding efforts and finds additional areas that are prohibitive to the undergrounding program, PG&E may increase CC use for those specific areas.

Undergrounding Cost Make up:

PG&E's unit cost analysis is based on completed projects with costs recorded in our SAP software. Of the 76 miles used to analyze the unit cost, these were projects that were marked completed in 2022. Some of the mileage may have been constructed in previous years, 46 of the miles were fire rebuild, which typically have a lower unit cost, and 30 miles completed were regular system hardening work.

Costs were organized per the six main categories agreed upon with the other utilities, 53 miles were constructed using external crews, categorized as Contract, and 23 miles were constructed using internal labor, categorized as Labor.

Undergrounding Cost Drivers:

In executing the System Hardening program, PG&E first uses a scoping criterion that identifies the highest risk areas, and then selects the appropriate risk mitigation approach for that circuit which may include undergrounding, remote grid installation, line removal, or overhead hardening (depending on the local circumstances). Since late 2021, PG&E has prioritized undergrounding as the preferred approach to reduce the most system risk. Once a circuit is selected for undergrounding, PG&E evaluates each proposed circuit segment quantitatively and qualitatively to mitigate the maximum amount of risk and evaluate feasibility and executability. Potential cost drivers can include:

Any of the above considerations may create delays or complexities that can impact the scope, cost, and schedule of undergrounding projects.

Furthermore, undergrounding projects are executed in multiple stages once the circuit segment has been identified based on the criterion described above for undergrounding:

As projects move through each stage, schedule certainty improves. Project schedules can change at any time from project dependencies, which may cause specific projects to move across years. Generally, if a project is not completed during the year that it was originally targeted for completion, it will continue through all the job phases and be completed in a subsequent year.

PG&E works closely with customers, governments, agencies, tribes, and regulatory officials to manage these issues within the program to minimize delays and optimize the efficiency of projects wherever possible.

SDG&E

CC Cost Make Up:

Each project goes through a six-stage gate process as follows:

Stage 1 – Project Initiation (duration ~1-3 months)

Stage 2 – Preliminary Engineering & Design (duration ~6-9 months)

Stage 3 – Final Design (duration ~3-5 months)

Stage 4 – Pre-Construction (duration ~1-2 months)

Stage 5 – Construction (duration ~3-4 months)

Stage 6 – Close Out (duration ~6-12 months)

The total duration of a project has an estimated duration of approximately 20 to 35 months.

SDG&E's CC per mile unit capital costs is made up of the following six major cost categories:

CC Cost Drivers Update:

Costs can vary significantly from project to project for a variety of reasons, including engineering and design, land rights, environmental, permitting, materials, and construction. Below is a description of these factors and why the costs can vary from project-to-project.

Engineering & Design:

SDG&E collects LiDAR (Light Imaging Data and Ranging) survey data before the start of design and again after construction is completed. During the LiDAR data capture, other data including photos (i.e., ortho-rectified images of the poles and surrounding area, and oblique pole photos), and weather data is acquired. After collection of the raw LiDAR and Imagery data, it is processed to SDG&E's specification and includes feature coding and thinning of the LiDAR data, and selection and processing of the imagery data. The entire process for delivery to SDG&E's specification can take weeks to months depending on the size of the data capture. This LiDAR data capture is used to support the base-mapping, engineering, and design processes (Stage 1 and Stage 6).

Currently, the engineering and design of all CC projects are conducted by engineering and design consultants, and their deliverables are reviewed by a separate Owner's Engineering (OE) consultant to ensure compliance with SDG&E standards and guidelines. At this time, SDG&E does not have the resources to conduct the engineering and design required at this scale of work; however, there are assigned SDG&E full time engineering staff that provide oversight of all engineering and design consultants, including the OE. The engineering component of work relates to the structural analysis,

including Power Line Systems – Computer Aided Drafting and Design (PLS-CADD) modeling, foundation calculations, or geotechnical studies. The design component includes the drafting, entering design units into SAP for material ordering and costing system, and building the job packages that are sent to construction. In some cases, one consultant can perform both the engineering and design function, and in others cases an engineering consultant collaborates with a design consultant. In all cases, SDG&E's Owner's Engineer will perform both engineering and design review support. Costs from consultants can vary depending on the size and complexity of the project, and due to various other factors including environmental constraints, land constraints, permitting requirements, or scoping changes that can occur from the start of design and throughout construction. The design stage (i.e., start of design to issuance of job package to construction) typically takes anywhere from six months to two years depending on the size and complexity of the project and the challenges with acquisition of land rights, environmental release, and/or permits. In some cases, our environmental releases cannot be released until we receive the permit from the agency as they may require additional environmental measure to be placed on the work and will need to be outlined in the environmental release.

SDG&E requires every pole be engineered using PLS-CADD software during the design phase and the post-construction phase. This software allows SDG&E to leverage LiDAR survey data (pre- and post-construction) and AutoCAD drawings, and to design the poles, wire, and anchors to meet General Order (GO) 95 Loading (Light and Heavy Loading) and Clearance Requirements, as well as to meet Known Local Wind requirements (e.g., 85 mph and in some cases 111 mph wind). SDG&E also requires its engineering and design contractors who use PLS-CADD software to have a California-registered Professional Engineer review and approve the final PLS-CADD model.

Land and Environmental:

SDG&E requires all projects to go through a land and environmental review process at each stage of the design process. These processes are predominantly supported with the help of land management and environmental service consultants but are overseen by SDG&E representatives in each respective department. The land process includes research of our land rights, interpretation, and may include support obtaining the proper land rights when required. Through the land rights design review process, SDG&E determines the land ownership of facilities (e.g., poles and wire) to determine if the scope of work is will stay within existing land rights or if new/amendment land rights would be necessary. These results are shared with the engineering, design, and environmental teams. Once the land rights are determined, environmental performs an assessment, determines the environmental impacts if any, and provides input to the design process to minimize and/or avoid environmental impacts. These land and environmental reviews can drive changes to the design and add time and cost to the project. For example, in many cases, SDG&E does not have the land rights to build the overhead CC design within its existing easement, or in some cases it only has prescriptive rights. In those cases, SDG&E has to amend or acquire the proper land rights, or redesign the project, if possible, to stay within the land and/or environmental constraints. If acquiring or amending land rights is required, this can take weeks to months depending on the property owner (e.g., private, BIA, State, Federal, or Municipality) and the level of change to the existing conditions.

Materials:

SDG&E's philosophy with CC, like SCE, is to install it in an open-crossarm configuration. In this configuration, the conductor is self-supporting and attached to insulators on crossarms at the structure.

Where connections are necessary, insulation piercing connectors (IPCs) are used to avoid stripping the wire and causing damage to the conductor and negating the need to wrap the connection with insulating tape. SDG&E also requires the use of vibration dampers, where necessary, to mitigate conductor damage due to Aeolian vibration. SDG&E replaces most wood poles to steel, and in some cases replaces existing steel poles if they are not adequate to support the new wire (e.g., inadequate clearance and/or mechanical loading capacity). In many cases equipment is replaced during these reconductor projects if it is older, is showing signs of failure, and/or needs to be brought up to current standards. The reason to replace wood poles with steel is due to several reasons, including the fact steel is more resilient to fires than wood and is seen as a defensive measure, steel is a man-made material and the strength and dimensions are consistent and have much smaller tolerances than wood, and because many of SDG&E's wood poles are over 50 years old. In some cases, SDG&E may also need to relocate the pole line to an area where it is more accessible to build and maintain but will require obtaining a new easement. SDG&E also replaces wood crossarms with fiberglass crossarms, insulators with polymer insulators, and replaces switches and regulators as necessary. For transformers, SDG&E developed specific criteria for replacement. A transformer will be replaced if it is internally-fused regardless of age, if it's greater than 7 years old, if it has visual defects or damage (leaks, burns, corrosion, etc.), is less than 25 kVA, or if the transformer does not pass volt-drop-flicker calculation. SDG&E also replaces secondary wire that is either open (non-insulated) or "grey wire" (covered secondary wire where the insulation is grey in color). On most projects, there is a smaller underground job associated with the overhead work. This typically occurs when a pole feeds underground (aka a Cable or Riser Pole) and the new pole location may be too far from the existing position such that the existing cable, conduit, and terminations may not reach the new pole position. In these cases, a small underground job will be initiated to have the crews intercept the run of underground conduit, install a new handhole, install a new run of conduit and cable to the new pole location, and splice the cable in the new handhole to make the connection to the existing underground system.

In 2021 and 2022, SDG&E experienced material supply chain issues, with CC materials as well as materials common to bare and CC. These supply chain issues were the result of various factors including impacts from COVID-19. In the case of CC, SDG&E currently sources the conductor from multiple suppliers; however, the associated materials such as piercing connectors and clamp dead-ends come from one supplier out of Europe and experienced significant delivery delays due to COVID-19 and issues with US Customs paperwork in 2021. In 2022 SDG&E had material delays with secondary conductor, 10 ft fiberglass guy strain insulators, transformers, guy grips, and fiberglass crossarms. SDG&E also experienced delays receiving other material due to COVID-19 supply chain disruptions and competition for the same materials used by other utilities including transformers and other materials common to various utilities across the country. Material delays can cause construction delays or cause construction to work less efficiently, thus impacting project schedules and costs. To mitigate material delays SDG&E's engineering and design team, as well as suppliers, work together to provide long term forecasting and ensures materials are ordered with enough lead time to receive the materials in time for construction, and when necessary, substituting material.

Construction:

One of the most significant variables, and most difficult to predict, is the civil portion of construction. The civil portion of a project includes the pole hole, anchor, and handhole digging and can vary significantly depending on several factors including accessibility (truck accessible versus non-truck

accessible), soil conditions (rock versus soft soil), methods of digging (hand tools versus machine), and environmental constraints that may limit the method of digging or access protocols. For example, a 0.7 miles project completed a couple of years ago was on the side of a steep mountain side and all the material, equipment (pneumatic drill and hand tools), and crews had to be flown in and out every day for months. The civil crews encountered significant rock at most locations and the spoils from the digging had to be flown out due via helicopter to environmental concerns rather than spreading the spoils on location. Each pole and anchor were back-filled with concrete using helicopters because of the slope of the mountain and due to the significant mechanical loading due to winter storms (wind and ice loading). In contrast to this mountain side project example, SDG&E has had other projects that are truck accessible, that do not require concrete backfill and allow the spoils to be spread out on location.

Another reason costs can vary significantly from project to project is due to the time of year and location. SDG&E often deals with elevated fire weather conditions which requires a dedicated fire watch crew to be present at each location where there is work happening that can pose a fire risk. In some cases, SDG&E has multiple dedicated fire watch crews on a project as there may be multiple civil and electric crews working at different locations at the same time on the same project. Some locations are also so remote that the drive time from the staging yard to the site can take a significant amount of time out of each workday that the crew may work longer hours and/or over the weekend, including Sundays, thus increasing overtime hours for the construction crew and all other support services (e.g., traffic control, environmental monitors, etc.). In some cases, generators are used due to the remote nature of some customers and the lack of ties with other circuits in SDG&E's service area. Generators require special protection schemes, equipment, and resources to adequately plan, deploy, setup, monitor, and tear-down which increase the installation costs.

Lastly, construction costs can vary depending on the crew building the project and issues encountered during construction that were not anticipated during design. SDG&E currently uses four primary construction contractors who perform the electrical construction and typically sub-contract the civil work (e.g., pole hole, anchor, handhole digging), helicopter, traffic control and dedicated fire watch. SDG&E also uses internal electric construction teams who typically contract out the helicopter, traffic control, dedicated fire watch and civil work (pole hole and anchor digging). Based on SDG&E's experience with its traditional hardening program, in 2023 it is estimated that 50% of the construction work costs will be performed by contractors and 50% by internal crews. The costs between external and internal crews can vary depending on the work scope, location (rural versus very rural), methods of construction (e.g., truck accessible versus non-truck accessible), time of year (e.g., fire season and non-fire season, and wet versus dry conditions), and issues encountered during construction. Larger projects (typically 20 or more poles) that are not assigned to an internal crew are sent out to bid with the three prime electrical construction contractors and are often bundled with other projects on the same circuit to gain economies of scale. SDG&E has determined that its ideal bid size is 100-200 poles; however, some bids have been significantly greater and some can be much smaller. The size of bids can change significantly depending on the location of a project, time of year, and schedule of the project. SDG&E has seen changes with pricing due to competition for construction resources with the other utilities in the state and this can drive-up costs depending on the volume of work and timing with other projects statewide.

CC Unit Cost Make Up:

For purposes of this comparison, PacifiCorp has again aligned its costs into the six major categories. No changes were made in 2022 related to how costs are organized into the six main categories. PacifiCorp is basing the cost per mile on ten projects totaling about 33 miles of primarily spacer cable. These projects were placed in service during 2022; however, design, material procurement, permitting, and some construction may have taken place prior to 2022.

CC Cost Drivers:

PacifiCorp has identified eight main cost drivers for the installation of CC. The cost drivers are discussed below in terms of cost increases that have been experienced, highlighting how impactful these components can be on the overall project cost.

Access: PacifiCorp includes costs for required access to facilitate project construction in projects charged to the work order. These costs may include vegetation clearing, road construction, or other site preparation activities. These costs will typically be included in the contractor total for purposes of this cost analysis as this work is predominantly contracted. Additionally, these costs can also range significantly between projects based on the specific location and terrain where work is conducted. Projects that include significant off-road scopes tended to be most impacted, though this is somewhat offset by limited flagging costs.

Pole Replacement: PacifiCorp evaluates all poles for strength and clearance using PLS CADD on spacer cable projects. Poles are then selected for replacement for the following reasons: insufficient strength to accommodate CC, insufficient minimum clearance, relocation is required, or not constructible in the current state. Projects completed in 2022 averaged 25 poles per mile due to projects with larger conductor sizes, short spans on in-town projects, and two projects designed for double circuits. Additionally, nearly all poles identified are replaced with non-wood fire resistant materials (predominantly fiberglass) at a greater cost than like-for-like replacement with wood.

Construction Labor: In 2022, PacifiCorp continued to receive higher bid prices. Contractors reported needing to include incentives to attract adequate labor to complete projects. Increases in construction labor costs were the single largest driver in project cost increases. As of January 31, 2023, PacifiCorp has awarded approximately one third of the 2023 planned construction work scope and is forecasting that these higher costs will continue.

Post Construction Inspections: In 2022, it was recognized that the total amount of construction exceeded the capacity of internal staff to adequately inspect as the construction was taking place. Based on this, external construction inspectors have been hired to monitor construction, while it is taking place, and complete a formal inspection of each line segment as it is placed into service. While this comes at a higher cost per line mile, it assures that the completed project matches the design. This will be an ongoing addition to project costs.

Permitting: As included in the company's 2021 Change Order, significant cost increases have been experienced for locations requiring access into seasonal wetlands and transmission under build projects.

Future projects include environmentally sensitive areas that have been in NEPA or CEQA review with high environmental review costs. Additionally, projects scheduled for completion in 2023 have required cultural monitors for all ground disturbing activities and several re-designs to accommodate changes in current infrastructure layout requested by permitting agencies.

Materials: PacifiCorp experienced material cost increases on most commodity materials in 2022; however, this impact was limited for the group of projects in this analysis as much of the material was on order prior to 2022. Projects scheduled for completion in 2023 are expecting to experience more impact from these cost increases.

Internal Labor and Overhead: Internal labor increased on a per mile basis while overhead costs decreased. This is largely driven by a shift in staff charging directly to projects they are working on rather than an overhead account. These should be viewed largely as offsetting cost shifts.

Design Type: In 2022, PacifiCorp rebuilt approximately 7 miles of overhead distribution lines with CC. While there are many factors impacting the projects overall costs, a cursory review indicates a lower cost per mile as compared to spacer cable, generally attributed to the lower cost of materials, shortened project timeline, and reduction in engineering and design requirements. However, some of these costs are offset by the increase in pole replacements required with using a more standardized product. Based on this one project, PacifiCorp expects that CC could be a cost-effective option in many locations but requires more experience to understand the cost variability.

Based on the cost drivers discussed above, PacifiCorp anticipates higher costs for projects in 2023 and beyond.

Bear Valley

CC Unit Cost Make Up:

BVES continues to contract out most of the work with an internal Field Inspector overseeing the whole project. The design consists of our contractor performing field visits, wind loading calculations, developing the design and assembling the material lists. BVES purchases the materials and its contractor does the construction. The overhead costs consist of BVES internal groups. The capital cost per circuit mile are based on a double circuits' area in 2022.

CC Cost Drivers:

CC unit costs decreased in 2022 compared to 2021. A higher percentage of poles were installed which support both 34.4 kV and 4 kV CC lines. These double circuit lines reduce installation and material costs. In addition, the construction crews have gained more experience installing CC and are more efficient.

Liberty

CC Unit Cost Make Up:

Liberty's CC program is still relatively new and limited in scope compared to the large utilities. Liberty first piloted CC projects in 2020 in select areas that already needed line upgrades because of asset age and condition, and later focused on projects that targeted short line segments in HFTD areas, had reliability issues, and were in remote areas. An average of recent CC projects amounted to less than one circuit mile per project and only a total of 20 miles of CC were installed over the last 3 years. Liberty's CC work is

substantially less than, for example, SCE's approximate 1,000+ miles of CC installed each year. Liberty's CC unit costs vary depending on terrain, number of poles replaced, type of conductor installed, project design and permitting requirements, and amount of vegetation management work required for the job order. Liberty used the same cost categories as described in the 2022 WMP Update report and did not make any major changes to its CC program.

CC Cost Drivers:

Liberty's project life cycle ranges from 18-36 months depending on project scope and permitting complexity. There are many factors that may impact the total project life cycle and costs, including permitting and environmental requirements, easements, geography and terrain, and construction resource availability. Contractor costs for construction in its service area are a major cost driver for Liberty. Projects typically take longer to construct because of the mountainous terrain and require more costly construction methods like helicopter use and hand digging. Other cost factors include permitting, weather, and environmental restrictions that limit scheduling flexibility and reduce productivity, causing construction costs to increase.

Conductor Type: Liberty has two CC designs that vary depending on project site access and terrain. These include 14.4 kV delta Aerial Spacer Cable (ACS or spacer cable) and CC solutions at this voltage level. In addition, because some of Liberty's service area includes 12.5 kV grounded Wye system, Liberty has piloted the use of CC. Liberty selects the two different system options based on the installation and maintenance of the two solutions.

The ACS solution has two or three covered conductors supported by a steel messenger. The framing for ACS includes brackets that hold the messenger under tension and for the current carrying conductors at full sag or zero tension. Installing and maintaining spacers requires a bucket truck; however, if accessibility is an issue, crews may require a bosun's chair to access the line adding to the costs.

The covered conductor solution includes various sizes of covered wire such as a 1/0, 2/0, or 397 kcmil AAC. The ACS solution projects have installed 1/0 AA wire with 1-052 AWA messenger and 1/0 AAC with 6AW messenger. Covered conductor is installed with framing similar to bare conductor wire in an open-crossarm configuration for framing and installation. CC is the preferred solution in areas with limited bucket truck access. Conductors are sized based on circuit load for both solutions. Wind and ice loading are major concerns in the Liberty service area and do not utilize conductors smaller than 1/0.

Location: A vast majority of Liberty's service area is in HFTD Tier 2 and Tier 3. In the initial phases of its covered conductor program, Liberty selected areas of its service area based on local knowledge of the wildland/urban interface, locations of high fire threat districts, remoteness of overhead lines, and the age and condition of the infrastructure. Areas were also chosen based on their accessibility and egress options during an emergency. Most of Liberty's covered conductor projects are in Tier 2 and Tier 3 at elevations between 6,200 to 7,500 feet over rugged, rocky terrain with limited seasonal access. Projects typically utilize helicopter pole sets, and crews are tasked with digging pole holes with pneumatic tools by hand versus trucks with augers. Pole holes take days versus hours to excavate, increasing labor hours and costs.

Pole and Asset Replacements: Most of the covered conductor projects Liberty has designed and constructed have required a significant number of pole replacements per circuit mile. When replacing existing poles, Liberty uses taller and larger class poles. This is due to new loads and increased weights of the covered conductor, as well as the age of existing infrastructure. Projects include installation of poles, insulators, crossarms, anchors (rock anchors), down guys, transformers, and switches.

Economies of Scale: Liberty has limited contract resources available during its construction period compared to the larger IOUs that have replaced thousands of circuit miles with CC. Liberty's contract costs are higher on a per mile basis than those of large IOUs, given Liberty's ratio of miles installed as compared to IOUs with significantly more miles installed. This factor has likely contributed to Liberty's higher CC cost per circuit mile.

Construction: Liberty's primary construction window is May 1 to October 15 due to weather and Tahoe Regional Planning Agency (TRPA) dig season restrictions. The construction window also coincides with seasonal tourism, a high number of RFW days, and during the typical fire season that further limits construction efforts and effects costs. These restrictions also constrain resources and add a premium on labor during construction season.

Vegetation Management: Liberty's service area is in a high elevation and mountainous terrain that is densely forested, averaging over one hundred trees per mile within maintenance distance of the conductor, given recent LiDAR data. Vegetation management inspectors and tree crews often need to access work sites on foot while carrying tools and equipment, resulting in much higher labor costs compared to typical work areas. In addition, due to the robust tree canopy in the Tahoe region, tree crew cost per circuit mile of construction has increased significantly due to SB 247 labor rate increases. Tree removals and pruning costs are unique to Liberty's service area and will increase the overall CC project costs.

In 2022, Liberty experienced an approximate 20% decrease in CC costs compared to 2021. This cost decrease was mainly due to Liberty's use of internal construction crews instead of contractors in 2021. Additionally, 2022 projects required fewer helicopter pole sets and less hand-digging than 2021 projects.

Next Steps:

In 2023, the utilities will continue this workstream and further discuss and document CC recorded/estimated unit costs, undergrounding unit costs and cost drivers as well as assess adding initial unit costs for other alternatives. The utilities will also document any lessons learned.

Lessons Learned:

Introduction:

In the utilities' 2022 WMP Update decisions, Energy Safety identified an ACI for all utilities to provide goals and timelines for implementing lessons learned from the CC joint effectiveness study. Specifically, Energy Safety ordered all utilities to:

As described in the sections above, the utilities are sharing and documenting information and lessons learned, and are driving to understand if best practices, common methods, and greater comparability

can be established. Where utilities have made improvements based on this working group, they are described in the sections above. Importantly, consistent with the 2022 WMP Update filings, while not an objective of the working group, the utilities anticipated that there could be lessons to learn from one another such as construction methods, engineering/planning, execution tactics, etc. that could help improve each utilities' deployment of CC. Since the final decisions on the utilities' 2022 WMP Update filings and as part of each workstream meeting, the utilities have discussed whether or not there are lessons learned and if so, documented these and any plans the utilities have to implement those lessons. In the limited time the utilities have had in 2022 to meet this requirement, we have documented a few lessons learned; however, it is important to note that each utilities' CC program (the initial focus of this effort) had been previously established and was based on past benchmarking, research, testing, and lessons learned from other utilities including SCE (see, e.g. the Covered Conductor Compendium), i.e., many lessons learned were already incorporated into each utilities' CC program. Notwithstanding this, and considering the expansion of this working group, the utilities are committed to documenting lessons learned and plans to implement them.

Lessons Learned:

The utilities agree that it is helpful to share information, practices, and data across the utilities as this can lead to improvements in reducing wildfire risk, safety incidents, and the impacts of PSPS, and improvements with other utility objectives. In furtherance of this objective, and given that a simple table cannot provide the information in a readable format with the ACI requirements, the utilities describe their lessons learned for this working group by the required subject areas.

CC Effectiveness Values

Pursuant to the testing results and further analysis, SCE and PG&E modified their estimated effectiveness values for certain risk drivers since its 2022 WMP Update submissions and have implemented these changes. SDG&E refreshed its effectiveness analysis per previous methodology but have not yet incorporated the updated value in its decision making. SDG&E anticipates completing this by December 2023. Based on the other utilities' previous estimates, the testing results, and their own data, no changes to CC effectiveness values were warranted at this time. These changes are described above in the Estimated Effectiveness workstream. The changes to effectiveness values have and are being incorporated into RSE calculations which in turn will feed into the utilities' decision-making processes. These updated RSE calculations will also be incorporated into utilities' future filings such as RAMP, GRC, and as applicable the WMP. If additional changes are made to effectiveness values, the utilities will document those lessons learned.

Data Sharing

An update on data sharing across utilities on measured effectiveness of CC in-field and pilot results, including collective evaluation. The utilities have and continue to share information across all workstreams. During 2022, utilities provided updates on recorded effectiveness. These included presentations and overviews on data, dashboards, and areas of continued improvement. The utilities also discussed their CC efforts including any pilots and shared these experiences.

Inclusion of REFCL, OPD, EFD, and DFA as alternatives, including for PSPS considerations

As described in the New Technologies section of this report, the utilities will discuss and document data and methods that can be used to estimate the effectiveness of these technologies. This workstream is new and the utilities have identified a series of workshops to develop this workstream. To date, the

utilities have not documented any lessons learned or changes from 2021 or 2022 for inclusion of new technologies.

Cost Impacts and Drivers

As described in the Cost section of this report, the utilities have provided an updated CC capital cost per circuit mile and document the cost changes and drivers. As explained in last year's report, each CC project is unique and will have different costs. Additionally, there are many factors that can increase costs including, for example, economies of scale, the mix of work across regions and differing terrain, contractor rates, permitting, resource constraints, and environmental restrictions. In 2022, the utilities provided updates with one another on these costs through presentations and overviews including trends, material price changes, and other cost-related information. Please see the Cost section in this report for further details the changes in cost impacts and drivers from last year's report.

Changes made to initiative selection based on effectiveness and benchmarking across alternatives.

The utilities have not made changes to initiative selection based on this joint IOU effort. The data and information compiled has confirmed the utilities understanding that CC is effective at reducing wildfire risk and highly effective at reducing most contact from object and wire-to-wire risk drivers. The testing has also shown CC is effective at reducing other risk drivers as well. Should one or more utilities make changes to initiative selection as a result of this effort, we will document those lessons learned as well as plans to implement them.

Next Steps:

In 2023, the utilities will document all lessons learned across all workstreams and will develop plans to implement those lessons learned, as applicable.

Conclusion:

This joint IOU report provides descriptions of the progress the utilities have made to better understand the long-term effectiveness of CC and its ability to reduce wildfire risk and PSPS impacts (and, in comparison to alternatives) as well as CC M&I practices, new technologies, and lessons learned. The utilities have made progress on this effort and describe plans for 2023 to conduct a large number of workshops to further understand the data and analyses that have been compiled, identify best practices for CC M&I, assess new technology effectiveness and the sharing of practice and implementation strategies, and discuss methodologies that can be employed across all utilities to improve comparability. The utilities look forward to continuing these efforts in 2023 and providing future updates.