



Bear Valley Electric Service 2023-2025 Wildfire Mitigation Plan

2025 Revision 1



Bear Valley
Electric Service, Inc.
A Subsidiary of American States Water Company

Submitted by:

Bear Valley Electric Service, Inc.

May 29, 2024

Table of Contents

1. Executive Summary	1
1.1 Summary of 2020–2022 WMP Cycle.....	1
1.2 Summary of 2023–2025 Base WMP.....	7
2. Responsible Persons	11
3. Statutory Requirement Checklist.....	14
4. Overview of WMP	20
4.1 Primary Goal	20
4.2 Plan Objectives	20
4.3 Proposed Expenditures	22
4.4 Risk Informed Framework	23
5. Overview of the Service Territory	26
5.1 Service Territory	26
5.2 Electrical Infrastructure.....	27
5.3 Environmental Settings.....	28
5.3.1 Fire Ecology.....	28
5.3.2 Catastrophic Wildfire History	29
5.3.3 High Fire Threat Districts	30
5.3.4 Climate Change	31
5.3.5 Topography	38
5.4 Community Values at Risk	38
5.4.1 Urban, Rural, and Highly Rural Customers	38
5.4.2 Wildland-Urban Interfaces.....	39
5.4.3 Communities at Risk from Wildfire	39
5.4.4 Critical Facilities and Infrastructure at Risk from Wildfire.....	40
5.4.5 Environmental Compliance and Permitting (<i>Tracking ID: ST_1</i>).....	41
6. Risk Methodology and Assessment	42
6.1 Methodology.....	42
6.1.1 Overview.....	42
6.1.2 Summary of Risk Models	52
6.2 Risk Analysis Framework	59
6.2.1 Risk and Risk Component Identification.....	59
6.2.2 Risk and Risk Components Calculation	64
6.2.3 Key Assumptions and Limitations	70
6.3 Risk Scenarios	73
6.3.1 Design Basis Scenarios	74
6.3.2 Extreme-Event Scenarios/Uncertainty Scenarios.....	77
6.4 Risk Analysis Results and Presentation	78

6.4.1 Top Risk Areas within the HFRA.....	78
6.4.2 Top Risk-Contributing Circuits/Segments/Spans.....	80
6.4.3 Other Key Metrics	81
6.5 Enterprise System for Risk Assessment.....	82
6.6 Quality Assessment and Control	82
6.6.1 Independent Review	83
6.6.2 Model Controls, Design, and Review	85
6.7 Risk Assessment Improvement Plan	85
7. Wildfire Mitigation Strategy Development	90
7.1 Risk Evaluation	90
7.1.1 Approach	90
7.1.2 Key Stakeholders for Decision Making.....	92
7.1.3 Risk-Informed Prioritization	93
7.1.4 Mitigation Selection Process	96
7.2 Wildfire Mitigation Strategy.....	102
7.2.1 Overview of Mitigation Initiatives.....	102
7.2.2 Anticipated Risk Reduction	109
7.2.3 Interim Mitigation Strategies.....	112
8. Wildfire Mitigation	113
8.1 Grid Design, Operations, and Maintenance	113
8.1.1 Overview.....	113
8.1.2 Grid Design and System Hardening.....	130
8.1.3 Asset Inspections.....	147
8.1.4 Equipment Maintenance and Repair	155
8.1.5 Asset Management and Inspection Enterprise System(s) (Tracking ID: GD_34)	160
8.1.6 Quality Assurance / Quality Control (QA/QC) (Tracking ID: GD_35)	163
8.1.7 Open Work Orders (Tracking ID: GD_36)	165
8.1.8 Grid Operations and Procedures.....	167
8.1.9 Workforce Planning (Tracking ID: GD_40)	173
8.2 Vegetation Management and Inspection	191
8.2.1 Overview.....	191
8.2.2 Vegetation Inspections.....	205
8.2.3 Vegetation and Fuels Management	211
8.2.4 Vegetation Management Enterprise System (VM_15).....	220
8.2.5 Quality Assurance / Quality Control (QA/QC) (VM_16)	221
8.2.6 Open Work Orders (VM_17)	225
8.2.7 Workforce Planning (VM_18)	227
8.3 Situational Awareness and Forecasting.....	237
8.3.1 Overview.....	237

8.3.2 Environmental Monitoring Systems.....	242
8.3.3 Grid Monitoring Systems.....	247
8.3.4 Ignition Detection Systems.....	250
8.3.5 Weather Forecasting.....	258
8.3.6 Fire Potential Index.....	261
8.4 Emergency Preparedness.....	262
8.4.1 Overview.....	262
8.4.2 Emergency Preparedness Plan.....	271
8.4.3 External Collaboration and Coordination.....	299
8.4.4 Public Emergency Communication Strategy (EP_3).....	332
8.4.5 Preparedness and Planning for Service Restoration.....	341
8.4.6 Customer Support in Wildfire and PSPS Emergencies (EP_5 - COE_1 – COE_2 – COE_3 – COE_4).....	350
8.5 Community Outreach and Engagement.....	352
8.5.1 Overview.....	352
8.5.2 Public Outreach and Education Awareness Program (COE_1 – COE_2 – COE_3 – COE_4).....	359
8.5.3 Engagement with Access and Functional Needs Populations.....	362
8.5.4 Collaboration on Local Wildfire Mitigation Planning.....	366
8.5.5 Best Practice Sharing with Other Electrical Corporations.....	368
9. Public Safety Power Shutoff.....	371
9.1 Overview.....	371
9.1.1 Key PSPS Statistics.....	371
9.1.2 Identification of Frequently De-energized Circuits.....	372
9.1.3 Objectives.....	373
9.1.4 Targets.....	380
9.1.5 Performance Metrics Identified by the Electrical Corporation.....	381
9.2 Protocols on PSPS.....	385
9.3 Communication Strategy for PSPS.....	391
9.4 Key Personnel, Qualifications, and Training for PSPS.....	391
9.5 Planning and Allocation of Resources for Service Restoration due to PSPS.....	391
10. Lessons Learned.....	395
11. Corrective Action Program.....	408
12. Notice of Violation and Defect.....	414

List of Appendices

- Appendix A. Definitions
- Appendix B. Supporting Documentation for Risk Methodology
- Appendix C. Additional Maps

Appendix D. Areas for Continued Improvement
 Appendix E. Referenced Regulations, Codes, and Standards
 Appendix F. BVES Emergency Response and Disaster Plan
 Appendix G. BVES Vegetation Management Policy
 Appendix H. BVES Quality Management Plan
 Appendix I. BVES PSPS Procedure
 Appendix J. BVES AFN Plan

List of Tables

Table 3-1 Statutory Requirements Checklist	14
Table 4-1 Summary of WMP Expenditures	22
Table 4-2 Risk-Informed Approach Components.....	23
Table 5-1 BVES Service Territory Overview.....	27
Table 5-2 Overview of Key Electrical Equipment.....	27
Table 5-3 Vegetation Types in the Service Territory.....	29
Table 5-4 Catastrophic Electrical Corporation Wildfires.....	30
Table 5-5 Electrical Corporation’s HFTD Statistics.....	31
Table 5-6 Relevant State and Federal Environmental Laws, Regulations, and Permitting Requirements for Implementing the WMP	41
Table 6-1 Summary of Risk Models	54
Table 6-2 Risk Modeling Assumptions and Limitations as provided by Technosylva	71
Table 6-3 Summary of Design Basis Scenarios	75
Table 6-4 Summary of Extreme-Event Scenarios.....	77
Table 6-5 Summary of Top-Risk Circuits/Segments.....	80
Table 6-6 Summary of Key Metrics by Statistical Frequency.....	81
Table 6-7 Utility Risk Assessment Improvement Plan	86
Table 7-1 Stakeholder Roles and Responsibilities in Decision Making Process	92
Table 7-2 Evaluation of HFTD Prioritized Circuits	94
Table 7-3 BVES WMP Mitigation Initiatives for 3-year and 10-year Outlooks	103
Table 7-4 Summary of Risk Reduction for Top-Risk Circuits	111
Table 8-1 Grid Design, Operations, and Maintenance (3-Year Plan).....	113
Table 8-2 Grid Design, Operations, and Maintenance Objectives (10-Year Plan)	117
Table 8-3 Grid Design, Operations, and Maintenance Targets by Year.....	121
Table 8-4 Asset Inspections Targets by Year	127
Table 8-5 Grid Design, Operations, and Maintenance Performance Metrics Results by Year	129
Table 8-6 Asset Management Inspection Frequency, Method, and Criteria.....	148
Table 8-7 Grid Design and Maintenance QA/QC Program	163
Table 8-8 Past Due Asset Work Orders	167
Table 8-9 Workforce Planning, Asset Inspections	175
Table 8-10 Workforce Planning, Grid Hardening	180
Table 8-11 Workforce Planning, Risk Event Inspection	188
Table 8-12 BVES Vegetation Management Implementation Objectives (3-year plan)	192
Table 8-13 Vegetation Management Implementation Objectives (10-year plan).....	194
Table 8-14 Vegetation Management Initiative Targets by Year	198
Table 8-15 Vegetation Inspections Targets by Year	200
Table 8-16 Vegetation Management and Inspection Performance Metrics Results by Year..	203
Table 8-17 Vegetation Management Inspection Frequency, Method, and Criteria.....	205
Table 8-18 Vegetation Management QA/QC Program	222
Table 8-19 Number of Past Due VM Work Orders Categorized by Age.....	226

Table 8-20 Vegetation Management Qualifications and Training	228
Table 8-21 Situational Awareness Initiative Objectives (3-year plan)	238
Table 8-22 Situational Awareness Initiative Objectives (10-year plan)	239
Table 8-23 Situational Awareness Initiative Targets by Year	240
Table 8-24 Situational Awareness and Forecasting Performance Metrics Results by Year ...	241
Table 8-25 Environmental Monitoring Systems	243
Table 8-26 Planned Improvements to Environmental Monitoring Systems	247
Table 8-27 Grid Operation Monitoring Systems.....	248
Table 8-28 Improvements to Grid Operation Monitoring Systems	249
Table 8-29 Fire Detection Systems Currently Deployed	251
Table 8-30 Planning Improvements to Fire Detection and Alarm Systems	257
Table 8-31 Planned Improvements to Weather Forecasting Systems	260
Table 8-32 FPI Features	262
Table 8-33 Emergency Preparedness Initiative Objectives (3-year plan).....	266
Table 8-34 Emergency Preparedness Initiative Objectives (10-year plan).....	267
Table 8-35 Emergency Preparedness Initiative Targets by Year	269
Table 8-36 Emergency Preparedness Performance Metrics Results by Year	271
Table 8-37 Key Gaps and Limitations in Integrating Wildfire- and PSPS-Specific Strategies into Emergency Plan.....	276
Table 8-38 Emergency Preparedness Staffing and Qualifications	278
Table 8-39 Electrical Corporation Personnel Training Program.....	288
Table 8-40 Contractor Training Program	293
Table 8-41 Internal Drill, Simulation, and Tabletop Exercise Program.....	294
Table 8-42 External Drill, Simulation, and Table-top Exercise Program	296
Table 8-43 Wildfire-Specific Updates to the Emergency Preparedness Plan.....	299
Table 8-44 State and Local Agency Collaboration(s)	301
Table 8-45 Key Gaps and Limitations in Collaboration Activities with State and Local Agencies	317
Table 8-46 High-Level Communication Protocols, Procedures, and Systems with Public Safety Partners	318
Table 8-47 Key Gaps and Limitations in Communication Coordination with Public Safety Partners	329
Table 8-48 High-Level Mutual Aid Agreement for Resources During a Wildfire or De- Energization Incident.....	330
Table 8-49 Protocols for Emergency Communication to Public Stakeholder Groups.....	335
Table 8-50 Key Gaps and Limitations in Public Emergency Communication Strategy.....	341
Table 8-51 Internal Drill, Simulation, and Table-top Exercise Program for Service Restoration	347
Table 8-52 External Drill, Simulation, and Table-top Exercise Program for Service Restoration	348
Table 8-53 Community Outreach and Engagement Initiative Objectives (3-year plan)	353
Table 8-54 Community Outreach and Engagement Initiative Objectives (10-year plan)	356
Table 8-55 Community Outreach and Engagement Initiative Targets by Year	357
Table 8-56 PSPS Outreach and Engagement Initiative Targets by Year	358
Table 8-57 Community Outreach and Engagement Performance Metrics Results by Year ...	359
Table 8-58 List of Target Community Groups.....	360
Table 8-59 List of Target Community Partners	361
Table 8-60 Community Outreach and Education Programs.....	362
Table 8-61 Collaboration in Local Wildfire Mitigation Planning	367
Table 8-62 Key Gaps and Limitations in Collaborating on Local Wildfire Mitigation Planning	368
Table 8-63 Best Practice Sharing with Other Electrical Corporations	369

Table 9-1 PSPS Statistics	371
Table 9-2 De-energized Circuits.....	372
Table 9-3 PSPS Objective (3-year plan).....	375
Table 9-4 PSPS Objective (10-year plan).....	378
Table 9-5 PSPS Targets	380
Table 9-6 Projected PSPS Performance	385
Table 10-1 Lessons Learned.....	398
Table 12-1 Open Violations and Defects.....	414

List of BVES Tables

BVES Table 2-1 WMP Responsible Persons	11
BVES Table 6-1 Risk Model Enhancements	52
BVES Table 7-1 Projected Overall Service Territory Risk	110
BVES Table 8-1 Capacitor Replacement List.....	156
BVES Table 8-2 Detailed Data Information	161
BVES Table 8-3 Quality Control Program Tracking.....	164
BVES Table 8-4 FPI Operational Action.....	170
BVES Table 8-5 Comparison of Bear Valley’s Vegetation Standards to GO 95 Minimum Requirements	195
BVES Table 8-6 VM Program Annual QA Audit Areas	223
BVES Table 8-7 Weather Station List	244
BVES Table 8-8 ALERT Wildfire HD Camera List.....	245
BVES Table 8-9 ALERTCalifornia HD Camera List.....	252
BVES Table 8-10 Outage and Emergency Response	274
BVES Table 8-11 Category Entity Primary Contact List	337
BVES Table 8-12 Restoration Priorities Guidance	345
BVES Table 9-1 Highest Daily Wind Gust and Sustained Wind on High-Risk Days	383
BVES Table 9-2 National Fire Danger Rating System (NFDRS) Historic Data	383
BVES Table 9-3 BVES Action for SCE Lines De-Energized due to PSPS.....	387
BVES Table 9-4 PSPS Re-Energization and Post-Event Strategy	392
BVES Table 11-1 2022 WMP Feedback and Status	410
BVES Table 11-2 Working Groups.....	413

List of Figures

Figure 5-1 Service Territory and Customers Served.....	26
Figure 5-2 HFTD Tier Breakdown for the Service Territory.....	31
Figure 5-3 Annual Mean Climatology for the Electrical Corporation’s Service Territory	32
Figure 5-4 Annual Maximum Temperature and Occurrence for the Electrical Corporation’s Service Territory.....	33
Figure 5-5 Annual Minimum Temperature and Occurrence for the Electrical Corporation’s Service Territory.....	34
Figure 5-6 Mean Annual Temperature for Service Territory, 1900s–2020s	35
Figure 5-7 Mean Annual Precipitation for Service Territory, 1900s–2020s	36
Figure 5-8 Mean Annual Precipitation for Service Territory, 1900s–2020s	36
Figure 5-9 Projected Change in Maximum Temperature (Daytime Highs) Through 2100 for the Service Territory.....	37
Figure 5-10 Projected Change in Minimum Temperature (Nighttime Lows) Through 2100 for the Service Territory.....	37

Figure 5-11. Projected Changes in Average Fuel Moisture and Average Number of Days of Extreme Fire Danger for Winter/Spring and Summer/Fall Periods for the Service Territory Based on Global Climate Model Outputs	38
Figure 5-12 SVI Overlay of Service Territory	40
Figure 6-1 Risk Assessment Component Hierarchy	44
Figure 6-2 Future State Risk Assessment Component Hierarchy	44
Figure 6-3 Cycle Ten-Step Approach	45
Figure 6-4 BVES Network Current Risk State	49
Figure 6-5 Use Case Long-Term Cost Comparison	50
Figure 6-6 Use Case PSPS Risk By Year	51
Figure 6-4 Composition of Overall Utility Risk (purple); Utility-related sources of risk including Ignition and PSPS Risks (blue); Intermediate Risk Components (green); and Fundamental Risk Components (yellow)	60
Figure 6-5 Example Calculation Schematic	64
Figure 6-6 Risk Model Process Diagram	66
Figure 6-10 FPI Value and Percentile Table	67
Figure 6-7 REAX – Risk Level Represented as Annualized Burn Probability	79
Figure 7-1 BVES Risk-Based Decision-Making Framework	90
Figure 7-2 Prioritization of Higher Fire-Threat Areas	94
Figure 7-3 BVES Project Selection Process	100
Figure 7-4 Projected Overall Service Territory Risk Graph	109
Figure 8-1 2023 Planned Covered Conductor Installation Location	133
Figure 8-2 Asset Work Orders by Quarter	167
Figure 8-3 Vegetation Management Work Orders by Quarter	227
Figure 8-4 BVES Weather Station Locations	245
Figure 8-5 WFA-E Domain Coverage	256
Figure 8-6 FEMA National Planning System Six Step Process	265
Figure 8-7 SEMS Organization	273
Figure 8-8 BVES Emergency Organization	274
Figure 8-9 EDRP Event Flowchart	275
Figure 8-10 PSPS Event Flowchart	275
Figure 8-11 FEMA National Planning System Six Step Process	298
Figure 8-12 BVES Press Release Protocol	341
Figure 9-1 BVES High Risk Areas for PSPS Consideration	373
Figure 9-2 BVES Supply Lines, Sources of Power and Sub-Transmission System	387
Figure 9-3 PSPS Decision-Making Criteria	389

1. Executive Summary

In the opening section of the WMP, the electrical corporation must provide an executive summary that is no longer than 10 pages. The executive summary must provide brief narratives on each of the following topics.

The Bear Valley Electric Service, Inc. (BVES or Bear Valley) Wildfire Mitigation Plan (WMP) aims to reduce the risk of utility-caused ignitions or threats as well as to mitigate the need for Public Safety Power Shutoff (PSPS) events in the future. This WMP represents BVES's plan to continue to reduce utility wildfire risks, maintain reliability, meet its regulatory obligations, and plan for continuous improvement through future years within the WMP compliance cycle.

Bear Valley's service area is in the mountain resort community of Big Bear Lake, California, with approximately 24,650 customers in a 32 square-mile service area located in the San Bernardino Mountains of Southern California, 80 miles east of Los Angeles. The region is remote and mountainous. The service area is entirely above 3,000 feet requiring all construction to conform to the "heavy" loading standards (highest strength standard) of the California Public Utility Commission (CPUC) General Order 95 (GO 95). The adjacent wilderness environment, including heavily forested terrain with dense underbrush makes the territory vulnerable to potential ignition risk. The service area is considered "Very Dry" or "Dry" per the National Fire Danger Rating System (NFRDS) over 75 percent of the time. Therefore, the combination of dry conditions and heavy vegetation result in high levels of available fuel to burn in the event of a wildfire.

The CPUC Fire-Threat Map, adopted January 19, 2018, designated Bear Valley's service area as being in the High Fire-Threat District (HFTD) with approximately 90% in Tier 2 (elevated risk) and the remaining 10% in Tier 3 (extreme risk) areas. The California Department of Forestry and Fire Protection ("Cal Fire") California Fire Hazard Severity Zone Map Update Project rates Bear Valley's service area as "Very High Fire Hazard Severity Zone". Years of drought and elevated ambient temperatures above historical norms has only exacerbated the situation further. Climate change predictions project increased drought, dryness, and elevated temperatures will continue their increasing trends. It is against this backdrop that BVES develops its WMP initiatives.

This WMP demonstrates the continued effort and investment underway at BVES and progress realized to reduce the probability of utility-caused ignitions and reduce the potential of wildfires to impact the reliable operation of the BVES system. The 2023-2025 WMP includes more data and quantitative content than its previous submissions and incorporates longer-term systematic thinking on reducing wildfire risks, additively and cumulatively, to improve BVES's wildfire mitigation maturity over time.

1.1 Summary of 2020–2022 WMP Cycle

The electrical corporation must provide a brief overview of its progress in achieving the goals, objectives, and targets specified in the previous WMP submissions. The overview must discuss areas of success, areas for improvement, and any major lessons learned.

BVES did not experience any ignition events or conditions that would have caused it to activate any Public Safety Power Shutoff (PSPS) to mitigate wildfire threats during the 2020-2022 WMP period. Bear Valley maintains its facilities with a foundational understanding of natural resource management in an area surrounded by mountainous terrain and forested slopes. To sustain its record of success, Bear Valley worked collaboratively with public safety partners and state and

federal agencies to enhance its preparation to face the ever-evolving threat of catastrophic wildfires.

Despite an absence of utility-caused ignitions or PSPS events, BVES recognizes the risk of ignitions and PSPS events is still significant and, therefore, embraces wildfire safety as a core competency in executed work, adopting fire operational standards, and continuously monitoring system and environmental conditions. BVES directed its resources to the most cost-effective projects to bring down the risk while aiming to promote resilience and maintain affordability and reliability. Specifically, BVES aims to (1) improve its understanding of the wildfire risk posed by and to its systems; (2) focus on reducing the highest risks aggressively and efficiently; and (3) maximize scarce financial and human resources in its efforts to mitigate wildfire risks. BVES also recognizes the significant impact climate change is having on increasing the risk of wildfires; BVES must continue to push forward with progress on its WMP initiatives to prevent potential future ignitions, wildfires, and avoid reliance on PSPS as an ignition mitigation tool.

During the 2020-2022 WMP Cycle, BVES achieved substantial progress on all 10 categories of its WMP initiatives. Some of the more significant achievements are highlighted as follows:

1. **Risk Assessment and Mapping:** BVES conducts its overall risk-based decision-making in accordance with CPUC Decision D.19-04-020 of May 6, 2019, which provides the framework that the Small and Multi-jurisdictional Utilities (SMJUs) are required to follow. This approach to risk management includes some of the basic tenets of the International Standardization Organization's "Risk Management – Principles and Guidelines" ("ISO 31000"). BVES found that this approach is heavily reliant on subject matter experts (SMEs) and is not sufficiently granular to permit detailed prioritization of specific circuits, segments, and areas for risk mitigation initiatives.

In order to implement a method to assess risk at the circuit level and prioritize initiatives on the BVES sub-transmission and distribution system, BVES implemented the Fire Safety Circuit Matrix. This rudimentary model determines circuit level risk under current and planned mitigation activities intended to reduce ignition potential. The purpose of the Fire Safety Circuit Matrix model is to assist as a planning tool in determining a circuit level risk that accounts for the current and planned mitigation activities that intend to reduce ignition potential. The Fire Safety Circuit Matrix was utilized to inform the planning period of the WMP considering changes to the risk profile as mitigations are executed over time. Outputs (mitigations and controls) from the risk-based decision-making approach are integrated in the Fire Safety Circuit Matrix to establish where and in what sequence the mitigations or controls should be applied to the sub-transmission and distribution systems. BVES updates this model on a semi-annual basis as initiative targets are reviewed and revisited for the following year. The model was improved to use historical weather data and vegetation density (based on Light Detection and Ranging (LiDAR) surveys) to determine the risk of wildfire and reduce reliance on SME evaluation.

In 2021, the utility contracted expert services to enhance current risk maps and expand its capability to better predict fire conditions and behaviors. The model aimed to address four separate subtasks of the Risk Mapping Program: (1) ignition probability mapping showing the probability of ignition along overhead electric lines and equipment; (2) match drop simulations showing the potential wildfire consequence of ignitions that occur along electric lines and equipment under current (2021) conditions; (3) match drop simulations showing the potential wildfire consequence of ignitions that occur along the electric lines and equipment under future (2050) conditions; and (4) summarized risk maps showing overall

ignition probability and estimated wildfire risk under current and future conditions. BVES's modeling package accounts for ignition risk probability and wildfire consequence (both area burned and structures impacted) through climate-driven factors. The visuals present a guide, which influences future planning targeting areas of greatest risk.

In June of 2022, BVES contracted with Technosylva, an expert wildfire risk modeling consultant firm, to further advance the Risk Mapping Program and enhance situational awareness. Better understanding of the risk environment will improve BVES's resource allocation. This effort leveraged Technosylva's Wildfire Analyst Enterprise (WFA-E) software capabilities and solutions implemented across California for other electric utility companies. Engaging with Technosylva has provided BVES software applications and analysis to generate the following:

- Through use of WFA-E FireSim, provision of on-demand, real-time wildfire behavior modeling, predictive spread conditions, and derivation of potential impacts analysis
- Ability to conduct simulations on-demand, to reflect changing conditions or local data observations, including proactive "what if" scenarios
- Weather and wildfire risk forecasting for customer assets and the service territory using daily weather prediction integration to support PSPS activation calls and response operations
- Asset risk analysis using historical weather climatology to support WMP development and mitigation planning

The asset risk analysis will utilize Technosylva's Wildfire Risk Reduction Model (WRRM)¹ which uses historical climatology (weather & fuel moisture data) as key input weather scenarios (~ 30 year and 2 km hourly reanalysis data). The model produces risk metrics by running fire spread simulations for each weather scenario territory wide. The outputs can be aggregated based on percentile and assigned to assets. The model uses historical or predicted fuels data (2030 etc.) and utilizes hundreds of millions of fires spread simulations across the customer service territory. The outputs are to be used to support mitigation planning in addition to setting context for daily FireCast asset risk forecasts.

It is BVES's intent to transition from using the Fire Matrix to use the WRRM to prioritize its WMP initiatives. The first runs of the WRRM were not completed in time to inform the 2023 WMP grid hardening work plan, since much of the planning had to occur in the summer of 2022 so that design specifications could be identified sufficiently in advance due to the long procurement supply chain process that all utilities are currently experiencing. Initial WRRM results became available to BVES in late February 2023. Therefore, the WRRM will be used in the 2024 and 2025 WMP Updates. BVES believes that replacing the Fire Matrix with the WRRM will provide a probabilistic model and the level of granularity will eventually shift from the circuit level to the segment or span level. The model will provide calculated probability, consequence, and risk.

2. **Situational Awareness and Forecasting:** BVES installed 20 weather stations, which it continuously monitors. The weather stations record weather data in a historian and the outputs are utilized by BVES's weather consultant, Technosylva's models, and are available to open-source forecasting (NOAA). Additionally, BVES worked with stakeholders to ensure the High-Definition (HD) ALERTWildfire Network had sufficient cameras (15 total in 7

¹ As of July 2023 Technosylva's Wildfire Risk Reduction Model (WRRM) is now called FireSight.

locations) to provide full visibility into the Big Bear Valley. As discussed above, during this period, BVES implemented Technosylva's Wildfire Analyst Enterprise (WFA-E) software capabilities and solutions to provide real-time fire threat forecasts along BVES's circuits. This capability has enhanced BVES's ability to evaluate the potential for invoking Public Safety Power Shutoffs (PSPS).

BVES also began installing additional fault indicators (FIs) in its system. FIs are installed at specific distances along a circuit and at major branch lines so that when a fault occurs, the fault zone (where the fault occurred) is minimized, thereby reducing time to locate and identify the fault and, therefore, restore service to affected customers. BVES already had 110 FIs in its system. In 2022, BVES installed 99 FIs under this initiative and will install an additional 30 FIs in 2023 to complete the project.

Mid-2022, BVES-initiated a pilot program to install an Online Diagnostic System, which uses continuous monitor sensors to provide usable grid insight information that is measured, reported, and documented, on one of its circuits. The system is designed to pinpoint irregularities, which may be due to degrading/imminent hardware failures, as well as identify objects such as vegetation contacting the lines. This will assist BVES in rapidly inspecting potential problems before they develop into an ignition source. Bear Valley anticipates completing this pilot project in 2023.

3. **Grid Design and System Hardening:** Bear Valley achieved a significant amount of system hardening to mitigate ignitions, reduce consequence of wildfires, and minimize PSPS event impacts during the 2020-2022 WMP period. By the end of 2022, BVES achievements included the following:

- Completed a covered conductor pilot program (finished in 2020), which evaluated various covered conductor products.
- Replaced of 30.2 bare wire circuit miles with covered conductors.
- Replaced all expulsion fuses (a total of 3,114) with 2,578 current limiting fuses and 536 electronic fuses.
- Completed technical and safety updates to the Pineknot Substation.
- Completed technical and safety updates to the Palomino Substation.
- Completed its evacuation route hardening pilot program, which validated the installation and efficacy of wire mesh wrap, fire resistant composite pole, and lightweight steel poles.
- Hardened all three primary evacuation routes to the Big Bear Lake and Big Bear City areas by installing a wire mesh wrap on 997 wood poles.
- Assessed a total of 3,641 poles.
- Replaced or remediated a total of 1,340 poles.
- Removed 644 tree attachments (563 remain to be removed).
- Installed a fiber optic network in its service area that will serve at the backbone for significant grid automation and situational awareness projects to enhance protective systems for safety and provide grid resiliency.

- Installed Fault Localization Isolation and Service Restoration (FLISR) system on its sub-transmission system.
- Replaced its three primary sub-transmission system auto-reclosures with Pulse Condition IntelliRupters.
- Connected into Supervisory Control and Data Acquisition (SCADA) via the fiber network and automated three substations.

Bear Valley's plan to replace the Radford Line, a bare wire sub-transmission line that operates at 34.5 kV with a capacity of 8 MW and consists of 95 wood poles, with high-performance covered conductor and fire resistant (ductile iron) poles because it is located in the HFTD 3 (extreme fire risk), was not completed during this WMP cycle due to the US Forest Service (USFS) not yet approving the permit. The project is delayed and BVES is working with the USFS to gain approval of the project and currently projects completing the project in 2024.

These grid hardening efforts have reduced the risk of ignitions, consequences of wildfires, risk of invoking PSPS, impact of potential PSPS events, and built a strong foundation for further grid design and hardening efforts in BVES's next WMP cycle.

4. **Asset Management and Inspections:** During this WMP cycle, Bear Valley introduced a number of advanced technology inspection techniques beyond those required by GO-165 inspection compliance requirements (Detailed Inspections, Patrol Inspections, and Intrusive Pole Inspections).

BVES established the following highly effective state-of-the-art inspection programs:

- Annual LiDAR surveys of all overhead circuits in its service area.
 - Annual Unmanned Aerial Vehicle (UAV) HD Photography and videography of all overhead circuits in its service area.
 - Annual UAV thermography of all overhead circuits in its service area.
 - Annual independent third-party patrol inspection of all overhead circuits in its service area.
 - Bear Valley also initiated a formal asset management quality assurance and quality control program aimed at grid hardening work as well as asset inspections. Additionally, BVES significantly upgraded its asset management enterprise system in terms of capability, geospatial data, and staff training on employing the system to enhance asset management activities.
5. **Vegetation Management and Inspections:** During the 2020-2022 WMP Cycle, Bear Valley focused on executing its enhanced vegetation management program, removing hazard-threat trees, introducing a number of advanced technology state-of-the-art inspection techniques beyond those required by GO-165 inspection compliance requirements (Detailed Inspections and Patrol Inspections). The following are some highlights of vegetation management achievements:
 - Annual LiDAR surveys of all overhead circuits in its service area.
 - Annual UAV HD Photography and videography of all overhead circuits in its service area.

- Annual independent third-party patrol inspection of all overhead circuits in its service area.
- Established having a full-time contracted Forester on staff.
- Removed 432 hazard-threat trees.
- Trimmed 18,417 trees to enhanced vegetation management specifications.
- Performed 270 vegetation management quality checks.
- Performed 10 vegetation management audits.

In 2020, vegetation density within a 24-foot corridor along all overhead (“OH”) lines was 25.44 percent as measured by LiDAR surveys. In 2022, the vegetation density was 20.17 percent, indicating that the overall density of vegetation along BVES’s lines have been reduced by 20.7 percent.

Bear Valley also improved its formal quality assurance and quality control program aimed at vegetation management work as well as vegetation management inspections. Additionally, BVES significantly upgraded its vegetation management enterprise system in both terms of capability, geospatial data, and staff training on employing the system to enhance asset management activities.

- 6. Grid Operations and Operating Protocols:** BVES developed and implemented operational changes based on weather conditions to reduce the risk of ignitions. The operational changes are escalatory, with the invoking of a PSPS as the action of last resort. BVES determined that during high fire threat weather, it is prudent and efficient for BVES to suspend work, by BVES staff or its contractors that might produce sparks or create fire hazards. Due to BVES’s small size, BVES and its contractors are able to pivot to other low-risk work during such conditions. Bear Valley refined its protocols for re-energization following a PSPS event to restore service in a safe and as rapid manner. Staff were trained on these protocols which were exercised during functional and table-top exercises for PSPS events. BVES also determined the areas most likely to experience a PSPS event during high threat fire weather conditions. BVES then developed the ability to isolate these areas from its system such that only customers in these high-risk areas would be impacted by a PSPS event.
- 7. Data Governance:** BVES made significant progress in migrating its many databases, which were mostly in spreadsheets, to a centralized geographic data repository. BVES engaged the support of a consultant to identify gaps and make recommendations for methods to address its Geographic Information Systems (GIS) process and to immediately update the records in the required format. This initiative resulted in developing a common data definition, increase digitization of field work activities, and update system interfaces to automate data flow into GIS for Energy Safety reporting. Using the Energy Safety GIS Data Reporting Requirements and Schema as a guide, initial data governance steps were taken to define the system of record and assessing initial data quality for each of the required feature datasets in the Office of Energy Infrastructure Safety (OEIS) schema.
- 8. Resource Allocation Methodology:** As previously discussed, BVES conducts its overall risk-based decision-making in accordance with CPUC Decision D.19-04-020 of May 6, 2019, which provides the framework that the Small and Multi-jurisdictional Utilities (SMJUs) are required to follow. Using this framework BVES calculated Risk Spend Efficiencies (RSEs)

and utilized the RSEs in the initiative selection process. BVES was able to successfully allocate sufficient resources to achieve WMP initiatives. No WMP initiatives during this period were not achieved due to inadequate resourcing.

9. **Emergency Planning and Preparedness:** During this WMP cycle, BVES updated its Emergency and Disaster Response Plan (EDRP) and its PSPS Procedures. Additionally, BVES worked with stakeholders to improve coordination on PSPS and emergency response. BVES conducted PSPS table-top exercises and functional drills with excellent stakeholder participation. Also, BVES took a number of effective steps to ensure its workforce is well positioned to conduct restoration efforts. Additionally, BVES established routine briefings for the public and local government, agencies, and other key stakeholders (utilities, communications companies, etc.) to better coordinate emergency planning and preparedness. BVES also implemented a survey program to assess the effectiveness of its outreach programs so that it may improve its messaging. During this period, BVES established special customer service and assistance procedures to assist customers during any wildfire recovery.
10. **Stakeholder Cooperation and Community Engagement:** BVES developed a comprehensive community outreach program and made significant efforts to identify and engage key community stakeholders. These programs are maturing and will serve BVES well in further advancing its outreach programs and coordination with stakeholders. BVES developed and implemented a plan to better service Access and Functional Needs (AFN) customers in the event of a PSPS and made significant progress in identifying AFN customers. Additionally, BVES has put in place a process to identify AFN customers during new customer sign up and periodically throughout the year because the AFN population is not static. BVES has identified all key stakeholders including those that own and operate critical infrastructure and has developed primary, secondary, and tertiary points of contact.

BVES also implemented a Stakeholder Portal on its website to communicate more efficiently with stakeholders during PSPS events. BVES engaged with other utilities outside California on best practices and cooperation on wildfire mitigation and PSPS issues. This has been done primarily through participation at several major transmission and distribution (T&D) conferences. Additionally, BVES has provided other utilities outside of California information on wildfire mitigation initiatives upon request. BVES has been coordinating with various stakeholders for years including Big Bear Fire Department (BBFD), CAL FIRE, the USFS, county fire authorities, mutual aid organizations and more. BVES improved information sharing and coordination with these organizations and others. BVES implemented an initiative that provides BBFD, Sheriff, and California Highway Patrol (CHP) the iRestore App, which enables first responders to report directly into BVES's dispatch using their mobile devices (phone) with a picture of the situation and the geo-coordinates for the location. By reporting this way, BVES will have the phone number of the first responder making the report and BVES dispatch will be able to discuss the issue further with the first responder.

1.2 Summary of 2023–2025 Base WMP

The electrical corporation must summarize the primary goal, plan objectives, and framework for the development of the WMP for the three-year cycle. The electrical corporation may use a combination of brief narratives and bulleted lists.

The primary objective of the WMP is to ensure that BVES constructs, maintains, and operates its electric lines and equipment in a manner that minimizes the risk of catastrophic wildfire posed by and to its lines and equipment. Additionally, the WMP helps to ensure BVES is compliant with all applicable regulations and statutes. Finally, an objective of the WMP is to assist BVES in its goal to continue to provide customers with safe delivery of service at competitive rates and maintain its role as a valued partner in the community it serves by promoting public safety.

BVES's WMP aims to reduce threats of utility-caused wildfires by eliminating sources of ignition and, in the event of a wildfire affecting the BVES service area, to provide emergency response and restoration actions regardless of cause. Another objective of BVES's WMP is to minimize the need to activate disruptive PSPS events. BVES seeks to fulfill the requirements detailed in PUC Section 8386 and associated statutes by identifying wildfire risks and risk drivers within the BVES service territory; providing an overview of strategies, protocols, plans, and programs to mitigate wildfires; tracking metrics to monitor performance of the WMP's initiatives; ensuring the performance of quality control and assurances of completed work; and setting forth protocols for communicating with customers and public safety partners throughout wildfire mitigation, PSPS, and emergency events. The following objectives are categorized by timeframe: objectives to accomplish within the next three years and within the next ten years.

The following summarize Bear Valley's three-year objectives for the 2023-2025 WMP:

- Replace all sub-transmission (34.5 kV) overhead bare conductors with covered conductors. Complete the Radford Line Replacement Project.
- Assess and remediate all sub-transmission (34 kV) poles.
- Harden secondary evacuation routes in highest risk areas.
- Remove all tree attachments from high-risk areas.
- On a priority basis, automate substations, switches, field devices, and fuse TripSavers and connect to SCADA.
- Replace capacitor banks and connect to SCADA.
- Pursue development and execution of the Bear Valley Solar Energy Project.
- Pursue development and execution of the Bear Valley Energy Storage Project.
- Upgrade highest risk substations.
- Continue robust asset inspection routine of annual Detailed Inspections, Patrol Inspections, LiDAR surveys, UAV HD Photography & thermography, 3rd party Ground Patrols, intrusive pole testing, and substation inspections.
- Implement robust asset management and inspection enterprise system.
- Improve quality assurance and quality control program on asset work and asset inspection.
- Continue robust vegetation inspection routine of annual Detailed Inspections, Patrol Inspections, LiDAR surveys, UAV HD Photography & thermography, 3rd party Ground Patrols, intrusive pole testing, and substation inspections.
- Implement robust vegetation management and inspection enterprise system. Ensure all trees within the right-of-way are tracked in the data system.

- Improve quality assurance and quality control program on vegetation management inspection and clearance work and asset inspection.
- Develop and implement program to promote vegetation communities that are sustainable, fire-resilient, and compatible with the use of the land as an electrical corporation right-of-way.
- Complete online diagnostic pilot program and evaluate effectiveness.
- Complete installation of fault indicators (FIs). Evaluate need for additional FIs.
- Evaluate need for additional weather stations.
- Evaluate need for additional HD Alert Cameras.
- Develop and implement Fire Potential Index.
- Improve staff proficiency in utilizing advanced fire threat weather forecasting tools.
- Improve staff training on emergency and disaster response plan through a combination of classroom instruction, table-top exercises, and functional drills.
- Increase coordination with community stakeholders in emergency response.
- Develop robust lines and layers of communications with stakeholders and customers.
- Integrate plan to restore service after an outage due to a wildfire or PSPS event.
- Establish strong programs, systems, and protocols to support residential and non-residential customers in wildfire emergencies and PSPS events.
- Continue to deploy and improve public outreach and education awareness program(s) for wildfires; outages due to wildfires, PSPS events, and protective equipment and device settings; service restoration before, during, and after the incidents and vegetation management. Evaluate effectiveness of outreach efforts.
- Continue to improve program to understand, evaluate, design, and implement wildfire and PSPS risk mitigation strategies, policies, and procedures specific to AFN customers. Evaluate effectiveness of these efforts.
- Work with stakeholders to develop and integrate plans, programs, and policies for collaborating with communities on local wildfire mitigation planning, such as wildfire safety elements in general plans, community wildfire protection plans, and local multi-hazard mitigation plans. Evaluate effectiveness of these collaborative efforts.
- Continue to be proactive in sharing and integration of best practices and collaborating with other electrical corporations on technical and programmatic aspects of WMP programs.

The following summarize Bear Valley's ten-year objectives for the 2023-2025 WMP:

- Replace all high and medium risk distribution (4 kV) overhead bare conductors with covered conductors.
- Assess and remediate all high and medium risk distribution (4 kV) poles.
- Harden secondary evacuation routes.
- Remove all tree attachments from distribution system.

- Automate remaining substations, switches, field devices, and fuse TripSavers and connect to SCADA.
- Replace remaining capacitor banks and connect to SCADA.
- Pursue other renewable generating facility opportunities.
- Pursue other energy storage project opportunities.
- Assess emerging technologies aimed at early detection of asset degradation, wire down detection, and other ignition prevention/mitigation technologies.
- Assess other emerging sub-transmission and distribution inspection techniques.
- Implement social media and other effective platforms to increase public outreach and education awareness program(s) for wildfires; outages due to wildfires, PSPS events, and protective equipment and device settings; service restoration before, during, and after the incidents and vegetation management. Evaluate effectiveness of these outreach efforts.
- Establish streamlined routine for sharing lessons learned and best practices among peers.
- Continue to conduct program to promote vegetation communities that are sustainable, fire-resilient, and compatible with the use of the land as an electrical corporation right-of-way.
- Evolve vegetation inspection cycles to be risk-based.
- Evolve vegetation clearance cycles to be risk-based.
- Evaluate effectiveness of installing cameras, infrared detectors, LiDAR instruments, and other technologies on overhead assets to provide remote monitoring.
- Integrate EDRP with stakeholder emergency response plans.
- Evaluate increased use of social media and technology to improve and streamline communications with stakeholders and customers.
- Implement social media and other effective platforms to increase public outreach and education awareness program(s) for wildfires; outages due to wildfires, PSPS events, and protective equipment and device settings; service restoration before, during, and after the incidents and vegetation management. Evaluate effectiveness of these outreach efforts.
- Establish streamlined routine for sharing lessons learned and best practices among peers.

BVES recognizes there is still substantial work to be performed in wildfire mitigation and room for improvement and, therefore, has developed its 2023-2025 WMP to continue to make substantial progress in wildfire mitigation and address areas of weakness.

2. Responsible Persons

The electrical corporation must list those responsible for executing the WMP, including:

- Executive-level owner with overall responsibility
- Program owners with responsibility for each of the main components of the plan
- As applicable, general ownership for questions related to or activities described in the WMP

Titles, credentials, and components of responsible person(s) must be released publicly. Electrical corporations can reference the WMP Process and Evaluation Guidelines and California Code of Regulations Title 14 section 29200 for the submission process of any confidential information.

Executive-Level Owner with Overall Responsibility

The following Executive-Level contact is ultimately responsible for monitoring and execution of the BVES WMP:

Name and title: Paul Marconi, President, Treasurer, & Secretary BVES is responsible for the overall management of BVES and is directly responsible for ensuring all WMP elements are executed as intended. The President, Treasurer, & Secretary shall provide the Board of Directors' Safety and Operations Committee periodic updates on safety issues, plan execution; identify any problems, delays in schedule, and resource shortfalls; and propose solutions to issues and problems. The President, Treasurer & Secretary shall also keep the Vice President, Regulatory Affairs of Golden States Water Company (GSWC) informed of all compliance and regulatory affairs issues regarding the plan. The President, Treasurer, & Secretary shall communicate the WMP to BVES staff and hold staff accountable for executing their portions of the WMP including PSPS activation decisions. The President, Treasurer, & Secretary shall ensure the applicable portions of the WMP is communicated to local government and agencies, key stakeholders, customers, and the public. The President, Treasurer, & Secretary is responsible for ensuring lessons learned and metrics from the current WMP are incorporated into future WMPs as appropriate.

Program Owners Specific to Each Section of the Plan

Key utility staff execute and implement this WMP working closely with public safety, local agencies and governments, fire, forestry management, first responders, and customers to enable information dissemination to vested stakeholders. BVES also retains experienced and qualified third-party contractors to assist in the performance of the WMP. BVES Table 2-1, shown below, outlines leadership roles regarding implementation and monitoring of the WMP and their relevant responsibilities.

BVES Table 2-1 WMP Responsible Persons

Name	Title	Email	Phone Number	Component
Section 1: Executive Summary				
Paul Marconi	President, Treasurer, & Secretary	Paul.Marconi@bvesinc.com	909.866.4678 x100 909-202-9539	Entire Section

Name	Title	Email	Phone Number	Component
Section 2: Responsible Persons				
Jon Pecchia	Utility Manager	Jon.Pecchia@bvesinc.com	909.866.4678 x102 909.253.8966	Entire Section
Section 3: Statutory Requirement Checklist				
Jon Pecchia	Utility Manager	Jon.Pecchia@bvesinc.com	909.866.4678 x102 909.253.8966	Entire Section
Section 4: Overview of WMP				
Paul Marconi	President, Treasurer, & Secretary	Paul.Marconi@bvesinc.com	909.866.4678 x100 909-202-9539	Entire Section
Section 5: Service Territory				
Tom Chou	Utility Engineer & Wildfire Mitigation Supervisor	Tom.Chou@bvesinc.com	909.273.8009	Section 5.1 - 5.2
Jared Hennen	Fire Mitigation & Reliability Engineer	Jared.Hennen@bvesinc.com	909.255.2948	Section 5.3
Jon Pecchia	Utility Manager	Jon.Pecchia@bvesinc.com	909.866.4678 x102 909.253.8966	Section 5.4
Section 6: Risk Methodology ad Assessment				
Paul Marconi	President, Treasurer, & Secretary	Paul.Marconi@bvesinc.com	909.866.4678 x100 909-202-9539	Entire Section
Section 7: Wildfire Mitigation Strategy and Development				
Paul Marconi	President, Treasurer, & Secretary	Paul.Marconi@bvesinc.com	909.866.4678 x100 909-202-9539	Entire Section
Section 8: Wildfire Mitigations				
Paul Marconi	President, Treasurer, & Secretary	Paul.Marconi@bvesinc.com	909.866.4678 x100 909-202-9539	Entire Section
Tom Chou	Utility Engineer	Tom.Chou@bvesinc.com	909.273.8009	Section 8.1
Jared Hennen	Reliability Engineer	Jared.Hennen@bvesinc.com	909.255.2948	Section 8.2

Name	Title	Email	Phone Number	Component
Jon Pecchia	Utility Manager	Jon.Pecchia@bvesinc.com	909.866.4678 x102 909.253.8966	Section 8.4
Sean Matlock	Energy Resource Manager	Sean.Matlock@bvesinc.com	909.522.1913	Section 8.5
Section 9: Public Safety Power Shutoff				
Sean Matlock	Energy Resource Manager	Sean.Matlock@bvesinc.com	909.522.1913	Entire Section
Section 10: Lessons Learned				
Paul Marconi	President, Treasurer, & Secretary	Paul.Marconi@bvesinc.com	909.866.4678 x100 909-202-9539	Entire Section
Section 11: Corrective Action Program				
Jon Pecchia	Utility Manager	Jon.Pecchia@bvesinc.com	909.866.4678 x102 909.253.8966	Entire Section
Section 12: Notices of Violation and Defect				
Jon Pecchia	Utility Manager	Jon.Pecchia@bvesinc.com	909.866.4678 x102 909.253.8966	Entire Section

3. Statutory Requirement Checklist

This section provides a checklist of the statutory requirements for a WMP as detailed in Public Utilities Code section 8386(c). By completing the checklist, the electrical corporation affirms that its WMP addresses each requirement.

For each statutory requirement, the checklist must include a reference and hyperlink to the relevant section and page number in the WMP. Where multiple WMP sections provide the information for a specific requirement, the electrical corporation must provide references and hyperlinks to all relevant sections. Unique references must be separated by semicolons, and each must include a brief summary of the contents of the referenced section (e.g., Section 5, pp. 30–32 [workforce]; Section 7, p. 43 [mutual assistance]).

BVES affirms its WMP addresses each statutory requirement in accordance with Public Utilities Code section 8386(c). Table 3-1 provides a checklist of each statutory requirement BVES must adhere to. References to relevant hyperlinks and page numbers within the WMP are provided for each statutory requirement in the table below.

Table 3-1 Statutory Requirements Checklist

PUC Section 8386	Description	WMP Section
(a)	Each electrical corporation shall construct, maintain, and operate its electrical lines and equipment in a manner that will minimize the risk of catastrophic wildfire posed by those electrical lines and equipment.	Section 5, p. 25 [infrastructure] Section 7, p. 63-65 [risk mitigation]
(b)	Each electrical corporation shall annually prepare and submit a wildfire mitigation plan to the Wildfire Safety Division for review and approval. The plan shall cover at least a three-year period.	Section 1, p. 7-10
(c) (1)	Provide list of persons responsible for executing the WMP and each members responsibility in the process.	Section 2, p. 11-13
(c) (2)	The objectives of the WMP	Section 4.1, p. 19
(c) (3)	A description of the preventative strategies and programs to be adopted by BVES to minimize the risk of its electrical lines and equipment causing catastrophic wildfires, including consideration of dynamic climate change risks.	Section 6, p. 48-51 [risk of catastrophic wildfires] Section 7, p. 62-69 [risk evaluation and prioritization]

PUC Section 8386	Description	WMP Section
(c) (4)	A description of the metrics BVES plans to use to evaluate the plan's performance and the assumptions that underlie the use of those metrics.	Section 6, p. 46-48
(c) (5)	A discussion of how the application of previously identified metrics to previous plan performances has informed the plan.	Section 6, p. 42 [overview of plan] Section 8, p. 176-180 [QA/QC] Section 11, p. 308-313 [corrective action program]
(c) (6)	A description of BVES's protocols for disabling reclosers and de-energizing portions of the electrical distribution system that consider the associated impacts on public safety. As part of these protocols, each electrical corporation shall include protocols related to mitigating the public safety impacts of disabling reclosers and de-energizing portions of the electrical distribution system that impacts critical first responders.	Section 8, p. 214-215
(c) (7)	A description of BVES's appropriate and feasible procedures for notifying a customer who may be impacted by the de-energizing of electrical lines, including procedures for those customers receiving medical baseline allowances. The procedures shall direct notification to all public safety offices, critical first responders, health care facilities, and operators of telecommunications infrastructure with premises within the footprint of potential de-energization for a given event. The procedures shall comply with any orders of the	Section 8.4.4.1, p. 250-252

PUC Section 8386	Description	WMP Section
	Commission regarding notifications of de-energization events.	
(c) (8)	Identification of circuits that have frequently been de-energized pursuant to a de-energization event to mitigate the risk of wildfire and the measures taken, or planned to be taken, by BVES to reduce the need for, and impact of, future de-energization of those circuits, including, but not limited to, the estimated annual decline in circuit de-energization and de-energization impact on customers, and replacing, hardening, or undergrounding any portion of the circuit or of upstream transmission or distribution lines.	Section 4, p. 20 [proposed expenditures] Section 8, p. 125 [circuit breakers] p. 275-276 [discussion of frequently de-energized circuits]
(c) (9)	Plans for vegetation management.	Section 7, p. 77-78 [3 and 10-year plans for vegetation management] Section 8, p. 150-185 [vegetation management and inspection]
(c) (10)	Protocols for the PSPS of BVES's transmission infrastructure, etc.	Section 5, p. 38-40
(c) (11)	A description of BVES's protocols for the de-energization of BVES's transmission infrastructure, for instances when the de-energization may impact customers who, or entities that, are dependent upon the infrastructure. The protocols shall comply with any order of the Commission regarding de-energization events.	Section 4, p. 20-23 [risk-informed framework used] Section 8, p. 215-216 [emergency preparedness]
(c) (12)	A list that identifies, describes, and prioritizes all wildfire risks, and drivers for those risks, throughout BVES's service territory such	Section 7, p. 66-69 [prioritized list of risks] Section 8, p. 100-117 [planned activities and associated risks]

PUC Section 8386	Description	WMP Section
	as those risks and risk drivers associated with design, construction, operations, and maintenance of BVES's equipment and facilities as well as risks and risk drivers associated with topographic and climatological risk factors.	
(c) (13)	A description of how the plan accounts for the wildfire risk identified in BVES's Risk Assessment Mitigation Phase filing.	Section 6, p. 44-46 [accounting for wildfire risk] Section 7, p. 71 [Risk Assessment Mitigation Phase filing]
(c) (14)	A description of the actions BVES will take to ensure its system will achieve the highest level of safety, reliability, and resiliency, and to ensure that its system is prepared for a major event, including hardening, and modernizing its infrastructure with improved engineering, system design, standards, equipment, and facilities, such as undergrounding, insulating of distribution wires, and replacing poles.	Section 5, p. 37-39 [actions to be taken to ensure emergency preparedness] Section 8, p. 100-117 [planned activities and expected system impacts]
(c) (15)	A description of where and how BVES considered undergrounding electrical distribution lines within those areas of its service territory identified to have the highest wildfire risk in a Commission fire threat map.	Section 8.1.2.2, p. 134
(c) (16)	A showing that BVES has an adequately sized and trained workforce to promptly restore service after a major event, taking into account employees of other utilities pursuant to mutual aid agreements and employees of entities that have entered into contracts with BVES.	Section 7, p. 65-66 [stakeholder roles for decision making] Section 8, p. 138-149, p. 179-185 [workforce planning]
(c) (17)	Identification of any geographic area in BVES's	Section 5.3.3, p. 30 Section 6.4.1.1, p. 74

PUC Section 8386	Description	WMP Section
	service territory that is a higher wildfire threat than is currently identified in a Commission fire threat map, and where the Commission should consider expanding the high fire threat district based on new information or changes in the environment.	
(c) (18)	Methodology for identifying and presenting enterprise-wide safety risk and wildfire-related risk that is consistent with other electrical corporations.	Section 6, p. 57
(c) (19)	A description of how the WMP is consistent with BVES's disaster and emergency preparedness plan prepared pursuant to Public Utilities Code section 768.6, including plans to restore service and community outreach.	Section 7, p. 74-83 [wildfire mitigation strategy] Section 8, p. 260-273 [community outreach and engagement]
(c) (20)	A statement of how BVES will restore service after a wildfire.	Section 8, p. 253-256 [planning for service restoration] Section 9, p. 293-295 [allocation of resources for service restoration]
(c) (21)	Protocols for supporting customers during and after a wildfire, outage reporting, supporting low-income customers, billing adjustments, deposit waivers, extended payment plans, suspension of disconnection and nonpayment fees, repair processing and timing, access to electrical corporation representatives, and emergency communications.	Section 5, p. 38-39 [communities at risk from wildfire] Section 8, p. 259-261 [customer support in wildfire and PSPS emergencies]
(c) (22)	Description of the processes and procedures used to monitor and audit the WMP, identify and correct WMP deficiencies, and assess the	Section 1, p. 1-10 [summary of WMP cycles] Section 8, p. 117-123 [asset inspections]

PUC Section 8386	Description	WMP Section
	effectiveness of electrical line and equipment inspections.	Section 10, p. 296-307 [lessons learned]
(c) (23)	Provide a list of persons responsible for executing the WMP and each members responsibility in the process.	Section 2, p. 11-13

4. Overview of WMP

4.1 Primary Goal

Each electrical corporation must state the primary goal of its WMP. At a minimum, the electrical corporation must affirm its compliance with California Public Utilities Code section 8386(a):

Each electrical corporation shall construct, maintain, and operate its electrical lines and equipment in a manner that will minimize the risk of catastrophic wildfire posed by those electrical lines and equipment.

The primary objective of the WMP is to ensure that BVES constructs, maintains, and operates its electric lines and equipment in a manner that minimizes the risk of catastrophic wildfire posed by, and to, its lines and equipment. Additionally, the WMP seeks to ensure BVES is compliant with all applicable regulations and statutes. Finally, the WMP intends to assist BVES in its goal to continue to provide customers with safe delivery of service at competitive rates and maintain its role as a valued partner in the community it serves by promoting public safety.

BVES's WMP aims to reduce threats of utility-caused wildfires by eliminating sources of ignition, and to increase resilience of BVES's assets and provide emergency response, in the event of a wildfire affecting the BVES service area, and restoration actions regardless of cause. Another objective of BVES's WMP is to minimize the need to activate PSPS events. Through its WMP, BVES seeks to fulfill the requirements detailed in PUC Section 8386 and associated statutes by identifying wildfire risks and risk drivers within the BVES service territory; providing an overview of strategies, protocols, plans, and programs to mitigate wildfires; tracking metrics to monitor performance of the WMP's initiatives; ensuring the performance of quality control and assurances of completed work; and setting forth protocols for communicating with customers and public safety partners throughout wildfire mitigation, PSPS, and emergency events.

BVES identifies its objectives as categorized by timeframe: objectives to accomplish before the next annual WMP Update, within the next three years, and within the next ten years.

4.2 Plan Objectives

In this section, the electrical corporation must summarize its plan objectives over the 2023-2025 WMP cycle. Plan objectives are determined by the portfolio of mitigation initiatives proposed in the WMP.

Over the course of 2023-2025 WMP cycle, the primary objective of BVES is to continue to reduce wildfire risks through the execution of its grid hardening initiatives, risk assessment and prioritization, and improve the leveraging of enhanced situational awareness and weather monitoring capabilities. For grid hardening, BVES will continue to replace bare wire with covered wire in the highest risk areas and harden every main evacuation route as its highest objectives. Regarding situational awareness, goals include continued improvement through BVES's contracted meteorologist, Technosylva near-real-time fire risk assessment applications and weather stations, improving coordination and communication with stakeholders, employing forecasting capabilities through fire predictive live models, and continuing aggressive vegetation management and inspection. BVES also plans to continue to enhance its data collection and handling. BVES will continue to improve its workforce readiness through recruitment, training, and the strategic use of consultants to supplement BVES staff.

The following list provides greater detail to the objectives over the 2023-2025 WMP cycle:

- Replace all sub-transmission (34.5 kV) overhead bare conductors with covered conductors. Complete the Radford Line Replacement Project.
- Assess and remediate all sub-transmission (34 kV) poles.
- Harden secondary evacuation routes in highest risk areas.
- Remove all tree attachments from high-risk areas.
- On a priority basis, automate substations, switches, field devices, and fuse TripSavers and connect to SCADA.
- Replace capacitor banks and connect to SCADA.
- Pursue development and execution of the Bear Valley Solar Energy Project.
- Pursue development and execution of the Bear Valley Energy Storage Project.
- Upgrade highest risk substations.
- Continue robust asset inspection routine of annual Detailed Inspections, Patrol Inspections, LiDAR surveys, UAV HD Photography & thermography, 3rd party Ground Patrols, intrusive pole testing, and substation inspections.
- Implement robust asset management and inspection enterprise system.
- Improve quality assurance and quality control program on asset work and asset inspection.
- Continue robust vegetation inspection routine of annual Detailed Inspections, Patrol Inspections, LiDAR surveys, UAV HD Photography & thermography, 3rd party Ground Patrols, intrusive pole testing, and substation inspections.
- Implement robust vegetation management and inspection enterprise system. Ensure all trees within the right-of-way are tracked in the data system.
- Improve quality assurance and quality control program on vegetation management inspection and clearance work and asset inspection.
- Develop and implement program to promote vegetation communities that are sustainable, fire-resilient, and compatible with the use of the land as an electrical corporation right-of-way.
- Complete online diagnostic pilot program and evaluate effectiveness.
- Complete installation of fault indicators (FIs). Evaluate need for additional FIs.
- Evaluate need for additional weather stations.
- Evaluate need for additional HD Alert Cameras.
- Develop and implement Fire Potential Index.
- Improve staff proficiency in utilizing advanced fire threat weather forecasting tools.
- Improve staff training on emergency and disaster response plan through a combination of classroom instruction, table-top exercises, and functional drills.
- Increase coordination with community stakeholders in emergency response.
- Develop robust lines and layers of communications with stakeholders and customers.

- Integrate plan to restore service after an outage due to a wildfire or PSPS event.
- Establish strong programs, systems, and protocols to support residential and non-residential customers in wildfire emergencies and PSPS events.
- Continue to deploy and improve public outreach and education awareness program(s) for wildfires; outages due to wildfires, PSPS events, and protective equipment and device settings; service restoration before, during, and after the incidents and vegetation management. Evaluate effectiveness of outreach efforts.
- Continue to improve program to understand, evaluate, design, and implement wildfire and PSPS risk mitigation strategies, policies, and procedures specific to AFN customers. Evaluate effectiveness of these efforts.
- Work with stakeholders to develop and integrate plans, programs, and policies for collaborating with communities on local wildfire mitigation planning, such as wildfire safety elements in general plans, community wildfire protection plans, and local multi-hazard mitigation plans. Evaluate effectiveness of these collaborative efforts.
- Continue to be proactive in sharing and integration of best practices and collaborating with other electrical corporations on technical and programmatic aspects of WMP programs.

4.3 Proposed Expenditures

Each electrical corporation must summarize its projected expenditures in thousands of U.S. dollars per year for the next three-year WMP cycle, as well as the planned and actual expenditures from the previous three-year WMP cycle (e.g., 2020–2022), in both tabular and graph form.

Table 4-1 provides an example of the minimum acceptable level of information summarizing an electrical corporation's WMP expenditures. The financials represented in the summary table equal the aggregate spending listed in the financial tables of the QDR (see the Energy Safety Data Guidelines). Energy Safety's WMP evaluation, including approval or denial, must not be construed as approval of, or agreement with, costs listed in the WMP.

BVES's projected expenditures in thousands of US dollars per year for the next three-year WMP cycle, as well as the planned and actual expenditures from the previous three-year WMP cycle (2020-2022) is provided in Table 4-1, below. The financials represented in the table equal the aggregate spending listed in the financial tables of the QDR.

Table 4-1 Summary of WMP Expenditures

Year	Spend (Thousands \$USD)
2020	Planned = \$11,417 Actual = \$9,154 ± Δ = (\$2,262)
2021	Planned = \$15,218 Actual = \$12,088 ± Δ = (\$3,130)
2022	Planned = \$16,109

Year	Spend (Thousands \$USD)
	Actual = \$15,232 $\pm \Delta = (\$877)$
2023	Planned = \$25,852
2024	Planned = \$43,620
2025	Planned = \$18,301

4.4 Risk Informed Framework

The electrical corporation must adopt a risk-informed approach to developing its WMP. The purposes of adopting this approach are as follows:

- To develop a WMP that achieves an optimal level of life safety, property protection, and environmental protection, while also being in balance with other performance objectives (e.g., reliability and affordability)
- To integrate risk modeling outcomes with a range of other performance objectives, methods, and subject matter expertise to inform decision-making processes and the spatiotemporal prioritization of mitigations
- To target mitigation efforts that prioritize the highest-risk equipment, wildfire environmental settings, and assets at risk (e.g., people, communities, critical infrastructure), while still satisfying other performance objectives defined by the California Public Utilities Commission (CPUC) (e.g., reliability and affordability)
- To provide a decision-making process that is clear and transparent to internal and external stakeholders, including clear evaluation criteria and visual aids (such as flow charts or decision trees)

The risk-informed approach adopted by the electrical corporation must, at a minimum, incorporate several key components, described below. In addition, the evaluation and management of risk must include consideration of a broad range of performance objectives (e.g., life safety, property protection, reduction of social vulnerability, reliability, resiliency, affordability, health, environmental protection, public perception, etc.), integrate cross-disciplinary expertise, and engage various stakeholder groups as part of the decision-making process.

The risk-informed approach adopted by BVES incorporates several components displayed in Table 4-2, below. The evaluation and management of risk takes into consideration a range of performance objectives such as reliability, environmental protection, resiliency, property protection, and life safety. Additionally, BVES integrates cross-disciplinary expertise into its evaluation and management of risk process. Lastly, BVES engages various stakeholder groups as part of the decision-making process.

Table 4-2 Risk-Informed Approach Components

Risk-Informed Approach Component	Brief Description
1. Goals and Objectives	The first step in the risk-informed approach is to identify the primary goal and objectives of BVES WMP. The overall risk reduction objectives of the WMP are specific to BVES and are defined in Section 4.2.
2. Scope of Application (i.e., electrical corporation service territory)	Next, BVES defines the physical characteristics of the system in terms of its major elements: utility service area characteristics, electrical infrastructure,

Risk-Informed Approach Component	Brief Description
	wildfire environmental settings, and various assets at risk (e.g., communities and people, property, critical infrastructure, cultural/historical resources, environmental services). Knowledge and understanding of how individual system elements interface are essential to this step. Sections 5–5.4 provide details on what BVES presents regarding physical traits, environmental characteristics, and potential assets at risk in their service territory.
3. Hazard Identification	The third step is to identify hazards and determine their likelihoods. Section 6.2.1 provides an overview of BVES hazard identification.
4. Risk Scenario Identification	The fourth step, based on the context and desired values, is for BVES to develop risk scenarios that could lead to an undesirable event. Risk scenario techniques that may be employed include event tree analysis, fault tree analysis, preliminary hazard analysis, and failure modes and effects analysis. Section 6.3 provides instructions on risk scenario identification.
5. Risk Analysis (i.e., likelihood and consequences)	The fifth step is to evaluate the likelihood and consequences of the identified risk scenarios to understand the potential impact on the desired goals and objectives. The consequences are based on risk components fundamental to wildfire risk and PSPS event risk, given BVES’s scope of application and portfolio of wildfire mitigation initiatives. Section 6.2.2 provides instructions on the risk analysis.
6. Risk Presentation	The sixth step is to consider how the risk analysis is presented to the stakeholders. Section 6.4 provides details on risk presentation.
7. Risk Evaluation	<p>After the risk analysis is complete, hazards can be resolved by either assuming the risk associated with the hazards or eliminating or controlling the hazards.</p> <p>Risk evaluation includes identification of criteria, processes, and procedures for identifying critical risk - both spatially and temporally. Risk evaluation must also include, as a minimum, evaluating the seriousness,</p>

Risk-Informed Approach Component	Brief Description
	<p>manageability, urgency, and growth potential of the wildfire hazard/risk. Risk evaluation should be used to determine whether the individual hazard/risk should be mitigated. Risk evaluation and risk-informed decision-making should be done using a consensus approach involving a range of key stakeholder groups. Section 7 provides details for BVES risk evaluation process and risk-informed decision-making.</p>
<p>8. Risk Mitigation and Management</p>	<p>In the final step, BVES identifies which risk management strategies are appropriate given practical constraints such as limited resources, costs, and time. BVES indicates the high-level risk management approach, such as preventing the risk or mitigating the risk (i.e., reducing its likelihood and consequences) as determined in Step 7. BVES identifies risk mitigation initiatives (or a portfolio of initiatives) and prioritize their implementation based on both spatial and temporal considerations. This step includes determining which risk mitigation strategies are appropriate and most effectively meet the intent of the WMP goals and objectives, while still in balance with other performance objectives. It also includes the processes, procedures, and monitoring strategies to develop, review, and execute schedules for implementation of mitigation initiatives and activities (as well as interim strategies). Section 8 provides instructions for reporting on initiatives to mitigate identified risks.</p>

5. Overview of the Service Territory

In this section of the WMP, the electrical corporation must provide a high-level overview of its service territory and key characteristics of its electrical infrastructure. This information is intended to provide the reader with an understanding of the physical and technical scope of the electrical corporation's WMP. Sections 5.1 - 5.4 below provide detailed instructions.

5.1 Service Territory

The electrical corporation must provide a high-level description of its service territory, addressing the following components:

- Area served (in square miles)
- Number of customers served

The electrical corporation must provide a geospatial map that shows its service territory (polygons) and distribution of customers served (raster or polygons). This map should appear in the main body of the report.

The following figure

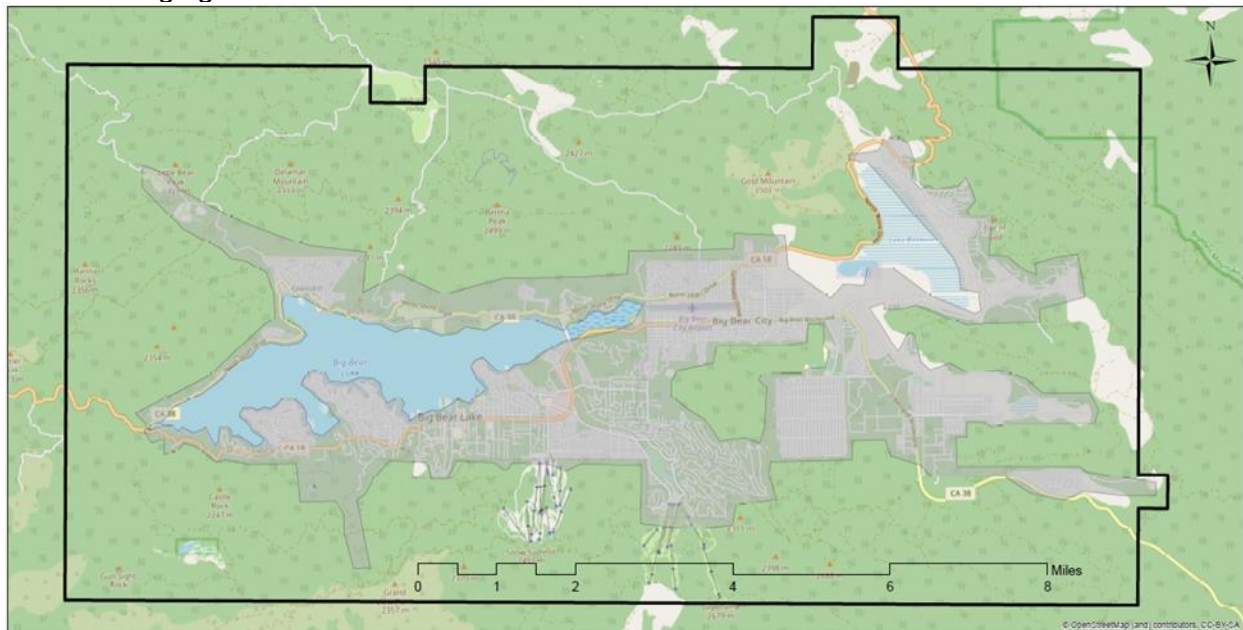

Customers Served



Figure 5-1 and tableTable 5-1 provide a high-level description of BVES's service territory.

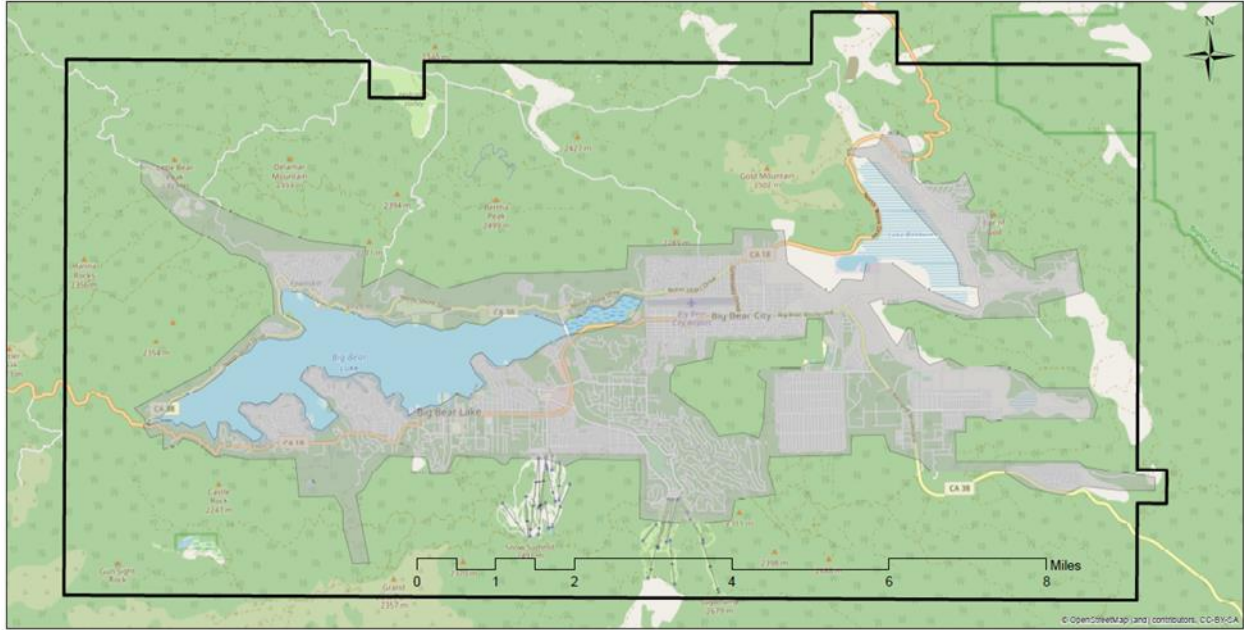

Customers Served

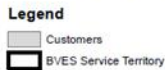

Figure 5-1 Service Territory and Customers Served

Table 5-1 BVES Service Territory Overview

Characteristic	Description
Area Served	32 sq miles
Number of Customers Served	24,691
Number of Counties and Cities Served	1 County (San Bernardino), 1 City (Big Bear Lake)
Total Circuit Miles	267.1
Overhead Circuit Miles	206.7 ²
Underground Circuit Miles	60.4

5.2 Electrical Infrastructure

The electrical corporation must provide a high-level description of its infrastructure, including all power generation facilities, transmission lines and associated equipment, distribution lines and associated equipment, substations, and any other major equipment.

² Post 2023 submission, the BVES Overhead Circuit Miles was adjusted to 205 following GIS review and validation of past undergrounding and grid hardening upgrades.

Table 5-2 Overview of Key Electrical Equipment

Type of Equipment	HFTD	Non-HFTD	Total
Substations (#)	13	0	13
Power Generation Facilities (#)	1	0	1
Overhead, Underground & Hardened Transmission Lines (Circuit Miles)	0	0	0
Overhead Distribution Lines (Circuit Miles)	206.7	0	206.7
Hardened Overhead Distribution Lines (Circuit Miles)	31.45	0	31.45
Underground Distribution Lines (Circuit Miles)	60.4	0	60.4
Distribution Transformers (#)	2902	0	2902
Reclosers (#)	15	0	15
Poles (#)	9,156	0	9,156
Towers (#)	0	0	0
Microgrids (#)	0	0	0

5.3 Environmental Settings

The electrical corporation must provide a high-level overview of the wildfire environmental settings within its service territory.

5.3.1 Fire Ecology

The electrical corporation must provide a brief narrative describing the fire ecology or ecologies across its service territory. This includes a brief description of how ecological features, such as the following, influence the propensity of the electrical corporation's service territory to experience wildfires: generalized climate and weather conditions, ecological regions and associated vegetation types, and fire return intervals.

The electrical corporation must provide tabulated statistics of the vegetative coverage across its service territory. The tabulated data must include a breakdown of the vegetation types, total acres per type, and percentage of service

territory per type. The electrical corporation must identify the vegetative database used to characterize the vegetation (e.g., CALVEG).

BVES's territory comprises the higher elevation and cooler parts of the San Bernardino Mountains. Topographically the area generally consists of north/south facing slopes. Elevation ranges from as low as 4,000 to 10,200 feet. The major ridges generally run east to west, specifically the Sugarloaf Mountain and Holcomb Valley ranges. The mean annual precipitation is about 30 to 40 inches, with the majority in the form of snow in the winter months. Mean annual temperature is about 40 to 50 degrees Fahrenheit. The mean freeze-free period is about 150 to 200 days. Due to Bear Valley's small size its service territory does not consist of multiple ecological regions.

The predominant natural plant community is Jeffery/Ponderosa pine series. There are small areas of coulter pine series, mixed chaparral shrub lands transitioning to the east where there are juniper/pinon woodlands. Some fir and lodgepole pine series are common in the north facing higher elevations. Future breakdown of the vegetation found in the area:

Grasslands: Alpine habitat, beaked sedge, bur-reed, creeping ryegrass, shorthair sedge, sedge, and tufted hair grass series.

Shrub lands: big sagebrush, black sagebrush, bush chinquapin, deer brush, east wood manzanita, green leaf manzanita, interior live oak - chaparral whitethorn, interior live oak - canyon live oak shrub, interior live oak - scrub oak shrub, mixed saltbush, mixed scrub oak, mountain whitethorn, rothrock sagebrush, rubber rabbit brush, scrub oak, and scrub oak - chamise series.

Forests and woodlands: Aspen, black cottonwood, black oak, coulter pine - canyon live oak, curl leaf mountain-mahogany, incense-cedar, Jeffrey pine, ponderosa pine, limber pine, lodgepole pine, mixed conifer, mixed subalpine forest, mountain juniper, single leaf pinon, and white fir series.

A large portion of the Big Bear Valley Wildland-Urban Interface has not burned in well over 105 years and has missed approximately four fire intervals in the conifer or mixed conifer vegetation structure. According to the California Department of Forestry (FRAP) data derived from the United States Forest Service material, 42% of the Big Bear Valley Wildland-Urban Interface is a Fire Regime I; 47% is a Fire Regime III; and 3% is in Fire Regime IV. Even without the drought and tree mortality issues, this is considered high fire hazard conditions with old decadent brush, heavy fuel loadings, and over-densification of trees that have not been comprehensively treated for a number of years.

Table 5-3 Vegetation Types in the Service Territory

Vegetation Type	Acres	Percentage of Service Territory
Short, Sparse Dry Climate Grass	241.7455868	0.41
Low Load, Dry Climate Grass	391.5194723	0.67
Low Load, Dry Climate Grass-Shrub	322.3434777	0.55
Moderate Load, Dry Climate Grass-Shrub	14226.21045	24.18
Low Load Dry Climate Shrub	56.61822526	0.10
Moderate Load Dry Climate Shrub	0.142417401	0.00

Low Load, Humid Climate Timber-Shrub	3493.005658	5.94
High Load, Dry Climate Shrub	460.7446809	0.78
Very High Load, Dry Climate Shrub	4333.899448	7.37
Low Load Dry Climate Timber-Grass-Shrub	151.4796424	0.26
Moderate Load, Humid Climate Timber-Grass-Shrub	6648.109504	11.30
Timber Understory Dynamic ML (TSYL 2022)	8928.199803	15.18
Low Load Compact Conifer Litter	3.069616227	0.01
Low Load Broadleaf Litter	26.38574582	0.04
Timber Litter ML (TSYL 2022)	11072.32054	18.82

5.3.2 Catastrophic Wildfire History

The electrical corporation must provide a brief narrative summarizing its wildfire history for the past 20 years (2002-2022) as recorded by the electrical corporation, CAL FIRE, or another authoritative sources. For this section, wildfire history must be limited to electrical corporation ignited catastrophic fires (i.e., fires that caused at least one death, damaged over 500 structures, or burned over 5,000 acres). This includes catastrophic wildfire ignitions reported to the CPUC that may be attributable to facilities or equipment owned by the electrical corporation and where the cause of the ignition is still under investigation. Electrical corporations must clearly denote those ignitions as still under investigation. In addition, the electrical corporation must provide catastrophic wildfire statistics in tabular form, including the following key metrics:

- Ignition date
- Fire name
- Official cause (if known)
- Size (acres)
- Number of fatalities
- Number of structures damaged
- Estimated financial loss (U.S. dollars)

Table 5 4 provides an example of the content and level of detail required for the tabulated historical catastrophic utility-related wildfire statistics. The electrical corporation must provide an authoritative government source (e.g., CPUC, CAL FIRE, U.S. Forest Service, or local fire authority) for its reporting of wildfire history data and loss/damage estimates, to the extent this information is available.

BVES has not experienced an electrical corporation ignited catastrophic fire, so this section is not applicable to BVES.

Table 5-4 Catastrophic Electrical Corporation Wildfires

Ignition Date	Fire Name	Official Cause	Fire Size (acres)	No. of Fatalities	No. of Structures Destroyed and Damaged	Financial Loss (US\$)
N/A	N/A	N/A	N/A	N/A	N/A	N/A

The electrical corporation must also provide a map or set of maps illustrating the catastrophic wildfires. One representative map must appear in the main body of the WMP, with supplemental or detailed maps provided in Appendix C as needed. The maps must include the following:

- *Fire perimeters*
- *Legend and text labeling each fire perimeter*
- *County lines*

BVES has not experienced an electrical corporation ignited catastrophic fire, so this section is not applicable to BVES.

5.3.3 High Fire Threat Districts

The electrical corporation must provide a brief narrative identifying the CPUC-defined HFTD across its territory. The electrical corporation must also provide a map of its service territory overlaid with the HFTD. The map must be accompanied by tabulated statistics on the CPUC-defined HFTD including the following minimum information:

- *Total area of the electrical corporation's service territory in the HFTD (sq. mi.)*
- *The electrical corporation's service territory in the HFTD as a percentage of its total service territory (%)*

For the HFTD map, the HFTD layer(s) (raster or polygon) must cover the electrical corporation's service territory and the HFTD layer must match the latest boundaries as published by the CPUC.

BVES's entire service territory falls within the HFTD designation. The territory primarily contains HFTD Tier 2 with a small portion of Tier 3. The only asset that falls within the Tier 3 designation is the Radford Line, which is a sub-transmission line that supplies electric power from Southern California Edison's (SCE) system and operates at 34.5 kV and serves at a maximum capacity of 5 MWs. The following figure and table provide further detail to the breakdown of HFTD in Bear Valley's service territory.

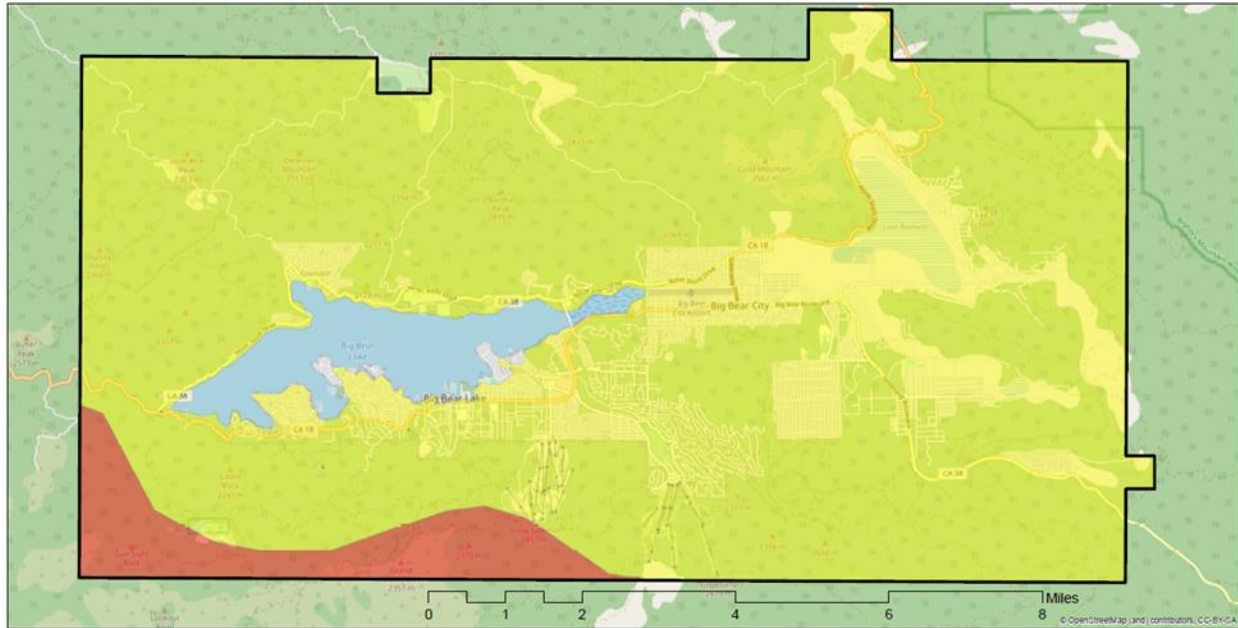

HFTDs in Service Territory

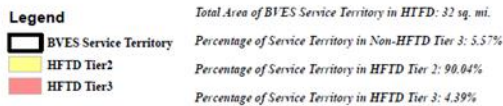

Figure 5-2 HFTD Tier Breakdown for the Service Territory

Table 5-5 Electrical Corporation’s HFTD Statistics

High Fire Threat District	Total Area of Individual District (sq. mi.)	% of Total Service Territory
Non-HFTD ³	1.7824	5.57%
Tier 2	28.8128	90.04%
Tier 3	1.4048	4.39%
Total	32	100%

5.3.4 Climate Change

It is critical for the electrical corporation to understand general climate conditions and how climate change impacts the frequency and the intensity of extreme weather events and the vegetation that fuels fires.

5.3.4.1 General Climate Conditions

The electrical corporation must provide an overview of the general weather conditions and climate across its service territory in the past 30- to 40-year period. The narrative must include, at a minimum, the following:

- *Average temperatures throughout the year*
- *Extreme temperatures that may occur and when and where they may occur*
- *Precipitation throughout the year*

³ The Non-HFTD portion of BVES’s service territory is Big Bear Lake where no assets exist.

The electrical corporation must also provide a graph of the average precipitation and maximum and minimum temperatures for each distinct climatic region of its service territory. At a minimum, it must provide one graph in the main body of the report.

The Bear Valley service territory’s mean annual temperature is about 40° to 50° Fahrenheit, and its mean annual precipitation is about 30 to 40 inches. Much of the precipitation falls in the form of snow. The mean freeze-free period is about 150 to 200 days.

Bear Valley prepared the following three graphs to provide greater detail into its average temperature, the extreme temperatures and when they occur, and average precipitation. Figure 5-3 provides monthly average rainfall, average high, and average low temperature for the last 40 years. Figure 5-4 provides the maximum high temperature and when said temperature occurs along with the trend line for maximum high temperature over the last 40 years. Finally, Figure 5-5 provides minimum low temperatures and when such temperatures occur along with the trend line for minimum low temperature over the last 40 years.

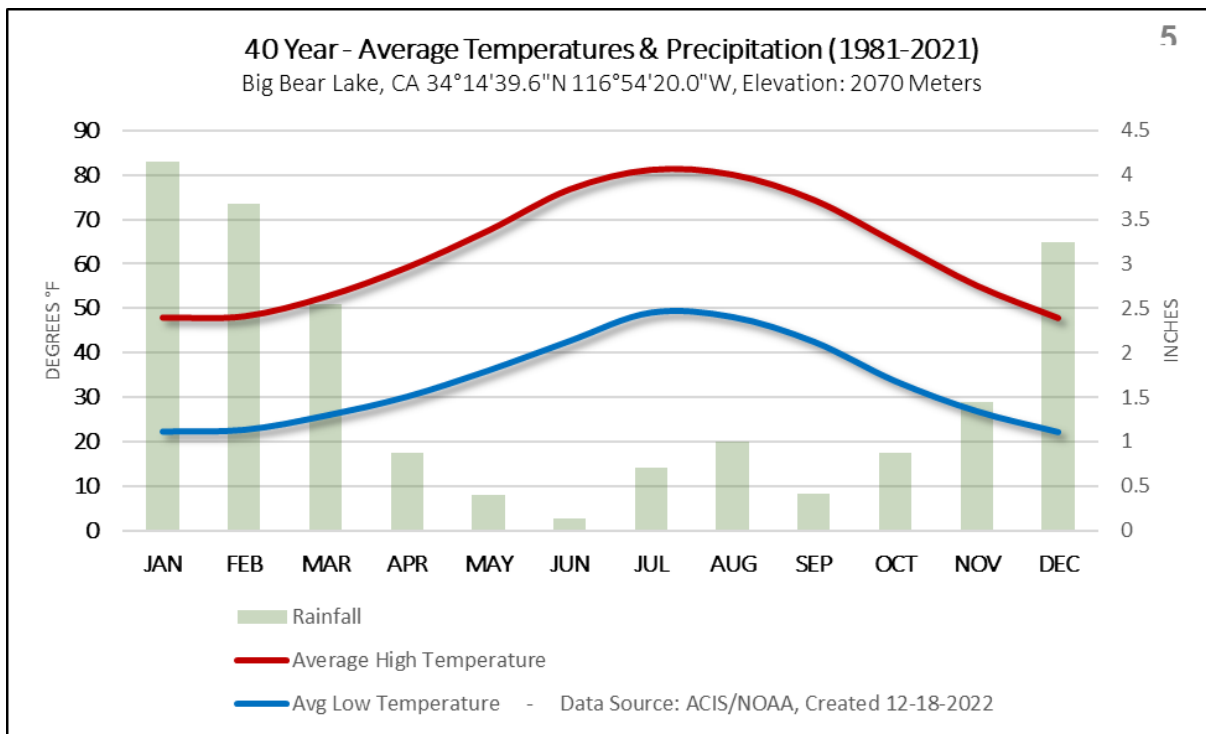

Figure 5-3 Annual Mean Climatology for the Electrical Corporation’s Service Territory

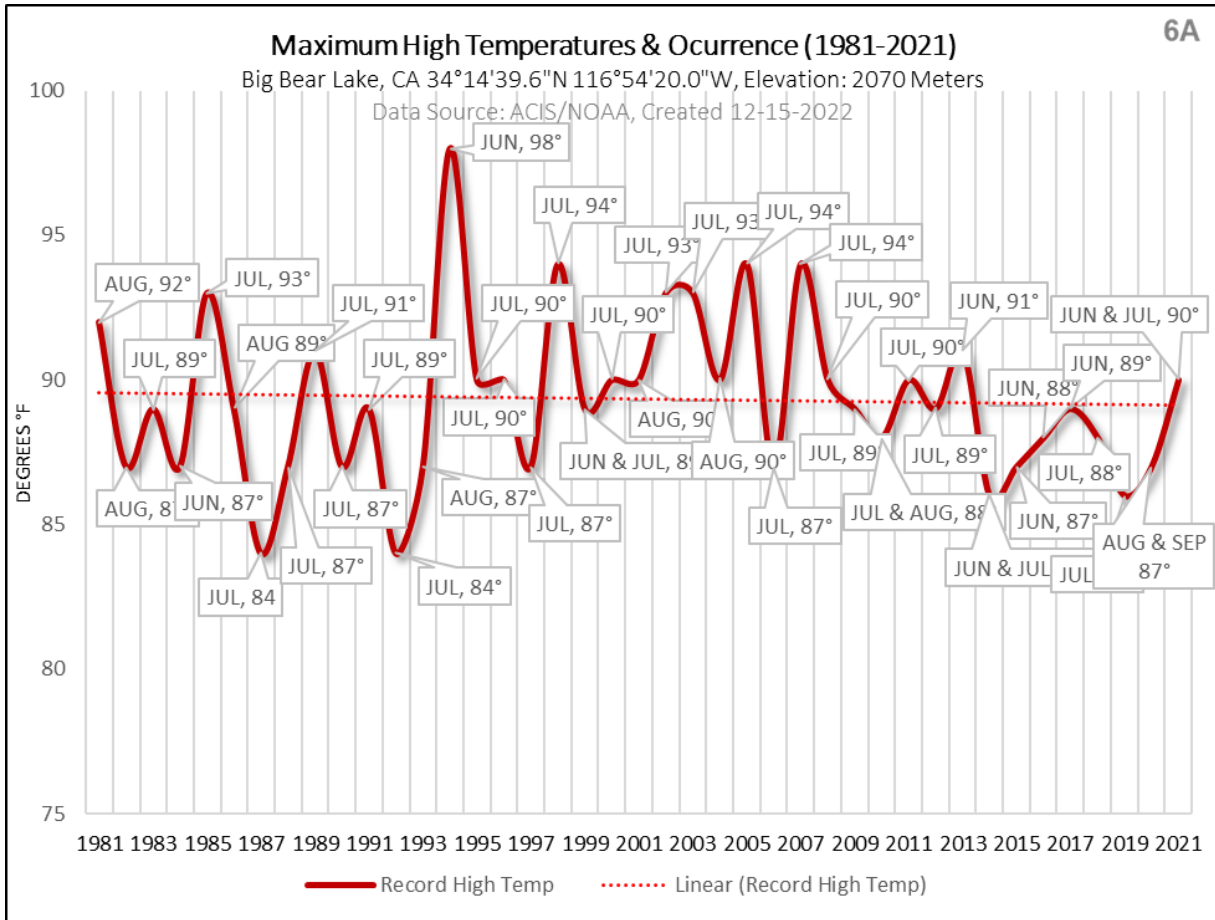

Figure 5-4 Annual Maximum Temperature and Occurrence for the Electrical Corporation's Service Territory

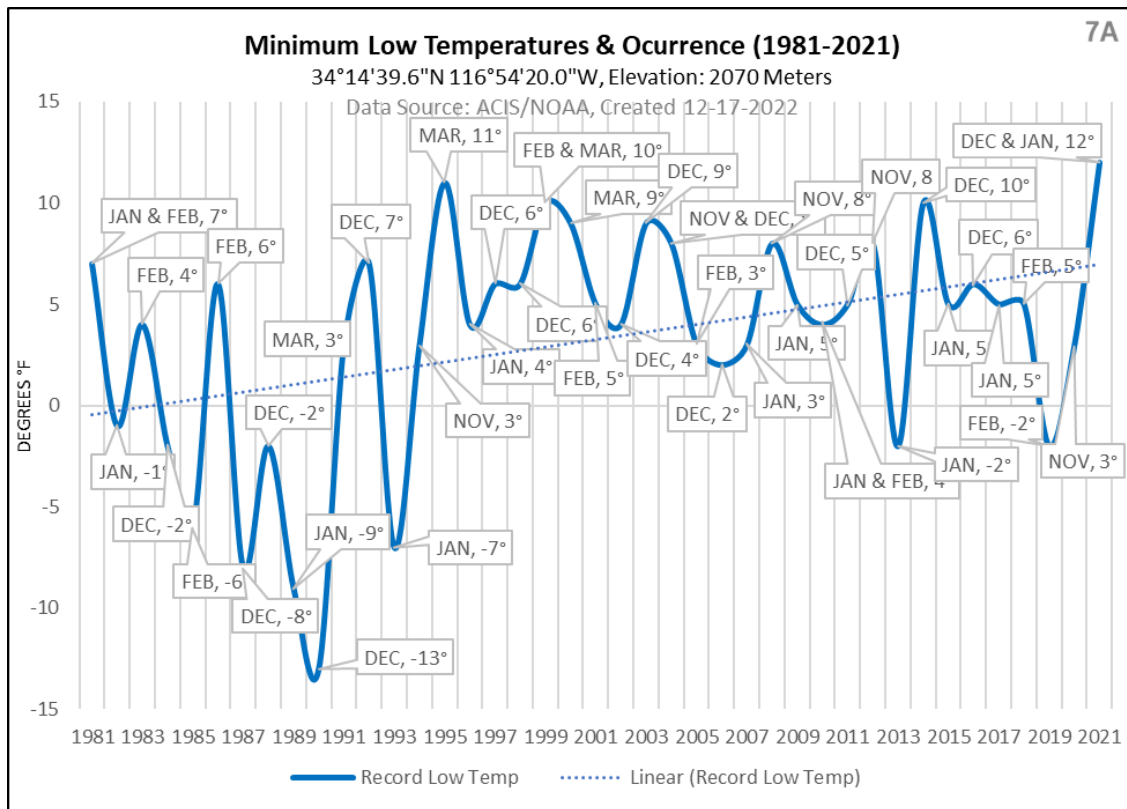

Figure 5-5 Annual Minimum Temperature and Occurrence for the Electrical Corporation’s Service Territory

5.3.4.2 Climate Change Phenomena and Trends

The electrical corporation must provide a brief discussion of the local impacts of anticipated climate change phenomena and trends across its service territory. In addition, the electrical corporation must provide graphs/charts illustrating:

- Mean annual temperature (Figure 5-3)
- Mean annual precipitation (Figure 5-4)
- Projected changes in minimum and maximum daily temperatures (Figure 5-5)

The electrical corporation must also indicate the increase in extreme fire danger days (historic 95th-percentile conditions) due to climate change, considering (at a minimum) the combination of warmer temperatures, drier vegetation, and changes in high-wind events (e.g., Santa Ana winds, Diablo winds, Sundowners) for both winter/spring and summer/fall periods throughout the electrical corporation service territory. Figure 5 6 provides an example of the required information on projections of extreme fire dangers.

The electrical corporation must cite all source(s) used to write and illustrate this section.

Historical data over the past 60 years for the Big Bear area has shown a steady increase in mean temperature with a gradual decline in natural snowfall, while rainfall remains near average. If the current pattern continues, we can expect a continued increase in temperature by some 2-3 degrees through the year 2100. This could have severe long-term implications,

leading to drier winters with more extreme weather events; storms would tend to impact the region less frequently but more violently. This would result in lower lakes, reservoirs & aquifers, which would promote lower fuel moisture supporting more catastrophic wildfires. Short-term pattern changes in the ENSO (El Niño and the Southern Oscillation) may bring temporary relief for the drought-stricken west, but are expected to remain just that, temporary. Scientists cannot say with certainty if we will break this pattern cycle and combat the effects of global warming, but if history is any indication, drier winters, gradually warming temperatures, and more extreme meteorological events appear to be the long-term trend.

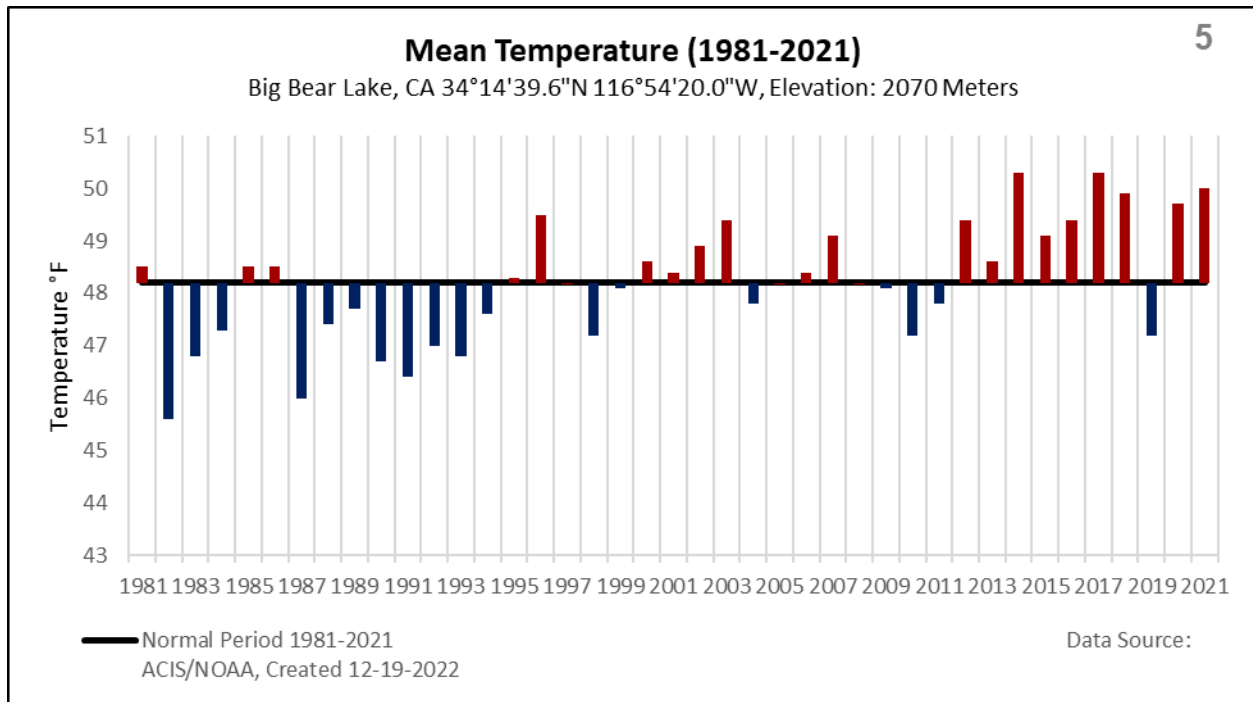

Figure 5-6 Mean Annual Temperature for Service Territory, 1900s–2020s

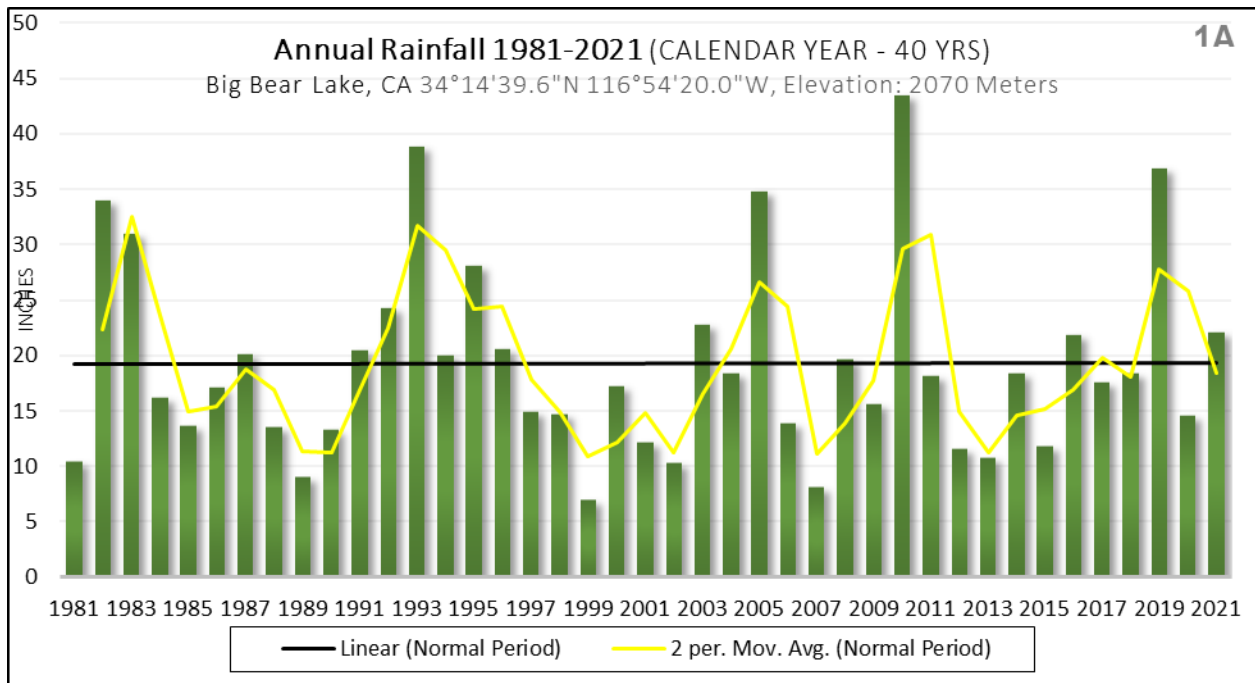

Figure 5-7 Mean Annual Precipitation for Service Territory, 1900s–2020s

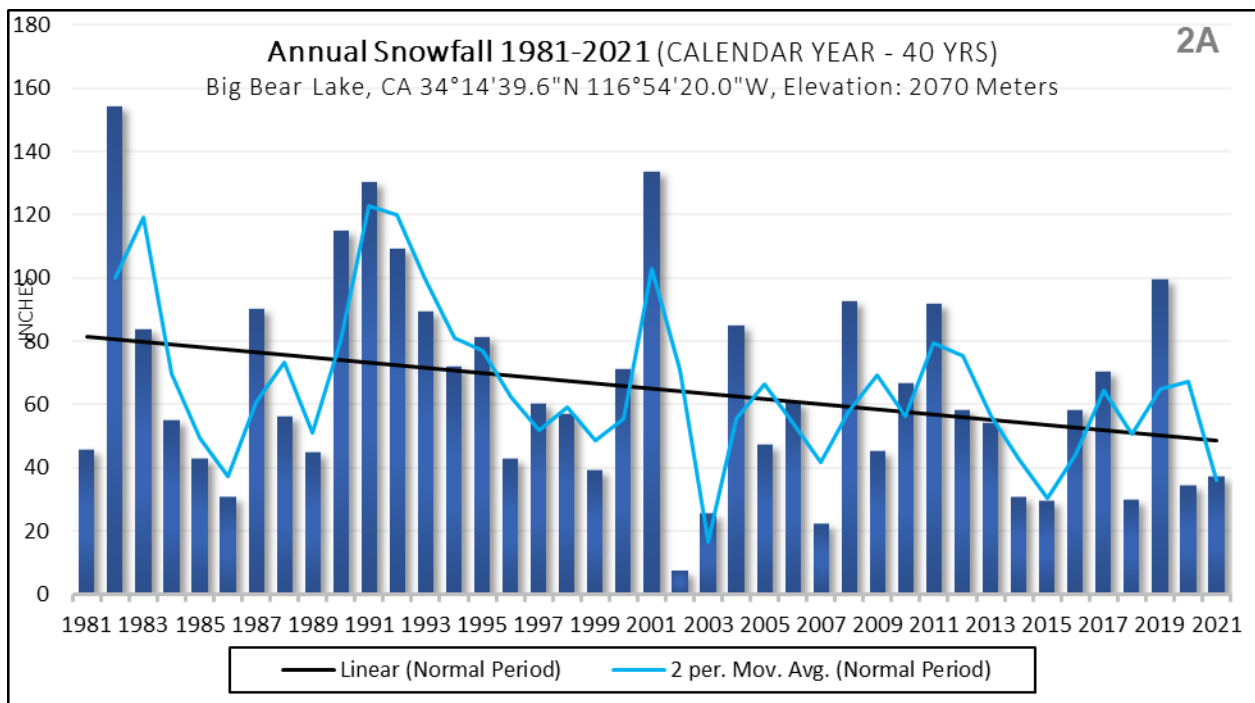

Figure 5-8 Mean Annual Precipitation for Service Territory, 1900s–2020s

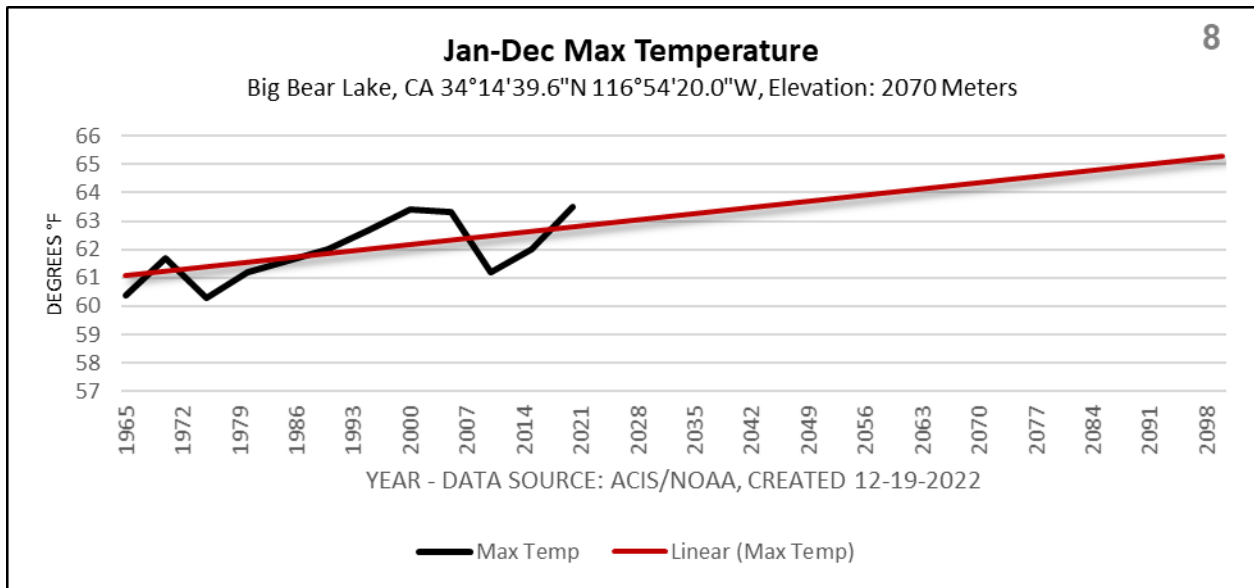

Figure 5-9 Projected Change in Maximum Temperature (Daytime Highs) Through 2100 for the Service Territory

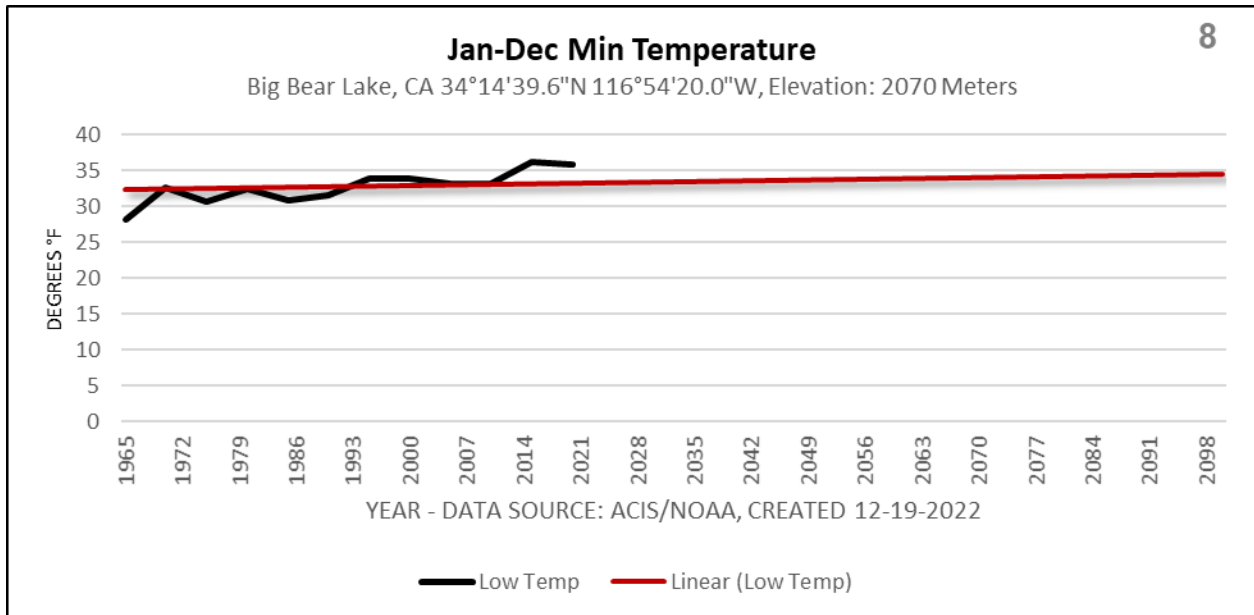

Figure 5-10 Projected Change in Minimum Temperature (Nighttime Lows) Through 2100 for the Service Territory

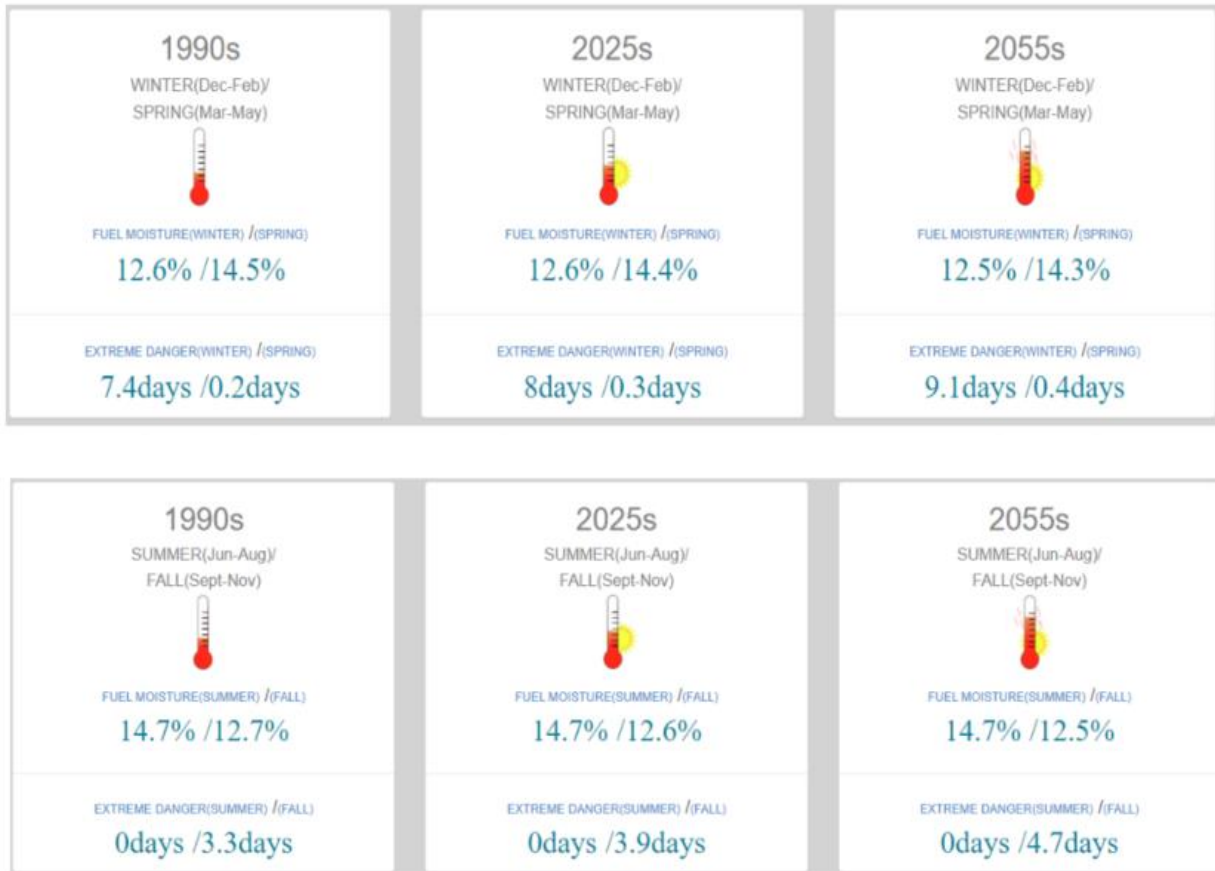

Figure 5-11. Projected Changes in Average Fuel Moisture and Average Number of Days of Extreme Fire Danger for Winter/Spring and Summer/Fall Periods for the Service Territory Based on Global Climate Model Outputs

5.3.5 Topography

The electrical corporation must provide an overview and brief description of the various topographic conditions across its service territory.

Topographically, the 270 square-mile area generally consists of north/south facing slopes. Elevations range from as low as 4,000 feet to 10,200 feet. The major ridges generally run east to west, specifically the Sugarloaf Mountain and Holcomb Valley ranges.

5.4 Community Values at Risk

In this section of the WMP, the electrical corporation must identify the community values at risk across its service territory. Sections 5.4.1–5.4.5 provide detailed instructions.

5.4.1 Urban, Rural, and Highly Rural Customers

The electrical corporation must provide a brief narrative describing the distribution of urban, rural, and highly rural areas and customers across its service territory. Refer to Appendix A for definitions.

BVES services 24,691 customers. Those customers are primarily urban customers with 21,109 customers primarily concentrated in the City of Big Bear Lake and the unincorporated

communities of Big Bear City, Sugarloaf and Erwin Lake. BVES also services a small portion of urban customers with 3,531 customers primarily concentrated in the unincorporated communities of Baldwin Lake, Fawnskin and Lake Williams. BVES does not service any highly rural customers.

5.4.2 Wildland-Urban Interfaces

The electrical corporation must provide a brief narrative describing the wildland-urban interfaces (WUIs) across its service territory. Refer to Appendix A for definitions.

BVES's service territory falls entirely in the wildland-urban interface (WUI) designation.

5.4.3 Communities at Risk from Wildfire

In this section of the WMP, an electrical corporation must provide a high-level overview of communities at risk from wildfire as defined by the electrical corporation (e.g., within the HFTD and HFRA). This includes an overview of individuals at risk, AFN customers, social vulnerability, and communities vulnerable because of single access/egress conditions within its service territory. Detailed instructions are provided below.

5.4.3.1 Individuals at Risk from Wildfire

The electrical corporation must provide a brief narrative (one to two paragraphs) describing the total number of people and distribution of people at risk from wildfire across its service territory.

BVES's entire service territory falls within the HFTD designation. The territory primarily contains HFTD Tier 2 with a small portion of Tier 3. Due to this make-up, all 24,691 customers are considered at risk from wildfires. As BVES completes its grid hardening initiatives some of these customers will be at a reduced risk because of said efforts but with an HFTD designation their risk will never be fully eliminated.

5.4.3.2 Social Vulnerability and Exposure to Electrical Corporation Wildfire Risk

The electrical corporation must provide a brief narrative describing the intersection of social vulnerability and community exposure to electrical corporation wildfire risk across its service territory. This intersection is defined as census tracts that 1) exceed the 70th percentile according to the Social Vulnerability Index (SVI) or have a median household income of less than 80 percent of the state median, and 2) exceed the 85th percentile in wildfire consequence risk according to the electrical corporation's risk assessment(s).

For SVI, the electrical corporation must use the most up-to-date version of Centers for Disease Control and Prevention/Agency for Toxic Substances and Disease Registry's Social Vulnerability Index dataset (Year = 2018; Geography = California; Geography Type = Census Tracts).

In addition, the electrical corporation must provide a single geospatial map showing its service territory (polygon) overlaid with the distribution of the SVI and exposure intersection and urban and major roadways. Any additional maps needed to provide clarity and detail should be included in Appendix C.

The BVES territory contains one Census tract "112.05, San Bernardino County, California" which is defined as the intersection of vulnerability and community exposure. This Census track exceeds the 70th percentile according to the Social Vulnerability Index and exceeds the 85th percentile in BVES wildfire consequence risk.

The high wildfire consequence risk is attributed to the Radford Circuit. BVES is planning to upgrade the Radford Circuit in 2023 with covered conductor which will significantly reduce the wildfire consequence risk for Census tract "112.05, San Bernardino County, California". Upon completion of the Radford upgrade, BVES will re-evaluate the wildfire consequence risk for

each of the circuits and upgrade the Social Vulnerability and Exposure to Electrical Corporation Wildfire Risk Map.

Census tract “112.05, San Bernardino County, California” contains part or all of the following circuits: Shay Circuit, Lagonita Circuit, Harnish Circuit, Georgia Circuit, Garstin Circuit, Eagle Circuit and Boulder Circuit.

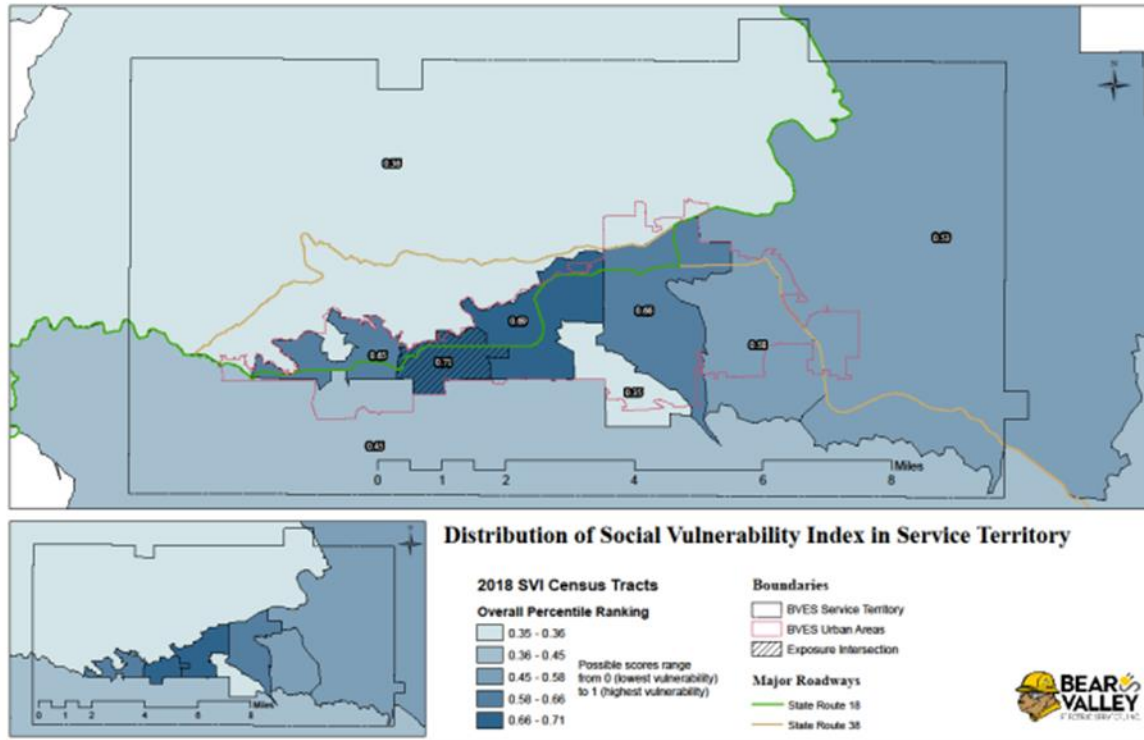

Figure 5-12 SVI Overlay of Service Territory

5.4.3.3 Sub-Divisions with Limited Egress or No Secondary Egress

The electrical corporation must provide a brief narrative overview (one to two paragraphs) describing sub-divisions with limited egress or no secondary egress, per CAL FIRE data, across the electrical corporation’s service territory.

BVES’s service territory does not contain sub-divisions with limited egress or no secondary egress. This was verified using CAL FIRE and their OSFM Subdivision Review Program map.

5.4.4 Critical Facilities and Infrastructure at Risk from Wildfire

The electrical corporation must provide a brief narrative describing the distribution of critical facilities and infrastructure located in the HFTD/HFRA across its service territory. Critical facilities and infrastructure are defined in Appendix A.

BVES’s service territory falls entirely in HFTD Tier 2 and Tier 3, meaning that all critical facilities and infrastructure are located in HFTD. No critical facilities and infrastructure reside outside of HFTD.

5.4.5 Environmental Compliance and Permitting (*Tracking ID: ST_1*)

In this section, the electrical corporation must provide a summary of how it ensures its compliance with applicable environmental laws, regulations, and permitting related to the implementation of its WMP. This overview must include:

- *A description of the procedures/processes to ensure compliance with relevant environmental laws, regulations, and permitting requirements before and during WMP implementation. The process or procedure should include when consultation with permittees occurs (i.e., at what stage of planning and/or implementation of activities described in the WMP)*
- *Roadblocks the electrical corporation has encountered related to environmental laws, regulations, and permitting related to implementation of its WMP and how the electrical corporation has addressed, is addressing, or plans to address the roadblocks.*
- *Any notable changes to its environmental compliance and permitting procedures and processes since the last WMP submission and a brief explanation as to why those changes were made. Include any planned improvements or updates to the initiative and the timeline for implementation.*

The electrical corporation must also provide a table of potentially relevant state and federal agencies that may be responsible for discretionary approval of activities described in WMPs and the relevant environmental laws, regulations, and permitting requirements. If this table extends past two pages, provide the required information in an appendix.

BVES contacts an environmental consultant to ensure that our main facility and substations are properly permitted. The consultant informs BVES of permitting requirements and issues. Permits include but are not limited to Air Quality, Water Quality and Discharge, Hazardous Materials Business Plan, and Spill Prevention Control and Countermeasures Plan.

BVES adheres to and complies with all applicable environmental laws and regulations including but not limited to the Endangered Species Act, Storm Water Pollution Prevention Plan (SWPPP), California Environmental Quality Act (CEQA), and consults with the State Historic Preservation Officer (SHPO). BVES frequently follows up with agencies to ensure all permit submittal requirements are met. There have been no major changes, adjustments, or roadblocks to the environmental process since the last WMP.

Table 5-6 Relevant State and Federal Environmental Laws, Regulations, and Permitting Requirements for Implementing the WMP

Environmental Law, Regulation, or Permit	Responsible Permittee/Agency
Endangered Species Act Section 10(a)(1)(B) Incidental Take Permit	United States Fish and Wildlife Service
CEQA – BVES is seeking a categorical exclusion for the covered conductor project along the Radford sub-transmission (34.5kV) line	USFS
Storm Water Pollution Prevention Plan (SWPPP)	US Environmental Protection Agency (EPA)
National Environmental Policy Act (NEPA)	US EPA
Highway Encroachment Permit	Caltrans

6. Risk Methodology and Assessment

In this section of the WMP, the electrical corporation must provide an overview of its risk methodology, key input data and assumptions, risk analysis, and risk presentation (i.e., the results of its assessment). This information is intended to provide the reader with a technical understanding of the foundation for the electrical corporation's wildfire mitigation strategy for its Base WMP. Sections 6.1–6.7 below provide detailed instructions.

For the 2023-2025 Base WMP, the electrical corporation does not need to have performed each calculation and analysis indicated in sections 6.2, 6.3, and 6.6. If the electrical corporation is not performing a certain calculation or analysis, it must describe why it does not perform the calculation or analysis, its current alternative to the calculation or analysis (if applicable), and any plans to incorporate those calculations or analyses into its risk methodology and assessment.

In this section, BVES provides an overview of its approach to define and analyze wildfire and PSPS risk. The risk analyses, which results in risk assessments, inform mitigation strategy, prioritization, selection, and scoping as described in Section 7.

BVES has significantly advanced its risk methodologies and assessments, including by hiring the risk modeling firms Technosylva and DIREXYON to improve Bear Valley's risk assessment, modeling, and monitoring capabilities, and support daily operations as well as long-term risk planning. Over the past three years, BVES has sought external help with risk mapping and modeling from REAX Engineering, Technosylva and DIREXYON. Additionally, and as described in Section 7 of this WMP, BVES has improved its Fire Safety Circuit Matrix, Risk-Based Decision-Making Model, and RSE analysis.

BVES is a small, geographically compact utility with limited budgets and staff. The service territory is all designated as Tier 2, with a small section of Tier 3 HFTD and, accordingly, the entirety of BVES's service territory is vulnerable to utility ignitions and wildfire. Because of this inherent risk across the utility footprint, there is significantly less risk variation between lines and circuits present at other California IOUs and all risk evaluations. Therefore, BVES's risk scoring necessarily incorporates this understanding. Further, BVES seeks to be prudent with its ratepayer funds and is closely observing its fellow utilities and monitoring their developments as it pertains to risk methodology and assessment. Bear Valley continues to adopt, implement, and update appropriate risk methodologies, assessments, and modeling where such approaches and tools allow BVES to gain a better understanding of the risks and how it should mitigate those risks.

6.1 Methodology

In this section, the electrical corporation must present an overview of its risk calculation approach. This includes one or more graphics showing the calculation process, a concise narrative explaining key elements of the approach, and definitions of risks and risk components.

6.1.1 Overview

The electrical corporation must provide a brief narrative describing its methodology for quantifying its overall risk of wildfires and PSPS. This methodology will help inform the development of its wildfire mitigation strategy (see Section 7). The electrical corporation must describe the methodology and underlying intent of this risk assessment in no more than five pages, inclusive of all narratives, bullet point lists, and any graphics.

The following is an exemplar of this overview:

The risk assessment in this WMP is based on a quantified risk approach using a range of industry-recognized standards, best practices, and research to determine the electrical corporation's overall risk of wildfires and PSPS for its service territory. The intent of performing this risk analysis is to:

- *Understand the overall risk and associated risk components of wildfires and PSPS events spatially and temporally across the electrical corporation's service territory*
- *Use this understanding of risk to inform the development of a comprehensive wildfire mitigation strategy in Section 7 that achieves the goals and objectives stated in Section 4.1 and 4.2*

The risk analysis is shown schematically in Figure 6-1 below. The approach consists of the following:

- *Identifying key wildfire and PSPS hazards and risk components across the electrical corporation's service territory (refer to Section 6.2.1).*
- *Identifying key modeling tools, inputs, and assumptions to quantify the likelihood and consequence of the electrical corporation's overall risk (refer to Section 6.2.2 and 6.2.3).*
- *Identifying credible scenarios that would expose surrounding people, assets, and natural resources (PAR) to wildfire or PSPS risks (refer to Section 6.3).*
- *Summarizing the overall utility risk and key metrics (refer to Section 6.4).*
- *Presenting the quality assessment and quality control procedures for the electrical corporation's risk assessment (refer to Section 6.4).*
- *Improving the risk analysis approach based on lessons learned during the WMP cycle (refer to Section 6.7)*

BVES maintains a risk mitigation strategy to prioritize the most cost and operationally effective strategies for risk reduction. The methodology identifies inherent risk, existing controls, residual risk, and future mitigation efforts based on the residual risk that includes the remaining likelihood and impact of wildfire risk in the service territory. The Risk-Based Decision-Making Framework is the primary risk evaluation tool utilized to prioritize and plan for WMP initiatives. BVES's Risk-Based Decision-Making Framework is consistent with other SMJUs based on direction from the Commission. The following figure provides an overview of BVES's overall risk assessment process.

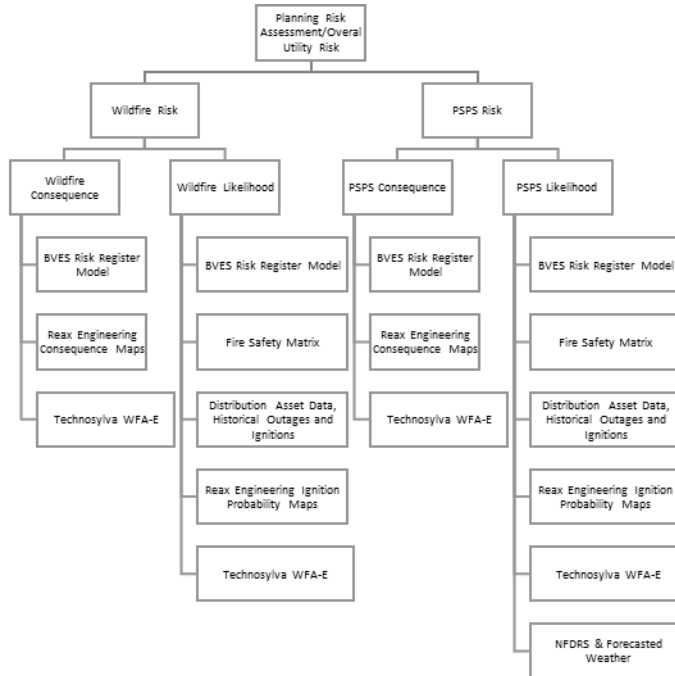

Figure 6-1 Risk Assessment Component Hierarchy

As BVES is moving to implement additional modeling capability, BVES expects the overall risk assessment process by the 2024 WMP Update to reflect the figure below:

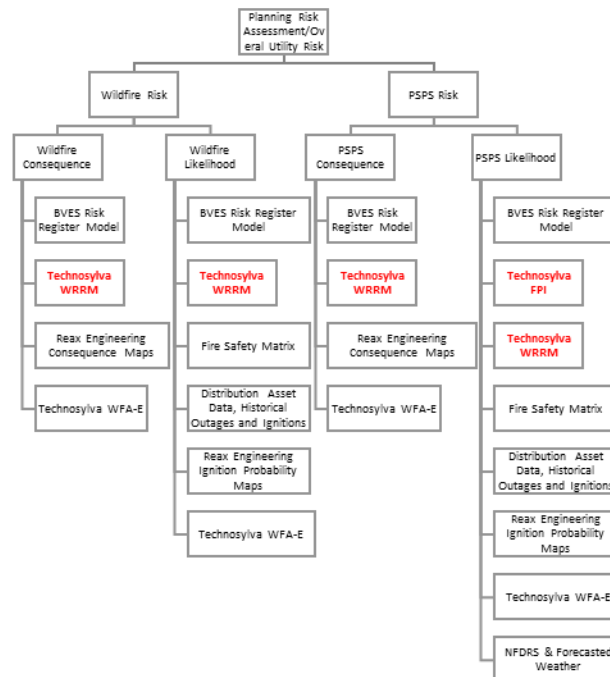

Figure 6-2 Future State Risk Assessment Component Hierarchy

Currently, BVES evaluates enterprise risk in accordance with Risk-Based Decision-Making Framework, this aligns with the safety model approach for Small and Multi-Jurisdictional Utilities (SMJU) provided in CPUC D. 19-04-020 of April 25, 2019. This approach to risk management

includes the basic tenets of the International Standardization Organization’s “Risk Management – Principles and Guidelines” (“ISO 31000”). Specifically, the process utilizes the Cycle Ten-Step Approach to perform the risk analysis. The figure below summarizes the Cycle Ten-Step Approach.

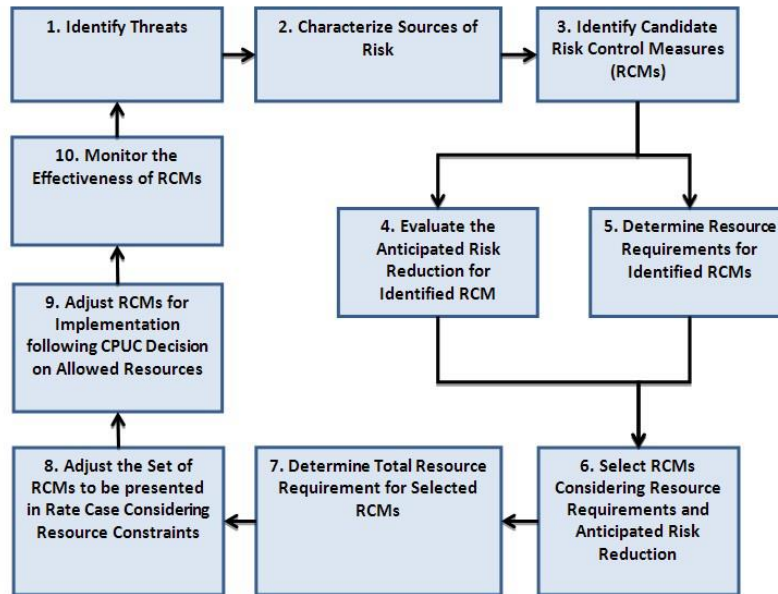

Figure 6-3 Cycle Ten-Step Approach

This Risk Register Model evaluates the enterprise risk reduction relative to the cost of the mitigation using the RSE analysis. This analysis focuses on a review of ongoing and potential new projects to mitigate the three primary wildfire risk events:

- Wildfire – Threats to Public Safety
- Wildfire – Significant Loss of Property
- Loss of Energy Supplies

The enterprise risk evaluation considers a reasonable worst-case scenario for the three primary wildfire risk events. For each primary risk event, BVES determined the frequency of occurrence and impact scores for each of the weighted risk scoring inputs listed below:

- Personal and public safety
- System reliability impacts
- Regulatory compliance and legal implications
- Quality of service to customers
- Environmental impacts

The Risk Register Model quantifies mitigation projects and programs by the risk benefit and RSE. This allows BVES to better evaluate projects in terms of risk reduction and select the most cost effective and efficient project among alternatives. BVES utilizes a 7x7 log score model matrix to determine an impact risk score for each weighted scoring input in the Risk Register.

The weighted impact scores are accumulated to arrive at a total risk score. The risk scoring inputs, and total risk score form the basis of evaluation for each identified wildfire mitigation activity or initiative. Mitigation activities can be applied to single or multiple risk events. BVES then calculates the risk reduction or risk benefit for each scoring input to arrive at a weighted mitigated risk score. The risk benefit for each combination of mitigation activity and risk event is determined by subtracting the mitigated risk score from the total risk score. BVES also defines an equivalent annual cost for each mitigation activity. Finally, the Risk Register determines the RSE by dividing the risk benefit by the equivalent annual cost.

While the Risk Register Model provides overall system risk benefit analysis, it does not provide specific location risk benefit. This limits its value in prioritizing wildfire and PSPS mitigation work in the system. To address this issue, BVES developed the Fire Safety Circuit Matrix, which aims to characterize all BVES distribution circuits in groups of High, Moderate, and Low wildfire risk and then prioritize the circuits within each wildfire risk group. The matrix data uses a balanced scorecard approach, and its inputs include *inter alia*, the number of customers, wood poles, bare wire overhead circuit miles, tree attachments, and remaining expulsion fuses, which are then compiled and weighted to calculate the wildfire risk mitigation score.

BVES uses the Fire Safety Circuit Matrix as a “living document” as mitigations are implemented. BVES re-evaluates the scores, incorporating any new mitigations, for Wildfire Risk Group, Priority, and Mitigation Weight at least every six months. Additionally, the Fire Safety Circuit Matrix is used to gauge progress and set 3- and 10-year targets for wildfire mitigation score reductions and associated wildfire ignition risk reduction.

BVES enhanced its ignition risk mapping methodology with the completion of several ignition probability and consequence models in 2021 by contracting with REAX Engineering (REAX). REAX provided BVES ignition probability maps along each point of its overhead distribution and sub-transmission system. REAX also developed consequence maps for each point of its overhead distribution and sub-transmission system. The consequence maps were developed for wildfire size (acres burned) and number of structures impacted. REAX then performed the same analysis, projected out to 2050, to provide insight on the impact of long-term climate change. While these maps are very useful in understanding the wildfire risk along the BVES overhead distribution and sub-transmission system, they are static; therefore, BVES sought to move to more dynamic models.

BVES contracted Technosylva in 2022 and DIREXYON in 2023 to support the Risk Mapping Program to further improve situational awareness and long-term wildfire risk mitigation planning efforts. Better understanding of the risk environment should improve BVES’s resource allocation. This effort leverages Technosylva’s Wildfire Analyst Enterprise (WFA-E) software capabilities and solutions implemented across California for other electric utility companies.

Technosylva

Technosylva’s WFA-E product is used by BVES to conduct the modeling, deliver modeling outputs, and monitor and visualize results with software applications. The wildfire behavior modeling and risk analysis is applied to address two different, yet similar, scenarios.

First, the modeling is used with historical reanalysis weather research and forecasting model (WRF) weather data to support the BVES mitigation planning process. The WFA-E Wildfire Risk Reduction Model (WRRM) is used to quantify risk metrics from millions of wildfire simulations using the numerous WRF weather scenarios defined. Other key input datasets such as surface

and canopy fuels, and live fuel moisture and dead fuel moisture, are developed daily using machine learning (ML) models to calculate the wildfire behavior outputs as part of the risk analysis model.

Second, the modeling is run by BVES daily with WRF-based weather forecast data to calculate consequence-based risk metrics for all assets as possible ignition sources to support operational requirements. This wildfire consequence data is then combined with probability of failure and ignition analysis developed by BVES to define composite risk values to support prioritization decision making for asset hardening and related mitigation.

Wildfire risk forecasts are derived daily by BVES, or sometimes twice daily, with a multi-day outlook that displays expected changes on an hourly basis. This information is used by BVES as input into key decision making related to operational requirements, such as PSPS, resource allocation and deployment, field operations, etc.

Wildfire behavior modeling and risk analysis is applied to quantify the potential impacts from possible electric utility infrastructure asset caused ignitions. The basis of this modeling is that not all ignitions (fires) are created equally, and each asset caused ignition can have substantially different consequence-based on ignition location and related landscape characteristics.

The wildfire modeling and risk analysis derives a set of consequence metrics that quantify impacts. This includes potential acres burned, population impacted, number of buildings threatened, and estimated number of buildings destroyed. These consequences are currently derived using an 8-hour simulation duration, based on a typical first burning period. Testing is underway to evaluate different fire durations based on suggestions in the most recent WMP Guidelines.

BVES implemented Technosylva's WRRM, which uses historical climatology (weather & fuel moisture data) as key input weather scenarios (~ 30 year and 2 km hourly reanalysis data), to improve its asset risk analysis. The model produces risk metrics by running fire spread simulations for each weather scenario territory wide. The outputs can then be aggregated based on percentile and assigned to assets. The model uses historical or predicted fuels data (e.g., 2030) and utilizes hundreds of millions of fire-spread simulations across customer service territory. The WRRM outputs are used by BVES to support mitigation planning in addition to setting context for daily FireCast asset risk forecasts.

It is BVES's intent to transition from using the Fire Safety Circuit Matrix to the WRRM to prioritize its WMP initiatives. The first runs of the WRRM were completed in 2023. BVES used the WRRM to help plan and prioritize initiatives in the 2024 and 2025 WMP Updates. In 2023, with the initial information from WRRM, BVES continued to use the Fire Safety Circuit Matrix and validated its results against the WRRM outputs. Now that BVES has experience with WRRM, BVES believes that replacing the Fire Matrix with the WRRM will provide a probabilistic model and the level of granularity will eventually shift from the circuit level to the segment or span level. The model will provide calculated probability, consequence, and risk.

DIREXYON

BVES is committed to continued advancement and improvement in wildfire risk mitigation efforts. In pursuit of this goal, BVES is making strategic investments aimed at bolstering the overall maturity of its long-term wildfire mitigation capabilities. One such investment is the

procurement and use of the DIREXYON Solution (DIREXYON) to develop an advanced fire risk model. The DIREXYON model seeks to bridge critical gaps in BVES's risk modeling capabilities.

The BVES collaboration with DIREXYON represents the initial phase of a multi-phased approach aimed at progressively enhancing BVES decision-making processes around wildfire risk mitigation, with a focus on streamlining operations and fostering data-driven solutions. The first phase implementation is scheduled for completion in the third quarter of 2024, and detailed within DIREXYON's report titled, "*Phase 1 – Implementation of DIREXYON Suite for distribution assets*" (hereafter referred to as the Report). The summary of the phase 1 findings are highlighted below and provide insight into BVES fire mitigation efforts as they pertain to long-term risk modeling, planning, and mitigation, as well as our continued improvement efforts.

Through this phase 1 effort, DIREXYON identified three (3) distinct use cases that, DIREXYON explains, "offer comprehensive insights into the necessary investment levels to meet regulatory minimums, ascertain the current state of affairs, assess the short-term and long-term impacts of the existing BVES strategy on network conditions, and explore alternative fire mitigation strategies."

The three use cases are delineated as follows:

1. Meeting the minimum Public Utilities Commission of the State of California General Order 165 (GO 165) requirements regarding the Inspection Requirements for Electric Distribution and Transmission Facilities
2. Continuation of the current state of BVES measures, which comply to GO 165 with added enhanced mitigation measures, such as:
 - Installation of wire mesh wraps on wood poles
 - Proactive replacement of bare conductors
 - Implementation of vegetation management strategies
3. An alternative mitigation strategy that deals with covered conductors and replacing wooden poles with steel as an alternative to the ongoing wire mesh wrap installation efforts by BVES

These three scenarios are integrated into the DIREXYON risk modeling efforts and the result of those inputs indicate the corresponding risk mitigation level. This tool enables BVES to make data-driven decisions aimed at reducing wildfire risk and minimizing exposure to public safety power shutoff (PSPS) events. By leveraging effective risk modeling techniques and corresponding decision-making processes, BVES aims to enhance the resilience of its power infrastructure assets and equipment to safeguard communities from the threat of wildfires. The findings from the DIREXYON fire risk model identified the BVES use cases two and three presented substantial long-term value by consistently maintaining fire risks at lower levels. Of those, the use case that performed at the highest level was number three. This use case, while it presents higher upfront costs with lower long-term savings, will have the greatest impact on wildfire mitigation risk.

When arriving at this conclusion, DIREXYON noted that, "considerations regarding inventory, supply chain constraints, and the feasibility of steel pole installation over wood poles are not factored into this analysis." The factors beyond the scope of the analysis, such as inventory and supply chain constraints, underscore the limitations around material availability and project timelines, influencing the implementation process, even in the most optimal use case. The risk modeling efforts also experienced barriers around lack of historical outage data that influenced the use of the Weibull parameters sourced from subject matter experts or available literature to

calculate the probability of asset failure. Similarly, in the absence of Fire Potential Index (FPI), DIREXYON utilized Technosylva data to calculate PSPS probabilities. Now that FPI is available, it will be integrated by DIREXYON into the model.

Within the Report, DIREXYON provides an aggregated results dashboard detailing the phase 1 findings. The dashboard shows, as DIREXYON explains,

“simulation outcomes in an aggregated format, offering a holistic view of the overall network condition, required investments, and other key performance indicators at a collective level. This format facilitates a comprehensive evaluation of the network's overall health and performance. The integrated dashboard within the DIREXYON suite offers versatile views, tailored to cater to various personas such as executives, asset managers, and more. These views can seamlessly switch between detailed insights and holistic overviews, providing a customized experience for different stakeholders.”

For example, in the current state dashboard, shown in Figure 6-4, we can see the current condition of the network and details such as the number of uncovered conductors and poles without fire wrap. This insight allows BVES to identify the highest risk areas within the network and plan our risk mitigation activities accordingly.

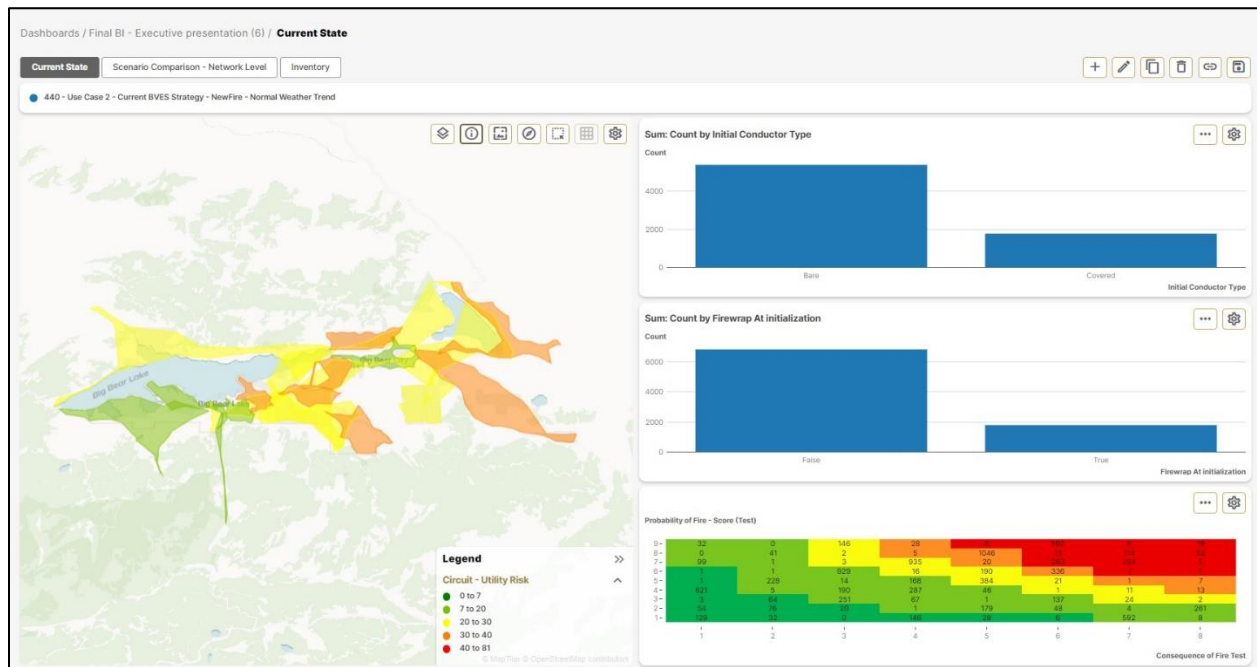

Figure 6-4 BVES Network Current Risk State

Embedded within the Report and DIREXYON's risk modeling efforts is the scenario comparison dashboard that offers a view into the short-term and long-term network impacts of the three use cases. An example of this is shown in Figure 6-5 where DIREXYON provided a long-term view into the cost of implementing each of the use cases. The blue line accounts for use case one (meeting minimum GO165 requirements), use case two is shown through the orange line (current BVES strategy), and use case three is the green line (alternative mitigation strategy).

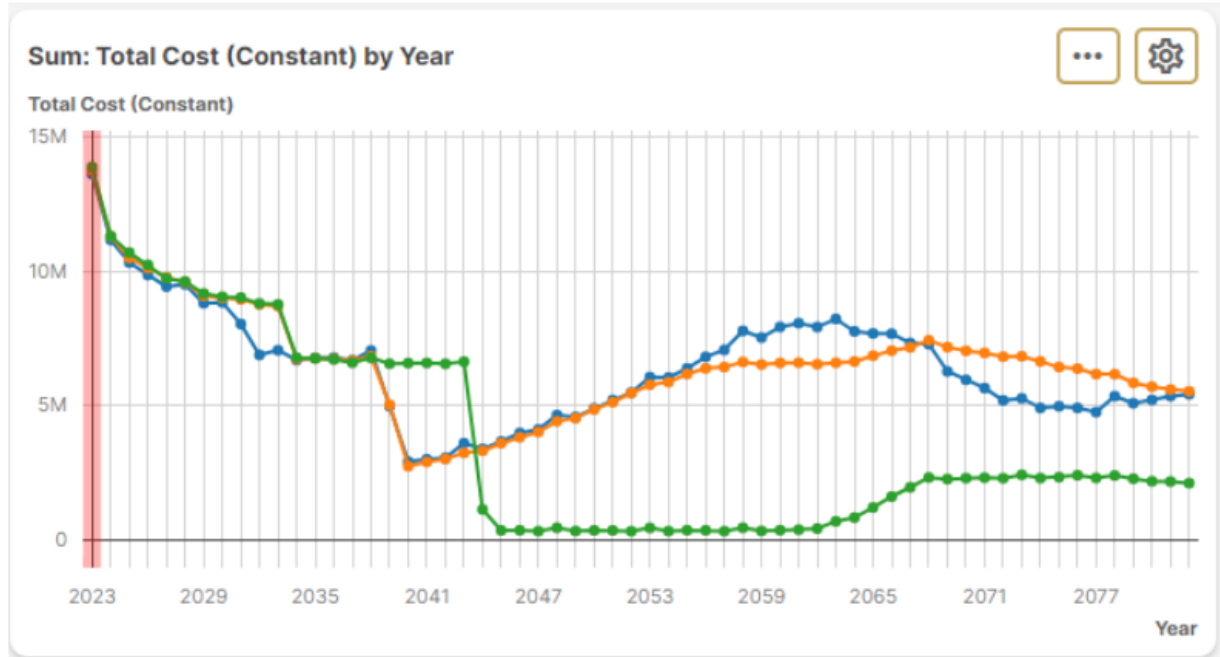

Figure 6-5 Use Case Long-Term Cost Comparison

DIREXYON describes the findings shown in Figure 6-5 as follows,

“[Use case 1] while being more cost-effective, relies primarily on vegetation management as the key strategy for reducing fire risk. Scheduled every five years, this systematic approach helps manage the risk to some extent. However, the limited frequency and scope of vegetation management may not fully address the comprehensive fire risk, especially in areas prone to rapid regrowth or in high-risk fire zones. The cost savings in this use case are significant, reflecting a more reactive and compliance-focused approach.

Use Case 2 - Current BVES Strategy: The second use case includes not only more frequent and extensive vegetation management but also the installation of wire mesh wraps on poles and the proactive replacement of conductors. By choosing to invest in comprehensive fire prevention methods like fire-resistant wraps and safer conductors, the upfront costs are higher.

Use Case 3 – Covered Conductors and Proactive Steel Pole Replacement: Use Case 3 introduces a different strategy from the previous two, involving the proactive replacement of wood poles with steel poles with the expectation that it will lead to major cost savings over time. Steel poles, being more durable and less prone to fire suggests an understanding that some significant early investments will lead to a smoother financial road ahead, with much lower maintenance requirements. It's a forward-thinking strategy that anticipates less frequent interventions and long-term resilience.”

This correlation between the provided analysis and the visual representation in the report underscores the effectiveness of the risk modeling strategy that BVES is implementing with the support of DIREXYON. What we see in Figure 6-5 is that, despite the higher upfront costs, the long-term performance depicted in the figure substantiates use case three. This tangible demonstration of efficacy not only facilitates informed decision-making, but also strengthens the utility’s risk mitigation efforts. The value of the risk modeling efforts lies in its ability to provide

concrete, data-driven evidence that directly influences decision-making processes, ultimately guiding BVES towards more prudent and effective strategies.

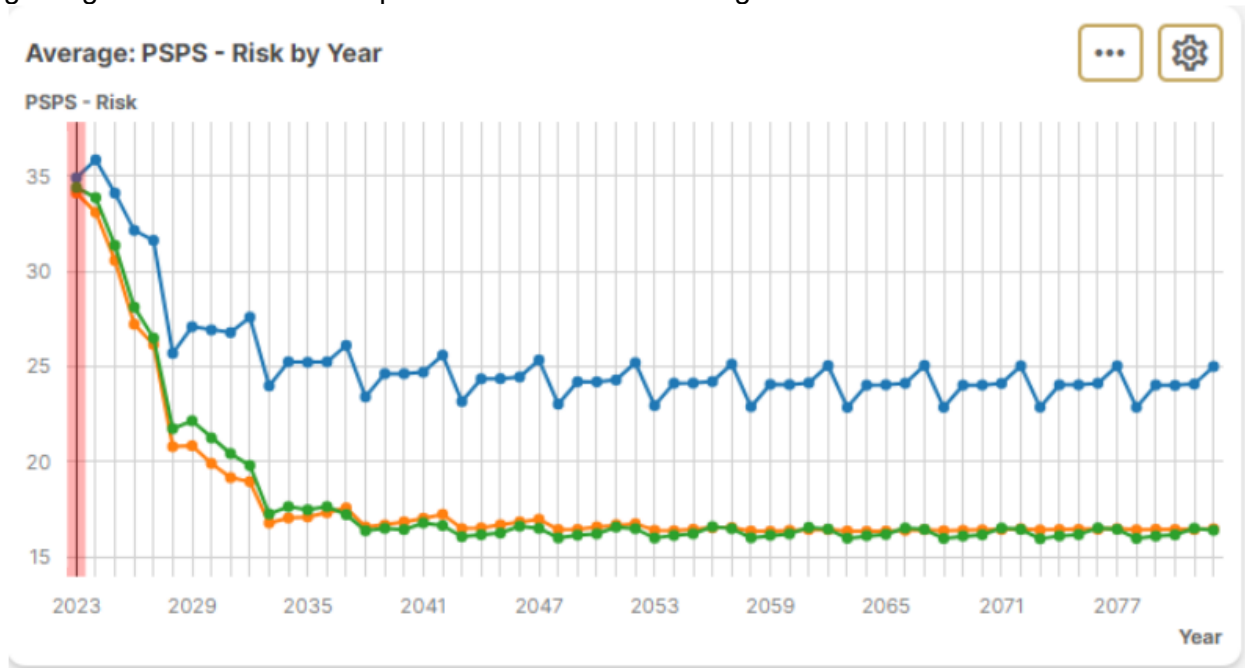

Figure 6-6 Use Case PSPS Risk By Year

Figure 6-6 shows the PSPS risk trend across the three use cases. DIREXYON describes the findings shown in Figure 6-6 as follows,

“The PSPS risk trends across the strategies illustrate how a focus on resilient infrastructure can profoundly affect the necessity and frequency of PSPS. Investments that enhance the electrical system’s resilience, such as the proactive replacement of wood poles with steel, are shown to not only lower fire risk but also reduce the reliance on PSPS as a preventative measure. With fewer PSPS events, there’s less disruption to communities and a lower risk of fire initiation from electrical equipment. This is particularly crucial for AFN customers, for whom power outages can pose serious risks. A strategy that results in a sustained low PSPS risk demonstrates a commitment to public safety and reliability, highlighting a long-term view where initial higher investments in infrastructure lead to greater stability and fewer impacts from power shutoffs.”

At present, BVES collaboration with DIREXYON has yielded its phase 1 risk modeling analysis that is set to be implemented by the third quarter of 2024. The information gleaned from this initial endeavor are promising. The revelations uncovered in this report signify the potential inherent in leveraging the DIREXYON risk modeling methodology, allowing for decision-making frameworks underpinned by data-driven insights, as elucidated by the findings in the Report. Yet, it is crucial to acknowledge that this current undertaking represents only initial phase of what is meant to be a long-term effort. As BVES ventures forward, we anticipate harnessing the full spectrum of benefits that this risk modeling tool offers, thereby fortifying BVES operational resilience and enhancing BVES ability to make informed and substantiated decisions based on empirical evidence.

The Report describes what DIREXYON views as the future phases of this analysis that aligns with BVES long-term risk planning goals, and are summarized in Table 6-1, *Future Phase – Risk Model Enhancements/Refinements*.

BVES Table 6-1 Risk Model Enhancements

Risk Model Enhancements/Refinements	
PSPS Model Enhancement	<ul style="list-style-type: none"> Augment risk modeling by incorporating FPI Technosylva data and factoring in the monetary impact of PSPS. This includes strategies to reduce the impact on AFN customers, exploring battery storage options, and more.
Integration of Other Asset Types	<ul style="list-style-type: none"> Include other asset types in the model to accommodate diverse fire mitigation strategies, such as proactive fuse replacement and assessing AFN impacts. Consider fire caused by different asset types and adjust the overall framework accordingly.
Vegetation Modeling as a Separate Asset	<ul style="list-style-type: none"> Model vegetation as a distinct asset, allowing for the testing of various vegetation management strategies.
Designing Additional Use Cases	<ul style="list-style-type: none"> Explore and create new use cases, testing additional what-if scenarios to further refine the model <ul style="list-style-type: none"> Assessing the Benefits of Using Fire-Resistant conductor Materials to Replace Copper Conductors

Continued collaborative efforts with DIREXYON will help BVES to achieve its goals surrounding long-term oversight and planning on our wildfire risk mitigation strategy. The implementation of the future phases will follow and build upon the successful implementation of the phase 1 efforts.

To conclude, the collaboration with DIREXYON demonstrates BVES’s steadfast commitment to enhancing wildfire risk mitigation and PSPS event reduction. By enlisting the expertise of a professional risk modeling company, we have embarked on a journey of continuous improvement and strategic investment aimed at fortifying BVES’s network resilience as it pertains to wildfire risks. The insights gleaned from this collaboration have illuminated higher risk areas within BVES’s network and provided invaluable analyses for both short-term and long-term decision-making.

As BVES looks to the future, this initial phase 1 findings are set for implementation in the third quarter of 2024. Moving forward, BVES is poised to leverage these insights to streamline its processes and bolster risk mitigation capabilities, ensuring a more robust and resilient energy infrastructure for the communities served.

6.1.2 Summary of Risk Models

In this section, the electrical corporation must summarize the calculation approach for each risk and risk component identified in Section 6.2.1. This documentation is intended to provide a quick summary of the models used. The electrical corporation must provide the following information:

- **Identification (ID)** – Unique shorthand identifier for the risk or risk component.
- **Risk component** – Unique full identifier for the risk or risk component.
- **Design scenario(s)** – Reference to design scenarios evaluated with the model to calculate the risk or risk component. These must be defined in Section 6.3.

- **Key inputs** – List of key inputs used to evaluate the risk or risk component. These can be in summary form (e.g., the electrical corporation may list “equipment properties” rather than listing out equipment age, maintenance history, etc.).
- **Sources of inputs** – List of sources for each input parameter. These must include data sources (such as LANDFIRE) and modeling results (such as wind predictions) as relevant to the calculation of the risk or risk component. If the inputs come from multiple sources, each source should be on a new line.
- **Key outputs** – List of outputs calculated for the risk or risk component.
- **Units** – List of the units associated with the key outputs.

The electrical corporation must provide additional detail on each model in the appendix, in accordance with the requirements documented in Appendix B.

Table 6-1 Summary of Risk Models

ID	Risk Component	Design Scenario(s)	Key Inputs	Source of Inputs (Data and/or Models)	Key Outputs	Units
R1	Overall Utility Risk	Wind Load Condition 1, Wind Load Condition 2, Weather Condition 2, Vegetation Condition 1, Vegetation Condition 3	Combination of Wildfire Risk and PSPS Risk	BVES Risk Register Model (SMJU Risk-Based Decision Making) DIREXYON	Overall wildfire and PSPS risk	Risk Unit (Specific to Model)
R2	Ignition Risk	Wind Load Condition 3, Weather Condition 2, Vegetation Condition 1, Vegetation Condition 3	Product of Ignition Likelihood and Wildfire Consequence	Technosylva WFA and WRRM ⁴ DIREXYON	Wildfire Risk for Circuit Segment	Risk Unit (Specific to Model)
R3	PSPS Risk	Wind Load Condition 2, Weather Condition 1, Vegetation Condition 1	Product of PSPS Likelihood and PSPS Consequence	Technosylva WFA and FPI ⁵ DIREXYON	PSPS Risk per Circuit Segment	Risk Unit (Specific to Model)

⁴ BVES expects to fully implement the Wildfire Risk Reduction Model (WRRM) for its 2024 WMP Update.

⁵ BVES expects to implement a Fire Potential Index (FPI) by the end of 2023.

ID	Risk Component	Design Scenario(s)	Key Inputs	Source of Inputs (Data and/or Models)	Key Outputs	Units
LI	Ignition Likelihood	Wind Load Condition 3, Weather Condition 2, Vegetation Condition 1, Vegetation Condition 3	Technosylva Database BVES GIS Asset Map	Technosylva WFA and WRRM	Ignition Likelihood per Circuit Segment	Ignition Likelihood Unit (Specific to Model)
L1	Wildfire Likelihood	Wind Load Condition 3, Weather Condition 2, Vegetation Condition 1, Vegetation Condition 3	Technosylva Database BVES GIS Asset Map	Technosylva WFA DIREXYON	Wildfire Likelihood per Circuit Segment	Wildfire Likelihood Unit (Specific to Model)
C1	Wildfire Consequence	Wind Load Condition 3, Weather Condition 2, Vegetation Condition 1, Vegetation Condition 3	Technosylva Database (Population, buildings, acres burned)	Technosylva WFA DIREXYON	Wildfire Consequence per Circuit Segment	Wildfire Consequence Unit (Specific to Model)
L2	PSPS Likelihood	Wind Load Condition 2, Weather Condition 1,	Technosylva Database	Technosylva WFA & FPI DIREXYON	PSPS Likelihood per Circuit Segment	Wildfire Likelihood Unit (Specific to Model)

ID	Risk Component	Design Scenario(s)	Key Inputs	Source of Inputs (Data and/or Models)	Key Outputs	Units
		Vegetation Condition 1				
C2	PSPS Consequence	Wind Load Condition 2, Weather Condition 1, Vegetation Condition 1	Customer Data	Customer Information System DIREXYON	Customers impacted per circuit	Customers/circuit segment
LE	Equipment Ignition Likelihood	Wind Load Condition 2, Weather Condition 1, Vegetation Condition 1	Under Development Expect to use: Outage database, historical faults/ignitions	Distribution Asset Data, Historical Outages and Ignitions DIREXYON	Ignition Likelihood	Annualized ignition probability of ignition
LV	Contact from Vegetation Ignition Likelihood	Wind Load Condition 2, Weather Condition 1, Vegetation Condition 1	Under Development Expect to use: Outage database, historical faults/ignitions	Distribution Asset Data, Historical Outages and Ignitions DIREXYON	Ignition Likelihood	Annualized ignition probability of ignition
LO	Contact by Object Ignition Likelihood	Wind Load Condition 2, Weather Condition 1, Vegetation Condition 1	Under Development Expect to use: Outage database, historical faults/ignitions	Distribution Asset Data, Historical Outages and Ignitions DIREXYON	Ignition Likelihood	Annualized ignition probability of ignition

ID	Risk Component	Design Scenario(s)	Key Inputs	Source of Inputs (Data and/or Models)	Key Outputs	Units
LB	Burn Probability	Wind Load Condition 3, Weather Condition 1, Vegetation Condition 1, Vegetation Condition 3	Technosylva Database	Technosylva WFA	100m x 100m pixel destructive potential classification	Probability Units (Specific to Model)
WHI	Wildfire Hazard Intensity	Wind Load Condition 3, Weather Condition 1, Vegetation Condition 1, Vegetation Condition 3	Technosylva Database	Technosylva WFA	100m x 100m pixel destructive potential classification	Intensity Units (Specific to Model)
WEP	Wildfire Exposure Potential	Wind Load Condition 3, Weather Condition 1, Vegetation Condition 1, Vegetation Condition 3	Technosylva Database	Technosylva WFA NFDRS	100m x 100m pixel destructive potential classification	Exposure Units (Specific to Model)
WV	Wildfire Vulnerability	Wind Load Condition 3, Weather Condition 1,	Customer demographics and AFN population	Customer Information System	AFN population per circuit	Customers/circuit

ID	Risk Component	Design Scenario(s)	Key Inputs	Source of Inputs (Data and/or Models)	Key Outputs	Units
		Vegetation Condition 1, Vegetation Condition 3				
PEP	PSPS Exposure Potential	Wind Load Condition 3, Weather Condition 1, Vegetation Condition 1, Vegetation Condition 3	Under Development expect to use: Customer demographics and AFN population Technosylva Database	Under Development	Under Development	Under Development
PV	PSPS Vulnerability	Wind Load Condition 3, Weather Condition 1, Vegetation Condition 1, Vegetation Condition 3	Customer demographics and AFN population	Customer Information System	AFN population per circuit	Customers/circuit

6.2 Risk Analysis Framework

In this section of the WMP, the electrical corporation must provide a high-level overview of its risk analysis framework. This includes a summary of key modeling assumptions, input data, and modeling tools used.

At a minimum, the electrical corporation must evaluate the impact of the following factors on the quantification of risk:

- **Equipment / Assets** (e.g., type, age, inspection, maintenance procedures, etc.)
- **Topography** (e.g., elevation, slope, aspect, etc.)
- **Weather** – at a minimum this must include statistically extreme conditions based on weather history and seasonal weather
- **Vegetation** (e.g., type/class/species/fuel model, canopy height/base height/cover, growth rates, moisture content, inspection, clearance procedures, etc.)
- **Climate change** (e.g., long-term changes in seasonal weather; statistical extreme weather; impact of change on vegetation species, growth, moisture, etc.) at a minimum, this must include adaptations of historical weather data to current and forecasting future climate
- **Social vulnerability** (e.g., AFN, socioeconomic factors, etc.)
- **Physical vulnerability** (e.g., people, structures, critical facilities/infrastructure, etc.)
- **Coping capacities** (e.g., limited access/egress, etc.)

BVES uses its two in-house tools (Fire Safety Circuit Matrix and Risk-Based Decision-Making Model) as it has in the past that already incorporates most of the features listed above. Additionally, Bear Valley previously sought risk mapping and modeling information from REAX and Technosylva that incorporates wildfire risk and ignition potential in the current and projected climate conditions of 2050. In addition to these efforts, BVES has collaborated with DIREXYON to support their long-term risk planning efforts to make data-driven decisions. The details around the DIREXYON tool can be found in Section 6.1.1.

BVES has demonstrated its continued commitment to risk mitigation, and will continue to develop its current models and add additional capability to fully and holistically understand the dynamic wildfire risk facing BVES and the best measures to adopt to mitigate such risk.

6.2.1 Risk and Risk Component Identification

In this section, the electrical corporation must provide a brief narrative and one or more simple graphics describing the framework that defines its overall utility risk. At a minimum, the electrical corporation must define its overall risk as the comprehensive risk due to both wildfire and PSPS events across its service territory. This includes several

likelihood and consequence risk components that are aggregated based on the framework shown in Figure 6-2 below. The following paragraphs define each risk component.

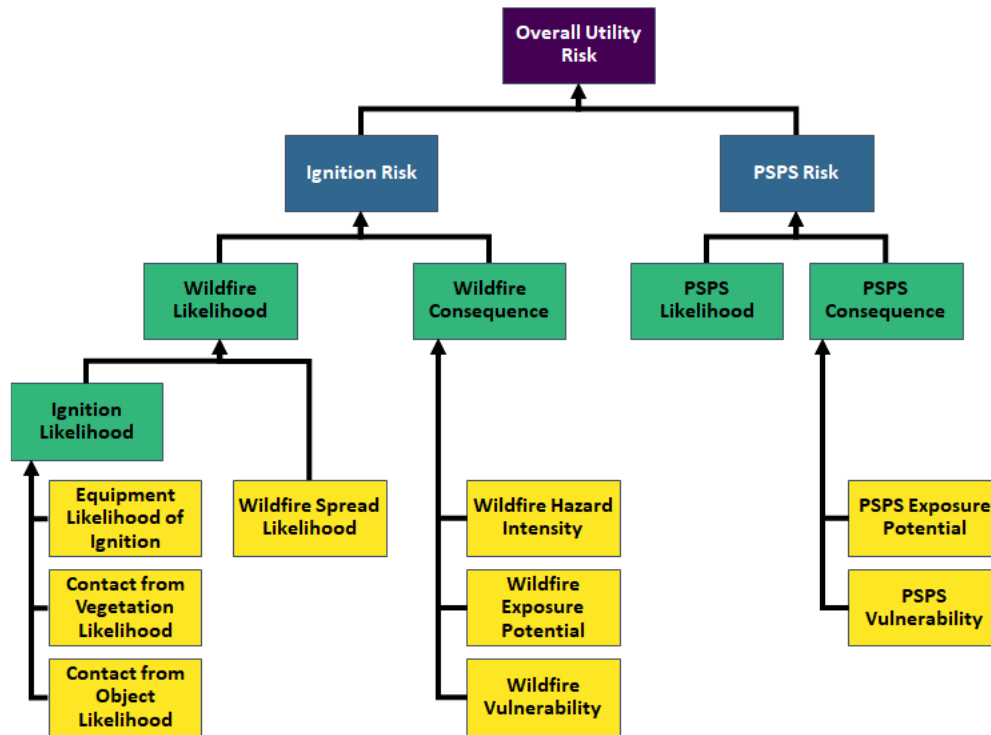

Figure 6-7 Composition of Overall Utility Risk (purple); Utility-related sources of risk including Ignition and PSPS Risks (blue); Intermediate Risk Components (green); and Fundamental Risk Components (yellow)

While the overall risk framework and associated risk components identified in Section 6.2 are the minimum requirements for determining overall risk, the electrical corporation may elect to include additional risk components, as needed, to better define risk for its service territory. Where the electrical corporation identifies additional terms as part of its risk framework, it must define those terms. The electrical corporation must include a schematic demonstrating its adopted risk framework (similar to Figure 6-2), including any components beyond minimum requirements.

As shown in Figure 6-1, overall utility risk is broken down into two individual hazard risks:

- **Ignition risk** – The total expected annualized impacts from ignitions at a specific location. This considers the likelihood that an ignition will occur, the likelihood the ignition will transition into a wildfire, and the potential consequences – considering hazard intensity, exposure potential, and vulnerability – the wildfire will have for each community it reaches
- **PSPS risk** – The total expected annualized impacts from PSPS at a specific location. This considers two factors: (1) the likelihood a PSPS will be required due to environmental conditions exceeding design conditions, and (2) the potential consequences of the PSPS for each affected community, considering exposure potential and vulnerability

The individual hazard risks are further broken down into 14 risk components. These risk components are split into two categories, intermediate and fundamental. Fundamental risk components are the smallest components of risk that the electrical corporation must determine as part of its risk analysis. Intermediate risk components are the likelihood and consequence related to each hazard. Each fundamental or intermediate risk component provides valuable insight in a electrical corporation's wildfire and PSPS risk calculations.

There are a minimum of five intermediate risk components:

- **Ignition likelihood** – The total anticipated annualized number of ignitions resulting from electrical corporation-owned assets at each location in the electrical corporation's service territory. This considers probabilistic weather conditions, type and age of equipment, and potential contact of vegetation and other objects with electrical corporation assets. This should include the use of any method used to reduce the likelihood of ignition. For example, the use of protective equipment and device settings to reduce the likelihood of an ignition upon an initiating event.
- **Wildfire likelihood** – The total anticipated annualized number of fires reaching each spatial location resulting from utility-related ignitions at each location in the electrical corporation service territory. This considers the ignition likelihood and the likelihood that an ignition will transition into a wildfire based on the probabilistic weather conditions in the area.
- **Wildfire consequence** – The total anticipated adverse effects from a wildfire on each community it reaches. This considers the wildfire hazard intensity, the wildfire exposure potential, and the inherent wildfire vulnerabilities of communities at risk (see definitions in the following list).
- **PSPS likelihood** – The likelihood of a electrical corporation requiring a PSPS given a probabilistic set of environmental conditions.
- **PSPS consequence** – The total anticipated adverse effects from a PSPS for a community. This considers the PSPS exposure potential and inherent PSPS vulnerabilities of communities at risk (see definitions in the following list).

There are a minimum of nine fundamental risk components:

- **Equipment ignition likelihood** – The likelihood that electrical corporation-owned equipment will cause an ignition either through normal operation (such as arcing) or through failure.
- **Contact from vegetation ignition likelihood** – The likelihood that vegetation will contact electrical corporation-owned equipment and result in an ignition.
- **Contact by object ignition likelihood** – The likelihood that a non-vegetative object (such as a balloon or vehicle) will contact electrical corporation-owned equipment and result in an ignition.
- **Wildfire spread likelihood** – The likelihood that a fire with a nearby but unknown ignition point will transition into a wildfire and will spread to a location in the service territory based on a probabilistic set of weather profiles, vegetation, and topography.
- **Wildfire hazard intensity** – The potential intensity of a wildfire at a specific location within the service territory given a probabilistic set of weather profiles, vegetation, and topography.
- **Wildfire exposure potential** – The potential physical, social, or economic impact of wildfire on people, property, critical infrastructure, livelihoods, health, environmental services, local economies, cultural/historical resources, and other high-value assets. These may include direct or indirect impacts, as well as short- and long-term impacts.
- **Wildfire vulnerability** – The susceptibility of people or a community to adverse effects of a wildfire, including all characteristics that influence their capacity to anticipate, cope with, resist, and recover from the adverse effects of a wildfire (e.g., AFN, SVI, age of structures, firefighting capacities).
- **PSPS exposure potential** – The potential physical, social, or economic impact of a PSPS event on people, property, critical infrastructure, livelihoods, health, local economies, and other high-value assets.
- **Vulnerability of community to PSPS (PSPS vulnerability)** – The susceptibility of people or a community to adverse effects of a PSPS event, including all characteristics that influence their capacity to anticipate, cope with, resist, and recover from the adverse effects of a PSPS event (e.g., high AFN population, poor energy resiliency, low socioeconomics).

The electrical corporation must adopt these definitions in this section of the WMP. If the electrical corporation considers additional intermediate and fundamental risk components, it must define those components in this section as well.

Figure 6-1 and Figure 6-2 in Section 6.1.1 illustrate BVES's overall utility risk assessment framework. BVES's overall risk is comprised of the risk stemming from both wildfire and PSPS events across its service territory. This includes several likelihood and consequence risk components that are aggregated based on the framework shown in Figure 6-7. The following paragraphs define each risk component.

As shown in Figure 6-7 above, overall utility risk is broken down into two individual hazard risks:

- Ignition risk – The total expected annualized impacts from ignitions at a specific location. This considers the likelihood that an ignition will occur, the likelihood the ignition will become a wildfire, and the potential consequences – considering hazard intensity, exposure potential, and vulnerability –for each community the wildfire reaches
- PSPS risk – The total expected annualized impacts from PSPS at a specific location. This considers two factors: (1) the likelihood a PSPS will be required due to environmental conditions exceeding design conditions, and (2) the potential consequences of the PSPS for each affected community, considering exposure potential and vulnerability

The individual hazard risks are further broken down into 14 risk components. These risk components are split into two categories, intermediate and fundamental. Fundamental risk components are the inherent risk components that BVES must determine as part of its risk analysis. Intermediate risk components are the likelihood and consequence related to each hazard. Each fundamental or intermediate risk component provides valuable insight in BVES's wildfire and PSPS risk calculations.

There are five intermediate risk components:

1. Ignition likelihood – The total anticipated annualized number of ignitions resulting from electrical corporation-owned assets at each location in the electrical corporation's service territory. This considers probabilistic weather conditions, type and age of equipment, and potential contact of vegetation and other objects with electrical corporation assets. This also includes the use of any method used to reduce the likelihood of ignition. For example, the use of protective equipment and device settings to reduce the likelihood of an ignition upon an initiating event.
2. Wildfire likelihood – The total anticipated annualized number of fires reaching each spatial location resulting from utility-related ignitions at each location in the electrical corporation service territory. This considers the ignition likelihood and the likelihood that an ignition will become a wildfire based on the probabilistic weather conditions in the area.
3. Wildfire consequence – The total anticipated adverse effects from a wildfire on each community it reaches. This considers the wildfire hazard intensity, the wildfire exposure potential, and the inherent wildfire vulnerabilities of communities at risk (see definitions in the following list).
4. PSPS likelihood – The likelihood of an electrical corporation requiring a PSPS given a probabilistic set of environmental conditions.

5. PSPS consequence – The total anticipated adverse effects from a PSPS for a community. This considers the PSPS exposure potential and inherent PSPS vulnerabilities of communities at risk (see definitions in the following list).

There are nine fundamental risk components:

1. Equipment ignition likelihood – The likelihood that electrical corporation-owned equipment will cause an ignition either through normal operation or through failure.
2. Contact from vegetation ignition likelihood – The likelihood that vegetation will contact electrical corporation-owned equipment and result in an ignition.
3. Contact by object ignition likelihood – The likelihood that a non-vegetative object (such as a balloon or vehicle) will contact electrical corporation-owned equipment and result in an ignition.
4. Wildfire spread likelihood – The likelihood that a fire with a nearby, but unknown, ignition point will become a wildfire and spread to a location in the service territory based on a probabilistic set of weather profiles, vegetation, and topography.
5. Wildfire hazard intensity – The potential intensity of a wildfire at a specific location within the service territory given a probabilistic set of weather profiles, vegetation, and topography.
6. Wildfire exposure potential – The potential physical, social, or economic impact of wildfire on people, property, critical infrastructure, livelihoods, health, environmental services, local economies, cultural/historical resources, and other high-value assets. These may include direct or indirect impacts, as well as short- and long-term impacts.
7. Wildfire vulnerability – The susceptibility of people or a community to adverse effects of a wildfire, including all characteristics that influence their capacity to anticipate, cope with, resist, and recover from the adverse effects of a wildfire (e.g., AFN, SVI, age of structures, firefighting capacities).
8. PSPS exposure potential – The potential physical, social, or economic impact of a PSPS event on people, property, critical infrastructure, livelihoods, health, local economies, and other high-value assets.
9. Vulnerability of community to PSPS (PSPS vulnerability) – The susceptibility of people or a community to adverse effects of a PSPS event, including all characteristics that influence their capacity to anticipate, cope with, resist, and recover from the adverse effects of a PSPS event (e.g., high AFN population, poor energy resiliency, low socioeconomics).

BVES has adopted these definitions for its 2023 WMP and for future risk assessments. Table 6-1 Table 6 describes how these individual hazard risks, intermediate risk components and fundamental risk components are address in BVES current models and future developments. The implementation of Technosylva’s WRRM and its modeling software is currently underway. As part of this implementation, BVES will have better access to the information required in this section. BVES is currently using its two in-house tools (Fire Safety Circuit Matrix and Risk-Based Decision-Making Model) as it has in the past that already incorporates most of the features listed above through SME evaluation. Bear Valley had previously sought and obtained risk mapping and modeling information that incorporates wildfire risk and ignition potential in the

current and projected climate conditions of 2050. This product was static, a snapshot in time. BVES will continue to develop its current models and add additional capability through Technosylva’s WFA-E and WRRM until the time BVES is fully able to holistically understand the dynamic ignition and PSPS risk facing BVES. Additionally, BVES contracted with DIREXYON in 2023 to utilize Technosylva data to model risk mitigation decision-making scenarios to maximize risk reduction efforts, and properly understand the short-term and long-term costs associated with the contemplated strategies.

6.2.2 Risk and Risk Components Calculation

The electrical corporation must calculate each risk and risk component defined in Section 6.2.1. Appendix B provides additional requirements on these calculations. These are the minimum requirements and are intended to establish the baseline evaluation and reporting of all electrical corporations. If the electrical corporation identifies other key factors as important, it must report them in the WMP in a similar format.

The electrical corporation must provide schematics illustrating the calculation of each risk and risk component as necessary to demonstrate the logical flow from input data to outputs, including separate items for any intermediate calculations. An example calculation schematic is provided for the equipment likelihood of ignition in Figure 6-2.

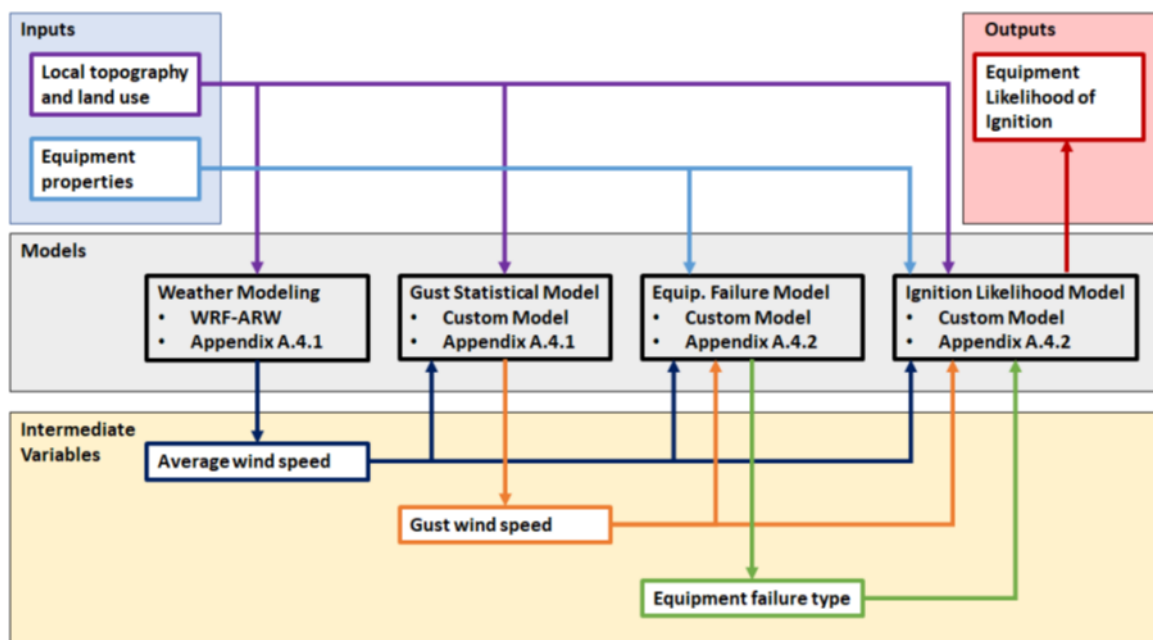

Figure 6-8 Example Calculation Schematic

The electrical corporation must summarize any differences between its calculation of these risk components and the requirements of these Guidelines. These differences may include any of the following:

- **Additional input parameters** beyond the minimum requirements for a specific risk component
- **Calculations of additional outputs** beyond the minimum requirements for a specific risk component
- **Calculations of additional risk components** defined by the electrical corporation in Section 6.2.1

The process used to combine risk components must be summarized for each relevant risk component. This process must align with applicable CPUC decisions regarding the inclusion of Risk Assessment and Mitigation Phase (RAMP) filings. If scaling factors (such as multi-attribute value functions [MAVFs] or representative cost) are used in this combination, the electrical corporation must present a table with all relevant information needed to understand this

procedure. The electrical corporation must organize this discussion into the following two subsections focusing on likelihood and consequence.

BVES calculates Wildfire risk and PSPS risk in accordance with the safety model approach for Small and Multi-Jurisdictional Utilities (SMJU) provided in CPUC D. 19-04-020 of April 25, 2019, using its Risk Register Model. The following intermediate risk components are determined by SME evaluation as inputs to the model:

- Wildfire likelihood
- Wildfire consequence
- PSPS likelihood
- PSPS consequence

Likelihood is determined by SMEs evaluation on a simple 1 to 7 scale with 1 being “occurs once every 100+ years” and 7 being “> 10 times per year”.

Consequence is determined by SMEs evaluation on the impact to the following impact weighted components:

Reliability	Compliance	Quality of Service	Safety	Environmental
12.1%	17.1%	7.2%	60.5%	3.1%

Once likelihood and consequence are assigned values, risk (Wildfire and PSPS risk) is calculated using the following formula:

$$\text{Risk score} = \sum_{i=1}^n \text{weight}_i * \text{frequency}_i * 10^{\text{impact}_i}$$

This results in risk score which can be plotted on a 7-by 7-logarithmic risk heat map. The following diagram illustrates this process.

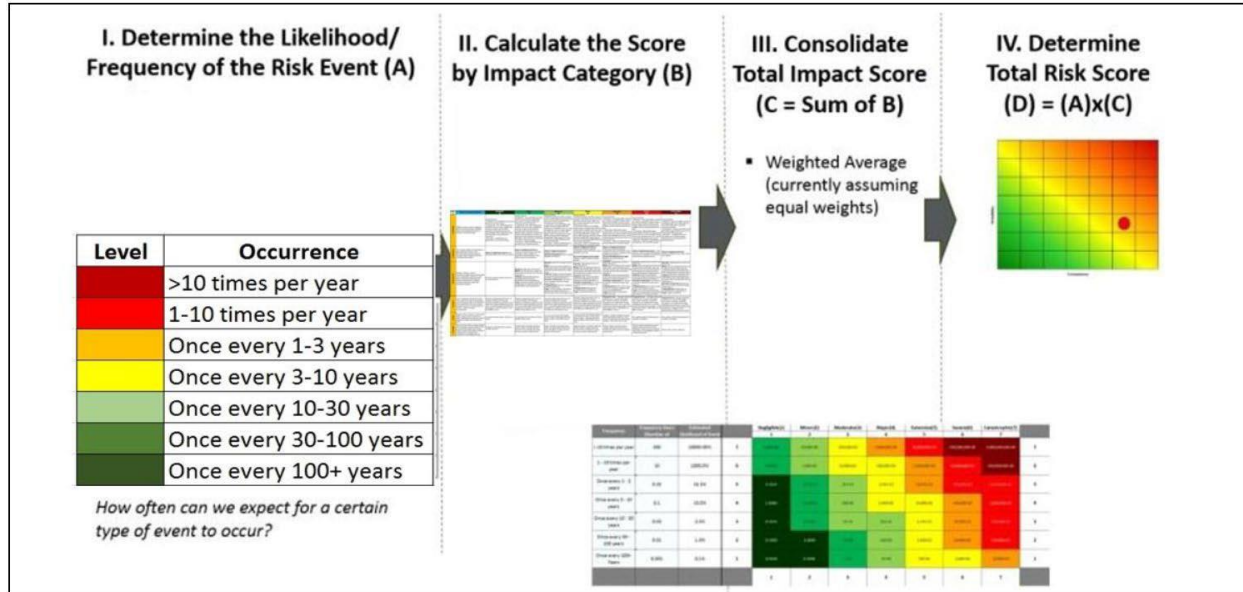

Figure 6-9 Risk Model Process Diagram

BVES currently obtains ignition risk as an output from the Technosylva WFA-E model and REAX models. BVES obtains its fire activity potential as an output from the Technosylva FPI model. The FPI model is specifically customized to BVES service territory and quantifies the fire activity potential over the territory based on different parameters including fuels, terrain, and weather. The FPI values are then assigned a score as seen in Figure 6-10.

FPI categories	FPI value	FPI percentile
Very Low	< 5	<60
Low	5-10	60-80
Moderate	10-13.5	80-85
High	13.5-23	85-95
Very High	23-37.5	95-99
Extreme	> 37.5	>99

Figure 6-10 FPI Value and Percentile Table

FPI will be used to assist BVES to make operational decisions regarding the sub-transmission and distribution system. As shown in the table above, as FPI increases, the risk of wildfire increases. Therefore, the BVES Team will initiate operational and customer procedures to mitigate wildfire. These procedures include the implementation of Public Safety Power Shut-off as a measure of last resort.

When sub-transmission and distribution facilities are in areas where the FPI is designated as “High,” “Very High,” or “Extreme,” the circuit is designated as being under “consideration”. When facilities are designated as being “under consideration,” the Management and the Operations Team will evaluate the facilities for their condition (material condition, level of grid hardening, level of protective equipment and automation, etc.), status (energized, loading, etc.), scheduled work and maintenance, status of situational awareness monitoring equipment, actual weather, other weather forecasts, staff resources, etc. The Customer Service Team will review notification procedures for the affects area(s).

When sub-transmission and distribution facilities are in areas where the FPI is designated as “Very High” or “Extreme,” the circuit is designated as being under “in scope”. When facilities are designated as “in scope,” all actions required for circuits “under consideration” will be taken. Additionally, BVES will start making preparations for possible PSPS implementation on affected circuits.

At present BVES does not have any plans to update the FPI, and plans to continue to evaluate the benefits of the model and its outputs in its current state.

6.2.2.1 Likelihood

The electrical corporation must calculate the likelihood that its equipment (through normal operations or failure) will result in a catastrophic wildfire and the resulting likelihood of issuing a PSPS. The risk components discussed in this section must include at least the following:

- *Ignition likelihood*
- *Equipment failure likelihood of ignition*
- *Contact from vegetation likelihood of ignition*
- *Contact from object likelihood of ignition*
- *Burn Probability*
- *PSPS likelihood*

As discussed in Section 6.2.2, BVES determines PSPS likelihood by SMEs evaluation on a simple 1 to 7 scale with 1 being “occurs once every 100+ years” and 7 being “> 10 times per year.” This is an input to the Risk Register Model.

BVES now obtains ignition likelihood as calculated output from the Technosylva’s WFA-E model on at least a daily basis. This output is currently used in qualitatively evaluating PSPS likelihood and consequently PSPS risk. Technosylva developed and delivered a Fire Potential Index (FPI) to calculate PSPS risk in a quantitative manner in 2023 and BVES has begun incorporating it into daily planning in 2024. BVES will continue working with Technosylva and DIREXYON to calculate all likelihood components including the following:

- Equipment failure likelihood of ignition
- Contact from vegetation likelihood of ignition
- Contact from object likelihood of ignition
- Burn Probability
- PSPS likelihood

6.2.2.2 Consequence

The electrical corporation must calculate the consequences of a fire originating from its equipment and the consequence of implementing a PSPS event to prevent a catastrophic wildfire in the community. The risk components discussed in this section must include at least the following:

- *Wildfire consequence*
- *Wildfire hazard intensity*
- *Wildfire exposure potential*
- *Wildfire vulnerability*
- *PSPS consequence*
- *PSPS exposure potential*
- *PSPS vulnerability*

As discussed in Section 6.2.2. BVES determines consequence (Wildfire and PSPS) by SMEs evaluation on the impact to the following weighted components:

Reliability	Compliance	Quality of Service	Safety	Environmental
12.1%	17.1%	7.2%	60.5%	3.1%

The results of the SME evaluation are then input into the Risk Register Model as described in Section 6.2.2.

BVES is moving to calculate all consequence components via Technosylva’s WFA-E and WRRM models in a quantitative manner. Currently, BVES can obtain wildfire consequence as a calculated output from the WFA-E model. The following risk components are not calculated in BVES’s risk modeling process (gaps in BVES risk process):

- Wildfire hazard intensity
- Wildfire exposure potential
- Wildfire vulnerability
- PSPS consequence
- PSPS exposure potential
- PSPS vulnerability

BVES is working with Technosylva and DIREXYON on this capability. At present, BVES’s collaboration with DIREXYON has yielded its phase 1 risk modeling analysis that is set to be implemented by the third quarter of 2024. This effort gives a long-term insight into the wildfire and PSPS exposure potential, vulnerability, and consequence. Through these efforts, BVES will be able to make data-driven decisions around mitigation efforts.

6.2.2.3 Risk

The electrical corporation must calculate each risk and the resulting overall risk defined in Section 6.2.1. The discussion in this section must include at least the following:

- Ignition risk
- PSPS risk
- Overall utility risk

BVES calculates Wildfire risk and PSPS risk as an output of its Risk Register Model as described in Section 6.2.2. BVES obtains Ignition Risk as a calculated output of Technosylva’s WFA-E model. BVES has not directly calculated Overall Utility Risk but has qualitatively evaluated such risk based on its calculated Ignition Risk, PSPS Risk, and Wildfire Risk. BVES recognizes that not calculating PSPS risk quantitatively is a gap in BVES’s risk process. BVES has received the Fire Potential Index (FPI) model and is currently evaluating PSPS risk daily.

With the implementation of Technosylva's models (WFA-E, WRRM and FPI), BVES is conducting long-term risk mitigation planning and review the overall risk levels for the utility on a pre-mitigation, post-mitigation, and mitigation decision basis. FPI also allows BVES to make operational decisions based on real-time fire activity potential.

Additionally, with the introduction of the DIREXYON risk modeling efforts, described in detail in Section 6.1.1, BVES now has the capability to conduct long-term risk mitigation planning and review the risk levels for the utility through the models that are developed by DIREXYON. This new data driven impact assessment allows BVES to observe where the greatest wildfire risk exists within the network and plan the mitigation response accordingly on a longer term basis.

6.2.3 Key Assumptions and Limitations

Because the individual elements of risk assessment are interdependent, the interfaces between the various risk models and mitigation initiatives must be internally consistent. In this section of the WMP, the electrical corporation must discuss key assumptions, limitations, and data standards for the individual elements of its risk assessment. This must include the following:

- **Key modeling assumptions** made specific to each model to represent the physical world and to simplify calculations
- **Data standards**, which must be consistently defined (e.g., weather model predictions at a 30-ft [10-m] height must be converted to the correct height for fire behavior predictions, such as mid-flame wind speeds)
- **Consistency of assumptions and limitations** in each interconnected model, which must be traced from start to finish, with any discrepancies between models discussed
- **Stability of assumptions in the program**, including historical and projected changes

More mature programs regularly monitor and evaluate the scope and validity of modeling assumptions. Monitoring and evaluation categories may include:

- **Adaptation of weather history** to current and forecasted climate conditions
- **Availability of suppression resources** including type, number of resources, and ease of access to incident location
- **Height of wind driving fire spread** / wind adjustment factor calculation
- **General equipment failure rates** / wind speed functional dependence for unknown components
- **General vegetation contact rates** / wind speed functional dependence for unknown species
- Height of electrical equipment in the service territory
- **Stability of the atmosphere** and resulting calculation of near-surface winds
- **Vegetative fuels** and fuel models including adaptations based on fuel management activities by other Public Safety Partners
- **Combination of risk components / weighting of attributes** in alignment with most recent decision issued by the CPUC for inclusion in RAMP filings
- Wind load capacity for electrical equipment in the service territory
- Number, extent, and type of community assets at risk in the service territory

- Proxies for estimating impact on customers and communities in the service territory
- Extent, distribution, and characteristics of vulnerable populations in the service territory

The electrical corporation must document each assumption in Table 6-2, see the exemplar provided below. The electrical corporation must summarize detailed assumptions made within models in accordance with the model documentation requirements in Appendix B.

Key modeling assumptions and limitations to BVES’s Risk Register Model include the following:

- Key modeling assumptions are made specifically to each model to represent the physical world and to simplify calculations: The model evaluates each mitigation measure in isolation of other mitigation measures to calculate risk benefit.
- Data standards: Currently BVES utilizes SME evaluation of likelihood and consequence instead of raw data input. SME’s evaluate data sources such as outage log, LiDAR surveys, asset hardening, etc. in developing their evaluations. While the data is largely standardized and consistent, the input to the model from the data can fluctuate somewhat due to the inherent subjectivity of the SME’s interpretation of the data.
- Consistency of assumptions and limitations in each interconnected model, which must be traced from start to finish, with any discrepancies between models discussed: Assumptions made in the Risk Register Model are consistent with the Fire Safety Circuit Matrix since the Risk Register Model is used to determine mitigations to be implemented and the Fire Safety Circuit Matrix is used to prioritize the mitigations.
- Stability of assumptions in the program: Because the determination of likelihood and consequence is by SME evaluation, stability of the assumptions is susceptible to instability when SMEs change.

Table 6-2 below provides risk modeling assumptions provided by Technosylva with respect to the WFA-E model.

Table 6-2 Risk Modeling Assumptions and Limitations as provided by Technosylva

<i>Assumption</i>	<i>Justification</i>	<i>Limitation</i>	<i>Applicable Models</i>
The physical framework development is based on an idealized situation in steady state spread which may not fit some extreme behavior of fires.	N/A	N/A	WFA-E
Fuels are assumed to be continuous and uniform for the scale of the input (typically between 10-to-30-meter (m) resolution).	N/A	N/A	WFA-E
Fire characteristics at a point only depends on the conditions at that point (point-functional model). This means that there are certain non-local phenomena like: <ul style="list-style-type: none"> • Increase of ROS due to a concave front. • Fire interaction between different parts of the same fire or a different one. 	N/A	N/A	WFA-E
Fire spread is assumed to be elliptical although there are several variations such as double ellipse, oval, egg-shape, etc.	N/A	N/A	WFA-E

Assumption	Justification	Limitation	Applicable Models
Weather is given hourly and is assumed to remain constant during that time. There is no interpolation in time to compute evolution of weather between hours.	N/A	N/A	WFA-E
Reliability of weather inputs in the mid-range forecast (2 to 5 days).	N/A	N/A	WFA-E
Fire is not coupled with the atmosphere in any way. This may seem like a major limitation in the model as wind is a main contribution to fire spread and at present many models (especially physical ones) try to couple wind and fire. The main reasons for us not to consider the coupling is: <ul style="list-style-type: none"> • It would make it unfeasible to run millions of simulations considering the coupling effect. • Empirical and semi-empirical models have been developed using an average wind speed as an input, so it is not clear that considering more granular wind at the front is advisable. 	N/A	N/A	WFA-E
Fire is always assumed to be fully developed. Fire acceleration, flashover, or decay is not considered.	N/A	N/A	WFA-E
Atmospheric instability which may have a deep impact on ROS (beer 1991) is not considered in the model.	N/A	N/A	WFA-E
Gusts are not considered in the model.	N/A	N/A	WFA-E
No interaction between slope and wind other than creating an effective or equivalent wind. This means that fire is assumed to have an elliptical shape no matter the alignment of wind and slope.	N/A	N/A	WFA-E
Models have been developed with scares empirical data. The abundance of today's fire data sources, however, is allowing us to better adjust models to observed fire patterns.	N/A	N/A	WFA-E
Fuel array description of the vegetation may not perfectly describe fuel characteristics.	N/A	N/A	WFA-E
Spotting is only considered in surface fires.	N/A	N/A	WFA-E

As BVES has implemented quantitative risk models (Technosylva's WFA-E and WRRM), BVES will continue to regularly monitor and evaluate the scope and validity of modeling assumptions to include as applicable the following monitoring and evaluation categories:

- Adaptation of weather history to current and forecasted climate conditions
- Availability of suppression resources including type, number of resources, and ease of access to incident location
- Height of wind driving fire spread / wind adjustment factor calculation

- General equipment failure rates / wind speed functional dependence for unknown components
- General vegetation contact rates / wind speed functional dependence for unknown species
- Height of electrical equipment in the service territory
- Stability of the atmosphere and resulting calculation of near-surface winds
- Vegetative fuels and fuel models including adaptations based on fuel management activities by other Public Safety Partners
- Combination of risk components / weighting of attributes in alignment with most recent decision issued by the CPUC for inclusion in RAMP filings
- Wind load capacity for electrical equipment in the service territory
- Number, extent, and type of community assets at risk in the service territory
- Proxies for estimating impact on customers and communities in the service territory
- Extent, distribution, and characteristics of vulnerable populations in the service territory

6.3 Risk Scenarios

In this section of the WMP, the electrical corporation must provide a high-level overview of the scenarios to be used in its risk analysis in Section 6.2. These must include at least the following:

- **Design basis scenarios** that will inform the electrical corporation's long-term wildfire mitigation initiatives and planning
- **Extreme-event scenarios** that may inform the electrical corporation's decisions to provide added safety margin and robustness

The risk scenarios described in Sections 6.3.1 and 6.3.2 below are the minimum scenarios the electrical corporation must assess in its wildfire and PSPS risk analysis. The electrical corporation must also describe and justify any additional scenarios it evaluates.

Each scenario must consider:

- **Local relevance** – Heterogeneous conditions (e.g., assets, equipment, topography, vegetation, weather) that vary over the landscape of the electrical corporation's service territory at a level sufficiently granular to permit understanding of the risk at a specific location or for a specific circuit segment. For example, statistical wind loads must be calculated based on wind gusts considering the impact of nearby topographic and environmental features, such as hills, canyons, and valleys
- **Statistical relevance** – Percentiles used in risk scenario selection must consider the statistical history of occurrence and must be designed to describe a reasonable return interval / probability of occurrence. For example, designing to a wind load with a 10,000-year return interval may not be desirable as most conductors in the service territory would be expected to fail (i.e., the scenario does not help discern which areas are at elevated risk)

For BVES's Risk Register Model, it considers a reasonable extreme-event scenario for the three primary wildfire risk events, which are:

- Wildfire Public Safety
- Wildfire – Significant Loss of Property
- Loss of Energy Supplies (PSPS)

With the implementation of the Technosylva models (WFA-E, WRRM and FPI), BVES and the introduction of DIREXYON, BVES is now able to conduct long-term risk mitigation planning and review the overall risk levels for the utility on a pre-mitigation, post-mitigation, and mitigation

decision basis. FPI also allows BVES to make operational decisions based on real-time fire activity potential.

6.3.1 Design Basis Scenarios

Fundamental to any risk assessment is the selection of one or more relevant design basis scenarios (design scenarios). These scenarios will inform long-term mitigation initiatives and planning. In this section, the electrical corporation must identify the design scenarios it has prioritized from a comprehensive set of possible scenarios. The scenarios identified must be based on the unique wildfire and PSPS risk characteristics of the electrical corporation's service territory and achieve the primary goal and stated objectives of its WMP. At a minimum, the following design scenarios representing statistically relevant weather and vegetative conditions must be considered throughout the service territory.

For wind loading on electrical equipment, the electrical corporation must consider at least four statistically relevant design conditions. It must calculate wind loading based on locally relevant 3-second wind gusts over a 30-year wind speed history during fire season in its service territory. The conditions are the following:

- **Wind Load Condition 1 – Baseline** – The baseline wind load condition the electrical corporation use in design, construction, and maintenance relative to GO 95, Rule 31.1.
- **Wind Load Condition 2 – Very High** – 95th-percentile wind gusts based on maximum daily values over the 30-year history. This corresponds to a probability of exceedance of 5 percent on an annual basis (i.e., 20-year return interval) and is intended to capture annual high winds observed in the region (e.g., Santa Ana winds).
- **Wind Load Condition 3 – Extreme** – Wind gusts with a probability of exceedance of 5 percent over the three-year WMP cycle (i.e., 60-year return interval).
- **Wind Load Condition 4 – Credible Worst Case** – Wind gusts with a probability of exceedance of 1 percent over the three-year WMP cycle (i.e., 300-year return interval).

The data and/or models the electrical corporation uses to establish locally relevant wind gusts for these design conditions must be documented in accordance with the weather analysis requirements described in Appendix B.

For weather conditions used in calculating fire behavior, the electrical corporation must use probabilistic scenarios based on a 30-year history of fire weather. This approach must consider a range of wind speeds, directions, and fuel moistures that are representative of historic conditions. In addition, the electrical corporation must discuss how this weather history is adapted to align with current and forecasted climate conditions. The electrical corporation must consider the following two conditions:

- **Weather Condition 1 – Anticipated Conditions** – The statistical weather analysis is limited to fire seasons expected to be the most relevant to the next three years of the WMP cycle.
- **Weather Condition 2 – Long-Term Conditions** – The statistical weather analysis is representative of fire seasons covering the full 30-year history.

The electrical corporation must state how it defines “fire weather” and “fire season” for the calculations of these probabilistic scenarios.

One possible approach to the statistical weather analysis for fire behavior is Monte- Carlo simulation of synthetic fire seasons in accordance with approaches presented by the United States Forest Service.¹³ However, the electrical corporation must justify the selection of locally relevant data for use in this approach (i.e., Remote Automated Weather Systems data or historic weather reanalysis must be locally relevant). The data and/or models the electrical corporation uses to establish locally relevant weather data for these designs must be documented in accordance with the weather analysis requirements described in Appendix B.

For vegetative conditions not including short-term moisture content, the electrical corporation must evaluate design scenarios including the current and forecasted vegetative type and coverage. The conditions it must consider include the following:

- **Vegetation Condition 1 – Existing Fuel Load** – The wildfire hazard must be evaluated with the existing fuel load within the service territory, including existing burn scars and fuel treatments that reduce the near-term fire hazard.
- **Vegetation Condition 2 – Short-Term Forecasted Fuel Load** – The wildfire hazard must be evaluated considering the changes in expected fuel load over the three-year Base WMP cycle (2023-2025). At a minimum, this must include regrowth of previously burned and treated areas.
- **Vegetation Condition 3 – Long-Term Extreme Fuel Load** – The wildfire hazard must be evaluated considering the long-term potential changes in fuels throughout the service territory. This must include, at a minimum, regrowth of previously burned and treated areas and changes in predominant fuel types.

The data and/or models the electrical corporation uses to establish locally relevant fuel loads for these designs must be documented in accordance with the vegetation requirements described in Appendix B.

The electrical corporation must provide a brief narrative on the design basis scenarios used in its risk analysis. If the electrical corporation includes additional design scenarios, it must describe these scenarios and their purpose in the analysis. In addition, the electrical corporation must provide a table summarizing the following information:

- Identification of each design basis scenario (e.g., Scenario 1, Scenario 2)
- Components of each scenario (e.g., Weather Condition 1, Vegetation Condition 1)
- Purpose of each scenario

BVES utilizes a design scenario that most closely reflects Wind Loading Condition 1, Wind Loading Condition 2, Weather Condition 2, Vegetation Condition 1, and Vegetation Condition 3 for mitigation planning purposes in its risk frameworks.

Table 6-3 Summary of Design Basis Scenarios

Scenario ID	Design Scenario	Purpose	Reference
WL1	Wind Load Condition 1	Used in the Risk Register Model and in the application of the WFA-E and WRRM models.	WL1
WL2			WL2
WC2	Wind Load Condition 2		WC2
VC1	Weather Condition 2,		VC1
VC3	Vegetation Condition 1 Vegetation Condition 3		VC3

The following information was provided by Technosylva in response to the information requested in this section:

The WRRM analysis uses a subset of historical weather data to simulate wildfires on specific days, considering ignition points along utility assets. The resulting risk scores are then combined to provide a comprehensive assessment of the wildfire risk distribution. The selection of weather days to simulate is based on a careful consideration of both typical and extreme conditions throughout the historical weather data, ensuring that the resulting risk distribution accurately reflects the full range of potential scenarios. Every year, the WRRM analysis is

performed using the latest available weather data to ensure its relevance for the upcoming WMP cycles, thus maintaining its accuracy and effectiveness over time.

For wind loading on electrical equipment, BVES will consider at least four statistically relevant design conditions. It will calculate wind loading based on locally relevant 3-second wind gusts over a 30-year wind speed history during fire season in its service territory. The four conditions are the following:

- **Wind Load Condition 1 – Baseline** – The baseline wind load condition the electrical corporation use in design, construction, and maintenance relative to GO 95, Rule 31.1.
- **Wind Load Condition 2 – Very High** – 95th-percentile wind gusts based on maximum daily values over the 30-year history. This corresponds to a probability of exceedance of 5 percent on an annual basis (i.e., 20-year return interval) and is intended to capture annual high winds observed in the region (e.g., Santa Ana winds).
- **Wind Load Condition 3 – Extreme** – Wind gusts with a probability of exceedance of 5 percent over the three-year WMP cycle (i.e., 60-year return interval).
- **Wind Load Condition 4 – Credible Worst Case** – Wind gusts with a probability of exceedance of 1 percent over the three-year WMP cycle (i.e., 300-year return interval).

For weather conditions used in calculating fire behavior, the BVES will use probabilistic scenarios based on a 30-year history of fire weather. This approach will consider a range of wind speeds, directions, and fuel moistures that are representative of historic conditions in the BVES service area. BVES will consider the following two conditions:

- **Weather Condition 1 – Anticipated Conditions** – The statistical weather analysis is limited to fire seasons expected to be the most relevant to the next three years of the WMP cycle.
- **Weather Condition 2 – Long-Term Conditions** – The statistical weather analysis is representative of fire seasons covering the full 30-year history.

BVES is working with Technosylva to develop how it intends to define “fire weather” and “fire season” for the calculations of these probabilistic scenarios.

For vegetative conditions not including short-term moisture content, BVES will evaluate design scenarios including the current and forecasted vegetative type and coverage. The conditions BVES will consider include the following:

- **Vegetation Condition 1 – Existing Fuel Load** – The wildfire hazard must be evaluated with the existing fuel load within the service territory, including existing burn scars and fuel treatments that reduce the near-term fire hazard.
- **Vegetation Condition 2 – Short-Term Forecasted Fuel Load** – The wildfire hazard must be evaluated considering the changes in expected fuel load over the three-year Base WMP cycle (2023-2025). At a minimum, this must include regrowth of previously burned and treated areas.

Vegetation Condition 3 – Long-Term Extreme Fuel Load – The wildfire hazard must be evaluated considering the long-term potential changes in fuels throughout the service territory.

This must include, at a minimum, regrowth of previously burned and treated areas and changes in predominant fuel types.

6.3.2 Extreme-Event Scenarios/Uncertainty Scenarios

In this section, the electrical corporation must identify extreme scenarios that it considers in its risk analysis. These generally include the following types of scenarios:

- *Longer-term scenarios with higher uncertainty (e.g., climate change impacts, population migrations, extended drought)*
- *Multi-hazard scenarios (e.g., ignition from another source during a PSPS)*
- *High-consequence but low-likelihood (“Black Swan”) events (e.g., acts of terrorism, 10,000-year weather)*

While the primary risk analysis is intended to be based on the design scenarios discussed in Section 6.3.1, the potential for high consequences from extreme events may provide additional insight into the mitigation prioritization described in Section 7.

The electrical corporation must provide a brief narrative on the extreme-event scenarios used in its risk analysis. The electrical corporation must describe these scenarios and their purpose in the analysis. In addition, the electrical corporation must provide a table summarizing the following information:

- *Identification of each extreme-event risk scenario (e.g., Scenario 1, Scenario 2)*
- *Components of each scenario (e.g., Weather Condition 1, Vegetation Condition 1)*
- *Purpose of the scenario*

BVES currently analyzes extreme events and highly uncertain scenarios. BVES will be working with Technosylva to develop a long-term extreme-event scenario as indicated in Table 6-4. BVES believes modeling the risk in 2030 is very relevant to ensuring grid hardening efforts are going to be effective at-risk reduction (Ignition Risk and PSPS Risk).

Table 6-4 Summary of Extreme-Event Scenarios

Scenario ID	Extreme-Event Scenario	Purpose
Not yet assigned	2030 Climate Conditions (mostly concerned with fuel levels and moisture)	Assess if climate change, as well as any resulting changes in wildfire consequence, may influence BVES’s existing grid hardening strategy.

This is not currently a capability within the Technosylva software program being provided to BVES. However, this capability is going to be available in the future based on discussions with Technosylva. Accordingly, BVES has discussed the possibility of adding this service with Technosylva. BVES will monitor developments in this area to determine whether such an approach is reasonable and prudent for a utility with the size and risk profile of Bear Valley.

BVES does not plan on developing the following extreme-event scenarios in the near-term:

- Multi-hazard scenarios (e.g., ignition from another source during a PSPS)
- High-consequence but low-likelihood (“Black Swan”) events (e.g., acts of terrorism, 10,000-year weather)

Once BVES has in place its quantitative risk modeling process, it will consider the above extreme-event scenarios; most likely in the 2026-2028 WMP timeframe.

6.4 Risk Analysis Results and Presentation

In this section of the WMP, the electrical corporation must present a high-level overview of the risks calculated using the approaches discussed in Section 6.2 for the scenarios discussed in Section 6.3.

The risk presentation must include the following:

- *Summary of electrical corporation-identified high fire threat areas in the service territory*
- *Geospatial map of electrical corporation-identified areas with heightened risk of fire in the service territory*
- *Narrative discussion of proposed updates to HFTD*
- *Tabular summary of top risk-contributing circuits across the service territory*
- *Tabular summary of key metrics across the service territory*

The following subsections expand on the requirements for each of these.

6.4.1 Top Risk Areas within the HFRA

In this section, the electrical corporation must identify areas within its self-identified HFRA, compare these areas to CPUC’s current HFTD, and discuss how it plans to submit its proposed changes to the CPUC for review.

BVES primarily lies within the HFTD Tier 2 area, with a small portion reaching into a HFTD Tier 3 area along the Radford Line. BVES does not have any self-identified HFRA that are outside the CPUC’s HFTD. The presence of the HFTD Tier 3 and Tier 2 is included as part of the calculation to determine BVES’s highest risk areas as part of the Fire Safety Circuit Matrix and are incorporated into Technosylva’s WFA-E models as well as the REAX Engineering risk maps of the BVES service territory. The risk by circuit identified by the Fire Safety Circuit Matrix is included below in Table 6-5 in Section 6.4.2. This aligns with the other assessments including those from Technosylva and REAX.

BVES will continue to assess if the HFTD-2 and HFTD-3 boundaries need adjustment in 2023 and beyond.

6.4.1.1 Geospatial Maps of Areas with Heightened Risk of Fire

The electrical corporation must evaluate the outputs from its risk modeling to identify top risk areas within its HFRA (independent of where they fall with respect to the HFTD). The electrical corporation must provide geospatial maps of these areas.

The maps must fulfill the following requirements:

- **Risk levels:** Levels must be selected to show at least three distinct levels, with the values based on the following:
 - Top 5 percent of overall utility risk values in the HFRA
 - Top 5 to 20 percent of overall utility risk values in the HFRA
 - Bottom 80 percent of overall utility risk values in the HFRA
- **Colormap** – The colormap of the contour must meet accessibility requirements (recommended colormap is Viridis)
- **County lines** – The map must include county lines as a geospatial reference
- **HFTD tiers** – The map must show a comparison with existing HFTD Tier 2 and Tier 3 regions.

BVES already identifies and maps its highest risk areas through the Technosylva products, the CPUC and Cal Fire maps, and the Fire Safety Circuit Matrix. The Fire Safety Circuit Matrix currently evaluates all BVES circuits and orders them by overall risk which includes both ignition risk and PSPS risk as well as the mitigation efforts BVES has undertaken to reduce those risks. As stated above, in Section 6.1.1, BVES is working with Technosylva on implementing the WRRM product to replace the use of the Fire Safety Circuit Matrix. The WRRM will include mapped displays of the highest risk circuits in the service territory. Additionally, BVES will monitor developments in this area to determine whether such an approach is reasonable and prudent for a utility with the size and risk profile of Bear Valley. See Appendix C for additional Fire Risk Maps.

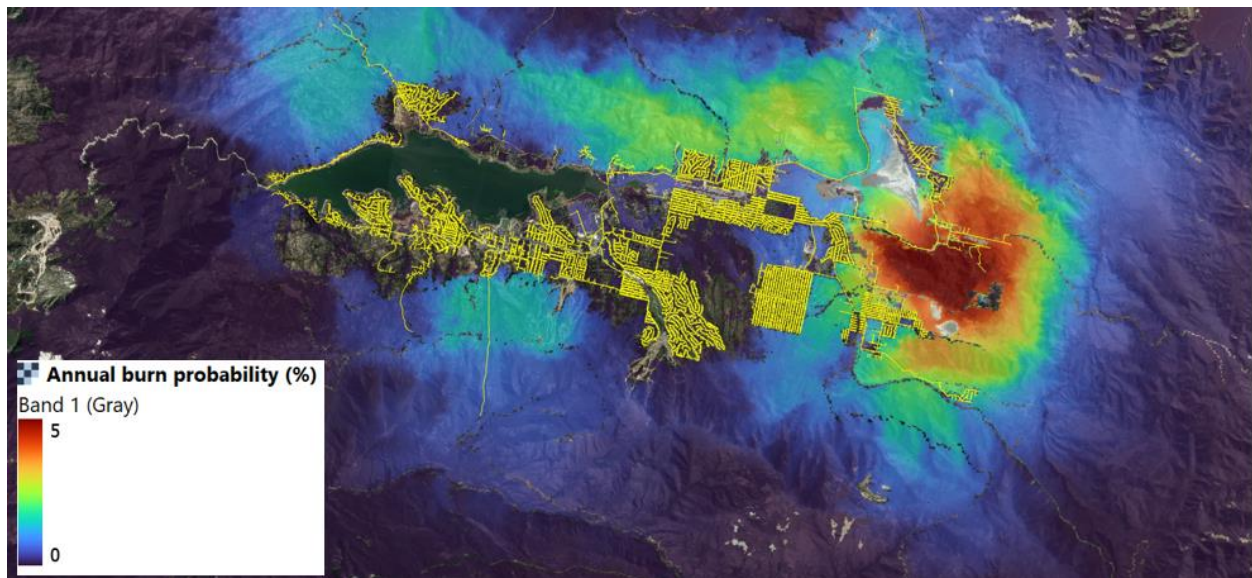

Figure 6-11 REAX – Risk Level Represented as Annualized Burn Probability

6.4.1.2 Proposed Updates to HFTD

In this section, the electrical corporation must discuss the differences between the electrical corporation-identified areas with heightened fire risk and the existing Commission-approved HFTD. The electrical corporation must identify areas that its risk analysis indicates are at a higher risk than indicated in the current HFTD. The electrical corporation must also describe its proposed process to submit proposed changes to the Commission to modify the HFTD. The

electrical corporation need not conclude that the HFTD should be expanded and/or modified. Any proposed changes to the HFTD must be mapped in accordance with the requirement in the previous sub-section.

Currently, BVES does not see a need for any changes to the HFTD designations for the Bear Valley service territory of which nearly all the territory is Tier 2 with a small area of Tier 3 along the Radford Line. BVES already identifies and maps its highest risk areas through the Technosylva products, the CPUC and Cal Fire maps, and the Fire Safety Circuit Matrix. If conditions change, due to changes in land use, vegetation density, or climatological factors, BVES will propose such changes to the Commission.

6.4.2 Top Risk-Contributing Circuits/Segments/Spans

The electrical corporation must provide a summary table showing the highest-risk circuits/segments¹⁴ within its service territory. The table should include the following information about each circuit:

- **Circuit, Segment, or Span ID** – unique identifier for the circuit, segment, or span
- **Overall Utility Risk Scores** – numerical value for each risk
- **Top Risk Contributors** – the risk components that lead to the high risk on the circuit

The electrical corporation must rank its circuits, segments, or spans by circuit-mile-weighted overall utility risk score and identify each circuit, segment, or span that significantly contributes to risk. A circuit/segment/span significantly contributes to risk if it:

1. Individually contributes more than 1 percent of the total overall utility risk; or
2. Is in the top 5 percent of highest risk circuits/segments/spans when all circuits/segments/spans are ranked individually from highest to lowest risk.

Table 6-5 Summary of Top-Risk Circuits/Segments

Risk Ranking	Circuit/Segment ID	Overall Risk Score	Ignition Risk Score	PSPS Risk Score	Top Risk Contributors
1	Radford	31214.88	60	30	31215
2	Baldwin	6890.98	30	60	6891
3	North Shore (Fawnskin)	6717.23667	30	30	6717
4	Holcomb (Bear City)	4746.15	30	30	4746
5	Goldmine	4538.8	30	30	4538
6	Shay	3524.49667	30	60	3524
7	Clubview	3225.04	30	30	3225
8	Pioneer (Palomino)	2729.88	30	30	2730
9	Sunset	2373.52	30	30	2374
10	Sunrise (Maple)	1856.69	30	30	1857
11	Eagle	1812.68667	30	30	1813
12	Paradise	1809.54667	30	30	1810
13	Lagonita	1533.14	30	30	1533
14	Interlaken	1485.16	30	30	1485
15	Castle Glen (Division)	1483.32	30	30	1483
16	Georgia	1384.19	30	30	1384
17	Garstin	1366.31	30	30	1366
18	Boulder	882.12	30	30	882

Note: Once populated, if this table is longer than two pages, the electrical corporation must append the table.

BVES already identifies and maps its highest risk circuits through its the Fire Safety Circuit Matrix. The output of this effort is shown above in Table 6-5. BVES further describes the Fire Safety Circuit Matrix, including its data inputs in Section 6.1.1. As you can see this incorporates both ignition risk as well as PSPS risk. While this matrix is the best illustration of which are the top-risk contributing circuits, this represents only part of BVES’s risk assessment process. This risk is further understood using BVES’s other risk assessment, modeling and mapping tools including the Risk-Based Decision-Making Framework, the Risk Register Model, and the products from Technosylva and REAX procured by Bear Valley. With the implementation of Technosylva’s WRRM model, BVES has been provided a baseline (no mitigation efforts included) and a current state output, and these model outputs will be used to drive risk informed decision making for mitigation efforts. As stated above, it is BVES’s intent to replace the Fire Safety Circuit Matrix once the WRRM model is fully implemented.

6.4.3 Other Key Metrics

The electrical corporation must calculate, track, and present on several other key metrics and indicators of risk across its service territory (see Appendix B for additional information on the calculation of these metrics). These include, at a minimum:

- **High Fire Potential Index (FPI)** – Landscape scale index used as a proxy for assessing real-time risk of a wildfire under current and forecasted weather conditions. The electrical corporation must specify whether it calculates its own FPI or uses an external source, such as the United States Geological Survey.
- **Red Flag Warning (RFW)** – Near-term proxy for the potential of high wildfire risk due to weather conditions, as declared by the National Weather Service (NWS)
- **High Wind Warnings (HWW)** – Near-term potential for high wind risk, as declared by the NWS

For each metric, the frequency of its occurrence within each HFTD Tier and the HFRA must be reported in the table below. The metric must be reported in number of overhead circuit mile (OCM) days of occurrence normalized by circuit miles within that area type. For example, consider an electrical corporation with 1,000 OCM in HFTD Tier 3. If 100 of these OCM are under a RFW for one day, and 10 of those OCM are under a RFW for an additional day, then the average RFW-OCM per OCM would be:

$$RFW_OCM/OCM = (100 \times 1 + 10 \times 1)/1000 = 0.1$$

This metric represents the average RFW-OCM experienced by an OCM within the electrical corporation’s service territory within HFTD Tier 3. If the metric is continuous (such as FPI), the report should include a note stating the threshold used to select high values.

Table 6-6 Summary of Key Metrics by Statistical Frequency

Metric	Non-HFTD	HFTD Tier 2	HFTD Tier 3
FPI-OCM/OCM	N/A	N/A	N/A
RFW-OCM/OCM	0	0.875	0.875
HWW-OCM/OCM	0	8.5	8.5

BVES tracked and recorded Red Flag Warning (RFW) and High Wind Warning (HWW) for its 2023-2025 WMP and previous WMPs and continues to record it in its QDR. All of BVES’s service territory resides in Tier 2 and Tier 3 and all of BVES’s service territory is considered to be one polygon due to its small size. BVES installed several remote weather stations and uses a contract meteorologist that tracks this information from the National Weather Service, the installed weather stations, the National Fire Danger Rating System (NFDRS), and other key

indicators. Additionally, High Wind Warning and Red Flag Warning as well as other real-time climactic features are incorporated into Technosylva's real-time risk mapping of BVES's territory.

6.5 Enterprise System for Risk Assessment

In this section, the electrical corporation must provide an overview of inputs, operation, and support for a centralized risk assessment enterprise system. This overview must include discussion of:

- *The electrical corporation's database(s) utilized for storage of risk assessment data*
- *The utilities internal documentation of its database(s)*
- *Integration with systems in other lines of business*
- *The internal processes for updating enterprise system including database(s)*
- *Any changes to the initiative since the last WMP submission and a brief explanation as the why those changes were made. Include any planned improvements or updates to the initiative and timeline for implementation*

BVES implement Technosylva's WFA-E and WRRM models in 2023 and 2024 respectively, which will serve as a risk enterprise system. The WFA-E model was completed in the first quarter of 2023 and is now in use. Technosylva delivered WRRM in 2023 and BVES expects to begin to fully integrate it in 2024. These completions along with the addition of the DIREXYION models initial implementation will allow BVES to significantly improve its modeling and risk limiting decision-making capabilities in 2024. Technosylva staff have established controls for updating the models, maintaining configuration control, ensuring the updates are correct (testing and quality assurance process) and implementing the updates. This process is formal and BVES staff is alerted prior to any updates.

BVES contracted with DIREXYION to deliver an enterprise risk modeling system. This enterprise risk model utilizes the various inputs (likelihood and consequence) derived from the WFA-E, WRRM, and other calculated values (such probability of vegetation contacting lines, etc.). This work is ongoing which includes a formal process to maintain configuration control and update it.

6.6 Quality Assessment and Control

The electrical corporation must document the processes and procedures it uses to confirm that the data collected and processed for its risk assessment are accurate and comprehensive. This includes but is not limited to model, sensor, inspection, and risk event data used as part of the electrical corporation's WMP program. In this section of the WMP, the electrical corporation must describe the following:

- *Independent review – Role of independent third-party review in the data and model quality assessment*

Model controls, design, and review – Overview of the quality controls in place on electrical corporation risk models and sub-models BVES will develop quality assessment and quality control processes and procedures to confirm that the data collected and processed for its risk assessment are accurate and comprehensive as its Risk Assessment Program moves forward. This may include but is not limited to model, sensor, inspection, and risk event data used as part

of the electrical corporation's WMP program. BVES will provide an update on this effort as part of its 2024 WMP Update. Independent review will be conducted by a third-party contracted expert.

6.6.1 Independent Review

The electrical corporation must report on its procedures for independent review of data collected (e.g., through sensors or inspections) and generated (e.g., through risk models and software) to support decision making. In this section of the WMP, the electrical corporation must provide the following:

- **Independent reviews:** *The electrical corporation's procedures for conducting independent reviews of data collection and risk models.*
- **Additional review triggers:** *The electrical corporation's internal procedures to identify when a third-party review is required beyond the routinely scheduled reviews.*
- **Results, recommendations, and disposition:** *The results and recommendations from the electrical corporation's most recent independent review of its data collection and risk models. This includes the electrical corporation's disposition of each comment.*
- **Routine review schedule:** *The electrical corporation's routine review schedule.*

The electrical corporation must enter each accepted recommendation from independent review into its action tracking system for resolution (assignment of responsibility, development of technical plan, schedule for development and deployment, etc.) in accordance with the requirements discussed in Section 11.

BVES has utilized third parties such as Technosylva and REAX to review and process its data as it pertains to risk. Both firms use open, peer reviewed data sets, along with BVES data, to develop their models. BVES will continue to explore methods to improve its data gathering, QA/QC processes, and independent review of its data, models, and assumptions.

Internally, the data for BVES's Risk-Based Decision-Making Framework, Risk Register, and Fire Safety Circuit Matrix utilize internal data gathered from BVES staff and contractors across the service territory as well as data BVES gathers from the Commission, other utilities, the US Census Bureau, the National Weather Service, and more. BVES seeks data from these reliable sources and takes pains to ensure the data is accurate, timely, and fit for the purpose to which it is applied.

REAX provided BVES with Ignition Probability Risk Model / Mapping including a look out to expected 2050 conditions. REAX utilized publicly available utility-ignition data reported to CPUC and OH electrical network filed with WMPs were analyzed to quantify ignition rate (ignitions / 100 pole miles / hour) as a function of wind gust speed, fuel moisture, and temperature. Weather conditions at ignition location & time of ignition determined from gridded meteorological data and normalized by historical values that the entire overhead network "sees". Ignition rate was found to be an exponential function of wind gust speed, fine dead fuel moisture content, and fuel temperature.

Climate conditions for 2021 are derived from the RTMA product from the NOAA / National Centers for Environmental Prediction. This provides hourly gridded (2.5 km) fields of weather conditions from 2011 to current. Future (2050) climate conditions are modeled using a downscaled global climate model developed by UCLA's Department of Atmospheric and Oceanic Sciences. Specifically, the WRF was used to dynamically downscale global climate models (GCMs) from the 6th Coupled Model Intercomparison Project (CMIP6). BVES is using a 10-year block of this data (hourly, 3 km resolution) centered around 2050 in its fire ignition and

spread modeling to quantify differences in fire ignition and spread between current (2021) and future (2050) climate conditions.

10-year climatology (2021 and 2050) was used to drive ignition and spread simulations with 1,000,000 years of fires simulated for current and climate-adjusted conditions. The simulation duration varied from 24 hours to one week.

Technosylva uses the following the independent review results (Guide ASTM E 1355) described below:

- The core models implemented in WFA-E form the basis of most operational propagation models in use today (Andrews et al 1980, Gould 1991). They have been implemented in well-known software like NEXUS (Scott and Reinhardt 2001), Fire and Fuels Extension to Forest Vegetation Simulator (FFE-FVS) (Reinhardt and Crookston 2003), FARSITE (Finney 2004), Fuel Management Analyst (FMAPlus) (Carlton2005), FlamMap (Finney 2006) and BehavePlus (Andrews et al.2008). Nevertheless, forest fires are a very difficult phenomenon to simulate that depends on many different factors, therefore typical simulations can predict the source dataset with mean absolute percent errors between 20 and 40% (Cruz et al. 2013).
- One important factor in fire simulation is the definition of the fuel models, with analysis providing different results for different fuels and regions. For example, Sanders (2001) observed a pattern of over-prediction by FARSITE in fuel models 1,2,5 by a large margin, moderate in fuel 10 and some underprediction for fuel model 8. Zigner et al (2020) used two case studies during strong winds revealing that FARSITE was able to successfully reconstruct the spread rate and size of wildfires when spotting was minimal. However, in situations when spotting was an important factor in rapid downslope wildfire spread, both FARSITE and FlamMap were unable to simulate realistic fire perimeters. Ross et al. (2006) used measurements from temperature sensors during prescribed burn in the Appalachian Mountains to recreate the fires and compared fire behavior simulated by FARSITE. They obtain a set of ROS adjustment factors that better represented the observed fire behavior obtaining a ROS adjustment factor of 1.5 and 2 for fuels 9 and 11 respectively, and a decreasing factor of 0.2 to the fuel type 6.
- Apart from these reviews, Technosylva has been constantly improving the accuracy and performance of the published fire models to better adjust the results to observed fire behavior. This includes a better definition of the fuel types, improved forecast of live fuel moisture content, modifications to the crown fire modeling initialization scheme, and automatic fire adjustment based on data assimilation techniques using ROS adjustment factor. In addition, Technosylva has implemented more than 21 additional models into the WFA-E platform to enhance accuracy and address know limitations of published fire models. These improvements include crown fire analysis, ember and spotting, urban / non-burnable area encroachment, consequence and impact quantification, etc. It is important to note that improvement of the fire modeling platform of choice necessitates not only improvements in mathematical algorithms but substantial improvements in the accuracy and resolution of input data sources. These improvements work in concert to enhance the modeling and outputs to match observed and expected fire behavior. A robust operationalization of fire models requires constant and ongoing research, testing, validation and implementation of both models and data sources.

6.6.2 Model Controls, Design, and Review

An electrical corporation's risk modeling approaches are complex, with several layers of interaction between models and sub-models. If these models are designed as a single unit, it can be difficult to evaluate the propagation of small changes in assumptions or inputs through the models. The requirements in this section are designed to facilitate the review of models by the public, intervenors, and Energy Safety, and allow more comprehensive retrospective analysis of failures in the system.

The electrical corporations must report on its risk modeling software's model controls, design, and review in the following areas:

- **Modularization** – *The electrical corporation must evaluate its software architecture to ensure the structure is sufficiently modular to track and control changes and enhancements over time. At a minimum, the electrical corporation risk model is expected to have separate modules to evaluate each of the following:*
 - *Weather analysis*
 - *Fire behavior analysis*
 - *Seasonal vegetation analysis*
 - *Equipment failure*
 - *Exposure and vulnerability analysis*
- **Reanalysis** – *The electrical corporation must maintain the capability to provide Energy Safety the results of its risk model based on the operational version of the software (including code and data) on a specific historic day.*
- **Version control** – *The electrical corporation must use industry standard practices in version controlling its risk model and sub-models. At a minimum, the electrical corporation is expected to meet the following requirements:*
 - *Models and software must use version controls aligned with industry standard programs, procedures, and protocols.*
 - *Model input data, including geospatial data layers, must be version controlled.*
 - *Technical, verification, and validation documentation must be periodically updated for new software versions.*
 - *Procedures for updating technical, verification, and validation documentation.*

Per the engagement agreement, and the description above in Section 6.6.1, BVES relies upon Technosylva for this type of analysis. Technosylva maintains that it meets all the requirements set forth by Energy Safety in this section. BVES recognizes that this is a gap in its capability and BVES intends to develop a better understanding modularization, reanalysis, and version control. BVES will provide additional granularity on this effort in the 2024 WMP Update.

6.7 Risk Assessment Improvement Plan

A key objective of the WMP process is to drive year-over-year continuous improvement. In this section, the electrical corporation must provide a high-level overview of its plan to improve both programmatic and technical aspects of its risk assessment in at least four key areas:

- **Risk assessment methodology** – Wildfire and PSPS risk assessment methodology and its documentation, including both quantitative and qualitative approaches
- **Design basis** – Justification of design basis scenarios used to evaluate the risk and its documentation
- **Risk presentation** – Presentation of risk to stakeholders, including dashboards and statistical assessments
- **Risk event tracking** – Tracking and reconstruction of risk events and integration of lessons learned

The overview must consist of the following information, in tabulated format:

- **Key area** – One of the four key areas identified above
- **Title of proposed improvement** – Brief heading or subject of the improvement
- **Type of improvement** – Technical or programmatic
- **Anticipated benefit** – Summary of expected benefit and any other impacts of the proposed improvement
- **Timeframe and key milestones** – Total timeframe for undertaking the proposed improvement and any key milestones

In addition, the electrical corporation must provide a concise narrative of its proposed improvement plan (maximum of five pages per improvement) summarizing:

- **Problem statement** – Description of the current state of the problem to be addressed
- **Planned Improvement** – Discussion of the planned improvement, including any new/novel strategies to be developed and the timeline for their completion
- **Anticipated Benefit** – Description of the anticipated benefit of the improvement to the electrical corporation's program and risk in its service territory
- **Region prioritization (where relevant)** – Reference to risk-informed analysis (e.g., local validation of weather forecasts in the HFTD) demonstrating that high-risk areas are being prioritized for continued improvement
- Supporting documentation (as necessary)

Table 6-7 Utility Risk Assessment Improvement Plan

Key Risk Assessment Area	Proposed Improvement	Type of Improvement	Expected Value Added	Timeframe and Key Milestones
Risk assessment methodology	Complete formal implementation and staff training on the WFA-E model to develop proficient model users	Programmatic: Training and process improvements on WFA-E use.	This will help BVES better evaluate their risks both in severity and location and prioritize mitigation efforts to reduce those risks.	Q4 2023 complete process development and staff proficient at use of the model.

Key Risk Assessment Area	Proposed Improvement	Type of Improvement	Expected Value Added	Timeframe and Key Milestones
Risk assessment methodology	Implement use of the WRRM and WFA-E in evaluating asset risks	Programmatic: Training and process improvements on WRRM use.	This will replace the Fire Safety Circuit Matrix to help BVES prioritize mitigation initiatives.	Q1 2023 complete initial delivery of baseline WRRM output Q4 2023 implement process for evaluating WRRM outputs and evaluating asset risk. comparing baseline and mitigation effort maps. Q4 2023 Complete staff training 2024 Daily use of WFA-E to monitor service territory Fire Risk
Risk presentation	Develop and implement overall risk enterprise system (A combination of WFA-E, WRRM, and DIREXYON	Technical and programmatic: Develops overall risk enterprise system and processes for control and use of system. Additionally, involves staff training on system.	Produce reliable quantitatively derived wildfire risk, ignition risk, PSPS risk and overall utility risk and display it in a manner that is useful to decision makers.	Q3 2024 Complete development of overall risk enterprise system Q3 2024 Complete process controls and training for overall risk enterprise system Q4 2024 Implement Use of DIREXYON with input from WFA-E and WRRM to make risk informed decisions on

Key Risk Assessment Area	Proposed Improvement	Type of Improvement	Expected Value Added	Timeframe and Key Milestones
				mitigation selection

The implementation of Technosylva and its modeling software is currently underway. BVES believes that until the full suite of tools purchased is available and utilized, it is not in its best interest to develop an Improvement Plan for its Risk Assessment Program. Once BVES gains experience generating the appropriate outputs, and conducts its own analysis on those outputs, BVES will be better positioned to determine other specific areas for improvement.

Proposed Improvement Plan

1. Complete formal implementation and staff training on Technosylva's WFA-E model to develop proficient model users.

- **Problem statement** – The WFA-E model is new to BVES staff, and the model users are not yet proficient in its use or application. Training and user process improvements are needed to maximize the value of the WFA-E product.
- **Planned Improvement** –The goal is to develop proficient model users of the model who understand its limitations and its benefits and can plan and take actionable steps to address risks highlighted by the model. BVES plans to complete the formal implementation and train applicable staff on the WFA-E model. BVES also intends to make user process improvements.
- **Anticipated Benefit** – Properly trained users of the WFA-E model will be better positioned to unlock the most value from the tool. The WFA-E delivers both ignition risk and PSPS risk and severity and helps illuminate potential consequences of fires. This is further enhanced when there is a consistent, repeatable process for users to follow. Improved use of WFA-E by staff will lead to proficiency in operating and understanding the model as an operational tool in assessing ignition risk and PSPS risk on a near-real-time basis. These outputs will lead to actionable efforts both to alleviate real-time operational concerns and to plan and prioritize long-term mitigations. Specifically, better understanding of the tool's capabilities and outputs will lead to planned mitigations to reduce ignition and PSPS risk in those areas most at risk from wildfire and PSPS consequences.
- **Region prioritization (where relevant)** – BVES will analyze its entire service territory through this initiative.

2. Implement use of the WRRM in evaluating asset risks.

- **Problem statement** – BVES's current Fire Safety Circuit Matrix is a crude, static tool that does not allow for complex interactions or provide near-real-time dynamic outputs based on observed or projected conditions.
- **Planned Improvement** – BVES will fully adopt and implement Technosylva's Wildfire Risk Reduction Model (WRRM) in evaluating asset risks and grid hardening and initiative planning for the WMP. In addition to implementation, BVES plans to train its staff on

WRRM use and develop process improvements to ensure applicable staff are proficient in operating and understanding the model as a planning tool.

- **Anticipated Benefit** – Adoption of the WRRM as a replacement for the Fire Safety Circuit Matrix will provide BVES with dynamic, granular, near real-time understanding of its service territory. This improvement will allow BVES to better prioritize mitigation initiatives with a probabilistic model to quantitatively calculate ignition and PSPS risk. This will make BVES less dependent on the subjectivity of subject matter experts and manual processes that run the risk of omitting relevant facts. These outputs will lead to actionable efforts both to alleviate real-time operational concerns and to plan and prioritize long-term mitigations. Specifically, better understanding of the tool's capabilities and outputs will lead to planned mitigations to reduce ignition and PSPS risk in those areas most at risk from wildfire and PSPS consequences.
- **Region prioritization (where relevant)** – BVES will analyze its entire service territory through this initiative.

3. Develop and implement overall risk enterprise system

- **Problem statement** – BVES currently does not have a risk enterprise system.
- **Planned Improvement** – BVES intends to develop and implement a comprehensive risk enterprise system. BVES will also develop and implement processes for control and use of the system and a training program for staff to promote utilization and optimization of the system.
- **Anticipated Benefit** – BVES anticipates the benefit to adopting a comprehensive enterprise risk tool is to produce reliable quantitatively derived wildfire risk, ignition risk, PSPS risk and overall utility risk and display it in a manner that is useful to decision makers. This will also help BVES better identify, understand, quantify, and evaluate inherent, emerging, intermediate, and residual risks across its system and to the utility in a manner that is digestible for management. Clear presentation of risks allows the management, staff, and stakeholders to manage risks in a manner that maximizes public safety, reliability, operational efficiency on a cost-effective basis through careful planning organized implementation of risk reduction efforts.
- **Region prioritization (where relevant)** – BVES will analyze its entire service territory through this initiative.

7. Wildfire Mitigation Strategy Development

In this section of the WMP, the electrical corporation must provide a high-level overview of its risk evaluation and process for deciding on a portfolio of mitigation initiatives to achieve maximum feasible 4.1–4.2, and wildfire mitigation strategy for 2023-2025. Sections 7.1 and 7.2 below provide detailed instructions. 16 risk reduction and that meet the goal(s) and plan objectives stated in Sections

7.1 Risk Evaluation

7.1.1 Approach

In this section of the WMP, the electrical corporation must provide a brief narrative of its risk evaluation approach, based on the risk analysis outcomes presented in Section 6, to help inform the development of a wildfire mitigation strategy that meets the goal(s) and plan objectives stated in Sections 4.1– 4.2.

The electrical corporation must describe the risk evaluation approach in a maximum of two pages, inclusive of all narratives, bullet point lists, and any graphics.

The risk evaluation approach in this WMP is designed to meet a range of industry best practices to determine a wildfire and PSPS risk mitigation strategy. The intent is to use this approach to help inform BVES’s development of a portfolio of wildfire mitigation initiatives and activities to meet the objectives stated in Sections 4.1–4.2. Therefore, BVES’s general risk evaluation approach consists of the following:

- Identifying risk evaluation criteria based on the balance of various performance goals
- Applying the criteria to monitor the effectiveness of the mitigation initiatives
- Evaluating wildfire and PSPS risks and risk components through a risk-informed decision-making process to develop mitigation initiatives priorities
- Evaluating and prioritizing mitigation initiatives and activities to efficiently reduce risk
- Selecting mitigation initiatives over the WMP cycle based on risk reduction
- Describing selected risk mitigation strategies in the WMP
- Monitoring and re-evaluating mitigation activities to maximize risk benefit and efficiency



Figure 7-1 BVES Risk-Based Decision-Making Framework

BVES uses a Risk-Based Decision-Making Framework in accordance with the approach for Small and Multi-Jurisdictional Utilities (SMJU) in CPUC D. 19-04-020. The Risk-Based Decision-Making Framework prioritizes effective strategies for risk reduction. The methodology identifies inherent risk, existing controls, residual risk, and future mitigations after determining the likelihood and impact of wildfire. This is the primary tool for planning WMP initiatives. Figure 7-1, above, provides an overview of the steps.

Enterprise Risk Mitigation Strategy

The Risk Register Model quantifies mitigation projects and programs by the risk benefit and risk spend efficiency (RSE). This analysis reviews ongoing and potential projects to mitigate the three primary wildfire risk events: 1) Wildfire Public Safety, 2) Wildfire – Significant Loss of Property, and 3) Loss of Energy Supplies. BVES uses the output from this analysis to select the most cost effective and efficient projects. The enterprise risk evaluation considers a reasonable

worst-case scenario for the three primary wildfire risk events. For each, BVES determined the frequency and impact scores for each of the weighted risk scoring inputs including system reliability impacts, regulatory compliance/legal implications, service to customers, public safety, and environmental impacts.

BVES utilizes a 7x7 log score matrix to determine an impact risk score for each weighted scoring input in the Risk Register. The weighted impact scores are accumulated to arrive at a total risk score. The risk scoring inputs, and total risk score form the basis of evaluation for each identified wildfire mitigation activity or initiative. Mitigation activities can be applied to a single or multiple risk events. BVES then calculates the risk reduction/risk benefit for each scoring input to arrive at a weighted mitigated risk score. The risk benefit for each combination of mitigation and risk event is determined by subtracting the mitigated risk score from the total risk score. BVES also defines an equivalent annual cost for each mitigation activity. Finally, the Risk Register determines the RSE by dividing the risk benefit by the equivalent annual cost.

Current and Future Locational Prioritization Tools

BVES's Fire Safety Circuit Matrix characterizes each BVES distribution circuit as high, moderate, and low risk and then prioritize the circuits within each risk group. The matrix data inputs include, inter alia, the number of customers, wood poles, bare wire overhead circuit miles, and tree attachments, which are then compiled and weighted to calculate the wildfire risk mitigation score. Currently, seven circuits are rated high-risk, 12 circuits are rated moderate risk, and seven circuits are rated low risk. BVES uses the Fire Safety Circuit Matrix as a "living document" as mitigations are implemented. BVES re-evaluates the mitigations, wildfire risk group, priority, and mitigation weight at least every six months. Additionally, the Fire Safety Circuit Matrix is used to gauge progress and set 3- and 10-year targets for the reduction of the wildfire mitigation score and associated wildfire ignition risk reduction.

BVES enhanced its ignition risk mapping with REAX Engineering's ignition probability models in 2021 to better predict, quantify, and measure risk drivers under high-risk and climate change related metrological forecasts. The risk maps provide ignition probability, consequence, and risk under current and future conditions to better understand the effects of climate change.

In 2022, BVES hired Technosylva to advance the Risk Mapping Program and enhance situational awareness and improve resource allocation by leveraging the Wildfire Analyst Enterprise (WFA-E) software solution. This provides BVES with the following:

- Real-time wildfire behavior modeling, spread predictions, and potential impacts analysis
- Weather and wildfire risk forecasting for customer assets and the service territory to support PSPS activation calls and response operations
- Asset risk analysis using historical climatology to support mitigation planning

In 2023, Technosylva delivered the Wildfire Risk Reduction Model (WRRM). This model performs asset risk analysis using historical climatology as inputs and produces risk scenarios by running fire spread simulations for projected weather conditions. The model uses historical or predicted fuels data and runs millions of simulations across the customer service territory showing impact to assets. These outputs will inform future mitigation planning and set the context for daily FireCast asset risk forecasts.

BVES intends to transition from the Fire Safety Circuit Matrix to the WRRM to prioritize its WMP initiatives. The first runs of the WRRM were not completed in time to plan the 2023 WMP initiative work. The WRRM will be used in future WMP Updates. BVES believes that this change will provide a more detailed probabilistic model at the circuit and segment levels.

BVES must also account for the timing and proper sequencing of the various wildfire mitigation initiatives. For example, while the Situational Awareness Enhancement Project (establishing a distribution management center) offers a relatively high RSE, it cannot be fully completed until various grid automation initiatives are completed in 2025.

7.1.2 Key Stakeholders for Decision Making

In this section, the electrical corporation must identify all key stakeholder groups that are part of the decision-making process for developing and prioritizing mitigation initiatives. At a minimum, the electrical corporation must do the following:

- *Identify each key stakeholder group (e.g., electrical corporation executive leadership, the public, state/county public safety partners)*
- *Identify the decision-making role of each stakeholder group (e.g., decision maker, consulted, informed)*
- *Identify method of engagement (e.g., meeting, workshop, written comments)*

The electrical corporation must also describe how it communicates decisions to the identified key stakeholders.

In the below section BVES identifies all key stakeholder groups that are part of the decision-making process for developing and prioritizing mitigation initiatives. The roles and responsibilities for the BVES decision making process for communicating with the identified key stakeholders can be seen in Table 7-1.

Table 7-1 Stakeholder Roles and Responsibilities in Decision Making Process

Stakeholder	Stakeholder Point of Contact	Electrical Corporation Point of Contacts	Stakeholder Role	Engagement Protocols
Sheriff's Department Big Bear Lake Patrol Station	Sherriff	Paul Marconi	<ul style="list-style-type: none"> • Evacuation Routes – decision maker • PSPS Coordination - informed 	<ul style="list-style-type: none"> • Phone calls as needed • Quarterly public meetings
Big Bear Fire Department	Fire Chief	Paul Marconi	<ul style="list-style-type: none"> • Policy - consulted • Coordinate emergency response - consulted • Wildfire mitigation – decision maker 	<ul style="list-style-type: none"> • Quarterly meetings • As needed phone calls
San Bernadino County	Big Bear Lake Representative for County	Paul Marconi	<ul style="list-style-type: none"> • Policy - consulted • Communication - informed 	<ul style="list-style-type: none"> • Bi-annual meetings

Stakeholder	Stakeholder Point of Contact	Electrical Corporation Point of Contacts	Stakeholder Role	Engagement Protocols
	Supervisor 3 rd District			<ul style="list-style-type: none"> • Phone calls as needed
Cal Trans	Transportation Engineer	Tom Chou	<ul style="list-style-type: none"> • Grid hardening coordination - informed • PSPS coordination - informed • Permitting – decision maker 	<ul style="list-style-type: none"> • Quarterly meetings • Phone calls as needed
City of Big Bear Lake	City Manager Director of Public Service/City Engineer	Paul Marconi Jon Pecchia	<ul style="list-style-type: none"> • Policy – consulted • Permitting – consulted • Communication – consulted 	<ul style="list-style-type: none"> • Quarterly public meetings • Phone calls as needed
Mountaintop San Bernadino US Forrest Service	District Ranger	Jon Pecchia	<ul style="list-style-type: none"> • Grid hardening coordination – consulted • Vegetation management – consulted • Permitting – decision maker 	<ul style="list-style-type: none"> • Phone calls as needed

7.1.3 Risk-Informed Prioritization

In making decisions about risk mitigation, the electrical corporation must identify and evaluate where it can make investments and take actions to reduce its overall utility risk. The electrical corporation must develop a prioritization list based on overall utility risk.

In this section, the electrical corporation must:

- *Describe how it selects areas of its service territory at risk from wildfire for potential mitigation initiatives, including, at a minimum, the following:*
- *Geographic scale used in prioritization (i.e., regional, circuit, circuit segment, span, asset)*
- *Statistical approach used to select prioritized areas (e.g., areas in top 20 percent for risk, areas in top 20 percent for consequences)*
- *Feasibility constraints (e.g., limitations on data resolution, jurisdictional considerations, accessibility)*
- *Present a list that identifies, describes, and prioritizes areas of its service territory at risk from wildfire for potential mitigation initiatives based solely on overall utility risk, including the associated risk drivers.*

For each of the risk scenarios discussed in Section 6.2, BVES developed an initial prioritization list based solely on quantitative risk. These prioritizations reflect a critical assessment of the risks associated with wildfire events. BVES assessed the initial prioritizations to identify any insights and considerations relevant to its decision-making process.

BVES developed a list of all its circuits risks that identifies the highest risk circuits for which it will prioritize the application of mitigation initiatives.

BVES' higher fire threat areas outlined below and prioritized activities for this current WMP cycle include the following circuits: (1) Radford, (2) Baldwin, (3) Shay, (4) Northshore, (5) Goldmine, (6) Holcomb (Bear City), and (7) Clubview.

Table 7-2 Evaluation of HFTD Prioritized Circuits

Circuit	Substation	Wildfire Risk Group	Overall Risk Weighting	Risk Ranking	Voltage (kV)	High Fire Threat District Tier	Vegetation Density	Wind Intensity	# of Customers	# of Wood Poles	# of Fire Resistant Composite Poles	# of LWS Poles	# of Ductile Iron Poles	Bare Wire OH Circuit Miles	Covered Conductor OH Circuit Miles	UG Circuit Miles
Radford	SCE Feed	31215	0.3826	1	34.5	3	High	High	3437	89	0	0	0	2.82	0	0.02
Shay	SCE Feed	3524	0.0432	6	34.5	2	Medium	High	9582	586	0	24	0	5.57	11.6	0.39
Baldwin	SCE Feed	6891	0.0845	2	34.5	2	Medium	High	11621	236	0	20	0	7.62	1.32	0.5
Boulder	Village	882	0.0108	18	4.16	2	Medium	High	2015	990	22	6	0	17.28	0.4	1.8
North Shore (Fawnskin)	Fawnskin	6717	0.0823	3	4.16	2	High	High	1512	924	0	0	0	15.83	0	8.09
Erwin Lake	Maltby	0	-0.0030	26	4.16	2	Medium	High	2574	1054	2	6	0	15.5	5.83	7.41
Pioneer (Palomino)	Palomino	2730	0.0335	8	4.16	2	Medium	High	534	601	0	1	0	11.22	5.17	2.95
Clubview	Moonridge	3225	0.0395	7	4.16	2	High	Medium	1723	507	3	2	0	9.76	0.42	0.27
Goldmine	Moonridge	4539	0.0556	5	4.16	2	Medium	High	2033	601	0	0	0	13.2	0	5.26
Paradise	Maltby	1810	0.0222	12	4.16	2	Medium	High	1874	532	3	17	0	7.22	2.63	2
Sunset	Maple	2374	0.0291	9	4.16	2	High	Medium	1894	505	0	0	0	8.38	2.29	0.5
Sunrise (Maple)	Maple	1857	0.0228	10	4.16	2	Medium	Medium	1772	348	0	0	0	7.61	0.18	3.86
Holcomb (Bear City)	Bear City	4746	0.0582	4	4.16	2	Medium	High	1581	609	2	4	0	13.15	0.1	0.85
Georgia	Pineknott	1384	0.0170	16	4.16	2	Medium	Low	935	349	0	0	0	5.91	0	3.95
Eagle	Pineknott	1813	0.0222	11	4.16	2	Medium	Medium	689	323	0	0	0	7.38	0	1.53
Hamish (Village)	Village	786	0.0096	19	4.16	2	Medium	Low	327	86	0	0	0	1.34	0	1.21
Garstin	Meadow	1366	0.0167	17	4.16	2	High	Low	1347	277	0	0	0	5.09	0.82	3
Lagonita	Village	1533	0.0188	13	4.16	2	Medium	Low	1095	452	1	0	0	7.46	0	1.43
Interlaken	Meadow	1485	0.0182	14	4.16	2	Medium	Medium	889	280	0	0	0	6.04	0.41	3.55
Castle Glen (Division)	Division	1483	0.0182	15	4.16	2	Medium	High	1216	340	9	2	0	5.33	1.6	3.68
Country Club	Division	640	0.0078	20	4.16	2	Medium	Medium	596	178	1	0	0	3.03	0.15	0.94
Fox Farm	Meadow	0	0.0000	25	4.16	2	Low	Low	28	2	0	0	0	0	0	0.84
Pump House (Lake)	Lake	202	0.0025	22	4.16	2	Low	High	3	22	0	0	0	0.64	0	0.02
Lift (Summit TO U)	Summit	627	0.0077	21	4.16	2	Low	Low	0	1	0	0	0	0.1	0	0
Skyline (Summit Res)	Summit	0	0.0000	23	4.16	2	Low	Low	0	0	0	0	0	0	0	0
Geronimo (Bear Mtn.)	Bear Mtn.	0	0.0000	23	4.16	2	Low	Low	2	0	0	0	0	0	0	0.03

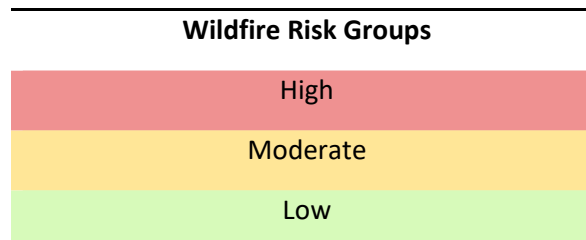

Figure 7-2 Prioritization of Higher Fire-Threat Areas

Known Local Conditions

With relation to (General Order) GO 95 Rule 31.1, BVES adheres to requirements listed for its design, construction, and maintenance activities within a safe and prudent manner. In some instances, BVES exceeds GO 95 standards such as with vegetation right-of-way (ROW) management utilizing an internal company standard of 72-inch minimum radial clearance specification.

BVES monitors meteorological conditions through its situational awareness program, including the use of live data feeds from its own weather stations and visual feeds through the ALERTWildfire network of HD cameras.

BVES's service area is entirely above 3,000 feet requiring all construction to conform to the heavy loading standards of GO 95. The heavily forested environment and mountainous terrain makes the territory vulnerable to potential ignition risk. Per GO 95 21.2 and D. 17-12-024, the entire service area is within the HFTD Tiers 2 and 3, requiring BVES to manage its assets with an understanding of elevated hazards for ignition risk. This includes high wind activity, excessive fuel loading, and lower humidity during the summer months. BVES's service territory also experiences heavy winter loading. BVES maintains and operates its equipment with an abundance of caution due to the seasonal conditions, which may impact delivery of power. While BVES's service territory has not experienced a recorded utility-ignition event in recent history, field workers assume variable risks when engaging in line maintenance and construction. In accordance with GO 166 Standard 1.E, BVES performs activities with safety as a principal focus as part of its Fire Prevention Plan and company standards.

Risk Impact Categorization

BVES established Risk Impact Categories to assess the impact of an event. BVES also established descriptions in each category that describe increasing levels of severity from level 1 (negligible) to level 7 (catastrophic). These Risk Impact Category descriptions provide guidance for analyzing and scoring risk events. The descriptions provide a consistent framework to assign an impact value (level 1 to 7) to risk events across all five impact categories. BVES utilizes SME review and common industry practices to align worst case impact scores.

The Risk-Based Decision-Making model incorporates a Risk-Based Decision-Making Framework into utility investments and programs to inform the General Rate Case (GRC) cycles. This framework provides a process for identifying asset-related risks (including distribution assets and the Bear Valley Power Plant), consequences of occurrence, frequency or likelihood of occurrence, risk drivers, and mitigation measures. The results of the model identify strategic objectives for approval, categorize top risks to BVES and its service area including new and emerging risks, and arrive at risk-informed recommendations for future investments. This may also lead to modifying existing controls and implementation schedules.

Data Elements:

Scope and granularity: Data includes incident and safety findings, identified risk events with consequence mapping, field findings, and external sources of risk. These drivers are updated annually as new inputs are collected.

Frequency of data updates: Updates to the risk model occur on an annual basis to help determine any needed changes for capital investment or enhanced O&M activities.

Sources of data: The initial list of risk events is captured through record-keeping practices and risk team brainstorming sessions. These risks are reviewed and categorized with links to asset classes and affixed with a priority weight for the initial analysis. Additional inputs include activities poised to reduce the identified risk weight through WMP and operational execution. The raw data includes scores for frequency, reliability, compliance, quality of service, safety, environmental, and impact score, which result in the total risk score.

Detailed approaches used to verify data quality: Data quality is verified through brainstorming sessions, SME input, and annual review of the model outputs. The data aligns with similarly tracked information imperative to the WMP Update and quarterly reports. BVES ensures there is a 1-1 relationship between the inputs and outputs of the model across all enterprise risk practices. The System Safety and Reliability Engineer is also responsible for reporting any findings or discrepancies among the tracked data values and outputs. This employee also assists in quantifying the impact scores for the proposed mitigations and existing controls.

Feasibility Constraints:

Feasibility constraints include limitations on data resolution, jurisdictional considerations, and accessibility.

The most significant feasibility constraints facing BVES are jurisdictional considerations, namely permitting, to perform work along the Radford Line which is identified as the highest risk circuit in the Bear Valley service territory. This line resides on USFS land and within their jurisdiction. This has led to permitting delays which have thus far prevented efforts to install covered conductor on this circuit. BVES has, however, made progress with the USFS and expects to complete this effort in 2024.

Bear Valley also experiences limitations on data resolution, but those limitations are offset by BVES's intimate familiarity with its compact service territory. Additionally, BVES has made significant improvements in its data acquisition, tracking, and utilization through its improved GIS performance, its use of the iRestore inspection/management activity interface, and its deployment of Technosylva's products.

BVES does not have any significant accessibility issues. Nearly all of BVES's overhead equipment can be accessed via truck on local roads.

7.1.4 Mitigation Selection Process

After the electrical corporation creates a list of top-risk contributing circuits/segments/spans (Section 6.4.2) and prioritized areas based on overall utility risk (Section 7.1.3), the electrical corporation must then identify potential mitigation strategies. It must also evaluate the benefits and drawbacks of each strategy at different scales of application (e.g., circuit, circuit segment, system-wide). In this section of the WMP, the electrical corporation must provide the basis for its decisions regarding which mitigation initiatives to pursue. It must also document how it develops, evaluates, and selects mitigation initiatives.

The electrical corporation should consider appropriate mitigation initiatives depending on the local conditions and setting and the risk components that create the high-risk conditions. There may be a wide variety of potential mitigation initiatives, such as:

- *Engineering changes to grid design*
- *Discretionary inspection and/or maintenance of existing assets*
- *Vegetation clearances beyond minimum regulatory requirements*
- *Alternative operational policies, practices, and procedures*
- *Improved emergency planning and coordination*

The electrical corporation may also mitigate risk by combining multiple mitigation initiatives. The electrical corporation is expected to use its procedures discussed in Section 7 to:

- *Develop potential mitigation initiative approaches to address each risk*
- *Characterize the potential mitigation initiatives to provide decision makers with information required to support decision making (e.g., costs, material availability), including an assessment of uncertainties*
- *Document the results*

The electrical corporation must develop a proposed schedule for implementing each mitigation initiative and proposed metrics to monitor implementation and effectiveness of the mitigation initiative. The following subsections provide specific requirements.

BVES determines potential mitigation strategies based on the prioritized list of risks identified. Additionally, BVES evaluates the benefits and drawbacks of each strategy at different scales of application (e.g., circuit, circuit segment). BVES utilizes the processes and procedures discussed to develop, evaluate, and select mitigation initiatives.

Identification of Potential Projects: This step is designed to identify and determine which projects are potentially viable to deliver consequential wildfire risk reduction. The outcome is an integrated list of projects with a basic understanding of project need, wildfire risk reduction value, timing, and execution challenges, such as permitting, equipment lag, workforce issues, etc. For each potential project, the risk reduction value and RSE are calculated using the Risk-Based Decision-Making process. For BVES to obtain a reasonable assessment of the risk reduction and RSE for each project, BVES seeks to understand to what degree will the risk reduction work be achieved and, if achievable or partly achievable, at what cost. The following factors are developed and considered by the management team:

- Desired scope of work (what technical specifications will the project achieve)
- Technology risk (is technology mature, used in California, new, etc.)
- Site availability and evaluation (constrained to existing facilities or new property; easements; access for construction, inspection, and O&M; zoning; endangered species, other protected species, cultural or historical concerns, or other environmental issues; impact on neighboring community during construction and following project, etc.)
- Permitting (are permits required; approval authority; complexity and timeline of permitting process; request from within the Company or contract out to a permitting expert consultant, etc.)
- Availability of material and equipment (delivery lead-time, type of material – special order made to specifications or commodity, etc.)
- Access to qualified labor resources (mobilization/demobilization, Company labor or contracted labor, work hours – day, night, weekends, shift work, etc.)
- Design process (design complexity; can the design be performed within the company, or must it be contracted out; timeline to produce construction grade design, design risk (e.g., during the course design, how likely is it that the scope of the project may be altered and by how much), etc.)
- Stakeholder support (internal approval, regulatory support, public and local stakeholder support)
- Length of construction period (multi-year, work all year-round or only during non-winter snow period, etc.)
- Project used and useful timeframe (as the project is constructed is it put in service, put in service in distinct phases, or at end of project)

From the above considerations, management analyzes the cost of the project, the estimated timeline and sequence of the project, and the risk reduction achieved according to the Risk-Based Decision-Making model for SMJUs. From this analysis, RSE is calculated.

7.1.4.1 Mitigation Initiatives Development Process

The electrical corporation must describe how it identifies and evaluates options for mitigating wildfire and PSPS risk at various analytical scales. The current guidelines governing this process are derived from the Risk-Based Decision-Making Framework established in the Safety Model and Assessment Proceeding (S-MAP). The S-MAP is currently being updated in CPUC proceeding R. 20-07-013. In due course, the electrical corporation's risk mitigation identification procedure must align with results from this proceeding.²¹ The electrical corporation must describe the following:

- *The procedures for identifying and evaluating mitigation initiatives (comparable to 2018 S-MAP Settlement Agreement, row 26), including the use of risk buy-down estimates (e.g., risk-spend efficiency) and evaluating the benefits and drawbacks of mitigations*
- *To the extent possible, multiple potential locally relevant mitigation initiatives to address local wildfire risk drivers (see 2018 S-MAP Settlement Agreement, row 29)*
- *The approach the electrical corporation uses to characterize uncertainties and how the electrical corporation's evaluation and decision-making process incorporates these uncertainties (see 2018 S-MAP Settlement Agreement, rows 29 and 30)*
- *Two or more potential mitigation initiatives for each risk driver included in the list of prioritized areas (Table 7-2 in Section 7.1.3), including the following information:*
 - *The initiatives and activities*
 - *Expected risk reduction and impact on individual risk components*
 - *Estimated implementation costs*
 - *Relevant uncertainties*
 - *Implementation schedule*
- *How the electrical corporation uses multi-attribute value functions (MAVFs) and/or other specific risk factors (as identified in 2018 S-MAP or subsequent relevant CPUC Decisions) in evaluating different mitigations*

The BVES process to evaluate options for mitigating wildfire and PSPS risk at various analytical scales is discussed in Section 7.1.1. BVES is not required by the California Public Utilities Commission (CPUC) to develop either a Multi-Attribute Value Function (MAVF) or Multi-Attribute Risk Score (MARS) framework for Risk Assessment Mitigation Phase (RAMP) filings; however, BVES maintains a risk assessment toolkit to help identify risk drivers and better understand the potential consequences of wildfire threat while gauging the success of mitigation initiatives. This framework is the Risk-Based Decision-Making Framework in accordance with the safety model approach for Small and Multi-Jurisdictional Utilities (SMJU) provided in CPUC D. 19-04-020. Additionally, BVES is tracking current proceeding activities under R. 20-07-013, for which Safety Model and Assessment Proceeding (S-MAP) enhancements continue to be developed.

7.1.4.2 Potential Mitigation Initiative Evaluation and Selection

After identifying and characterizing the mitigation options, the electrical corporation must analyze the options to determine which will reduce risk the most, given limitations and constraints (e.g., resources available for mitigation initiatives). To the greatest extent practicable, the electrical corporation must make these determinations using its existing framework of project prioritization. The electrical corporation must strive to optimize its resources for maximum risk reduction.

The electrical corporation should seek the best integrated portfolio of mitigation initiatives to meet its performance objectives. Objectives may be based on quantified risk assessment results (see Section 6), or other values prioritized by the electrical corporation or broader stakeholder groups (e.g., environmental protection, public perception, resilience, cost). At a minimum, the electrical corporation must do the following:

- Evaluate its potential mitigation initiatives. This evaluation will yield a prioritized list of initiatives. The objective is for the electrical corporation to identify the preferable initiatives for specific geographical areas. (Comparable to 2018 S-MAP Settlement Agreement, rows 12, 26, and 29.)
- Identify the best mitigation initiatives for all geographical areas to create a portfolio of projects expected to provide maximal benefits within known limitations and constraints. (Comparable to 2018 S-MAP Settlement Agreement, rows 12, 26, and 29.)
- Explain how the electrical corporation is optimizing its resources to maximize risk reduction. Describe how the proposed initiatives are an efficient use of electrical corporation resources and focus on achieving the greatest risk reduction with the most efficient use of funds and workforce resources.

This process is expected to be iterative due to the competing nature of performance objectives and their complex interrelationships.

The electrical corporation must describe how it prioritizes mitigation initiatives to reduce both wildfire and PSPS risk. This discussion must include the following:

- A high-level schematic showing the procedures and evaluation criteria used to evaluate potential mitigation initiatives. At a minimum, the schematic must demonstrate the roles of quantitative risk assessment, resource allocation, evaluation of other performance objectives (e.g., cost, timing) identified by the electrical corporation, and subject matter expert (SME) judgment. Where specific local factors, which vary across the service territory, are considered in the decision-making process (e.g., the primary risk driver in a region is legacy equipment), they must be indicated in the schematic. The detail must be sufficiently specific to understand why those local conditions are part of the decision process (i.e., there should not be simply one box in the schematic that is labeled "local conditions," which is then connected to the rest of the process).
- Summary description (no more than five pages) of the procedures and evaluation criteria for prioritizing mitigation initiatives, including the three minimum requirements listed above in this section.

Selection of Projects: In this step, management uses the information identified in the risk assessment to plan the optimal mix of projects to be included in the WMP (and follow-on updates to the WMP) to deliver maximum risk reduction considering BVES's limited capital and human resources. This process includes re-evaluating multi-year projects that are in progress to determine if they should be continued, discontinued, or revised. The expected outcome of this step is to develop an integrated and prioritized list of WMP projects to be executed in the next and future WMPs. The list of three and ten-year projects can be seen in Table 7-3 Table 7. The list of selected projects is not sequenced in this step. Alternatives to the projects are considered and some projects are removed from consideration in this step.

The risk reductions and RSEs, developed using the Risk-Based Making-Decision process is utilized to establish an initial project selection screening. Then, the resulting risk mitigation outcome of executing the project is projected using the Fire Safety Circuit Matrix model described in Section 7.1.1 of this WMP. This provides more granular information at the circuit level. It should be noted that BVES's circuits are short in comparison to many utilities. The longest circuit is 23.9 circuit miles (8 of those circuit miles are underground) and most circuits are less than 10 circuit miles in length. Additionally, the projects are viewed against the risk maps developed by REAX Engineering and Technosylva to determine where the wildfire mitigation greatest risk benefit may be achieved by each project.

Each decision to plan an initiative recognizes that the utilities will not be bound to select mitigation strategies based solely on model outputs, and may consider other factors that inform initiative prioritization, including professional and engineering judgment, and resource constraints in terms of labor, equipment, and capital availability. Risk mitigation impacts will be quantified using monetized and standardized risk consequences to the most practicable extent; however, final prioritization choices will continue to be influenced by factors such as labor resources, technology, and modeling limitations and/or uncertainties affecting the analyses.

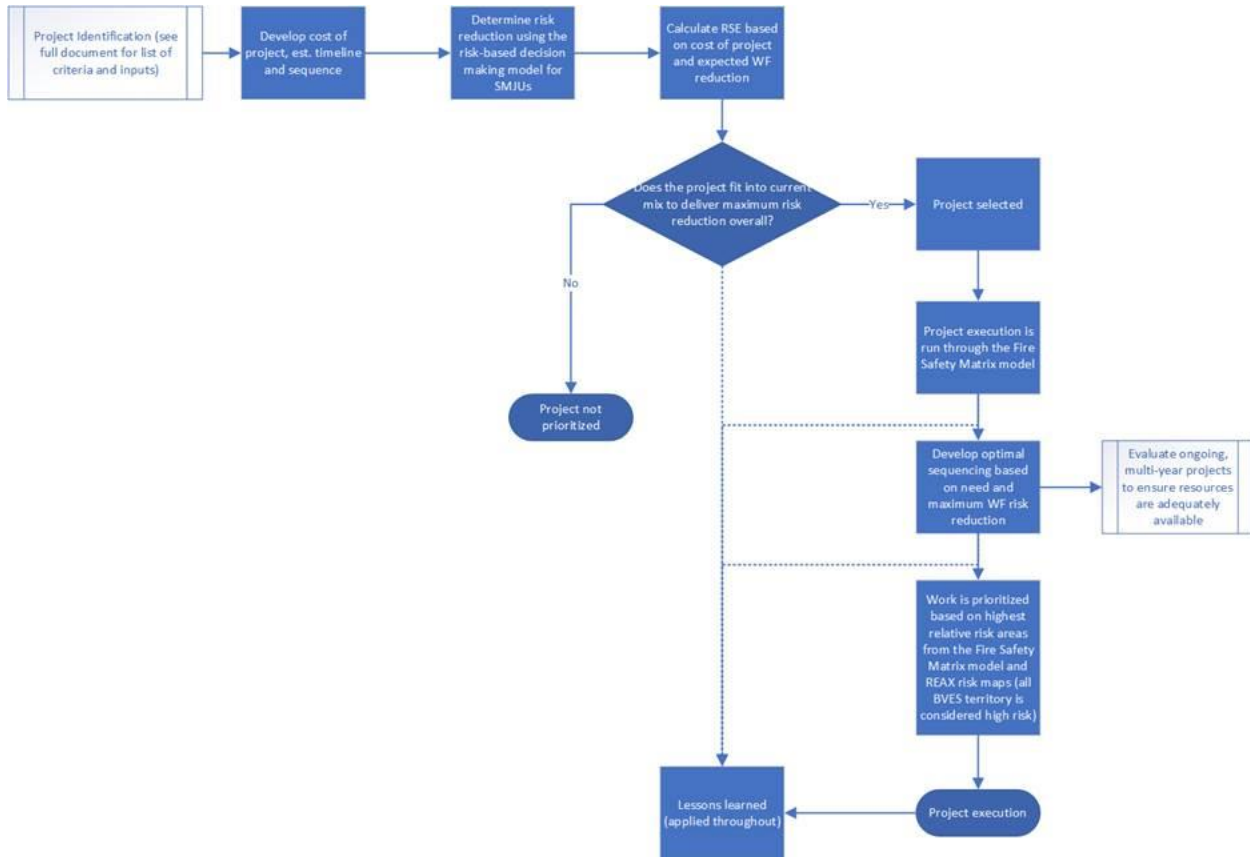

Figure 7-3 BVES Project Selection Process

Resource Optimization

BVES, as a small utility, completely located within HFTD Tiers 2 and 3, must maximize its resources to reduce wildfire and PSPS risk as much as possible with each initiative. A key factor in the selection of projects is a consideration of how each potential initiative will impact Bear Valley’s labor force (both staff and contract labor) and ability to perform its core functions as well as achieve other safety, reliability, and performance objectives. It is imperative to BVES, its customers, and its stakeholders to optimize its resources to maximize risk reduction by employing the most efficient use of Bear Valley Resources. This evaluation has always been part of the project selection process, but BVES will work to formally include this adjustment factor in its project selection by next year’s WMP Update.

7.1.4.3 Mitigation Initiative Scheduling Process

The electrical corporation must report on its schedule for implementing its portfolio of mitigation initiatives. The electrical corporation must describe its preliminary schedules for each initiative and its iterative processes for modifying mitigation initiatives (Section 7.1.4.1).

Mitigation initiatives may require several years to implement. For example, relocating transmission or distribution capabilities from overhead to underground may require substantial time and resources. Since mitigation initiatives are undertaken in high-risk regions, the electrical corporation may need interim mitigation initiatives to mitigate risk while working to implement long-term strategies. Some examples of interim mitigation initiatives include more frequent inspections, fire detection and monitoring activities, and PSPS usage. If the electrical corporation's mitigation initiative requires substantial time to implement, the electrical corporation must identify and deploy interim mitigation initiatives as described in Section 7.2.3.

In its WMP submission, the electrical corporation must provide a summary description of the procedures it uses in developing and deploying mitigation initiatives. This discussion must include the following:

- *How the electrical corporation schedules mitigation initiatives.*
- *How the electrical corporation evaluates whether an interim mitigation initiative is needed and, if so, how an interim mitigation initiative is selected (see Section 7.2.3).*
- *How the electrical corporation monitors its progress toward its targets within known limitations and constraints. This should include descriptions of mechanisms for detecting when an initiative is off track and for bringing it back on track.*
- *How the electrical corporation measures the effectiveness of mitigation initiatives (e.g., tracking the number of protective equipment and device settings de-energizations that had the potential to ignite a wildfire due to observed damage/contact prior to re-energization). The mitigation sections of these Guidelines (Sections 8) include specific requirements for each mitigation initiative.*

Sequencing of Projects:

BVES management uses its risk assessment processes and tools to develop the optimal sequence to execute the selected WMP projects to deliver the maximum wildfire risk reduction while balancing constraints (siting, designing, permitting, costs, access to labor, availability of equipment and material, mobilization/demobilization, etc.). This process also includes re-evaluating the pace and order for which in-progress multi-year projects are to be executed, or even paused. The expected outcome of this step is to develop a well-sequenced WMP integrated risk-based project plan by year. The plan's 1-3-year horizon is well-defined, the 4-5-year horizon is projected with as much detail as feasible, and the 6-10-year horizon is more notional.

This step focuses on allocating resources to ready to execute projects, incorporating project constraints (siting, designing, permitting, costs, access to labor, availability of equipment and material, mobilization/demobilization, etc.), in a risk-based prioritized manner based on the information from the prior steps. A project may have a large risk reduction but permitting for the project is lengthy and may still be in progress; therefore, other projects with consequential risk benefit are sequenced ahead of the high risk-benefit project until it is ready to execute. This approach allows BVES to continuously make risk reduction progress in its grid hardening efforts. This step also considers other projects being executed and how best to seize synergy opportunities, improve resource allocation efficiency, stay focused on achieving the greatest risk reduction, and coordinate between projects to avoid inefficiencies, unnecessary delays, and re-work.

In sequencing projects, the focus is maximizing risk reduction. BVES prioritizes and plans work based upon the highest relative risk areas as determined in the Fire Safety Circuit Matrix

described in Section 7.1.1 of this WMP and the Risk Maps. As detailed in Section 5, Bear Valley's entire 32 square-mile service area is "high risk," considered "Very Dry" or "Dry" per the National Fire Danger Rating System (NFDRS) over 75 percent of the time and is characterized with a high density of vegetation – trees and shrubs. The CPUC Fire-Threat Map adopted January 19, 2018, designated Bear Valley's entire service area as within the High Fire-Threat District (HFTD) with approximately 90% in Tier 2 (elevated risk) and the remaining 10% in Tier 3 (extreme risk) areas. The Cal Fire California Fire Hazard Severity Zone Map Update Project rates Bear Valley's service area as "Very High Fire Hazard Severity Zone." While one can rank the relative risk of BVES's facilities within the service area, BVES's entire service area is high-risk. In such a small service area, an ignition anywhere can produce embers that the wind can carry just a few blocks away and cause a wildfire.

Project Progress Monitoring

BVES management tracks implementation of each mitigation project and initiative closely. Due to the size of the staff and service territory, all projects have full visibility up to the highest level of the utility. Additionally, staff conducts weekly management briefings and management reports to track progress, project needs, challenges, and delays, if any, on every project. Major initiative targets are reviewed at least weekly by management.

Project Execution Lessons Learned:

Lessons are learned at every step of the process, and it is inefficient to wait to make course corrections where appropriate. Therefore, BVES management uses its experience as well as external information to incorporate and address pertinent lessons learned in executing the WMP projects to deliver the maximum wildfire risk reduction while considering constraints. Lessons learned are not just limited to project execution but also from other utilities' experiences, updates from industry group (e.g., Institute of Electrical and Electronics Engineers (IEEE), National Electrical Safety Code (NESC), etc.), vendor and manufacturer updates, etc. The intended outcome is developing knowledge from both experience and external sources that will inform the entire WMP project cycle to create a process for continual improvement.

Lessons learned and best practices are discussed by the BVES management team at weekly meetings to promote continuous improvement in project processes.

Risk models are re-evaluated to ensure resources are allocated using the best information available at the time.

7.2 Wildfire Mitigation Strategy

In this section, BVES provides an overview of its proposed wildfire mitigation strategies based on the evaluation process identified in Section 7.1.

7.2.1 Overview of Mitigation Initiatives

The electrical corporation must provide a high-level summary of the portfolio of mitigation initiatives across its service territory. In addition, the electrical corporation must describe its reasoning for the proposed portfolio of mitigation initiatives and why it did not select other potential mitigation initiatives.

Additionally, for each mitigation initiative category, the electrical corporation must provide the following:

- *A high-level overview of the selected mitigation initiatives*

- *An implementation plan, including its schedule and how progress will be monitored*
- *How the need for any interim mitigation initiatives was determined and how interim mitigation initiatives were selected (see Section 7.2.3)*

BVES' high-level summary of mitigation initiatives across its service territory include geospatial areas where mitigation will be deployed, levels at which mitigation will be deployed, and brief descriptions of the scope of mitigation.

The three-year objectives include the annual WMP Update objectives with the additional grid hardening efforts, increased situational awareness and control improvements expected from completion of the grid automation initiatives, real-time fire risk modeling, and increased resiliency to serve load via local generation through potential solar and storage projects. BVES expects to make continued and substantial progress in replacing all sub-transmission bare wire with covered wire. BVES will also begin to harden secondary evacuation routes throughout the service area.

The ten-year objectives include significant reduction of wildfire ignition probability and improved system resilience. Much of this will stem from BVES's grid hardening efforts. BVES expects to fully realize the benefits from its various grid automation initiatives and its proposed solar and storage projects. BVES's long-term grid hardening will primarily be aimed at continuing to replace bare wire with covered wire on its sub-transmission and distribution systems. This project will continue over the next ten years addressing the highest risk circuits first. Additionally, in the next ten years, BVES will look to leverage the fiber network installed in its service area with new technologies in monitoring equipment, systems, and external conditions and bringing this data to databases to be utilized in risk determination (perhaps real-time) and to improve situational awareness of operational staff. Specific technologies and sensors will be considered over the next few years and may be included in future WMPs if warranted. BVES will also work to continue automating switches and equipment where feasible and beneficial to mitigate wildfire risk.

BVES's implementation strategy for each mitigation initiative selected in accordance with the risk-informed process discussed in Section 7.1, is displayed in Table 7-3 below.

Table 7-3 BVES WMP Mitigation Initiatives for 3-year and 10-year Outlooks

WMP Category	Within 3 Years	Within 10 Years	Location in WMP
Grid design, operations, and maintenance	<ul style="list-style-type: none"> • Replace all sub-transmission (34.5 kV) overhead bare conductors with covered conductors • Assess and remediate all sub-transmission (34 kV) poles • Harden secondary evacuation routes in highest risk areas 	<ul style="list-style-type: none"> • Replace all high and medium risk distribution (4 kV) overhead bare conductors with covered conductors • Assess and remediate all high and medium risk distribution (4 kV) poles • Harden secondary evacuation routes 	Section 8.1

WMP Category	Within 3 Years	Within 10 Years	Location in WMP
	<ul style="list-style-type: none"> • Remove all tree attachments from high-risk areas • On a priority basis, automate substations, switches, field devices, and fuse TripSavers and connect to SCADA • Replace Capacitor Banks and Connect to SCADA • Pursue development and execution of the Bear Valley Solar Energy Project • Pursue development and execution of the Energy Storage Project • Upgrade highest risk substations • Continue robust asset inspection routine of annual Detailed Inspections, Patrol Inspections, LiDAR surveys, UAV HD Photography & Thermography, 3rd party Ground Patrols, Intrusive Pole Testing, and Substation Inspections • Implement robust asset management and inspection enterprise system • Improve quality assurance and quality control program on asset 	<ul style="list-style-type: none"> • Remove all tree attachments from distribution system • Automate remaining substations, switches, field devices, and fuse TripSavers and connect to SCADA • Replace remaining Capacitor Banks and Connect to SCADA • Pursue other renewable generating facility opportunities • Pursue other energy storage project opportunities • Assess emerging technologies aimed at early detection of asset degradation, wire down detection, and other ignition prevention/mitigation technologies • Assess other emerging sub-transmission and distribution inspection techniques 	

WMP Category	Within 3 Years	Within 10 Years	Location in WMP
	work and asset inspection		
Community Outreach and Engagement	<ul style="list-style-type: none"> • Continue to deploy and improve public outreach and education awareness program(s) for wildfires; outages due to wildfires, PSPS events, and protective equipment and device settings; service restoration before, during, and after the incidents and vegetation management. Evaluate effectiveness of outreach efforts. • Continue to improve program to understand, evaluate, design, and implement wildfire and PSPS risk mitigation strategies, policies, and procedures specific to AFN customers. Evaluate effectiveness of these efforts. • Work with stakeholders to develop and integrate plans, programs, and/or policies for collaborating with communities on local wildfire mitigation planning, such as wildfire safety elements in 	<ul style="list-style-type: none"> • Implement social media and other effective platforms to increase public outreach and education awareness program(s) for wildfires; outages due to wildfires, PSPS events, and protective equipment and device settings; service restoration before, during, and after the incidents and vegetation management. Evaluate effectiveness of these outreach efforts. • Establish streamlined routine for sharing lessons learned and best practices among peers. 	Section 8.5

WMP Category	Within 3 Years	Within 10 Years	Location in WMP
	<p>general plans, community wildfire protection plans, and local multi-hazard mitigation plans. Evaluate effectiveness of these collaborative efforts.</p> <ul style="list-style-type: none"> Continue to be proactive in sharing and integration of best practices and collaborating with other electrical corporations on technical and programmatic aspects of WMP programs. 		
Situational Awareness and Forecasting	<ul style="list-style-type: none"> Complete online diagnostic pilot program and evaluate effectiveness. Complete installation of fault indicators (FIs). Evaluate need for additional (FIs). Evaluate need for additional weather stations. Evaluate need for additional HD Alert Cameras. Develop and implement Fire Potential Index. Improve staff proficiency in utilizing advanced fire threat weather forecasting tools. 	<ul style="list-style-type: none"> Evaluate effectiveness of installing cameras, infrared detectors, LiDAR instruments, and other technologies on overhead assets to provide remote monitoring. 	Section 8.3
Vegetation Management and Inspection	<ul style="list-style-type: none"> Maintain enhanced clearance specifications and 	<ul style="list-style-type: none"> Continue to conduct program to promote vegetation communities that are 	Section 8.2

WMP Category	Within 3 Years	Within 10 Years	Location in WMP
	<p>evaluate effectiveness.</p> <ul style="list-style-type: none"> • Continue to proactively remove/remediate high-risk species. • Continue robust vegetation inspection routine of annual Detailed Inspections, Patrol Inspections, LiDAR surveys, UAV HD Photography, 3rd party Ground Patrols, and Substation Inspections. • Implement robust vegetation management and inspection enterprise system. Ensure all trees within right-of-way tracked in data system. • Improve quality assurance and quality control program on vegetation management inspection and clearance work and asset inspection. • Develop and implement program to promote vegetation communities that are sustainable, fire-resilient, and compatible with the use of the land as an electrical corporation right-of-way. 	<p>sustainable, fire-resilient, and compatible with the use of the land as an electrical corporation right-of-way</p> <ul style="list-style-type: none"> • Evolve vegetation inspection cycles to be risk-based • Evolve vegetation clearance cycles to be risk-based 	

WMP Category	Within 3 Years	Within 10 Years	Location in WMP
Emergency Preparedness	<ul style="list-style-type: none"> • Improve staff training on emergency and disaster response plan through a combination of classroom instruction, table-top exercises, and functional drills. • Increase coordination with community stakeholders in emergency response. • Develop robust lines and layers of communications with stakeholders and customers. • Integrate plan to restore service after an outage due to a wildfire or PSPS event. • Establish strong programs, systems, and protocols to support residential and non-residential customers in wildfire emergencies and PSPS events. 	<ul style="list-style-type: none"> • Integrate emergency response plan with stakeholder emergency response plans • Evaluate increased use of social media and technology to improve and streamline communications with stakeholders and customers. 	Section 8.4

Project Progress Monitoring

All projects are monitored during and after their deployment to ensure progress continue on pace, spending aligns with expectations, and to ensure risk mitigation is maximized. Each initiative follows an implementation plan that tracks the schedule, the resources working on the initiative, materials, and other key indicators. BVES management also tracks the schedule and implementation of each mitigation project and initiative closely. Due to the size of the staff and service territory, all projects have full visibility up to the highest level of the utility. Additionally, staff conducts weekly management briefings and management reports to track progress, project needs, challenges, and delays, if any, on every project.

7.2.2 Anticipated Risk Reduction

In this section, the electrical corporation must present an overview of the expected risk reduction of its wildfire mitigation activities.

The electrical corporation must provide:

- Projected overall risk reduction
- Projected risk reduction on highest-risk circuits over the three-year WMP cycle

In the below subsections, BVES presents the expected risk reduction for each mitigation and the schedule on which it plans to implement the mitigation initiatives.

7.2.2.1 Projected Overall Risk Reduction

In this section, the electrical corporation must provide a figure showing the overall utility risk in its service territory as a function of time, assuming the electrical corporation meets the planned timeline for implementing the mitigations. The figure is expected to cover at least 10 years. If the electrical corporation proposes risk reduction strategies for a duration longer than ten years, this figure must show that corresponding time frame.

BVES' overall service area risk reduction depicted in Figure 7-4 and intends to provide an integrated view of wildfire risk reduction across its service territory over the next 10 years.

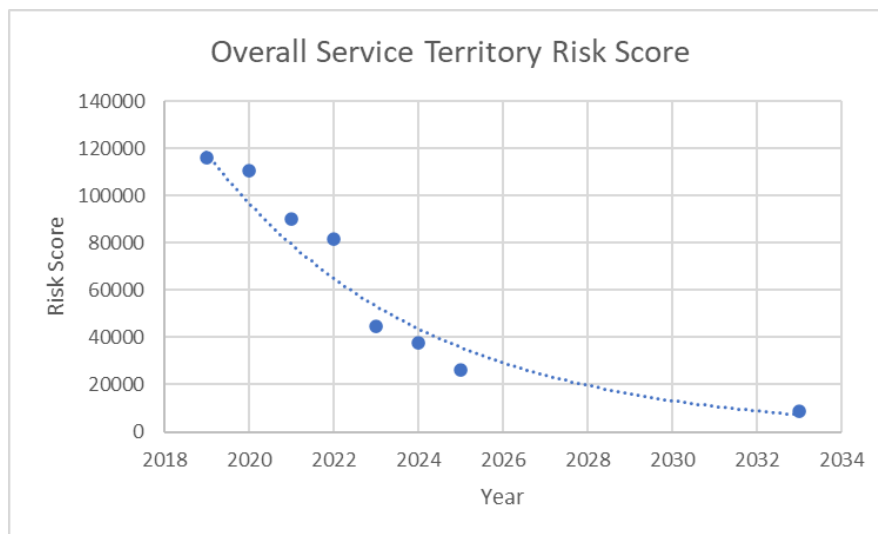

Figure 7-4 Projected Overall Service Territory Risk Graph

BVES Table 7-1 Projected Overall Service Territory Risk

Circuit	Substation	2019 Wildfire Risk Group ¹	2020 Wildfire Risk Group ¹	2021 Wildfire Risk Group ¹	2022 Wildfire Risk Group ¹	2023 Wildfire Risk Group ²	2024 Wildfire Risk Group ²	2025 Wildfire Risk Group ²	2033 Wildfire Risk Group ²
Radford	SCE Feed	30521	30621	31215	31215	522	522	522	522
Shay	SCE Feed	14230	13367	7103	3524	0	0	0	0
Baldwin	SCE Feed	7185	7763	7606	6891	6891	3197	345	345
Boulder	Village	3351	2951	1230	882	882	882	0	0
North Shore (Fawnskin)	Fawnskin	7518	7538	6721	6717	6717	6095	4585	0
Erwin Lake	Maltby	7401	3416	2006	0	0	0	0	0
Pioneer (Palomino)	Palomino	5706	5206	2426	2730	2730	2730	2730	0
Clubview	Moonridge	3460	4060	3331	3225	3011	2203	1193	0
Goldmine	Moonridge	5559	6659	4491	4539	4539	3731	2721	0
Paradise	Maltby	3493	3493	2894	1810	1242	1242	1242	0
Sunset	Maple	3583	3883	2533	2374	2075	2075	259	0
Sunrise (Maple)	Maple	2650	2650	2217	1857	1712	1712	396	0
Holcomb (Bear City)	Bear City	5916	4516	4205	4746	4746	3413	2605	1382
Georgia	Pineknott	1919	2019	1280	1384	1103	1103	1103	847
Eagle	Pineknott	2072	2072	1813	1813	1509	1509	1509	522
Harnish (Village)	Village	385	585	793	786	786	786	786	742
Garstin	Meadow	2440	1750	1392	1366	906	906	906	846
Lagonita	Village	2023	2323	1576	1533	1453	1453	1453	374
Interlaken	Meadow	3275	2475	1652	1485	1117	1117	1117	1009
Castle Glen (Division)	Division	1982	2238	2365	1483	1483	1483	1303	495
Country Club	Division	984	845	709	640	640	640	640	608
Fox Farm	Meadow	0	0	0	0	0	0	0	0
Pump House (Lake)	Lake	287	287	202	202	202	202	202	202
Lift (Summit TOU)	Summit	28	28	627	627	627	627	627	627
Skyline (Summit Res)	Summit	0	0	0	0	0	0	0	0
Geronimo (Bear Mtn.)	Bear Mtn.	0	0	0	0	0	0	0	0
		115969	110745	90386	81829	44891	37626	26243	8520
Wildfire Risk Groups									
	High	>3000							
	Moderate	1201-2999							
	Low	<1200							

7.2.2.2 Risk Impact of Mitigation Initiatives

The electrical corporation must calculate the expected “x% risk impact” of each of its mitigation initiative activity targets for each year from 2023–2025. The expected x% risk impact is the expected percentage risk reduction on the last day of each year compared to the first day of that same year. For example:

For protective devices and sensitivity settings, the risk on Jan. 1, 2024 = 2.59×10^{-1}

After meeting its planned initiative activity targets for protective devices and sensitivity settings, the risk on Jan. 1, 2024 = 1.29×10^{-1}

The expected x% risk impact for the protective devices and sensitivity settings initiative in 2024 is: $\text{risk before} - \text{risk after} \times 100 = 2.59 \times 10^{-1} - 1.29 \times 10^{-1} = 1.29 \times 10^{-1} \times 100 = 50\%$

The expected “x% risk impact” numbers must be reported for each planned mitigation initiative activities in the specific mitigation initiative sections of Section 8 (see example tables in Section 8).

BVES calculates the expected risk impact percentage of each of its mitigation initiative activity targets from 2023-2025 utilizing the following formula:

$$((\text{risk before} - \text{risk after}) / (\text{risk before})) \times 100$$

7.2.2.3 Projected Risk Reduction on Highest-Risk Circuits Over the Three-Year WMP Cycle

The objective of the service territory risk reduction summary is to provide an integrated view of wildfire risk reduction across the electrical corporation's service territory. The electrical corporation must provide the following information:

- *Tabular summary of numeric risk reduction for each high-risk circuit, showing risk levels before and after the implementation of mitigation initiatives. This must include the same circuits, segments, or span IDs presented in Section 6.4.2. The table must include the following information for each circuit:*
 - **Circuit, Segment, or Span ID:** Unique identifier for the circuit, segment, or span.
 - *If there are multiple initiatives per ID, each must be listed separately, using an extended to provide a unique identifier*
 - **Overall Utility Risk:** Numerical value for the overall utility risk before and after each mitigation initiative.
 - **Mitigation initiatives by implementation year:** Mitigation initiatives the electrical corporation plans to apply to the circuit in each year of the WMP cycle.

BVES' service area risk reduction depicted in Table 7-4 Figure 7-4 intends to provide an integrated view of wildfire risk reduction across its service territory from 2023-2025.

Table 7-4 Summary of Risk Reduction for Top-Risk Circuits

Circuit ID	Jan 1, 2023 Overall Risk	Jan 1, 2023 – Dec 31, 2023 Mitigation Initiatives	Jan 1, 2024 Overall Risk	Jan 1, 2024 – Dec 31, 2024 Mitigation Initiatives	Jan 1, 2025 Overall Risk	Jan 1, 2025 – Dec 31, 2025 Mitigation Initiatives	Jan 1, 2026 Overall Risk
Radford	31215	Covered Conductor & Fire-Resistant Poles	522	No Mitigation Initiatives Planned	522	No Mitigation Initiatives Planned	522
Shay	3524	Covered Conductor & Pole Assessment and Hardening	0	No Mitigation Initiatives Planned	0	No Mitigation Initiatives Planned	0
Baldwin	6891	Covered Conductor & Pole Assessment and Hardening	6891	Covered Conductor & Pole Assessment and Hardening	3197	Covered Conductor & Pole Assessment and Hardening	345
North Shore	6717	No Mitigation Initiatives Planned	6717	Covered Conductor & Pole Assessment and Hardening	6717	Covered Conductor & Pole Assessment and Hardening	4585

Circuit ID	Jan 1, 2023 Overall Risk	Jan 1, 2023 – Dec 31, 2023 Mitigation Initiatives	Jan 1, 2024 Overall Risk	Jan 1, 2024 – Dec 31, 2024 Mitigation Initiatives	Jan 1, 2025 Overall Risk	Jan 1, 2025 – Dec 31, 2025 Mitigation Initiatives	Jan 1, 2026 Overall Risk
Clubview	3225	Covered Conductor & Pole Assessment and Hardening	3011	Covered Conductor & Pole Assessment and Hardening	2203	Covered Conductor & Pole Assessment and Hardening	1193
Goldmine	4539	No Mitigation Initiatives Planned	4539	Covered Conductor & Pole Assessment and Hardening	3731	Covered Conductor & Pole Assessment and Hardening	2721
Holcomb	4746	No Mitigation Initiatives Planned	4746	Covered Conductor & Pole Assessment and Hardening	3413	Covered Conductor & Pole Assessment and Hardening	2605

7.2.3 Interim Mitigation Strategies

As indicated in Section 7.1.4.3, for each mitigation that will require greater than one year to implement, the electrical corporation must assess the potential need for interim mitigation initiatives to reduce risk until the primary or permanent mitigation initiative is in place. If the electrical corporation determines that an interim mitigation initiative is necessary, it must also develop and implement that initiative as appropriate.

The electrical corporation must provide a description of the following in this section of the WMP:

- *The electrical corporation's procedures for evaluating the need for interim risk reduction*
- *The electrical corporation's procedures for determining which interim mitigation initiative(s) to implement*
- *The electrical corporation's characterization of each interim risk management/reduction action and evaluation of its specific capabilities to reduce risks, including:*
 - *Potential consequences of risk event(s) addressed by the improvement/mitigation*
 - *Frequency of occurrence of the risk event(s) addressed by the improvement/mitigation*

Each interim mitigation initiative planned by the electrical corporation for implementation on high-risk circuits must be listed as a mitigation initiative in Section 8. In addition, interim mitigation initiatives must be discussed in the relevant mitigation initiative sections of the WMP and included in the related target tables.

BVES assesses each mitigation that requires more than one year to implement for the potential need for interim mitigation strategies to reduce risk until the primary mitigation is complete. BVES develops and implements interim strategies if determined necessary. BVES utilizes the approach discussed in Section 7.1.4.1 to evaluate the need for interim risk reduction, determining which mitigations to implement, and the characterization of each interim risk reduction action.

8. Wildfire Mitigation

8.1 Grid Design, Operations, and Maintenance

8.1.1 Overview

In this section, the electrical corporation must identify objectives for the next 3- and 10-year periods, targets, and performance metrics related to the following grid design, operations, and maintenance programmatic areas:

- *Grid design and system hardening*
- *Asset inspections*
- *Equipment maintenance and repair*
- *Asset management and inspection enterprise system(s)*
- *Quality assurance / quality control*
- *Open work orders*
- *Grid operations and procedures*
- *Workforce planning*

8.1.1.1 Objectives

Each electrical corporation must summarize the objectives for its 3-year and 10-year plans for implementing and improving its grid design, operations, and maintenance. These summaries must include the following:

- *Identification of which initiative(s) in the WMP the electrical corporation is implementing to achieve the stated objective, including Utility Initiative Tracking IDs*
- *Reference(s) to applicable codes, standards, and best practices/guidelines and an indication of whether the electrical corporation exceeds an applicable code, standard, or regulation*
- *Method of verifying achievement of each objective*
- *A target completion date*
- *Reference(s) to the WMP section(s) or appendix, including page numbers, where the details of the objective(s) are documented and substantiated*

This information must be provided in Table 8-1 for the 3-year plan and Table 8-2 for the 10-year plan. Examples of the minimum acceptable level of information are provided below.

Table 8-1 Grid Design, Operations, and Maintenance (3-Year Plan)

Objectives (3-year plan) Objectives for Three Years	Applicable Initiative(s), Tracking ID(s)	Applicable Regulations, Codes, Standards, and Best Practices (See Notes)	Method of Verification (i.e., program)	Completion Date	Reference (Section and Page Number)
Replace all sub-transmission (34.5 kV)	Covered Conductor Replacement Project,	GO 95	Completion of planned targeted covered	31-Dec-25	8.1.2.1; pg. 103

Objectives (3-year plan) Objectives for Three Years	Applicable Initiative(s), Tracking ID(s)	Applicable Regulations, Codes, Standards, and Best Practices (See Notes)	Method of Verification (i.e., program)	Completion Date	Reference (Section and Page Number)
overhead bare conductors with covered conductors	covered conductor installation GD_1 Radford Line Replacement Project, Covered conductor installation GD_2		conductor each year through work orders and visual verification.		
Assess and remediate all sub-transmission (34 kV) poles	Covered Conductor Replacement Project, covered conductor installation GD_3 Radford Line Replacement Project, Covered conductor installation GD_4	GO 95	Completion of planned targeted covered conductor each year through work orders and visual verification.	31-Dec-25	8.1.2.2; pg. 104
Harden secondary evacuation routes in highest risk areas	Evacuation Route Hardening Project, Distribution pole replacements and reinforcements, GD_6	GO 95 GO 165	Completion of planned targeted evacuation route hardening through work orders and visual verification.	31-Dec-25	8.1.2.3; pg. 105
Remove all tree attachments from high-risk areas	Tree Attachment Removal Project, Other grid topology improvements to minimize risk	PRC 4292	Completion of planned targeted tree attachments through work orders and sampled	31-Dec-25	8.1.2.10; pg. 116

Objectives (3-year plan) Objectives for Three Years	Applicable Initiative(s), Tracking ID(s)	Applicable Regulations, Codes, Standards, and Best Practices (See Notes)	Method of Verification (i.e., program)	Completion Date	Reference (Section and Page Number)
	of ignitions, GD_19		visual verification.		
On a priority basis, automate substations, switches, field devices, and fuse TripSavers and connect to SCADA	Substation Automation, Installation of system automation equipment, GD_12 Switch and Field Device Automation, Installation of system automation equipment, GD_13 Fuse TripSavers Automation, Installation of system automation equipment, GD_15	GO 95	Completion of planned targeted projects through work orders, SCADA review.	31-Dec-25	8.1.2.8; pg. 110
Replace Capacitor Banks and Connect to SCADA	Capacitor Bank Upgrade Project, Installation of system automation equipment, GD_14	GO 95	Completion of planned targeted capacitor banks through work orders, SCADA review.	31-Dec-25	8.1.2.8; pg. 110
Pursue development and execution of the Bear Valley Solar Energy Project	Bear Valley Solar Energy Project, Microgrids, GD_10	GO 95	Work with suppliers and regulatory agencies to develop Solar Energy Project, verified via	31-Dec-24	8.1.2.7; pg. 109

Objectives (3-year plan) Objectives for Three Years	Applicable Initiative(s), Tracking ID(s)	Applicable Regulations, Codes, Standards, and Best Practices (See Notes)	Method of Verification (i.e., program)	Completion Date	Reference (Section and Page Number)
			work orders, visual verification, and SCADA review.		
Pursue development and execution of the Energy Storage Project	Energy Storage Project, Microgrids, GD_11	GO 95	Work with supplier and regulatory agencies to develop Energy Storage Project, verified via work orders, visual verification,	31-Dec-24	8.1.2.7; pg. 109
Upgrade highest risk substations	Partial Safety and Technical Upgrades to Maltby Substation, Other technologies and systems not listed above, GD_22	GO 95	Completion of planned targeted substations through work orders, verified via work orders, visual verification, and SCADA review.	31-Dec-25	8.1.2.12; pg. 119 8.1.4.2; pg. 128
Continue robust asset inspection routine of annual Detailed Inspections, Patrol Inspections, LiDAR surveys, UAV HD Photography & Thermography,	Asset inspections, GD-25, GD_26, GD_27, GD_28, GD_29, GD_30, GD_31, GD_32	GO 95	Complete planned targeted inspections through work orders.	31-Dec-25	8.1.3.1 – 8.1.3.9; pg. 121-126

Objectives (3-year plan) Objectives for Three Years	Applicable Initiative(s), Tracking ID(s)	Applicable Regulations, Codes, Standards, and Best Practices (See Notes)	Method of Verification (i.e., program)	Completion Date	Reference (Section and Page Number)
3rd party Ground Patrols, Intrusive Pole Testing, and Substation Inspections					
Implement robust asset management and inspection enterprise system	Asset management and inspection enterprise system(s), GD_34	GO 95	Provide asset management and inspection reports.	31-Dec-23	8.1.5; pg. 131-134
Improve quality assurance and quality control program on asset work and asset inspection	Quality assurance / quality control, GD-35	GO 95	Provide quality assurance and quality control reports.	31-Dec-23	8.1.6; pg. 135-137

Note: An asterisk indicates that the electrical corporation exceeds a particular code, regulation, standard, or best practice. The electrical corporation must provide a reference to the appendix section and page providing further documentation, justification, and substantiation.

Table 8-2 Grid Design, Operations, and Maintenance Objectives (10-Year Plan)

Objectives for 10 Years (2026 -2032)	Applicable Initiative(s), Tracking ID(s)	Applicable Regulations , Codes, Standards, and Best Practices (See Notes)	Method of Verification (i.e., program)	Completion Date	Reference (Section and Page Number)
Replace all high and medium risk distribution (4 kV) overhead bare	Covered Conductor Replacement Project, Covered	GO 95	Completion of planned targeted covered conductor each year	31-Dec-32	Section 8.1.2.1; pg.103

Objectives for 10 Years (2026 -2032)	Applicable Initiative(s), Tracking ID(s)	Applicable Regulations , Codes, Standards, and Best Practices (See Notes)	Method of Verification (i.e., program)	Completion Date	Reference (Section and Page Number)
conductors with covered conductors	conductor installation GD_1		through work orders, visual verification.		
Assess and remediate all high and medium risk distribution (4 kV) poles	Covered Conductor Replacement Project, Covered conductor installation GD_3	GO 95	Completion of planned targeted covered conductor each year through work orders, visual verification.	31-Dec-32	Section 8.1.2.3; pg. 105
Harden secondary evacuation routes	Evacuation Route Hardening Project, Distribution pole replacements and reinforcements , GD_6	GO 95	Planned targeted evacuation route hardening through work orders, visual verification.	31-Dec-32	Section 8.1.2.3; pg. 105
Remove all tree attachments from distribution system	Tree Attachment Removal Project, Other grid topology improvements to minimize risk of ignitions, GD 19	GO 95	Completion of planned targeted tree attachments through work orders, visual verification.	31-Dec-32	8.1.2.10; pg. 116
Automate remaining substations, switches, field devices, and fuse TripSavers and connect to SCADA	Substation Automation, Installation of system automation equipment, GD_12 Switch and Field Device	GO 95	Completion of planned targeted substations through work orders, SCADA review.	31-Dec-32	8.1.2.8; pg. 110

Objectives for 10 Years (2026 -2032)	Applicable Initiative(s), Tracking ID(s)	Applicable Regulations , Codes, Standards, and Best Practices (See Notes)	Method of Verification (i.e., program)	Completion Date	Reference (Section and Page Number)
	Automation, Installation of system automation equipment, GD_13 Fuse TripSavers Automation, Installation of system automation equipment, GD_15				
Replace remaining Capacitor Banks and Connect to SCADA	Capacitor Bank Upgrade Project, Installation of system automation equipment, GD_14	GO 95	Completion of planned targeted capacitor banks through work orders, SCADA review.	31-Dec-32	8.1.2.8; pg. 110
Pursue other renewable generating facility opportunities	Microgrids, GD_10	GO 95	Meeting minutes, planning documents, as applicable.	31-Dec-32	8.1.2.7; pg. 109
Pursue other energy storage project opportunities	Microgrids, GD_11	GO 95	Meeting minutes, planning documents, as applicable.	31-Dec-32	8.1.2.7; pg. 109
Assess emerging technologies aimed at early detection of asset degradation, wire down detection, and other ignition prevention/mitigation technologies	Emerging grid hardening technology installations and pilots, GD_9	GO 95	Assess technologies with vendors and other IOUs to determine if a pilot project is needed.	31-Dec-32	8.1.2.6; pg. 109

Objectives for 10 Years (2026 -2032)	Applicable Initiative(s), Tracking ID(s)	Applicable Regulations , Codes, Standards, and Best Practices (See Notes)	Method of Verification (i.e., program)	Completion Date	Reference (Section and Page Number)
Assess other emerging sub-transmission and distribution inspection techniques	Asset inspections, GD-25, GD_26, GD_27, GD_28, GD_29, GD_30, GD_31, GD_32	GO 95	Assess distribution inspection technologies with vendors and other IOU to determine if new inspections are added	31-Dec-32	8.1.3.1-8.1.3.9; pg. 121-126

Note: An asterisk indicates that the electrical corporation exceeds a particular code, regulation, standard, or best practice. The electrical corporation must provide a reference to the appendix section and page providing further documentation, justification, and substantiation.

8.1.1.2 Targets

Initiative targets are forward-looking quantifiable measurements of activities identified by each electrical corporation in its WMP. Electrical corporations will show progress towards completing targets in subsequent reports, including QDRs and WMP Updates.

The electrical corporation must list all targets it will use to track progress on its grid design, operations, and maintenance for three years of the Base WMP. Energy Safety’s Compliance Assurance Division and third parties must be able to track and audit each target. For each initiative target, the electrical corporation must provide the following:

- *Utility Initiative Tracking IDs*
- *Projected targets for the three years of the Base WMP and relevant units*
- *Quarterly, rolling targets for end of 2023 and 2024 (inspections only)*
- *For 2023–2025, the “x% risk impact.” The x% risk impact is the percentage risk reduction identified in Table 7-2 for a specific mitigation initiative (see Section 7.2.2.1 for calculation instructions)*
- *Method of verifying target completion*

The electrical corporation’s targets must provide enough detail to effectively inform efforts to improve the performance of the electrical corporation’s grid design, operations, and maintenance initiatives.

Table 8-3 Grid Design, Operations, and Maintenance Targets by Year

Initiative Activity	Tracking ID	Units	2023 Target	x% Risk Impact 2023	2024 Target	x% Risk Impact 2024	2025 Target	x% Risk Impact 2025	Method of Verification
Covered conductor installation	GD_1	Circuit Miles of Line Replaced	12.9	3.62%	12.9	3.62%	5.1	3.62%	Quantitative
Covered conductor installation	GD_2	Circuit Miles of Line Replaced	2.7	3.62%	0	N/A	0	N/A	Quantitative
Undergrounding of electric lines and/or equipment	GD_3	Initiate Underground Projects as needed (% of Budget)	100%	4.98%	100%	4.98%	100%	4.98%	Budget Review
Distribution pole replacements and reinforcements	GD_4	Number of Poles Replaced	200	60%	200	60%	100	60%	Quantitative
Distribution pole replacements and reinforcements	GD_5	Number of Poles Replaced	70	88%	0	N/A	0	N/A	Quantitative
Distribution pole replacements and reinforcements	GD_6	Number of Poles that had Wire Mesh Installed on them	500	12%	500	12%	500	12%	Quantitative

Initiative Activity	Tracking ID	Units	2023 Target	x% Risk Impact 2023	2024 Target	x% Risk Impact 2024	2025 Target	x% Risk Impact 2025	Method of Verification
Transmission pole/tower replacements and reinforcements	GD_7	N/A	N/A	N/A	N/A	N/A	N/A	N/A	N/A
Traditional overhead hardening	GD_8	As Needed Maintenance (% of Budget)	100%	4.36%	100%	4.36%	100%	4.36%	Budget Review
Emerging grid hardening technology installations and pilots	GD_9	N/A	N/A	N/A	N/A	N/A	N/A	N/A	N/A
Microgrids	GD_10	Preform Necessary Project Action	No Action	N/A	File Application	N/A	No Action	N/A	Project Timeline and Budget
Microgrids	GD_11	Preform Necessary Project Action	No Action	N/A	File Application & Obtain Permit	N/A	No Action	N/A	Project Timeline and Budget

Initiative Activity	Tracking ID	Units	2023 Target	x% Risk Impact 2023	2024 Target	x% Risk Impact 2024	2025 Target	x% Risk Impact 2025	Method of Verification
Installation of system automation equipment	GD_12	Number of Substations Automated and Connected to SCADA	3	29%	3	29%	3	29%	Quantitative
Installation of system automation equipment	GD_13	Number of Field Switches Automated and Connected to SCADA	13	22%	10	22%	11	22%	Quantitative
Installation of system automation equipment	GD_14	Number of Capacitor Banks Replaced and Connected to SCADA	6	29%	6	29%	6	29%	Quantitative
Installation of system automation equipment	GD_15	Number of Fuse TripSavers Automated and Connected to SCADA	10	29%	50	29%	50	29%	Quantitative

Initiative Activity	Tracking ID	Units	2023 Target	x% Risk Impact 2023	2024 Target	x% Risk Impact 2024	2025 Target	x% Risk Impact 2025	Method of Verification
Installation of system automation equipment	GD_16	Project Milestones for Server Installation	32%	84%	64%	84%	100% Project Completion	N/A	Project Timeline and Budget
Installation of system automation equipment	GD_17	Project Milestones for Distribution Management Center	No Action	72%	50% Project Completion	72%	100% Project Completion	N/A	Project Timeline and Budget
Line removals (in HFTD)	GD_18	N/A	N/A	N/A	N/A	N/A	N/A	N/A	N/A
Other grid topology improvements to minimize risk of ignitions	GD_19	Number of Tree Attachments Removed	100	10%	100	10%	100	10%	Quantitative
Other grid topology improvements to mitigate or reduce PSPS events	GD_20	N/A	N/A	N/A	N/A	N/A	N/A	N/A	N/A
Other technologies and systems not listed above	GD_21	Project Milestones for Natural Engine Upgrades	32%	24.8%	64%	24.8%	100% Project Completion	N/A	Project Timeline and Budget

Initiative Activity	Tracking ID	Units	2023 Target	x% Risk Impact 2023	2024 Target	x% Risk Impact 2024	2025 Target	x% Risk Impact 2025	Method of Verification
Other technologies and systems not listed above	GD_22	Project Milestones for Maltby Substation	32%	87%	64%	87%	100% Project Completion	N/A	Project Timeline and Budget
Other technologies and systems not listed above	GD_23 ⁶	Project Milestones for Lake Substation	32%	87%	64%	87%	100% Project Completion	N/A	Project Timeline and Budget
Other technologies and systems not listed above	GD_24 ⁷	Project Milestones for Village Substation	32%	87%	64%	87%	100% Project Completion	N/A	Project Timeline and Budget
Equipment maintenance and repair	GD_33	As Needed Maintenance (% of Budget)	100%	4.36%	100%	4.36%	100%	4.36%	Budget Review
Asset management and inspection enterprise system(s)	GD_34	Maintenance of Asset Management System	100%	4.36%	100%	4.36%	100%	4.36%	Budget Review
Quality assurance / quality control	GD_35	Number of Asset QCs on WMP Work	20	4.36%	20	4.36%	20	4.36%	Quantitative

⁶ The program completion has been moved to 2026. Details about the change can be found in the 2025 WMP Update.

⁷ The program completion has been moved to 2027. Details about the change can be found in the 2025 WMP Update.

Initiative Activity	Tracking ID	Units	2023 Target	x% Risk Impact 2023	2024 Target	x% Risk Impact 2024	2025 Target	x% Risk Impact 2025	Method of Verification
Open work orders	GD_36	No discrepancies exceeding GO95 resolution timeframes	All WO resolved within GO 95 Timeframe	N/A	All WO resolved within GO 95 Timeframe	N/A	All WO resolved within GO 95 Timeframe	N/A	WO Log
Equipment Settings to Reduce Wildfire Risk	GD_37	Review and Evaluate System Settings	Review and Evaluate System Settings	4.36%	Review and Evaluate System Settings	4.36%	Review and Evaluate System Settings	4.36%	Meeting Minutes
Grid Response Procedures and Notifications	GD_38	Review and Update Procedure Annually	Finalize Review	84%	Finalize Review	84%	Finalize Review	84%	Version History
Personnel Work Procedures and Training in Conditions of Elevated Fire Risk	GD_39	Review and Update Procedure Annually. Verification of Training Annual	Finalize Review	3.62%	Finalize Review	3.62%	Finalize Review	3.62%	Version History

Initiative Activity	Tracking ID	Units	2023 Target	x% Risk Impact 2023	2024 Target	x% Risk Impact 2024	2025 Target	x% Risk Impact 2025	Method of Verification
Workforce Planning	GD_40	Verify Appropriate Staffing Levels for Wildfire Related Activities	Staffing Level Verified	3.62%	Staffing Level Verified	3.62%	Staffing Level Verified	3.62%	Meeting Minutes

Table 8-4 Asset Inspections Targets by Year

Initiative Activity	Tracking ID	Units	Target End of Q2 2023	Target End of Q3 2023	End of Year Target 2023	X% Risk Impact 2023	Target End of Q2 2024	Target End of Q3 2024	End of Year Target 2024	X% Risk Impact 2024	Target End of Q2 2025	Target End of Q3 2025	End of Year Target 2025	X% Risk Impact 2025	Method of Verification
Asset inspections	GD_25	Circuit Miles Inspected	60	100	134	4.36%	0	40	51	4.36%	0	20	53	4.36%	Quantitative
Asset inspections	GD_26	Circuit Miles Inspected	0	211	211	4.36%	0	211	211	4.36%	102	153	205	4.36%	Quantitative
Asset inspections	GD_27	Circuit Miles Inspected	0	211	211	4.36%	0	211	211	4.36%	0	205	205	4.36%	Quantitative

Initiative Activity	Tracking ID	Units	Target End of Q2 2023	Target End of Q3 2023	End of Year Target 2023	X% Risk Impact 2023	Target End of Q2 2024	Target End of Q3 2024	End of Year Target 2024	X% Risk Impact 2024	Target End of Q2 2025	Target End of Q3 2025	End of Year Target 2025	X% Risk Impact 2025	Method of Verification
Asset inspections	GD_28	Circuit Miles Inspected	0	211	211	4.36%	0	211	211	4.36%	0	205	205	4.36%	Quantitative
Asset inspections	GD_29	Circuit Miles Inspected	0	211	211	4.36%	0	211	211	4.36%	0	205	205	4.36%	Quantitative
Asset inspections	GD_30	Circuit Miles Inspected	0	211	211	4.36%	0	211	211	4.36%	0	205	205	4.36%	Quantitative
Asset inspections	GD_31	Number of Poles Intrusively Inspected	0	300	850	4.36%	0	300	850	4.36%	0	300	850	4.36%	Quantitative
Asset inspections	GD_32	Number of Substations Inspected	72	108	144	4.36%	72	108	144	4.36%	72	108	144	4.36%	Quantitative

8.1.1.3 Performance Metrics Identified by the Electrical Corporation

Performance metrics indicate the extent to which an electrical corporation’s Wildfire Mitigation Plan is driving performance outcomes. The electrical corporation must:

- List the performance metrics the electrical corporation uses to evaluate the effectiveness of its grid design, operations, and maintenance in reducing wildfire and PSPS risk

For each of these performance metrics listed, the electrical corporation must:

- Report the electrical corporation’s performance since 2020 (if previously collected)
- Project performance for 2023-2025
- List method of verification

The electrical corporation must ensure that each metric’s name and values are the same in its WMP reporting as its QDR reporting (specifically, QDR Table 2 and QDR Table 3). Metrics listed in this section that are the same as performance metrics required by Energy Safety and reported in QDR Table 2 (Performance Metrics) must match those reported in QDR Table 2. Metrics listed in this section that are not the same as any of the performance metrics identified by Energy Safety and reported in QDR Table 2 must match those reported in QDR Table 3.

The electrical corporation must:

- Summarize its self-identified performance metrics in tabular form
- Provide a brief narrative that explains trends in the metrics

Table 8-5 Grid Design, Operations, and Maintenance Performance Metrics Results by Year

Performance Metrics	2020	2021	2022	2023 Projected	2024 Projected	2025 Projected	Method of Verification (e.g., third-party evaluation, QDR)
Equipment caused ignitions	0	0	0	0	0	0	QDR
Equipment caused outages	61	51	75	62	62	62	QDR
Grid inspection findings	733	151	356	415	415	415	QDR

8.1.2 Grid Design and System Hardening

In this section the electrical corporation must discuss how it is designing its system to reduce ignition risk and what it is doing to strengthen its distribution, transmission, and substation infrastructure to reduce the risk of utility-related ignitions resulting in catastrophic wildfires.

The electrical corporation is required, at a minimum, to discuss grid design and system hardening for each of the following mitigation activities:

1. *Covered conductor installation*
2. *Undergrounding of electric lines and/or equipment*
3. *Distribution pole replacements and reinforcements*
4. *Transmission pole/tower replacements and reinforcements*
5. *Traditional overhead hardening*
6. *Emerging grid hardening technology installations and pilots*
7. *Microgrids*
8. *Installation of system automation equipment*
9. *Line removal (in the HFTD)*
10. *Other grid topology improvements to minimize risk of ignitions*
11. *Other grid topology improvements to mitigate or reduce PSPS events*
12. *Other technologies and systems not listed above*

In Sections 8.1.2.1 through 8.1.2.12, the electrical corporation must provide a narrative including the following information for each grid design and system hardening mitigation activity:

- **Utility Initiative Tracking ID.**
- **Overview of the activity:** *A brief description of the activity including reference to related objectives and targets. Additionally, the overview must identify whether the activity is a program, project, pilot, or study.*
- **Impact of the activity on wildfire risk.**
- **Impact of the activity on PSPS risk.**
- **Updates to the activity:** *Changes to the initiative since the last WMP submission and a brief explanation as to why those change were made. Discuss any planned improvements or updates to the activity and the timeline for implementation.*

8.1.2.1 Covered Conductor Installation (Tracking ID: GD_1 &GD_2)

Overview

Covered conductors are any conductors (wires) covered by layers of insulation. Vendors designed these wires to withstand incidental contact with vegetation or other debris. Bare wires were historically used to provide a reliable, cost-effective solution for delivering energy to

customers. BVES performed covered conductor pilot programs under previous WMPs that demonstrated reduced fire risk and no impacts on reliability. Covered wire is an accepted practice to eliminate tree and vegetation and debris contact to reduce wildfire ignitions. Undergrounding the 34 kV system would be the only other technically acceptable alternative. However, the cost would be over 10 times that of the covered wire replacement project. Additionally, certain areas present significant challenges to underground the overhead system. The Covered Wire Program therefore yields a more attractive RSE. BVES, therefore, decided to replace bare conductors with covered conductors on all sub-transmission lines (34.5 kV) and to replace all bare 4 kV distribution wire in high-risk areas within the service area with covered wire. The replacement program is prioritized based on higher risk circuits to maximize the risk reduction.

Impact of the Activity on Wildfire Risk

This initiative intends to reduce potential ignition events by installing wire with insulated protective covers. It also addresses the replacement of standard bare or unprotected conductors (defined in accordance with GO 95 as supply conductors, including but not limited to lead wires, not enclosed in a grounded metal pole, or not covered by: a “suitable protective covering” (in accordance with Rule 22.8), grounded metal conduit, or grounded metal sheath or shield).

The Covered Wire Program replaces 34.5 kV bare wire at a rate of 4.3 circuit miles per year and replaces 4 kV bare wire at a rate of 8.6 circuit miles per year. Additionally, the Radford Line Replacement Project is addressed under this subsection.

Covered Wire Program – 34.5 kV System

BVES intends to install covered wire on all sub-transmission lines (34.5 kV). This will result in the entire overhead 34.5 kV system in the HFTD being either underground or covered. This program will reduce the risk of sub-transmission lines contacting vegetation or other debris and causing an ignition to near zero.

BVES plans to replace all overhead sub-transmission bare wire with covered wire over a 6-year period of execution from 2020 to 2026 covering approximately 4.3 miles per year.

Covered Wire Program – 4 kV System

BVES intends to replace all bare 4 kV distribution wire in identified high-risk areas within the HFTD with covered wire. This will result in approximately 86 miles of the 4 kV distribution lines in the system in the HFTD being covered at approximately 8.6 miles per year for the next 10 years. Based upon this schedule, 4kV wire in high-risk areas will be replaced by 2032. The remaining 4 kV lines will take another 10 years. This program will significantly reduce the risk of distribution lines contacting vegetation or other debris and causing an ignition. The high-risk areas are primarily defined by high vegetation density.

Based on benchmarking with other utilities’ estimated effectiveness against ignition risks, discussions with its covered conductor suppliers, and the short amount of time that it has installed covered conductor, BVES believes that the estimate of effectiveness on ignition risk drivers in its service territory is approximately 90%. For comparison, the SCE estimated full deployment of covered conductor in high-risk areas to mitigate approximately 60 percent of fires associated with electrical distribution facilities in defined risk tiers. BVES believes SCE’s

effectiveness results are a valid, relative measure of effectiveness of this technology, with underground conversion providing the baseline (100 percent) for purposes of our comparison.

Covered Conductor Project – Radford Line Sub-transmission Project

This project includes two components: (1) replacement of the bare wire with covered conductor and (2) replacement of the wood poles with fire resistant poles. The bare wire replacement portion of the project is discussed and tracked in this initiative. The pole replacement portion of the project is discussed and tracked under initiative Section 8.1.2.3 (Distribution pole replacement and reinforcement, including with composite poles).

BVES is replacing bare wire with covered conductor on the Radford 34.5 kV line. BVES chose to cover this line specifically, which resides in the HFTD Tier 3 area, since it has the highest wildfire risk of all of BVES's overhead facilities. The line is in a densely vegetated area that is difficult to patrol, due to no road access. The project also includes replacing the aged wood poles with fire resistant poles. Replacing the bare wire with covered wire will provide a high-level of effectiveness for preventing a potential ignition leading to a wildfire. Utilizing fire resistant poles will improve resiliency to quickly restore power to Big Bear Lake in the event the area suffers a major wildfire. All bare wire in the HFTD Tier 3 is to be covered by end of calendar year 2023 if permitting issues with the USFS are resolved in time to complete construction prior to the winter of 2023.

Impact of the Activity on PSPS Risk

The expanded use of covered conductor will reduce BVES's likelihood of implementing a PSPS because it reduces the risk of vegetation or debris contacting a bare live wire which can cause an ignition. Additionally, once the Radford Line has covered conductor installed that line will no longer be de—energized during fire season and can limit the impact of a SCE-activated PSPS of BVES's supply lines.

Updates to the Activity

BVES will apply any lessons learned throughout the progression of the program, collecting information on supply logistics, pole replacements necessary to support covered wire installation, and covered wire installation work techniques and rates to optimize the program execution. As part of the project, BVES will install utility fiber cable and will use this for future system monitoring efforts (cameras, infrared sensors, system diagnostics sensors, etc.) and for fast acting switches on the circuit.

BVES participates in the joint utilities workshop on covered wire and will continue to exchange information in this area with other utilities. BVES also attends T&D conferences and review T&D literature and periodicals on the latest in covered wire operations and maintenance.

34.5kV System

BVES will continue covered conductor installations on high-risk areas towards a program goal of 100 percent completion by end of calendar year 2026.

4kV System

BVES will continue replacing 4 kV bare wire in high-risk areas towards a program goal of 100 percent completion (for high-risk areas) by end of calendar year 2032. BVES will then continue to replace 4 kV bare wire until it no longer has bare wire in its 4kV system.

Radford Line

BVES was delayed in 2022 from installing covered conductor on the Radford Line due to permitting delays with the US Forest Service (USFS). BVES is now meeting with USFS regularly and expects to receive the permit and complete the work by November 2023.

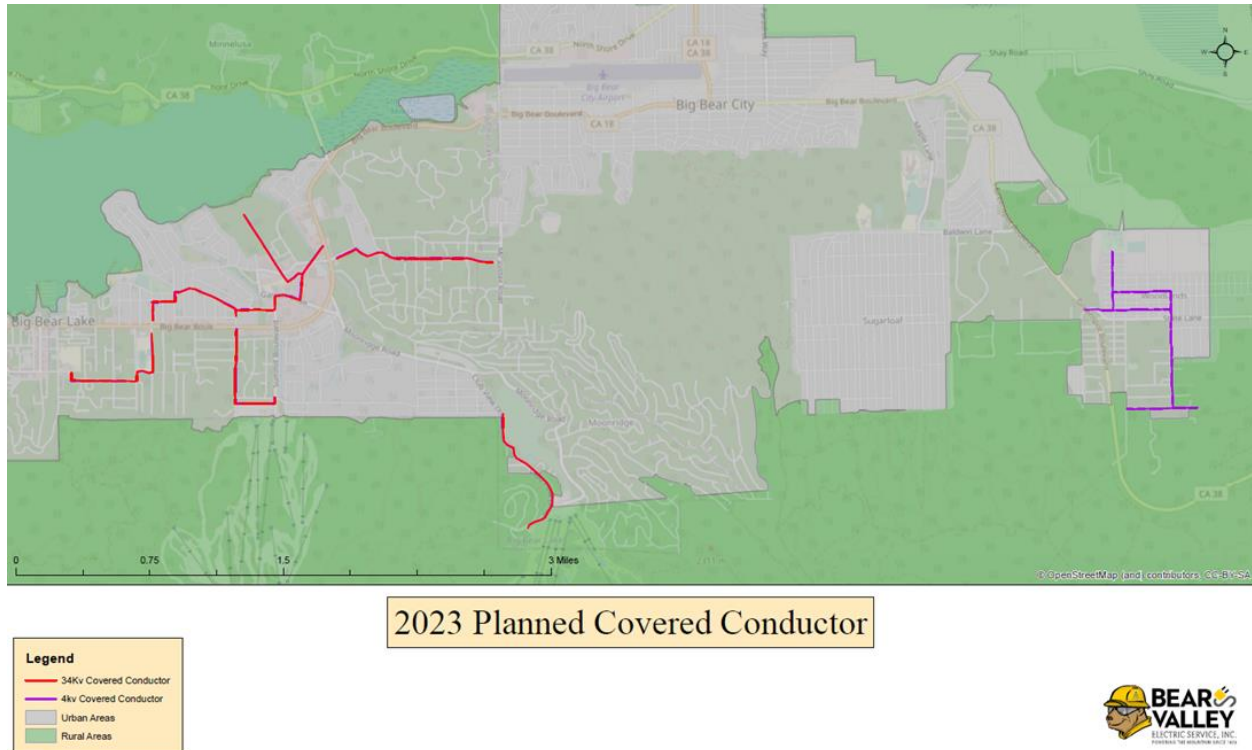

Figure 8-1 2023 Planned Covered Conductor Installation Location

8.1.2.2 Undergrounding of Electric Lines and/or Equipment (Tracking ID: GD_3)

Overview

BVES currently does not have any major undergrounding projects planned. This activity addresses the utility actions taken to underground (UG) electrical lines and equipment in accordance with GO 128. Converting circuits from overhead to underground nearly eliminates the risk of ignition and exists minimally surrounding the area where equipment resurfaces.

BVES does not have any major UG projects planned at this time. BVES conducts small undergrounding projects for new developments and services and minor upgrades to existing facilities. When feasible, BVES works to install UG facilities for new developments and services to reduce the number of overhead facilities and therefore the risk those facilities pose to wildfire. BVES also conducts small upgrades to existing UG facilities so that service is safe, reliable, and of high quality. The alternative is to convert to bare conductor overhead facilities to covered

conductor overhead facilities. The major advantage of covered conductors is that they cost significantly less per circuit mile than UG facilities yet the marginal gain in risk reduction by utilizing UG instead of covered conductors is not nearly as significantly.

Impact of the Activity on Wildfire Risk

The minor UG projects that BVES engages in are generally driven by the customer or local government and are generally new facilities; therefore, it is difficult to prioritize them by wildfire risk. However, as noted before, BVES's entire service area is extreme or elevated risk so any UG has a significant wildfire risk benefit.

Impact of the Activity on PSPS Risk

The minimal amount of UG projects described above are not expected to have any impact on BVES's likelihood to activate a PSPS.

Updates to the Activity

There are no immediate plans for large-scale undergrounding projects in 2023. BVES will continue to conduct small UG projects driven by new developments and local government in 2023.

BVES will continue to reassess the need of potential undergrounding projects and will continue to exchange information with the other utilities on the advantages and disadvantages of UG and covered conductors through working groups. BVES will watch carefully for any advances in UG installation, especially those that reduce the price point while maintaining GO 128 minimum specifications.

8.1.2.3 Distribution Pole Replacements and Reinforcements (Tracking ID: GD_4 – GD_5, GD_6)

Overview

This initiative covers costs associated with four separate programs and projects, which includes Distribution Pole Replacement and reinforcement, covered conductor Radford Line project, and the evacuation route hardening program.

Distribution Pole Replacement and Reinforcement – GO 95 Projects (Tracking ID: GD_6)

Overview

In compliance with GOs 95 and 165, BVES has an ongoing program to assess and remediate noncompliant distribution poles. GO 95 Rule 43.1 requires BVES to design, build, and maintain their overhead facilities to withstand foreseeable fire and wind conditions in the service territory. Poles that are not compliant with GO 95 safety factors will be identified, and the appropriate remediation will be designed and implemented. Depending on the nature and extent of the noncompliance, the remediation will require either repair (e.g., the installation or modification of guy wires) or complete replacement of the pole, including removal and reinstallation of all attachments, all within the time frames required by GO 95. GO 95 is aimed at the safety of personnel, the public, and preserving the reliability of the power grid. Risk is significantly

reduced when poles are brought into compliance with laws directed at preserving safety and reliability.

Impact of the Activity on Wildfire Risk

Meeting or exceeding the mandates of GO 95 is critical to mitigate wildfires. Noncompliant poles are a fire risk. Since the entire BVES service area is in a HFTD Tiers 2 and 3, any pole failure is considered a high fire risk. Additionally, BVES is above 3000 ft sea level and is subject to heavy loading requirements. Overhead distribution lines are exposed to severe weather including heavy snow, ice, and high winds.

To promote efficiency and minimize duplication of work, and subject to the remediation time frames in GO 95, the rate of testing and resulting remediation designs may be integrated with other potential work proposed in the same area which is also more operationally efficient and cost effective. In addition, the program may require a sufficient number of pole replacements on a line or in a concentrated area that it is prudent to undertake a more comprehensive replacement design, as opposed to mere replacement of individual poles. The remediation work is performed by BVES, or contractor resources based on available capacity, cost, and other related factors.

Impact of the Activity on PSPS Risk

This activity will lower the risk of PSPS activation on BVES's system. Pole failures are a concern for igniting fires and having a new pole or reinforced pole reduces that likelihood. BVES considered pole failure as part of its determination for its PSPS activation thresholds.

Updates to the Activity

This activity is mostly achieved in conjunction with the covered conductor program. Before covered conductor is installed, each affected pole is fully assessed and those not meeting GO-95 requirements are replaced or remediated.

Covered Conductor Project – Radford Line Sub-transmission Project (Tracking ID: GD 1 – GD 2)

Overview

This initiative intends to reduce the potential of one of the main power supply lines to Big Bear Lake from being lost, should the area suffer a wildfire or other event. Additionally, the initiative removes the likelihood BVES would need to initiate a PSPS on this circuit during extreme fire weather conditions.

BVES is replacing 70 aged wood poles on the Radford 34.5 kV line with fire resistant poles that will improve resiliency to quickly restore power to Big Bear Lake in the event the area suffers a major wildfire.

Impact of the Activity on Wildfire Risk

BVES chose to cover this line located in the HFTD Tier 3 area and replace the poles with fire resistant poles specifically because it has the highest wildfire risk of all of BVES's overhead facilities. The line is in a densely vegetated area that is difficult to patrol, due to no road access.

Impact on PSPS Risk

Replacing the poles will improve system resiliency from wildfires and reduce the likelihood that BVES would need to declare a PSPS on this line.

Evacuation Route Hardening Pilot & Program (Tracking ID:GD 6)

Overview

BVES's service area has three predetermined evacuation routes, developed by the local sheriff department and other government officials, to evacuate the public in the event of an emergency, including a wildfire. The hardening of BVES electrical assets (poles, wires, equipment) along the evacuation routes is important to ensure they do not fail during a wildfire, which would limit mobility along the evacuation routes required to safely perform the evacuation. The evacuation hardening pilot project performed in 2020 and completed in 2021 was designed to determine availability, cost effectiveness, and ability to install technology such as fire-resistant pole wrap, steel poles, concrete poles, ductile iron poles, and fire-resistant fiberglass poles. These proposed measures are intended to increase resiliency to demonstrate the ability to keep evaluation routes safe from failed BVES electrical assets during a wildfire. BVES is now focusing on secondary evacuation routes that lead to the primary routes by installing the wire wrap mesh on approximately 500 poles per year.

Impact of the Activity on Wildfire Risk

Hardening of BVES electrical assets (poles, wires, equipment) along the evacuation routes is important to ensure they do not fail during a wildfire which would limit mobility along the evacuation routes required to safely perform the evacuation. Additionally, routes must also be unencumbered to allow the movement of first responders and their equipment during a wildfire. The primary objective of this evacuation route hardening program is not to reduce the risk of ignition resulting in a wildfire. Rather, the primary objective of the program is to add resiliency and safety to evacuation routes during an evacuation due to a wildfire or other emergencies. BVES hardened the three main evacuation routes (800 poles) over two years with wire wrap program. In addition, BVES will implement the following policy that requires when wood poles are to be replaced for any reason on main evacuation routes, that they are to be replaced with fire resistant composite or other acceptable pole types (LWS or ductile iron after testing). If undergrounding opportunities arise along evacuation routes, evaluations will be performed to determine the suitability of undergrounding.

Impact of the Activity on PSPS Risk

Since the primary objective on this evacuation route hardening is to add resiliency and safety of the evacuation routes the program does not directly address the impact to PSPS risk but reduces the chances of a wildfire risk and therefore inherently provides for a reduction on the chances of declaring a PSPS.

Updates to the Activity

BVES will continue its effort across its service territory to upgrade and replace poles and already achieved hardening with a significant portion of its poles in service are under 10 years old. BVES has a goal to install wire mesh wrap on approximately 500 poles per year to harden the secondary evacuation routes that lead to the primary evacuation routes.

8.1.2.4 Transmission Pole/Tower Replacements and Reinforcements (Tracking ID: GD_7)

N/A. BVES does not own or operate any transmission assets.

8.1.2.5 Traditional Overhead Hardening (Tracking ID: GD_8)**Addition and replacement of distribution and sub-transmission components and equipment**

BVES's traditional overhead hardening initiatives consist of replacing bare conductors with insulated covered conductors on all sub-transmission lines (34.5 kV) and to replace all bare 4 kV distribution wire in high-risk areas within the service area with covered wire, as mentioned in Section 8.1.2.1. The replacement program is prioritized based on higher risk circuits to maximize the risk reduction. BVES plans to replace its 34.5 kV bare wire at a rate of 4.3 circuit miles per year and to replace 4 kV bare wire at a rate of 8.6 circuit miles per year. Additionally, poles that are not compliant with GO 95 safety factors are identified and remediated appropriately. Depending on the nature and extent of the noncompliance, the remediation will require either repair (e.g., the installation or modification of guy wires) or complete replacement of the pole, including removal and reinstallation of all attachments, all within the time frames required by GO 95. GO 95 is aimed at the safety of personnel, the public, and preserving the reliability of the power grid. Risk is significantly reduced when poles are brought into compliance with laws directed at preserving safety and reliability.

Updates to the Initiatives

BVES will apply any lessons learned throughout the progression of the program. As part of the project, BVES will install utility fiber and use this for future system monitoring efforts (via cameras, infrared sensors, system diagnostics sensors, etc.) and for fast acting switches on the circuit.

Where possible, BVES will look for synergies between initiatives such as covered wire installation and pole loading assessment, infrastructure hardening, and replacement programs to maximize the risk benefit associated with each project.

BVES participates in the joint utilities covered wire working group and will continue to exchange information regarding pole replacements associated with covered wire installation. Additionally, BVES will participate in T&D conferences and review current T&D literature and periodicals to gain the latest information on pole replacement practices.

As part of the covered conductor program, cross-arms and other pole mounted equipment are replaced when installing covered conductors.

8.1.2.6 Emerging Grid Hardening Technology Installations and Pilots (Tracking ID: GD_9)

BVES does not have any pilots planned at this time and will continue to monitor developments underway at other utilities.

8.1.2.7 Microgrids (Tracking ID: GD_10, GD_11)

Bear Valley Energy Storage Facility (GD 11)

Overview

BVES proposed the construction of an energy storage project of approximately 5 MW/20 MWh (four-hour) Lithium-Ion NMC utility-grade battery in the BVES service area. This project will complement the Bear Valley Solar Energy Project (BVSEP), 5 MW alternating current single-axis tracker solar generation facility, to be constructed on the same location as the storage facility project and directly feeding the distribution system benefiting all customers.

Impact of the Activity on Wildfire Risk

This project aims to reduce activity on PSPS risk but does not significantly reduce the potential to wildfire risk.

Impact of the Activity on PSPS Risk

One of the purposes of the storage project is to minimize the impact of the loss of all SCE energy imports to the BVES service area due to a SCE-directed PSPS of the SCE supply lines to BVES. BVES imports from SCE are subject to PSPS and while these lines may be required to be de-energized by SCE, the BVES service area may not require PSPS.

Updates to the Activity

Once built, these projects will allow BVES to internally supply energy to most of its customers by utilizing its existing peaking power plant (8.4 MW), along with the BVSEP and the energy storage battery to minimize the effects of any PSPS event.

Energy Storage/Solar Energy Project (GD 10)

Overview

BVES proposed an Energy Storage and Solar Generating Facility Project that are designed to reduce the likelihood and consequences of disruptive events, including PSPS actions, and provide many of the benefits outlined the Grid Resilience and Innovation Partnerships (GRIP) program.

Bear Valley's service area includes a wilderness environment with heavily forested treed terrain making the territory vulnerable to potential ignition risk. BVES proposes to construct an energy storage project of approximately 5 MW/20 MWh (four-hour) Lithium-Ion NMC utility-grade battery located in the BVES maintenance yard. This project will complement the Bear Valley Solar Energy Project (BVSEP), 5 MW alternating current single-axis tracker solar generation facility, to be constructed on a 21-acre site within the BVES service territory. This system will directly feed the distribution system benefiting all customers.

Impact of the Activity on Wildfire Risk

The proposed projects enhance safety, reliability, and quality of service. The projects are designed to significantly mitigate the potential of ignitions by removing the need to expand sub-transmission supply lines to Bear Valley's service area, which may cause wildfires with catastrophic loss of life and enormous loss of property.

Impact of the Activity on PSPS Risk

These projects significantly reduce the need for PSPS and the impact of Southern California Edison (SCE) initiating a PSPS event affecting the supply lines to Bear Valley. One of the objectives of the storage project is to minimize the impact of the loss of all SCE energy imports to the BVES service area due to a SCE-directed PSPS of the SCE supply lines to BVES. BVES energy imports from SCE are subject to PSPS and while these lines may be required to be de-energized by SCE, the BVES service area may not require PSPS.

Updates to the Activity

These projects will be submitted to the CPUC and the County of San Bernardino in 2023. If these proposed projects are approved, BVES will be able to internally supply energy to most of its customers by utilizing its existing peaking power plant (8.4 MW), along with the BVSEP and the energy storage battery to minimize the effects of any PSPS event.

8.1.2.8 Installation of System Automation Equipment (Tracking ID: GD_12 – GD_14 – GD_17)

Overview

Installation of System Automation Equipment

This initiative covers the various system automation programs implemented to reduce wildfire and PSPS risks. They encompass automation on the grid by installing advanced equipment, upgraded communication infrastructure and data driven upgrades that assist with the automation.

Grid Automation Program (SCADA)

Overview

BVES's current SCADA system is inadequate with few controls for the distribution system and limited monitoring capability. Through the Grid Automation Project, BVES will establish a service area network, build out its SCADA software and historian capabilities, connect/automate substations and field switches, and install circuit metering and monitoring devices such as weather stations. This initiative will also include installation of electric equipment to increase the ability to automate the system with operational controls and monitoring. To further enhance its situational monitoring, BVES outlined a number of initiatives that contribute to its information base and facilitate sharing. These initiative resources include web-based weather resources, BVES-owned weather stations, weather forecasting, and GIS-supported applications, such as its Outage Management System (OMS).

BVES plans to continue to automate its system including the installation of a fiber optic network throughout the service area, automating substations and key field switches, and adding sensors to provide critical system information. Grid automation will enhance operational efficiency, safety, reliability, and wildfire prevention by allowing remote monitoring and real-time fault detection. The fiber optic network is also an enabler for future advanced technologies that reduce wildfire ignition risk.

Impact of the Activity on Wildfire Risk

This initiative is aimed at reducing the risk of ignitions due to faults by enhancing situational awareness and control of the electric distribution system, rapidly detecting fault conditions,

localizing faults, and isolating faults from the system. With the implementation of the SCADA network as part of the Grid Automation Program, BVES will enhance its grid as well as conditional awareness into asset performance and potential incidents. This will provide the utility rapid results, instantaneous reads and communications from system enhancements, and optimize system maintenance and remediation deployments with more precision in system management.

Impact of the Activity on PSPS Risk

The enhanced situational awareness and detection of fault conditions allows for an intelligent isolation of faults reducing the risk of PSPS.

Updates to the Activity

The following list demonstrates the current assets monitored and/or controlled via BVES's SCADA system.

Asset
All Bear Valley Power Plant (BVPP) Controls
7.4 kV 4 kV Circuit Breakers for each of the BVPP generators at the BVPP
4 - 34 kV Ring Bus Circuit Breakers (# 22, 44, 66 & 88) at Meadow Substation
9 Fault Localization Isolation System Restoration 34 kV IntelliRupter Switches (Baldwin IR3430, Shay IR3440, PS3435IR, PS3454IR, PS3436IR, PS3428IR, PS3414IR, PS3415IR & PS3456IR)
Shay 34 kV Auto Recloser (IR3440)
Baldwin 34 kV Auto Recloser (IR3430)
Radford 34 kV Auto Recloser (IR3470)
Palomino Substation
Moonridge Substation
Pineknot Substation

In 2022, BVES connected three substations to the SCADA network. In 2023-2025 WMP, the Substation Automation Project will be implemented, which will connect three substations per year to the SCADA network. The following items will also be connected in 2023.

Asset
6 Capacitor Banks – 6 locations: 2 on the Boulder Circuit, 2 on the Erwin Circuit, 1 on the North Shore Circuit and 1 on the Paradise Circuit
8 - 34 kV Field Switches
4 - 4kV Field Switches at 4 tie switch locations
Trip Savers at 4 locations (Radio Study)
Fault Indicators (FI) – proposed to install 79 FI's, Radio Study will be part of the trip saver radio study. (7 locations on 34kV for SCADA connection)
All Bear Valley Power Plant (BVPP) Controls

BVES will leverage the network connectivity capabilities gained by the project to eventually deploy an array of field devices that enhance situational awareness and detect and remedy

system faults and potential ignition events. BVES will apply any lessons learned throughout the progression of the program.

Substation Automation Project (GD 12)

Overview

The project aims to connect nine substations, three per year in 2023-2025, to Bear Valley's SCADA network to allow remote real-time monitoring, reporting, and documenting key substation parameters over three years. The project involves the following elements: installing SCADA enabled control equipment, enhancing telemetry, and creating the capability to collect and modify settings remotely. This project will establish a robust and secure IP communications network across the distribution system to fully enable monitoring and control of critical equipment at the substations throughout the distribution system. Critical switches at substations will be automated and connected to SCADA in a phased approach. Connectivity to SCADA will be via the BVES service area fiber optic network. Additionally, sensors will be placed throughout the substations to continuously monitor volt-ampere reactive (VAR) performance and power quality. Bear Valley connected the Palomino, Moonridge, and Pineknoll Substations to SCADA by the end of 2022.

Impact of the Activity on Wildfire Risk

System will monitor, report via alarms, and document key parameters that may indicate impending catastrophic equipment failures that may cause ignitions leading to wildfires and/or large oil spills that may damage the environment allowing Bear Valley allowing immediate action to be taken by Bear Valley crews and first responders. Additionally, this project will allow Bear Valley to remotely and rapidly de-energize a circuit when the circuit is determined to be at high risk of causing an ignition which may result in a wildfire and rapidly assess the boundaries of potential faults that caused the outage, allowing fault location precision that crews can act on. Rapid fault localization may reduce the risk of ignitions resulting from wildfires and clearly has an impact on reducing time to restore from outages. Finally, the project provides risk reduction regarding downed wires and sustained outages.

Impact of the Activity on PSPS Risk

This project would allow for quick and efficient remote switching operations at the circuit level minimizing the impact to customers significantly reducing outage time for customers by enabling quick restoration of unaffected portions of the distribution system when the fault is localized during faulted, storm, and/or other disaster conditions. Additionally, the project will incorporate available and future distributed generation sources within grid resilience planning and improve response to outages through input on substation device status into the Outage Management System (OMS).

Updates to the Activity

In 2023, Bear Valley plans to connect and automate Village, Meadow, and Bear Mountain substations. Bear City, Division, and Fawnskin are planned for upgrades in 2024, and Maltby, Maple, and Lake substations are planned for connection and automation in 2025. The Snow Summit substation will be upgraded through an Added Facilities agreement with Snow Summit in either 2023 or 2024. This means that all of BVES's substations will be connected to SCADA and fully automated by 2025.

Fault Isolation Localization and Service Restoration (FLISR) (GD 13)

Overview

The Fault Localization Isolation and System Restoration (FLISR) installs nine smart high voltage switches and integrates three existing auto-reclosers and one auto-transfer switch on the 34.5 kV system. The system leverages the network installed by the Grid Automation Project to rapidly detect and isolate faults and restore unaffected portions of the system to the maximum extent possible utilizing unaffected power sources and circuit routes. Additionally, the system provides improved information on where to dispatch line crews responding to fault and outage conditions; thereby, reducing the time to detect and remedy potentially dangerous conditions.

Impact of the Activity on Wildfire Risk

The wildfire risk is reduced by BVES's ability to quickly isolate detected faults.

Impact of the Activity on PSPS Risk

This program would also allow for additional sectionalization to minimize the impact of PSPS events.

Updates to the Activity

The FLISR system was completed in 2022 and is fully operational. BVES will look to expanding FLISR capability into the 4 kV distribution system where it is possible due to circuit configurations.

Fuse TripSavers Automation (GD 15)

Overview

This initiative is aimed at reducing the risk of ignitions due to conventional fuses and to increase situational awareness of the electric distribution system, rapidly detecting fault conditions, and restoring the fuses remotely through the SCADA system. The Fuse TripSavers Automation is scheduled to connect and automate 160 Fuse TripSavers to the SCADA network over a four-year period. BVES finished replacing all conventional fuses to current limiting and electronic fuses in 2021. However, in order to fully optimize surveillance of the system, BVES plans to automate the fuses by integrating the devices with the SCADA network.

Impact of the Activity on Wildfire Risk

The reduction of conventional fuses that tend to spark by replacing them with electronic fuses greatly reduces the risk of wildfires. By automating the Fuse TripSavers BVES will be able to switch the devices rapidly and remotely to "manual" to prevent them from testing following a fault detection (over current) on "dry" and "very dry" days.

Impact of the Activity on PSPS Risk

By integrating the newly installed electronic fuses with the SCADA network, using a fault condition detection, the system can intelligently restore the fuses as soon as possible reducing the risk of PSPS.

Updates to the Activity

The project is planned for 2023 and will be completed in 2026.

Server Upgrade Project (GD 16)

Overview

This initiative supports the SCADA network configuration by providing enough physical space and controls to allow for flexibility, reliability, and security in operating the automated SCADA network. This will enable the integration of remote devices that will allow BVES to detect and react to faults, outages, and potential fire risk across its system. This upgrade project is a necessary component to upgrading the SCADA network. The Server Upgrade Project converts space at BVES into a fully compliant server room with security and environmental controls, backup power, server racks and conduit, and server equipment to fully support BVES's SCADA network.

Impact of the Activity on Wildfire Risk

The project upgrade allows for the integration of more intelligent remote devices that will assist in the monitoring and remote control of devices which will reduce wildfire risks.

Impact of the Activity on PSPS Risk

Same as with the reduction of wildfire risks the expansion on the SCADA network will help expand the automation devices that reduce the risk of PSPS.

Updates to the Activity

The project is planned for 2023

Distribution Management Center Program (GD 17)

Overview

This initiative supports the SCADA network configuration, which aims to construct a fully equipped distribution management center to permit monitoring and control of the sub-transmission and distribution electrical assets, monitor and operate the OMS, update interactive voice response (IVR) and company website and social media, and provide for dispatch of repair crews. BVES plans to install a Distribution Management Control Center (DMCC) with the following equipment and applications that would provide substantially greater information capabilities to distribution decision makers relevant to the following functional areas: (1) Energy Resources; (2) T&D Assets; (3) SCADA, Outage Management System, GIS & Other Applications; (4) Weather Information; (5) HD Cameras; (6) Media Access (Internet, BVES Website & Social Media, Local Radio, TV, etc.); (7) Communications Equipment; and (8) Dispatch Services.

Impact of the Activity on Wildfire Risk

A fully integrated control management system is integral to maintaining optimal awareness into the system as well as management of communication methods internally and externally, and remote control of switching and fuse devices. This will assist with providing BVES monitor real-time data improve control and reduce wildfire risk.

Impact of the Activity on PSPS Risk

Similar to the reduction of wildfire risks, the expansion on this project will help expand the situational awareness of the system and remote control and operation thereby reducing the risk of PSPS.

Updates to the Activity

The conceptual planning for such a facility is scheduled to start in 2024. A detailed design plan will be developed in 2023 with the facility anticipated to be constructed in 2024 to coincide with the SCADA and Grid Automation efforts being completed as the DMCC facility comes online.

8.1.2.9 Line Removal in HFTD (Tracking ID: GD_18)

N/A. BVES does not have a line removal program or plans to remove lines currently. A program will be established if line removal is needed in the future.

8.1.2.10 Other Grid Topology Improvements to Minimize Risk of Ignitions (Tracking ID: GD_19)

Tree Attachment Removal Program

Overview

This Tree Attachment Removal Program initiative captures the work to remove legacy service attachments and wires that are affixed to trees, replacing with structures and poles that are more fire resistant. Tree attachments are pieces of electrical infrastructure fastened to trees instead of poles for infrastructure support. Although this infrastructure approach initially reduces costs, it inherently introduces ignition risk by holding energized wires in direct proximity to vegetation.

Impact of the Activity on Wildfire Risk

For some time now, the practice of installing distribution and service lines using tree attachments has been prohibited for new installations. Given that BVES's service area is entirely located in HFTD Tiers 2 and 3, tree attachments have been recognized as high-risk circumstances, BVES has planned to remove all tree attachments by the end of 2026. Elimination of tree attachments will enhance the safety and reliability of the distribution system and reduce the risk of wildfires.

Impact of the Activity on PSPS Risk

This activity is not expected to impact PSPS Risk.

Updates to the Activity

BVES had approximately 1,207 legacy tree attachment service connections in its service area (2019 inventory count), mostly located in USFS controlled areas. As of December 31, 2021, BVES has removed 644 tree attachments and installed 223 new poles. BVES estimates that the remaining 563 tree attachments will be removed by the end of 2026. BVES is executing this initiative across the entire distribution system prioritized based on risk and accessibility (permitting). BVES plans to remove approximately 100 tree attachments per year.

8.1.2.11 Other Grid Topology Improvements to Mitigate or Reduce PSPS Events (Tracking ID: GD_20)

Switch and Field Device Automation Project. (GD 14)

Overview

This project aims to automate and connect to Bear Valley's SCADA network 28 sub-transmission (34 kV) switches and 20 distribution switches over four years (2023 to 2026) in order to allow remote real-time monitoring, reporting, and documenting key switch parameters and enable remote operation of the switches. The project involves the following elements: installing SCADA enabled control equipment, enhancing telemetry, and creating the capability to collect and modify settings remotely. This project will establish a robust and secure IP communications network across the sub-transmission and distribution systems to fully enable monitoring and control of critical switches throughout the sub-transmission and distribution systems. Critical switches in the system will be automated and connected to SCADA in a phased approach. Connectivity to SCADA will be via the BVES service area fiber optic network and in some cases via radio/cellular data transfer equipment. As indicated in the table below, 32 switches will be replaced with automated SCADA enabled switches, 13 switches will be motorized (motor operator installed to existing switch) and SCADA enabled, and one new switch will be added to the sub-transmission system to allow isolation of the Moonridge and Bear Mountain substations from the sub-transmission system for maintenance and fault isolation purposes. Automated switches would have battery backup power to permit remote connectivity and operation on a complete loss of power.

Impact of the Activity on Wildfire Risk

The system will monitor, report, and document key parameters on field switches that may indicate impending catastrophic equipment failures that may cause ignitions leading to wildfires allowing Bear Valley to evaluate the situation, to develop and plan appropriate technical solutions, and then take the directed corrective action. The project will allow BVES to monitor, report via alarms, and document key parameters on field switches that indicate a catastrophic equipment failure or fault has occurred that may cause ignitions leading to wildfires and allow immediate action to be taken by Bear Valley crews and First Responders. It will also allow Bear Valley to remotely and rapidly de-energize sections of circuits when the circuit is determined to be at high risk of causing an ignition, which may result in a wildfire, thereby removing risk while minimizing impact to unaffected portions of the circuit and customers served.

Impact of the Activity on PSPS Risk

If Bear Valley were to lose some or all of its power supplies from SCE due to a SCE-directed PSPS, wildfires or other disasters affecting SCE power lines, or for other reasons, Bear Valley would have to implement a rolling blackout strategy since the Bear Valley Power Plant is not capable of supporting all loads. Currently, executing switching operations associated with a rolling blackout is very labor intensive and cumbersome due to manual switching. This project would allow for quick and efficient remote switching operations at the circuit level minimizing the impact to customers. It should be noted that during the Holcomb Fire in June 2017 Bear Valley had to implement a rolling blackout strategy for several days when SCE's supply power lines to Bear Valley were damaged and de-energized due to the wildfire.

This effort will also support actions taken to mitigate or reduce PSPS events in terms of geographic scope and number of customers affected, such as installation and operation of electrical equipment to sectionalize or island portions of the grid or local generation.

Updates to the Activity

BVES has completed prior assessments of device needs and concluded this activity in 2019. In 2023, BVES will implement a new project to install additional switching devices for supply transfer ability to mitigate load loss or PSPS event impact.

BVPP Phase 4 Upgrade Project (GD 21)

Overview

This program is aimed at reducing the impacts of power outages from proactive de-energization and preserving essential services by improving the reliability of the Bear Valley Power Plant (BVPP). The Phase Three (2022) upgrades will include installing new catalyst housing directly above the engine. New placement will reduce heat loss and improve emissions bandwidths. The catalyst housing will include the double stacked element system to provide additional assistance in meeting emissions requirements. It also relocates oil and water piping, battery boxes, and controller stands while increasing accessibility and safety. The project will also address several age-related issues and align each generator to limit vibrations and abnormal wear on the engine.

Phase Four activities (2023) will include installing updated engine controls on all engines to a current controls system that will allow efficient start/stop functions, consolidated controls, and synchronization monitoring. Also, the plan is to replace the Detonation Sensing Module (DSM) Controls on all engines with a detcon system that will allow for visual DSM monitoring and repair any faulty wiring. Lastly, the project is scheduled to replace the governor speed control systems on all engines with a ProAct system and EX Gen control.

Impact of the Activity on Wildfire Risk

This activity will not impact wildfire risk.

Impact of the Activity on PSPS Risk

Implementing this project as described in this section would result in significantly reducing the risk to Bear Valley's customers having to endure extended outages due to a loss of energy supplies as a result of SCE invoking a PSPS event on power lines that supply Bear Valley. Generally, during Santa Ana winds, which is when it is likely that SCE would invoke a PSPS event, the temperatures in Bear Valley often drop below freezing at night which leave customers without heat. This is potentially dangerous to elderly, AFN, and other vulnerable customers; therefore, this project aims to reduce public risk.

Updates to the Activity

BVES has outlined the four (2023) activities planned for this initiative in the above section. BVES will consider any future upgrades when these phases are completed.

8.1.2.12 Other Technologies and Systems Not Listed Above (Tracking ID: GD_22 - GD_24)

Safety and Technical Upgrades to Substations

Overview

This initiative covers the Safety and Technical Upgrades to Substations and the Tree Attachment Removal Program.

This initiative category accounts for the incremental repair, maintenance, and replacement work associated with substations to function safely, reliably, and properly to reduce increased ignition risk. BVES recently converted the existing Palomino Substation from an overhead-type to a pad-mounted design with dead-front SCADA enabled. This will improve the safety, reliability, and efficiency of the substation by eliminating a wiring configuration that poses a safety and fire risk due to its exposure to the elements, such as vegetation contact. Additionally, BVES has replaced all substation equipment with enclosed pad-mounted transformers, voltage regulators, reclosers, and bus work, further enhancing wildfire mitigation and reliability.

Impact of the Activity on Wildfire Risk

The existing Palomino Substation had an overhead, open bus type design. Because of this design, vegetation (leaves, branches, trees, etc.) could contact the energized bus and could cause an ignition potentially leading to a wildfire or extensive power outage. The new substation design uses a pad-mount dead-front design with no exposed energized conductors or equipment. The new “no-possible-contact” design reduces the ignition risk to near zero, essentially the maximum reduction possible when compared to an open bus design combined with vegetation management. This work is performed in Tier 2 as there are no substations in Tier 3. BVES will prioritize this effort based on need and relative risk.

Impact of the Activity on PSPS Risk

This project does not substantially impact PSPS risk.

Updates to the Activity

BVES plans, in 2025, to perform partial safety and technical upgrades to the Maltby, Moonridge, and Lake Substations. This will include replacing overhead regulators with pad-mounted regulators, installing pad-mounted IntelliRupter switches, which will convert the substation to be fully underground, and lastly, updates to substation controls. BVES will also continue to exchange information with other utilities on the available substation upgrades and their cost versus risk benefits.

8.1.3 Asset Inspections

In this section, the electrical corporation must provide an overview of its processes and procedures for inspecting its assets.

The electrical corporation must first summarize details regarding the inspection process in Table 8-6. The table must include the following:

- **Type of inspection** – i.e., distribution, transmission, or substation
- **Inspection program name** – Identify various inspection programs within the electrical corporation
- **Frequency or trigger** – Identify the frequency or triggers, such as inputs from the risk model. Indicate differences in frequency or trigger by HTFD Tier, if applicable
- **Method of inspection** – Identify the methods used to perform the inspection (e.g., patrol, detailed, aerial, climbing, and LiDAR)
- **Governing standards and operating procedures** – Identify the regulatory requirements and the electrical corporation’s procedures/processes

Table 8-6 Asset Management Inspection Frequency, Method, and Criteria

Type	Inspection Program	Frequency or Trigger (Note 1)	Method of Inspection (Note 2)	Governing Standards & Operating Procedures	Section
Transmission	N/A	N/A	N/A	N/A	N/A
Distribution	Detailed Inspection	5 Years	Ground inspection	GO 165 & GO 95 (Rule 18)	8.1.3.1
Distribution	Patrol Inspection	Annual	Ground inspection	GO 165 & GO 95 (Rule 18)	8.1.3.2
Distribution	UAV Thermography Inspection	Annual	Aerial inspection	GO 95 (Rule 18)	8.1.3.3
Distribution	UAV HD Photography/Videography	Annual	Aerial inspection	GO 165	8.1.3.4
Distribution	LiDAR Inspection	Annual	Ground and Aerial inspection	GO 95 (Rule 18)	8.1.3.5
Distribution	3 rd Party Ground Patrol	Annual	Ground inspection	GO 165 & GO 95	8.1.3.6
Distribution	Intrusive Pole Inspection	Per GO 165	Ground inspection	GO 165	8.1.3.7
Substation	Substation Inspection	Monthly	Ground inspection	GO 174	8.1.3.8

Note 1: The electrical corporation must provide electrical corporation-specific risk-informed triggers used for asset inspections.

Note 2: The electrical corporation must provide electrical corporation-specific definitions of the different methods of inspection.

The electrical corporation must then provide a narrative overview of each vegetation inspection program identified in the above table; Sections 8.2.2.1. provides instructions for the overviews. The sections should be numbered 8.1.3.1 to Section 8.1.3.n (i.e., each vegetation inspection program is detailed in its own section). The electrical corporation must include inspection programs it is discontinuing or has discontinued since the last WMP submission; in these cases the electrical corporation must explain why the program is being discontinued or has been discontinued.

8.1.3.1 Detailed Inspection Program (Tracking ID: GD_25 - VM_1)

In this section, the electrical corporation must provide an overview of the individual asset inspection program, including inspection criteria and the various inspection methods used for each inspection program.

Include relevant visuals and graphics depicting the workflow and decision-making process the electrical corporation uses for the inspection program (see the example in Figure 8-1).

Process

A “detailed inspection” is a more careful visual and diagnostic exam of individual pieces of equipment. BVES’s Field Inspector performs the Detailed Inspections. The Field Inspector is required to be a Journeyman Lineman experienced in inspection of electric transmission and distribution facilities and power lines. The inspector records the results of the diagnostic and visual examinations and rates the condition of the equipment. These inspections are designed to identify any existing, including minor, defects. These may include, but are not limited to, open wire secondary clearance, corona effect on cross-arms, warning signage issues, visibility strips and pole-tag issues, and rotten poles. If any defects are identified, BVES prioritizes the defect resolution based on risk and resolves the issues in compliance with GO 95 Rule 18 timeframes.

All inspection findings (detailed, patrol, UAV, etc.) are rated in accordance with GO 95 Rule 18 (level 1, 2, or 3) and entered into the distribution inspection GIS database. Level 1 findings are reported immediately to the Field Operations Supervisor who will direct corrective action as soon as possible to resolve the issue or reduce its severity to Level 2 so that more time is available to perform permanent corrective action.

The Wildfire Mitigation and Reliability Engineer reviews the results of all inspections and assigns corrective action to Field Operations. Additionally, the Wildfire Mitigation and Reliability Engineer reviews the results of Detailed Inspections as well as other asset inspections to determine if there are systemic issues that must be addressed. Finally, the results of Detailed Inspections are validated against other asset inspections to evaluate the quality and effectiveness of each inspection type.

Frequency or Trigger

In this section, the electrical corporation must identify the frequency (including how frequency may differ by HFTD Tier or other risk designation[s]) or triggers used in the inspection program, such as inputs from the risk model.

If the inspection program is schedule based, the electrical corporation must explain how it uses risk prioritization in the scheduling of the inspection program to target high-risk areas. If the electrical corporation does not use risk prioritization in the scheduling of the inspection program, it must explain why.

BVES conducts these inspections at least once every five years in compliance with GO 165 and GO 95 (Rule 18). BVES divides its system up and conducts detailed inspections on every circuit is inspected at least every five years.

8.1.3.2 Patrol Inspection Program (Tracking ID: GD_26 - VM_2)

Process

In compliance with GO 165, BVES's Inspection Program requires a patrol inspection of all overhead facilities each year. A "patrol inspection" is a visual inspection designed to identify obvious problems, gross defects, and hazards. Gross defects may include, but are not limited to, cracked cross-arms, poles leaning beyond specification, guy wires missing or damaged, vegetation encroachment inside of minimum clearance standards, etc. These encroachments have the potential to spark and possibly ignite a wildfire. Patrol inspections are a critical element in mitigating the risk of wildfire caused by electric utility facilities. BVES's Field Inspector performs the patrol inspections. The Field Inspector is required to be a Journeyman Lineman experienced in inspection of electric transmission and distribution facilities and power lines.

Frequency

Patrol inspections are conducted annually and cover the entirety of BVES's overhead facilities. Because all of BVES's service territory is in HFTD Tier 2 or Tier 3, risk prioritization scheduling is not used in assigning the patrol inspections.

8.1.3.3 UAV Thermography (Tracking ID: GD_27)

Process

The UAV thermographic survey provides quick and meaningful inspection results other inspection methods are not able to provide. The ability to identify "hot spots" is unique to this inspection technology. Generally, thermographic hot spots are indicative of potential equipment degradation or failure.

When BVES receives the thermography survey report, each finding is investigated by qualified personnel in evaluating asset conditions to validate the identified conditions and reassign the priority per GO 95, if deemed appropriate. The thermography contractor will immediately inform BVES of any level 1 findings so that they may be corrected or resolved to a level 2 or 3 finding as soon as possible.

The Wildfire Mitigation and Reliability Engineer reviews the results of thermography surveys and assigns corrective action to the line crews. Additionally, the Wildfire Mitigation and Reliability Engineer reviews the result of thermography surveys as well as other vegetation inspections to determine if there are systemic issues that must be addressed. Finally, the results of thermography surveys are cross checked against other asset inspections to evaluate the quality and effectiveness of each inspection type.

Frequency

UAV thermography inspections are conducted annually and cover the entirety of BVES's overhead facilities. BVES's entire service territory is in HFTD Tier 2 or Tier 3 and is very compact and done over a short period of time, therefore risk prioritization scheduling is not used in assigning these inspections.

8.1.3.4 UAV HD Photography/Videography (Tracking ID: GD_28 – VM_3)

Process

BVES will contract UAV fly-over inspections of its sub-transmission and distribution system. This inspection complements the Ground Patrols and detailed inspections of GO 165 and LiDAR

inspections. Many electric utilities including major California electric utilities have found inspections utilizing UAVs are highly effective at identifying facilities degradations and issues that Ground Patrols and detailed inspections would not necessarily reveal. The UAVs film the facilities using high-definition video photography while maintaining an accurate date/time and geolocation stamp on the recorded video stream. The video recordings are then reviewed by qualified analysts who can slow down the recording so as to note any issues. When a potential issue is identified, they can freeze the video and perform further analysis such as zooming in on the item in question. Discrepancies are then identified, evaluated, recorded, and remediation or further investigation is assigned.

The UAVs used for this inspection will also collect infrared thermography data for analysis. This technology includes heat-sensing cameras that can identify risk drivers such as increased “hot” areas or conditions that may indicate deterioration, which can lead to potential failures and ignitions.

The Wildfire Mitigation and Reliability Engineer reviews the results of the UAV Imagery surveys and assigns corrective action to the line crews. Findings are handled in the same manner as described above. Additionally, the Wildfire Mitigation and Reliability Engineer reviews the results of the UAV Imagery surveys as well as other asset inspections to determine if there are systemic issues that must be addressed. Finally, the results of the UAV Imagery surveys are cross checked against other asset inspections to evaluate the quality and effectiveness of each inspection type.

Frequency

UAV HD Photography/videography inspections are conducted annually and cover the entirety of BVES’s overhead facilities. All of BVES’s service territory is in HFTD Tier 2 or Tier 3 and is very compact and done over a short period of time, therefore risk prioritization scheduling is not used in assigning these inspections.

8.1.3.5 LiDAR Inspection (Tracking ID: GD_29 – VM_4)

Process

BVES conducts one LiDAR sweep of its entire service area per year to evaluate the effectiveness of clearance efforts and identify potential wildfire hazards. This is an enhanced inspection using LiDAR (Light Detection and Ranging) inspections and analysis, which uses a system of lasers and software to develop surveys of the overhead sub-transmission and distribution systems, to accurately determine vegetation clearances to conductors. BVES began using LiDAR through a pilot project initiative using both helicopter and fixed wing flights, as well as via a truck-mounted mobile system. Given the proximity of the majority of BVES’s electrical system to the road network and the tree canopy that is typical of distribution systems, truck-mounted mobile LiDAR is utilized more often because it is more effective.

LiDAR survey findings are rated in accordance with GO 95 Rule 18 (level 1, 2, or 3) and entered into the distribution inspection GIS database and handled in the same manner as described above. When BVES receives the LiDAR survey report, each finding is investigated by qualified personnel in evaluating asset conditions to validate the actual conditions and reassign the priority per GO 95, if deemed appropriate. The LiDAR contractor immediately informs BVES of any level 1 findings so that they may be corrected or resolved to a level 2 or 3 finding as soon

as possible. Finally, the results of LiDAR surveys are validated against other asset inspections to evaluate the quality and effectiveness of each inspection type.

Frequency

LiDAR inspections are conducted annually and cover the entirety of BVES's overhead facilities. All of BVES's service territory is in HFTD Tier 2 or Tier 3 and is very compact and done over a short period of time, therefore risk prioritization scheduling is not used in assigning these inspections.

8.1.3.6 3rd Party Ground Patrol (Tracking ID: GD_30 – VM_5)

Process

This inspection conducted by a contracted 3rd party satisfies GO 165 patrol inspection requirements and is in effect an additional annual GO 165 patrol inspection to the one that the BVES's Field Inspector performs. BVES contracts experienced and qualified electrical distribution asset inspection contractors to perform this ground patrol inspection.

BVES believes this additional patrol is warranted due to the local climate; likelihood of icing conditions; tree limbs and branches subject to weakening due to repeated high winds, snow, and ice weight (which may cause fatigue failure); high elevation; other local conditions; difficulty accessing vegetation for trimming near bare conductors; species growth rates and characteristics; and the fact that the service area is designated "very dry" or "dry" approximately 80 percent of the time in the NFDRS. This environment, coupled with the fact that the fire season is now year-round, creates a high-risk condition that can be mitigated by increasing patrols. Substandard conditions detected on the second ground patrol are addressed in the same manner as the first patrol in compliance with GO 95 and 165.

3rd Party Ground Patrol Inspection findings are rated and handled in the same manner as BVES's inspection findings accordance with GO 95 Rule 18 (level 1, 2, or 3) and entered into the distribution inspection GIS data base. Level 1 findings are reported immediately to the Field Operations Supervisor who will direct corrective action as soon as possible to resolve the issue or reduce its severity to Level 2 so that more time is available to perform permanent corrective action.

Frequency

The 3rd Party Ground Patrol inspections are conducted annually and cover the entirety of BVES's overhead facilities. Because all of BVES's service territory is in HFTD Tier 2 or Tier 3, risk prioritization scheduling is not used in assigning these inspections.

8.1.3.7 Intrusive Pole Inspection (Tracking ID: GD_31)

Process

In accordance with GO 165, this initiative monitors the age and structural integrity of existing wood poles through means of a more detailed assessment of the pole's condition such as coring areas of identified damage and visual inspection of the poles apart from pole loading assessments results. Intrusive inspections involve movement of soil, taking samples for

analysis, and using more sophisticated diagnostic tools beyond visual inspections of instrument reading.

Frequency

BVES conducts Intrusive Pole Inspection on a cycle that maintains compliance with GO 165 based off of the type of pole as well as if/when an intrusive inspection was previously conducted. Wood poles over 15 years which have not been subject to intrusive inspection are due for inspection in 10 years. Wood poles which previously passed intrusive inspection are due every 20 years. When the inspection determines the pole no longer has the required strength, the pole is scheduled for replacement. This program determines the health of existing poles. BVES routinely intrusively inspects poles as part of its Pole Loading and Assessment program and performs directed intrusive inspections as needed. Because all of

BVES's service territory is in HFTD Tier 2 or Tier 3, risk prioritization scheduling by area is not used in assigning these inspections. BVES schedules these inspections based up on the age of the poles and the order of the review cycles, in addition to other efforts such as pole loading assessments or pole replacement projects which are prioritized by risk.

8.1.3.8 Substation Inspection (Tracking ID: GD_32 – VM_6)

Process

Substation transformer and other equipment inspections are mandated by the CPUC through GO 174 facilities inspections. Substation inspections provide both reliability and incidental wildfire mitigation benefits. Substation inspections mitigate the risk of equipment failures which have the potential to cause wildfire ignitions. The inspections also provide benefits when a substation is in the HFTD or wildland-urban interface. Gas in oil analysis is performed every year. If gas is detected in the oil, a cause analysis is performed to determine if the transformer can be repaired or requires replacement. Other inspections such as oil levels, temperature, and contamination are also performed. These inspections will determine when a transformer is nearing its end of life so it can be scheduled for replacement.

Protective relays are used extensively across the power system to remove any element from service that suffers a short circuit, starts to operate abnormally, or poses a risk to the operation of the system. It is essential to inspect and test substation protective relays at chosen intervals. The frequency of maintenance inspections and tests depends on the quality of the equipment, importance of the supply, and upon the conditions at the site where the relays are installed. Protective substation relays are inspected, tested, and calibrated on a periodic basis to assure proper operation.

Frequency

Substation Inspection – BVES conducts Substation Inspections for all 13 substations on a month basis in compliance with GO 174. Presently, the periodic inspection for relays is every four years. If proper operation cannot be assured, for instance due to obsolescence, the relay is scheduled for replacement.

8.1.3.9 Inspection Accomplishments, Roadblocks, and Updates (Tracking ID: GD_28 – VM_3)

BVES has established robust asset inspection routines that go beyond GO-165 requirements and include state-of-the-art inspection techniques that include LiDAR surveys, UAV HD Photography & Thermography, and 3rd party Ground Patrols. Bear Valley has also upgraded its data governance, including geographic locational data, for its assets, inspections, findings, and corrections.

8.1.4 Equipment Maintenance and Repair

In this section, in addition to the information described above regarding distribution, transmission, and substation inspections, the electrical corporation must provide a brief narrative of maintenance programs. As a narrative, the electrical corporation must include its strategy for maintenance, such as whether the electrical corporation replaces or upgrades facilities/equipment proactively (for example, an electrical corporation may monitor dissolved gases in its transformers to detect potential transformer failures to alert engineering and maintenance personnel or component lifecycle management) or if it runs its facilities/equipment to failure. The narrative must include, at minimum, the following types of equipment:

- *Capacitors*
- *Circuit breakers*
- *Connectors, including hotline clamps*
- *Conductor, including covered conductor*
- *Fuses, including expulsion fuses*
- *Distribution poles*
- *Lightning arrestors*
- *Reclosers*
- *Splices*
- *Transmission poles/towers*
- *Transformers*
- *Other equipment not listed*

8.1.4.1 Capacitors (Tracking ID: GD_8 – GD_14)

A detailed inspection is performed on the 24 capacitor banks each year. The inspection for 2022 was completed in July 2022. This is part of ongoing electrical maintenance and prevention activities intended to provide a plan for any remediation, adjustments, or installations of new equipment to improve or replace existing capacitors and reduce the likelihood of faults or failures that may result in ignitions. BVES does not run its capacitors to failure.

Capacitor banks are also inspected at the following times:

- During system detailed inspections every five years per GO 165 system patrol

- Patrol inspections - BVES performs two full patrols of its system per year (exceeding the GO 165 requirement)
- UAV thermography and HD photography/videography (exceeding the GO 165 requirement)
- Anytime a capacitor bank is placed in service or removed from service basic inspection maintenance is performed in accordance with BVES's Capacitor Operation Maintenance Policy and Procedures.

BVES plans to replace six capacitor banks per year beginning in 2023. The project aims to replace 24 capacitor banks from 2023 – 2026. The new capacitor banks will replace significantly aging (>40 years old) manually operated capacitor banks. The existing capacitor banks are beginning to show signs of possible future failure, which in the worst case could result in explosion of the capacitor and the potential for ignition.

The new capacitor banks will be 450kVAR 3-phase units connected to the SCADA system for remote operation, control and monitoring of performance. In addition, the project will study the locations that will result in optimized voltage support and control. Connectivity to SCADA will be via radio/cellular data transfer equipment and the BVES service area fiber optic network. This will allow BVES to control voltage by placing or removing the capacitor banks from service, as needed, without sending a crew to manually operate the capacitor banks. Additionally, the capacitor banks will be continuously monitored to prevent overheating or excessive voltage which may lead to catastrophic failure.

BVES Table 8-1 Capacitor Replacement List

Year	Element Name	Type	Phasing	Upline Source	Upline Feeder	Address	Status
2023	C12525BV	Capacitor	ABC	Village	Boulder Breaker	39649 Big Bear Blvd, Big Bear Lake, CA 92333	ONLINE
2023	C11207BV	Capacitor	ABC	Village	Boulder Circuit	South of, 40074 Big Bear Blvd, Big Bear Lake, CA 92315	OFFLINE, DAMAGED
2023	C7027BV	Capacitor	ABC	Maltby	Erwin Lake Circuit	1048 Willow Ln, Big Bear, CA 92314	ONLINE
2023	C6116BV	Capacitor	ABC	Maltby	Erwin Lake Circuit	866 Lakewood Dr, Big Bear, CA 92314	OFFLINE
2023	C3216BV	Capacitor	ABC	Fawnskin	North Shore Circuit	39222 N Shore Dr, Big Bear, CA 92314	ONLINE
2023	C10014BV	Capacitor	ABC	Maltby	Paradise Circuit	116 W Sherwood Blvd, Big Bear, CA 92314	OFFLINE

8.1.4.2 Circuit Breakers (Tracking ID: GD_8 – GD_23)

BVES routinely maintains and repairs its circuit breakers to prevent ignition risk and aid in future fault detection deployments. Specifically, this activity addresses the remediation, adjustments,

or installations of new equipment to improve or replace existing fast switching circuit breaker equipment to improve the ability to protect electrical circuits from damage caused by overload of electricity or short circuit.

Circuit breaker inspections at substations are mandated by the CPUC through GO 174 facilities inspections. Circuit breakers are used for high voltage switching and to isolate faults in a timely manner before the faults can cascade into a complete system outage. Circuit breakers in a substation protect the power grid from events such as a surge in voltage due to a lightning strike. Circuit breakers are generally inspected and maintained periodically every four years. BVES policy does not allow its circuit breakers to run to failure. Depending on the type of breaker, these inspection and maintenance tests include oil analysis, vacuum/gas checks, speed analysis, or other industry analysis standards.

8.1.4.3 Connectors, Including Hotline Clamps (Tracking ID: GD_33)

BVES routinely maintains these electrical assets to prevent ignition risk through operations and maintenance practices. This activity addresses the remediation, adjustments, or installation of new equipment to improve or replace existing connectors, including hotline clamps. This maintenance of equipment aims to improve the ability to protect electrical circuits from damage or ignition caused by overload of electricity or short circuit.

BVES does not have any hotline clamps on its sub-transmission system (34 kV) and does not have any hotline clamps in the HFTD Tier 3. Maintenance is achieved through the following inspections:

- Detailed asset inspections
- Patrol asset inspection
- LiDAR asset inspection
- UAV Thermography asset inspection
- UAV Photography/Videography asset inspection
- 3rd Party Ground Patrol asset inspection

Hotline clamps are rarely found in the BVES system. Because distribution voltage is 4 kV; generally, hotline clamping is not necessary.

In the last five years, BVES replaced approximately six hotline clamps due to the limited number in its system and its efforts to not introduce any new additional hotlines as stated above. Currently, it is BVES's policy that when a hotline clamp is found, to note and report any hotline clamp locations to the Field Operations Supervisor and Engineering staff for tracking in GIS system. Upon identification, the hotline clamp is identified for removal as soon as feasible. Once removed from the system, GIS is updated to reflect its removal.

8.1.4.4 Conductor, Including Covered Conductor (Tracking ID: GD_1 – GD_2)

BVES will maintain its conductors, including covered conductors as described below and has established a separate initiative for maintenance activities. Conductors are inspected as follows:

- Detailed asset inspections
- Patrol asset inspection
- LiDAR asset inspection
- UAV Thermography asset inspection
- UAV Photography/Videography asset inspection

- 3rd Party Ground Patrol asset inspection

Covered conductor issues identified in the inspections are documented and corrected in accordance with GO 95 Rule 18 prioritization.

Regarding covered conductors, BVES will maintain the installed covered conductor in accordance with prescribed maintenance standards and industry best practices. This includes remediation and adjustments to installed covered or insulated conductors. This will reduce the chance of degradation to the covered wire and potential for ignition sources to develop.

BVES participates in the joint utilities workshop on covered wire and will continue to exchange information in this area with other utilities. BVES will attend T&D conferences and review T&D literature and periodicals on the latest in covered wire operations and maintenance.

8.1.4.5 Fuses, Including Expulsion Fuses (Tracking ID: GD_15)

As of December 31, 2021, BVES replaced all of its conventional fuses by installing current limiting fuses (ELF) and electronic programmable fuses (S&C TripSavers) system wide. The current limiting fuses and electronic fuses expel no materials, limit the available fault current, and may even reduce the duration of faults. Beginning in 2022, BVES shifted its fuse replacement program from a system hardening type initiative to a normal operations and maintenance initiative, with the focus of maintaining the updated fuses in the system. BVES will continue to replace blown or faulty fuses with the ELF type fuses or electric fuses as applicable. BVES will also perform maintenance on Fuse TripSavers to manufacturer's specifications.

Fuses are inspected as follows:

- Detailed asset inspections
- Patrol asset inspection
- UAV Thermography asset inspection
- UAV Photography/Videography asset inspection
- 3rd Party Ground Patrol asset inspection

Fuse issues identified in the inspections are documented and corrected in accordance with GO 95 Rule 18 prioritization.

8.1.4.6 Distribution Poles (Tracking ID: GD_4 – GD_5 – GD_6)

GO 95 Rule 43.1 requires BVES to design, build, and maintain their overhead facilities to withstand foreseeable fire and wind conditions in the service territory. Poles that are not compliant with GO 95 safety factors will be identified, and the appropriate remediation will be designed and implemented. Meeting or exceeding the mandates of GO 95 is critical to mitigate wildfires. Depending on the nature and extent of the noncompliance, the remediation will require either repair (e.g., the installation or modification of guy wires) or complete replacement of the pole, including removal and reinstallation of all attachments, all within the time frames required by GO 95. GO 95 is aimed at the safety of personnel, the public, and preserving the reliability of the power grid. Risk is significantly reduced when poles are brought into compliance with laws directed at preserving safety and reliability. BVES uses preventative maintenance to identify poles at risk

8.1.4.7 Lightning arrestors (Tracking ID: GD_4 – GD_5 – GD_6 – GD_28 – VM_3)

BVES installs lightning arrestors that are approved for use in all areas of California in accordance with GO-95. Lightning arrestors are inspected via BVES's asset inspections (detailed, patrol, thermography, UAV photography) and defective arrestors are replaced. Additionally, during pole replacements arrestors are also replaced.

8.1.4.8 Reclosers (Tracking ID: GD_12, GD_13, GD_14, GD_15, GD_16, GD_17)

Protective relays are used extensively across the power system to remove any element from service that suffers a short circuit, starts to operate abnormally, or poses a risk to the operation of the system. It is essential to inspect and test substation protective relays at chosen intervals. The frequency of maintenance inspections and tests depends on the quality of the equipment, importance of the supply, and upon the conditions at the site where the relays are installed. Protective substation relays are inspected, tested, and calibrated on a periodic basis to assure proper operation in accordance with GO 174. In 2023, BVES will start to automate additional field switches as discussed below.

8.1.4.9 Splices (Tracking ID: GD_4 – GD_5 – GD_6)

BVES rarely uses splices. BVES's asset inspections (detailed, patrol, thermography, UAV photography) inspect for splices and defective splices are repaired. Additionally, during reconductor work, splices are removed.

8.1.4.10 Transmission Poles/Towers

N/A. BVES does not own or operate any transmission assets.

8.1.4.11 Transformers (Tracking ID: GD_8)

BVES routinely maintains these electrical assets through standard transformer operations and maintenance practices to prevent ignition risk mainly due to catastrophic failure.

BVES has 3,141 service transformers and performs the following operations and maintenance on them:

- Detailed asset inspections (visual inspection checking for oil leakage, casing bulging, casing corrosion and integrity)
- Patrol asset inspection (visual inspection checking for oil leakage, casing bulging, casing corrosion and integrity)
- LiDAR asset inspection
- UAV Thermography asset inspection
- UAV Photography/Videography asset inspection
- 3rd Party Ground Patrol asset inspection

BVES has 18 substation transformers and performs the following operations and maintenance on them:

- Periodic oil samples and analysis
- Monthly GO 174 visual inspection (checking for oil leakage, casing bulging, casing corrosion and integrity) and recording of operating temperatures and oil level
- Periodic thermography (every 4 years)
- Periodic winding resistance tests (every 4 years)

- Current injection test (every 4 years)
- Insulation resistance test (every 4 years)
- Transformer turns ratio (every 4 years)
- Power factor testing (every 4 years)

Service transformers are replaced based on their condition as determined by the above operations and maintenance actions and if the load needs to be expanded on the transformer.

Similarly, substation transformers are replaced based on condition as determined by above operations and maintenance actions and generally as part of a major substation upgrade project. BVES preventative maintenance and replacement program is intended to replace transformers before they fail.

8.1.4.12 Other Equipment Not Listed

N/A. BVES does not have other equipment not already listed and addressed.

8.1.5 Asset Management and Inspection Enterprise System(s) (Tracking ID: GD_34)

In this section, the electrical corporation must provide an overview of Inputs, operation of, and support for centralized asset management and inspection enterprise system(s) updated based upon inspection results and activities such as hardening, maintenance, and remedial work. This overview must include discussion of:

- *The electrical corporation's asset inventory and condition database*
- *Describe the utilities internal documentation of its database(s)*
- *Integration with systems in other lines of business*
- *Integration with the auditing system(s) (see QA/QC section below)*
- *Describe internal processes for updating enterprise system including database(s) and any planned updates*
- *Any changes to the initiative since the last WMP submission and a brief explanation as the why those changes were made. Include any planned improvements or updates to the initiative and timeline for implementation*

BVES improved its asset management and inspection enterprise system over the last few years. Data governance is an enabling investment that supports the overall effort of mitigating wildfires. Proper data governance will support the tracking of events that could lead to a wildfire, tracks the progress of electric system upgrades, and enables the ability to provide information to “other” parties.

BVES recognizes the importance of carefully tracking and managing WMP data for all its activities and initiatives performed in accordance with this WMP. BVES records and manages data collected from numerous sources, in varying formats, and in several storage locations in the execution of its wildfire mitigation efforts. BVES Table 8-2 below highlights the types of data collected and the repository in use by BVES for such data.

BVES Table 8-2 Detailed Data Information

Data Source	Storage Location	Data	Planned Next Steps	Storage Type (Excel, GIS, etc.)	Update Process
Vegetation Management	Partners & Spreadsheet Database & iRestore (in progress)	Vegetation findings and completed sections	Migration to iRestore (cloud-based) software	Excel, Geo Database, Cloud-based	Manual, mobile phone, and tablet
Substation Inspections (GO 174)	Paper-based-database & iRestore (in progress)	Asset inventory, type, and condition	Migration to iRestore (cloud-based) software Oct. 2023	Binder, Cloud-based	Manual
GO 165 Inspections	iRestore	Asset inventory, asset/vegetation findings and condition	Add vegetation management inventory, tracking	Cloud-based, Geo Database	Via mobile phone, tablet
LiDAR Inspections	Spreadsheet and web portal	Asset/vegetation findings and condition	Planning to import into Geo Database	Excel, Shapefile	Manual
UAV Inspections	Spreadsheet and web portal	Asset/vegetation findings and condition	Will be reviewing the program and improving as needed	Excel, Geo Database	Manual
Covered Conductor	Spreadsheet & Geo database	Asset inventory	Continue to update into Geo Database	Excel, Geo Database	Manual
Pole Replacement	Spreadsheet & Geo Database	Asset inventory, inspection dates, findings, and condition	Continue to update into Geo Database	Excel, Geo Database	Manual
Pole Remediation	Spreadsheet	Asset inventory, inspection dates, findings, and condition	Will be reviewing the program and improving as needed	Excel	Manual
Pole Assets	Spreadsheet & Geo Database	Asset inventory, inspection dates, findings, and condition	Continue to update into Geo Database	Excel	Manual
Fire Wrap	Spreadsheet & Geo Database	Asset inventory, inspection dates, findings, and condition	Continue to update into Geo Database	Excel, Geo Database	Manual
Fuse Replacement	Spreadsheet & Geo Database	Asset inventory, inspection dates, findings and condition	Continue to update into Geo Database	Excel, Geo Database	Manual

Data Source	Storage Location	Data	Planned Next Steps	Storage Type (Excel, GIS, etc.)	Update Process
VM QA/QC Inspections	Web Portal	Vegetation findings and completed sections	Migration to iRestore (Cloud-based) software	Excel	Manual, Via tablet
Asset Inspection QA/QC	Spreadsheet	Asset inventory, inspection dates, findings, and condition	Migration to iRestore (Cloud-based) software	Excel	Manual
Outage Log	Spreadsheet	Outage time/date, duration, and cause	Continue to update datasets needed for regulatory compliance	Excel, Geo Database	Manual
Daily wildfire risk	Technosylva	Ignition and spread potential based on current, expected conditions	Add PSPS threshold indicators	Geo Database	Vendor automated updates

BVES is continually updating its data gathering and managing resources and tools. Equally important is having the ability to track electric system upgrades in a GIS database. Having this information in a standard format supports BVES's ability to continuously improve its risk mitigation process.

BVES GIS system does not currently support the sharing of data with key stakeholder agencies, such as the CPUC and Cal Fire, but BVES provides its data in accordance with regulatory requirements. To support the above, BVES has an ongoing initiative to update GIS records in the format agreed upon by the OEIS.

Currently, most of these systems are standalone but BVES is working to integrate them with its other systems. Regarding BVES, interaction with other lines of business is less of a concern than larger utilities as the structure is essentially flat with most staff members responsible for multiple roles affecting different parts of the utility's operations.

BVES can share its data with both internal and external QA and QC reviews and activities. However, BVES does not have an automated "auditing system." BVES will continue to monitor such systems for their effectiveness at a reasonable cost.

Since the 2022 BVES WMP Update, BVES made a few key updates to the main internal inspection enterprise system. BVES is continuing the goal to integrate all internal inspections into one central database into the current inspection application "iRestore" database. BVES also added a General Order 165 (GO 165) Detailed Inspections Portal, a General Order 174 (GO 174) Substation Inspection Portal, and a Vegetation Management inventory database. This created a reliable, searchable, comprehensive, and easily accessible database allowing BVES staff to continually meet or exceed all regulatory inspection requirements and achieve WMP inspection targets. Importantly, the enterprise system allows BVES to prioritize and track

corrective action via work orders to inspection deficiencies and conduct trend analysis of work orders. The system allows management to understand the scope of work orders and ensure resources are being properly allocated to completing any outstanding work orders. iRestore is a customizable database that BVES can mold to meet current and future needs. The next update to the iRestore database will be an addition of a meter inspection portal that is expected to be completed in 2024.

8.1.6 Quality Assurance / Quality Control (QA/QC) (Tracking ID: GD_35)

In this section, the electrical corporation must provide an overview of its QA/QC activities for asset management by inspection program. This overview must include:

- *Reference to procedure/program documenting QA/QC activities.*
- *How the sample sizes are determined and how the electrical corporation ensures the samples are representative*
- *Qualifications of the auditors*
- *Documentation of findings and how lessons learned based on those findings are incorporated into training and/or procedures*
- *Any changes to the initiative since the last WMP submission and a brief explanation as the why those changes were made. Include any planned improvements or updates to the initiative and timeline for implementation*
- *Tabular information (Table 8-7 is an exemplar of the appropriate level of detail) that includes:*
 - *Sample sizes*
 - *Type of QA/QC performed (e.g., desktop or field)*
 - *Resulting pass rates, starting in 2022*
 - *Yearly target pass rate for the 2023-2025 Base WMP cycle*

Table 8-7 Grid Design and Maintenance QA/QC Program

Activity Being Audited	Sample Size	Type of Audit	Audit Results 2022	Yearly Target Pass Rate for 2023-2025
Covered Conductor Installation	100% Inspection of installations by contractor	Verify Contractor's Construction and installation	Completed	99%
Tree Attachment Removal Program	100% inspection of installations by contractor	Verify Contractor's Construction and installation	Completed	99%
Grid Design and Maintenance	20 Inspections per year	QC of Grid Design and Maintenance	Beginning in 2023	99%

Asset management to achieve properly operating equipment and facilities is vitally important for enhancing public safety and mitigating the threat of wildfire. Therefore, establishing a high performing asset management quality assurance (QA) and quality control (QC) program is a critically essential element of a successful asset management program that aims to assure intended contractors' scope of work outcomes and asset management continuous process improvement.

BVES's asset QA/QC program includes the identification and actionable outcomes of deficiencies and inspection protocols executed in the field. The findings and lessons learned from such actions, including third-party evaluations, are incorporated into the training and applying lessons learned from third-party evaluations and inspections. The initiative establishes an audit process for the BVES Field Inspectors to manage and oversee the work completed by employees or contractors, including packaging QA/QC information for input to decision-making and workforce management processes. The qualifications for the BVES Field Inspectors are found in Table 8-9. This includes the identification of deficiencies and actionable outcomes to improve inspection protocols executed in the field. This supports improvement of work outcomes, training of personnel involved in asset management, and applying lessons learned from internal and external evaluations and audits.

Given the population of each work order or maintenance activity type unit (e.g., pole replacements, covered wire installation, tree attachment removals, wire mesh wrap installations, etc.) is less than 1,000 in any given year, BVES strives to achieve a quality control (QC) sample size of at least 10%. This value provides a confidence level of >95% and a margin of error of no more than 10%. This approach provides reasonable assurances on the quality of work and is realistically achievable by BVES's small staff. Additionally, as part of work order closing procedures, BVES staff conducts a quality assurance (QA) audit all work order documents (e.g., as-built drawings, work order instructions, material usage sheets, invoices, etc.) to ensure the work was properly documented. BVES Table 8-3 below demonstrates the quality control program tracking.

BVES Table 8-3 Quality Control Program Tracking

Start Pole #	End Pole #	Start STA #	End STA #	New Wire Size	Total Circuit Length	Conductor Qty	Circuit	Install Date	CM	BVES QC Date	BVES Inspector	BVES QC Personnel
12439BV	11918BV / 14278BV	60	69-70	394	1250	3	Shay 34kV	6/10/2021	0.24	6/11/2021	Field Inspector	Anthony Rivera
12439BV	11918BV / 14278BV	60	69-70	394	1250	4	Pioneer 4kV	6/10/2021	0.24	6/11/2021	Field Inspector	Anthony Rivera
12447BV	14824BV	78	82-83	1/0	525	2	Pioneer 4kV	6/24/2021	0.10	6/25/2021	Field Inspector	Anthony Rivera
14826BV	14828BV	91	94-95	1/0	575	2	Pioneer 4kV	6/24/2021	0.11	6/25/2021	Field Inspector	Anthony Rivera
11298BV	12439BV	60	61	1/0	60	2	Pioneer 4kV	6/10/2021	0.01	6/11/2021	Field Inspector	Anthony Rivera
12433BV	12447BV	40	78	394	3975	4	Pioneer 4kV	6/18/2021	0.75	7/8/2021	Field Inspector	Anthony Rivera
12433BV	12447BV	40	78	394	3975	3	Shay 34kV	6/18/2021	0.75	7/8/2021	Field Inspector	Anthony Rivera
12433BV	12637BV	40	26	394	1865	4	Pioneer 4kV	7/2/2021	0.35	7/19/2021	Field Inspector	Anthony Rivera
12433BV	12637BV	40	26	394	1865	3	Shay 34kV	7/2/2021	0.35	7/19/2021	Field Inspector	Anthony Rivera
12426bv	11232bv	48	52	1/0	663	2	Pioneer 4kV	7/9/2021	0.13	7/19/2021	Field Inspector	Anthony Rivera
12445bv	1211696ctc	85	87	1/0	110	2	Pioneer 4kV	7/9/2021	0.02	7/19/2021	Field Inspector	Anthony Rivera

Start Pole #	End Pole #	Start STA #	End STA #	New Wire Size	Total Circuit Length	Conductor Qty	Circuit	Install Date	CM	BVES QC Date	BVES Inspector	BVES QC Personnel
14763BV	9285BV / 14815BV	1	23/24	394	2726	4	Pioneer 4kV	7/15/2021	0.52	7/19/2021	Field Inspector	Anthony Rivera
14763BV	9285BV / 14815BV	1	23/24	394	2726	3	Shay 34kV	7/15/2021	0.52	7/19/2021	Field Inspector	Anthony Rivera
9774BV	12557BV	5	23	394	2182	4	Sunset 4kV	9/24/2021	0.41	10/1/2021	Field Inspector	Anthony Rivera
9774BV	12557BV	5	23	394	2182	3	Shay 34kV	9/24/2021	0.41	10/1/2021	Field Inspector	Anthony Rivera
12557BV	11095BV / 14776BV	5	34/35	394	1850	3	Shay 34kV	10/8/2021	0.35	10/22/2021	Field Inspector	Anthony Rivera
12557BV	11095BV / 14776BV	5	34/35	394	1850	4	Sunset 4kV	10/8/2021	0.35	10/22/2021	Field Inspector	Anthony Rivera
9772BV / 14765BV	9774BV	3-4	5	394	180	3	Shay 34kV	10/22/2021	0.03	10/22/2021	Field Inspector	Anthony Rivera
9772BV / 14765BV	9774BV	3-4	5	394	180	4	Sunset 4kV	10/22/2021	0.03	10/22/2021	Field Inspector	Anthony Rivera
11095BV / 14776BV	13864BV	34-35		394	60	4	Sunset 4kV	10/22/2021	0.01	10/22/2021	Field Inspector	Anthony Rivera
11095BV / 14776BV	13864BV	34-35		394	60	3	Shay 34kV	10/22/2021	0.01	10/22/2021	Field Inspector	Anthony Rivera
10543BV	14829BV	23	96/97	394	3770	4	Shay 34kV	10/22/2021	0.71	10/29/2021	Field Inspector	Anthony Rivera
10543BV	14829BV	23	96/97	394	3770	3	Sunset 4kV	10/22/2021	0.71	10/29/2021	Field Inspector	Anthony Rivera
14795BV	14803BV	42	59	394	1175	4	Sunset 4kV	10/28/2021	0.22	11/12/2021	Field Inspector	Anthony Rivera
BV10985	14843BV	25	27	394	199	4	Paradise 4kV	11/16/2021	0.04	11/24/2021	Field Inspector	Anthony Rivera
14843BV	14834BV	27	29	394	199	4	Paradise 4kV	11/16/2021	0.04	11/24/2021	Field Inspector	Anthony Rivera
14834BV	14832BV	29	31	394	151	4	Paradise 4kV	11/16/2021	0.03	11/24/2021	Field Inspector	Anthony Rivera
14832BV	9044BV	31	3	394	227	4	Paradise 4kV	11/16/2021	0.04	11/24/2021	Field Inspector	Anthony Rivera
14839BV	BV10985	24	25	394	59	4	Paradise 4kV	11/23/2021	0.01	11/24/2021	Field Inspector	Anthony Rivera

Current plans for next year include applying any lessons learned and gathered throughout the year and further improving BVES's QA/QC program for asset inspection. BVES will monitor the results of its asset management QA/QC programs and implement improvements as warranted. BVES will also exchange information with other utilities to determine best practices in asset management QA/QC for consideration in BVES's program.

8.1.7 Open Work Orders (Tracking ID: GD_36)

In this section, the electrical corporation must provide an overview of the process it uses to manage its open work orders. This overview must include a brief narrative that provides:

- *Reference to procedures/programs documenting the work order process. The electrical corporation must provide a summary of these procedures or provide a copy in the supporting documents location on its website.*
- *A description of how work orders are prioritized based on risk.*
- *A description of the plan for eliminating any backlog of work orders (i.e., open work orders that have passed remediation deadlines), if applicable.*
- *A discussion of trends with respect to open work orders*

In addition, each electrical corporation must:

- *Graph open work orders over time as reported in the QDRs (Table 2, metrics 8.a and 8.b).*
- *Provide an aging report for work orders past due (Table 8-8 provides an example).*

BVES follows General Order 95 (GO 95) Rule 18 requirements in managing and prioritizing open work orders. Work Orders are priority levels and associated timeframes for completion in accordance with GO 95 Rule 18 (e.g., Level 1, 2, or 3). BVES identifies work orders through its formal inspection programs as well as through as identified conditions by service crews, supervisors, and call-ins. The deficiencies are input into an asset enterprise system (BVES utilizes iRestore) where a work order number is created. Qualified BVES maintenance staff and contractors apply a level of severity in accordance with GO 95 Rule 18 and the iRestore program applies the corresponding timeframe for the remediation to be accomplished. If the repair is simple and does not require engineering design package (e.g., missing signage or visual strips), a Service Crew will be tasked to complete the work order, typically the same day. If the repair requires engineering design (e.g., pole replacement), the work order goes to the engineering planning group to have a design package created, but the situation will be at least mitigated down from a Level 1. Once a design package developed, the package is provided to Field Operations and construction crew is assigned to the work order to complete the required remediation.

BVES prioritizes open work orders first by level of severity defined by GO 95 Rule 18. Level 1 findings are addressed immediately by either completely remediating the issue or by making minor repairs to reclassify the issue to a Level 2 or level 3. Level 2 findings are assigned a timeframe of six months if in the HFTD Tier 3 area or 12 months if in the HFTD Tier 2 area. All Level 3 work orders are to be repaired within 60 months of being identified. BVES also prioritizes work orders within each level by HFTD. For example, HFTD Tier 3 Level 3 work orders have a higher priority over other areas. Finally, BVES prioritizes work orders within each level and HFTD area by higher risk circuits per BVES's the Fire Safety Circuit Matrix described in Section 6.2. For example, Level 2 work orders within the HFTD 2 area are prioritized based on the level of risk circuits have per BVES's Fire Safety Matrix. As BVES implements its Technosylva WRRM Risk Model, the model will be used in place of the Fire Safety Circuit Matrix to prioritize work orders.

At the time of this writing, BVES does not have any past due work orders. Any past due work orders are immediately prioritized for correction. Work orders approaching their due date, or past due work orders are automatically flagged to BVES maintenance supervisors by the enterprise system. Other considerations in assigning work orders to crews are the work order age and grouping orders geographically together. For example, if a crew is working on a higher priority work order, lower priority work orders on the same facility would also be assigned to the crew so that they may be corrected while the crew is on site.

If a backlog of work orders coming due or even past due were to develop, BVES will develop a plan of action to gain control of the work orders as follows:

- First, BVES would prioritize completing the backlog with internal crew resources or augmenting with contracted crews.
- Second, BVES management will analyze the root causes contributing to the backlog developing and initiate corrective action address the root causes.

BVES began populating its asset work order enterprise system to track work orders in the first quarter of 2023. With this tracking ability from the asset enterprise system, BVES will have the ability to conduct work order trend analysis. Conducting such trend analysis will be part of the

maintenance supervisory element’s routine. The trend analysis will be presented to management at periodic management meetings.

Table 8-8 Past Due Asset Work Orders

HFTD Area	0-30 Days	31-Days	91-180 Days	181+ Days
Non-HFTD	0	0	0	0
HFTD Tier 2	0	0	0	0
HFTD Tier 3	0	0	0	0

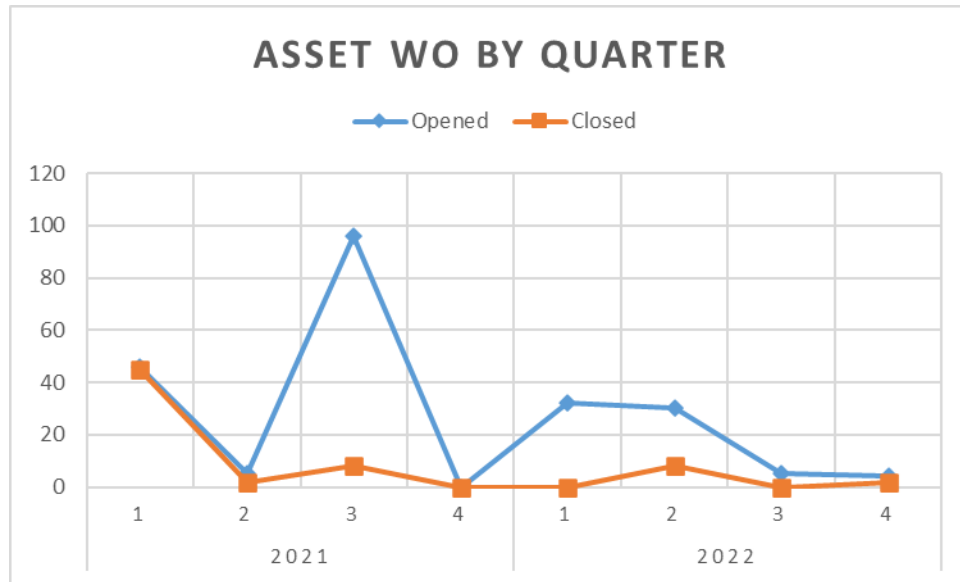

Figure 8-2 Asset Work Orders by Quarter

8.1.8 Grid Operations and Procedures

In this section, the electrical corporation must discuss the ways in which operates its system to reduce wildfire risk. The equipment settings discussion must include the following:

- *Protective equipment and device settings*
- *Automatic recloser settings*
- *Settings of other emerging technologies (e.g., rapid earth fault current limiters)*

For each of the above, the electrical corporation must provide a narrative on the following:

- *Settings to reduce wildfire risk*
- *Analysis of reliability/safety impacts for settings the electrical corporation uses*
- *Criteria for when the electrical corporation enables the settings*
- *Operational procedures for when the settings are enabled*
- *The number of circuit miles capable of these settings*
- *An estimate of the effectiveness of the settings*

8.1.8.1 Equipment Settings to Reduce Wildfire Risk (Tracking ID: GD_37)

In this section, the electrical corporation must discuss the ways in which operates its system to reduce wildfire risk. The equipment settings discussion must include the following:

- *Protective equipment and device settings*
- *Automatic recloser settings*
- *Settings of other emerging technologies (e.g., Rapid Earth Fault Current Limiters)*

For each of the above, the electrical corporation must provide a narrative on the following:

- *Settings to reduce wildfire risk*
- *Analysis of reliability/safety impacts for settings the electrical corporation uses*
- *Criteria for when the electrical corporation enables the settings*
- *The number of circuit miles capable of these settings*
- *An estimate of the effectiveness of the settings*
- *The electrical corporation's operations procedures for response to off-normal events*

Protective Equipment and Device Settings

Grid operations and protocols encompass company procedures related to wildfires, special work procedures, and wildfire response team definitions. These practices help the utility manage risk on a day-to-day basis and during wildfire high-risk periods.

Understanding the electric system load/demand allows BVES to create an operating mode optimized for two types of operations: (1) safety and reliability and (2) wildfire prevention during high-risk periods. It should be noted that wildfire prevention measures during high fire risk weather conditions override reliability optimization regardless of season or system demand. BVES 34.5kV sub-transmission system is fed by Southern California Edison's (SCE) sub-transmission systems at 34.5kV at two delivery points. In order to ensure that the BVES protective system is properly coordinated with SCE's protective system, BVES's protective curve settings are always set to the fast trip settings. Additionally, for over 20 years, it is BVES's policy to use the fast trip curve setting on all devices due to BVES's location within high fire risk areas.

Comparison of BVES's outage data to other California and US utilities for the last 10 years does not indicate this policy resulted in increased outages. For over 20 years, BVES has not experienced any reportable ignitions. Most BVES customers are residential or small commercial. Therefore, it is rare for customer equipment to cause an over current driven trip.

Generally, since the winter months bring the heaviest load/demand on the BVES distribution system, BVES optimizes the system for safety and reliability during such time by utilizing the automatic testing feature on devices such as reclosers and fuse TripSavers. These months are often wet and do not typically pose significant wildfire risks. Following the winter season, the operational focus becomes more defensive and optimized for wildfire prevention, given the hot, dry climate. Specifically, the system uses the following protocols:

- From approximately November 1st through March 31st, the system is focused on safety and reliability and devices are set as follows:

- All fuse TripSavers fuses are set to three trips to lockout.
- All auto-reclosers are set to three trips to lockout.
- Radford 34.5kV line is energized and its recloser set to three trips to lockout.
- From approximately April 1st through October 31st, BVES adopts a more defensive operational scheme during the non-winter months. To accomplish this, the utility enacts the following operational settings:
 - All TripSavers fuses are set to non-reclosing.
 - All auto-reclosers are set to non-reclosing.
 - Radford 34.5 kV line is de-energized.

Although BVES generally follows a strict schedule, the utility monitors conditions, using the FPI, to determine if additional precautions should be taken. Further, BVES staff and BVES's weather consultant review the NFDRS on a weekly basis or more frequently during high fire threat periods to make advanced preparations and on a daily basis to determine if additional steps should be taken. In short, overall system configuration is optimized for fire prevention from approximately April 1 to October 31, using the seasonal characteristics of BVES's climate and load profile. The system is then further adjusted based on the FPI, as well as other operational and weather information available to BVES.

BVES monitors the FPI each day and then determines the proper operational focus from a reliability and fire prevention focus. Exact steps depend on the level of fire threat. As indicated in BVES Table 8-4 below, "High" and "Very High" "Extreme" are considered elevated fire threat conditions that require the BVES system to be configured for fire prevention over reliability concerns. FPI values are explained in Section 6.2.2 Risk and Risk Components Calculation and Figure 6-10 FPI Value and Percentile Table.

Each day the Wildfire Mitigation & Reliability Engineer (or alternate in his absence) reviews the WFA-E fire risk (Fire Behavior Index) forecast for the current weather forecast using for the sub-transmission and distribution systems and the FPI model. The Wildfire Mitigation & Safety Engineer will send the forecasts (WFA-E fire risk) and FPI to designated Field Operations and Management staff (President, Energy Resource Manager, Utility Manager, Field Operations Supervisor, Utility Engineer & Wildfire Mitigation Supervisor, Electrical Distribution System Engineer, Customer Programs Specialist, Substation Technician, and other staff as designated by the Utility Manager.

Table 8-4 below provides specific operational actions to be implement by the Operations and Customer Service Teams according to the FPI category.

BVES Table 8-4 FPI Operational Action

FPI Category	Very Low and Low	Moderate	High	Very High/Extreme
Auto-Reclosers and Protective Switches with Reclosing Capability	Automatic ¹	Manual (Non-Automatic)	Manual (Non-Automatic)	Manual (Non-Automatic)
Patrol following circuit or feeder outage	No ^{2,3}	Yes	Yes	Yes
Fuse TripSavers	Automatic ¹	Automatic ¹	Manual (Non-Automatic)	Manual (Non-Automatic)
Designate which circuits are under: (1) Consideration (2) In Scope	No	No	Yes	Yes
Deploy Wildfire Risk Team(s) to circuits "In Scope".	No	No	Yes ⁴	Yes
Cease using any spark producing tools and equipment for circuits under consideration or in scope.	No	No	Yes	Yes
Cease vegetation management work for circuits under consideration or in scope.	No	No	Yes ⁵	Yes
Cease "high risk" energized line work for circuits under consideration or in scope. ⁶	No	No	Yes	Yes
Forward to Field Operations updated list of medical baseline customers and impacts access and functional needs population.	No	Yes	Yes	Yes
Review Local Government, Agencies, First Responders, Critical Infrastructure, and Stakeholder notification lists and procedures.	No	Yes	Yes	Yes
Review customer notification procedures.	No	Yes	Yes	Yes
Activate EOC.	No	No	Yes ⁷	Yes
Initiate Local Government, Agencies, First Responders, Critical Infrastructure, and Stakeholder notification in accordance with BVES PSPS Procedures.	No	No	Yes ⁸	Yes ⁸
Initiate customer notification in accordance with BVES PSPS Procedures.	No	No	Yes ⁸	Yes ⁸
Prepare Bear Valley Power Plant for sustained operations.	No	No	Yes	Yes
Conduct switching operations to minimize impact of potential PSPS activity	No	No	Yes	Yes
Activate first responder, local government and agency, customer and community, and stakeholders PSPS communications plan.	No	No	Yes ⁹	Yes ⁹
Activate Community Resource Centers.	No	No	Yes ¹⁰	Yes
Invoke Public Safety Power Shutoff.	No	No	Yes ¹¹	Yes ¹¹

¹During the non-winter months, certain devices designated by the Field Operations Supervisor and approved by the Utility Manager will remain in Manual (Non-Automatic) for the entire period regardless of the wildfire risk.

² During the non-winter months, when an Auto-Recloser, Switch, or Fuse TripSaver that was placed in "Manual" due to the above policy trips open, the affected portions of the de-energized circuit or feeder will be patrolled prior to re-energizing them. If the cause is likely known and the fire risk is "Green" or "Yellow," the Field Operations Supervisor may authorize the Line

Crew to test the device once. If the device trips open again, the circuit or feeder must be thoroughly patrolled to determine the fault and ensure there is no risk to causing fire.

³No patrol is required. Re-test allowed following check of fault indicators, SCADA, other system indicators, and reports from the field. If the re-test fails, a patrol is mandatory.

⁴Based on actual conditions in the area, the Field Operations Supervisor may rescind the requirement to deploy Wildfire Risk Teams.

⁵The Wildfire Mitigation & Reliability Engineer may allow certain vegetation management activities to continue with additional controls to mitigate ignitions in place.

⁶The Field Operations Supervisor will review and designate which work is considered “high risk.” Examples of “high risk” work include line work that can result in ignitions such as line work in high vegetation density areas where the line could make contact with vegetation or work that could cause line slap.

⁷If forecasted sustained wind or 3-second wind gusts expected to exceed 55 or actual sustained wind or 3-second wind gusts exceed 45 mph and expected to increase. The Utility Manager reduced the scope of the EOC to match actual conditions in the field.

⁸Executive Management will approve initiating notifications.

⁹Executive Management will approve activating first responder, local government and agency, customer and community, and stakeholders PSPS communications plan.

¹⁰Based on actual conditions in the area, the Energy Resource Manager may rescind the requirement to activate the Community Resource Center.

¹¹If actual sustained wind or 3-second wind gusts exceed 55 mph. The President may initiate PSPS if in his judgement the actual conditions in the field pose a significant safety risk to the public.

When a Red Flag Warning condition is declared, Field Operations will closely monitor the FPI and other local forecasts to determine the appropriate operational conditions to be implemented. Additionally, BVES’s weather consultant provides more detailed and frequent forecast updates. It should be noted that generally Red Flag Warning conditions are assigned to areas much larger than the BVES service area, such as the County of San Bernardino. Therefore, BVES factors in the localized conditions for its service area.

In 2022, BVES started utilizing Technosylva’s Wildfire Analyst Enterprise (WFA-E) application to monitor the wildfire risk at each point along its circuits. BVES has been gaining experience and confidence in this model and will develop protocols in 2023 to shift from utilizing the NFDRS protocols discussed above to utilizing the WFA-E and FPI to drive operational decisions with respect to wildfire risk and mitigations.

BVES does not have any rapid earth fault current limiters. BVES continues to follow development with respect to these devices to determine whether this would be a prudent investment for BVES.

8.1.8.2 Grid Response Procedures and Notifications (Tracking ID: GD_38)

The electrical corporation must provide a narrative on operational procedures it uses to respond to faults, ignitions, or other issues detected on its grid that may result in a wildfire igniting, at a minimum, how it:

- *Locates the issues*
- *Prioritizes the issues*
- *Notifies relevant personnel and suppression resources to respond to issues*
- *Minimizes/optimizes response times to issues*

Power outages are tracked internally through the SCADA system, trip savers, fault indicators and/or the FLISR system. Outages may also be reported through the Customer Call Center or through the BVES iRestore application in which the local Fire and Sheriff department directly report outages to BVES. Information collected provides a basic understanding of the issue and this information is relayed to the Service Crew (during normal working hours) or the Dutyman (afterhours) who’s priority is to investigate any outage or issue in the field. These crews investigate outages in the field to determine the extent of the damage. This information is

quickly communicated to management which determines the personnel, equipment and outside sources needed to optimize recovery times. As necessary, BVES will conduct work with associated fire risk by de-energizing work areas. BVES will notify the Big Bear Fire Department (BBFD) and/or Cal Fire if any ignitions or wildfires are detected. As recovery activities progress, the field crews communicate with management who will quickly adjust recovery resources and activities, as required.

Any significant outage or afterhours outage effecting more than 25 customers is also communicated via text messages to the BVES “Internal PSPS List” which includes management, field and other key personnel involved with responding to emergency situations.

BVES’s small size allows the workforce to pivot to low-risk work on high fire threat days or conduct a training day for its staff. This is true for its contracted power line staff as well who have a detailed program and checklist to outline necessary precautions based on the Fire Index Rating (FIR). BVES and its contractors can easily pivot to low-risk activities on short notice due to its small size. For example, if a high fire threat day occurs with little notice, BVES can pivot to other de-energized work or to training, which it has at the ready. For example, BVES can pivot from covered wire or pole replacement work to de-energized work.

BVES’s vegetation management contractor has protocols in place for high fire threat weather. For example, on “Very High” fire threat conditions, BVES will require crews, staff, and contractors, to:

- Evaluate the weather conditions to ensure they are safe to work in.
- A Dedicated Fire Watch must be assigned to the jobsite.
- There must be a trailer-mounted water tank or alternative water delivery method at the jobsite. 120 gallons with 200 feet of hose.
- No chainsaw operations allowed – only hand saw use permitted.

As necessary, BVES can conduct work with associated fire risk by de-energizing work areas as applicable. BVES does not see reduced productivity overall with this method and has not missed a program target.

BVES will notify the BBFD and/or Cal Fire if any ignitions or wildfires are detected.

BVES will continue to evaluate its policies to not conduct certain work that produces sparks or has the potential to produce sparks on high fire threat days. Based on experience, lessons learned, and techniques other utilities are utilizing, BVES will frequently evaluate its approach and is open to making adjustments if there is a compelling reason to do so.

8.1.8.3 Personnel Work Procedures and Training in Conditions of Elevated Fire Risk (Tracking ID: GD_39)

The electrical corporation must provide a narrative on the following:

- *The electrical corporation’s procedures that designate what type of work the electrical corporation allows (or does not allow) personnel to perform during operating conditions of different levels of wildfire risk, including:*
 - *What the electrical corporation allows (or does not allow) during each level of risk*
 - *How the electrical corporation defines each level of wildfire risk*
 - *How the electrical corporation trains its personnel on those procedures*
 - *How it notifies personnel when conditions change, warranting implementation of those procedures*

- *The electrical corporation's procedures regarding deployment of firefighting staff and equipment (e.g., fire suppression engines, hoses, water tenders, etc.) to construction and/or electrical worksites for site-specific fire prevention and ignition mitigation during on-site work*

BVES will enforce operational changes when a RFW issuance or when its weather consultant forecasts high-risk conditions through local weather stations and the NFDRS reports. This initiative is critical to ensuring safe operations during routine and specialized work taking place within the service area.

During high fire threat weather, BVES suspends all work, by BVES staff or its contractors, which might produce sparks or create fire hazards. As discussed above, due to BVES's small size, BVES and its contractors are able to pivot to other low-risk work during such conditions. All line crews and field personnel are trained on this fire safe protocol.

During a potential emergency or significant event, a rapid response, with specific resources can reduce the risk of the event leading to a wildfire. BVES has a Wildfire Infrastructure Protection Team (WIPT). Given the need for capabilities during wildfire incidences and other emergencies, the WIPT aligns with BVES's Emergency Response Team (ERT). Both teams consist of the Utility Manager, Field Operations Supervisor, Service Crew, and Customer Service staff.

The Utility Manager oversees the WIPT. The Field Operations Supervisor will direct field activities and operations during the emergency. The Service Crew (or Dutyman outside normal working hours) will provide initial field response to the emergency. Additional linemen will be called out as needed. Furthermore, Customer Service staff and/or additional staff may be called out to assist with notification procedures as needed. Other staff may be called out at the direction of the Utility Manager to assist, as needed. For example, Engineering staff may be called out to assist linemen in monitoring local wind speeds.

Reports of wires sparking, or smoke could lead to a wildfire. The Utility Engineer & Wildfire Mitigation Supervisor has issued operational guidelines or procedures to follow in the event BVES receives a report of potential fire such as "arcing, sparks, smoldering, smoke, or fire" or other emergency reports involving the overhead distribution system. Examples of reports could include customer, or third-party reported arcing, sparking, smoke, or fire sightings. These procedures will be at the discretion of the Utility Manager and, given the event, will require prompt and decisive action to place the system in a safe condition.

8.1.9 Workforce Planning (Tracking ID: GD_40)

In this section, the electrical corporation must report on qualifications and training practices regarding wildfire and PSPS mitigation for workers in the following target roles:

- *Asset inspections*
- *Grid hardening*
- *Risk event inspection*

For each of the target roles listed above, the electrical corporation must:

- *List all worker titles relevant to the target role.*
- *For each worker title, list and explain minimum qualifications, with an emphasis on qualifications relevant to wildfire and PSPS mitigation. Note if the job requirements include:*

- *Going beyond a basic knowledge of GO 95 requirements to perform relevant types of inspections or activities*
- *Being a “Qualified Electrical Worker” (QEW); if so, define what certifications, qualifications, experience, etc. are required to be a QEW for the target role for the electrical corporation*
- *Report the percentage of electrical corporation and contractor full-time employees (FTEs) in the target role, with specific job titles*
- *Report plans to improve qualifications of workers relevant to wildfire and PSPS mitigation. The electrical corporation must explain how it is developing more robust training programs which would teach electrical workers to identify hazards that could ignite wildfires*

Table 8-9, Table 8-10, Table 8-11 are examples of the required information.

Table 8-9 Workforce Planning, Asset Inspections

Worker Title (Employee / Contractor)	Minimum Qualifications for Target Role	Special Certification Requirements	Electrical Corporation % FTE Min Quals	Electrical Corporation % Special Certifications	Reference to Electrical Corporation Training/Qualification Programs
Field Inspector (BVES Employee)	<p>Three years of Journeyman Lineman or above experience. IBEW Journeyman Lineman status in good standing Demonstrated knowledge and proficiency in GO 95 and GO 128. Experience inspecting overhead and underground facilities. Class C California Driver's License</p>	Journeyman Lineman	100%	100%	N/A

Worker Title (Employee / Contractor)	Minimum Qualifications for Target Role	Special Certification Requirements	Electrical Corporation % FTE Min Quals	Electrical Corporation % Special Certifications	Reference to Electrical Corporation Training/Qualification Programs
Light Crew Foreman (BVES Employee)	<p>Three years of experience as a Journeyman Lineman or Service Crew Foreman.</p> <p>IBEW Journeyman Lineman status in good standing.</p> <p>Knowledge of:</p> <p>Methods, materials, and tools used in electrical overhead and underground construction, maintenance, and repair work.</p> <p>Principles of electrical theory as applied to electrical circuits and wiring systems, GO 95 and 128, service requirements and all applicable codes, accident prevention rules and ordinances.</p> <p>Occupational hazards and standard safety precautions necessary in work.</p> <p>Class A California Driver's License.</p>	Journeyman Lineman	100%	100%	N/A

Worker Title (Employee / Contractor)	Minimum Qualifications for Target Role	Special Certification Requirements	Electrical Corporation % FTE Min Qualls	Electrical Corporation % Special Certifications	Reference to Electrical Corporation Training/Qualification Programs
Service Crew Foreman (BVES Employee)	<p>Three years of experience at the journey level in construction, maintenance, and repair of both overhead and underground electrical systems.</p> <p>IBEW Journeyman Lineman status in good standing.</p> <p>Knowledge of:</p> <ul style="list-style-type: none"> Methods, materials, and tools used in electrical overhead and underground construction, maintenance, and repair work. Principles of electrical theory as applied to electrical circuits and wiring systems, GO 95 and 128, service requirements and all applicable codes, accident prevention rules and ordinances. Inspection program requirements of GO 165 and GO 174. Occupational hazards and standard safety precautions necessary in work. Class A California Driver's License. 	Journeyman Lineman	100%	100%	N/A

<p>Substation Technician (BVES Employee)</p>	<p>Minimum five (5) years' experience observing and operating substation equipment.</p> <p>Journeyman Lineman certification a plus.</p> <p>Demonstrated ability to read and understand electrical system drawings and substation equipment technical manuals.</p> <p>Class C California Driver License.</p> <p>Sound knowledge of:</p> <ul style="list-style-type: none"> Methods, materials, and tools used in electrical distribution system substation construction, operations, maintenance, diagnostic, and repair work. Principles of electrical theory as applied to distribution system substations and grid equipment (34.5 kV and 4.160 kV). Inspection program requirements of GO 174. SCADA and electric utility GIS systems. IEEE-SA - National Electrical Safety Codes (NESC) as they pertain to electrical distribution 	<p>N/A</p>	<p>100%</p>	<p>N/A</p>	<p>N/A</p>
--	---	------------	-------------	------------	------------

Worker Title (Employee / Contractor)	Minimum Qualifications for Target Role	Special Certification Requirements	Electrical Corporation % FTE Min Quals	Electrical Corporation % Special Certifications	Reference to Electrical Corporation Training/Qualification Programs
	substations and grid equipment				
Utility Systems Specialist Inspector/Lead Inspector (Contractor)	Overhead Distribution and/or Transmission distribution inspection experience (2-year min) Identification of all overhead equipment Current Driver License Computer and GIS mapping experience	NESC and ANSI Inspection experience (1-year min) Red Cross FA/CPR Certified Wildfire Training	100%	100%	N/A
Geospatial Project Manager (Contractor)	8 years of GIS and Remote Sensing Experience 5 years or more in a Supervisory Role Advanced Knowledge of LiDAR Sensors and Data Advanced GIS Skills and Problem Solving	Geospatial Information Systems Professional (GISP)	100%	100%	ASPRS Certified Mapping Scientist, LiDAR
Geospatial Lead Analyst (Contractor)	8 years of GIS and Remote Sensing Experience Strong Quality Control and Detail Advanced Knowledge of LiDAR Sensors and Data Advanced GIS Skills and Problem Solving	N/A	100%	N/A	ASPRS Certified Remote Sensing Technologist

Worker Title (Employee / Contractor)	Minimum Qualifications for Target Role	Special Certification Requirements	Electrical Corporation % FTE Min Quals	Electrical Corporation % Special Certifications	Reference to Electrical Corporation Training/Qualification Programs
Geospatial Technician (Contractor)	Solid Understand of GIS and Remote Sensing Science Strong Attention to Detail Strong Computer Skills Work Independently	N/A	100%	N/A	N/A

Table 8-10 Workforce Planning, Grid Hardening

Worker Title (Employee / Contractor)	Minimum Qualifications for Target Role	Special Certification Requirements	Electrical Corporation % FTE Min Quals	Electrical Corporation % Special Certifications	Reference to Electrical Corporation Training/Qualification Programs
Utility Engineer & Wildfire Mitigation Supervisor (BVES Employee)	Bachelor's Degree in an engineering field or a technical discipline required. Eight years of planning, construction, or engineering experience including four years of administrative and supervisory experience. Utility experience preferred. Work experience in an area with strong compliance regimes. Experience interacting with utility regulators and knowledge of regulatory processes preferred.	Professional Engineer license in California required. If not held, must obtain within 2 years of employment.	100%	100%	N/A

Worker Title (Employee / Contractor)	Minimum Qualifications for Target Role	Special Certification Requirements	Electrical Corporation % FTE Min Quals	Electrical Corporation % Special Certifications	Reference to Electrical Corporation Training/Qualification Programs
	<p>Knowledge of overhead and underground line construction, substations, transformation, cabling, voltage drop, circuit protection and protection coordination, rules, rates and schedules, Company policies and procedures, service requirements, material management, electrical codes, budgeting and electrical theory and application.</p>				
<p>Field Operations Supervisor (BVES Employee)</p>	<p>Associate degree (Bachelor's preferred) in electrical engineering and construction management or related field or fifteen (15) years of experience in supervising line operations.</p> <p>Seven years of experience in line operations working under a collective bargaining agreement or equivalent combination of experience and education required</p> <p>Thorough knowledge of GO 95/165 and Construction Methods</p>	<p>N/A</p>	<p>100%</p>	<p>N/A</p>	<p>N/A</p>
<p>Regulatory Compliance Project</p>	<p>Bachelor's Degree in Electrical Engineering, or related field.</p>	<p>Professional Engineer's (PE) license in the</p>	<p>50%</p>	<p>100%</p>	<p>N/A</p>

Worker Title (Employee / Contractor)	Minimum Qualifications for Target Role	Special Certification Requirements	Electrical Corporation % FTE Min Quals	Electrical Corporation % Special Certifications	Reference to Electrical Corporation Training/Qualification Programs
Engineer (BVES Employee)	<p>Strong experience with overhead and underground distribution and substation design. Knowledge of SCADA and automated grid systems are highly desirable.</p> <p>Excellent knowledge and strong experience in working in a highly regulated environment and working with a large number of agencies such as: US Forest Service, US Bureau of Land Management, US Fish and Wildlife Service, California Department of Fish and Game, California Division of Occupational Safety and Health (DOSH, also known as Cal/OSHA), California Department of Transportation (Caltrans), Department of Transportation (DOT), State Water Resource Control Board, California Environmental Protection Agency (EPA), and South Coast Air Quality Management District (SCAQMD).</p> <p>Experience with California Environmental Quality Act (CEQA) process.</p> <p>Experience and working knowledge of CPUC General Orders 95, 128, 165 and 174.</p>	California is strongly desired. Note, that if the applicant does not have a PE in California, the applicant will be required to obtain a California PE license within 12 months of employment at BVES, Inc. in this position.			

Worker Title (Employee / Contractor)	Minimum Qualifications for Target Role	Special Certification Requirements	Electrical Corporation % FTE Min Quals	Electrical Corporation % Special Certifications	Reference to Electrical Corporation Training/Qualification Programs
Project Coordinator (BVES Employee)	<p>Associates or bachelor's degree preferred</p> <p>Project Management course work and Project Management Professional (PMP) certification preferred</p> <p>Four years of experience in construction projects including demonstrable project management experience</p>	N/A	100%	N/A	N/A
Utility Planner I (BVES Employee)	<p>Bachelor's degree in Engineering or successful completion of a Utility Planning Certification required.</p> <p>Minimum of 2 years utility or comparable construction planning experience performing duties such as estimating, planning, and electrical distribution design work.</p>	N/A	100%	N/A	N/A
Engineering Inspector	<p>Minimum three years of experience at an Engineering Technical position or equivalent in an electric utility working the area of distribution.</p> <p>Experience identifying in field electrical equipment.</p> <p>Experience in distribution facility overhead design.</p>	N/A	100%	N/A	N/A

Worker Title (Employee / Contractor)	Minimum Qualifications for Target Role	Special Certification Requirements	Electrical Corporation % FTE Min Qualls	Electrical Corporation % Special Certifications	Reference to Electrical Corporation Training/Qualification Programs
	<p>Demonstrated Experience in AutoCAD design software and experience with GIS software (desired).</p> <p>Excellent understanding of the JPA process and paperwork</p>				
<p>Light Crew Foreman (BVES Employee)</p>	<p>Three years of experience as a Journeyman Lineman or Service Crew Foreman.</p> <p>IBEW Journeyman Lineman status in good standing.</p> <p>Knowledge of:</p> <ul style="list-style-type: none"> Methods, materials, and tools used in electrical overhead and underground construction, maintenance, and repair work. Principles of electrical theory as applied to electrical circuits and wiring systems, GO 95 and 128, service requirements and all applicable codes, accident prevention rules and ordinances. Occupational hazards and standard safety precautions necessary in work. 	<p>Journeyman Lineman</p>	<p>100%</p>	<p>100%</p>	<p>N/A</p>

Worker Title (Employee / Contractor)	Minimum Qualifications for Target Role	Special Certification Requirements	Electrical Corporation % FTE Min Quals	Electrical Corporation % Special Certifications	Reference to Electrical Corporation Training/Qualification Programs
	Class A California Driver's License.				
Service Crew Foreman (BVES Employee)	<p>Three years of experience at the journey level in construction, maintenance, and repair of both overhead and underground electrical systems.</p> <p>IBEW Journeyman Lineman status in good standing.</p> <p>Knowledge of:</p> <ul style="list-style-type: none"> Methods, materials, and tools used in electrical overhead and underground construction, maintenance, and repair work. Principles of electrical theory as applied to electrical circuits and wiring systems, GO 95 and 128, service requirements and all applicable codes, accident prevention rules and ordinances. Inspection program requirements of GO 165 and GO 174. 	Journeyman Lineman	100%	100%	N/A

Worker Title (Employee / Contractor)	Minimum Qualifications for Target Role	Special Certification Requirements	Electrical Corporation % FTE Min Quals	Electrical Corporation % Special Certifications	Reference to Electrical Corporation Training/Qualification Programs
	<p>Occupational hazards and standard safety precautions necessary in work.</p> <p>Class A California Driver's License.</p>				
Lineman (BVES Employee)	<p>Certified completion of a union or company recognized lineman apprenticeship training program.</p> <p>IBEW Journeyman Lineman status in good standing.</p> <p>Past experience in climbing wooden power poles and working on high voltage power lines.</p> <p>Knowledge of basic principles of electricity, current theory mathematics, GO 95 and 128 and all applicable codes, accident prevention orders and ordinances.</p> <p>Knowledge of methods, material and tools used in the construction, maintenance and repair of an overhead/underground transmission, distribution, and substation electrical system</p> <p>Must possess or obtain within 6 months a valid Class A California Driver's License.</p>	Journeyman Lineman	80%	100%	N/A

Worker Title (Employee / Contractor)	Minimum Qualifications for Target Role	Special Certification Requirements	Electrical Corporation % FTE Min Quals	Electrical Corporation % Special Certifications	Reference to Electrical Corporation Training/Qualification Programs
Substation Technician (BVES Employee)	<p>Minimum five (5) years' experience observing and operating substation equipment.</p> <p>Journeyman Lineman certification a plus.</p> <p>Demonstrated ability to read and understand electrical system drawings and substation equipment technical manuals.</p> <p>Sound knowledge of:</p> <p>IEEE-SA - National Electrical Safety Codes (NESC) as they pertain to electrical distribution substations and grid equipment.</p> <p>Methods, materials, and tools used in electrical distribution system substation construction, operations, maintenance, diagnostic, and repair work.</p> <p>Principles of electrical theory as applied to distribution system substations and grid equipment (34.5 kV and 4.160 kV).</p> <p>Inspection program requirements of GO 174.</p> <p>SCADA and electric utility GIS systems.</p>	N/A	100%	N/A	N/A

Worker Title (Employee / Contractor)	Minimum Qualifications for Target Role	Special Certification Requirements	Electrical Corporation % FTE Min Quals	Electrical Corporation % Special Certifications	Reference to Electrical Corporation Training/Qualification Programs
	Class C California Driver License.				

Table 8-11 Workforce Planning, Risk Event Inspection

Worker Title (Employee / Contractor)	Minimum Qualifications for Target Role	Special Certification Requirements	Electrical Corporation % FTE Min Quals	Electrical Corporation % Special Certifications	Reference to Electrical Corporation Training/Qualification Programs
Utility Engineer & Wildfire Mitigation Supervisor (BVES Employee)	<p>Bachelor's Degree in an engineering field or a technical discipline required.</p> <p>Eight years of planning, construction, or engineering experience including four years of administrative and supervisory experience. Utility experience preferred.</p> <p>Work experience in an area with strong compliance regimes. Experience interacting with utility regulators and knowledge of regulatory processes preferred.</p> <p>Knowledge of overhead and underground line construction, substations, transformation, cabling, voltage drop, circuit protection and</p>	Professional Engineer license in California required. If not held, must obtain within 2 years of employment.	100%	100%	N/A

Worker Title (Employee / Contractor)	Minimum Qualifications for Target Role	Special Certification Requirements	Electrical Corporation % FTE Min Quals	Electrical Corporation % Special Certifications	Reference to Electrical Corporation Training/Qualification Programs
	protection coordination, rules, rates and schedules, Company policies and procedures, service requirements, material management, electrical codes, budgeting and electrical theory and application.				
Field Operations Supervisor (BVES Employee)	<p>Associate degree (Bachelor's preferred) in electrical engineering and construction management or related field or fifteen (15) years of experience in supervising line operations.</p> <p>Seven years of experience in line operations working under a collective bargaining agreement or equivalent combination of experience and education required.</p> <p>Thorough knowledge of GO 95/165 and Construction Methods.</p>	N/A	100%	N/A	N/A
Regulatory Compliance Project Engineer (BVES Employee)	<p>Bachelor's Degree in Electrical Engineering, or related field.</p> <p>Strong experience with overhead and underground distribution and substation design. Knowledge of SCADA and automated grid systems are highly desirable.</p>	Professional Engineer's (PE) license in the California is strongly desired. Note, that if the	50%	100%	N/A

Worker Title (Employee / Contractor)	Minimum Qualifications for Target Role	Special Certification Requirements	Electrical Corporation % FTE Min Quals	Electrical Corporation % Special Certifications	Reference to Electrical Corporation Training/Qualification Programs
	<p>Excellent knowledge and strong experience in working in a highly regulated environment and working with a large number of agencies such as: US Forest Service, US Bureau of Land Management, US Fish and Wildlife Service, California Department of Fish and Game, California Division of Occupational Safety and Health (DOSH, also known as Cal/OSHA), California Department of Transportation (Caltrans), Department of Transportation (DOT), State Water Resource Control Board, California Environmental Protection Agency (EPA), and South Coast Air Quality Management District (SCAQMD).</p> <p>Experience with California Environmental Quality Act (CEQA) process.</p> <p>Experience and working knowledge of CPUC General Orders 95, 128, 165 and 174.</p>	<p>applicant does not have a PE in California, the applicant will be required to obtain a California PE license within 12 months of employment at BVES, Inc. in this position.</p>			

8.2 Vegetation Management and Inspection

8.2.1 Overview

In accordance with Public Utilities Code section 8386(c)(9), each electrical corporation's WMP must include plans for vegetation management.

In this section, the electrical corporation must identify objectives for the next 3- and 10-year periods, targets, and performance metrics related to the following vegetation management programmatic areas:

- *Vegetation inspections*
- *Vegetation and fuels management*
- *Vegetation management enterprise system*
- *Environmental compliance and permitting*
- *Quality assurance / quality control*
- *Open work orders*
- *Workforce planning*

8.2.1.1 Objectives

Each electrical corporation must summarize the objectives for its 3-year and 10-year plans for implementing and improving its vegetation management and inspections. These summaries must include the following:

- *Identification of which initiative(s) in the WMP the electrical corporation is implementing to achieve the stated objective, including Utility Initiative Tracking IDs*
- *Reference(s) to applicable codes, standards, and best practices/guidelines and an indication of whether the electrical corporation exceeds an applicable code, standard, or regulation*
- *Method of verifying achievement of each objective*
- *A completion date for when the electrical corporation will achieve the objective*
- *Reference(s) to the WMP section(s) or appendix, including page numbers, where the details of the objective(s) are documented and substantiated*

This information must be provided in Table 8-12 for the 3-year plan and Table 8-13 for the 10-year plan. Examples of the minimum acceptable level of information are provided below.

Table 8-12 BVES Vegetation Management Implementation Objectives (3-year plan)

Objectives for Three Years (2023-2025)	Applicable Initiative(s), Tracking ID(s)	Applicable Regulations, Codes, Standards, and Best Practices (See Notes)	BVES Exceeds the Regulatory Specification (Y/N)	Method of Verification (i.e., program)	Completion Date	Reference (Section and Page Number)
Maintain enhanced clearance specifications and evaluate effectiveness.	Pole clearing, VM_7 Clearance, VM_9 Substation defensible space, VM_11	PRC 4292, GO 95, GO 165, GO 174	Y	Detailed, Ground, Patrol, LiDAR, UAV Inspection Programs	31-Dec-25	8.2.3.1; pg. 201 8.2.3.3; pg. 202 8.2.3.5; pg. 206
Continue to proactively remove/remediate high-risk species.	High-risk species, VM_12	GO 95, ESRB-4	Y	Detailed, Ground, Patrol, LiDAR, UAV Inspection Programs	31-Dec-25	8.2.3.6; pg. 206
Continue robust vegetation inspection routine of annual Detailed Inspections, Patrol Inspections, LiDAR surveys, UAV HD Photography, 3rd party Ground Patrols, and Substation Inspections.	Vegetation inspections, VM-1, VM-2, VM-3, VM-4, VM-5, VM-6, VM-11	GO 95, GO 165, PRC 4292	Y	QA/QC Checks	31-Dec-25	8.2.2.1; pg. 195 8.2.2.2; pg. 196 8.2.2.3; pg. 197 8.2.2.4; pg. 198 8.2.2.5; pg. 198 8.2.2.6; pg. 199 8.2.3.5; pg. 206

Objectives for Three Years (2023-2025)	Applicable Initiative(s), Tracking ID(s)	Applicable Regulations, Codes, Standards, and Best Practices (See Notes)	BVES Exceeds the Regulatory Specification (Y/N)	Method of Verification (i.e., program)	Completion Date	Reference (Section and Page Number)
Implement robust vegetation management and inspection enterprise system. Ensure all trees within right-of-way tracked in data system.	Vegetation management enterprise system, VM_15	GO 95	N	SME system audit	31-Dec-23	8.2.4; pg. 208
Improve quality assurance and quality control program on vegetation management inspection and clearance work and asset inspection.	Quality assurance/quality control, VM_16	GO 95, GO 165	N	N/A	31-Dec-23	8.2.5; pg. 211
Develop and implement program to promote vegetation communities that are sustainable, fire-resilient, and compatible with the use of the land as an electrical corporation right-of-way.	Fire-resilient rights-of-way, VM_13	PRC 4292, GO 95, GO 165, GO 174	N	N/A	31-Dec-25	8.2.3.7; pg. 207

Table 8-13 Vegetation Management Implementation Objectives (10-year plan)

Objectives for Ten Years (2026-2032)	Applicable Initiative(s), Tracking ID(s)	Applicable Regulations, Codes, Standards, and Best Practices (See Notes)	BVES Exceeds the Regulatory Specification (Y/N)	Method of Verification (i.e., program)	Completion Date	Reference (Section and Page Number)
Continue to conduct program to promote vegetation communities that are sustainable, fire-resilient, and compatible with the use of the land as an electrical corporation right-of-way	Fire-resilient rights-of-way, VM_13	PRC 4292, GO 95, GO 165, GO 174	Y	Continue providing information and meeting with the community to promote sustainable and fire-resilient land	31-Dec-32	8.2.3.7; pg. 207
Evolve vegetation inspection cycles to be risk-based	Vegetation inspections, VM-1, VM-2, VM-3, VM-4, VM-5, VM-6, VM-11	PRC 4292, GO 95, GO 165, GO 174	Y	Evaluate risk-based evaluation cycles using information from Detailed, Ground Patrol, LiDAR and UAV Inspection programs	31-Dec-32	8.2.2.1; pg. 195 8.2.2.2; pg. 196 8.2.2.3; pg. 197 8.2.2.4; pg. 198 8.2.2.5; pg. 198 8.2.2.6; pg. 199 8.2.3.5; pg. 206
Evolve vegetation clearance cycles to be risk-based	Pole clearing, VM_7 Clearance, VM_9 Substation defensible	GO 95, GO 165, GO 174	Y	Evaluate risk-based vegetation clearance cycles from Detailed, Ground, Patrol, LiDAR, UAV	31-Dec-32	8.2.3.1; pg. 201 8.2.3.3; pg. 203 8.2.3.5; pg. 206

Objectives for Ten Years (2026-2032)	Applicable Initiative(s), Tracking ID(s)	Applicable Regulations, Codes, Standards, and Best Practices (See Notes)	BVES Exceeds the Regulatory Specification (Y/N)	Method of Verification (i.e., program)	Completion Date	Reference (Section and Page Number)
	space, VM_11			Inspection Programs		

BVES Table 8-5 Comparison of Bear Valley’s Vegetation Standards to GO 95 Minimum Requirements

Comparison of Bear Valley’s Vegetation Standards to GO 95 Minimum Requirements	
Bear Valley Requirement in Excess of GO 95	GO 95/GO 165 Requirements
Minimum radial clearance of 72 inches between high voltage bare conductors and vegetation. (Bear Valley’s bare conductors operate between 2.4kV and 72kV.)	GO 95: Minimum radial clearance of 48 inches.
No vertical coverage is allowed above sub-transmission lines (34.5kV).	GO 95: Minimum radial clearance of 48 inches.

Comparison of Bear Valley’s Vegetation Standards to GO 95 Minimum Requirements	
Bear Valley Requirement in Excess of GO 95	GO 95/GO 165 Requirements
<p>Tree Trunk and Major Limb Exception: At the primary conductor level, mature tree trunks greater than 12 inches in diameter and major limbs greater than 12 inches in diameter with sufficient strength and rigidity may encroach within the minimum safe distance (72-inches) but not within 12 inches of the bare line conductors. The rigidity of the tree trunk or major limb must be such that it would be impossible for it to encroach within 12 inches of the bare conductor at any time during high wind, heavy icing and snow, or other conditions. Must satisfy Tree Trunk and Major Limb Exception flowchart in Bear Valley’s Vegetation Management and Vegetation QA/QC Programs.</p>	<p>GO 95: Mature trees whose trunks and major limbs are located more than six inches, but less than the clearance required by Table 1, Cases 13E and 14E, from primary distribution conductors are exempt from the minimum clearance requirement under this rule. The trunks and limbs to which this exemption applies shall only be those of sufficient strength and rigidity to prevent the trunk or limb from encroaching upon the six–inch minimum clearance under reasonably foreseeable local wind and weather conditions.</p>
<p>All vegetation within the drip line of primary conductors that has the potential of growing into the secondary system or within 12 feet of the energized primary conductors within the 3-year vegetation management program cycle will be removed.</p>	<p>GO 95: Minimum radial clearance of 48 inches.</p>
<p>Dead, rotten, or diseased trees or dead, rotten, or diseased portions of otherwise healthy trees overhang or lean toward and may fall into a span of power lines, said trees or portions thereof must be removed. Note that this may apply to trees outside the clearance zone.</p>	<p>GO 95: Minimum radial clearance of 48 inches.</p>
<p>BVES conducts two patrol inspections per year. One is conducted by BVES’s qualified Field Inspector. The other is conducted by a qualified contractor experience in power line inspections and is referred to as “Third-Party Ground Patrol” (Initiatives 7.3.5.9 and 7.3.5.11).”</p>	<p>GO-165: Patrol inspections in rural areas shall be increased to once per year in Tier 2 and Tier 3 of the High Fire-Threat District.</p>
<p>BVES conducts one LiDAR survey per year of its entire overhead system. (Initiative 7.3.5.7)</p>	<p>GO 95/GO 165: No LiDAR inspection requirement in GO 95 or GO 165.</p>
<p>BVES conducts one aerial HD photography/videography survey per year of its entire overhead system. (Initiative 7.3.5.9)</p>	<p>GO 95/GO 165: No LiDAR inspection requirement in GO 95 or GO 165.</p>

8.2.1.2 Targets

Initiative targets are quantifiable measurements of activities identified in the WMP. Electrical corporations will show progress towards completing targets in subsequent reports, including QDRs and WMP Updates.

The electrical corporation must list all targets it will use to track progress on its vegetation management and inspections for the three years of the Base WMP. Energy Safety's Compliance Assurance Division and third parties must be able to track and audit each target.²⁵ For each initiative target, the electrical corporation must provide the following:

- *Utility Initiative Tracking IDs*
- *Projected targets for each of the three years of the Base WMP and relevant units*
- *Quarterly, rolling targets for end of 2023 and 2024 (inspections only)*
- *For 2023–2025, the “x% risk impact” For each of the three years of the Base WMP. The expected x% risk impact is the expected percentage risk reduction per year, as described in a7.2.2.2*
- *Method of verifying target completion*

The electrical corporation's targets must provide enough detail to effectively inform efforts to improve the performance (i.e., reduction in ignition probability or wildfire consequence) of the electrical corporation's vegetation management and inspections initiatives.

Table 8-14 Vegetation Management Initiative Targets by Year

Initiative Activity	Tracking ID	Units	2023 Target	X% Risk Impact 2023	2024 Target	X% Risk Impact 2024	2025 Target	X% Risk Impact 2025	Method of Verification
Wood and slash management	VM_8	Contractor Adhered to Waste Removal	Waste Removal Requirements Met	3.62%	Waste Removal Requirements Met	3.62%	Waste Removal Requirements Met	3.62%	Contract Status
Clearance	VM_9	Circuit Miles Cleared	72	3.02%	72	3.02%	72	3.02%	Quantitative (QDR)
Fall-in mitigation	VM_10	Number of trees remediated or removed to prevent fall-in	88	3.02%	88	3.02%	88	3.02%	Quantitative (QDR)
Substation defensible space	VM_11	Substations inspected and cleared	13	3.02%	13	3.02%	13	3.02%	Quantitative (QDR)
High-risk species	VM_12	WMP Plan Review and Vegetation Discussion with Experts	WMP Plan Review and Vegetation Discussion with Experts	3.02%	WMP Plan Review and Vegetation Discussion with Experts	3.02%	WMP Plan Review and Vegetation Discussion with Experts	3.02%	Version History

Initiative Activity	Tracking ID	Units	2023 Target	X% Risk Impact 2023	2024 Target	X% Risk Impact 2024	2025 Target	X% Risk Impact 2025	Method of Verification
Fire-resilient rights-of-way	VM_13	WMP Plan Review and Vegetation Discussion with Experts	WMP Plan Review and Vegetation Discussion with Experts	4.51%	WMP Plan Review and Vegetation Discussion with Experts	4.51%	WMP Plan Review and Vegetation Discussion with Experts	4.51%	Version History
Emergency response vegetation management	VM_14	Verification of Readiness and Review of Plan	Verification of Readiness and Review of Plan	3.02%	Verification of Readiness and Review of Plan	3.02%	Verification of Readiness and Review of Plan	3.02%	Version History
Vegetation management enterprise system	VM_15	Ongoing Monitoring and Maintenance	100%	3.02%	100%	3.02%	100%	3.02%	Budget Review
Quality assurance / quality control	VM_16	Number of Vegetation QCs	72	4.36%	72	4.36%	72	4.36%	Quantitative (QDR)
Open work orders	VM_17	No discrepancy exceeding GO95 resolution timeframes	All WO resolved within GO 95 Timeframe	3.02%	All WO resolved within GO 95 Timeframe	3.02%	All WO resolved within GO 95 Timeframe	3.02%	WO Log

Initiative Activity	Tracking ID	Units	2023 Target	X% Risk Impact 2023	2024 Target	X% Risk Impact 2024	2025 Target	X% Risk Impact 2025	Method of Verification
Workforce planning	VM_18	Verify Appropriate Staffing Levels for Wildfire Related Activities	Staffing Level Verified	3.62%	Staffing Level Verified	3.62%	Staffing Level Verified	3.62%	Meeting Minutes

Table 8-15 Vegetation Inspections Targets by Year

Initiative Activity	Tracking ID	Units	Target End of Q2 2023	Target End of Q3 2023	End of Year Target 2023	X% Risk Impact 2023	Target End of Q2 2024	Target End of Q3 2024	End of Year Target 2024	X% Risk Impact 2024	Target End of Q2 2025	Target End of Q3 2025	Target 2025	X% Risk Impact 2025	Method of Verification
Vegetation inspections / Detailed Inspection	VM_1	Circuit Miles Inspected	60	100	134	4.36 %	0	40	51	4.36 %	0	20	53	4.36 %	Quantitative (QDR)
Vegetation inspection	VM_2	Circuit Miles	0	211	211	4.36 %	0	211	211	4.36 %	102	153	205	4.36 %	Quantitative (QDR)

Initiative Activity	Tracking ID	Units	Target End of Q2 2023	Target End of Q3 2023	End of Year Target 2023	X% Risk Impact 2023	Target End of Q2 2024	Target End of Q3 2024	End of Year Target 2024	X% Risk Impact 2024	Target End of Q2 2025	Target End of Q3 2025	Target 2025	X% Risk Impact 2025	Method of Verification
ns / Patrol Inspection		Inspected													
Vegetation inspections / UAV HD Photography / Videography	VM_3	Circuit Miles Inspected	0	211	211	4.36 %	0	211	211	4.36 %	0	205	205	4.36 %	Quantitative (QDR)
Vegetation inspections / LiDAR Inspection	VM_4	Circuit Miles Inspected	0	211	211	4.36 %	0	211	211	4.36 %	0	205	205	4.36 %	Quantitative (QDR)
Vegetation inspections / 3 rd Party	VM_5	Circuit Miles Inspected	0	211	211	4.36 %	0	211	211	4.36 %	0	205	205	4.36 %	Quantitative (QDR)

Initiative Activity	Tracking ID	Units	Target End of Q2 2023	Target End of Q3 2023	End of Year Target 2023	X% Risk Impact 2023	Target End of Q2 2024	Target End of Q3 2024	End of Year Target 2024	X% Risk Impact 2024	Target End of Q2 2025	Target End of Q3 2025	Target 2025	X% Risk Impact 2025	Method of Verification
Ground Patrol															
Vegetation inspections / Substation Inspection	VM_6 ⁸	Number of Substations Inspected	0	211	211	4.35 %	0	211	211	4.35 %	72	108	144	4.35 %	Quantitative (QDR)

⁸ BVES has revised VM_6 units and targets to reflect correct values for 2025.

8.2.1.3 Performance Metrics Identified by BVES

Performance metrics indicate the extent to which an electrical corporation’s Wildfire Mitigation Plan is driving performance outcomes. The electrical corporation must:

- List the performance metrics the electrical corporation uses to evaluate the effectiveness of its vegetation management and inspections in reducing wildfire and PSPS risk

For each of these performance metrics listed, the electrical corporation must:

- Report the electrical corporation’s performance since 2020 (if previously collected)
- Project performance for 2023-2025
- List method of verification

The electrical corporation must ensure that each metric’s name and values are the same in its WMP reporting as its QDR reporting (specifically, QDR Table 2 and QDR Table 3). Metrics listed in this section that are the same as performance metrics required by Energy Safety and reported in QDR Table 2 (Performance Metrics)29 must match those reported in QDR Table 2. Metrics listed in this section that are not the same as any of the performance metrics identified by Energy Safety and reported in QDR Table 2 must match those reported in QDR Table 3.

The electrical corporation must:

- Summarize its self-identified performance metric(s) in tabular form
- Provide a brief narrative that explains trends in the metrics

Table 8-16 provides a list of performance metrics that relate to BVES Vegetation Management and Inspection program. Many of these metrics are used as tracking (tree’s trimmed, tree removal, tree attachments removed, Circuit Miles Trimmed, QC’s, and Customer Service calls) for annual performance. These metrics show annual accomplishment and are not intended to be trend based, but they do however influence Vegetation Ignitions, Vegetation caused outage, and Vegetation inspection findings. As you can see in the table below those that are directly affected by the annual tracking metrics are trending down or remaining the same year over year.

Table 8-16 Vegetation Management and Inspection Performance Metrics Results by Year

Performance Metrics	2020	2021	2022	2023 Projected	2024 Projected	2025 Projected	Method of Verification (e.g., third-party evaluation, QDR)
Vegetation-caused ignitions	0	0	0	0	0	0	QDR Table 2
Vegetation-caused outages	5	6	19	10	10	10	QDR Table 2
Vegetation Inspection Findings (All Methods)	N/A	520	375	145	145	145	QDR Table 2

Performance Metrics	2020	2021	2022	2023 Projected	2024 Projected	2025 Projected	Method of Verification (e.g., third-party evaluation, QDR)
Tree Attachment Removal	N/A	N/A	83	100	100	100	QDR Table 3
Tree's Trimmed	N/A	N/A	6042	N/A	N/A	N/A	QDR Table 3
Tree Removal	N/A	N/A	147	N/A	N/A	N/A	QDR Table 3
Circuit Miles Trimmed	N/A	N/A	86.84	72	72	72	QDR Table 3
VM QC's	N/A	N/A	132	72	72	72	QDR Table 3
Number of Customer Service calls about Tree Trimming	N/A	N/A	87	100	100	100	QDR Table 3

This initiative includes identifying and addressing deficiencies in inspections protocols, practices, and implementation by improving training and the evaluation of inspectors the identification and actionable outcomes of deficiencies and inspection protocols executed in the field. VM Inspection Improvement actions also support improvement of training and applying lessons learned from third-party contractor services and inspections. Additionally, it includes the identification and actionable outcomes of deficiencies and inspection protocols executed in the field. This will support improvement of work outcomes, training of personnel involved in vegetation management, and applying lessons learned from internal and external evaluations and audits.

BVES maintains routine training and assessment of vegetation management practices. BVES also applies annual lessons learned or identified improvements and tracks developing inspection practices in the industry. BVES conducts quarterly vegetation management assessments, and an annual audit of the vegetation management programs to identify and develop areas for improvements.

BVES performs inspection improvement activities across all of its inspections. Inspection techniques for the various inspections BVES performs do not vary significantly. Therefore, not much risk reduction is gained by prioritizing improvement of inspections in higher risk areas over lower risk areas – the same inspections are performed across the service territory.

BVES does prioritize implementing lessons learned and inspection improvements in its high-risk areas and prior to the fire season Santa Ana wind period.

As provided in table 8-63 BVES participates in scoping meetings hosted by Energy Safety. Additionally, BVES collaborates with adjacent IOU's in best practice sharing for vegetation management, PSPS, and asset inspection procedures and exercises. Best practices are shared informally and formally during scheduled meetings and when opportunities to share pertinent information arises.

8.2.2 Vegetation Inspections

In this section, the electrical corporation must provide an overview of its procedures for vegetation management inspections.

The electrical corporation must first summarize details regarding its vegetation management inspections in Table 8-17. The table must include the following:

- *Type of inspection: distribution, transmission, substation, etc.*
- *Inspection program name: Identify various inspection programs within the electrical corporation (e.g., routine, enhanced vegetation, high-risk species, and off-cycle)*
- *Frequency or trigger: Identify the frequency or triggers, such as inputs from the risk model. Indicate differences in frequency or trigger by HTFD Tier, if applicable*
- *Method of inspection: Identify the methods used to perform the inspection (e.g., patrol, detailed, sounding or root examination, aerial, and LiDAR)*
- *Governing standards and operating procedures: Identify the regulatory requirements and the electrical corporation's procedures for addressing them*

Table 8-17 Vegetation Management Inspection Frequency, Method, and Criteria

Type	Inspection Program	Frequency or Trigger (Note 1)	Method of Inspection (Note 2)	Governing Standards & Operating Procedures
Distribution	Detailed Inspection	5 Years	Detailed	GO 165 & GO 95 (Rule 18)
Distribution	Patrol Inspection	Annual	Patrol	GO 165 & GO 95 (Rule 18)
Distribution	UAV HD Photography/Videography	Annual	Arial	GO 165
Distribution	LiDAR Inspection	Annual	LiDAR	GO 95 (Rule 18)
Distribution	3 rd Part Ground Patrol	Annual	Patrol	GO 165 & GO 95
Substation	Substation Inspection	Monthly	Detailed	GO 174

Note 1: The electrical corporation must provide electrical corporation-specific risk-informed triggers used for vegetation management.

Note 2: The electrical corporation must provide electrical corporation-specific definitions of the different methods of inspection.

The electrical corporation must then provide a narrative overview of each vegetation inspection program identified in the above table; Sections 8.2.2.1. provides instructions for the overviews. The sections should be numbered 8.2.2.1 to Section 8.2.2.n (i.e., each vegetation inspection program is detailed in its own section). The electrical corporation must include inspection programs it is discontinuing or has discontinued since the last WMP submission; in these cases, the electrical corporation must explain why the program is being discontinued or has been discontinued.

8.2.2.1 Detailed Inspection (Tracking ID: GD_25, VM_1)

In this section, the electrical corporation must discuss:

- Noteworthy accomplishments for the inspection program since the last WMP
- Roadblocks the electrical corporation has encountered while implementing the inspection program and how the electrical corporation has addressed the roadblock
- Changes/updates to inspection program since the last WMP Including known future plans (beyond the current year) and new/novel strategies the electrical corporation may implement in the next 5 years (e.g., references to and strategies from pilot projects and research)

Process

The BVES Inspection Plan is intended to promote safety, circuit reliability, minimal service interruption, and reduced risk of fire through routine visual inspection of facility conditions. The inspection focus is ensuring compliance to GO 95 and GO 165 requirements. In these Detailed Inspections vegetation and individual trees in the rights-of-way are carefully examined, visually, and discrepancies are recorded. This inspection is thorough and is more time consuming than Patrol Inspections. Individual pieces of equipment and structures are carefully examined to determine the condition of each rated and recorded component and vegetation clearances to bare conductor and other components. Identifying vegetation encroachments to minimum clearance requirements (as established by GO-95 or BVES, whichever is greater) is the first step in correcting such occurrences, which in turn reduces the probability of ignitions due to vegetation contacting bare conductors.

Inspection intervals and reports comply with the requirement specified in GO 165. BVES's Inspection Program requires overhead facilities to be patrol inspected each year. A "detailed inspection" is a more careful visual exam of individual pieces of equipment. The inspector records the results of the visual examinations and rates the condition of the vegetation. These inspections are designed to identify any vegetation encroachment inside of BVES's minimum clearance standards or encroachment that will lead to violation of minimum clearance standards before the next scheduled vegetation clearance crew visit. These encroachments have the potential to spark and ignite a wildfire. Detailed Inspections are a critical element in mitigating the risk of wildfire caused by electric utility facilities.

BVES's Field Inspector performs the Detailed Inspections. The Field Inspector is required to be a Journeyman Lineman experienced in inspection of electric transmission and distribution facilities and power lines. The Field Inspector works closely with the contracted Forester to ensure he is equipped to properly inspect vegetation around power lines.

Detailed Inspection findings are rated in accordance with GO 95 Rule 18 (level 1, 2, or 3) and entered the distribution inspection GIS database. Level 1 findings are reported immediately to the Field Operations Supervisor who will direct corrective action as soon as possible to resolve the issue or reduce its severity to Level 2 so that more time is available to perform permanent corrective action.

Frequency or Trigger

BVES conducts these inspections at least once every five years in compliance with GO 165 and GO 95 (Rule 18). If any defects outlined above are identified, BVES prioritizes the defect resolution based on risk and resolves the issues in compliance with GO 95 Rule 18 timeframes. BVES divides its system up and each year conducts a number of Detailed Inspections such that each circuit is Detailed Inspected at least every five years. As the amount of covered wire installed in the BVES circuits becomes relatively significant, BVES will be revising its detailed inspection program in its next WMP cycle by increasing the frequency of detailed inspections on assets that have the highest risk according to its risk model.

Accomplishments and Updates

BVES completed all scheduled detailed inspections for 2022. Additionally, BVES fully transitioned into using a new inspection enterprise system (iRestore). iRestore provides better documentation of all identified vegetation issues by providing an exact geospatial location and high-resolution pictures. This helps reduce response time for vegetation crew when tasked with correcting the issue. BVES also created a feature class of all major woody stems in the entire service area.

Roadblocks

Environmental issues such as snow and ice can often affect detailed inspection. This can delay inspections for accessibility and safety reasons.

8.2.2.2 Patrol Inspection (Tracking ID: GD_26, VM_2)**Process**

Patrol inspections are intended to identify obvious problems or hazards while performing a “drive-by” patrol. The problems sought are those which are readily observable when performing a driving-, foot-, or aerial-patrol and do not require the patrolman to enter properties unless facilities cannot be observed from public access locations.

The Wildfire Mitigation and Reliability Engineer reviews the results of patrol inspections and assigns corrective action to the vegetation clearance crews. Additionally, the Wildfire Mitigation and Reliability Engineer reviews the results of patrol inspections as well as other vegetation inspections to determine if there are systemic issues that must be addressed. Finally, the results of Detailed Inspections are cross checked against other vegetation inspections to evaluate the quality and effectiveness of each inspection type.

Frequency or Trigger

Circuit Patrol will be performed on a circuit-by-circuit basis at least once per year directed by GO 165. BVES has an emergency response plan in effect that prioritizes circuits serving key public agencies such as hospitals, emergency response services, etc. Circuits will be patrolled in order of priority to ensure public safety and reliability.

Accomplishments and Updates

BVES completed patrol inspections on all of the service territory in 2022. Additionally, BVES fully transitioned into using a new inspection enterprise system (iRestore). iRestore provides better documentation of all identified vegetation issues by providing an exact geospatial location and high-resolution pictures. This helps reduce response time for vegetation crew when tasked with correcting the issue.

Roadblocks

Environmental issues such as snow and ice can often affect detailed inspection. This can delay inspections for accessibility and safety reasons.

8.2.2.3 UAV HD Photography/Videography Inspection (Tracking ID: GD_27 – GD_28 – VM_3)

Process

BVES conducts an annual UAV HD Photography/Videography inspection. This initiative is a high-definition (HD) imagery aerial survey of BVES's sub-transmission and distribution facilities and power lines inspection of rights-of-way and adjacent vegetation that may be hazardous, which exceeds or otherwise go beyond those mandated by rules and regulations, in terms of frequency, inspection checklist requirements or detail, analysis of and response to problems identified, or other aspects of inspection or records kept. This relatively quick and accurate inspection will allow BVES to verify, document and resolve vegetation encroachment and overheating and degrading equipment issues before they make contact with bare conductors.

Frequency or Trigger

BVES performs a UAV HD Photography/Videography survey of all of its circuits each year. It takes an expert contractor approximately six weeks to conduct the inspection and document the findings of the entire BVES system (211 circuit miles of overhead facilities and power lines). BVES does prioritize completing the UAV HD Photography/Videography Survey prior to the fire season Santa Ana wind period.

Accomplishments and Updates

In 2022, BVES completed UAV HD Photography/videography inspections on all of the service territory. A contractor put all of the photographs and data through a QA/QC analysis. A detailed report was provided to BVES of all potential defects. Once received BVES prioritized the potential defects and made repairs where it was necessary. In 2023, BVES is planning for the UAV inspection program to identify connection devices throughout the system.

Roadblocks

Environmental issues such as snow and ice can affect the ability of the UAV inspection teams to access some areas during certain times of the year. Concerned customers that do not want drones flying near/around their property have also delayed the inspection. Most of the time, a resolution can be found and the inspection continues.

8.2.2.4 LiDAR Inspection (Tracking ID: VM_4 – GD_29)

Process

BVES conducts one LiDAR sweep per year to evaluate the effectiveness of clearance efforts and identify potential wildfire hazards. This is an enhanced inspection using LiDAR (Light Detection and Ranging) inspections and analysis, which uses a system of lasers and software to develop surveys of the overhead sub-transmission and distribution systems, to accurately determine vegetation clearances to conductors. BVES began using LiDAR through a pilot project initiative using both helicopter and fixed wing flights, as well as via a truck-mounted mobile system. Given the proximity of the majority of BVES's electrical system to the road network and the tree canopy that is typical of distribution systems, truck-mounted mobile LiDAR will be utilized more often because it is more effective.

LiDAR survey findings are rated in accordance with GO 95 Rule 18 (level 1, 2, or 3) and entered into the distribution inspection GIS database. Level 1 findings are reported immediately to the Field Operations Supervisor who will direct corrective action as soon as possible to resolve the issue or reduce its severity to Level 2 so that more time is available to perform permanent corrective action. When BVES receives the LiDAR survey report, each finding is investigated by qualified personnel in evaluating vegetation clearances around power lines to validate the actual conditions and reassign the priority per GO 95, if deemed appropriate. The LiDAR contractor will immediately inform BVES of any level 1 findings so they may be corrected or resolved to a level 2 or 3 finding as soon as possible.

The Wildfire Mitigation and Reliability Engineer reviews the results of LiDAR surveys and assigns corrective action to the vegetation clearance crews. Additionally, the Wildfire Mitigation and Reliability Engineer reviews the result of LiDAR surveys as well as other vegetation inspections to determine if there are systemic issues that must be addressed. Finally, the results of LiDAR surveys are validated against other vegetation inspections to evaluate the quality and effectiveness of each inspection type. Frequency or trigger

BVES performs a LiDAR survey of all circuits each year. It takes its expert contractor approximately two weeks to gather LiDAR data on the entire BVES system (211 circuit miles of overhead facilities and power lines).

Accomplishments and Updates

In 2022, BVES completed LiDAR inspections on all of the service territory. Since BVES began LiDAR inspection in 2020, vegetation density around the power lines has significantly reduced. In 2020, the LiDAR inspection measured 25.44% vegetation density. In 2022, vegetation density had been reduced down to 19.82%. The contractor that conducts the UAV LiDAR inspection has acquired approval from the Federal Aviation Administration (FAA) to fly a fixed wing drone without line of sight. This new technique will significantly increase the speed at which the inspection will be conducted.

Roadblocks

BVES utilizes a vehicle mounted LiDAR system for a majority of the inspection. For the areas not accessible by road, BVES has had to use a UAV that was operated only by line of sight. This made inspection of these areas very difficult and time consuming.

8.2.2.5 3rd Party Ground Patrol Inspection (Tracking ID: VM_5 – GD_30)

Process

BVES conducts an annual 3rd Party Ground Patrol Inspection. This inspection is conducted by a contracted 3rd party satisfies GO 165 patrol inspection requirements and is in effect an additional annual GO 165 patrol inspection to the one that the BVES's Field Inspector performs as described in **Section 8.2.2.2**. BVES contracts experienced and qualified electrical distribution vegetation inspection contractors to perform this ground patrol inspection. The 3rd Party Ground Patrol Inspection is a careful, visual inspection of overhead electric distribution lines and equipment along rights-of-way that is designed to identify obvious hazards. This includes careful examination of individual pieces of equipment and structures to determine the condition of each rated and recorded component and vegetation clearances to bare conductor and other components.

3rd Party Ground Patrol Inspection findings are rated in accordance with GO 95 Rule 18 (Level 1, 2, or 3) and entered into the distribution inspection GIS database. Level 1 findings are reported immediately to the Field Operations Supervisor who will direct corrective action as soon as possible to resolve the issue or reduce its severity to Level 2 so that more time is available to perform permanent corrective action.

The Wildfire Mitigation and Reliability Engineer reviews the results of the 3rd Party Ground Patrol Inspections and assigns corrective action to the vegetation clearance crews. Additionally, the Wildfire Mitigation and Reliability Engineer reviews the results of the 3rd Party Ground Patrol Inspections, as well as other vegetation inspections, to determine if there are systemic issues that must be addressed. Finally, the results of the 3rd Party Ground Patrol Inspections are validated against other vegetation inspections to evaluate the quality and effectiveness of each inspection type

Frequency or Trigger

BVES performs a 3rd Party Ground Patrol Inspection of all its circuits each year. It takes its expert contractor approximately three weeks to conduct the inspection and document the findings of the entire BVES system. BVES prioritizes completing the 3rd Party Ground Patrol Inspection prior to the fire season Santa Ana wind period.

Accomplishments and Updates

In 2022, BVES completed a 3rd Party Ground Patrol Inspection on the entirety of the service area. All of the findings were reinspected by BVES crews to determine a remedy. No updates are planned for future inspections.

Roadblocks

Access issues to property and government land caused minor delays for the inspection teams. All of the issues were able to be resolved in a timely manner and the inspections were completed on time.

8.2.2.6 Substation Inspection (Tracking ID: VM_6 – GD_32)

Process

Monthly inspections of the BVES substations in compliance with the State of California G.O. 174 recommendations. The inspection will include a detailed visual examination and written record of all components pertaining to the 34kV/4kV substations, as well as if vegetation growth and encroachment has occurred. Any sign of growth or encroachment that does not meet GO 174 will be removed.

Frequency or Trigger

BVES conducts monthly inspections of all substations in the service territory. As security cameras are installed and connected to SCADA at the substation, visual inspection via feed could act as a trigger for vegetation management action. These cameras have not yet been installed and connected to SCADA.

Accomplishments and Updates

In, 2022 BVES completed monthly inspections on all substations in the service territory. All vegetation issues identified in the inspections were corrected in a timely manner. No updates are planned for future inspections.

Roadblocks

Environmental issues such as snow and ice can affect the access to substations in the winter months. No inspections were past due in 2022.

8.2.2.7 AiDash (Tracking ID: VM_19)

Process

BVES is using AiDash software to provide a complementary review of its vegetation management around electrical lines and equipment. AiDash uses satellite imaging to provide a rapid assessment of BVES's service territory and insight into vegetation that should be assessed or moved up in priority for upcoming patrol, detailed, or third party ground inspections. This assessment will allow BVES to understand the complete state of its service territory at a glance.

Frequency or Trigger

BVES is currently using AiDash to complement its existing Vegetation Management programs. AiDash will not be used as a standalone program but to validate and escalate the inspection schedules of the existing programs. The satellite inspection will be conducted once per year. Additional satellite inspections may be conducted as deemed necessary (e.g., if the fire season is expected to be more severe than it normally is or vegetation management activities fall behind targets, etc.).

Accomplishments and Updates

BVES conducted the first survey of its service territory with AiDash in 2023. The results of the survey indicated 3.5 circuit miles of overhead lines should be prioritized for inspection due to potential issues. These circuits were already the next circuits to be inspected and trimmed on the cycle schedule which acted as validation for its initial survey. BVES will continue to use AiDash in 2024 and provide additional updates in its 2026-2028 Base WMP.

Roadblocks

BVES has currently not identified any roadblocks for this program. If BVES experiences any roadblocks in 2024 it will identify and document them in its 2026-2028 Base WMP.

8.2.3 Vegetation and Fuels Management

In this section, the electrical corporation must discuss the following mitigation initiatives associated with vegetation and fuel management:

1. *Fuels management*
2. *Clearance*

3. *Fall-in mitigation*
4. *Substation defensible space*
5. *High-risk species*
6. *Fire-wise right-of-way*
7. *Emergency response vegetation management*

In the following subsections, the electrical corporation must provide an overview of its vegetation and fuels management initiatives. These overviews should include figure(s) that depict the workflow and decision process used for vegetation and fuels management. Figure 8-3 provides an example of the appropriate level of detail for tree trimming and removal.

In addition to figure(s), the electrical corporation must provide a narrative overview of each vegetation and fuels management initiative. The discussion must include the following:

- *Utility Initiative Tracking ID.*
- *Overview of the initiative: A brief description of the initiative including reference to related objectives and targets*
- *Governing standards and electrical corporation standard operating procedures: Reference to the appropriate code and electrical corporation procedure. If any standard exceeds regulatory requirements, the electrical corporation must reference the document that the electrical corporation uses as a basis for exceeding the regulatory requirements.*
- *Updates to the initiative: Changes to the initiative since the last WMP submission and a brief explanation as to why those change were made. Discuss any planned improvements or updates to the initiative and the timeline for implementation.*

BVES routinely engages in fuels removal activities within the right-of-way to maintain forest health and target overgrown and scattered vegetation that potentially threaten to encroach within vegetation clearance specifications during vegetation management inspections according to PRC 4292 requirements.

Fuels reduction is a key element to wildfire mitigation. BVES's vegetation clearance contractor clears vegetation and removes all vegetation waste and slash from the area. If the property owner wants the vegetation waste (for firewood, chipping, etc.), the contractor will assist the property owner in removing the vegetation waste from the rights-of-way for their use. BVES collaborates with the US Forest Service to remove trees near lines and removes the slash as agreed upon by the local US Forest Ranger.

BVES also conducts vegetation clearance including fuel management and removal of fuels along its power lines according to GOs and applicable standards, regardless of area. Additionally, BVES recognizes the community imperative to carry out these activities in a manner that meets or exceeds the requirements, especially in higher risk areas. BVES conducts vegetation management on a cycle schedule. However, BVES conducts inspections of high-risk areas and will divert crews from the cycle schedule on a priority basis to remedy any issues found in the inspections. Fuel management in the right-of-way in high-risk areas are prioritized for removal as they are identified. Vegetation waste from clearance activities is removed from the right-of-way as well as slash within or near the right-of way.

Since the 2022 WMP, BVES has committed to exchanging information with other utilities to determine best practices for slash removal vegetation management activities. Additionally, the iRestore app was implemented into vegetation management activity tracking. BVES will continue to consider additional improvements to its vegetation management program.

8.2.3.1 Pole Clearing (VM_7)

In this subsection, the electrical corporation must provide an overview of fuel management activities, including:

- Pole clearing per Public Resources Code section 4292
- Pole clearing outside the requirements of Public Resources Code section 4292 (e.g., pole clearing performed outside of the State Responsibility Area)

BVES has a vegetation management plan in place that meets or exceeds the PRC 4292. Mowbray's Tree Service Inc., a third-party contractor, executes the vegetation clearing efforts under the direction of BVES. The contractor's work is subject to BVES QA and QC checks. The goal of this plan is to proactively maintain vegetation, so it does not encroach electrical infrastructure, thereby preventing wildfires.

Base of Poles/Structures: For poles or structures that have non-exempt equipment per CALFIRE requirements, all flammable material and vegetation in a 10-foot radius around the base of the pole or structure shall be cut down and removed during each normal vegetation management cycle clearance visit. Exceptions per the effective California Power Line Fire Prevention Field Guide are authorized. BVES also clears around exempt poles, where possible. With the complete replacement of its traditional overhead expulsive fuses, nearly all of BVES's poles are now exempt from PRC 4292.

The utility created the vegetation management plan with wildfire prevention in mind, collaborating with the City of Big Bear Lake, local Fire Departments, and the USFS. The plan will be reviewed and updated on an as needed basis not to exceed three years, depending on changing conditions. The program includes three components: preventative vegetation management, corrective vegetation clearance, and emergency vegetation clearance. Each of these components needs to adhere to the designated specifications, such as with PRC 4292.

Updates to this Initiative:

BVES has not made changes since the last WMP submission. Currently, BVES evaluation demonstrates that there is no need to update the initiative.

8.2.3.2 Wood Slash Management (VM_8)

In this subsection, the electrical corporation must provide an overview of how it manages all downed wood and "slash" generated from vegetation management activities, including references to applicable regulations, codes, and standards.

BVES routinely engages in fuels removal activities within the right-of-way to maintain forest health and target overgrown and scattered vegetation that potentially threaten to encroach within vegetation clearance specifications during vegetation management inspections.

Fuels reduction is a key element to wildfire mitigation. BVES's vegetation clearance contractor clears vegetation and removes all vegetation waste and slash from the area every day. If the property owner wants the vegetation waste (for firewood, chipping, etc.), the contractor will

assist the property owner in removing the vegetation waste from the rights-of-way for their use. BVES also collaborates with the US Forest Service to remove trees near lines and removes the slash as agreed upon by the local US Forest Ranger.

BVES will continue to evaluate the effectiveness of its Wood Slash Management Program and make updates as needed.

Updates to this Initiative:

BVES has not made changes since the last WMP submission. Currently, BVES evaluation demonstrates that there is no need to update the initiative.

8.2.3.3 Clearance (VM_9)

In this subsection, the electrical corporation must provide an overview of clearance activities, including:

- *Clearances established more than the minimum clearances in Table 1 of GO 95*
- *The bases for the clearances established*

BVES has a vegetation management plan in place that meets or exceeds the minimum requirements of the CPUC's applicable GOs. Mowbray's Tree Service Inc., a third-party contractor, executes the vegetation clearing efforts under the direction of BVES. The contractor's work is subject to BVES QA and QC checks. The goal of this plan is to proactively maintain vegetation, so it does not contact electrical infrastructure, thereby preventing wildfires. The utility created the vegetation management plan with wildfire prevention in mind, collaborating with the City of Big Bear Lake, local Fire Departments, and the USFS. The plan will be reviewed and updated on an as needed basis not to exceed three years, depending on changing conditions. The program includes three components: preventative vegetation management, corrective vegetation clearance, and emergency vegetation clearance. Each of these components needs to adhere to particular specifications, detailed below.

Preventative Vegetation Management: This scope of work encompasses ensuring vegetation on BVES overhead sub-transmission and distribution lines adheres to identified clearance specifications.

Corrective Vegetation Clearance: This scope of work consists of completing corrective and emergent vegetation orders to fix clearance discrepancies that the contractor or BVES discovers. If an order is designated as High Priority, the contractor must prioritize that work and make the correction immediately.

The BVES vegetation management contract also contains many provisions to reduce the accumulations of brush and trees waste that may become fuel for wildfires:

- The Contractor is required to remove all wood and wood products and any other wastes generated by the requested service on a daily basis.
- Other requirements related to temporary slash piles, and proper disposal of wood and wood product waste according to applicable laws, rules, and regulations.
- Removal of all dead and rotting trees as well as those with the potential to fall on lines, even if they are outside the required clearance zone.

As mentioned above, all vegetation management work must adhere to certain specifications, as outlined by BVES. The utility-defined specifications comply with or exceed those outlined in GO 95, Rules for Overhead Electric Line Construction, Rule 35 Vegetation management, and Appendix E Guidelines to Rule 35 and Commission Decisions, such as D.17-12-024. As previously described, BVES has unique local conditions that require it, in certain circumstances, to go beyond the regulated vegetation clearance standards. These enhanced specifications include:

Radial Clearances: Vegetation that is within the minimum 72-inch safe clearance distance will be trimmed to at least 12 feet in accordance with Appendix E Guidelines to Rule 35 of GO-95. Considering vegetation species and growth rates and characteristics, BVES's contractor will even trim beyond 12 feet if necessary to help to ensure that the vegetation remains outside the minimum 72-inch safe clearance distance for the entire length of the vegetation management program cycle (3-years).

Vegetation that is outside the minimum 72-inch safe clearance distance, but expected, to encroach the 72-inch safe clearance distance prior to the next scheduled preventative vegetation management visit (normally 3 years), taking into account vegetation species and growth rates and characteristics, will be trimmed to at least 12 feet in accordance with Appendix E Guidelines to Rule 35 of GO-95. BVES's contractor will even trim beyond 12 feet if necessary to help to ensure that the vegetation remains outside the minimum 72-inch safe clearance distance for the entire length of the vegetation management program cycle (3-years), based upon species, growth rate, site characteristics.

In so far as possible, trimming shall be designed to achieve the appropriate clearance from the power lines without damaging the structural integrity or health of the tree(s).

Blue Sky Requirement: No vertical coverage shall be allowed above BVES sub-transmission lines (34.5 kV).

Drip Line: All vegetation within the drip line of primary conductors that has the potential of growing into the secondary system or within 12 feet of the energized primary conductors within the 3-year vegetation management program cycle will be removed.

Tree Removal: Trees that are dead, rotten, or diseased, or dead, rotten, or diseased portions of otherwise healthy trees which overhang or lean toward and may fall into a span of power lines, should be removed. Note that this may apply to trees outside the clearance zone (for example, a dead tree across the street may pose a danger to BVES power lines).

Tree Trunk and Major Limb Exception: BVES has developed a flowchart for Field Personnel to use in determining the appropriate action for trees and major limbs in close proximity to bare conductors. If there is a mature tree whose trunk or major limb is within 48 inches of bare conductors, the following action is to be taken:

If the tree or major limb is within 12 inches of the bare conductors regardless of thickness at conductor level, this is a Level 1 discrepancy and shall be immediately remediated by:

- Removing the tree or limb immediately, or
- Installing a tree guard on the line to prevent the tree or limb from contacting the bare conductors and designating the discrepancy as a Level 2 discrepancy to be corrected by removing the tree within 6 months.

If the tree or major limb is less than 6 inches thick at conductor level, then the tree or major limb must be trimmed or removed to achieve 72 inches clearance from bare conductors as follows:

- If there are no burn marks or evidence of the tree or limb contacting bare conductors and the clearance is greater than 48 inches, then this is a Level 2 discrepancy and shall be corrected within 12 months.
- If there are no burn marks or evidence of the tree or limb contacting bare conductors and the clearance is less than 48 inches but greater than 18 inches, then this is a Level 2 discrepancy and shall be corrected within 180 days. A tree guard should be installed as soon as operationally possible.
- If there are burn marks or evidence of the tree or limb contacting bare conductors and/or the clearance is less than 18 inches, then this is a Level 1 discrepancy and shall be immediately remediated by:
 - Removing the tree or limb immediately, or
 - Installing a tree guard on the line to prevent the tree or limb from contacting the bare conductors and designating the discrepancy as a Level 2 discrepancy to be corrected by removing the tree within 6 months.

If the tree or major limb is greater than 6 inches thick at conductor level and greater than 12 inches from bare conductors, then the tree or major limb shall be evaluated to determine if an exemption per GO-95 Rule 35 may be applied. Take the following action:

- If there are burn marks present on the tree or major limb or evidence of the tree or limb contacting the bare conductor, this is a Level 1 discrepancy and shall be immediately remediated by:
 - Removing the tree or major limb immediately, or
 - Installing a tree guard on the line to prevent the tree or limb from contacting the bare conductors and designating the discrepancy as a Level 2 discrepancy to be corrected by removing the tree within 6 months.
- If there are no burn marks present on the tree or major limb and no evidence of the tree or limb contacting the bare conductor, then the tree or major limb may be exempted provided the following:
 - Tree has been established in its current location for at least 10 years.
 - Tree trunk has a diameter at breast height (DBH) of at least 10".
 - Tree or limb at the conductor level is at least 6" in diameter.
 - Tree is not re-sprouting at conductor level during the time of inspection.
 - Tree is healthy and not otherwise hazardous.
 - Tree is not easily climbable. Note the tree clearance crew can remove branches to render a tree not easily climbable.
- If the tree cannot satisfy one or more of the above criteria, then the tree or major limb must be removed. It should be designated as a Level 2 discrepancy and shall be corrected within 12 months.
- If the tree satisfies all of the above criteria, then the tree may be exempted and remain in place. The tree shall be:
 - Documented on Major Woody Stem Form and approved by the Wildfire Mitigation & Reliability Engineer.
 - Tracked in the Company's GIS applications for vegetation management.
 - Re-evaluated each year.
 - As a precaution, install a tree guard when operationally feasible.

BVES will also consider the removal of any fast-growing trees, such as Poplars, Aspens, or Cottonwood, rotten or diseased trees, and healthy trees hanging over or leaning towards bare

lines. All such trees will be trimmed to 12 feet minimum and evaluated for removal in each case. This information will be tracked in BVES's tree tracking program.

Updates to this Initiative:

BVES has not made changes since the last WMP submission. Currently, BVES evaluation demonstrates that there is no need to update the initiative.

8.2.3.4 Fall-in Mitigation (VM_10)

In this subsection, the electrical corporation must provide an overview of its actions taken to remove or otherwise remediate trees that pose a high risk of failure or fracture that could potentially strike electrical equipment (e.g., danger trees or hazard trees).

BVES has a vegetation management plan in place that meets or exceeds the CPUC's applicable GOs. Mowbray's Tree Service Inc., a third-party contractor, executes the vegetation clearing efforts under the direction of BVES. The contractor's work is subject to BVES QA and QC. The goal of this plan is to proactively maintain vegetation, so it does not contact electrical infrastructure, thereby preventing wildfires. The utility created the vegetation management plan with wildfire prevention in mind, collaborating with the City of Big Bear Lake, local Fire Departments, and the USFS. The plan will be reviewed and updated on an as needed basis not to exceed three years, depending on changing conditions. The program includes three components: preventative vegetation management, corrective vegetation clearance, and emergency vegetation clearance. Each of these components adheres to specifications, detailed above (e.g., clearances in Section 8.2.3.3) and immediately below.

Tree Removal: Trees that are dead, rotten, or diseased, or dead, rotten, or diseased portions of otherwise healthy trees which overhang or lean toward and may fall into a span of power lines, should be removed. Note that this may apply to trees outside the clearance zone (for example, a dead tree across the street may pose a danger to BVES power lines).

Updates to this Initiative:

BVES has not made changes since the last WMP submission. Currently, BVES evaluation demonstrates that there is no need to update the initiative.

8.2.3.5 Substation Defensible Space (VM_11)

In this subsection, the electrical corporation must provide an overview of its actions taken to reduce the ignition probability and wildfire consequence due to contact with substation equipment.

This initiative aligns with requirements under GOs 165 and 174 for inspections of substations and involves the removal of vegetation in and around substations that may result in contact with bare conductors. The initiative is intended to reduce the likelihood of vegetation contacting bare conductor; thereby, reducing the probability of ignition. Substation vegetation clearance work is conducted in response to periodic (monthly) visual site inspection of each substation. Based on inspection results, vegetation task orders are provided to the qualified contractor. The contractor performs corrective and emergent vegetation orders to fix clearance discrepancies that BVES discovers. If an order is designated as High Priority, the contractor must prioritize that work and make the correction immediately.

Updates to this Initiative:

BVES has not made changes since the last WMP submission. Currently, BVES evaluation demonstrates that there is no need to update the initiative.

8.2.3.6 High-Risk Species (VM_12)

In this subsection, the electrical corporation must provide an overview of its actions, such as trimming, removal, and replacement, taken to reduce the ignition probability and wildfire consequence attributable to high-risk species of vegetation.

BVES has a vegetation management plan in place that meets or exceeds the minimum requirements of the CPUC's applicable GOs. Mowbray's Tree Service Inc., a third-party contractor, executes the vegetation clearing efforts under the direction of BVES. The contractor's work is subject to BVES QA and QC checks. The goal of this plan is to proactively maintain vegetation, so it does not contact electrical infrastructure, thereby preventing wildfires. The utility created the vegetation management plan with wildfire prevention in mind, collaborating with the City of Big Bear Lake, local Fire Departments, and the USFS. The plan will be reviewed and updated on an as needed basis not to exceed three years, depending on changing conditions. The program includes three components: preventative vegetation management, corrective vegetation clearance, and emergency vegetation clearance. Each of these components needs to adhere to particular specifications, detailed below.

BVES will consider the removal of any fast-growing trees, such as Poplars, Aspens, or Cottonwood, rotten or diseased trees, and healthy trees hanging over or leaning towards bare lines (note: due to its elevation and climate, BVES does not have palm or eucalyptus trees present). All such trees will be trimmed to at least 12 feet minimum (or more if warranted) and evaluated for removal in each case. BVES's contractor may determine that additional clearance would be prudent based on growth factors, wind, ice, etc. This information will be tracked in BVES's tree tracking program.

Updates to this Initiative:

BVES has not made changes since the last WMP submission. Currently, BVES evaluation demonstrates that there is no need to update the initiative.

8.2.3.7 Fire-Resilient Right-of-Ways (VM_13)

In this subsection, the electrical corporation must provide an overview of its actions taken to promote vegetation communities that are sustainable, fire-resilient, and compatible with the use of the land as an electrical corporation right-of-way. It must also provide an overview of its actions to control vegetation that is incompatible with electrical equipment and with the use of the land as an electrical corporation right-of-way. This may include, but is not limited to, the following activities: the strategic use of herbicides, growth regulators, or other chemical controls; tree-replacement programs; promotion of native shrubs; prescribed fire; or fuel treatment activities not covered by another initiative.

BVES has a vegetation management plan in place that meets or exceeds the applicable minimum requirements of the CPUC's GOs. Mowbray's Tree Service Inc., a third-party contractor, executes the vegetation clearing efforts under the direction of BVES. The contractor's work is subject to BVES QA and QC checks. The goal of this plan is to proactively maintain vegetation, so it does not encroach electrical infrastructure, thereby preventing wildfires. The utility created the vegetation management plan with wildfire prevention in mind, collaborating with the City of Big Bear Lake, local Fire Departments, and the USFS. The plan will be reviewed and updated on an as needed basis not to exceed three years, depending on

changing conditions. The program includes three components: preventative vegetation management, corrective vegetation clearance, and emergency vegetation clearance. Each of these components needs to adhere to specifications, detailed below.

Right-of-Way: All brush, limbs and foliage in the ROW shall be cut up to 8-feet above the ground. All dead, dying, diseased, or dried vegetation from 8 feet above the ground to the top of the power lines must be removed during each normal vegetation management cycle clearance visit. This requirement is applicable to all ROWs in the HFTD Tier 3 and to all ROWs in the HFTD Tier 2 designated as having high strike potential by the Wildfire Mitigation & Safety Engineer. Exceptions per the effective California Power Line Fire Prevention Field Guide are authorized.

Updates to this Initiative:

BVES has not made changes since the last WMP submission. Currently, BVES evaluation demonstrates that there is no need to update the initiative.

8.2.3.8 Emergency Response Vegetation Management (VM_14)

In this subsection, the electrical corporation must provide an overview of the following emergency response vegetation management activities:

- *Activities based on weather conditions:*
- *Planning and execution of vegetation management activities, such as trimming or removal, executed based on and in advance of a Red Flag Warning or other weather condition forecast that indicates an elevated fire threat in terms of ignition probability and wildfire potential.*
- *Post-fire service restoration:*
- *Vegetation management activities during post-fire service restoration, including, but not limited to, activities or protocols that differentiate post-fire vegetation management from programs described in other WMP initiatives; supporting documentation for the tool and/or standard the electrical corporation uses to assess the risk presented by vegetation after a fire; and how the electrical corporation includes fire-specific damage attributes in its assessment tool/standard. The description of such activities must differentiate between those emergency actions initiated to restore power while active fire suppression is ongoing and actions that occur following active fire suppression during the post-fire suppression repair and rehabilitation phases of fire protection operations.*

BVES has a vegetation management plan in place that meets or exceeds the minimum requirements of the CPUC's applicable GOs. Mowbray's Tree Service Inc., a third-party contractor, executes the vegetation clearing efforts under the direction of BVES. The contractor's work is subject to BVES QA and QC checks. The goal of this plan is to proactively maintain vegetation, so it does not come into contact with electrical infrastructure, thereby preventing wildfires. The utility created the vegetation management plan with wildfire prevention in mind, collaborating with the City of Big Bear Lake, local Fire Departments, and the USFS. The plan will be reviewed and updated on an as needed basis not to exceed three years, depending on changing conditions. The program includes three components: preventative vegetation management, corrective vegetation clearance, and emergency vegetation clearance. Each of these components needs to adhere to particular specifications, detailed below.

Emergency Vegetation Clearance: This scope of work includes completing maintenance on an as needed basis for any major disaster or emergency events. For example, if a storm results in

fallen trees and branches, the contractor must mobilize as soon as possible to clear the vegetation.

While BVES has not experienced a significant fire, it remains prepared to respond quickly in the event an ignition source impacts adjacent vegetation or threatens public access. BVES will continue conversations with CAL FIRE, other utilities, and vegetation contractors to develop a list of preparations that would be beneficial to have in place in the event the service area experiences a wildfire.

Updates to this Initiative:

BVES has not made changes since the last WMP submission. Currently, BVES evaluation demonstrates that there is no need to update the initiative.

8.2.4 Vegetation Management Enterprise System (VM_15)

In this section, the electrical corporation must provide an overview of inputs to, operation of, and support for a centralized vegetation management enterprise system updated based upon inspection results and management activities such as trimming and removal of vegetation. This overview must include discussion of:

- *The electrical corporation's vegetation inventory and condition database(s)*
- *Describe the utilities internal documentation of its database(s)*
- *Integration with systems in other lines of business*
- *Integration with the auditing system(s) (see Section 8.2.5, "Quality Assurance and Quality Control").*
- *Describe internal processes for updating enterprise system including database(s) and any planned updates*
- *Any changes to the initiative since the last WMP submission and a brief explanation as to why those changes were made. Include any planned improvements or updates to the initiative and timeline for implementation*

BVES is implementing a new vegetation management enterprise system in 2023 created specifically to meet BVES needs. The program is called "iRestore Tree Action Inventory Application." This application allows BVES to catalog every tree within the service territory and document a list of data of each tree. The database will include information on circuit, GPS coordinates, address, species of tree, height of tree, all inspection and trim history, pictures of the tree before and after and work is conducted, and individual tree ID numbers. Additional features include mobile device data acquisition, documentation of asset inspection findings, assignment of resolution priority, tracking status of resolution, and high-level finding analysis to determine if systemic issues exist.

The vegetation management crews have access to the database through iPads and mobile phones to document all the above inputs on all work completed. BVES pre-inspectors also have access to the database and enter all inspections into the database. The information from iRestore is also migrated into BVES's GIS database. In the next update of the application, QA/QC reviews and information will be integrated into the application. Once completed, iRestore will have QA/QC integrated into the application. As a new application, BVES expects iRestore will require frequent updates to create a better inventory system usable and visible by all necessary BVES staff.

Data Source	Storage Location	Planned Next Steps	Storage Type (Excel, GIS, etc.)
Vegetation Management	Partners & Spreadsheet Database	Migration to iRestore (cloud-based) software Oct. 2022	Excel, Geo Database

The iRestore tree database creates a unique ID for each tree and holds extensive data on each tree (such as species, height, condition, etc.). The database will provide real-time vegetation inspection data available to users, trimming status, geolocation, among other things. The software will provide alerts on trees that require revisiting based on growth rates. Additionally, the software will alert when a tree is about to exceed its review time based on the cycle schedule. This database is expected to be fully up and running by the end of 2023. BVES is also considering tagging trees with tags that electronically connect with mobile devices that crews and inspectors would use to enhance accuracy of data recording.

8.2.5 Quality Assurance / Quality Control (QA/QC) (VM_16)

In this section, the electrical corporation must provide an outline of its quality assurance and quality control (QA/QC) activities for vegetation management. This overview must include:

- *Reference to procedures documenting QA/QC activities.*
- *How the sample sizes are determined and how the electrical corporation ensures the samples are representative.*
- *Who performs QA/QC (internal or external, is there a dedicated team, etc.).*
- *Qualifications of the auditors.*
- *Documentation of findings and how the lessons learned from those findings are incorporated into trainings and/or procedures.*
- *Any changes to the procedures since the last WMP submission and a brief explanation as to why those changes were made. Include any planned improvements or updates to the initiative and the timeline for implementation.*
- *Tabular information:*
- *Sample sizes*
- *Type of QA/QC performed (e.g., desktop or field)*
- *Resulting pass rates, starting in 2022*
- *Yearly target pass rate for the 2023-2025 Base WMP cycle*

Table 8-18 provides an example of the appropriate level of detail.

Table 8-18 Vegetation Management QA/QC Program

Activity Being Audited	Sample Size	Type of Audit	Audit Results 2022	Yearly Target Pass Rate for 2023-2025
Tree Trimming by contractor	132 inspections completed in 2022 (1,419 Trees)	Verify Contractor's Tree Trimming meets standards	Completed (99% pass rate for trees inspected)	99%

The objective of BVES's vegetation management QA/QC program is to promote consistent and effective vegetation management action by establishing an oversight and audit process to review the work completed by employees or contractors, including packaging QA/QC information for input to decision-making and workforce management processes. This initiative includes the identification and actionable outcomes of deficiencies and inspection protocols executed in the field. This will support improvement of work outcomes, training of personnel involved in vegetation management, and applying lessons learned from internal and external evaluations and audits.

Quality Assurance

In 2023, BVES aims to improve vegetation management inspection by conducting QA assessments and audits per BVES QA/QC procedures. In 2022, BVES set a target to conduct four quarterly QA assessments, and one annual program audit. Quarterly audits were conducted by the Wildfire Mitigation and Reliability Engineer, and the annual program audit by the contracted Forester. The qualifications for these individuals are described in Table 8-20.

The quarterly QA assessments included the following:

- Brief narrative on the status of the VM program, VM QC checks program and analysis or commentary on the metrics below as applicable.
- Number of trees trimmed as a result of the vegetation management program.
- Number of trees removed as a result of the vegetation management program.
- Number of Level 1 vegetation discrepancies identified.
- Number of Level 1 vegetation discrepancies resolved.
- Number of Vegetation Orders issued.
- Number of Vegetation Orders resolved.
- Any accidents, incidents, or near misses on the part of vegetation clearance personnel.
- Number of outages where vegetation made contact with power lines and caused the outage (break out those outages where vegetation clearance was in violation of standards).
- List of VM QC Checks performed (includes name of evaluator and date performed).
- List of significant findings from VM QC checks.
- Service area map showing where contractor worked in the quarter and where contractor will work in the next quarter.
- Where the contractor is in the vegetation cycle plan (e.g., percent complete).
- Corrective action taken on issues noted in previous Quarterly VM Program Assessments.

- Other items that would be useful to Management regarding vegetation management.

Additionally, an annual QA audit is conducted by the Forester in January of each year covering the previous calendar year. The audit provides a comprehensive review of the VM Program covering, at a minimum, the areas and questions specified in the table below, VM Program Annual QA Audit Areas.

BVES Table 8-6 VM Program Annual QA Audit Areas

VM Program Annual QA Audit Areas	
VM Line Clearance	Is the VM program effective at ensuring vegetation meets required clearance specifications?
	Is the VM program on track with the program schedule?
	Is the VM program effective in reducing vegetation contact with bare conductors?
	Are any changes to the VM clearance standards delineated in Section 3 necessary?
	Is the VM clearance contractor(s) executing work in accordance with the VM contract(s)?
	Are changes to the VM Contract Scope of Work needed?
VM Inspections	Are VM inspections (patrol, detailed, LiDAR, etc.) conducted in accordance with the Company's effective Wildfire Mitigation Plan?
	Are the results of VM inspections documented, tracked, and resolved in a timely manner in accordance with GO-95 Rule 18?
	For each type of inspection performed, assess whether the inspection is effective and useful to assisting in achieving VM program objectives?
	Should additional inspections be performed?
	Is the scheduling of inspections appropriate or should the schedule be modified?
VM QC Checks	Are VM QC checks performed in accordance with the requirements of this policy and procedure (Section 5.3)?
	Are personnel performing VM QC checks sufficiently knowledgeable and qualified to perform the checks?
	Are VM QC checks documented?

	Are discrepancies identified in VM QC checks being tracked and resolved in a timely manner in accordance with GO-95 Rule 18?
	Are VM QC checks effective at identifying vegetation clearance issues?
	Should modifications to Appendix B VM QC Check Instructions be made?
VM Quarterly Reports	Are the VM Quarterly Reports conducted per Section 4.1.24?
	Are the VM Quarterly Reports useful in providing management an assessment of the VM program?
	Should changes be made to the content or periodicity of the VM Quarterly Reports?
VM Program	Overall, are the Company's VM Program objectives achieved?
	Are changes recommended to the VM Program Policy and Procedures?
	Are changes in the Company's execution of its VM Program warranted?

Quality Control

In 2023, BVES aims to continue to execute vegetation management QC per its vegetation management QC procedures. In 2022, BVES set a QC target to conduct 72 QC reviews, more specifically 18 QC reviews per quarter. BVES selected 72 as its annual target based off of its qualified staff availability (6 individuals conducting at minimum 1 QC review a month) and wanting to maintain regularity of review. QC reviews are to be conducted by qualified staff designated in the BVES vegetation management procedures manual. Quarterly audits will be conducted by the Wildfire Mitigation and Reliability Engineer, and the annual program audit by the contracted Forester (BVES staff qualifications are discussed in Section 8.2.7).

QC reviews check the quality of recent vegetation clearance activities. Staff assigned vegetation management QCs receive a GIS map that illustrates the specific trees trimmed or removed and the pole numbers for each pole in assigned QC area. The assigned staff then go to the assigned area and inspect the assigned area to determine whether the contractor cleared the vegetation surrounding the lines in accordance with BVES vegetation clearance specifications. The staff utilize a checklist to conduct the QC and document the results in an online application used to manage, document, and archive vegetation management QCs. Discrepancies are forwarded to the vegetation management contractor to resolve. Additionally, the vegetation management QC application collects QC finding results and allows for analysis of potential systemic issues.

BVES conducts frequent QC checks of its vegetation contractor's work execution. Discrepancies noted during QC checks, detailed inspections, patrols of overhead circuits, or other means, are generally forwarded to contracted resource via the Kintone Tree Trimming QC application provided by BVES. The contractor responds by marking whether completion of corrective actions is achieved through the software database. Additionally, the contractor

documents the vegetation trimming activities performed in the utility right-of-way application to BVES' Partner Software (part of BVES' GIS suite). Discrepancies are designated and corrected as follows:

1. Emergency (Priority 1) vegetation orders will be corrected immediately (or mitigated to reduce the priority level to at least Priority 2).
2. Urgent (Priority 2) vegetation orders will be corrected within 30 days.
3. Routine (Priority 3) vegetation orders will document non-urgent items that will be addressed during the regular tree trimming cycle.

BVES utilizes a tree trimming QC program, Kintone Tree Trimming, as part of its internal quality control for vegetation management activities. This database provides several fuel characteristics that are tracked for record-keeping and presents the number of trees targeted for remediation with those that have passed a QC review and those that have failed. This results in an efficiency rating based on parameters that align with General Order 95 Rule 35 and BVES's enhanced vegetation management practices.

BVES will monitor the results of its vegetation management QA/QC programs and implement improvements as warranted. BVES will also exchange information with other utilities to determine best practices in vegetation management QA/QC for consideration in BVES's program. Furthermore, BVES is in the process of implementing vegetation management inspection software, which will enhance the ability to document QCs and perform QA on vegetation management inspections.

8.2.6 Open Work Orders (VM_17)

In this section, the electrical corporation must provide an overview of the process it uses to manage its open work orders. This overview must include a brief narrative that provides:

- *Reference to procedures/programs documenting the work order process.*
- *Process for prioritization of work orders based on risk*
- *Process for eliminating a backlog of work orders (i.e., open work orders that have passed remediation deadlines), if applicable*
- *A discussion of trends with respect to open work orders*

In addition, each electrical corporation must graph open work orders over time as reported in the QDRs.

BVES uses General Order 95 (GO 95) Rule 18 requirements as guidance for managing and prioritizing open work orders. Work Orders are given priority levels and associated timeframes for completion. In the second quarter of 2023, BVES will move to using iRestore (Enterprise System) to track all open vegetation work orders. When a discrepancy is identified by the vegetation inspector, a work order is created and a severity level (Level 1, 2, or 3 in accordance with GO 95 Rule 18) is applied. The severity will dictate the timeframe for remediation. For vegetation related discrepancies timeframe and example situations are as follow:

- Level 1 – Immediate Action – Vegetation Order Issued to Contractor for Immediate Action
 - Vegetation contacting, nearly contacting or arcing to high voltage conductor, vegetation contacting low voltage conductor and compromising structure, etc.

- Level 2 – Action within 30 days – Vegetation Order Issued to Contractor for Action within 30 days
 - Vegetation within 48 inches of high voltage lines, vegetation causing strain or abrasion on low voltage conductor, tree or portions of tree that are dead, rotten, or diseased that may fall into power lines, etc.
- Level 3 – Non-urgent Normal Cycle Action – Vegetation Order issued to Contractor for Action during the next normal vegetation cycle

BVES prioritizes open work orders first by level of severity defined by GO 95 Rule 18, then by HFTD area for a specific level. For example, an HFTD 3 Level 2 work order is prioritized over an HFTD 2 Level 2 work order. Finally, BVES priorities work orders within each level and HFTD area by higher risk circuits per BVES's the Fire Safety Circuit Matrix described in Section 6.1. For example, Level 2 work orders within the HFTD 2 area are prioritized based on the level of risk circuits have per BVES's Fire Safety Circuit Matrix.

BVES will begin populating its vegetation work order enterprise system to track work orders in the second quarter of 2023. With this tracking ability from the enterprise system, BVES will have the ability to conduct work order trend analysis. Until this change, BVES cannot provide trend analysis on its work orders. Conducting such trend analysis will be part of the Wildfire Mitigation & Reliability Engineer routine. The trend analysis will be presented to management at periodic management meetings.

BVES does not currently have any past due work orders. If BVES were to have past due work orders, the issue would immediately be prioritized. Work orders approaching their due date as well as work orders that are past due will be automatically flagged to BVES Wildfire Mitigation & Reliability Engineer by the enterprise system once it is put into use in the second quarter of 2023.

Table 8-19 Number of Past Due VM Work Orders Categorized by Age

HFTD Area	0-30 Days	31-90 Days	91-180 Days	181+ Days
Non-HFTD	0	0	0	0
HFTD Tier 2	0	0	0	0
HFTD Tier 3	0	0	0	0

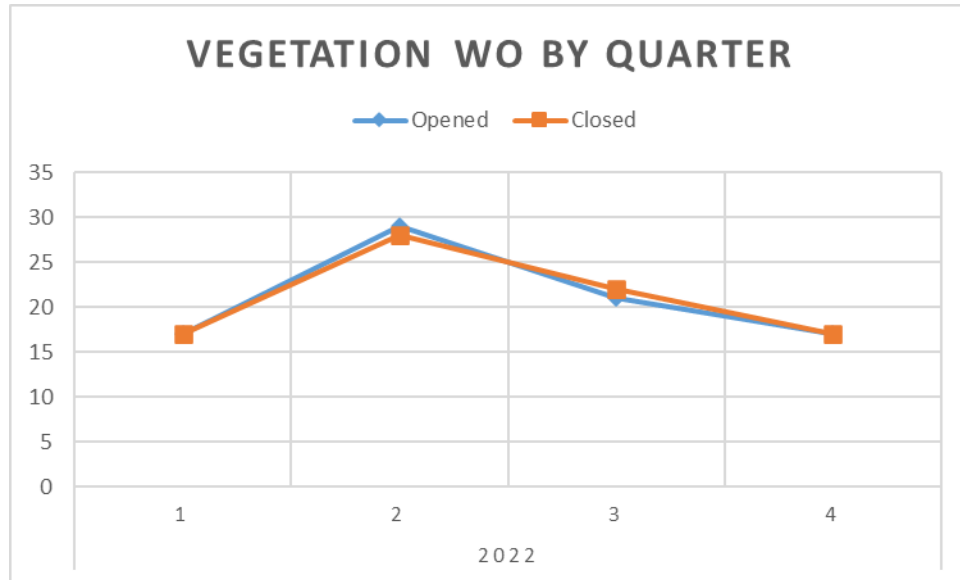

Figure 8-3 Vegetation Management Work Orders by Quarter

8.2.7 Workforce Planning (VM_18)

In this section, the electrical corporation must provide a brief overview of its recruiting practices for vegetation management personnel. It must also provide its worker qualifications and training practices for workers in the following target roles:

- *Vegetation inspections*
- *Vegetation management projects*

For each of the target roles listed above, the electrical corporation must:

- *List all worker titles relevant to the target role.*
- *List and explain minimum qualifications for each worker title with an emphasis on qualifications relevant to vegetation management. Note if the job requirements include the following:*
- *Special certification requirements, such as being an International Society of Arboriculture Certified Arborist with specialty certification as a Utility Specialist or a California-licensed Registered Professional Forester*
- *Additional training on biological resources identification and protection (e.g., plant and animal species and habitats); and cultural prehistoric and historic resources identification and protection*
- *Report the percentage of electrical corporation and contractor full-time equivalents (FTEs) in target roles with specific job titles.*

Table 8-20 Vegetation Management Qualifications and Training

Worker Type	Minimum Qualifications for Target Role	Special Certification Requirements	Electrical Corporation % FTE Min Quals	Electrical Corporation % Special Certifications	Contractor % FTE Min Quals	Contractor % Special Certifications	Reference to Electrical Corporation Training/Qualification Programs Improvements
Utility Engineer & Wildfire Mitigation Supervisor (BVES Employee)	<p>Bachelor's Degree in an engineering field or a technical discipline required.</p> <p>Eight years of planning, construction, or engineering experience including four years of administrative and supervisory experience. Utility experience preferred.</p> <p>Work experience in an area</p>	<p>Professional Engineer license in California required. If not held, must obtain within 2 years of employment.</p>	100%	100%	N/A	N/A	None required

Worker Type	Minimum Qualifications for Target Role	Special Certification Requirements	Electrical Corporation % FTE Min Quals	Electrical Corporation % Special Certifications	Contractor % FTE Min Quals	Contractor % Special Certifications	Reference to Electrical Corporation Training/Qualification Programs Improvements
	<p>with strong compliance regimes. Experience interacting with utility regulators and knowledge of regulatory processes preferred.</p> <p>Knowledge of overhead and underground line construction, substations, transformation, cabling, voltage drop, circuit protection and protection coordination, rules, rates and schedules, Company</p>						

Worker Type	Minimum Qualifications for Target Role	Special Certification Requirements	Electrical Corporation % FTE Min Quals	Electrical Corporation % Special Certifications	Contract or % FTE Min Quals	Contractor % Special Certifications	Reference to Electrical Corporation Training/Qualification Programs Improvements
	policies and procedures, service requirements, material management, electrical codes, budgeting and electrical theory and application.						
Wildfire Mitigation and Reliability Engineer (BVES Employee)	Bachelor of Science degree in Engineering, Mathematics, Physics, or other related technical discipline. Prior electric utility experience preferred.	N/A	100%	100%	N/A	N/A	None required

Worker Type	Minimum Qualifications for Target Role	Special Certification Requirements	Electrical Corporation % FTE Min Quals	Electrical Corporation % Special Certifications	Contractor % FTE Min Quals	Contractor % Special Certifications	Reference to Electrical Corporation Training/Qualification Programs Improvements
	<p>Understanding of statistical analysis and probabilistic methods preferred.</p> <p>Prior experience working with Enterprise Resource Planning (ERP) software or asset management software, Oracle based accounting systems, Outage Management Systems, Geographic Information Systems (GIS) and SCADA</p>						

Worker Type	Minimum Qualifications for Target Role	Special Certification Requirements	Electrical Corporation % FTE Min Quals	Electrical Corporation % Special Certifications	Contract or % FTE Min Quals	Contractor % Special Certifications	Reference to Electrical Corporation Training/Qualification Programs Improvements
	systems preferred.						
Field Inspector (BVES Employee)	<p>Three years of Journeyman Lineman or above experience.</p> <p>Experience inspecting overhead and underground facilities.</p> <p>Class C California Driver's License</p>	<p>IBEW Journeyman Lineman status in good standing</p> <p>Demonstrated knowledge and proficiency in GO 95, GO 128, and GO 165 requirements.</p>	100%	100%	N/A	N/A	None required
Utility Systems Specialist Inspector/Lead Inspector (Contractor)	Overhead Distribution and/or Transmission distribution inspection	NESC and ANSI Inspection experience (1-year min)	N/A	N/A	100%	100%	None required

Worker Type	Minimum Qualifications for Target Role	Special Certification Requirements	Electrical Corporation % FTE Min Quals	Electrical Corporation % Special Certifications	Contractor % FTE Min Quals	Contractor % Special Certifications	Reference to Electrical Corporation Training/Qualification Programs Improvements
	<p>experience (2-year min) Identification of all overhead equipment Current Driver License Computer and GIS mapping experience</p>	<p>Red Cross FA/CPR certified Wildfire Training</p>					
<p>Geospatial Project Manager (Contractor)</p>	<p>8 years of GIS and Remote Sensing Experience 5 years or more in a Supervisory Role Advanced Knowledge of LiDAR Sensors and Data</p>	<p>Geospatial Information Systems Professional (GISP)</p>	<p>N/A</p>	<p>N/A</p>	<p>100%</p>	<p>100%</p>	<p>ASPRS Certified Mapping Scientist, LiDAR</p>

Worker Type	Minimum Qualifications for Target Role	Special Certification Requirements	Electrical Corporation % FTE Min Quals	Electrical Corporation % Special Certifications	Contractor % FTE Min Quals	Contractor % Special Certifications	Reference to Electrical Corporation Training/Qualification Programs Improvements
	Advanced GIS Skills and Problem Solving						
Geospatial Lead Analyst (Contractor)	8 years of GIS and Remote Sensing Experience Strong Quality Control and Detail Advanced Knowledge of LiDAR Sensors and Data Advanced GIS Skills and Problem Solving	N/A	N/A	N/A	100%	N/A	ASPRS Certified Remote Sensing Technologist
Geospatial Technician (Contractor)	Solid Understand of GIS and Remote	N/A	N/A	N/A	100%	N/A	N/A

Worker Type	Minimum Qualifications for Target Role	Special Certification Requirements	Electrical Corporation % FTE Min Quals	Electrical Corporation % Special Certifications	Contractor % FTE Min Quals	Contractor % Special Certifications	Reference to Electrical Corporation Training/Qualification Programs Improvements
	Sensing Science Strong Attention to Detail Strong Computer Skills Work Independently						
Tree Trim General Foreman/Supervisor (Contractor)	5 years of line clearance tree pruning experience in a Foreman role Line clearance Certification Current California Driver License General Computer knowledge	ISA Certification Line-clearance qualified tree-trimmer	N/A	N/A	100%	100%	ISA Continuing Education Requirements

Worker Type	Minimum Qualifications for Target Role	Special Certification Requirements	Electrical Corporation % FTE Min Quals	Electrical Corporation % Special Certifications	Contractor % FTE Min Quals	Contractor % Special Certifications	Reference to Electrical Corporation Training/Qualification Programs Improvements
Tree Trimmer (Contractor)	Strong work ethic Current California Driver License (Class B permit) General computer skills	ISA Certification Line-clearance qualified tree-trimmer	N/A	N/A	100%	100%	ISA Continuing Education Requirements

8.3 Situational Awareness and Forecasting

8.3.1 Overview

In this section, the electrical corporation must identify objectives for the next 3- and 10-year periods, targets, and performance metrics related to the following situational awareness and forecasting programmatic areas:

- *Environmental monitoring systems*
- *Grid monitoring systems*
- *Ignition detection and alarm systems*
- *Weather forecasting*
- *Ignition likelihood calculation*
- *Ignition consequence calculation*

8.3.1.1 Objectives

Each electrical corporation must summarize the objectives for its 3-year and 10-year plans for implementing and improving its situational awareness and forecasting. These summaries must include the following:

- *Identification of which initiative(s) in the WMP the electrical corporation is implementing to achieve the stated objective, including Utility Initiative Tracking IDs*
- *Reference(s) to applicable codes, standards, and best practices/guidelines and an indication of whether the electrical corporation exceeds an applicable code, standard, or regulation*
- *Method of verifying achievement of each objective*
- *A completion date for when the electrical corporation will achieve the objective*
- *Reference(s) to the WMP section(s) or appendix, including page numbers, where the details of the objective(s) are documented and substantiated*

This information must be provided in Table 8-19 for the 3-year plan and Table 8-20 for the 10-year plan. Exemplars of the minimum acceptable level of information are provided below.

Table 8-21 Situational Awareness Initiative Objectives (3-year plan)

Objectives for Three Years (2023-2025)	Applicable Initiative(s), Tracking ID(s)	Applicable Regulations, Codes, Standards, and Best Practices (See Notes)	Method of Verification (i.e., program)	Completion Date	Reference (Section and Page Number)
Complete online diagnostic pilot program and evaluate effectiveness.	Grid monitoring systems, SAF_3	N/A	Completion of Pilot. Internal review of results	31-Dec-23	Section 8.1.2.8; pp. 135
Complete installation of fault indicators (FIs). Evaluate need for additional (Fis)	Grid monitoring systems, SAF_2	N/A	Close of work order. Internal review of cost-benefit	31-Dec-23	Section 8.3.3.3; pp. 237
Evaluate need for additional weather stations.	Environmental monitoring systems, SAF_1	N/A	N/A	31-Dec-25	Section 8.3.1; pp. 225
Evaluate need for additional HD Alert Cameras.	Ignition detection systems, SAF_4	N/A	N/A	31-Dec-25	Section 8.3.1; pp. 225
Develop and implement Fire Potential Index.	Fire Potential Index, SAF_6	N/A	FPI Tool – Technosylva	31-Dec-23	6.4.3; pp. 76 7.2.1; pp. 96 8.3.6; pg.
Improve staff proficiency in utilizing advanced fire threat weather forecasting tools.	Weather forecasting, SAF_5	N/A	Multiple Members of BVES team are able to proficiently use tool	31-Dec-23	7.2.1; pp. 248

Note: An asterisk indicates that the electrical corporation exceeds a particular code, regulation, standard, or best practice. The electrical corporation must provide a reference to the appendix section and page providing further documentation, justification, and substantiation.

Table 8-22 Situational Awareness Initiative Objectives (10-year plan)

Objectives for Ten Years (2026-2032)	Applicable Initiative(s), Tracking ID(s)	Applicable Regulations, Codes, Standards, and Best Practices (See Notes)	Method of Verification (i.e., program)	Completion Date	Reference (Section and Page Number)
Evaluate effectiveness of installing cameras, infrared detectors, LiDAR instruments, and other technologies on overhead assets to provide remote monitoring.	Grid monitoring systems SAF_2, Ignition detection systems SAF_4		Meeting minutes discussing the installation, cost-benefit discussion and review of tracking metrics	31-Dec-2033	7.2.1; pp. 248

Note: An asterisk indicates that the electrical corporation exceeds a particular code, regulation, standard, or best practice. The electrical corporation must provide a reference to the appendix section and page providing further documentation, justification, and substantiation.

8.3.1.2 Targets

Initiative targets are forward-looking quantifiable measurements of activities identified by each electrical corporation in its WMP. Electrical corporations will show progress toward completing targets in subsequent reports, including QDRs and WMP Updates.

The electrical corporation must list all targets it will use to track progress on its situational awareness and forecasting for the three years of the Base WMP. Energy Safety's Compliance Assurance Division and third parties must be able to track and audit each target.³¹ For each initiative target, the electrical corporation must provide the following:

- *Utility Initiative Tracking IDs.*
- *Projected targets for each of the three years of the Base WMP and relevant units.*
- *The expected "x% risk impact" For each of the three years of the Base WMP. The expected x% risk impact is the expected percentage risk reduction per year, as described in Section 7.2.2.2.*
- *Method of verifying target completion.*

The electrical corporation's targets must provide enough detail to effectively inform efforts to improve the performance (i.e., reduction in ignition probability or wildfire consequence) of the electrical corporation's situational awareness and forecasting initiatives.

Table 8-23 Situational Awareness Initiative Targets by Year

Initiative Activity	Tracking ID	Units	2023 Target	X% Risk Impact 2023	2024 Target	X% Risk Impact 2024	2025 Target	X% Risk Impact 2025	Method of Verification
Environmental monitoring systems / Advanced Weather Monitoring and Weather Stations	SAF_1	Ongoing Monitoring and Maintenance	100 %	38%	100 %	38%	100 %	38%	Budget Review
Grid monitoring systems / Install Fault Indicators	SAF_2	Number of FIS installed	30	84%	0	N/A	0	N/A	Quantitative
Grid monitoring systems / Online Diagnostic System	SAF_3	Number of circuits installed on per year	2	3.62 %	1	3.62 %	1	3.62 %	Quantitative
Ignition detection systems / HD ALERTWild fire Cameras	SAF_4	N/A	N/A	N/A	N/A	N/A	N/A	N/A	N/A
Weather forecasting	SAF_5	Ongoing Monitoring and Maintenance	100 %	3.76 %	100 %	3.76 %	100 %	3.76 %	Budget Review

Initiative Activity	Tracking ID	Units	2023 Target	X% Risk Impact 2023	2024 Target	X% Risk Impact 2024	2025 Target	X% Risk Impact 2025	Method of Verification
Fire Potential Index	SAF_6	Ongoing Monitoring and Maintenance	100 %	3.46 %	100 %	3.46 %	100 %	3.46 %	Budget Review

8.3.1.3 Performance Metrics

Performance metrics indicate the extent to which an electrical corporation's Wildfire Mitigation Plan is driving performance outcomes. Each electrical corporation must:

- List the performance metrics the electrical corporation uses to evaluate the effectiveness of its situational awareness and forecasting in reducing wildfire and PSPS risk

For each of these performance metrics listed, the electrical corporation must:

- Report the electrical corporation's performance since 2020 (if previously collected)
- Projected performance for 2023-2025
- List method of verification

The electrical corporation must ensure that each metric's name and values are the same in its WMP reporting as its QDR reporting (specifically, QDR Table 2 and QDR Table 3). Metrics listed in this section that are the same as performance metrics required by Energy Safety and reported in QDR Table 2 (Performance Metrics) must match those reported in QDR Table 2. Metrics listed in this section that are not the same as any of the performance metrics identified by Energy Safety and reported in QDR Table 2 must match those reported in QDR Table 3.

The electrical corporation must:

- Summarize its self-identified performance metric(s) in tabular form
- Provide a brief narrative that explains trends in the metrics

Table 8-24 provides an example of the minimum acceptable level of information.

Table 8-24 Situational Awareness and Forecasting Performance Metrics Results by Year

Performance Metrics	Unit	2020	2021	2022	2023 Projected	2024 Projected	2025 Projected	Method of Verification (e.g., third-party evaluation, QDR)
Clearance – SAF_1	miles	N/A	N/A	86.84	72	72	72	QDR

Performance Metrics	Unit	2020	2021	2022	2023 Projected	2024 Projected	2025 Projected	Method of Verification (e.g., third-party evaluation, QDR)
Substation Defensible Space – SAF 4	miles	N/A	N/A	N/A	13	13	13	QDR
Fall-in Mitigation – SAF 6	miles	N/A	N/A	N/A	88	88	88	QDR

8.3.2 Environmental Monitoring Systems

The electrical corporation must describe its systems, processes, and procedures used to monitor environmental conditions within its service territory. These observations should inform the electrical corporation's near-real-time risk assessment and weather forecast validation. The electrical corporation must document the following:

- Existing systems, technologies, and processes
- How the need for additional systems is evaluated
- Implementation schedule for any planned additional systems
- How the efficacy of systems for reducing risk are monitored

Reference the Utility Initiative Tracking ID where appropriate.

8.3.2.1 Existing Systems, Technologies, and Processes

The electrical corporation must report on the environmental monitoring systems and related technologies and procedures currently in use, highlighting any improvements made since the last WMP submission. At a minimum, the electrical corporation must discuss systems, technologies, and procedures related to the reporting of the following:

- Current weather conditions:
 - Air temperature
 - Relative humidity
 - Wind velocity (speed and direction)
- Fuel characteristics:
 - Seasonal trends in fuel moisture

Each system must be summarized in Table 8-25. The electrical corporation must provide the following additional information for each system in the accompanying narrative:

- Generalized location of the system / locations measured by the system (e.g., HTFD, entire service territory).

- *Integration with the broader electrical corporation's system.*
- *How measurements from the system are verified.*
- *Frequency of maintenance.*
- *For intermittent systems (e.g., aerial imagery, line patrols), what triggers collection. This should include flow charts and equations as appropriate.*
- *For calculated quantities, how raw measurements are converted into calculated quantities. This should include flow charts and equations as appropriate.*

Table 8-25 Environmental Monitoring Systems

System	Location	Measurement/Observation	Frequency	Purpose and Integration	Maintenance Schedule
Weather Stations	20 across entire BVES service territory (See Table Below)	Air Temperature Wind Velocity & Direction (Steady & Gust) Relative Humidity Barometric Pressure Precipitation	Continuous Monitoring	Improved weather monitoring and forecasting Model Validation SCADA Connected	As needed
HD Cameras (ALERTWildfire HD Cameras)	15 cameras in 7 Key Locations Across BVES service Territory	Visual Observation	Continuous During Hazardous Conditions	Visual Awareness in areas adjacent to electrical assets. Immediate fire alert	As needed; to be tracked and reported in future WMPs

Weather Stations (SAF 1)

Weather stations are a key component in situational awareness and wildfire risk mitigation strategies. In 2021, BVES completed the installation of all 20 weather stations manufactured by Orion. These stations measure temperature, relative humidity, barometric pressure, wind direction and speed, and precipitation.

These sensors communicate over wireless cellular communications to help BVES obtain service territory specific data and information at one-minute interval recordings. Currently the weather

station data is captured on its own platform. The data gathered from the weather stations has also been integrated into the Technosylva Database.

BVES asserts a total of 20 weather stations will provide sufficient coverage of its 32 sq. mi. service area. These 20 weather stations are currently on an as needed maintenance schedule based on the manufacturer's recommendations. When a maintenance work order is issued for a given weather station calibration is included as part of said work order. Due to the weather stations being in remote locations in the service territory, BVES does not project a change to a regular maintenance schedule unless the accuracy of data is brought into question.

BVES Table 8-7 Weather Station List

Weather Station Name	Pole Number	Year of Installation	Latitude	Longitude
Big Bear Dam	1210284CTC	2020	34.24227667	-116.97761740
North Shore	6984BV	2019	34.24532883	-116.97341180
Fawnskin	12535BV	2020	34.26380082	-116.93446430
Division	In substation	2020	34.26186422	-116.86659300
Paradise	11000BV	2020	34.26652527	-116.84013820
Baldwin	10170BV	2020	34.29375365	-116.81310840
Pioneer	11967BV	2019	34.26318578	-116.79065270
Erwin Lake	7025BV	2020	34.2429703	-116.8006365
Erwin	12671BV	2019	34.23298191	-116.79211290
Lake Williams	9607BV	2020	34.23198312	-116.77332380
Sunrise	9784BV	2019	34.25554307	-116.82382920
Sugarloaf	5026BV	2020	34.24301379	-116.83739720
Clubview	13117BV	2019	34.24027965	-116.86800240
Goldmine	6940BV	2019	34.232107	-116.845663
Garstin	13050BV	2019	34.24588032	-116.88580580
Boulder	12524BV	2019	34.2386084	-116.9376263
Lagunita	11054BV	2019	34.24732716	-116.93515330
2N10	4254BV	2021	34.209833	-116.904333
Radford	12188BV	2019	34.20184	-116.90551
Lake View		2021	34.267380,	-116.880145

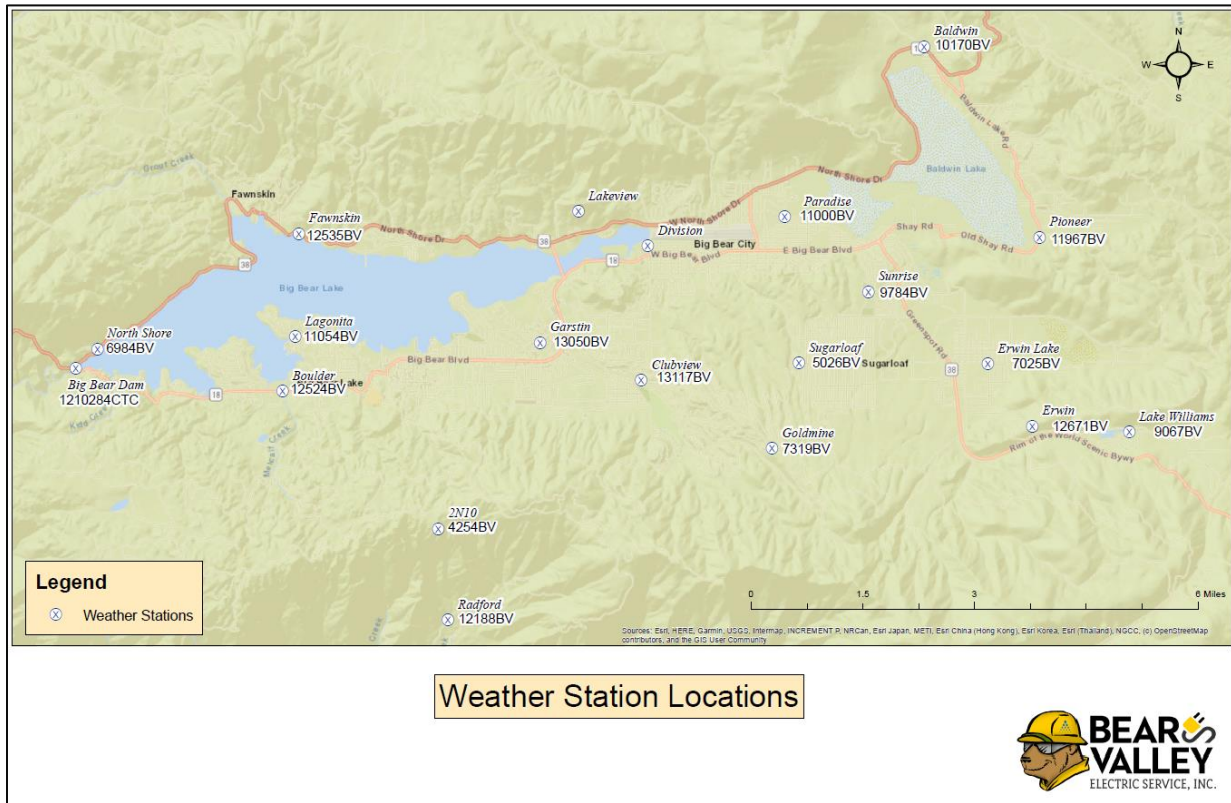

Figure 8-4 BVES Weather Station Locations

HD Cameras (ALERTCalifornia HD Cameras) (SAF 4)

The HD Cameras that BVES has strategically placed around its service territory are a key component in situation awareness, specifically in instances of elevated fire risk. The HD Cameras provide visual awareness into the territories adjacent to electrical assets and maintain live accounts of risk drivers during hazardous weather conditions. The cameras owned by BVES will also contribute to the Southern California system, which comprises a shared network of utility, academic, and fire response cameras to provide coverage of live feeds to monitor conditions and assist emergency event awareness. During high threat conditions, BVES deploys personnel to supplement camera information with observations by qualified personnel.

BVES currently has the ALERTCalifornia cameras on an as needed basis maintenance schedule. There is no current tracking associated with the camera’s and BVES plans to track this in more detail in future WMP submissions.

BVES Table 8-8 ALERT Wildfire HD Camera List

ALERTCalifornia HD Camera (Quantity)	Latitude	Longitude
Bear Mountain (5)	34.21260737482088	- 116.86633705780157
Snow Summit (2)	34.22276789245118	- 116.89473063338028

ALERTCalifornia HD Camera (Quantity)	Latitude	Longitude
Lake Williams is now "Deadman's Ridge" (2)	34.232954204525576	- 116.79212344081046
Bertha Peak is now "Lakeview" (2)	34.267381554648416	- 116.88014786493233
KBHR (2)	34.27789572286411	- 116.79304190092348
*Onyx Peak (2)	34.19126270322101	- 116.70940870018705
*Keller Peak (2)	34.19680815454194	- 117.04922917574402

8.3.2.2 Evaluation and Selection of New Systems

The electrical corporation must describe how it evaluates the need for additional environmental monitoring systems. This description must include:

- How the electrical corporation evaluates the impact of new systems on reducing risk (e.g., expected quantitative improvement in weather forecasting)
- The electrical corporation's process to evaluate the efficacy of new technologies

These descriptions should include flow charts as appropriate to describe the process.

BVES evaluates risk of its assets two times per year. Updated evaluations include any installations of new systems and the reduction of overall risk to the system.

BVES also evaluates new systems by actual performance (reductions in outages, reductions in line contacts, etc.). If new systems are not performing as expected, then additional situational awareness and forecasting systems are considered. In addition, if a new technology is found that will improve safety, then it will be evaluated and considered.

8.3.2.3 Planned Improvements

The electrical corporation must describe its planned improvements for its environmental monitoring systems. This must include any plans for the following:

- Expansion of existing systems
- Establishment of new systems

For each planned improvement, the electrical corporation must provide the following in Table 8-26:

- Description – A description of the planned initiative activity
- Impact – Reference to and description of the impact of the initiative activity on each risk and risk component
- Prioritization – A description of the x% risk impact (see Section 8.1.1.2 for explanation)
- Schedule – A description of the planned schedule for implementation

Table 8-26 Planned Improvements to Environmental Monitoring Systems

System	Description	Impact	X% Risk Impact	Implementation Schedule
N/A	N/A	N/A	N/A	N/A

At the present time, BVES does not have plans to implement additional environmental monitoring systems. BVES believes its HD cameras as well as weather stations coupled with its investment in Technosylva, and the contract meteorologist provide adequate environmental monitoring. BVES will continue to work in partnership with Technosylva, University of California, San Diego (UCSD), CAL FIRE, and Big Bear Fire Department to determine if additional cameras or weather stations would be beneficial in providing granularity to the conditions within BVES’s service territory.

8.3.2.4 Evaluating Mitigation Initiatives

The electrical corporation must describe the processes and procedures for the ongoing evaluation of the efficacy of its environmental monitoring program.

BVES will continue to work in partnership with Technosylva, UCSD, CAL FIRE, and Big Bear Fire Department to determine if additions to existing system, or additional systems are needed.

- Technosylva will be provide clarity if sufficient data is being provided for monitoring and forecasting.
- UCSD, CAL FIRE & Big Bear Fire Department will provide insight into service area visibility and if the current array of camera’s sufficiently covers the BVES service territory and allows for accurate monitoring of current conditions in the service territory and the surrounding area.

8.3.3 Grid Monitoring Systems

The electrical corporation must describe its systems, processes, and procedures used to monitor the operational conditions of its equipment. These observations should inform the electrical corporation’s near-real-time risk assessment. The electrical corporation must document:

- Existing systems, technologies, and processes
- Process used to evaluate the need for additional systems
- Implementation schedule for any planned additional systems
- How the efficacy of systems for reducing risks are monitored

Reference the Utility Initiative Tracking ID where appropriate.

8.3.3.1 Existing Systems, Technologies, and Processes (Tracking ID: GD_14 – GD_16 – GD_17)

The electrical corporation must report on the grid system monitoring systems and related technologies and processes currently in use, highlighting any improvements made since the last WMP submission. At a minimum, the electrical corporation must discuss systems/technologies related to the detection of:

- *Faults (e.g., fault anticipators, Rapid Earth Fault Current Limiters, etc.)*
- *Failures*
- *Recloser operations*

Each system must be summarized in Table 8-27 below. The electrical corporation must provide the following information for each system in the accompanying narrative:

- *Location of the system / locations measured by the system*
- *Integration with the broader utility system*
- *How measurements from the system are verified*
- *For intermittent systems (e.g., aerial imagery, line patrols), the processes used to trigger collection. This should include flow charts and equations as appropriate to describe the process*
- *For calculated quantities,*
- *How raw measurements are converted to calculated quantities. This should include flow charts and equations as appropriate.*

Table 8-27 Grid Operation Monitoring Systems

System	Measurement/Observation	Frequency	Purpose and Integration
EGM Meta-Alert System	Fault Monitoring due fire, grounding, or third-party impact	Real-Time	Real-time monitoring of Pioneer Circuit
Fault Indicators	Indication of fault on an electrical line or circuit	Real-Time	Allow for BVES to reduce risk of ignition or spark by reducing time to locate and isolate fault. As of 2022 209 have been installed on the system
GreenGrid iSIU System	Physical Asset Condition, and Ignition Monitoring	Real-Time	Real-time monitoring of Boulder and North Shore circuits

GreenGrid iSIU System

BVES is conducting a pilot program to install cameras on poles that continuously monitor the pole and associated line in partnership with Green Grid Inc. The iSIU system provides automated monitoring of asset physical condition as well as ignition monitoring. The system

consists of camera units (nodes) that contain optical sensors, communication modules, processors, and power supply. These nodes allow for autonomous monitoring of the power line infrastructure and can advise the remote maintenance, inspections, or operator crews on equipment status and potential hazardous events. The program hopes to increase real time data as well as reduce operational costs, and human and environmental risk.

8.3.3.2 Evaluation and Selection of New Systems

The electrical corporation must describe how it evaluates the need for additional grid operation monitoring systems. This description must include:

- How the electrical corporation evaluates the impact of new systems on reducing risk (e.g., expected reduction in ignitions from failures, expected reduction in failures)
- How BVES evaluates the efficacy of new technologies

These descriptions should include flow charts as appropriate to describe the process.

See Section 8.3.2.2

8.3.3.3 Planned Improvements

The electrical corporation must describe its planned improvements in its grid operation monitoring systems. This must include any plans for the following:

- Expansion of existing systems
- Establishment of new systems

For each planned improvement, the electrical corporation must provide the following in Table 8-28:

- Description – A description of the planned initiative activity
- Impact – Reference to and description of the impact of the initiative activity on each risk and risk component
- Prioritization – A description of the x% risk impact (see Section 8.1.1.2 for explanation)
- Schedule – A description of the planned schedule for implementation

Table 8-28 Improvements to Grid Operation Monitoring Systems

System	Description	Impact	X% Risk Impact	Implementation Schedule
Fault Indicators	Install additional Fault Indicators	Reduce Risk of Spark or Ignition Reduce fault identification and location time to improve service restoration	84%	129 in 2023

8.3.3.4 Evaluating Mitigation Initiatives (WMSD_1)

BVES must describe its procedures for the ongoing evaluation of the efficacy of its grid operation monitoring program.

BVES will continue to do twice annual evaluation of its assets. In the case of Grid Monitoring Systems (Fault Indicators & EGM Meta-Alert) BVES will monitor the annual Customer Average Interruption Duration Index (CAIDI) for circuits that have the monitoring assets versus prior to asset implementation. BVES will also conduct cost-benefit analysis as it related to risk reduction (the primary goal of the WMP) to determine if the program is meeting the threshold originally planned prior to implementation.

8.3.3.5 Enterprise System for Grid Monitoring (GD_34)

In this section, the electrical corporation must provide an overview of its enterprise system for grid monitoring. This overview must include discussion of:

- *Any database(s) utilized for storage*
- *Describe the utilities internal documentation of its database(s)*
- *Integration with systems in other lines of business*
- *Describe any QA/QC or auditing of its system*
- *Describe internal processes for updating enterprise system including database(s)*
- *Any changes to the initiative since the last WMP submission and a brief explanation as the why those changes were made. Include any planned improvements or updates to the initiative and timeline for implementation*

BVES maintains a SCADA system as its Operational Enterprise system. BVES SCADA system currently monitors and can controls the BVPP as well as all of its upgraded substations, and remotely controlled devices. BVES's SCADA system is only physically monitored during normal business hours but the system sends alerts designated resources via text on a 24/7/365 basis. BVES's BVPP Operators, Substation Technicians, and line crews regularly monitor SCADA as a function of their day-to-day operations.

BVES SCADA system is an IT-managed asset. BVES IT has standard operating procedures for updating and patching SCADA and its associated devices that include, but are not limited to, testing changes outside their operating environment before deployment, version control, comparison of field readings against SCADA displays, etc. BVES IT make sure to verify with all parties that the time is acceptable before performing the deployment of updates, changes, or patches.

8.3.4 Ignition Detection Systems

The electrical corporation must describe its systems, technologies, and procedures used to detect ignitions within its service territory and gauge their size and growth rates.

The electrical corporation must document the following:

- *Existing ignition detection sensors and systems*
- *Evaluation and selection of new ignition detection systems*

- *Planned integration of new ignition detection technologies*
- *Monitoring of mitigation improvements*

Reference the Utility Initiative Tracking ID where appropriate.

8.3.4.1 Existing Ignition Detection Sensors and Systems (SAF_4)

The electrical corporation must report on the ignition detection sensors and systems, along with related technologies and processes, that are currently in use, highlighting any improvements made since the last WMP submission. At a minimum, the electrical corporation must document the deployment of each of the following:

- *Early fire detection:*
- *Satellite infrared imagery*
- *High-definition video*
- *Infrared cameras*
- *Fire growth potential software*

The electrical corporation must summarize each system in Table 8-29 below. It must provide the following additional information for each system in an accompanying narrative:

- *General location of detection sensors (e.g., HFTD or entire service territory)*
- *Resiliency of sensor communication pathways*
- *Integration of sensor data into machine learning or AI software*
- *Role of sensor data in risk response*
- *False positives filtering*
- *Time between detection and confirmation*
- *Security measures for network-based sensors*

Table 8-29 Fire Detection Systems Currently Deployed

Detection System	Capabilities	Companion Technologies	Contribution to Fire Detection and Confirmation
HD Cameras (ALERTWildfire HD Cameras)	Continuous Monitoring During Hazardous Conditions 15 cameras in 7 Key Locations Across BVES service Territory	Technosylva – Fire Growth Potential Software	Visual Awareness in areas adjacent to electrical assets. Immediate fire alert

Detection System	Capabilities	Companion Technologies	Contribution to Fire Detection and Confirmation
Fire Spread Modeling (SA-8)	BVES is utilizing Technosylva's FireCast and FireSim Applications to predict fire spread and consequence outputs such as fire perimeter size, structures impacted, and populations affected	N/A	Capability to forecast consequences that wildfire will have on a particular area
GreenGrid iSIU System	Physical Asset Condition, and Ignition Monitoring	Real-Time	Real-time monitoring of Boulder and North Shore circuits

BVES Table 8-9 ALERTCalifornia HD Camera List

ALERT Wildfire HD Camera (Quantity)	Latitude	Longitude
Bear Mountain (5)	34.21260737482088	- 116.86633705780157
Snow Summit (2)	34.22276789245118	- 116.89473063338028
Lake Williams is now "Deadman's Ridge" (2)	34.232954204525576	- 116.79212344081046
Bertha Peak is now "Lakeview" (2)	34.267381554648416	- 116.88014786493233
KBHR (2)	34.27789572286411	- 116.79304190092348
*Onyx Peak (2)	34.19126270322101	- 116.70940870018705
*Keller Peak (2)	34.19680815454194	- 117.04922917574402

Satellite Infrared Imagery

BVES is not currently pursuing or planning on utilizing satellite infrared imagery for ignition detection. BVES's service area is 32 square-miles (less if you subtract the lakes). Based on the small size and other systems available to detect ignitions, BVES has determined to not pursue satellite infrared imagery.

Highlight any improvements made since the last WMP submission

N/A – BVES is currently not pursuing satellite infrared technology.

General location of detection sensors (e.g., HFTD or entire service territory)

N/A – BVES is currently not pursuing satellite infrared technology.

Resiliency of Sensor Communication Pathways

N/A – BVES is currently not pursuing satellite infrared technology.

Integration of Sensor Data into Machine Learning or Artificial Intelligence (AI) Software

N/A – BVES is currently not pursuing satellite infrared technology.

Role of Sensor Data in Risk Response

N/A – BVES is currently not pursuing satellite infrared technology.

False Positives Filtering

N/A – BVES is currently not pursuing satellite infrared technology.

Time Between Detection and Confirmation

N/A – BVES is currently not pursuing satellite infrared technology.

Security Measures for Network-Based Sensors

N/A – BVES is currently not pursuing satellite infrared technology.

HD Video Cameras

In partnership with the University of California, San Diego (UCSD) ALERTCalifornia (formerly AlertWildfire) network, BVES utilizes the network's HD cameras provide full visibility into the Big Bear Valley. Continuous live feeds help inform BVES, Big Bear Fire Department, San Bernardino Fire Department, San Bernardino Office of Emergency Services, CAL FIRE and other agencies with fast information gathering for ability to confirm smoke/fire location and direction of growth in Big Bear Valley. The information is critical for BVES to protect assets and PSPS decision-making as well as for Fire Departments to evaluate and dispatch resource quickly. BVES continues to work with stakeholders to ensure the HD ALERTCalifornia network has sufficient cameras. The cameras provide live high-definition video feed and infrared detection capability is being incorporated into the system.

Highlight any improvements made since the last WMP submission

BVES completed the installation of a total of 15 camera in 7 locations in partnership with UCSD's ALERTCalifornia network to provide full visibility into the Big Bear Valley.

General location of detection sensors (e.g., HFTD or entire service territory)

15 cameras in 7 locations currently provide full coverage and beyond BVES's service area. The cameras are located at selected mountain peaks, hill tops, and a radio station antenna. These locations were selected in partnership with UCSD, Big Bear Fire Department, San Bernardino Fire Department, San Bernardino Office of Emergency Services, and CAL FIRE.

Resiliency of Sensor Communication Pathways

HD Camera are connected through radio/cellular communication network connecting to UCSD's secured network protocols. UCSD monitors and maintains the connectivity of the HD cameras. Partnering with UCSD allows BVES to access and view the status of the cameras. BVES assists UCSD in maintaining the communications equipment and provides on-site checks when requested by UCSD.

Integration of Sensor Data into Machine Learning or AI Software

UCSD is piloting use of AI to improve alerts.

Role of Sensor Data in Risk Response

The HD cameras do not have sensor technology. HD Cameras provide continuous live feeds and employ AI technology which send alerts for potential smoke/fire locations and provide situational awareness allowing respective parties to better respond to alerts.

False Positives Filtering

Once BVES staff receive an alert notification, they view the cameras for situational awareness and determine what action is necessary on the part of BVES operational staff. If action is required, implementation of BVES operational response protocols would be taken. If no action is required, BVES would dismiss the alert.

Time between Detection and Confirmation

BVES does not keep records of alert notification from AI of a potential smoke/fire.

Security Measures for Network-Based

UCSD maintains and secures data feeds. HD cameras are accessible by BVES through the UCSD provided website, <https://AlertCA.live> which is available to the public.

Infrared Cameras

BVES does not have a separate infrared camera program. Infrared technology is being implemented in the AlertCalifornia HD camera system, which is described in above section “HD Video Cameras”.

General location of detection sensors (e.g., HFTD or entire service territory)

15 cameras with infrared detection capability in 7 locations will provide full coverage and beyond BVES’s service area. The cameras are located at selected mountain peaks, hill tops, and a radio station antenna. These locations were selected in partnership with UCSD, Big Bear Fire Department, San Bernardino Fire Department, San Bernardino Office of Emergency Services, and CAL FIRE.

Highlight any improvements made since the last WMP submission

Infrared technology is being implemented in ALERTCalifornia the camera system. BVES does not have a specific timeline for the infrared upgrades to the cameras.

Resiliency of Sensor Communication Pathways

The sensor communications pathways will be the same as discussed above in the “HD Video Cameras” section.

Integration of Sensor Data into Machine Learning or AI Software

BVES has not integrated the camera infrared detection into machine learning or AI software. UCSD will be pursuing the AI effort.

Role of Sensor Data in Risk Response

The infrared cameras will provide continuous live feeds and will send alert(s) for potential fire location and situational awareness allowing respective parties to better respond to the alert.

False Positives Filtering

When BVES staff receive an alert notification, they view the camera for situational awareness and determine what, if any, action is necessary by BVES operational staff. If action is required, implementation of BVES operational response protocols would be taken. If no action is required, BVES would dismiss the alert.

Time Between Detection and Confirmation

BVES does not maintain this data.

Security Measures for Network-Based Sensors

UCSD will maintain and secure data feeds.

Fire Growth Potential Software

Summary

In 2022, BVES began utilizing Technosylva's Wildfire Analyst Enterprise (WFA-E) wildfire forecasting application. This application includes FireCast and FireSim to simulate advanced fire spread and consequence modeling tools. BVES can run on-demand simulations at any points on a circuit to predict fire spread and consequence outputs such as fire perimeter size, structures impacted, and populations affected. This information assists in driving operational measures to mitigate wildfire including use of PSPS.

General Location of Detection Sensors

The graphic below illustrates the domain covered by the WFA-E model. It goes well beyond BVES's service area due to the potential for significant fire spread in the San Bernardino Mountains as a result of historical weather (winds, humidity), fuel levels, and topography.

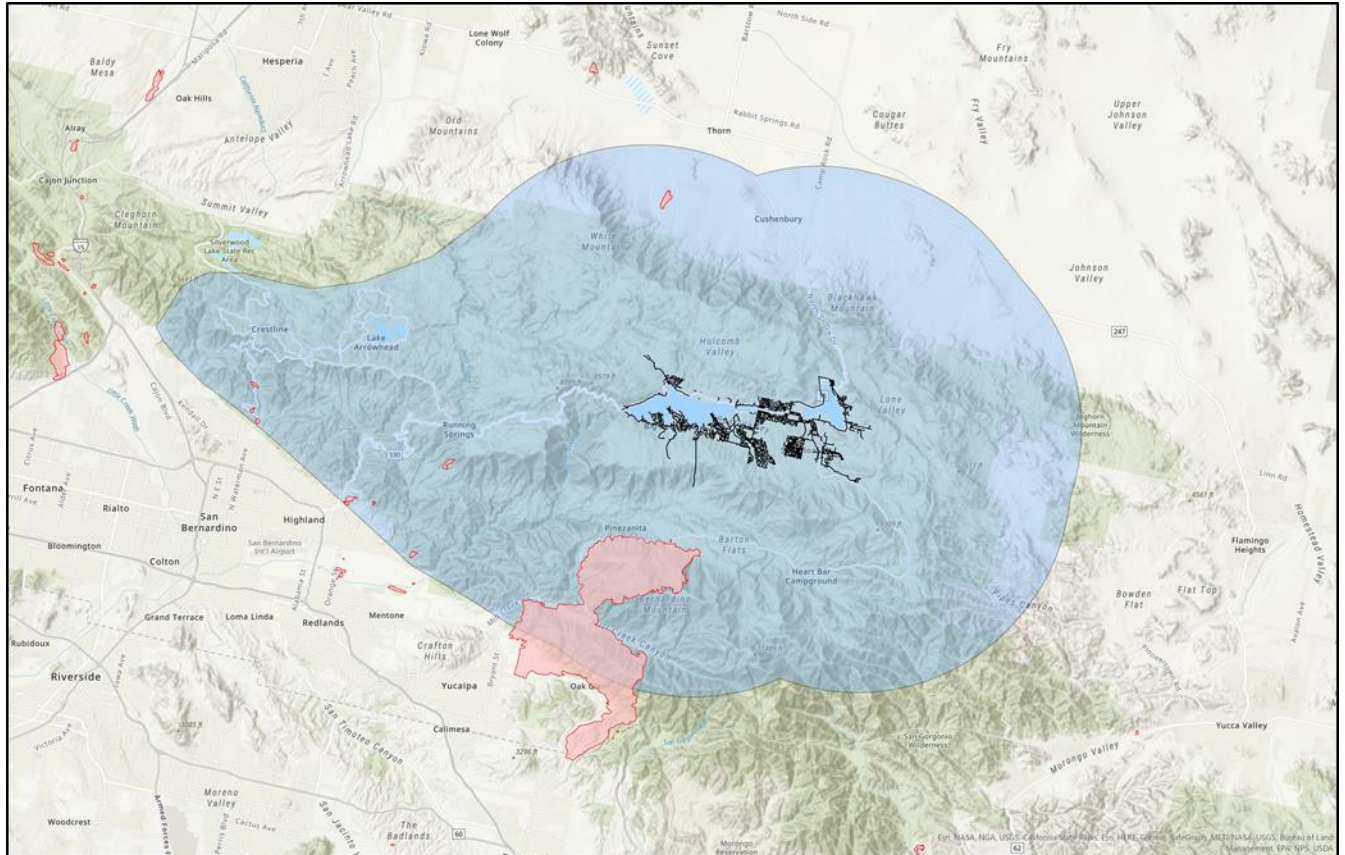

Figure 8-5 WFA-E Domain Coverage

Resiliency of Sensor Communication Pathways

N/A- Technosylva simulation software does not use sensors.

Integration of Sensor Data into Machine Learning or AI Software

N/A- Technosylva simulation software does not use sensors.

Role of Sensor Data in Risk Response

N/A- Technosylva simulation software does not use sensors.

False Positives Filtering

N/A- Technosylva simulation software does not use sensors.

Time Between Detection and Confirmation

N/A- Technosylva simulation software does not detect ignitions.

Security Measures for Network-Based Sensors

N/A- Technosylva simulation software does not use sensors.

8.3.4.2 Evaluation and Selection of New Detection Systems (WMSD_1)

The electrical corporation must describe how it evaluates the need for additional ignition detection technologies. This description must include:

- *How the electrical corporation evaluates the impact on new detection technologies on reducing and improving detection and response times*
- *The electrical corporation's process to evaluate the efficacy of new technologies*
- *The electrical corporation's budgeting process for new detection system purchases*

See Section 8.3.2.2

8.3.4.3 Planned Integration of New Detection Technologies (WMSD_1)

The electrical corporation must provide an implementation schedule for new ignition detection and alarm system technologies. This must include any plans for the following:

- *Integration of new systems into existing physical infrastructure*
- *Integration of new systems into existing data analysis*
- *Increases in budgets and staffing to support new systems*

For each new technology system, the electrical corporation must provide the following in Table 8-28:

- *Description – A description of the technology's capabilities*
- *Impact – A description of the impact the technology will have on each risk and risk component*
- *Prioritization – A description of the x% risk impact (see Section 8.1.1.2 for explanation)*
- *Schedule – A description of the planned schedule for implementation*

Table 8-30 Planning Improvements to Fire Detection and Alarm Systems

System	Description	Impact	X% Risk Impact	Implementation Schedule
N/A	N/A	N/A	N/A	N/A

At present, BVES does not plan to implement additional Ignition Detection systems. BVES believes its HD cameras, and GreenGrid iSUI system coupled with its investment in Technosylva provide adequate ignition detection and forecasting of fire spread. BVES will continue to work in partnership with Technosylva, UCSD, CAL FIRE, and Big Bear Fire Department to determine if additional cameras would be beneficial in providing granularity to the conditions within BVES's service territory.

8.3.4.4 Evaluating Mitigation Initiatives (WMSD_1)

The electrical corporation must describe its procedures for the ongoing evaluation of the efficacy of its fire detection systems.

BVES will continue to work in partnership with Technosylva, UCSD, CAL FIRE, and Big Bear Fire Department to determine if additions to existing system, or additional systems are needed.

- Technosylva will be provide clarity if sufficient data is being provided for monitoring and forecasting.
- UCSD, CAL FIRE & Big Bear Fire Department will provide insight into service area visibility and if the current array of camera's sufficiently covers the BVES service territory and allows for accurate monitoring of current conditions in the service territory and the surrounding area.

8.3.4.5 Enterprise System for Ignition Detection (SAF_4)

In this section, the electrical corporation must provide an overview of its enterprise system for ignition detection. This overview must include discussion of:

- *Any database(s) utilized for storage*
- *Describe the electrical corporation's internal documentation of its database(s)*
- *Integration with systems in other lines of business*
- *Describe any QA/QC or auditing of its system*
- *Describe internal processes for updating enterprise system including database(s)*
- *Any changes to the initiative since the last WMP submission and a brief explanation as the why those changes were made. Include any planned improvements or updates to the initiative and timeline for implementation*

8.3.5 Weather Forecasting

The electrical corporation must describe its systems, processes, and procedures used to forecast weather within its service territory. These forecasts should inform the electrical corporation's near-real-time-risk assessment and PSPS decision-making processes. The electrical corporation must document the following:

- *Existing modeling approach*
- *Known limitations of existing approach*
- *Implementation schedule for any planned changes to the system*
- *Process to monitor the efficacy of systems at reducing risk*

Reference the Utility Initiative Tracking ID where appropriate.

8.3.5.1 Existing Modeling Approach (RMA_1)

At a minimum, the electrical corporation must discuss the following components of weather forecasting:

- *Data assimilation from environmental monitoring systems within the electrical corporation service territory*
- *Ensemble forecasting with control forecast and perturbations*
- *Model inputs including, for example:*
 - *Land cover / land use type*

- *Local topography*
- *Model outputs including, for example:*
 - *Air temperature*
 - *Barometric pressure*
 - *Relative humidity*
 - *Wind velocity (speed and direction)*
 - *Solar radiation*
 - *Rainfall duration and amount*
- *Separate modules (e.g., local weather analysis and local vegetation analysis)*
- *Subject matter expert (SME) assessment of forecasts*
- *Spatial granularity of forecasts including:*
 - *Horizontal resolution*
 - *Vertical resolution*
- *Time horizon of the weather forecast throughout the service territory*

The electrical corporation must highlight improvements made to the electrical corporation's weather forecasting since the last WMP submission

The electrical corporation must also provide documentation of its modeling approach pertaining to its weather forecasting system in accordance with the requirements in Appendix B.

BVES contracts with a meteorologist to provide focused weather forecasts, at least weekly, tailored to BVES's service area, and forecasts evaluating the prevailing fire threat.

Detail on the resources and datasets are as follow:

Resources utilized for forecasting include a wide range of modeling data provided by NOAA, the National Weather Service, and the US Storm Prediction Center. All numerical weather prediction data is considered and ingested from the National Center for Environmental Predictions (NCEP), Canadian Meteorological Center (CMC) and European Centre for Medium-Range Weather Forecasts (ECMWF), utilizing all deterministic and ensemble models, including, but not limited to HRRR and RAP for short range guidance, NAM and GEM-RDPS for medium-range, and ECMWF, GFS and VFSv2 for longer-range data. Ensemble models consist of SREF & GEFS. Another dataset taken into consideration is the Deterministic Model Forecasts of IVT, IWV, and TIVT provided by the Center for Western Weather Water Extremes, Scripps Institution of Oceanography at UC San Diego.

Fire weather data, outlooks, and coordination are provided by the USFS along with the Southern California Geographic Coordination Center which includes hazardous outlooks from National Interagency Coordination Center and National Interagency Fire Center. All

of the above data is considered when providing an accurate fire weather outlook and forecast for the San Bernardino Mountains and Big Bear Valley (BVES coverage area).

The meteorologist is able to obtain analysis of weather data before, during, and after certain extreme weather events. During elevated fire threat and storm conditions, the meteorologist provides forecasts at least daily. During a PSPS event, which BVES has not yet experienced, BVES's contracted meteorologist would provide near continuous forecasting.

BVES's use of Technosylva while focused on risk and fire spread modeling does incorporate weather inputs which have been gathered from both the weather consultant as well as the weather stations BVES has within its service territory. The Technosylva model considers both current and future state conditions for the BVES service territory.

8.3.5.2 Known Limitations of Existing Approach

BVES must describe any known limitations of its existing modeling approach resulting from assumptions, data availability, and computational resources. It must discuss the impact of these limitations on the modeling outputs.

Technosylva's modeling outputs are greatly dependent on the quality of data provided by BVES and its weather assets. Due to the topography and microclimates of BVES's service territory it is possible that the weather data provided could be more granular. This granularity could yield a more accurate model output.

8.3.5.3 Planned Improvements

The electrical corporation must describe its planned improvements in its weather forecasting systems. This must include any plans for the following:

- *Increase in model validation*
- *Increase in spatial granularity*
- *Decrease in limitations by removal of assumptions*
- *Increase in input data quality*
- *Increase in related frequency*

For each planned improvement, the electrical corporation must provide the following in Table 8-31:

- *Description – A description of the planned initiative activity*
- *Impact – Reference to and description of the impact of the initiative activity on each risk and risk component*
- *Prioritization – A description of the x% risk impact (see Section 8.1.1.2 for explanation)*
- *Schedule – A description of the planned schedule for implementation*

Table 8-31 Planned Improvements to Weather Forecasting Systems

System	Description	Impact	X% Risk Impact	Implementation Schedule
--------	-------------	--------	----------------	-------------------------

N/A	N/A	N/A	N/A	N/A
-----	-----	-----	-----	-----

BVES does not have and planned changes or improvements in its engagement with its weather consultant.

All ongoing efforts with Technosylva and its modeling capabilities can be found in Section 6.

8.3.5.4 Evaluating Mitigation Initiatives

BVES must describe its procedures for the ongoing evaluation of the efficacy of its weather forecasting program.

BVES evaluates risk of its assets two times per year. Updated evaluations include any installations of new systems or programs and the reduction of overall risk to the system. BVES also evaluates programs by actual performance (reductions in outages, reductions in line contacts, etc.) and makes determinations on its efficacy.

8.3.5.5 Enterprise System for Weather Forecasting

In this section, the electrical corporation must provide an overview of its enterprise system for weather forecasting. This overview must include discussion of:

- *Any database(s) used for storage*
- *Describe the utilities internal documentation of its database(s)*
- *Integration with systems in other lines of business*
- *Describe any QA/QC or auditing of its system*
- *Describe internal processes for updating enterprise system including database(s)*
- *Any changes to the initiative since the last WMP submission and a brief explanation as the why those changes were made. Include any planned improvements or updates to the initiative and timeline for implementation*

BVES does not have an enterprise system for weather forecasting at this time nor does it have plans to acquire such a system.

8.3.6 Fire Potential Index

The electrical corporation must describe its process for calculating its Fire Potential Index (FPI) or a similar a landscape scale index used as a proxy for assessing real-time risk of a wildfire under current and forecasted weather conditions. The electrical corporation must document the following:

- *Existing calculation approach and how its FPI is used in its operations*
- *The known limitations of its existing approach*
- *Implementation schedule for any planned changes to the system.*

Reference the Utility Initiative Tracking ID where appropriate.

Please reference Sections 6.2.2 and 8.1.8.1 for BVES's use of its FPI model developed by Technosylva for the BVES service area and its risk, and fire potential modeling.

8.3.6.1 Existing Calculation Approach and Use

The electrical corporation must describe:

- How it calculates its own FPI or if uses an external source, such as the United States Geological Survey
- How it uses its or an FPI in its operations

Additionally, if the electrical corporation calculates its own FPI, it must provide tabular information regarding the features of its FPI. Table 8-32 provides a template for the required information.

Table 8-32 FPI Features

Feature Group	Feature	Altitude	Description	Source	Update Cadence	Spatial Granularity	Temporal Granularity
See Statement Below	N/A	N/A	N/A	N/A	N/A	N/A	N/A

BVES calculates FPI as of January 2024. Please reference Section 6 for BVES's use of FPI and its risk, and fire potential modeling.

8.3.6.2 Known Limitations of Existing Approach

The electrical corporation must describe any known limitations of current FPI calculation.

BVES calculates FPI as of January 2024. Please reference Sections 6.2.2 and 8.1.8.1 for BVES's use of FPI and its risk, and fire potential modeling.

8.3.6.3 Planned Improvements

The electrical corporation must describe its planned improvements for its FPI including a description of the improvement and the planned schedule for implementation

BVES calculates FPI as of January 2024. Please reference Section 6.2.2 and 8.1.8.1 for BVES's use of FPI and its risk, and fire potential modeling.

8.4 Emergency Preparedness

8.4.1 Overview

Each electrical corporation must develop and adopt an emergency preparedness plan in compliance with the standards established by the CPUC pursuant to Public Utilities Code section 768.6(a). Wildfires and PSPS introduce unique risk management challenges requiring the electrical corporation to evaluate, develop, and implement wildfire- and PSPS-specific emergency preparedness activities as part of a holistic emergency preparedness strategy.

In this section, the electrical corporation must identify objectives for the next 3- and 10-year periods, targets, and performance metrics related to the following emergency preparedness programmatic areas:

- *Wildfire and PSPS emergency preparedness plan*
- *Collaboration and coordination with public safety partners*
- *Public notification and communication strategy*
- *Preparedness and planning for service restoration*
- *Customer support in wildfire and PSPS emergencies*
- *Learning after wildfire and PSPS events*

BVES has an Emergency and Disaster Recovery Plan (EDRP) that sets forth how BVES will respond to emergencies and disasters, including PSPS activations, by either BVES or a cut of the supply lines by a PSPS initiated by Southern California Edison (SCE). Both the EDRP and the PSPS Protocols comply with CPUC protocols including, but not limited to, Public Utilities Code section 768.6(a).

BVES customers receive electric service through an overhead and underground distribution system. Extreme weather events such as heavy rain, hail, snow, ice, lightning, high winds, or extreme heat may adversely impact the integrity of the distribution system, resulting in occasional interruptions of electrical service. The distribution system is also susceptible to damage because of major disasters, such as earthquakes, flooding, wildfires, and mud and rockslides. Furthermore, in the interest of public safety, BVES may deem it necessary to proactively de-energize large portions of the distribution system to protect the public. For example, BVES may de-energize circuits or portions of circuits during extreme fire threat weather conditions. BVES normally imports power to its service area via Southern California Edison's (SCE) transmission lines. Therefore, the BVES service area may also be susceptible to outages caused by events outside of its services area. All the above may result in major power outages of varying extent and length depending on the severity of the event.

Since electricity is a critical element in our daily lives, prompt restoration is a reasonable customer expectation and a BVES goal. In the case of major disasters, rapid and efficient restoration of power; especially to critical infrastructure, is essential to overall community disaster recovery. The response to customer outages caused by severe weather events or other disasters or events affecting power delivery to the BVES service area is predicated on recognizing and understanding the magnitude of the event as well as the availability of resources to support the restoration process. Accordingly, the EDRP is designed to provide a systematic organized response plan for the purpose of promoting a safe and efficient recovery from any of those conditions. Since the potential of sustaining damages is highest for storm situations, the plan specifically addresses these situations, but it is easily adapted to major outages caused by other causes. It is also recognized that no plan can perfectly predict or respond to every emergency. Therefore, the EDRP provides a structure based on a set of assumptions for the most likely emergencies requiring emergency response; but it also provides the BVES's Incident Commander the authority, flexibility, and discretion to alter the BVES's emergency response to tailor it to the specific emergency to optimize the utilization of BVES resources and to achieve the emergency response goals in an effective and efficient manner. A critical component of the EDRP is close coordination with stakeholders that depend on BVES's service and assistance for their response actions and who may, also, be able to assist BVES in its response actions. Coordination must occur in developing the plan, training on the plan, executing the plan, and in plan refinements.

Some of BVES's major stakeholders include:

- Local officials (City of Big Bear Lake and San Bernardino County)
- State officials (California Public Utilities Commission)
- San Bernardino County Office of Emergency Services (County OES)
- Big Bear Fire Department Bear Valley Electric Service, Inc. Emergency & Disaster
- California Department of Forestry and Fire Protection (CAL FIRE)
- US Forest Service
- San Bernardino County Sheriff's Department Big Bear Lake Patrol Station
- California Highway Patrol (CHP) Arrowhead Area
- California Department of Transportation (Caltrans)
- Big Bear Area Regional Wastewater Agency (BBARWA)
- Big Bear City Community Services District (CSD)
- Big Bear Lake Water Department (DWP)
- Big Bear Municipal Water District (MWD)
- Southwest Gas Corporation
- Bear Valley Community Hospital
- Bear Valley Unified School District
- Big Bear Chamber of Commerce
- Big Bear Airport District
- Big Bear Mountain Resort
- Various media and communications companies

Accurate, effective, and timely communications with key stakeholders is critical in emergency response and, therefore, it is essential that working relationships be established before emergency response is necessary. Understanding stakeholders' key staff, contact information, roles and responsibilities, and capabilities are extremely useful in achieving successful emergency response.

8.4.1.1 Objectives

Each electrical corporation must summarize the objectives for its 3-year and 10-year plans for implementing and improving its emergency preparedness.³³ These summaries must include the following:

- *Identification of which initiative(s) in the WMP the electrical corporation is implementing to achieve the stated objective, including Utility Initiative Tracking IDs*
- *Reference(s) to applicable codes, standards, and best practices/guidelines and an indication of whether the electrical corporation exceeds an applicable code, standard, or regulation*
- *Method of verifying achievement of each objective*
- *A completion date for when the electrical corporation will achieve the objective*
- *Reference(s) to the WMP section(s) or appendix, including page numbers, where the details of the objective(s) are documented and substantiated*

This information must be provided in Table 8-32 for the 3-year plan and Table 8-33 for the 10-year plan. Exemplars of the minimum acceptable level of information are provided below.

BVES leverages the protocols included in the company's EDRP to learn from wildfire events in the same manner the utility learns from any emergency event. The criticality and scope of the BVES EDRP has grown over the past few years. To meet these challenges, emergency

preparedness and response activities must be systematic, inclusive, and transparent to review incidents in a manner that is aligned with our core values.

BVES does not have any specific future improvements for emergency preparedness identified at this time. The EDRP is reviewed annually and updated as necessary due to changes in requirements, lessons learned, changes to the grid, and suggestions from stakeholders in the community. For example, once the Radford Line covered conductor project is complete, BVES will update its EDRP to reflect the new capabilities of the Radford Line (e.g., not de-energizing it from April to October).

Starting In 2023, BVES is utilizing the Federal Emergency Management Agency (FEMA) National Planning System Six Step process to update the EDRP. The EDRP review will begin in November and end in April with a step performed each month: Step 1 Form a Collaborative Planning Team, Step 2, Understand the Situation, Step 3, Determine Goals and Objectives, Step 4, Plan Development, Step 5 Plan Preparation, Review and Approval, Step 6, Plan implementation & Maintenance. BVES will review the EDRP every year and update it as necessary. Figure 8-6

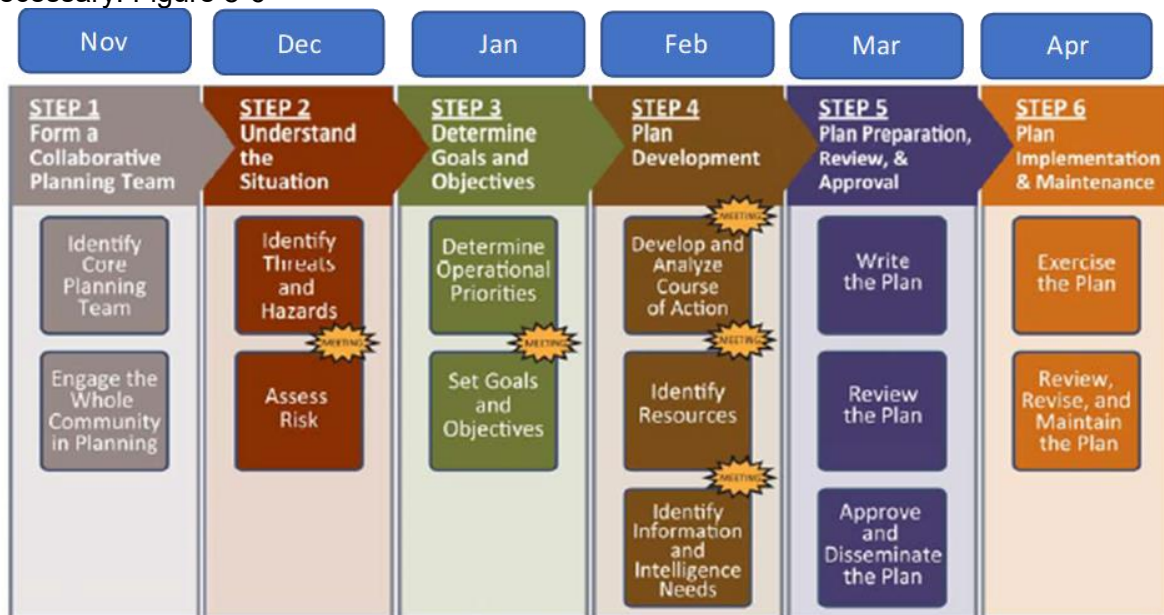

Figure 8-6 outlines the FEMA Six Step process.

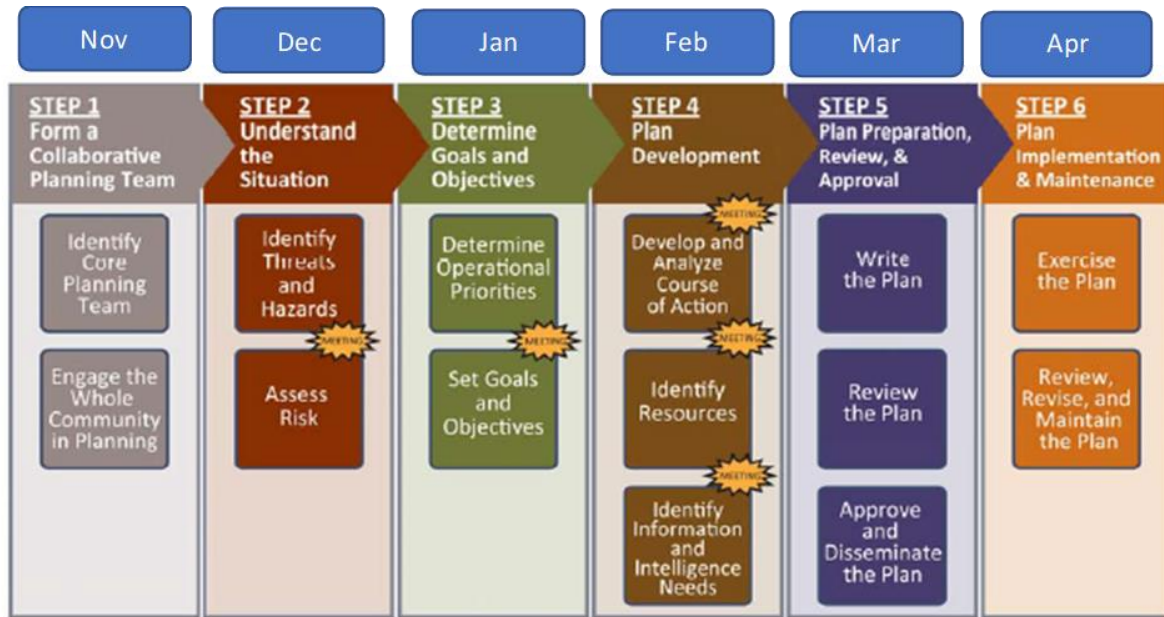

Figure 8-6 FEMA National Planning System Six Step Process

For the PSPS Plan, no direct lessons learned from BVES-initiated activations can be applied to this WMP Update because BVES has not met its thresholds to initiate a PSPS event between 2020 through 2022. However, Bear Valley has followed other utilities' experience and has added lessons learned from elsewhere into its PSPS Plan. The triggering threshold has also not changed based on the implementation of WMP initiatives. In the future, BVES anticipates continued re-designation of high-risk areas to reduced risk designations after years of significant WMP initiative implementation. BVES will re-evaluate its PSPS trigger thresholds to determine if they remain appropriate as mitigations are deployed and real-time modeling capabilities are enhanced.

In 2022, BVES contracted with Technosylva in an effort to provide real-time situational awareness through on-demand fire spread predictions and impact analysis, wildfire risk forecasting for customer assets and the service area using daily weather prediction integration and asset risk analysis using historical weather climatology. Additional quantitative analysis of this projected evolution will be available over the year with full deployment in 2023. This additional awareness may also lead to changes of BVES's PSPS activation thresholds or PSPS Protocol.

BVES updated its PSPS Plan and Protocols to align with Phase 3 de-energization guidelines issued under D. 21-06-034.

BVES has not initiated any PSPS events over the past three years and does not forecast an imminent need to de-energize in the future based on a one, three, or ten-year forecast.

Table 8-33 Emergency Preparedness Initiative Objectives (3-year plan)

Objectives for Three Years (2023-2025)	Applicable Initiative(s), Tracking ID(s)	Applicable Regulations, Codes, Standards, and Best Practices (See Notes)	Method of Verification (i.e., program)	Completion Date	Reference (Section and Page Number)
Improve staff training on emergency and disaster response plan through a combination of classroom instruction, table-top exercises, and functional drills.	Emergency preparedness plan, EP_1	GO 166	Evaluate EDRP through FEMA Six Step review process. Continue to conduct training, exercises and drills	31-Dec-25	8.4.2.1; pg. 268
Increase coordination with community stakeholders in emergency response.	External collaboration and coordination, EP_2	R.15-06-009	Coordination meetings, exercises, and functional drills with community stakeholders	31-Dec-25	8.4.3.1; pg. 300
Develop robust lines and layers of communications with stakeholders and customers.	Public emergency communication strategy, EP_3	R.15-06-009	Coordination meetings, exercises, and functional drills with community stakeholders	31-Dec-25	8.4.4.2; pg. 337
Integrate plan to restore service after an outage due to a wildfire or PSPS event.	Preparedness and planning for service restoration, EP_4	R.15-06-009	Review plan to restore service after an outage due to a wildfire or PSPS event	31-Dec-25	8.4.5; pg. 339
Establish strong programs, systems, and protocols to support residential and non-residential customers in wildfire emergencies	Customer support in wildfire and PSPS emergencies, EP_5	R.15-06-009	Coordination meetings, exercises, and functional drills with residential and non-residential customers	31-Dec-25	8.4.6; pg. 347

Objectives for Three Years (2023-2025)	Applicable Initiative(s), Tracking ID(s)	Applicable Regulations, Codes, Standards, and Best Practices (See Notes)	Method of Verification (i.e., program)	Completion Date	Reference (Section and Page Number)
and PSPS events.					

Note: An asterisk indicates that the electrical corporation exceeds a particular code, regulation, standard, or best practice. The electrical corporation must provide a reference to the appendix section and page providing further documentation, justification, and substantiation.

Table 8-34 Emergency Preparedness Initiative Objectives (10-year plan)

Objectives for Ten Years (2026-2032)	Applicable Initiative(s), Tracking ID(s)	Applicable Regulations, Codes, Standards, and Best Practices (See Notes)	Method of Verification (i.e., program)	Completion Date	Reference (Section and Page Number)
Integrate emergency response plan with stakeholder emergency response plans	Emergency preparedness plan, EP_1 External collaboration and coordination, EP_2	R.15-06-009	Provide an updated plan which integrates the emergency response plan with the stakeholders, emergency response plan	31-Dec-32	8.4.2.1; pg. 268 8.4.3.1; pg. 300
Evaluate increased use of social media and technology to improve and streamline communications with stakeholders and customers.	Public emergency communication strategy, EP_3	N/A	Evaluate the increased use of social media and modify use of social media based on findings	31-Dec-32	8.4.4.2; pg. 337

Note: An asterisk indicates that the electrical corporation exceeds a particular code, regulation, standard, or best practice. The electrical corporation must provide a reference to the appendix section and page providing further documentation, justification, and substantiation.

8.4.1.2 Targets

Initiative targets are quantifiable measurements of activities identified in the WMP. Electrical corporations will show progress towards completing targets in subsequent reports, including QDRs and WMP Updates.

The electrical corporation must list all targets it will use to track progress on its emergency preparedness for the next three years (2023–2025). Energy Safety’s Compliance Assurance Division and third parties must be able to track and audit each target.³⁴ For each initiative target, the electrical corporation must provide the following:

- *Utility Initiative Tracking IDs*
- *Projected targets for the three years of the Base WMP and relevant units*
- *For 2023–2025, the “x% risk impact.” The x% risk impact is the percentage risk reduction identified in Table 7-2 for a specific mitigation initiative (see Section 7.2.2.1 for calculation instructions)*
- *Method of verifying target completion*

The electrical corporation’s targets must provide enough detail to effectively inform efforts to improve the performance (i.e., reduction in wildfire consequence) of the electrical corporation’s emergency preparedness initiatives.

An exemplar of the minimum acceptable level of information is provided in Table 8-34.

Table 8-35 Emergency Preparedness Initiative Targets by Year

Initiative Activity	Tracking ID	Units	2023 Target	X% Risk Impact 2023	2024 Target	X% Risk Impact 2024	2025 Target	X% Risk Impact 2025	Method of Verification
Emergency preparedness plan	EP_1	Review and Evaluate Emergency Plan	Yearly Review by FEMA Six-Step Process Completed in April 2023	3.62%	Yearly Review by FEMA Six-Step Process Completed by April 2024	3.62%	Yearly Review by FEMA Six-Step Process Completed by April 2025	3.62%	Annual Review Meeting
External collaboration and coordination	EP_2	Meetings with Community Partners and Mutual Aid Groups	Meetings completed throughout the year	3.62%	Meetings completed throughout the year	3.62%	Meetings completed throughout the year	3.62%	Records of Meetings with Community Partners and Mutual Aid Groups
Public emergency communication strategy	EP_3	Review and Evaluate Emergency Program	Review and Evaluate Communication Strategy two times per year	3.62%	Review and Evaluate Communication Strategy two times per year	3.62%	Review and Evaluate Communication Strategy two times per year	3.62%	Review Meetings
Preparedness and planning for service restoration	EP_4	Review and Evaluate Emergency Program	Update Service Restoration Plan with Operations Group by June 2023	3.62%	Update Service Restoration Plan with Operations Group by June 2024	3.62%	Update Service Restoration Plan with Operations Group by June 2025	3.62%	Annual Revised Service Restoration Plan

Initiative Activity	Tracking ID	Units	2023 Target	X% Risk Impact 2023	2024 Target	X% Risk Impact 2024	2025 Target	X% Risk Impact 2025	Method of Verification
Customer support in wildfire and PSPS emergencies	EP_5	Review and Evaluate PPS Program	PSPS Plan was reviewed and revised in January 2023	3.62%	Yearly Review and Evaluate PPS Program completed by April 2024	3.62%	Yearly Review and Evaluate PPS Program completed by April 2025	3.62%	Annual Review Meeting

8.4.1.3 Performance Metrics

Performance metrics indicate the extent to which an electrical corporation's Wildfire Mitigation Plan is driving performance outcomes. Each electrical corporation must:

- List the performance metrics the electrical corporation uses to evaluate the effectiveness of its emergency preparedness in reducing wildfire and PSPS risk

For each of these performance metrics listed, the electrical corporation must:

- Report the electrical corporation's performance since 2020 (if previously collected)
- Project performance for 2023-2025
- List method of verification

The electrical corporation must ensure that each metric's name and values are the same in its WMP reporting as its QDR reporting (specifically, QDR Table 2 and QDR Table 3). Metrics listed in this section that are the same as performance metrics required by Energy Safety and reported in QDR Table 2 (Performance Metrics)40 must match those reported in QDR Table 2. Metrics listed in this section that are not the same as any of the performance metrics identified by Energy Safety and reported in QDR Table 2 must match those reported in QDR Table 3.

The electrical corporation must:

- Summarize its self-identified performance metric(s) in tabular form
- Provide a brief narrative that explains trends in the metrics

An exemplar of the minimum acceptable level of information is provided in Table 8-36.

BVES tracks on an annual basis the Customer Average Interruption Duration Index (CAIDI) for its service territory. CAIDI is a representative performance metric for its Emergency Preparedness as the metric tracks the time to restore power to its customers and allows BVES to view on an average interruption basis if it is improving in its effort. Since 2020 BVES has seen a decline in its CAIDI year over year. BVES believe it will continue to see a decline with a target of 45 minutes for its 2025 CAIDI.

Table 8-36 Emergency Preparedness Performance Metrics Results by Year

Performance Metrics	Units	2020	2021	2022	2023 Projected	2024 Projected	2025 Projected	Method of Verification (e.g., third-party evaluation, QDR)
CAIDI	Minutes	94.5	61.5	31.1	55	50	45	Year End Review

8.4.2 Emergency Preparedness Plan

In this section, the electrical corporation must provide an overview of how it has evaluated, developed, and integrated wildfire- and PSPS-specific emergency preparedness strategies, practices, policies, and procedures into its overall emergency plan based on the minimum standards described in GO 166. The electrical corporation must provide the title of its latest emergency preparedness report, the date of the report, and an indication of whether the plan complies with CPUC R.15-06-009, D.21-05-019, and GO 166. The overview must be no more than two paragraphs.

In addition, the electrical corporation must provide a list of any other relevant electrical corporation documents that govern its wildfire and PSPS emergency preparedness planning for response and recovery efforts. This must be a bullet point list with document title, version (if applicable), and date. For example:

- Electrical Corporation's Emergency Response Plan (ECERP), dated MM/DD/YYYY

Reference the Utility Initiative Tracking ID where appropriate.

Section 4 to the BVES Emergency Response and Disaster Plan (EDRP), dated March 31, 2022, explains the BVES system sources of power and actions to be taken when there is partial or complete loss of sources of power, including following the initiation of a PSPS. Appendix B to the EDRP provides a graphic showing the sources of power available to the BVES system including the SCE supply lines and their capacity. The PSPS Plan dated January 31, 2023, provides supplemental guidance in the case of an SCE PSPS event leading to a complete or partial loss of all SCE lines to avoid a “black start” of the Bear Valley Power Plant (BVPP). Once PSPS is implemented, outages shall be managed using the guidance of the BVES EDRP and the supplemental guidance of this procedure.

8.4.2.1 Overview of Wildfire and PSPS Emergency Preparedness (EP_1)

In this section of the WMP, the electrical corporation must provide an overview of its wildfire- and PSPS-specific emergency preparedness plan. At a minimum, the overview must describe the following:

- *Purpose and scope of the plan.*
- *Overview of protocols, policies, and procedures for responding to and recovering from a wildfire or PSPS event (e.g., means and methods for assessing conditions, decision-making framework, prioritizations). This must include:*
- *An operational flow diagram illustrating key components of its wildfire- and PSPS-specific emergency response procedures from the moment of activation to response, recovery, and restoration of service.*
- *Separate overviews and operational flow diagrams for wildfires and PSPS events.*
- *Key personnel, qualifications, and training.*
- *Resource planning and allocation (e.g., staffing).*
- *Drills, simulations, and table-top exercises.*
- *Coordination and collaboration with public safety partners (e.g., emergency planning, interoperable communications).*
- *Notification of and communication to customers during and after a wildfire or PSPS event.*
- *Improvements/updates made since the last WMP submission.*

The overview must be no more than six pages

In addition, the electrical corporation must provide a table with a list of current gaps and limitations in evaluating, developing, and integrating wildfire- and PSPS-specific preparedness and planning features into its overall emergency preparedness plan(s). Where gaps exist, the electrical corporation must provide a remedial action plan and timeline for resolving. Table 8-37 provides an exemplar of the minimum level of content and detail required for this information.

BVES approach to wildfire and PSPS emergency preparedness is to utilize the BVES Emergency Disaster Response Plan (EDRP) and the BVES PSPS Policy and Procedures plan to effectively and efficiently respond to a loss of power including a proactive de-energization (PSPS event) or wildfire event impacting the BVES service area. BVES will utilize a PSPS to promote public safety as a measure of last resort by decreasing the risk of utility infrastructure as a source of wildfire ignitions. PSPS activation is consistent with the statutory obligation to protect public safety pursuant to Public Utilities Codes (“PUCs”) § 451 and 399.2(a).

To prepare for a Wildfire or PSPS event, BVES will perform the following activities:

- Train staff on the BVES EDRP and the BVES PSPS Policy and Procedures Plan,
- Deploy wildfire response team(s) to high fire risk areas,
- Adjust protective device settings optimized for fire prevention (this is limited to adjusting the reclosing feature – automatic to manual),
- Increase frequency of consultant meteorologist forecast,
- Increase monitoring of Technosylva’s WFA-E and running fire spread simulations,
- Increase monitoring of weather stations, forecasts, and fire threat conditions,
- Increase communications with SCE points of contact,

- Proactively engage with first responders, local government and agencies, and other stakeholders,
- Proactively communicate with customers and other stakeholders,
- Identify Medical Baseline customers and AFN populations that may be impacted,
- Prepare to activate Community Resource Center (CRC),
- Activation of Emergency Operations Center (EOC) and EDRP,
- Prepare Bear Valley Power Plant for sustained operations,
- Conduct switch operations to minimize impact of potential PSPS activity,
- Engage temporary generation, and
- Activate CRC,
- Improvements/updates made since the last WMP submission.

The EDRP requires BVES’s staff shall be organized largely based on the Standardized Emergency Management System (SEMS) as interpreted by the BVES. The SEMS structure utilized by BVES is a utility compatible Incident Command Structure (ICS) framework designed to manage emergency incidents and events.

SEMS is an emergency preparedness and response system endorsed by the State of California. It is the cornerstone of California’s emergency response system and the fundamental structure for the response phase of emergency management. SEMS unifies all elements of California’s emergency management community into a single integrated system and standardizes key elements. Additionally, it provides a common structure for all organizations responding to an emergency and a means of systematic planning. The benefits of using the SEMS include:

- Use of common terminology among agencies.
- Use of parallel organizational functions among agencies.
- Provides a standard means of systematic planning.

The basic SEMS organization structure is shown in

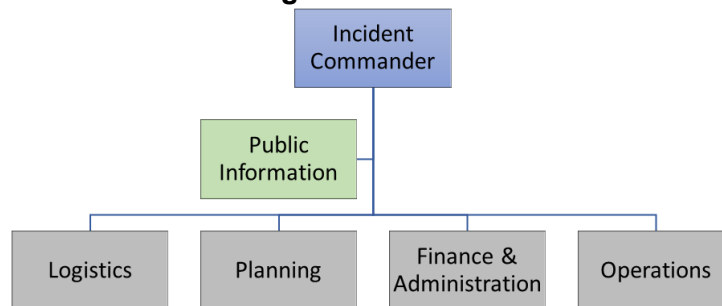

- Figure 8-7, SEMS Organization:

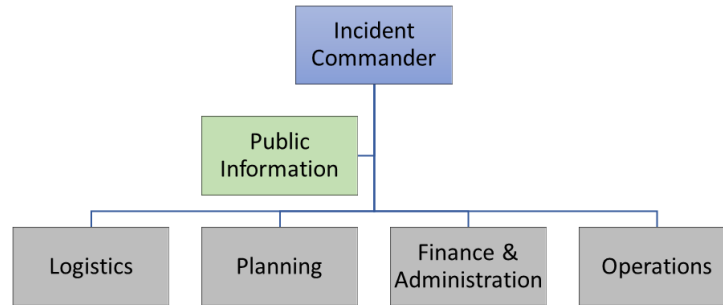

Figure 8-7 SEMS Organization

By organizing the response team along the SEMS structure, the BVES emergency response team coordinates with other government agencies via their corresponding groups. For example, BVES Operations coordinates directly with the City of Big Bear Lake EOC and San Bernardino County OES Operations Groups, as necessary. Additionally, when BVES sends a representative to these two centers, the representative brings a good understanding of the emergency response organization.

The organization chart presented below in Figure 8-8, BVES Emergency Organization, provides the BVES Emergency Organization structure for the full mobilization (Level 1) of BVES's staff in responding to emergencies per this plan. This organizational structure is intended to operate out of an EOC established by BVES and be sustainable for long-term emergency response activities. Due to the size and available resources, the structure BVES utilizes for emergency and PSPS events are the same. Also, the personnel utilized in both Emergency and PSPS events are also the same.

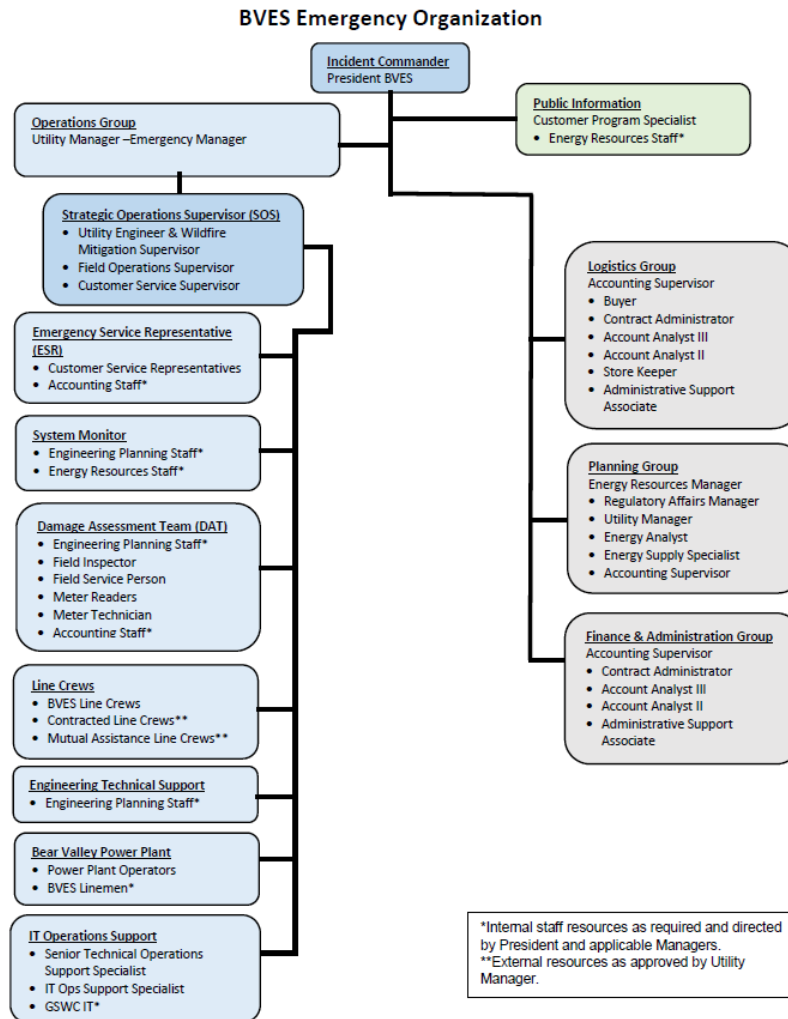

Figure 8-8 BVES Emergency Organization

There are three basic emergency response levels that BVES uses. Level 1 and 2 pertain to the EDRP and Level 3 refers the normal BVES working hours and afterhours Field Operations and Customer Service outage response procedures and processes. When the EDRP is activated, Level 1 or 2 are used to describe level of EOC activation and restoration response process. Level 3 is the normal Service Crew (or Dutyman for afterhours) response process to outages and system problems during the course of normal Transmission & Distribution operations. The response levels to outages and emergencies are summarized in BVES Table 8-10 below:

BVES Table 8-10 Outage and Emergency Response

Response	Event Type	Action	Comments
Level 1	High Risk Long-term*	EOC fully activated ERP processes implemented	It is preferred to fully activate EOC and then shift to Level 2 activation, if full response determined not necessary.

Response	Event Type	Action	Comments
Level 2	Moderate Risk Short-term	EOC partially activated ERP processes implemented	Level of EOC activation and ERP implementation as directed by Utility Manager.
Level 3	Low Risk Short-term	Normal Service Crew/Dutyman and Customer Service processes	These events are normally within the capability of assigned Service Crew or Dutyman to resolve with the normal on call resources.

*Long-term is generally defined as 12 hours.

In the event of a wildfire, the following are flow charts for EDRP and PSPS events:

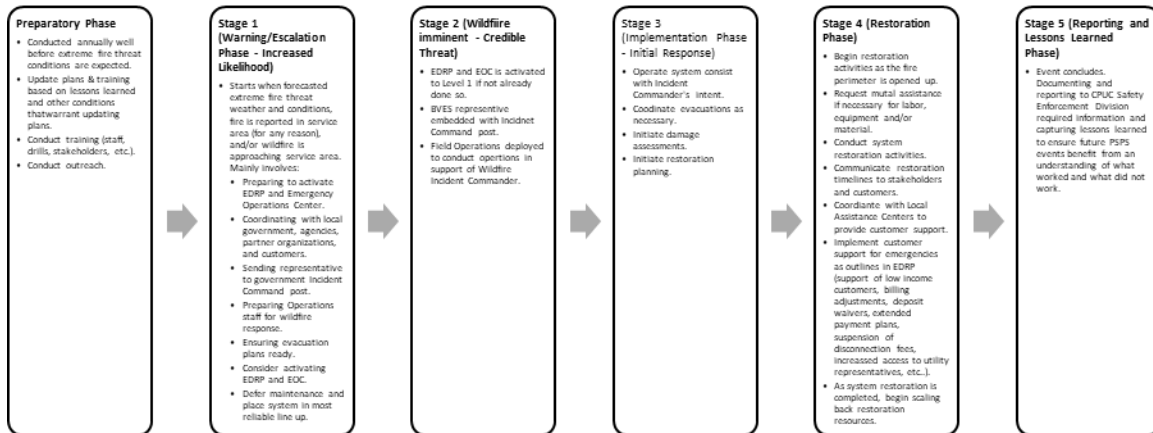

Figure 8-9 EDRP Event Flowchart

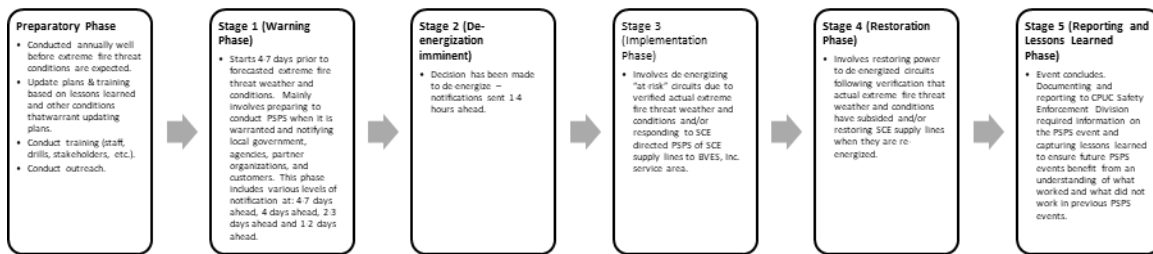

Figure 8-10 PSPS Event Flowchart

For PSPS training, BVES performs two drills per year which includes the public, stakeholders, CPUC, and OEIS involvement. One of the PSPS training is a table-top exercise and 2023 the other PSPS training in 2023 is a full-scale exercise. BVES also conducts at a minimum, two internal training sessions for PSPS.

For Emergency response, BVES conducts a minimum of one internal training session annually which is conducted by BVES' Health and Safety contractor. BVES reviews the EDRP annually utilizing the FEMA National Planning System 6-Step Process. BVES also staffs up its EOC at least once per year (real world event or, if none, then for training (drill scenario)). If an

emergency or PSPS event takes place, BVES will review its performance and develop lessons learned. Training will be conducted to the appropriate personnel for lessons learned.

BVES assigns personnel for each task which matches their expertise. Examples are: the Incident Commander is the President, the Emergency Manager is the Utility Manager, and the Finance and Administration Group is led by the Account Supervisor. Refer to Table 8-38 Emergency Preparedness Staffing and Qualifications for the experience of BVES personnel.

Table 8-37 Key Gaps and Limitations in Integrating Wildfire- and PSPS-Specific Strategies into Emergency Plan

Gap or Limitation Subject	Remedial Brief Description	Remedial Action Plan
Training	BVES continues to improve staff training and drills (exercises) based on real world incidents and lessons learned including those from other IOUs.	The training and exercise programs are continually updated and improve to incorporate new procedures and tools. In 2023, BVES is adding a full-scale PSPS exercise (in 2022 BVES performed a semi-functional exercise).
Coordination with outside organizations	BVES continues to seek to improve coordination with outside stakeholder organizations.	BVES training and exercise events will include outside stakeholder organizations to the maximum extent possible.
Post Action Reviews	After each PSPS exercise or real-world event, BVES collects and discusses lessons learned in order to develop areas for improvement.	Any change or update recommended in Post Action Reviews are to be added to the PSPS or emergency plan, if deemed appropriate, and training is conducted as necessary. BVES will focus on process updates to address any areas for improvement.

8.4.2.2 Key Personnel, Qualifications, and Training

In this section, the electrical corporation must provide an overview of the key personnel constituting its emergency planning, preparedness, response, and recovery team(s) for wildfire and PSPS events. This includes identifying key roles and responsibilities, personnel resource planning (internal and external staffing needs), personnel qualifications, and required training programs.

Personnel Qualifications

The electrical corporation must report on the various roles, responsibilities, and qualifications of electrical corporation and contract personnel tasked with wildfire emergency preparedness planning, preparedness, response, and

recovery, and those tasked for PSPS-related events. This may include representatives from administration, information technology (IT), human resources, communications, electrical operations, facilities, and any other mission-critical units in the electrical corporation. As part of this section, the electrical corporation must provide a brief narrative on how it determined its personnel resource planning for various key roles and responsibilities. The narrative must be no more than two to four pages.

Table 8-38 provides an exemplar of the minimum level of content and detail required.

Table 8-38 Emergency Preparedness Staffing and Qualifications

Role	Incident Type	Responsibilities	Qualifications	# of Dedicated Staff Required	# of Dedicated Staff Provided	# of Contract Workers Required	# of Contract Workers Provided
President	Emergency or PSPS	President holds overall responsibility for the PSPS Plan and ensuring it is properly implemented, resourced, trained upon, executed, and updated as appropriate. Furthermore, the President shall ensure proper communications and coordination with local government, agencies, and customers.	38 years of engineering and technical experience with electrical power systems including field inspections of equipment	1	1	N/A	N/A
Utility Manager	Emergency or PSPS	Direct emergency operations under the WMP and EDRP; Ensure monitoring of	-BS and PE Chemical Engineer -10 years as environmental consultant conducting site inspections and project management	1	1	N/A	N/A

Role	Incident Type	Responsibilities	Qualifications	# of Dedicated Staff Required	# of Dedicated Staff Provided	# of Contract Workers Required	# of Contract Workers Provided
		<p>weather forecasts and conditions is conducted by staff; Direct operational activities related to system line-up and PSPS as warranted; Ensure Field Operations provide timely / accurate information to the Customer Service Supervisor and staff performing customer and public information functions; Closely coordinate with stakeholders leading to a PSPS event, during PSPS, and during</p>	<p>involving a variety of environmental and safety issues -13 years of experience in general management of industrial equipment used in hazardous areas</p>				

Role	Incident Type	Responsibilities	Qualifications	# of Dedicated Staff Required	# of Dedicated Staff Provided	# of Contract Workers Required	# of Contract Workers Provided
		restoration procedures; Activate the Wildfire Response Team (WRT) for PSPS procedures Determine the appropriate staff composition of the WRT when activated; Ensure training for BVES staff with identified PSPS; Ensure availability of resources to execute PSPS Plan and identify gaps in resources and proposed remedies to the President; Ensure regulations are followed required reports					

Role	Incident Type	Responsibilities	Qualifications	# of Dedicated Staff Required	# of Dedicated Staff Provided	# of Contract Workers Required	# of Contract Workers Provided
		are timely submitted to regulatory bodies, including the CPUC and Energy Safety; Evaluate whether changes to PSPS Plan are warranted and implementing any necessary changes.					
Field Operations Supervisor	Emergency or PSPS	Monitor (or direct monitoring) weather advisories, consultant forecasts, and the NFDRS Forecast at least daily during fire season; Direct and manage operational system line-ups	<ul style="list-style-type: none"> -Over 42 years in the utility industry -Journeyman Lineman -Power Troubleshooter -Line Crew Foreman -Operations Manager -Assistant General Manager of Operations 	1	1	N/A	N/A

Role	Incident Type	Responsibilities	Qualifications	# of Dedicated Staff Required	# of Dedicated Staff Provided	# of Contract Workers Required	# of Contract Workers Provided
		based on conditions as described in PSPS Plan; Direct and coordinate PSPS procedures; Direct the activities of the WRT; Control all switch and system line-up operations; Provide (or ensure) timely / accurate information to the Customer Service Supervisor and/or staff performing customer / public information functions; Inform the Utility Manager of system issues;					

Role	Incident Type	Responsibilities	Qualifications	# of Dedicated Staff Required	# of Dedicated Staff Provided	# of Contract Workers Required	# of Contract Workers Provided
		Collect data and maintain documentation including, but not limited to, inspections, operational system line-up, and PSPS activities; and Submit to the Utility Manager recommended changes to PSPS Plan as warranted.					
Utility Engineer & Wildfire Mitigation Supervisor	Emergency or PSPS	Ensure system design and construction is compliant with applicable rules and regulations to mitigate fire; Develop distribution, sub-transmission and substations designs to reduce fire risk;	-13 years as an Electrical Engineer -Eight Years with BVES as substation designer, transmission/distribution designer and compliance engineer	1	1	N/A	N/A

Role	Incident Type	Responsibilities	Qualifications	# of Dedicated Staff Required	# of Dedicated Staff Provided	# of Contract Workers Required	# of Contract Workers Provided
		<p>Research, evaluate, and source materials fire resistant materials and equipment; Develop device protective settings and select fuses to prevent fire while taking into account reliability and load; Support Field Operations and the WRT as directed by the Utility Manager in the execution of system operations; and Submit recommended changes to the Utility Manager as warranted.</p>					

Role	Incident Type	Responsibilities	Qualifications	# of Dedicated Staff Required	# of Dedicated Staff Provided	# of Contract Workers Required	# of Contract Workers Provided
Customer Program Specialist	Emergency or PSPS	Notify (or direct to notify) local government, agency, and customer notifications; Establish and maintain customer communications methods and equipment to support PSPS notifications; Train staff assigned to issue customer / public information via media notification statements and customer communications methods; Develop (or cause to be developed) the contact list of stakeholders;	- 25 years of energy and utility experience -23 years working for BVES/Golden State Water Company in various roles such as: customer care and operations support superintendent, energy analyst, energy pre-scheduler, engineering technician, and customer support representative	1	1	N/A	N/A

Role	Incident Type	Responsibilities	Qualifications	# of Dedicated Staff Required	# of Dedicated Staff Provided	# of Contract Workers Required	# of Contract Workers Provided
		Direct a customer education strategy to inform customers about BVES's fire mitigation programs including PSPS; and Submit to the Utility Manager recommended changes to PSPS Plan as warranted.					

Personnel Training (GD_39)

The electrical corporation must report on its internal personnel training program(s) for wildfire and PSPS emergency events. This training must include, at a minimum, training on relevant policies, practices, and procedures before, during, and after a wildfire or PSPS event. The reporting must include, at a minimum:

- *The name of each training program*
- *A brief narrative on the purpose and scope of each program*
- *The type of training method*
- *The schedule and frequency of training programs*
- *The percentage of staff who have completed the most current training program*
- *How the electrical corporation tracks who has completed the training programs*

Table 8-39 provides an example of the minimum acceptable level of information.

BVES meets internally at least twice per year to train and review the EDRP and PSPS Plans and procedures. In addition, the entire management and a majority of the BVES staff is involved with both PSPS table-top and functional exercises. During these exercises, BVES runs through scenarios where PSPS de-energization is simulated.

In addition, BVES conducts a monthly Safety Committee Meeting which includes management as well as key office and field personnel. This meeting addresses safety and emergency response concerns that can be raised by any of the committee members. Emergency planning, wildfire, and PSPS are commonly discussed during the meetings. Minutes for each safety meeting are maintained.

BVES conducts a monthly training class for emergency situations and for general safety for working in the office and in the field. These training classes provide the background for all BVES employees to understand how to address an emergency situation, if encountered. Sign-in sheets are utilized to track employee participation for all training classes. Mandatory Safety training courses for 2023 are listed in Table 8-39.

External Contractor Training

The electrical corporation must report on its external contractor training program(s) for wildfire and PSPS emergency events. This training must include, at a minimum, training on relevant policies, practices, and procedures before, during, and after a wildfire or PSPS event. The reporting must include, at a minimum:

- *The name of each training program*
- *A brief narrative on the purpose and scope of each program*
- *The type of training method*
- *The schedule and frequency of training programs*
- *The percentage of contractors who have completed the most current training program*
- *How the electrical corporation tracks who has completed the training programs*

Wildfire and PSPS activation/response is managed by BVES staff. Any contractor used in a wildfire or PSPS event is fully trained for emergency response. BVES meets with its utility construction and tree service contractors on a weekly basis to review safety and/or emergency protocols. In the event of an emergency or PSPS event, BVES meets with our contractors to determine lessons learned. If there are no wildfire or emergencies, then BVES will meet with contractors four times per year to discuss emergency situations. In 2023, BVES is implementing a more in-depth contractor management program which includes training for wildfire and PSPS situations.

Table 8-39 Electrical Corporation Personnel Training Program

Training Topic	Purpose and Scope	Training Method	Training Frequency	Position or Title of Personnel Required to Take Training	# of Personnel Requiring Training	# of Personnel Provided with Training	Form of Verification or Reference
Fire Safety	Required fire safety training for all BVES staff	In-person or online for all training classes	As required, yearly, or every other year	All staff	~ 45	All staff will be scheduled for Fire Safety Training	Sign-in sheets used for all training classes
Office Safety	Required office safety training for all BVES staff	In-person or online for all training classes	As required, yearly, or every other year	All Staff	~45	All staff will be scheduled for Office Safety Training	Sign-in sheets used for all training classes
Ergonomics	Required ergonomics training for all BVES staff	In-person or online for all training classes	As required, yearly, or every other year	All Staff	~45	All staff will be scheduled for Ergonomics Training	Sign-in sheets used for all training classes
Emergency Action Plan	Required emergency action plan training for all BVES staff	In-person or online for all training classes	As required, yearly, or every other year	All Staff	~45	All staff will be scheduled for Emergency Action Plan Training	Sign-in sheets used for all training classes

Training Topic	Purpose and Scope	Training Method	Training Frequency	Position or Title of Personnel Required to Take Training	# of Personnel Requiring Training	# of Personnel Provided with Training	Form of Verification or Reference
Hazardous Communications	Train staff about proper comms during hazardous conditions Required hazardous communication training for all BVES staff	In-person or online for all training classes	As required, yearly, or every other year	All Staff	~45	All staff will be scheduled for Fire Safety Training	Sign-in sheets used for all training classes
Heat/Cold Stress	Promote worker safety under hot/cold conditions Required heat/cold stress training for all BVES staff	In-person or online for all training classes	As required, yearly, or every other year	All Staff	~45	All staff will be scheduled for Heat/Cold Stress Training	Sign-in sheets used for all training classes
Injury and Illness Prevention (I & IP)	Promote worker safety Required injury and illness prevention training for all BVES staff	In-person or online for all training classes	As required, yearly, or every other year	All Staff	~45	All staff will be scheduled for I & IP Training	Sign-in sheets used for all training classes

Training Topic	Purpose and Scope	Training Method	Training Frequency	Position or Title of Personnel Required to Take Training	# of Personnel Requiring Training	# of Personnel Provided with Training	Form of Verification or Reference
Personal Protective Equipment (PPE)	Promote worker safety Required PPE training for all field ops and management staff	In-person or online for all training classes	As required, yearly, or every other year	Field Operations and Management	~20	Field Operations and Management will be scheduled for PPE Training	Sign-in sheets used for all training classes
Tool Safety	Promote worker safety Required tool safety training for all field ops and management staff	In-person or online for all training classes	As required, yearly, or every other year	Field Operations and Management	~20	Field Operations and Management will be scheduled for Tool Safety Training	Sign-in sheets used for all training classes
Trenching, Shoring, and Excavation	Promote worker and public safety Required fire safety training for all field ops and management staff	In-person or online for all training classes	As required, yearly, or every other year	Field Operations and Management	~20	Field Operations and Management will be scheduled for Trenching, Shoring, and Excavation Training	Sign-in sheets used for all training classes
Confined Space Entry	Promote worker safety	In-person or online for all	As required, yearly, or	Field Operations	~20	Field Operations and Management will be scheduled	Sign-in sheets used for all

Training Topic	Purpose and Scope	Training Method	Training Frequency	Position or Title of Personnel Required to Take Training	# of Personnel Requiring Training	# of Personnel Provided with Training	Form of Verification or Reference
	Required confined space entry training for all field ops and management staff	training classes	every other year	and Management		for Confined Space Training	training classes
Lockout/Tagout	Promote worker safety Required lockout/tagout training for all field ops and management staff	In-person or online for all training classes	As required, yearly, or every other year	Field Operations and Management	~20	Field Operations and Management will be scheduled for Lockout/Tagout Training	Sign-in sheets used for all training classes
Electrical Safety	Promote worker safety Required electrical safety training for all field ops and management staff	In-person or online for all training classes	As required, yearly, or every other year	Field Operations and Management	~20	Field Operations and Management will be scheduled for Electrical Safety Training	Sign-in sheets used for all training classes
Roadway Worker	Promote worker and public safety Required roadway worker	In-person or online for all	As required, yearly, or every other year	Field Operations and Management	~20	Field Operations and Management will be scheduled	Sign-in sheets used for all

Training Topic	Purpose and Scope	Training Method	Training Frequency	Position or Title of Personnel Required to Take Training	# of Personnel Requiring Training	# of Personnel Provided with Training	Form of Verification or Reference
	training for all field ops and management staff	training classes				for Roadway Worker Training	training classes
Traffic Control and Flagging	Promote worker and public safety Required traffic control and flagging training for all field ops and management staff	In-person or online for all training classes	As required, yearly, or every other year	Field Operations and Management	~20	Field Operations and Management will be scheduled for Traffic Control and Flagging Training	Sign-in sheets used for all training classes

Table 8-40 Contractor Training Program

Program in development as stated above.

Training Topic	Purpose and Scope	Training Method	Training Frequency	Position or Title of Personnel Required to Take Training	# of Contractors Requiring Training	# of Contractors Proved with Training	Form of Verification or Reference
Please See Statement Above	N/A	N/A	N/A	N/A	N/A	N/A	N/A

8.4.2.3 Drills, Simulations, and Table-top Exercises

Discussion-based and operational-based exercises enhance knowledge of plans, allow personnel to improve their own performance, and identify opportunities to improve capabilities to respond to real wildfire emergency events and PSPS events. Exercises also provide a method to evaluate a electrical corporation's emergency preparedness plan and identify planning and/or procedural deficiencies.

Internal Exercises

The electrical corporation must report on its program(s) for conducting internal discussion-based and operations-based exercises for both wildfire and PSPS emergency events. This must include, at a minimum, the types of discussion-based exercises (e.g., seminars, workshops, table-top exercises, games) and operations-based exercises (e.g., drills, functional exercises, full-scale exercises), the purpose of the exercises, the frequency of internal exercise programs, the percentage of staff who have completed/participated in exercises and means for verification of internal exercises.

Table 8-41 Internal Drill, Simulation, and Tabletop Exercise Program

Category	Exercise Title and Type	Purpose	Exercise Frequency	Position or Title of Personnel Required to Participate	# of Personnel Participation Required	# of Personnel Participation Completed	Form of Verification or Reference
Discussion-based	Internal TTE	Test PSPS Capabilities	Annual	President, Field Operations Supervisor or Utility Engineer & Wildfire Supervisor, Customer Program Specialist, Accounting Supervisor, Logistic Group Leader, & Others	N/A	N/A	Post-Season Report

Category	Exercise Title and Type	Purpose	Exercise Frequency	Position or Title of Personnel Required to Participate	# of Personnel Participation Required	# of Personnel Participation Completed	Form of Verification or Reference
				as required			
Operations-based	Internal Functional Exercise	Test PSPS Capabilities	Annual	President, Field Operations Supervisor or Utility Engineer & Wildfire Supervisor, Customer Program Specialist, Accounting Supervisor, Logistic Group Leader, & Others as required	N/A	N/A	Post-Season Report

BVES conducted internal table-top and functional exercises for PSPS emergency events. These exercises required staff to participate in simulated PSPS events and administer the PSPS Plan and EDRP, as appropriate to familiarize staff with efforts to be taken during such emergencies. BVES will continue to administer such exercises and will consider setting goals of administering internal exercises in future WMPs in the future as necessary to ensure preparedness for emergencies.

External Exercises

BVES conducts at least one table-top and one functional simulation exercise annually. These exercises involve participating stakeholders from the Big Bear community and be coordinated

with CPUC Cal Fire, Cal OES, communication providers, AFN representatives, and other public safety partners. Additionally, BVES coordinates with these stakeholders to develop and plan the exercises. The exercises seek to prepare BVES and its community partners for a PSPS and enhance their performance, communication protocols, notification practices, and restoration procedures and test the functionality of the plan to the extent practicable. BVES keeps detailed records of these plans and submit reports of these exercises to the CPUC as required. BVES review the exercises to identify strengths and weaknesses of BVES actions and seek to incorporate lessons learned into the PSPS Plan and other associated documentation, as appropriate.

Table 8-42 External Drill, Simulation, and Table-top Exercise Program

Category	Exercise Title and Type	Purpose	Exercise Frequency	Position or Title of Personnel Required to Participate	# of Personnel Participation Required	# of Personnel Participation Completed	Form of Verification or Reference
Discussion-based	Table-Top	Wildfire and PSPS Preparation	Once per year	President, Field Operations Supervisor or Utility Engineer & Wildfire Supervisor, Customer Program Specialist, Accounting Supervisor, Logistic Group Leader, & Others as required	N/A	N/A	Exercise reported to the CPUC

Category	Exercise Title and Type	Purpose	Exercise Frequency	Position or Title of Personnel Required to Participate	# of Personnel Participation Required	# of Personnel Participation Completed	Form of Verification or Reference
Operations-based	Functional Exercise	Wildfire and PSPS Preparation	Once per year	President, Field Operations Supervisor, Utility Engineer & Wildfire Supervisor, Customer Program Specialist, Accounting Supervisor, Logistic Group Leader, & Others as required	N/A	N/A	Exercise reported to the CPUC

8.4.2.4 Schedule for Updating and Revising Plan (EP_1)

The electrical corporation must provide a log of the updates to its emergency preparedness plan since 2019 and the date of its next planned update.

Updates should occur every two years, per R.15-06-009 and D.21-05-019. For each update, the electrical corporation must provide the following:

- Year of updated plan
- Revision type (e.g., addition, modification, elimination)
- Component modified (e.g., communications, training, drills/exercises, protocols/procedures, MOAs)
- A brief description of the lesson learned that informed the revision
- A brief description of the specific addition, modification, or elimination

An exemplar of the minimum acceptable level of information is provided in Table 8-43.

BVES has not identified any specific future improvements at this time. Each year the EDRP is reviewed and updated, as necessary, due to changes in requirements, lessons learned, changes to the grid, and suggestions from stakeholders in the community. For example, once the Radford Line is completed, BVES will update its EDRP to reflect the new capabilities of the Radford Line (e.g., not de-energizing it from April to October).

Bear Valley leverages the protocols included in the EDRP to learn from wildfire events in the same manner the utility learns from any emergency event. The criticality and scope of the BVES EDRP has grown over the past few years as extreme weather events become more common. To meet these challenges, emergency preparedness and response activities must be systematic, inclusive, and transparent to review incidents in a manner aligned with our core values.

In 2023, BVES began utilizing the FEMA National Planning System Six Step process to update the EDRP. The EDRP review begins in November and ends in April with a step performed each month: Step 1 Form a Collaborative Planning Team, Step 2, Understand the Situation, Step 3, Determine Goals and Objectives, Step 4, Plan Development, Step 5 Plan Preparation, Review and Approval, and Step 6, Plan Implementation & Maintenance. BVES will review the EDRP every year and update it as necessary. Figure 8-11

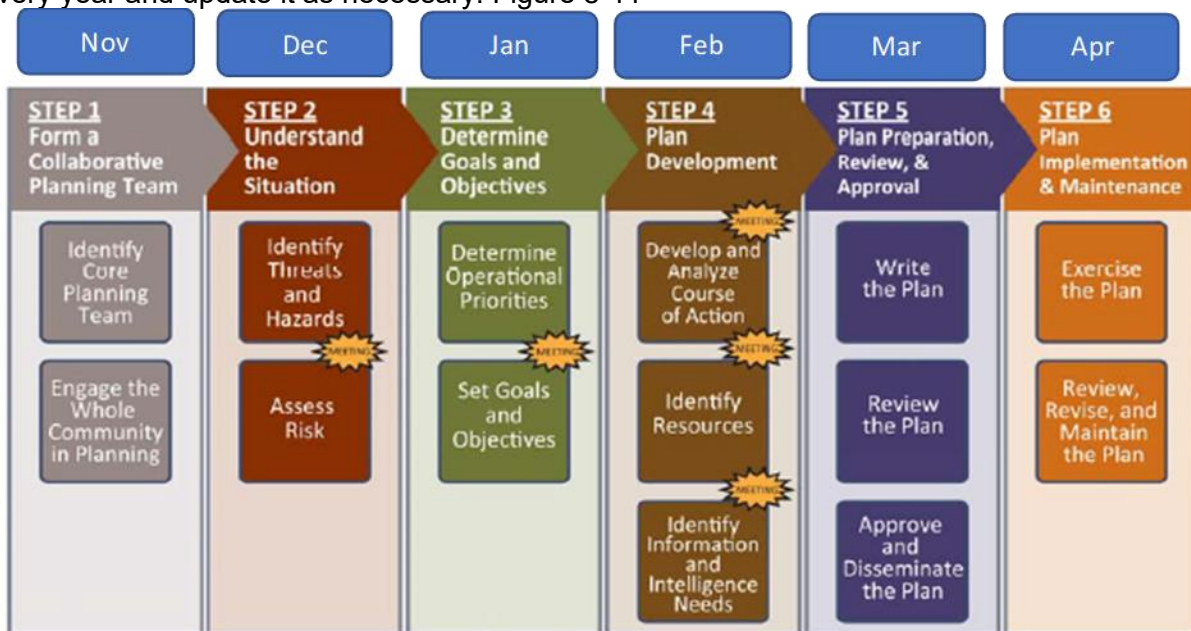

Figure 8-11 outlines the FEMA Six Step process.

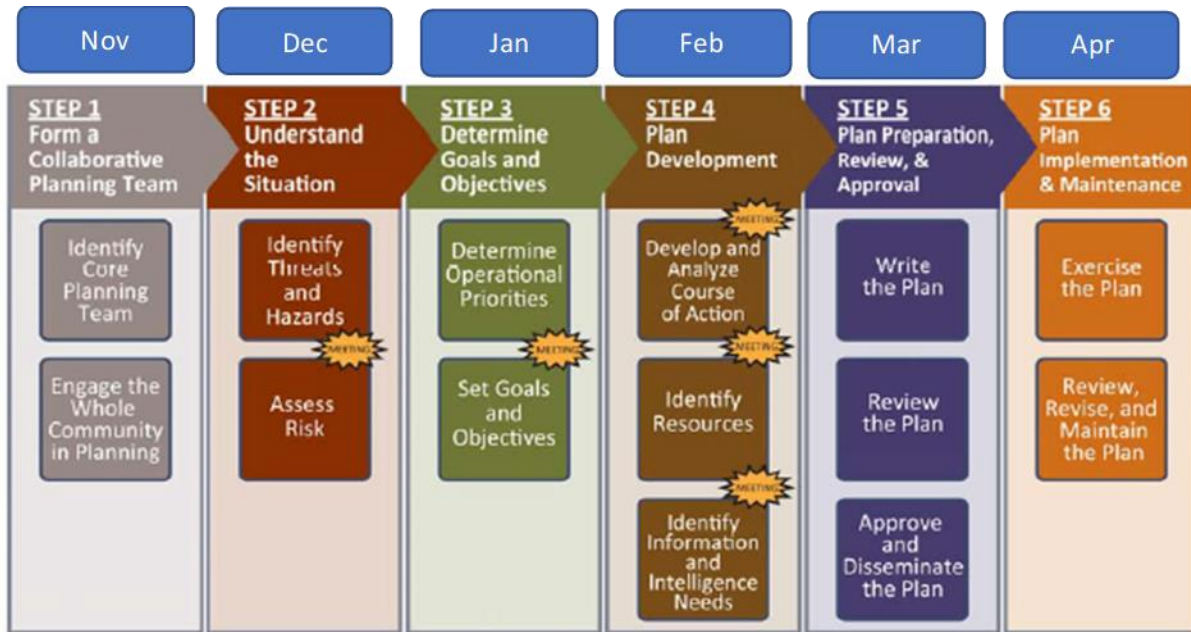

Figure 8-11 FEMA National Planning System Six Step Process

For the PSPS Plan, no direct lessons learned from BVES-initiated activations can be applied to this WMP Update. BVES has not met thresholds to initiate a PSPS event within 2020 through 2022. The triggering threshold has also not changed based on the implementation of WMP initiatives. In the future, BVES anticipates continued re-designation of high-risk areas to reduce risk designations after years of significant WMP initiative implementation. As mitigations are deployed and real-time modeling capabilities are enhanced, BVES will re-evaluate its PSPS trigger thresholds.

In 2022, BVES contracted with Technosylva in an effort to provide real-time situational awareness through on-demand fire spread predictions and impact analysis, wildfire risk forecasting for customer assets and the service area using daily weather prediction integration and asset risk analysis using historical weather climatology. Additional quantitative analysis of this projected evolution will be available over the year with full deployment in 2023.

In mid-2022, BVES is updating its current PSPS Plan and Protocols to align with Phase 3 de-energization guidelines issued under D. 21-06-034.

BVES has not initiated any PSPS events over the past three years and does not forecast an imminent need to de-energize in the future based on a one, three, or ten-year forecast.

Table 8-43 Wildfire-Specific Updates to the Emergency Preparedness Plan

ID #	Year of Updated Plan	Revision Type	Lesson Learned	Revision Description	Reference Section
Emergency Response and Disaster Plan (EDRP),	2023	Modification	Follow plan as outlined, ensure emergency	Process change to align with	8.4.2

dated March 31, 2022			equipment is in working condition	roles and responsibilities	
Public Safety Power Shutdown Plan dated January 31, 2023	2025	Modification	None, no PSPS in territory	Annual plan revision	9.1

8.4.3 External Collaboration and Coordination

8.4.3.1 Emergency Planning (EP_2)

In this section, the electrical corporation must provide a high-level description of its wildfire and PSPS emergency preparedness coordination with relevant public safety partners at state, county, city, and tribal levels within its service territory. The electrical corporation must indicate if its coordination efforts follow California’s SEMS or, where relevant for multi-jurisdictional electrical corporations (e.g., PacifiCorp), the Federal Emergency Management Agency (FEMA) National Incident Management Systems (NIMS), as permitted by GO 166. The description must be no more than a page.

In addition, the electrical corporation must provide the following information in tabular form, with no more than one page of information in the main body of the WMP and the full table in an appendix:

- *List of relevant state, city, county, and tribal agencies within the electrical corporation’s service territory and key point(s) of contact, with associated contact information. Where necessary, contact information can be redacted for the public version of the WMP.*
- *For each agency, whether the agency has provided consultation and/or verbal or written comments in preparation of the most current wildfire- and PSPS-specific emergency preparedness plan. If so, the electrical corporation should provide the date, time, and location of the meeting at which the agency’s feedback was received.*
- *For each agency, whether it has an MOA with the electrical corporation on wildfire and/or PSPS emergency preparedness, response, and recovery activities. The electrical corporation must provide a brief summary of the MOA, including the agreed role(s) and responsibilities of the external agency before, during, and after a wildfire or PSPS emergency.*
- *In a separate table, a list of current gaps and limitations in the electrical corporation’s existing collaboration efforts with relevant state, county, city, and tribal agencies within its territory. Where gaps or limitations exist, the electrical corporation must indicate the remedial action plan and timeline for resolving.*
- *For all requested information, a form of verification that can be provided upon request for compliance assurance.*

Reference the Utility Initiative Tracking ID where appropriate.

Table 8-44 and Table 8-45 provide exemplars of the minimum level of content and detail required.

BVES staff is organized according to the California SEMS structure foremergency planning and response efforts. The SEMS structure utilized by BVES is the utility compatible Incident Command Structure (ICS) designed to manage emergency incidents and events. Roles and responsibilities during emergencies for all members within the BVES ICS are clearly defined. For example, BVES operations coordinates directly with the City of Big Bear Lake EOC or the San Bernardino County OES Operations Group during emergencies, as applicable. Refer to the EDRP, Appendix F, where the BVES SEMS organizational structure and emergency planning coordination efforts are defined and available for review.

BVES utilizes the iRestore Responder software application for emergency planning and coordinating efforts. The iRestore Responder application is a mobile-based emergency response system developed to aid first responders in critical situations. The app was designed to provide effective and efficient communication between emergency responders and communication centers. The app expedites the emergency response time and coordinates emergency and remedial response activities between BVES personnel, public safety partners, and contractors who have been provided access to the app. iRestore's real-time insights into system damage provides BVES internal and external stakeholders better visibility of the incident and assists in restoration following a PSPS event.

BVES conducts and participates in annual emergency planning exercises and trainings. BVES conducted table-top and functional exercises in Q2 of 2022 where the EDRP procedures were tested. Additionally, BVES attended and participated in SCE's 2022 table-top and full-scale PSPS exercises. The lessons learned from the BVES and SCE-hosted exercises were incorporated into the BVES 2023 PSPS Plan. Additionally, BVES will host table-top and full-scale exercises in Q2 of 2023.

BVES also receives as needed assistance from various local government agencies through its mutual aid contract; please refer to Table 8-48 and Section 8.4.3.3 for details pertaining to the agreements established with local government agencies.

Table 8-44 State and Local Agency Collaboration(s)

Name of State or Local Agency	Point of Contact and Information	Emergency Preparedness Plan Collaboration – Last version of Plan Agency Collaborated	Emergency Preparedness Plan Collaborative Role	Memorandum of Agreement (MOA)	Brief Description of MOA
CPUC	Drucilla Dunton Sr. Regulatory Analyst Drucilla.Dunton@cpuc.ca.gov	PSPS Plan dated January 31, 2023 and EDRP dated March 31, 2022	Regulatory	N/A	N/A

Name of State or Local Agency	Point of Contact and Information	Emergency Preparedness Plan Collaboration – Last version of Plan Agency Collaborated	Emergency Preparedness Plan Collaborative Role	Memorandum of Agreement (MOA)	Brief Description of MOA
San Bernardino County	Sbcoa@oes.sbcounty.gov	PSPS Plan dated January 31, 2023 and EDRP dated March 31, 2022	Exercise Participant	Mountain Mutual Aid	Refer to Section 8.4.3.3
Big Bear Fire	Jeff Willis Fire Chief jeff.willis@bigbearfire.org	PSPS Plan dated January 31, 2023 and EDRP dated March 31, 2022	Review and provide feedback regarding PSPS procedures	Mountain Mutual Aid	Refer to Section 8.4.3.3
San Bernardino Fire	Dan Munsey Fire Chief/Fire Warden dmunsey@sbcfire.org	PSPS Plan dated January 31, 2023 and EDRP dated March 31, 2022	Review and provide feedback regarding PSPS procedures	Mountain Mutual Aid	Refer to Section 8.4.3.3
CAL FIRE	bdueccstaff@fire.ca.gov	PSPS Plan dated January 31, 2023 and EDRP dated March 31, 2022	Review and provide feedback regarding PSPS procedures	Mountain Mutual Aid	Refer to Section 8.4.3.3

Name of State or Local Agency	Point of Contact and Information	Emergency Preparedness Plan Collaboration – Last version of Plan Agency Collaborated	Emergency Preparedness Plan Collaborative Role	Memorandum of Agreement (MOA)	Brief Description of MOA
US Forest Service	Travis.Mason@usda.gov	VM procedure s dated October 6, 2021	Review and provide feedback regarding VM procedures	Mountain Mutual Aid	Refer to Section 8.4.3.3
San Bernardino County School District	rncollins@sbcasd.org	2023 WMP PSPS Plan dated January 31, 2023 and EDRP dated March 31, 2022	Review and provide feedback regarding WMP	Mountain Mutual Aid	Refer to Section 8.4.3.3
California Highway Patrol	Napoleon Salais Sargent NASalais@chp.ca.gov	PSPS Plan dated January 31, 2023 and EDRP dated March 31, 2022	Exercise Participant	Mountain Mutual Aid	Refer to Section 8.4.3.3

Name of State or Local Agency	Point of Contact and Information	Emergency Preparedness Plan Collaboration – Last version of Plan Agency Collaborated	Emergency Preparedness Plan Collaborative Role	Memorandum of Agreement (MOA)	Brief Description of MOA
California Department of Transportation	Emily Leinen Public Information Officer emily.leinen@dot.ca.gov	PSPS Plan dated January 31, 2023 and EDRP dated March 31, 2022	Exercise Participant	Mountain Mutual Aid	Refer to Section 8.4.3.3
Big Bear Area Regional Wastewater Agency	John Shimmin Plant Manager jshimmin@bbarwa.org	PSPS Plan dated January 31, 2023 and EDRP dated March 31, 2022	Exercise Participant	Mountain Mutual Aid	Refer to Section 8.4.3.3
Big Bear City Community Service Division	Mary Reeves General Manager mreeves@bbccsd.org	PSPS Plan dated January 31, 2023 and EDRP dated March 31, 2022	Exercise Participant	Mountain Mutual Aid	Refer to Section 8.4.3.3

Name of State or Local Agency	Point of Contact and Information	Emergency Preparedness Plan Collaboration – Last version of Plan Agency Collaborated	Emergency Preparedness Plan Collaborative Role	Memorandum of Agreement (MOA)	Brief Description of MOA
Big Bear Lake Department of Water and Power	Steve Wilson Water Superintendent swilson@bbldwp.com	PSPS Plan dated January 31, 2023 and EDRP dated March 31, 2022	Exercise Participant	Mountain Mutual Aid	Refer to Section 8.4.3.3
Big Bear Municipal Water District	Mike Stephenson General Manager mstephenson@bbmwd.net	PSPS Plan dated January 31, 2023 and EDRP dated March 31, 2022	Exercise Participant	Mountain Mutual Aid	Refer to Section 8.4.3.3
Bear Valley Community Healthcare District	John Mckinney Public Information Officer John.McKinney@bvchd.com	PSPS Plan dated January 31, 2023 and EDRP dated March 31, 2022	Exercise Participant	Mountain Mutual Aid	Refer to Section 8.4.3.3

Name of State or Local Agency	Point of Contact and Information	Emergency Preparedness Plan Collaboration – Last version of Plan Agency Collaborated	Emergency Preparedness Plan Collaborative Role	Memorandum of Agreement (MOA)	Brief Description of MOA
Bear Valley Unified School District	Dr. Mary Suzuki Superintendent mary_suzuki@bearvalleyusd.org	PSPS Plan dated January 31, 2023 and EDRP dated March 31, 2022	Exercise Participant	Mountain Mutual Aid	Refer to Section 8.4.3.3
Big Bear Chamber of Commerce	Ellen Clarke Executive Director execdir@bigbearchamber.com	PSPS Plan dated January 31, 2023 and EDRP dated March 31, 2022	Exercise Participant	Mountain Mutual Aid	Refer to Section 8.4.3.3
Big Bear Airport Authority	John Melissa Maintenance Worker III jmelissa@flybigbear.com	PSPS Plan dated January 31, 2023 and EDRP dated March 31, 2022	Exercise Participant	Mountain Mutual Aid	Refer to Section 8.4.3.3

Name of State or Local Agency	Point of Contact and Information	Emergency Preparedness Plan Collaboration – Last version of Plan Agency Collaborated	Emergency Preparedness Plan Collaborative Role	Memorandum of Agreement (MOA)	Brief Description of MOA
Big Bear Mountain Rescue	Mark Burnett Sr. Director of Facilities mburnett@bbmr.com	PSPS Plan dated January 31, 2023 and EDRP dated March 31, 2022	Exercise Participant	Mountain Mutual Aid	Refer to Section 8.4.3.3
Bear Valley Hospice	Lynda Boggie Administrator admin@bearvalleyhospice.com	PSPS Plan dated January 31, 2023 and EDRP dated March 31, 2022	Exercise Participant	Mountain Mutual Aid	Refer to Section 8.4.3.3
AT&T	EM357C@att.com	PSPS Plan dated January 31, 2023 and EDRP dated March 31, 2022	Exercise Participant	No	N/A

Name of State or Local Agency	Point of Contact and Information	Emergency Preparedness Plan Collaboration – Last version of Plan Agency Collaborated	Emergency Preparedness Plan Collaborative Role	Memorandum of Agreement (MOA)	Brief Description of MOA
City of Big Bear Lake	Sean Sullivan Director of Public Services ssullivan@citybigbearlake.com	PSPS Plan dated January 31, 2023 and EDRP dated March 31, 2022	Exercise Participant	Mountain Mutual Aid	Refer to Section 8.4.3.3
City of Big Bear Lake	Jeff Mathieu City Manager jmathieu@cityofbigbearlake.com	PSPS Plan dated January 31, 2023 and EDRP dated March 31, 2022	Exercise Participant	Mountain Mutual Aid	Refer to Section 8.4.3.3
San Bernardino Office of Emergency Services	Daniel Munoz EMS Administrator Daniel.Munoz@oes.sbcounty.gov	PSPS Plan dated January 31, 2023 and EDRP dated March 31, 2022	Exercise Participant	Mountain Mutual Aid	Refer to Section 8.4.3.3

Name of State or Local Agency	Point of Contact and Information	Emergency Preparedness Plan Collaboration – Last version of Plan Agency Collaborated	Emergency Preparedness Plan Collaborative Role	Memorandum of Agreement (MOA)	Brief Description of MOA
Big Bear Fire	Mike Maltby Assistant Chief mmaltby@bigbearfire.org	PSPS Plan dated January 31, 2023 and EDRP dated March 31, 2022	Exercise Participant	Mountain Mutual Aid	Refer to Section 8.4.3.3
CAL FIRE	BDUCommandStaff@fire.ca.gov	PSPS Plan dated January 31, 2023 and EDRP dated March 31, 2022	Exercise Participant	Mountain Mutual Aid	Refer to Section 8.4.3.3
US Forest Service	Scott Evans Utilities Coordinator scott.a.evans@usda.gov	PSPS Plan dated January 31, 2023 and EDRP dated March 31, 2022	Exercise Participant	Mountain Mutual Aid	Refer to Section 8.4.3.3

Name of State or Local Agency	Point of Contact and Information	Emergency Preparedness Plan Collaboration – Last version of Plan Agency Collaborated	Emergency Preparedness Plan Collaborative Role	Memorandum of Agreement (MOA)	Brief Description of MOA
San Bernardino County School District	Mitch Dattilo Captain mdattilo@sbcasd.org	PSPS Plan dated January 31, 2023 and EDRP dated March 31, 2022	Exercise Participant	Mountain Mutual Aid	Refer to Section 8.4.3.3
California Highway Patrol	Jacob Griede Public Information Officer JGriede@chp.ca.gov	PSPS Plan dated January 31, 2023 and EDRP dated March 31, 2022	Exercise Participant	Mountain Mutual Aid	Refer to Section 8.4.3.3
Big Bear Area Water Authority	Troy Bemisdarfer Plant Supervisor tbemisdarfer@bbarwa.org	PSPS Plan dated January 31, 2023 and EDRP dated March 31, 2022	Exercise Participant	Mountain Mutual Aid	Refer to Section 8.4.3.3

Name of State or Local Agency	Point of Contact and Information	Emergency Preparedness Plan Collaboration – Last version of Plan Agency Collaborated	Emergency Preparedness Plan Collaborative Role	Memorandum of Agreement (MOA)	Brief Description of MOA
Big Bear Community Service District	Jerry Griffith Water Department Superintendent jgriffith@bbccsd.org	PSPS Plan dated January 31, 2023 and EDRP dated March 31, 2022	Exercise Participant	Mountain Mutual Aid	Refer to Section 8.4.3.3
Big Bear Lake Department of Water and Power	Jason Hall Production Supervisor jhall@bbldwp.com	PSPS Plan dated January 31, 2023 and EDRP dated March 31, 2022	Exercise Participant	Mountain Mutual Aid	Refer to Section 8.4.3.3
Big Bear Municipal Water District	Tim Bowman Facility Manager tbowman@bbmwd.net	PSPS Plan dated January 31, 2023 and EDRP dated March 31, 2022	Exercise Participant	Mountain Mutual Aid	Refer to Section 8.4.3.3

Name of State or Local Agency	Point of Contact and Information	Emergency Preparedness Plan Collaboration – Last version of Plan Agency Collaborated	Emergency Preparedness Plan Collaborative Role	Memorandum of Agreement (MOA)	Brief Description of MOA
Southwest Gas	Phillip Petteruto District Manager phillip.petteruto@swgas.com	PSPS Plan dated January 31, 2023 and EDRP dated March 31, 2022	Exercise Participant	Mountain Mutual Aid	Refer to Section 8.4.3.3
Bear Valley Community Healthcare Division	Megan Meadors Program Director megan.meadors@bvchd.com	PSPS Plan dated January 31, 2023 and EDRP dated March 31, 2022	Exercise Participant	Mountain Mutual Aid	Refer to Section 8.4.3.3
Bear Valley Unified School District	Linda Rosado Executive Director of Business Services linda_rosado@bearvalleyusd.org	PSPS Plan dated January 31, 2023 and EDRP dated March 31, 2022	Exercise Participant	Mountain Mutual Aid	Refer to Section 8.4.3.3

Name of State or Local Agency	Point of Contact and Information	Emergency Preparedness Plan Collaboration – Last version of Plan Agency Collaborated	Emergency Preparedness Plan Collaborative Role	Memorandum of Agreement (MOA)	Brief Description of MOA
Big Bear Airport Authority	Ryan Goss General Manager rgoss@flybigbear.com	PSPS Plan dated January 31, 2023 and EDRP dated March 31, 2022	Exercise Participant	Mountain Mutual Aid	Refer to Section 8.4.3.3
Big Bear Mountain Rescue	William Burke Electrical Department Director bburke@bmr.com	PSPS Plan dated January 31, 2023 and EDRP dated March 31, 2022	Exercise Participant	Mountain Mutual Aid	Refer to Section 8.4.3.3
Bear Valley Hospice	info@bearvalleyhospice.com	PSPS Plan dated January 31, 2023 and EDRP dated March 31, 2022	Exercise Participant	Mountain Mutual Aid	Refer to Section 8.4.3.3

Name of State or Local Agency	Point of Contact and Information	Emergency Preparedness Plan Collaboration – Last version of Plan Agency Collaborated	Emergency Preparedness Plan Collaborative Role	Memorandum of Agreement (MOA)	Brief Description of MOA
AT&T	RS4669@att.com	PSPS Plan dated January 31, 2023 and EDRP dated March 31, 2022	Exercise Participant	No	N/A
OEIS	Kevin Miller Wildfire Safety Analyst kevin.miller@energysafety.ca.gov	PSPS Plan dated January 31, 2023 and EDRP dated March 31, 2022	Regulatory	N/A	N/A
OEIS	Melissa Semcer Deputy Director melissa.semcer@energysafety.ca.gov	PSPS Plan dated January 31, 2023 and EDRP dated March 31, 2022	Regulator	N/A	N/A

Name of State or Local Agency	Point of Contact and Information	Emergency Preparedness Plan Collaboration – Last version of Plan Agency Collaborated	Emergency Preparedness Plan Collaborative Role	Memorandum of Agreement (MOA)	Brief Description of MOA
Randle Communications	Noah Rodriguez Assistant Account Manager nrodriguez@randlecommunications.com	PSPS Plan dated January 31, 2023 and EDRP dated March 31, 2022	Communications Contractor	N/A	N/A
CAL FIRE	Frank Bigelow Assistant Deputy Director frank.bigelow@fire.ca.gov	PSPS Plan dated January 31, 2023 and EDRP dated March 31, 2022	Exercise Participant	Mountain Mutual Aid	Refer to Section 8.4.3.3
CAL FIRE	Jeff Fuentes Battalion Chief, Utility Fire Mitigation jeff.fuentes@fire.ca.gov	PSPS Plan dated January 31, 2023 and EDRP dated March 31, 2022	Exercise Participant	Mountain Mutual Aid	Refer to Section 8.4.3.3

Name of State or Local Agency	Point of Contact and Information	Emergency Preparedness Plan Collaboration – Last version of Plan Agency Collaborated	Emergency Preparedness Plan Collaborative Role	Memorandum of Agreement (MOA)	Brief Description of MOA
California Office of Emergency Services	Patricia Utterback Senior Emergency Services Coordinator Patricia.Utterback@CalOES.ca.gov	PSPS Plan dated January 31, 2023 and EDRP dated March 31, 2022	Regulatory	N/A	N/A
California Office of Emergency Services	Karen Valencia Associate Government Program Analyst karen.valencia@caloes.ca.gov	PSPS Plan dated January 31, 2023 and EDRP dated March 31, 2022	Regulatory	N/A	N/A
California Office of Emergency Services	Michael Massone Assistant Director, Response Operations michael.massone@caloes.ca.gov	PSPS Plan dated January 31, 2023 and EDRP dated March 31, 2022	Regulatory	N/A	N/A

Name of State or Local Agency	Point of Contact and Information	Emergency Preparedness Plan Collaboration – Last version of Plan Agency Collaborated	Emergency Preparedness Plan Collaborative Role	Memorandum of Agreement (MOA)	Brief Description of MOA
California Office of Emergency Services	Thomas Graham Regional Administrator thomas.graham@caloes.ca.gov	PSPS Plan dated January 31, 2023 and EDRP dated March 31, 2022	Regulatory	N/A	N/A
CAL FIRE	Stephen Volmer State Fire Marshall Stephen.Volmer@fire.ca.gov	PSPS Plan dated January 31, 2023 and EDRP dated March 31, 2022	Exercise Participant	Mountain Mutual Aid	Refer to Section 8.4.3.3
CAL FIRE	Mark Hillskotter Battalion Chief Mark.Hillskotter@fire.ca.gov	PSPS Plan dated January 31, 2023 and EDRP dated March 31, 2022	Exercise Participant	Mountain Mutual Aid	Refer to Section 8.4.3.3

Name of State or Local Agency	Point of Contact and Information	Emergency Preparedness Plan Collaboration – Last version of Plan Agency Collaborated	Emergency Preparedness Plan Collaborative Role	Memorandum of Agreement (MOA)	Brief Description of MOA
California Office of Emergency Services	Amanda Moyer Emergency Services Coordinator Amanda.Moyer@CalOES.ca.gov	PSPS Plan dated January 31, 2023 and EDRP dated March 31, 2022	Regulatory	N/A	N/A
CPUC	Anthony Knoll Program Manager pspsnotification@cpuc.ca.gov	PSPS Plan dated January 31, 2023 and EDRP dated March 31, 2022	Regulatory	N/A	N/A

Table 8-45 Key Gaps and Limitations in Collaboration Activities with State and Local Agencies

Gap or Limitation Subject	Remedial Brief Description	Remedial Action Plan
Not known at this time	N/A	N/A

8.4.3.2 Communication Strategy with Public Safety Partners (COE_1)

The electrical corporation must describe at a high level its communication strategy to inform external public safety partners and other interconnected electrical corporation partners of wildfire, PSPS, and re-energization events as required by GO 166 and Public Utilities Code section 768.6. This must include a brief description of the policies, practices, and procedures the electrical corporation adopts to establish appropriate communication protocols with public safety partners for both wildfire- and PSPS-specific incidents to ensure timely, accurate, and complete

communications. The electrical corporation must refer to its emergency preparedness plan, as needed, to provide more detail. The narrative must be no more than two pages.

As each public safety partner will have its own unique communication protocols, procedures, and systems, the electrical corporation must coordinate with each entity individually. The electrical corporation must summarize the following information in tabulated format:

- All relevant public safety partner groups (e.g., fire, law enforcement, OES, municipal governments, Energy Safety, CPUC, other electrical corporations) at every level of administration (state, county, city, or tribe), as needed.
- The names of individual public safety entities.
- For each entity, the point of contact for emergency communications coordination, and the contact information. Information may be redacted as needed.
- Key protocols for ensuring the necessary level of voice and data communications (e.g., interoperability channels, methods for information exchange, format for each data typology, communication capabilities, data management systems, backup systems, common alerting protocols, messaging), and associated references in the emergency plan for more details.
- Frequency of prearranged communication review and updates.
- Date of last discussion-based or operations-based exercise(s) on public safety partner communication.

In a separate table, the electrical corporation must list the current gaps and limitations in its public safety partner communication strategy coordination. Where gaps or limitations exist, the electrical corporation must indicate the remedial action plan and timeline for resolving. For all requested information, the electrical corporation must indicate a form of verification that can be provided upon request for compliance assurance.

Table 8-46 and Table 8-47 provide exemplars of the minimum level of content and detail required.

Table 8-46 High-Level Communication Protocols, Procedures, and Systems with Public Safety Partners

Public Safety Partner Group	Name of Entity	Point of Contact and Information	Key Protocols	Frequency of Prearranged Communication Review and Update	Communication Exercise(s): Date of Last Completed	Communication Exercise(s): Date of Planned Next
Law enforcement	Sheriff's Department Big Bear Lake Patrol Station	Lt. Kelly Craig Lieutenant 909-420-5620 kcraig@sbcasd.org	Email with read receipt. If email not read, then call	Quarterly Updates and Planned Exercises	March 1, 2023	April 13, 2023, PSPS Table-top Exercise

Public Safety Partner Group	Name of Entity	Point of Contract and Information	Key Protocols	Frequency of Prearranged Communication Review and Update	Communication Exercise(s): Date of Last Completed	Communication Exercise(s): Date of Planned Next
Medical	Bear Valley Community Hospital	John P. McKinney MPT Director of Physical Therapy/PIO 909-744-2231 John.mckinney@bvchd.com	Email with read receipt . If email not read, then call	Quarterly Updates and Planned Exercises	March 1, 2023	N/A
	Bear Valley Hospice	Cary Stewart 949-338-7252 admin@bearvalleyhospice.com	Email with read receipt . If email not read, then call	Quarterly Updates	March 1, 2023	N/A
Fire department	Big Bear Fire Department Headquarters – Station 281 41090 Big Bear Blvd	Jeff Willis Fire Chief 909-731-4824 Jeff.willis@bigbearfire.org	Email with read receipt . If email not read, then call	Quarterly Updates and Planned Exercises	March 1, 2023	April 13, 2023, PSPS Table-top Exercise

Public Safety Partner Group	Name of Entity	Point of Contract and Information	Key Protocols	Frequency of Prearranged Communication Review and Update	Communication Exercise(s): Date of Last Completed	Communication Exercise(s): Date of Planned Next
City & County Facilities	City of Big Bear Lake City Hall (includes Emergency Operations Center)	Erik Sund City Manager 909-633-4011 sund@citybigbearlake.com	Email with read receipt . If email not read, then call	Quarterly Updates and Planned Exercises	March 1, 2023	April 13, 2023, PSPS Table-top Exercise
Communications Providers	Verizon Wireless	Chris Sinner 714-669-3535 Chris.sinner@verizonwireless.com	Email with read receipt . If email not read, then call	Quarterly Updates	March 1, 2023	April 13, 2023, PSPS Table-top Exercise
		Jane Whang 415-778-1022 Jane.whang@verizon.com	Email with read receipt . If email not read, then call	Quarterly Updates	March 1, 2023	April 13, 2023, PSPS Table-top Exercise

Public Safety Partner Group	Name of Entity	Point of Contract and Information	Key Protocols	Frequency of Prearranged Communication Review and Update	Communication Exercise(s): Date of Last Completed	Communication Exercise(s): Date of Planned Next
		Rex Knowles 801-514-0589 Rex.knowles@verizon.com	Email with read receipt . If email not read, then call	Quarterly Updates	March 1, 2023	April 13, 2023, PSPS Table-top Exercise
	AT&T Wireless	Kevin Quinn 818-731-4000 Kq8185@att.com	Email with read receipt . If email not read, then call	Quarterly Updates	March 1, 2023	April 13, 2023, PSPS Table-top Exercise
		Joshua Overton 209-406-6712 Jo2147@att.com	Email with read receipt . If email not read, then call	Quarterly Updates	March 1, 2023	April 13, 2023, PSPS Table-top Exercise

Public Safety Partner Group	Name of Entity	Point of Contract and Information	Key Protocols	Frequency of Prearranged Communication Review and Update	Communication Exercise(s): Date of Last Completed	Communication Exercise(s): Date of Planned Next
		Joshua Mathisen Jm6547@att.com	Email with read receipt . If email not read, then call	Quarterly Updates	March 1, 2023	April 13, 2023, PSPS Table-top Exercise
		John Goddard Jg266@att.com	Email with read receipt . If email not read, then call	Quarterly Updates	March 1, 2023	April 13, 2023, PSPS Table-top Exercise
	Frontier California Inc.	Bret Plaskey 909-748-7880 Bret.p.plaskey@ftr.com	Email with read receipt . If email not read, then call	Quarterly Updates	March 1, 2023	April 13, 2023, PSPS Table-top Exercise

Public Safety Partner Group	Name of Entity	Point of Contract and Information	Key Protocols	Frequency of Prearranged Communication Review and Update	Communication Exercise(s): Date of Last Completed	Communication Exercise(s): Date of Planned Next
		Charlie Born 916-686-3570 Charlie.born@ftr.com	Email with read receipt . If email not read, then call	Quarterly Updates	March 1, 2023	April 13, 2023, PSPS Table-top Exercise
	Sprint	Jake Osorio 808-317-0276 SPR-inspections@motive-energy.com	Email with read receipt . If email not read, then call	Quarterly Updates	March 1, 2023	April 13, 2023, PSPS Table-top Exercise
	Charter Communications	Robert Fisher 760-674-5404 Robert.fisher@charter.com	Email with read receipt . If email not read, then call	Quarterly Updates	March 1, 2023	April 13, 2023, PSPS Table-top Exercise

Public Safety Partner Group	Name of Entity	Point of Contract and Information	Key Protocols	Frequency of Prearranged Communication Review and Update	Communication Exercise(s): Date of Last Completed	Communication Exercise(s): Date of Planned Next
		Lynn Notarianni 720-518-2585 Lynn.notarianni@charter.com	Email with read receipt . If email not read, then call	Quarterly Updates	March 1, 2023	April 13, 2023, PSPS Table-top Exercise
		Dan Gonzalez Dan.gonzales@charter.com	Email with read receipt . If email not read, then call	Quarterly Updates	March 1, 2023	April 13, 2023, PSPS Table-top Exercise
	T-Mobile	Saif Abdullah 714-757-7075 Saif.abdullah@t-mobile.com	Email with read receipt . If email not read, then call	Quarterly Updates	March 1, 2023	April 13, 2023, PSPS Table-top Exercise

Public Safety Partner Group	Name of Entity	Point of Contract and Information	Key Protocols	Frequency of Prearranged Communication Review and Update	Communication Exercise(s): Date of Last Completed	Communication Exercise(s): Date of Planned Next
		Steve Kukta 414-572-8358 Stephen.h.kukta@t-mobile.com	Email with read receipt . If email not read, then call	Quarterly Updates	March 1, 2023	April 13, 2023, PSPS Table-top Exercise
Radio Stations	KBHR	Cathy Herrick 909-499-4825 cathy@kbhr933.com	Email with read receipt . If email not read, then call	Quarterly Updates	March 1, 2023	April 13, 2023, PSPS Table-top Exercise
Utilities	City of Big Bear Lake Department of Water	Danny Ent 909-816-7709 dent@bbldwp.com	Email with read receipt . If email not read, then call	Quarterly Updates and Planned Exercises	March 1, 2023	April 13, 2023, PSPS Table-top Exercise

Public Safety Partner Group	Name of Entity	Point of Contact and Information	Key Protocols	Frequency of Prearranged Communication Review and Update	Communication Exercise(s): Date of Last Completed	Communication Exercise(s): Date of Planned Next
	Big Bear Area Regional Wastewater Agency (BBARWA)	John Shimmin 760-808-1256 jshimmin@bbarwa.org	Email with read receipt . If email not read, then call	Quarterly Updates and Planned Exercises	March 1, 2023	April 13, 2023, PSPS Table-top Exercise
	Big Bear City Community Services Department (CSD)	Mary Reeves 909-936-9521 mreeves@bbccsd.org	Email with read receipt . If email not read, then call	Quarterly Updates and Planned Exercises	March 1, 2023	April 13, 2023, PSPS Table-top Exercise
	Edison (SCE)	Bryan Falconer Account Manager 626-826-3745 Bryan.falconer@sce.com	Email with read receipt . If email not read, then call	Quarterly Updates and External Planned Exercises	March 1, 2023	April 13, 2023, PSPS Table-top Exercise

Public Safety Partner Group	Name of Entity	Point of Contract and Information	Key Protocols	Frequency of Prearranged Communication Review and Update	Communication Exercise(s): Date of Last Completed	Communication Exercise(s): Date of Planned Next
	Southwest Gas (SWG)	Phillip Petteruto Superintendent Operations 909-366-4869 Phillip.petteruto@swgas.com	Email with read receipt . If email not read, then call	Quarterly Updates and Planned Exercises	March 1, 2023	April 13, 2023, PSPS Table-top Exercise
		SWG Dispatch 877-860-6020 snvdispatch@swgas.com	Email with read receipt . If email not read, then call	Quarterly Updates and Planned Exercises	March 1, 2023	April 13, 2023, PSPS Table-top Exercise
	Big Bear Municipal Water District (MWD)	Mike Stephenson General Manager 909-289-5157 mstephenson@bbmwd.net	Email with read receipt . If email not read, then call	Quarterly Updates and Planned Exercises	March 1, 2023	April 13, 2023, PSPS Table-top Exercise

Public Safety Partner Group	Name of Entity	Point of Contract and Information	Key Protocols	Frequency of Prearranged Communication Review and Update	Communication Exercise(s): Date of Last Completed	Communication Exercise(s): Date of Planned Next
Airports	Big Bear Airport District	John Melissa 909-904-7700 jmelissa@flybigbear.com	Email with read receipt . If email not read, then call	As Needed	N/A	April 13, 2023, PSPS Table-top Exercise
Schools	Bear Valley Unified School District	Dr. Mary Suzuki Superintendent of schools 909-638-6851 Mary_suzuki@bearvalleyusd.org	Email with read receipt . If email not read, then call	As Needed	N/A	April 13, 2023, PSPS Table-top Exercise
Resorts	Big Bear Mountain Resorts	Mart Burnett Sr. Director Facilities 909-725-4017 mburnett@bbmr.com	Email with read receipt . If email not read, then call	As Needed	N/A	N/A

Table 8-47 Key Gaps and Limitations in Communication Coordination with Public Safety Partners

Gap or Limitation Subject	Remedial Brief Description	Remedial Action Plan
Reliance on email communication	N/A	N/A
Lack of social media presence	N/A	N/A
AFN communication methodology	N/A	N/A

8.4.3.3 Mutual Aid Agreements

In this section, the electrical corporation must provide a brief overview of the Mutual Aid Agreements (MAA) it has entered regarding wildfire emergencies and/or disasters, as well as PSPS events. The overview narrative must be no more than one page.

In addition, the electrical corporation must provide the following wildfire emergency information in tabulated format:

- *List of entities with which the electrical corporation has entered a MAA*
- *Scope of the MAA*
- *Resources available from the MAA partner*

Table 8-48 provides an exemplar of the minimum level of content and detail required.

Mutual Aid Agreements are an efficient and effective resource multiplier available to BVES restoration efforts. It is extremely important that these agreements be maintained and staff understand what resources they may provide and how to request the resources.

California Utilities Emergency Association: The California Utilities Emergency Association (CUEA) Mutual Aid Agreement allows member utilities to request and obtain labor, materials, or equipment resources from other member utilities in a rapid manner on a reimbursable basis. BVES shall be an active member of CUEA and shall participate in the Energy Committee meetings and activities, as feasible. Generally, CUEA meetings and activities provide information on emergency response planning at other utilities and state agencies. Additionally, CUEA is an excellent forum for organizations to discuss best practices. The Utility Manager shall be responsible for managing CUEA mutual aid agreement and shall ensure processes are in place and applicable Operations Staff are trained to:

- Inquire about CUEA resources and make formal mutual aid requests in accordance with the CUEA agreement.
- Provide mobilization support such as lodging and meals to responding mutual aid crews and other labor resources provided through CUEA.
- Direct and manage mutual aid crews and other labor resources provided through CUEA.
- Provide logistics support (materials, equipment and other resources as needed) to mutual aid crews and other labor resources provided through CUEA.
- The Administrative Support Associate shall ensure CUEA documents are available to the Operations Group and in the EOC. The Accounting Supervisor shall ensure processes are in place to account for and pay for CUEA mutual aid resources that

respond to BVES' aid requests. This shall require close coordination with the Operations Group.

- Mountain Mutual Aid Association: The mission of the Big Bear Valley Mountain Mutual Aid Association (“MMAA”) is to coordinate and facilitate resources to minimize the impact of disasters and emergencies on people, property, the environment, and the economy. This is accomplished by detailed valley-wide evacuation planning and dedicated support to all involved emergency responders and their agencies. MMAA’s vision is to prepare Big Bear Valley citizens, tourists, businesses, and governments to maximize their resistance to disaster through preparedness, mitigation, response, and recovery activities. BVES shall be an active member of MMAA and actively participate in the MMAA meetings and activities. This is especially important in establishing strong personal business relationships with key players and stakeholders in the community such that during an emergency event. The BVES Utility Manager shall be responsible for managing MMAA mutual aid agreement and shall ensure processes are in place and applicable Operations Staff are trained to:
 - Coordinate activities with MMAA.
 - Request support and resources of MMAA members. Bear Valley Electric Service, Inc. EDRP Page 31 of 65 states MMAA has the ability to provide a wide range of direct support to BVES restoration activities during emergency response including traffic controls, road-clearing services, coordination with local government agencies, other utilities, and other nongovernmental organizations, and communications with the public. Additionally, one of the most significant strengths of MMAA is its ability to coordinate through its member organizations support and relief for customers experiencing extended sustained major power outages. This may include health and welfare checks, shelters, meals, cooling centers, restroom and shower stations, etc.

Table 8-48 High-Level Mutual Aid Agreement for Resources During a Wildfire or De-Energization Incident

Mutual Aid Partner	Scope of Mutual Aid Agreement	Available Resources from Mutual Aid Partner
Mountain Mutual Aid Association	Share information, resources, and manpower in case of an emergency	Information, manpower, and resources

<ul style="list-style-type: none"> • City of Big Bear Lake • Big Bear Fire Department • San Bernardino County Fire • San Bernardino County Department of Public Health • San Bernardino County Office of Emergency Services (OES) • San Bernardino County Sheriff's Department • San Bernardino County Transportation Authority • San Bernardino County Emergency Communications Service (ECS) • US Forest Service • California Highway Patrol • California Department of Transportation • Big Bear Airport • Big Bear City Community Services District • Big Bear Lake Department of Water & Power • Big Bear Lake Municipal Water District • Big Bear Area Regional Water Authority • Bear Valley Electric Service, Inc. • Southwest Gas • Bear Valley Community Healthcare District • Bear Valley Unified School District 		
--	--	--

Mutual Aid Partner	Scope of Mutual Aid Agreement	Available Resources from Mutual Aid Partner
<ul style="list-style-type: none"> • Mountain Area Regional Transit Authority • Bear Mountain Ski Resorts • Big Bear Chamber of Commerce • Big Bear Lake Resort Association • Big Bear Valley Recreation & Park District • American Red Cross • Big Bear Community Emergency Response Team (CERT) • Big Bear Valley Community Organizations Active in Disaster (COAD) • Big Bear Valley Voluntary • Organizations Active in Disaster Resources available from the MAA partner 		
California Utilities Emergency Association (CUAE)	Share information, resources, and manpower in case of an emergency	Information, manpower, and resources

8.4.4 Public Emergency Communication Strategy (EP_3)

The electrical corporation must describe at a high level its comprehensive communication strategy to inform essential customers and other community stakeholder groups of wildfires, outages due to wildfires, and PSPS and service restoration, as required by Public Utilities Code section 768.6. This should include a discussion on the policies, practices, and procedures the electrical corporation adopts to establish appropriate communication protocols to ensure timely, accurate, and complete communications. The electrical corporation may refer to its Public Utilities Code section 768.6 emergency preparedness plan to provide more detail. The narrative must be no more than one page.

In the following sections, the electrical corporation must provide an overview of the following components of an effective and comprehensive communication strategy:

- *Protocols for emergency communications*
- *Messaging*
- *Current gaps and limitations*

Reference the Utility Initiative Tracking ID where appropriate.

Community outreach, public awareness, and communications efforts are required to reduce the impact to customers and the community from an event causing interrupting of service and/or poses serious public risks. Effective planning and awareness also assist to limit the scope of extreme events and avoid escalation. BVES altered how the company addressed the risk of catastrophic wildfires due to the increased presence of potential wildfire due to climate changes and environmental conditions. BVES works year-round to educate customers and the public and works with community partners to improve outreach, awareness, and communications.

The Energy Resource Manager oversees communications plans and activities. Reporting to the Energy Resource Manager is the Customer Service Supervisor, who manages communication activities. BVES's communication plan includes a two-pronged approach (1) proactive preparation before emergencies occur and (2) notifications during and after emergency events. Communications protocols vary slightly when dealing with stakeholders that include customers, first responders, the local mutual aid association, local government, among other key stakeholders.

The list below describes the goals and methods of informing each of these groups.

Customer Outreach and Notifications: The goal of customer outreach is to educate and prepare customers for fire prevention, proactive de-energization, and other utility infrastructure-related emergencies. Communication formats are planned in English, Spanish, Tagalog, Vietnamese, Chinese, French, Mixteco and Zapoteco for online resources and when requested by customers. BVES is continuing to enhance its community outreach activities and has conducted a self-identified survey process to account for these populations. Indigenous communities surrounding the service area are investigated to account for the unique languages representing English as a Second Language (ESL) speakers. BVES collaborates with other community organizations to assure that a local community resource center is available to customers during emergencies. BVES aligns its communication with other organizations, so it is clear and consistent among the local and state organizations.

Before Emergencies: Proactive outreach includes regular messages related to fire prevention (such as vegetation management, distribution inspection, and de-energization policies) and operational initiatives. This occurs through public workshops, BVES newsletters, social media, website posts, and other forms of media. Special presentations related to fire prevention and preparing for emergencies, including PSPS events, are provided through multiple outlets, including printed material, public service announcements, social media, and special briefings by BVES.

During / After Emergencies: Notifications include BVES-prepared customer-facing statements for staff to disseminate in the case of de-energization and emergencies, including information about timing and location of such events. These notifications occur through news outlets, printed materials, digital media, radio forums, website updates, social media updates, text messages, local government, and agency media (e.g., City of Big Bear Lake's email blasts), and interactive voice response (IVR) calls. Additional forms of communication may be leveraged as new technologies and software become available.

Post-event, BVES provides billing and repair support for affected customers. Billing support may include billing adjustments, deposit waivers, suspension of disconnection, and extended payment plans for standard and low-income customers. Repair support may include regular communications about repair processing and timing and individualized support from a utility representative.

1. **Local Government and Agency Engagement and Notification:** Communications with local government agencies is essential to BVES's outage and emergency response plans. BVES leadership strives to engage with local agencies in a direct and expedient manner. Coordination and preparation for emergencies, including PSPS, is a shared responsibility between BVES, public safety partners, and local governments; however, BVES is ultimately responsible and accountable for the safe deployment of PSPS. BVES prepares and informs relevant agencies, before, during, and after outages, PSPS, or emergencies. BVES's protocols include establishing a two-way communication channel to help facilitate communications to collaboratively manage the potential impacts of events.
 - a. **Before Emergencies:** BVES participates in proactive briefings with the local government to collaboratively plan to minimize the impacts of potential emergencies. These briefings include in-person meetings, emails, and coordinated training and drills. BVES solicits feedback from the local government and other agencies on its emergency preparedness communication plans and protocols, to incorporate ongoing improvements.
 - b. **During / After Emergencies:** When an emergency occurs, BVES notifies all relevant local government and agencies immediately to ensure proper response coordination. The Customer Care & Operations Support Supervisor and other staff performing customer and public information functions work closely to coordinate with counterparts including the local government and other agencies, providing outage and emergency notifications, estimated time to restore service, and periodic updates as available. BVES continues to provide timely communications to all parties until the situation has been resolved. These notifications happen through phone, text, email and in-person communications.

2. **Mountain Mutual Aid Association (MMAA) Participation:** The MMAA works in conjunction with the local fire department. BVES's outreach and engagement with the MMAA is similar to the collaborative approach used with local government and agency communications. Specifically, the goal is to inform, prepare, and coordinate closely with community first responders and aid workers.
 - a. **Before Emergencies:** Proactive briefings center on how the plan impacts the surrounding community based on BVES's utility infrastructure. Briefings may be conducted through email, training, remote collaboration tools, and in-person meetings, among others. BVES gains valuable feedback from MMAA to harmonize its emergency preparedness, communication plans, and overall protocols to align with other community partners aligned in their goal of public safety.
 - b. **During / After Emergencies:** When an emergency occurs, BVES notifies MMAA members immediately to effectuate a coordinated response. BVES continues to provide timely communications and participate in coordinated activities until the situation has been resolved. Communication and notifications happen through phone, text, email and in-person communications, among others.

3. **CPUC Reporting:** BVES’s communication with the CPUC aligns with mandates and requirements.
 - a. **Before Emergencies:** BVES submits its Fire Prevention Plan, WMP, and EDRP, and PSPS Plans for review and input. All plans are designed to work together to minimize the impact of outages and infrastructure-related events and, most importantly, protect the public safety.
 - b. **During / After Emergencies:** BVES notifies the Director of Safety Enforcement Division (SED) within 12 hours of the power being shut off. BVES also notifies the CPUC and Warning Center at the Office of Emergency Services in San Bernardino within one hour of shutting off the power if the outage meets the major outage criteria of GO 166.

BVES provides a written report to the Director of SED no later than 10 business days after a shut off event ends per ESRB-8. The utility complies with all analysis and report requests during and after any emergencies. Outage data shall also be included in BVES’s annual reliability indices report to the CPUC.

BVES engages in this activity to verify that the programs they have developed and the tools that are being used are at an equivalent or higher level to its California counterparts as well as its counterparts outside of the State of California. BVES is implementing a strategy and preparing actions to engage with agencies outside of California to exchange best practices both for utility wildfire mitigation and for stakeholder cooperation to mitigate and respond to wildfires.

8.4.4.1 Protocols for Emergency Communications (COE_2)

The electrical corporation must identify the relevant community stakeholder groups in its service territory and describe the protocols, practices, and procedures used to provide notification of wildfires, outages due to wildfires and PSPS, and service restoration before, during, and after each incident type. Community stakeholder groups include, but are not limited to, the general public, priority essential services, AFN populations, non-English speakers, tribes, and people in remote or isolated areas. The narrative must include a brief discussion on the decision-making process and use of best practices to ensure timely, accurate, and complete communications. The narrative must be no more than one page.

The electrical corporation must also provide, in tabular form, details of the following:

- *Methods for communicating*
- *Means to verify message receipt*

Table 8-49 Protocols for Emergency Communication to Public Stakeholder Groups

Stakeholder Group	Event Type	Method(s) for Communicating	Means to Verify Message Receipt
All Listed Above	All Listed Above	Email	Read Receipt If read receipt not confirmed phone contact is made

Stakeholder Group	Event Type	Method(s) for Communicating	Means to Verify Message Receipt
State Agencies	PSPS Notifications PSPS Restoration Wildfire – Outage or Other Information Wildfire – Repair & Maintenance Information	Email (preferred) Voice & SMS (back up) Website PSPS Portal	Read Receipt If read receipt not confirmed phone contact is made
Public Safety Partners	PSPS Notifications PSPS Restoration Wildfire – Outage or Other Information Wildfire – Repair & Maintenance Information	Email (preferred) Voice & SMS (back up) Website PSPS Portal	Read Receipt If read receipt not confirmed phone contact is made
Critical facilities and Infrastructure	PSPS Notifications PSPS Restoration Wildfire – Outage or Other Information Wildfire – Repair & Maintenance Information	Email (preferred) Voice & SMS (back up) Website PSPS Portal	Read Receipt If read receipt not confirmed phone contact is made
Local governments	PSPS Notifications PSPS Restoration Wildfire – Outage or Other Information Wildfire – Repair & Maintenance Information	Email (preferred) Voice & SMS (back up) Website PSPS Portal	Read Receipt If read receipt not confirmed phone contact is made
First responders	PSPS Notifications PSPS Restoration Wildfire – Outage or Other Information Wildfire – Repair & Maintenance Information	Email (preferred) Voice & SMS (back up) Website PSPS Portal	Read Receipt If read receipt not confirmed phone contact is made
<i>Tribal governments – there are no Tribal governments in BVES's service area.</i>	N/A	N/A	N/A
Local media	PSPS Notifications PSPS Restoration Wildfire – Outage or Other Information Wildfire – Repair & Maintenance Information	Email (preferred) Voice & SMS (back up)	Read Receipt If read receipt not confirmed phone contact is made

Stakeholder Group	Event Type	Method(s) for Communicating	Means to Verify Message Receipt
All customers including AFN and MBL	PSPS Notifications PSPS Restoration Wildfire – Outage or Other Information Wildfire – Repair & Maintenance Information	Text Power (SMS), IVR (voice message), Website, Social Media,	Text Power & IVR message delivery information available in system
General Public	PSPS Notifications PSPS Restoration Wildfire – Outage or Other Information Wildfire – Repair & Maintenance Information	Website Updates, Social Media Updates, Press Releases	Website & Social Media visit data available

BVES utilizes email to communicate to Public Stakeholder Groups. A “read receipt” is utilized to verify receipt of messages. If BVES does not receive a “Read Receipt” in a timely manner, we will contact the Stakeholder by phone. If the contact cannot be reached by phone, then the general contact number for the Stakeholder group will be called. It is critical for BVES to maintain an up-to-date Public Stakeholders Group list. Any out-of-date contact information can limit or delay communications with a Public Stakeholders.

Current gaps and limitations of Bear Valley’s communication plan include:

- reliance on email,
- phone verification may be difficult, especially under emergency conditions,
- presence on social media needs improvement, and
- need to increase the messaging channels to AFN customers (mail, email, text, website, social media, radio ads, paper ads, etc.).

BVES will continue to develop the communications strategies to mitigate or eliminate the gaps listed above.

BVES Table 8-11 Category Entity Primary Contact List

Category	Entity	Primary
Law enforcement	Sheriff’s Department Big Bear Lake Patrol Station	Lt. Kelly Craig Lieutenant 909-420-5620 kcraig@sbcasd.org
Medical	Bear Valley Community Hospital	John P. McKinney MPT Director of Physical Therapy/PIO 909-744-2231 John.mckinney@bvchd.com
	Bear Valley Hospice	Cary Steward 949-338-7252 admin@bearvalleyhospice.com

Category	Entity	Primary
Fire Department	Big Bear Fire Department Headquarters- Station 281 41090 Big Bear Blvd	Jeff Willis Fire Chief 909-731-4825 Jeff.willis@bigbearfire.org
City & County Facilities	City of Big Bear Lake City Hall (includes Emergency Operations Center)	Jeff Mathieu Interim City Manager 909-633-1575 jeffmathieu@citybigbearlake.com
Communications providers	Verizon Wireless	Chris Sinner 714-669-3535 Chris.sinner@verizonwireless.com
Communications providers	Verizon Wireless	Jane Whang 415-778-1022 Jane.whang@verizon.com
Communications providers	AT&T Wireless	Kevin Quinn 818-731-4000 Kq8185@att.com
Communications providers	AT&T Wireless	Joshua Overton 209-406-6712 Jo2147@att.com
Communications providers	AT&T Wireless	Joshua Mathisen Jm6347@att.com
Communications providers	AT&T Wireless	John Goddard Jq266q@att.com
Communications providers	Frontier California Inc.	Bret Plaskey 909-748-7880 Bret.p.plaskey@ftr.com
Communications providers	Frontier California Inc.	Charlie Born 916-686-3570 Charlie.born@ftr.com
Communications providers	Sprint	Jake Osorio 818-317-0276 SPR-Inspections@motive-energy.com
Communications providers	Charter Communications	Robert Fisher 760-674-5404 Robert.fisher@charter.com
Communications providers	Charter Communications	Lynn Notarianni 720-518-2585 Lynn.notariani@charter.com
Communications providers	Charter Communications	Dan Gonzalez Dan.gonzales@charter.com
Communications providers	T-Mobile	Saif Abdullah 714-757-7075 Saif.abdullah@t-mobile.com
Communications providers	T-Mobile	Steve Kukta 414-572-8358 Stephen.H.kukta@t-mobile.com

Category	Entity	Primary
Communications providers	T-Mobile	Vivek Kurisunkal Vivek.kurisunkal@t-mobile.com
Radio stations	KBHR	Cathy Herrick 9099-499-4825 Cathy@kbhr933.com
Utilities	City of Big Bear Lake Department of Water	Danny Ent 909-816-7709 dent@bbldwp.com
Utilities	Big Bear Area Regional Wastewater Agency (BBARWA)	John Shimmin 760-808-1256 jshimmin@bbarwa.org
Utilities	Big Bear City Community Services Department (CSD)	Mary Reeves 909-936-9521 mreeves@bbccsd.org
Utilities	Edison (SCE)	Bryan Falconer Account Manager 626082603745 Bryan.falconer@sce.com
Utilities	Southwest Gas (SWG)	Phillip Petteruto Superintendent Operations 909-366-4869 Phillip.petteruto@swgas.com
Utilities	Southwest Gas (SWG)	SWG Dispatch 877-760-6020 snvdispatch@swgas.com
Utilities	Big Bear Municipal Water District (MWD)	Mike Stephenson General Manager 909-289-5157 mstephenson@bbmwd.net
Airports	Big Bear Airport District	John Melissa 909-904-7700 jmelissa@flybigbear.com
Schools	Bear Valley Unified School District	Dr. Mary Suzuki Superintendent of Schools 909-638-6851 Mary_suzuki@bearvalleyusd.org
Resorts	Big Bear Mountain Resorts	Mark Burnett Sr. Director Facilities 909-725-4017 mburnett@bbmr.com

8.4.4.2 Messaging (EP_3)

In this section, the electrical corporation must describe its process and approach for developing effective messaging to reach the largest percentage of public stakeholders in its service territory before, during, and after a wildfire, an outage due to wildfire, or a PSPS event.

In addition, the electrical corporation must provide an overview of the development of the following aspects of its communication messaging strategy:

- *Features to maximize accessibility of the messaging (e.g., font size, color analyzer)*
- *Alert and notification schedules*
- *Translation of notifications*
- *Messaging tone and language that is specific, consistent, confident, clear, and accurate*
- *Key components and order of messaging content (e.g., hazard, location, time)*

The narrative must be no more than one page.

BVES's communications plan before, during and after a wildfire, an outage due to wildfire, or a PSPS event is designed develop effective messaging to reach the largest percentage of Public Stakeholders and includes the following elements:

Pre-Incident Outreach and Education. *A community that is knowledgeable and ready for emergency events will be a force multiplier in emergency response actions.*

BVES coordinates with local officials in compliance with Public Utilities Code section 768.6 and provides designated points of contact an opportunity to comment on draft and/or existing emergency plans.

BVES utilizes its website, social media, workshops, press releases, advertising, newsletters, bill inserts, two-way text communication, IVR, and other methods to provide information on emergency readiness preparation (including customer checklist for emergencies), backup generator safety information, reporting outages and emergencies, wire down event reporting/safety, PSPS, wildfire prevention measures, and outage restoration strategies. BVES maintains stakeholder contact lists, periodically briefs key elements on emergency plans at local stakeholder and public meetings and establishes strong working relationships with stakeholders. Stakeholders include at a minimum those listed in Section 8.4.1.

Provide Emergency Incident Communications. BVES believes achieving unity of effort provides for the most effective and efficient emergency response. This is best attained through the "4 C's" of disaster planning: (1) Collaboration, (2) Cooperation, (3) Coordination, and (4) Communication. During a wildfire or PSPS event, BVES strives to provide stakeholders, public and customers: extent of event, cause of the event, and estimated time of restoration. This information is provided at the start of the event, updated when new information is available, at a minimum every 2-3 hours during the event, and upon restoration from the event.

BVES strive to provide stakeholders, customers, and the public with reliable emergency notifications such that correct expectations are set and trust is developed. BVES develops consistent and accurate communications (if incorrect information is issued, a correction is issued and qualifies or avoids providing uncertain information). BVES establishes internal processes to ensure required regulatory notifications are made in a timely manner.

BVES keeps local officials and other key stakeholders informed of emergencies, which is critical to their ability to operate and support their missions. BVES utilizes standard press statement templates with fill-in-the-blank sections to update customers and the public with the "who, where, why, what, when, and how" to the emergency event. Short IVR and text messages are used to refer customers to additional resources (e.g., website or social media). BVES proactively engages media to reach a wide audience to convey correct information to the public.

BVES maintains "call center metrics" that measure customer access to information during an event and uses multiple channels to reach targeted audiences and issues alerts in English,

Spanish, Chinese (including Cantonese, Mandarin and other Chinese languages), Tagalog, Vietnamese, Zapateco, and Mixteco.

Post Emergency Event Close-out Statement. Once the emergency event passes, BVES prepares a summary press release providing customers and stakeholders a summary of the event and instructions such as: how to contact BVES to reconnect service and repair damaged equipment and how to obtain additional post incident customer support.

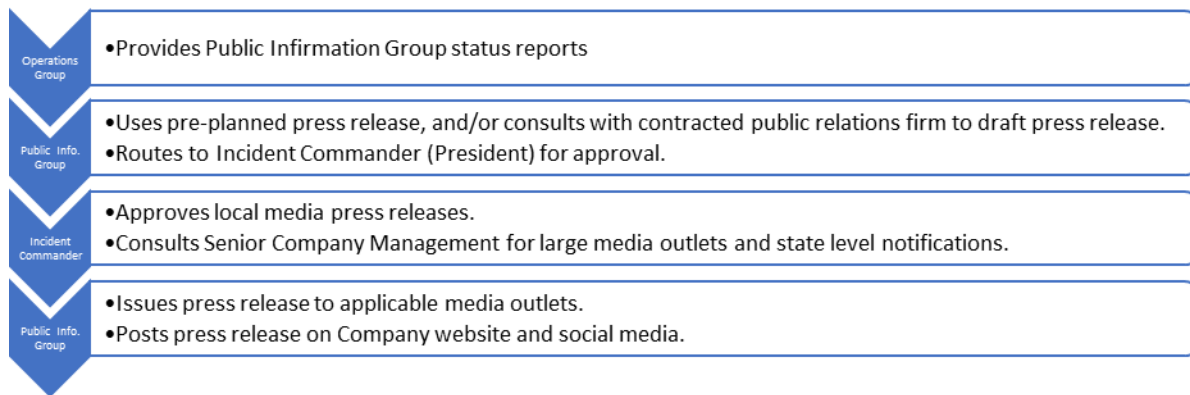

Figure 8-12 BVES Press Release Protocol

8.4.4.3 Current Gaps and Limitations

In tabulated format, the electrical corporation must provide a list of current gaps and limitations in its public communication strategy. Where gaps or limitations exist, the electrical corporation must indicate the remedial action plan and timeline for resolving. For all requested information, the electrical corporation should indicate a form of verification that can be provided upon request for compliance assurance. Table 8-49 provides an exemplar of the minimum level of content and detail required.

Table 8-50 Key Gaps and Limitations in Public Emergency Communication Strategy

Gap or Limitation Subject	Remedial Brief Description	Remedial Action Plan
Reliance on email communication	N/A	N/A
Lack of social media presence	N/A	N/A
AFN communication methodology	N/A	N/A

8.4.5 Preparedness and Planning for Service Restoration

8.4.5.1 Overview of Service Restoration Plan (EP_4)

In this section of the WMP, the electrical corporation must provide an overview of its plan to restore service after an outage due to a wildfire or PSPS event. At a minimum, the overview must include a brief description of the following:

- *Purpose and scope of the restoration plan.*
- *Overview of protocols, policies, and procedures for service restoration (e.g., means and methods for assessing conditions, decision-making framework, prioritizations, degree of customization). The electrical corporation must provide an:*
- *Operational flow diagram illustrating key components of the service restoration procedures from the moment of the incident to response, recovery, and restoration of service.*
- *Resource planning and allocation (e.g., staffing, equipment).*
- *Drills, simulations, and table-top exercises.*
- *Coordination and collaboration with public safety partners (e.g., interoperable communications).*
- *Notification of and communication to customers during and after a wildfire- or PSPS-related outage.*

The electrical corporation may refer to its Public Utilities Code section 768.6 emergency preparedness plan to provide more detail. Where the electrical corporation has already reported on the requested information in another section of the WMP, it must provide a cross-reference with hyperlink to that section. The overview must be no more than one page.

Reference the Utility Initiative Tracking ID where appropriate.

BVES recognizes the importance of establishing service restoration procedures and protocols. BVES's methodology for assessing conditions, prioritizing decisions, and allocating resources (staff and equipment) are defined in the BVES EDRP, located in Appendix F. BVES's EDRP complies with the requirements set forth in the General Order No. 166, Standards for Operation, Reliability, and Safety during Emergencies and Disasters.

Promptly assembling the Emergency Operations Center (EOC) is a crucial aspect of BVES's EDRP. The EOC is the central command and control facility responsible for carrying out the EDRP principles of emergency preparedness and emergency response functions during emergency events. The Utility Manager is responsible for ensuring the EOC provides support to BVES regarding strategic direction, operational decisions, and restoration activities. The EOC also collects and analyzes data to assess emergency response and prioritize decisions.

Leading up to a PSPS event, during a PSPS event, and during the PSPS restoration period, the Emergency Response Communications Plan of the EDRP is implemented in conjunction with the BVES PSPS Plan. Please refer to Appendix B and C of the BVES PSPS Plan where resource planning, public safety partner collaboration, and customer communication protocols during emergency events are discussed in detail.

During a PSPS event, if there is a downgrade in wildfire risk and wind speeds in the affected area drop below 50 mph for a period of 20 minutes, crews begin assessing the fire weather conditions. If the crew determines the fire weather conditions have subsided to "safe levels", BVES will begin the restoration of de-energized circuits. However, the crews will extend the calm period beyond 20 minutes, if further gusts of greater than 50 mph are likely based on their direct observation of local conditions or forecasts. Restoration activities which occur prior to re-energization include:

1. Validating that the extreme fire weather conditions have subsided to safe levels.
2. Conducting field inspections and patrols of facilities that were de-energized.
3. Repair of any identified immediate hazards (Level 1 inspection conditions).
4. Re-energization of inspected circuits.

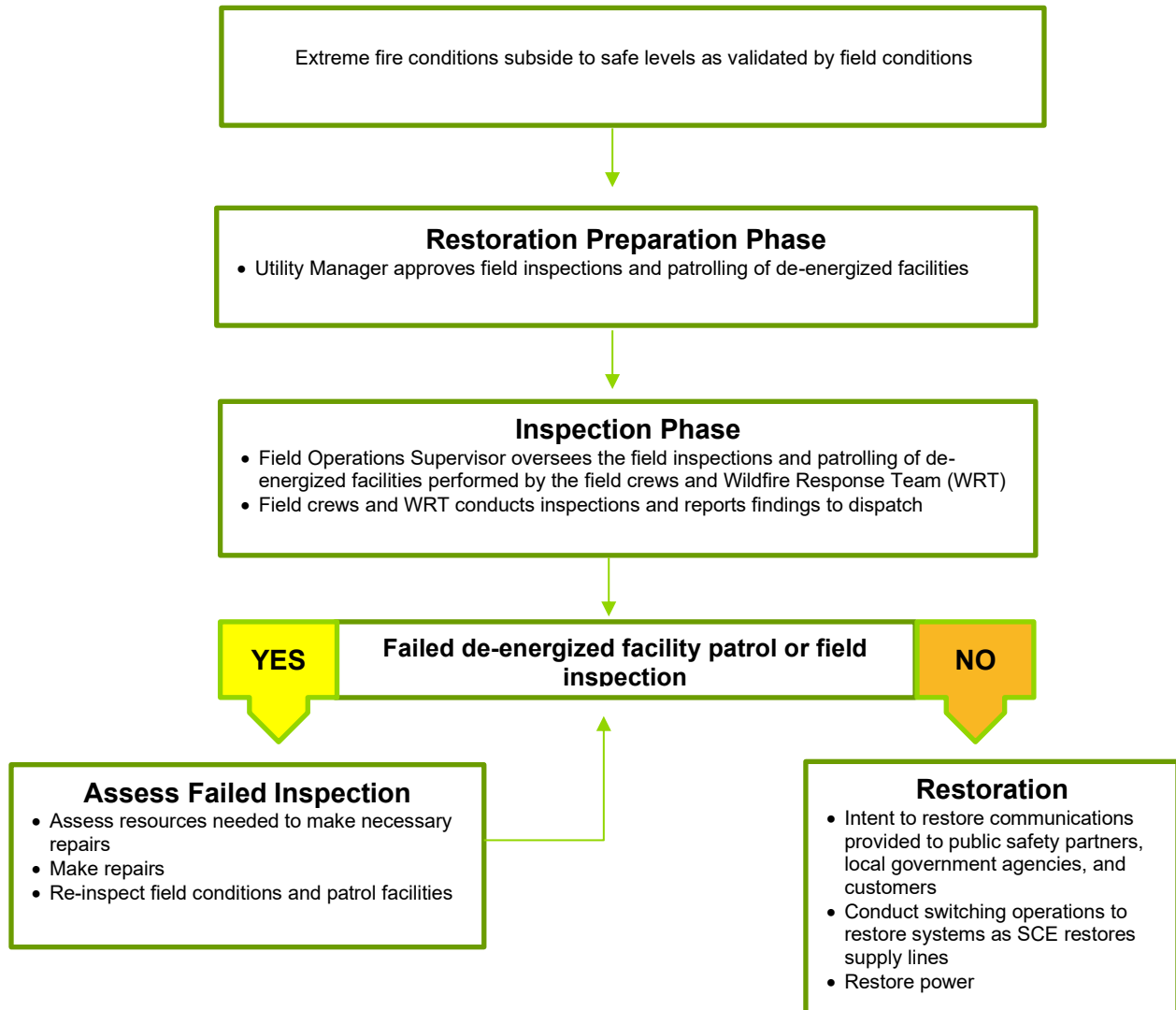

BVES Figure 8-6: Service Restoration Procedures

A comprehensive template outlining the communications plan for notifying public safety partners during a potential PSPS activation can be found in BVES PSPS Plan. Developing communication and notification procedures is a collaborative effort across public safety partners and local jurisdictions, although BVES is ultimately responsible and accountable for the safe deployment of PSPS activations and restoration activities. BVES has coordinated with emergency responders, fire, and local governments to seamlessly integrate communication protocols with a goal of providing secondary notices as warranted.

8.4.5.2 Planning and Allocation of Resources (EP_1)

The electrical corporation must briefly describe its methods for:

- Planning appropriate resources (e.g., equipment, specialized workers), and
- Allocating those resources to assure the safety of the public during service restoration

In addition, the electrical corporation must provide an overview of its plans for contingency measures regarding the resources required to:

- Respond to an increased number of reports concerning unsafe conditions, and
- Expedite a response to a wildfire- or PSPS-related power outage

This must include a brief narrative on how the electrical corporation:

- *Uses weather reports to pre-position manpower and equipment before anticipated severe weather that could result in an outage,*
- *Sets priorities,*
- *Facilitates internal and external communications, and*
- *Restores service*

- Before season starts, BVES plans and allocates resources to respond wildfires or PSPS events:
 - Establishes emergency contracts for essential restorative services.
 - Reviews and ensures mutual assistance agreements are sufficient.
 - Conducts outreach with stakeholders and customers to prepare for emergencies.
 - Builds up on site contingency inventories of materials.
 - Conducts training on EDRP and PSPS Procedures through table-top exercises and drills.
 - Ensures staff is sufficient to provide immediate response and plans.

- If there is a wildfire or conditions are approaching PSPS thresholds, BVES will enact their Public Safety Power Shutoff Plan (*BVES INC 2023 PSPS Procedures Final 022623*) and Table 5-1. The plan includes specific weather references including:
 - Frequently review weather and threat assessments.
 - Review Technosylva's WFA-E and conduct fire spread simulations at high-risk spots.
 - Notify meteorology consultant to provide more frequent forecasts.
 - Frequently monitor BVES installed weather stations.
 - Monitor local wind gusts in "at risk" areas.

There are three outage response levels at BVES. Level 1 and 2 pertain to the EDRP and are used to describe EOC activation and restoration responses. Level 3 refers the normal BVES working hours and afterhours Field Operations and Customer Service outage response procedures during normal T&D operations. The response levels are:

- Level 1 (High Risk, Long-Term – more than 12 hours) EOC is fully Activated and EDRP processes implemented.
- Level 2 (Moderate Risk, Short-Term) EOC is partially activated and EDRP processes implemented.
- Level 3 (Low Risk, Short –Term) Normal Service. Crew/Dutyman and Customer Serve Processes.

When BVES activates the EDRP, the EOC is also activated. BVES leadership considers the following in evaluating whether to implement the EDRP and to what Level to activate the EOC:

- Will resources beyond BVES' normal outage response posture be required and to what extent? Will external resources (mutual aid /or contracted services be required)?
- Will the restoration efforts be long-term (generally >12 hours)? If long-term, how long?
- Will around the clock Customer Service and Field Operations be needed?
- Will restoration efforts require management/logistics support beyond Field Operations Supervisor?
- Is the outage (or potential outage) expected to significantly impact on BVES customers?
- Depending on the situations, the response level is established, and priorities are set. If reports concerning unsafe conditions increase, the response level will be increased, and

additional help will be activated. In most cases resources shall be dispatched to restore systems to achieve the following restoration priorities:

- **Public safety** in the affected areas;
- **Worker safety** in performing the restoration work;
- **Critical infrastructure** key City & County facilities, other utility facilities (water, sewage, gas, communications), Airport, Traffic Control, Incident Commander Site, Incident Base Camp, Incident Evacuation Centers, communications providers, radio stations;
- **Continuity of community services** Major commercial activities critical to the community e.g., gas stations, food stores, lodging for first responders, financial institutions;
- **Medical Baseline Customers** and **Access and Functional Needs Customers**
- **Number of customers** affected; and
- **Length of time** customers have been without power.

When directing restoration efforts, the Operations Group shall prioritize restoring the following types of facilities in the prescribed order to optimally restore electric service:

- Energy supply sources
 - Sub-transmission circuits (34.5 kV)
 - Substations
 - Distribution circuits (4 kV)
 - Feeders
 - Distribution transformers
 - Individual Customer Service lines

The following table provides guidance on restoration priorities in the event of a wildfire or PSPS.

BVES Table 8-12 Restoration Priorities Guidance

Priority	Sub-Transmission Circuit	Substation	Distribution Circuit		Comments
1	Baldwin	Meadow	Garstin		<ul style="list-style-type: none"> • Key critical infrastructure • Connects BVPP
2	Shay/Radford	Pineknot Village Maltby Division	Interlaken Boulder Harnish Country Club	Georgia Paradise Erwin Lake Castle Glen	<ul style="list-style-type: none"> • Additional critical infrastructure • Major commercial activities & airport • Large number of residential customers.
3	NA	Moonridge Maple Bear City Fawnskin Palomino	Eagle Lagonita Fox Farm Clubview Sunset	Goldmine Holcomb Pioneer Sunrise	<ul style="list-style-type: none"> • Mostly residential customers

Priority	Sub-Transmission Circuit	Substation	Distribution Circuit		Comments
4	NA	Bear Mountain Summit Lake	Geronimo Skyline	Lift Pump House	<ul style="list-style-type: none"> • Mostly interruptible customer.

- Establishing a multi-layered communications plan utilizing many separate communications channels is essential to ensuring that the communications plan shall be effective in reaching targeted audiences under uncertain and severe conditions, as would be expected for major outages and disasters and/or following such events. For example, some customers may lose their landline capability in a power outage but still have cell phone service. Plan resiliency is therefore dependent on having many overlapping layers of communications.

8.4.5.3 Drills, Simulations, and Table-top Exercises

Discussion-based and operational-based exercises enhance knowledge of plans, allow personnel to improve their own performance, and identify opportunities to improve capabilities to respond to wildfire- and PSPS-related service outages. Exercises also provide a method to evaluate a electrical corporation's emergency preparedness plan and identify planning and/or procedural deficiencies.

Internal Exercises

The electrical corporation must report on its program(s) for conducting internal discussion-based and operations-based exercises for service restoration. This must include, at a minimum, the types of discussion-based exercises (e.g., seminars, workshops, table-top exercises, games) and operations-based exercises (e.g., drills, functional exercises, full-scale exercises), the purpose of the exercises, the frequency of internal exercise programs, the percentage of staff who have completed/participated in exercises and means for verification of internal exercises.

- *The types of discussion-based exercises (e.g., seminars, workshops, table-top exercises, games) and operations-based exercises (e.g., drills, functional exercises, full-scale exercises)*
- *The purpose of the exercises*
- *The schedule and frequency of exercise programs*
- *The percentage of staff who have completed/participated in exercises*
- *How the electrical corporation tracks who has completed the exercises*

An example of the minimum acceptable level of information is provided in Table 8-51.

Table 8-51 Internal Drill, Simulation, and Table-top Exercise Program for Service Restoration

Category	Exercise Type	Purpose	Exercise Frequency	Position of Title of Personnel Required to Participate	Personnel Required	Personnel Completed	Form of Verification or Reference
Discussion-based	Table-top	Wildfire and PSPS Preparation	Once per year	President, Utility Manager, Field Operations Supervisor, Utility Engineer & Wildfire Supervisor, Customer Program Specialist, Accounting Supervisor, Logistic Group Leader, Others as required	8	8	Exercise reported to the CPUC

External Exercises

The electrical corporation must report on its program(s) for conducting external discussion-based and operations-based exercises for service restoration due to wildfire. This must include, at a minimum, the types of discussion-based exercises (e.g., seminars, workshops, table-top exercises, games) and operations-based exercises (e.g., drills, functional exercises, full-scale exercises), the schedule and frequency of external exercise programs, the percentage of public safety partners who have participated in these exercises and means for verification of external exercises.

An exemplar of the minimum acceptable level of information is provided in Table 8-51.

- *The types of discussion-based exercises (e.g., seminars, workshops, table-top exercises, games) and operations-based exercises (e.g., drills, functional exercises, full-scale exercises)*
- *The schedule and frequency of exercise programs*
- *The percentage of public safety partners who have participated in these exercises*
- *How the electrical corporation tracks who has completed the exercises*

BVES conducts at least one table-top and one functional simulation exercise annually. These exercises involve participating stakeholders from the Big Bear community and be coordinated with CPUC Cal Fire, Cal OES, communication providers, AFN representatives, and other public safety partners. Additionally, BVES coordinates with these stakeholders to develop and plan the exercises. The exercises seek to prepare BVES and its community partners for a PSPS and enhance their performance, communication protocols, notification practices, and restoration procedures and test the functionality of the plan to the extent

practicable. BVES keeps detailed records of these plans and submits reports of these exercises to the CPUC as required. BVES also reviews the exercises to identify strengths and weaknesses of BVES actions, and seek to incorporate lessons learned, as appropriate.

Table 8-52 External Drill, Simulation, and Table-top Exercise Program for Service Restoration

Category	Exercise Type	Purpose	Exercise Frequency	Position of Title of Personnel Required to Participate	Personnel Required	Personnel Completed	Form of Verification or Reference
Discussion-based	Table-top	Wildfire and PSPS Preparation	Once per year	President, Utility Manager, Field Operations Supervisor, Utility Engineer & Wildfire Supervisor, Customer Program Specialist, Accounting Supervisor, Logistic Group Leader, Others as required	12	14	Exercise reported to the CPUC
Operations-based	Functional	Wildfire and PSPS Preparation	Once per year	President, Utility Manager, Field Operations Supervisor, Utility Engineer & Wildfire Supervisor, Customer	12	14	Exercise reported to CPUC

Category	Exercise Type	Purpose	Exercise Frequency	Position of Title of Personnel Required to Participate	Personnel Required	Personnel Completed	Form of Verification or Reference
				Program Specialist, Accounting Supervisor, Logistic Group Leader, Others as required			

8.4.6 Customer Support in Wildfire and PSPS Emergencies (EP_5 - COE_1 – COE_2 – COE_3 – COE_4)

In this section of the WMP, the electrical corporation must provide an overview of its programs, systems, and protocols to support residential and non-residential customers in wildfire emergencies and PSPS events. The overview for each emergency service must be no more than one page. At a minimum, the overview must cover the following customer emergency services, per Public Utilities Code section 8386(c)(21):

- *Outage reporting*
- *Support for low-income customers*
- *Billing adjustments*
- *Deposit waivers*
- *Extended payment plans*
- *Suspension of disconnection and nonpayment fees*
- *Repair processing and timing*
- *List and description of community assistance locations and services*
- *Medical Baseline support services*
- *Access to electrical corporation representatives*

Reference the Utility Initiative Tracking ID where appropriate.

In the event of a major emergency, BVES has a dedicated customer support team to help impacted customers by providing information on available resources. All customer inquiries during major emergencies, such as wildfire, are prioritized. BVES's efforts to reach, engage and support AFN communities, including by developing partnerships with CBOs and providing for AFN needs at CRCs, can be found in BVES's AFN Plan Quarterly Update reports and the AFN Plan filed on January 31, 2023.

All customer inquiries during major emergencies, such as wildfire, are prioritized. During an emergency BVES attempts to reach, engage, and support AFN communities as well as the Functional Needs Populations. BVES has programs available to customers to help them through emergencies. BVES continues to improve communications to promote awareness and provide access to information and resources needed to mitigate the safety and economic impacts. BVES provides the following programs to deliver customer support during wildfire and PSPS emergencies: outage reporting, support for low-income customers, billing adjustments, deposit waivers, extended payment plans, suspension of disconnection and nonpayment fees, repair processing and timing, list and description of community assistance locations and services, medical baseline support services, and access to electrical corporation representatives. These programs are further described below:

- **Outage reporting** – BVES uses best practices to provide customers with the most up-to-date information regarding outages and emergency communications, and to provide resources for reporting outages. BVES notifies State and Local Agencies (Section 8.4.3.1), Public Policy Partners (Section 8.4.3.2), Mutual Aid Associations (Section

8.4.3.3), and Stakeholders (Section 8.4.4.1) as directed in the BVES EDRP (Appendix F Sections 5.4 and 6.8). BVES provides multi-layered customer outreach communication programs including automated calls (IVR), automated text messages (Text Power), social media, email alerts, radio announcements, press releases, and updates on its website. The Operations Group is tasked with providing the Public Information Group, as a top priority, the following information regarding outages due to wildfire or PSPS: (1) extent of the outage including number of customers affected; (2) cause of the outage (if known) and status of BVES response (e.g., crews on site investigating, crews on site conducting repairs, etc.); (3) estimated time to restore (ETR) power – this must be updated and not allowed to go stale (e.g., ETR time passes without an update. The Public Information Group is responsible for updating local government, first responders, other community stakeholders, and customers including AFN and MBL customers with this information. Additionally, once power is restored, this must be communicated to the Public Information Group so that they can update local government, first responders, other community stakeholders, and customers including AFN and MBL customers.

- Support for low-income customers – To support for low-income customers BVES offers qualifying customers discounted rates on their electricity bill through California Alternate Rate for Energy (CARE) program. BVES maintains a list of low-income customers that we will provide outreach to, as required based on the emergency situation. BVES provides a list of community assistance programs on its website and advertise them through its media outlets. The Customer Care Team shall freeze accounts in these programs and stop billing during the disaster event to ensure bills are not estimated or generated for affected customers. Billing shall resume once the case is closed by the Customer Care & Billing (CC&B) technical team, upon notice from the Supervisor.
- Billing adjustments – The Customer Care Team shall freeze accounts and stop billing during the disaster event to ensure bills are not estimated or generated for affected customers. Billing shall resume once the case is closed by the Customer Care & Billing (CC&B) technical team, upon notice from the Supervisor.
- Deposit waivers – The Customer Care Team shall add a designated customer contact for all affected customers. The contact shall reside within CC&B for up to one year from the date the emergency ends. This allows BVES to track the customer's account, so when service is restored, the utility knows to waive any associated fees and to expedite customer reconnection.
- Extended payment plans – The Customer Care Team shall freeze all payments on affected customers' account to avoid affecting their credit. All affected customers are notified that an extended payment plan option is available for any past due payments.
- Repair processing and timing – During emergencies, BVES shall set up specialized repair teams to expedite repair processing. If additional support is needed, BVES will leverage mutual aid programs with other emergency response resources and work with electrical contractors to ensure timely service restoration. This is covered in Section 6.6 of BVES's EDRP (Appendix F)
- List and description of community assistance locations and services – BVES provides outreach to inform customers of available community assistance. BVES provides the information on its website, outreach to its Community Based Organization's (CBO), advertisements through social media, outreach to mobile home park managers, and bus stop ads. During PSPS events, BVES uses Community Resource Centers to provide support to customers in areas most likely to experience shutoffs. These locations

provide customers with water, light snacks and, access to restrooms and Wi-Fi. Customers can also obtain updated outage information, sign up for alerts, update their contact information and charge their personal mobile and certain portable medical devices.

- Medical Baseline support services – BVES updates the current list of medical baseline and AFN customers bi-monthly. This information is distributed internally, and the list is on the PSPS portal for critical facilities to access if needed. BVES also will provide automated calls, texts, emails, or door tags depending on the emergency. This program provides customers electricity at a discounted rate, helping to reduce monthly utility costs. Medical Baseline customers receive additional program eligibility for BVES's Critical Care Backup Battery Program. This program supports customers' ability to utilize their medical equipment in the event of an outage, including an outage caused by a PSPS event or a wildfire. BVES also works with regional agencies and partners to support customer needs before and during PSPS events. Additionally, enrollment as a Medical Baseline customer adds protections during PSPS activations and prior to disconnections through an escalated notification process.
- Access to electrical corporation representatives BVES representatives are available by phone on a 24-hour basis during an emergency. BVES regularly provides updated emergency information to the local radio station and press. Whenever possible, BVES management proactively provides management responses through the return of telephone calls or through local websites (e.g., Facebook) to keep customers informed of the emergency situation. BVES may direct staff and resources to county and local government assistance centers during disasters or PSPS events to provide in-person support.

8.5 Community Outreach and Engagement

8.5.1 Overview

Community outreach, public awareness, and communications efforts are required to reduce the impact to customers and the community from an event causing interrupting of service and/or poses serious public risks. Effective planning and awareness also assist in limiting the scope of extreme events and avoiding escalation. BVES has altered how the company addressed the risk of catastrophic wildfires due to the increased presence of potential wildfire due to climate changes and environmental conditions. BVES works year-round to educate customers and the general public and works with community partners to improve outreach, awareness, and communications.

The Energy Resource Manager oversees communications plans and activities. Reporting to the Energy Resource Manager is the Customer Service Supervisor, who manages communication activities. BVES's communication plan includes a two-pronged approach (1) proactive preparation before emergencies occur and (2) notifications during and after emergency events. Communications protocols vary slightly when dealing with stakeholders that include customers, first responders, the local mutual aid association, local government, among other key stakeholders.

The list below describes the goals and methods of informing each of these groups.

Customer Outreach and Notifications: The goal of customer outreach is to educate and prepare customers for fire prevention, proactive de-energization, and other utility infrastructure-related emergencies. Communication formats are planned in English, Spanish, Tagalog, Vietnamese, Chinese, French, Mixteco and Zapoteco for online resources and when requested by customers. BVES is continuing to enhance its community outreach activities and has conducted a self-identified survey process to account for these populations. Indigenous communities surrounding the service area are investigated to account for the unique languages representing English as a Second Language (ESL) speakers. BVES collaborates with other community organizations to assure that a local community resource center is available to customers during emergencies. BVES aligns its communication with other organizations, so it is clear and consistent among the local and state organizations.

8.5.1.1 Objectives

In this section BVES summarizes the objectives for its 3-year and 10-year plans for implementing and improving its community outreach and engagement in Table 8-53, below.

Table 8-53 Community Outreach and Engagement Initiative Objectives (3-year plan)

Objectives for Three Years (2023-2025)	Applicable Initiative(s), Tracking ID(s)	Applicable Regulations, Codes, Standards, and Best Practices (See Notes)	Method of Verification (i.e., program)	Completion Date	Reference (Section and Page Number)
Continue to deploy and improve public outreach and education awareness program(s) for wildfires; outages due to wildfires, PSPS events, and protective equipment and device settings; service restoration before, during, and after the incidents and vegetation management. Evaluate effectiveness of outreach efforts.	Public outreach and education awareness program, COE_1	GO 166	Evaluate effectiveness of outreach efforts and adjust outreach efforts based on evaluation results	31-Dec-25	8.5.2; pg. 344

Objectives for Three Years (2023-2025)	Applicable Initiative(s), Tracking ID(s)	Applicable Regulations, Codes, Standards, and Best Practices (See Notes)	Method of Verification (i.e., program)	Completion Date	Reference (Section and Page Number)
<p>Continue to improve program to understand, evaluate, design, and implement wildfire and PSPS risk mitigation strategies, policies, and procedures specific to AFN customers. Evaluate effectiveness of these efforts.</p>	<p>Engagement with access and Functional Needs Populations, COE_2</p>	<p>GO 166</p>	<p>Evaluate effectiveness of efforts with AFN customers and adjust efforts based on evaluation results</p>	<p>31-Dec-25</p>	<p>8.5.3; pg. 348-350</p>
<p>Work with stakeholders to develop and integrate plans, programs, and/or policies for collaborating with communities on local wildfire mitigation planning, such as wildfire safety elements in general plans, community wildfire protection plans, and local multi-hazard mitigation plans. Evaluate effectiveness of these collaborative efforts.</p>	<p>Collaboration on local wildfire mitigation planning, COE_3</p>	<p>GO 166</p>	<p>Evaluate effectiveness of collaborating with communities on local wildfire mitigation plans and adjust outreach efforts based on evaluation results</p>	<p>31-Dec-25</p>	<p>8.5.4; pg. 351</p>

Objectives for Three Years (2023-2025)	Applicable Initiative(s), Tracking ID(s)	Applicable Regulations, Codes, Standards, and Best Practices (See Notes)	Method of Verification (i.e., program)	Completion Date	Reference (Section and Page Number)
Continue to be proactive in sharing and integration of best practices and collaborating with other electrical corporations on technical and programmatic aspects of WMP programs.	Best practice sharing with other utilities, COE_4	GO 166	Attend electrical corporation workshops that share best practices of WMP programs	31-Dec-25	8.5.5; 353-356

Table 8-54 Community Outreach and Engagement Initiative Objectives (10-year plan)

Objectives for Ten Years (2026-2032)	Applicable Initiative(s), Tracking ID(s)	Applicable Regulations, Codes, Standards, and Best Practices (See Notes)	Method of Verification (i.e., program)	Completion Date	Reference (Section and Page Number)
Implement social media and other effective platforms to increase public outreach and education awareness program(s) for wildfires; outages due to wildfires, PSPS events, and protective equipment and device settings; service restoration before, during, and after the incidents and vegetation management. Evaluate effectiveness of these outreach efforts.	Public outreach and education awareness program, COE_1	GO 166	Evaluate effectiveness of increased public outreach and education awareness program(s) and adjust outreach efforts based on evaluation results	31-Dec-25	8.5.2; pg. 344
Establish streamlined routine for sharing lessons learned and best practices among peers.	Best practice sharing with other utilities, COE_4	GO 166	Attend electrical corporation workshops that share best practices	31-Dec-25	8.5.5; pg. 353-356

8.5.1.2 Targets

Initiative targets are quantifiable measurements of activities identified in the WMP. Electrical corporations will show progress towards completing targets in subsequent reports, including QDRs and WMP Updates.

The electrical corporation must list all targets it will use to track progress on its grid design, operations, and maintenance for the next three years (2023–2025). Energy Safety’s Compliance Assurance Division and third parties must be able to track and audit each target.³⁷ For each initiative target, the electrical corporation must provide the following:

- Utility Initiative Tracking IDs
- Projected targets for the three years of the Base WMP and relevant units
- Quarterly, rolling targets for end of 2023 and 2024 (inspections only)
- For 2023–2025, the “x% risk impact.” The x% risk impact is the percentage risk reduction identified in Table 7-2 for a specific mitigation initiative (see Section 7.2.2.1 for calculation instructions)
- Method of verifying target completion

The electrical corporation’s targets must provide enough detail to effectively inform efforts to improve the performance (i.e., reduction in ignition probability or wildfire consequence) of the electrical corporation’s community outreach and engagement initiatives.

Table 8-55 Community Outreach and Engagement Initiative Targets by Year

Initiative Activity	Tracking ID	2023 Target & Unit	X% Risk Impact 2023	2024 Target & Unit	X% Risk Impact 2024	2025 Target & Unit	X% Risk Impact 2025	Method of Verification
Collaboration on local wildfire mitigation planning	COE_3	Develop Program	3.62%	Review and Maintain Program	3.62%	Review and Maintain Program	3.62%	Version History
Best practice sharing with other utilities	COE_4	Work Groups, Conferences	3.62%	15	3.62%	15	3.62%	Quantitative

Table 8-56 PSPS Outreach and Engagement Initiative Targets by Year

Initiative Activity	Tracking ID	Target End of Q2 2023 & Unit	Target End of Q3 2023 & Unit	End of Year Target 2023 & Unit	X% Risk Impact 2023	Target End of Q2 2024 & Unit	Target End of Q3 2024 & Unit	End of Year Target 2024 & Unit	X% Risk Impact 2024	Target 2025 & Unit	X% Risk Impact 2025	Method of Verification
Public outreach and education awareness program	COE_1	180	270	360	3.62%	180	270	360	3.62%	360	3.62%	Quantitative
Engagement with access and Functional Needs Populations	COE_2	6	9	12	3.62%	6	9	12	3.62%	12	3.62%	Quantitative

8.5.1.3 Performance Metrics Identified by BVES

For each performance metric listed in Table 8-57, BVES reports its performance since 2022, projected performance for 2023-2025, and the method of verification. Trends in performance are unavailable at this time due to the lack of historical data. BVES began tracking performance metrics for community outreach and engagement events in 2022 and will begin tracking AFN customer verifications in 2023. BVES will report on trends in future WMPs.

Table 8-57 Community Outreach and Engagement Performance Metrics Results by Year

Performance Metrics	2020	2021	2022	2023 Projected	2024 Projected	2025 Projected	Method of Verification (e.g., third-party verification, WMP)
Public outreach and education events	N/A	N/A	250	360	360	360	Third-party QDR verification
AFN customer verifications	N/A	N/A	N/A	12	12	12	Third-party QDR verification

8.5.2 Public Outreach and Education Awareness Program (COE_1 – COE_2 – COE_3 – COE_4)

The electrical corporation must provide a high-level overview of its public outreach and education awareness program(s) for wildfires; outages due to wildfires, PSPS events, and protective equipment and device settings; service restoration before, during, and after the incidents (as required by Public Utilities Code section 8386[c][19][B]); and vegetation management. This includes outreach efforts in English, Spanish, Chinese (including Cantonese, Mandarin, and other Chinese languages), Tagalog, and Vietnamese, as well as Korean and Russian where those languages are prevalent within the service territory.

At a minimum, the overview must include the following:

- A description of the purpose and scope of the program(s).
- References to the Utility Initiative Tracking ID where appropriate.
- A brief narrative followed by a tabulated list of all the different target communities it is trying to reach across the electrical corporation’s service territory. The target communities list must include AFN and other vulnerable or marginalized populations, but they may also include other target populations, such as communities in different geographic locations (e.g., urban areas, rural areas), age groups, language and ethnic groups, transient populations, or Medical Baseline customers. In addition, the electrical corporation must summarize the interests or concerns each community may have before, during, or after a wildfire or PSPS event to help inform outreach and education awareness needs. Table 8-58 provides an example of the minimum acceptable level of information.
- A tabulated list of community partners the electrical corporation is working with or intends to work with to support its community outreach and education programs. Table 8-59 provides an example of the minimum acceptable level of information.
- A table of the various outreach and education awareness programs (i.e., campaigns, informal education, grant programs, participatory learning) that the electrical corporation implements before, during, and after wildfire, vegetation management, and PSPS events, including efforts to engage with partners in developing and exercising these programs. In addition, the electrical corporation must describe how it implements its overall program, including staff and volunteer needs, other resource needs, method for implementation (e.g., industry best practice, latest research in methods for risk communication, social marketing), long-term monitoring and

- *evaluation of each program’s success, need for improvement, etc. The narrative for this section is limited to two to three pages. The electrical corporation must also provide the information on its outreach and education awareness programs a in tabulated format.*

BVES’s public outreach and education program was developed with the intent of increasing community resiliency to wildfire preparedness and mitigating the impact of potential PSPS events. BVES believes it is best practice to keep its customers informed on BVES regular operations and planned actions before, during, and after wildfire, vegetation management, and PSPS events.

Community outreach, public awareness, and communication efforts are key to reducing the impact on customers and the community from an event interrupting service or posing serious public risks. Effective planning and awareness limit the scope of extreme events. BVES works year-round to educate customers and coordinate with stakeholders to improve outreach, awareness, and communication. For example, BVES administers annual service territory wide customer surveys to gauge the community’s awareness of wildfire risk and service territory offerings before, during, and after PSPS events. The results of the customer surveys are reported annually in the BVES Post-Season Report filed to the CPUC.

BVES communication plan consists of a two-pronged approach which involves proactive preparation prior to any emergency events occurring and notifications during and after such events. BVES’s communication protocols vary slightly depending on the stakeholders involved, which may include customers, first responders, local mutual aid associates, and local government.

A primary focus of the BVES communication plan is customer outreach. This involves educating and preparing customers for various utility infrastructure related emergencies, including fire prevention, and proactive de-energization. To ensure customers have access to necessary information, BVES provides communication formats in various languages such as English, Spanish, Tagalog, Vietnamese, Chinese, French, Mixteco, and Zapoteco through online resources.

Overall, BVES communication plan seeks to engage stakeholders through open and transparent communication channels. This proactive approach empowers customers and other stakeholders to make informed decisions and take necessary actions in the event of an emergency.

Table 8-58 List of Target Community Groups

Target Community Group	Interests or Concerns Before, During, and After Wildfire and PSPS Events
AFN/Medical Baseline	AFN customers are unable to use power for devices/equipment for health, safety, and independence during a PSPS event
Populations with limited English proficiency	Limited access to prepare for, received, react, and recover from a wildfire or a PSPS event
Populations with impaired vision	Limited access to prepare for, received, react, and recover from a wildfire or a PSPS event

Target Community Group	Interests or Concerns Before, During, and After Wildfire and PSPS Events
Elderly	Impaired physical mobility which interferes with the ability to prepare for, react and recover from a wildfire or a PSPS event.

- Community partners the electrical corporation is working with or intends to work with to support its community outreach and education programs. Partnerships are important to the success of public education and awareness efforts. Good strategies grow from collaboration, and cooperation is essential for developing consistent, harmonized, and standardized messages that will be scaled up and repeated frequently enough to become common knowledge. An exemplar of the minimum acceptable level of information is provided in Table 8-58.*

Table 8-59 List of Target Community Partners

Community Partners	County	City
Bear Valley Community Hospital	San Bernardino	Big Bear Lake
County/2-1-1	San Bernardino	Bernadino
Senior Citizens of Big Bear Valley	San Bernardino	Big Bear Lake
Big Bear Chamber of Commerce	San Bernardino	Big Bear Lake

- Description of the various outreach and education awareness programs (i.e., campaigns, informal education, grant programs, participatory learning) that the electrical corporation implements before, during, and after wildfire, vegetation management, and PSPS events. Successful programs may use many approaches, settings, and tools to repeat their messages for maximum impact. In addition, the electrical corporation must describe how it implements its overall program, including staff and volunteer needs, other resource needs, method for implementation (e.g., industry best practice, latest research in methods for risk communication, social marketing), long-term monitoring and evaluation of each program's success, need for improvement, etc. The narrative for this section is limited to two to three pages. The electrical corporation must also provide the requested information in tabulated format. An exemplar of the minimum acceptable level of information is provided in Table 8-59.*

Table 8-60 Community Outreach and Education Programs

Core Activity	Event Type	Period of Application (Before, During, After Incident)	Name of Outreach or Education Program	Description of Program	Target Audience	Reference/Link
Website and Radio Information	PSPS	Before	Public Safety Power Shutoff	PSPS customer information posted on website and advertised on radio	BVES Customers	Section 9
Website and Radio Information	Wildfire	Before	General Wildfire Safety	General Wildfire Safety customer information posted on website and advertised on radio	BVES Customers	Section 9
Website and Radio Information	Vegetation Management	Before	Vegetation Management	Vegetation Management customer information posted on website and advertised on radio	BVES Customers	Section 8.2
Safety Website and Radio Information	Wildfire	Before	Electrical Safety	Electrical Safety customer information posed on website and advertised on radio	BVES Customers	Section 8.4

8.5.3 Engagement with Access and Functional Needs Populations

In this section, the electrical corporation must provide an overview of its process for understanding, evaluating, designing, and implementing wildfire and PSPS risk mitigation strategies, policies, and procedures specific to AFN customers across its territory. The electrical corporation must also report, at a minimum, on the following:

- Summary of key AFN demographics, distribution, and percentage of total customer base.
- Evaluation of the specific challenges and needs during a wildfire or PSPS event of the electrical corporation's AFN customer base.

• *Plans to address specific needs of the AFN customer base throughout the service territory specific to the unique threats that wildfires and PSPS events may pose for those populations before, during, and after the incidents.*

This should include high-level strategies, policies, programs, and procedures for outreach, engagement in the development and implementation of the AFN-specific risk mitigation strategies, and ongoing feedback practices.

As of March 31, 2023, the BVES identified 588 customer accounts with AFN, which equates to roughly 3% of the BVES customers. 188 of the AFN customer accounts were registered as medical baseline accounts. BVES uses an approach consistent with other IOUs to identify and track customers with AFN. BVES continues work on system modifications to CIS and OMS to allow the recording of AFN customer categories and data beyond medical baseline customers.

BVES is continuously evaluating and seeking to implement system enhancements and modifications on the CIS, OMS, and GIS systems. Data tracking continues to be reviewed for areas of improvement to allow BVES more visibility into the AFN customer population. In 2022, BVES explored options to establish the ability to track AFN categories of customers beyond MBL in the CIS, including the following categorical identifiers: AFN customers enrolled in low-income programs, AFN customers with a physical, intellectual, or developmental disability, AFN customers with a chronic condition or injury, AFN customers identified with limited English proficiency, AFN customers in households with older adults / children, AFN homeless / transportation disadvantaged customers, and an additional AFN category for customers who wish to self-identify but may not necessarily fit into the aforementioned categories.

As a part of BVES's recent and ongoing system improvements, the capability to map AFN customers beyond MBL is anticipated to be integrated into the OMS soon and further refined throughout 2023.

In 2022, BVES partnered with MDC Research to execute two surveys to measure the public's awareness of messaging related to wildfire preparedness and safety. Customers were surveyed at random, targeted for either phone or web administration. Surveys were available to customers in English and Spanish. The first wave of surveys conducted June 13-29, 2022, resulted in completion of 400 surveys, including 13 from critical customers. The second wave of surveys conducted between December 28, 2022, and January 15, 2023 resulted in completion of 423 surveys, including 30 from critical customers. Notable customer survey findings include:

- Among those reporting that they rely on electricity for medical needs, one quarter are aware of additional notices from BVES.
- 98% of respondents indicated it would not be helpful to receive communications in a language other than English.
- 43% are aware they can update their contact information with BVES, and 61% of those have done so, in line with June 2022 findings.
- Similar to June 2022, 16% say they know whether their address is in PSPS area, and 11% are aware of a PSPS map on BVES's website.

In addition to customer surveys, MDC Research conducted Community Based Organization (CBO) interviews to request feedback and gather suggestions on the most effective approaches to PSPS communication within the community. The first wave of interviews resulted in two completed CBO interviews, whereas the second wave resulted in four completed CBO interviews. Notable CBO interview findings include:

- CBOs interviewed expressed a willingness and ability to share BVES PSPS preparedness information to the community during typical interactions, through social media and by handing out printed materials provided by BVES.
- English and Spanish are the primary languages required for effective communication in the communities BVES provides service.
- Simplified, easy-to-understand written communications are of importance to reach individuals with all levels of reading comprehension.

Additional survey information used to inform BVES's 2022 approach in effectively reaching customers include findings that email remains the most commonly recalled channel for wildfire preparedness communication. In terms of clarity, direct mail is rated the highest; bill inserts and other websites are rated as the most useful sources of information about wildfire preparedness. Customers say they most often recall seeing or hearing messages about wildfire on TV news, social networks, and through word of mouth.

In 2023, BVES will seek additional resources to execute surveys and research specific AFN needs before, during, and after PSPS events. BVES also plans to explore availability of resources and identification of gaps through further discussions and expansion of relationships with agencies, cities, counties, and local organizations.

BVES plans to continue improvements in accessibility of their webpage. Improvements in 2022 included the addition of 211 resource information on the web, as well as successful development of a self-identification tool for AFN customers in both Spanish and English.

BVES participated in the AFN Collaborative Planning Team, AFN Core Planning Team and provided executive representation on the Statewide Joint IOU AFN Advisory Council. To support individuals with AFN during potential PSPS events, BVES also participated in the creation of an annual support plan with assistance from regional and statewide AFN stakeholders. Beginning in 2023, that plan leverages the FEMA Comprehensive Preparedness Guide Six Step Process.

The main risk identified is "individuals with AFN are unable to use power for devices/equipment for health, safety, and independence due to an unexpected PSPS or are unprepared for a PSPS." BVES followed the same outline as the statewide AFN Collaborative Planning Team to address "Who," "What," and "How" to support individuals with AFN and mitigate risks associated with PSPS events. BVES uses the Electricity Dependent Definition: Individuals who are at an increased risk of harm to their health, safety, and independence during a Public Safety Power Shutoff for reasons including, but not limited to: Medical and Non-Medical; Behavioral, Mental and Emotional Health; Mobility and Movement; and Communication.

BVES AFN population consists of individuals who have developmental or intellectual disabilities, physical disabilities, chronic conditions, injuries, limited English proficiency or who are non-English speaking, older adults, children, people living in institutionalized settings, or those who are low-income, homeless, or transportation disadvantaged, including, but not limited to, those who are dependent on public transit or those who are pregnant.

WHY: As climate conditions change, wildfires have become a year-round threat. When wildfire conditions present a safety risk to our customers and communities, electric utilities may call for a PSPS as a measure of last resort. A PSPS, although necessary, disrupts the everyday lives of impacted individuals, including those with AFN. BVES seeks to mitigate the impact of PSPS on individuals with AFN.

WHO: The Joint IOU Statewide AFN Advisory Council and AFN Core Planning Team developed a definition of Electricity Dependent individuals that BVES seeks to support. That definition remains unchanged from 2022.

WHAT & HOW: Working alongside the AFN Collaborative Council and AFN Core Planning Team, the IOUs have worked to identify the goals, objectives, and potential opportunities for enhancements in 2023.

The overarching goal is to mitigate impacts of a PSPS on individuals with AFN served by the IOUs through improved customer outreach, education, assistance programs and services.

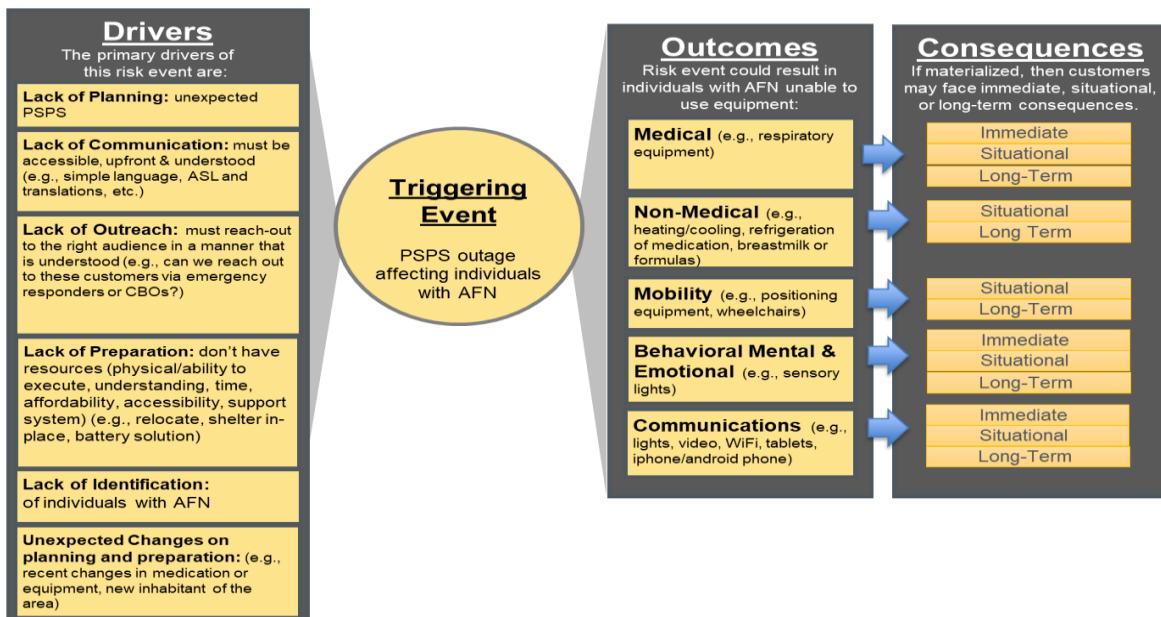

BVES Figure 8-7: AFN Population Risks and Hazards During PSPS Event

BVES developed the following communications outreach plan to notify AFN customers of pertinent PSPS status updates, including ongoing proactive education. BVES will continue to engage AFN customers throughout the year, and especially during wildfire season, to educate on the PSPS determination and notification process and how customers can prepare for prolonged de-energization through community meetings, social media, and BVES website.

San Bernardino 211 resource information is available on BVES website. BVES developed a self-identification tool for AFN customers in both Spanish and English languages, which is available on BVES website. BVES partnered with local public transportation service (MARTA), who will assist with non-medical transportation on an as available basis. BVES has contracted lodging services for customers during significant outage events on an as needed basis. BVES has staff available to deploy back up batteries on a small scale and educate each customer on the basic functionality of each battery unit. BVES also has an 8.4MW natural gas generation station in its service territory, available to produce energy during emergency events.

On February 1, 2023, BVES files with the CPUC “Bear Valley Electric Service, Inc. (U 913 E) Plan to Address Access and Functional Needs During De-Energization Events” which details BVES’s plans to address AFN during PSPS events.

8.5.4 Collaboration on Local Wildfire Mitigation Planning

BVES understands the importance of collaborating with local government and agencies including county, city, and tribal agencies on wildfire mitigation. There are no tribal groups in the BVES service area. The key jurisdictions in the BVES service area are the City of Big Bear Lake, County of San Bernardino, Caltrans and the US Forest Service. BVES maintains strong working relationships with Additionally, City of Big Bear Lake, County of San Bernardino, Caltrans, US Forest Service, Big Bear Fire Department, San Bernardino Fire Department, CHP Arrowhead, San Bernardino County Sheriff’s Department Big Bear Lake Patrol Station, Big Bear City Community Services Department and other local groups.

BVES attends the Big Bear Valley Mountain Mutual Aid Association (MMAA) meetings, held five times per year, and at each meeting discusses wildfire mitigation planning efforts. MMAA membership includes: City of Big Bear Lake, Big Bear Fire Department, San Bernardino County Fire, San Bernardino County Department of Public Health, San Bernardino County Office of Emergency Services (OES), San Bernardino County Sheriff’s Department, San Bernardino County Transportation Authority, San Bernardino County Emergency Communications Service (ECS), US Forest Service, California Highway Patrol, California Department of Transportation, Big Bear Airport, Big Bear City Community Services District, Big Bear Lake Department of Water & Power, Big Bear Lake Municipal Water District, Big Bear Area Regional Water Authority, Southwest Gas, Bear Valley Community Healthcare District, Bear Valley Unified School District, Mountain Area Regional Transit Authority, Bear Mountain Ski Resorts, Big Bear Chamber of Commerce, Big Bear Lake Resort Association, Big Bear Valley Recreation & Park District, American Red Cross, Big Bear Community Emergency Response Team (CERT), Big Bear Valley Community Organizations Active in Disaster (COAD), Big Bear Valley Voluntary Organizations Active in Disaster (VOAD), Civil Air Patrol, and Salvation Army.

Periodic meetings and recurring communication between BVES and local government and agencies strengthen the likelihood of demonstrating resiliency during emergencies. Due to the small service area, BVES can effectively engage local government and agencies frequently and prioritizes these engagements due to the significant impact that they have in achieving community buy-in. BVES participates in **community-based** fuels management and defensible space programs with the USFS. BVES supports, the broader Big Bear Valley fuels management and defensible space community programs by establishing collaborative activities within the service area. Since the initial 2005 Big Bear Valley Community Wildfire Protection Plan (CWPP), significant progress has been made through ongoing and well-coordinated efforts between various local, state, and federal agencies to reduce hazardous fuels across the valley through a wide range of fuel reduction projects.

See Table 8-70 for BVES local collaboration in resource conservation programs, structural hardening programs, and community wildfire protection plans.

Table 8-61 Collaboration in Local Wildfire Mitigation Planning

Name of County, City, or Tribal Agency or Civil Society Group (e.g., nongovernment organization, fire safe council)	Program, Plan, or Document	Last Version of Collaboration	Level of Collaboration
Local County Resource Management Agency	Local County General Plan, Safety Element, Wildfires	2022 version (06/2021)	Attended a virtual meeting on 02/02/2022 at 1 pm PDT Provided verbal comments and input
Local Fire Safe Council	Structural hardening grant program	2021/2022	Financier
Local County Resource Conservation District	Chipper program	Planned for 12/2023	Financier
Local Tribal Agency	Tribal Government Wildfire Safety Plan	2022 version (06/2021)	Attended a virtual meeting on 02/02/2022 at 1 pm PDT Provided verbal comments and input
City of Big Bear Lake	Wildfire Mitigation Plan	November 2, 2022	Meeting with City Manager and City Engineer
Big Bear Valley Mountain Mutual Aid Association	Wildfire Mitigation Initiatives and 2022 Weather Forecast	April 12, 2022	Meeting with representatives from City of Big Bear Lake, San Bernardino County, Big Bear Fire Department, Sheriff Big Bear Lake, CALTRANS, and CHP. Presentation by NOAA Meteorologist.

- *In a separate table, the electrical corporation must provide a list of current gaps and limitations in its collaboration efforts with local partners on local wildfire planning efforts. Where gaps or limitations exist, the electrical corporation must indicate proposed means and methods to increase collaborative efforts.*

An exemplar of the minimum acceptable level of information is provided in Table 8-61.

Table 8-62 Key Gaps and Limitations in Collaborating on Local Wildfire Mitigation Planning

Subject of Gap or Limitation	Brief Description of Gap or Limitation	Strategy for Improvement
Community engagement feedback	Gap: Limited feedback mechanisms are in place to gain insight on the effectiveness of community engagement activities.	BVES will work on implementing immediate feedback mechanisms to its community engagement activities.

8.5.5 Best Practice Sharing with Other Electrical Corporations

In this section BVES provides a high-level overview of its policy for sharing best practices and collaborating with other electrical corporations on technical and programmatic aspects of its WMP program.

BVES shares best practices and collaborates with other California IOUs in working group meetings and public communications. Additionally, BVES collaborates with other out of state electric utilities. The California IOUs share feedback provided by customers and the public regarding recommendations and concerns. BVES engages with utilities outside of California to exchange best practices both for utility wildfire mitigation and stakeholder cooperation when responding to wildfires. BVES expanded its efforts in this initiative area during 2022 and, accordingly, increased the projected operational expenditure spending for this initiative going forward.

BVES attended the 2023 DistribuTECH International transmission and distribution (T&D) conference where lessons learned and information on wildfire mitigation, manufactures and vendors of T&D equipment were shared and discussed. BVES sent several planning and field staff to this conference in February. Additionally, BVES sent attendees to the 2023 Power Delivery Design Conference in February 2023 where wildfire mitigation best practices were a main topic and information was exchanged with out-of-state utilities and utility industry experts. In March 2023, BVES participated at the 2023 Wildfire Mitigation for Utilities Conference organized by Electric Utility Consultants, Inc. (EUCI). At this conference, wildfire mitigation was discussed with California utilities and agencies, out of state utilities and agencies, and utility industry equipment suppliers and service providers. BVES intends to be more involved in conferences, workshops, and working groups throughout 2023.

In 2022, BVES attended the Institute of Electrical and Electronics Engineers (IEEE) Transmission and Distribution Conference and the DistribuTECH International transmission and distribution (T&D) conference.

BVES currently does not have a wire down detection program, nor does it have a timeline to procure one. As solutions are developed in this space, BVES will look to collaborate with other utilities on the effectiveness of their programs.

Table 8-63 Best Practice Sharing with Other Electrical Corporations

Best Practice Subject	Dates of Collaboration (YYYY-YYYY)	Technical or Programmatic	Utility Partner(s)	Description of Best Practice Sharing or Collaborating	Outcome
Covered conductor effectiveness	2020-Ongoing	Technical	BVES Liberty PC PG&E SCE SDG&E	The IOUs commissioned a joint study to assess the effectiveness and reliability of covered conductors (CCs) for overhead distribution system hardening. The aim is to develop consistent criteria and measurements for evaluating effectiveness of CCs. Refer to the report entitled "Effectiveness of Covered Conductors: Failure Mode Identification and Literature Review," dated December 22, 2021, for more details.	Ongoing <ul style="list-style-type: none"> • CCs are a mature technology (in use since the 1970s) and have the potential to mitigate several safety, reliability, and wildfire risks inherent to bare. • Conductors. This is due to the reduced vulnerability to arcing/faults afforded by the multi-layered polymeric insulating sheath material. • Of the 10 hazards that affect bare conductors, CCs have the potential to mitigate six (tree/vegetation contact, wind-induced contact, third-party damage, animal-related damage, public/worker impact, and moisture). • Laboratory studies and field experience have shown that CCs largely mitigated arcing due to external contact. • Several CC-specific failure modes exist that require operators to consider additional personnel training, augmented installation practices, and adoption of new mitigation strategies (e.g., additional lightning arrestors, conductor washing programs).
Risk Model Working Group	2022-Ongoing	Technical	BVES Liberty PC PG&E SCE SDG&E	Risk modeling methodology sharing among participating utilities	Ongoing "annual" working group meetings Next Step Establish uniform approach to risk modeling for utilities

Best Practice Subject	Dates of Collaboration (YYYY-YYYY)	Technical or Programmatic	Utility Partner(s)	Description of Best Practice Sharing or Collaborating	Outcome
Workshop on Vegetation Management Best Practices	2022-Ongoing	BVES Liberty PC PG&E SCE SDG&E	BVES Liberty PC PG&E SCE SDG&E	Share best practices in vegetation management among participating utilities and experts in the vegetation management field	Improved vegetation management programs
Wildfire Mitigation	2022-Ongoing	Technical and Programmatic	Varies depending on engagement	BVES engages and shares best practices with other utilities (in state and out of state), state agencies, industry trade associations, vendors, and other experts in wildfire mitigation by attending conferences and other external events	Participating in industry conferences and other forums as well as engaging with peer utilities provide regular opportunities to share best practices on topics pertaining to wildfire mitigation, including PSPS.
WMP Joint IOU	2023-Ongoing	Technical and Programmatic	BVES PG&E SCE SDG&E	Share best practices in IOU WMP Programs	Ongoing Create awareness on how other IOU's are handling WMP related topics, and share their approach to handling identified issues.

9. Public Safety Power Shutoff

9.1 Overview

In Sections 9.1–9.5 the electrical corporation:

- Provides a high-level overview of key PSPS statistics
- Identify circuits that have been frequently de-energized and provide measures for how the electrical corporation will reduce the need for, and impact of, future PSPS of those circuits
- Describe expectations for how the electrical corporation’s PSPS program will evolve over the next 3 and 10 years
- Describe any lessons learned for PSPS events occurring since the electrical corporation’s last WMP submission
- Describe the electrical corporation’s protocols, processes, and procedures for PSPS implementation

9.1.1 Key PSPS Statistics

In this section, the electrical corporation must include a summary table of PSPS event data. These data must be calculated from the same source used in the GIS data submission (i.e., they should be internally consistent). If it is not possible to provide these data from the same source, the electrical corporation must explain why. Table 9-1 provides an example of the minimum acceptable level of information for a summary of PSPS event data.

In this section, BVES provides summary table of PSPS event data. The data is calculated from the same source used in the GIS data submission.

Table 9-1 PSPS Statistics

Year	# of Events	Circuits De-energized	Customers Impacted	Customer Minutes of Interruption
Jan 1 – Dec 31, 2020	0	0	0	0
Jan 1 – Dec 31, 2021	0	0	0	0
Jan 1 – Dec 31, 2022	0	0	0	0

BVES considers PSPS to be a measure of last resort, driven by a combination of extreme fire threat weather, fuel moisture, wind, and situational awareness information to protect the community against ignition threats from energized circuits. Although BVES has never implemented PSPS, BVES is committed to reducing the scope, frequency, and duration of PSPS events, should it be necessary when the safety risk of imminent fire danger is greater than the impact of de-energization. As BVES continues to reduce ignition risk, BVES anticipates the likelihood to need to use its PSPS to become even more remote, but BVES will continue to

evaluate the risk and necessity for its use. Finally, BVES incorporates lessons learned across California regarding the use of PSPS and will update as necessary its PSPS Plan and Emergency Disaster and Response Plan (EDRP) accordingly.

No direct lessons learned from BVES-initiated activations can be applied to this WMP Update as BVES has not met thresholds to initiate a PSPS event. The triggering threshold has also not changed based on the implementation of WMP initiatives. In the future, BVES anticipates continued re-designation of high-risk areas to reduce risk designations after years of significant WMP initiative implementation as mitigations are deployed and real-time modeling capabilities are enhanced. BVES will also re-evaluate its PSPS trigger thresholds.

The circuits currently identified for de-energization and customer impact include North Shore Circuit (1,021 customers), Boulder Circuit (1,063 customers), Lagonita Circuit (946 customers), Clubview Circuit (740 customers), Goldmine Circuit (950 customers), and Erwin Lake Circuit (197 customers). If the Radford Circuit is de-energized, the load will be shifted to the Shay Line and no direct customers will be impacted.

9.1.2 Identification of Frequently De-energized Circuits

Public Utilities Code section 8386(c)(8) requires the “[i]dentification of circuits that have frequently been de-energized pursuant to a PSPS event to mitigate the risk from wildfire and the measures taken, or planned to be taken, by the electrical corporation to reduce the need for, and impact of, future PSPS of those circuits, including, but not limited to, the estimated annual decline in circuit PSPS and PSPS impact on customers, and replacing, hardening, or undergrounding any portion of the circuit or of upstream transmission or distribution lines.” To comply, the electrical corporation is required to populate Table 9-2 and provide a map showing the frequently de-energized circuits.

The map must show the following:

- *All circuits listed in Table 9-2, colored or weighted by frequency of PSPS*
- *HFTD Tiers 2 and 3 contour overlay*

Public Utilities Code section 8386(c)(8) requires the “Identification of circuits that have frequently been de-energized pursuant to a PSPS event to mitigate the risk of wildfire and the measures taken, or planned to be taken, by BVES to reduce the need for, and impact of, future PSPS of those circuits, including, but not limited to, the estimated annual decline in circuit PSPS and PSPS impact on customers, and replacing, hardening, or undergrounding any portion of the circuit or of upstream transmission or distribution lines.”

Table 9-2 De-energized Circuits

Entry #	Circuit ID	Name of Circuit	Dates of Outages	# of Customers Served by Circuit	# of Customers Affected	Measures Taken, or Planned to be Taken, to Reduce the Need for and Impact of Future PSPS of Circuit
N/A	N/A	N/A	N/A	N/A	N/A	N/A

BVES has not activated any PSPS events thus cannot provide a listing of frequently de-energized circuits. The utility has prioritized high-risk circuits for mitigation over the next ten years and does not anticipate the need to utilize any proactive de-energizations. However,

BVES has identified circuits for de-energization if PSPS triggers are met and maintains complete PSPS Protocols and conducts PSPS exercises to be prepared in case BVES must initiate a PSPS event.

These circuits for potential PSPS events are identified in the figure below.

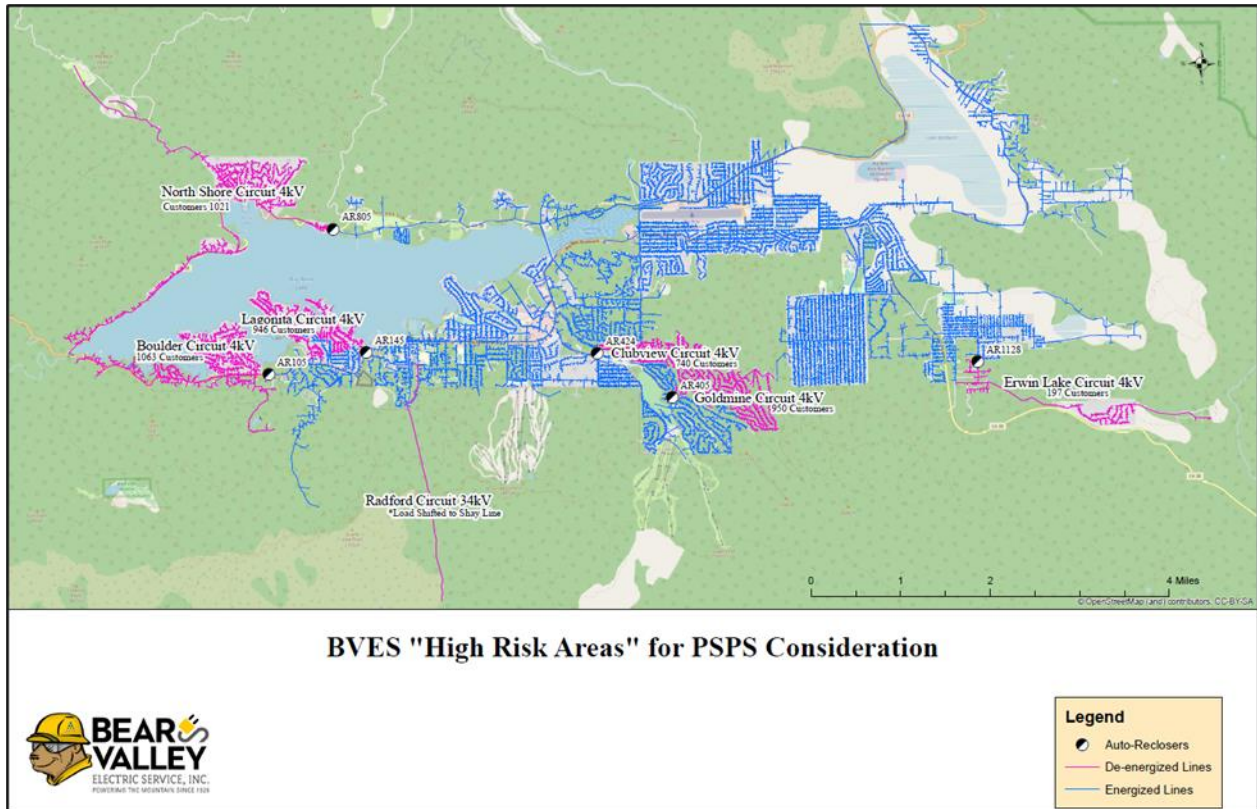

Figure 9-1 BVES High Risk Areas for PSPS Consideration

9.1.3 Objectives

Each electrical corporation must summarize the objectives for its 3-year and 10-year plans to reduce the scale, scope, and frequency of PSPS events. These summaries must include the following:

- Identification of which initiative(s) in the WMP the electrical corporation is implementing to achieve the stated objective, including Utility Initiative Tracking IDs
- Reference(s) to applicable codes, standards, and best practices/guidelines and an indication of whether the electrical corporation exceeds an applicable code, standard, or regulation
- Method of verifying achievement of each objective
- A completion date for when the electrical corporation will achieve the objective
- Reference(s) to the WMP section(s) or appendix, including page numbers, where the details of the objective(s) are documented and substantiated

In this section, BVES summarizes the objectives for its 3-year and 10-year plans to reduce the scale, scope, and frequency of PSPS events. The summaries include the following:

- Identification of which initiative(s) in the WMP the electrical corporation is implementing to achieve the stated objective, including Utility Initiative Tracking IDs
- Reference(s) to applicable codes, standards, and best practices/guidelines and an indication of whether the electrical corporation exceeds an applicable code, standard, or regulation
- Method of verifying achievement of each objective
- A completion date for when the electrical corporation will achieve the objective
- Reference(s) to the WMP section(s) or appendix, including page numbers, where the details of the objective(s) are documented and substantiated

Table 9-3 PSPS Objective (3-year plan)

Objectives for Three Years (2023-2025)	Applicable Initiative(s) & Tracking ID(s)	Applicable Regulations, Codes, Standards, and Best Practices (see note)	Method of Verification	Completion Date	Reference (section & page #)
Automate PSPS notifications to customers.	Public emergency communication strategy EP-3 Public outreach and education awareness program COE-1	CPUC's PSPS guidelines and rules	Contract with communications firm to automate notifications; demonstration of automated process; post-event reports	September 2023	Section 8.4.4

Objectives for Three Years (2023-2025)	Applicable Initiative(s) & Tracking ID(s)	Applicable Regulations, Codes, Standards, and Best Practices (see note)	Method of Verification	Completion Date	Reference (section & page #)
<p>Conduct annual table-top and functional exercises prior to the fire season.</p>	<p>Emergency preparedness plan EP-1 External collaboration and coordination EP-2 Public emergency communication strategy Preparedness and planning for service restoration EP-4 Customer support in wildfire and PSPS emergencies EP-5</p>	<p>CPUC's PSPS guidelines and rules</p>	<p>Table-top exercise results and Pre- and Post-Season Report</p>	<p>Q2 Annually</p>	<p>Section 8.4.2</p>

Objectives for Three Years (2023-2025)	Applicable Initiative(s) & Tracking ID(s)	Applicable Regulations, Codes, Standards, and Best Practices (see note)	Method of Verification	Completion Date	Reference (section & page #)
Conduct service restoration training with supervisory and field personnel each year prior to the fire season.	Emergency preparedness plan EP-1 External collaboration and coordination EP-2 Public emergency communication strategy Preparedness and planning for service restoration EP-4 Customer support in wildfire and PSPS emergencies EP-5	CPUC's PSPS guidelines and rules	Training Log	Q2 Annually	Section 8.4.2
Conduct community and stakeholder PSPS briefings each year prior to the fire season.	Public emergency communication strategy EP-3	CPUC's PSPS guidelines and rules	Annual Community Briefing Report Outreach Records	Q2 Annually	Section 8.4.4

Objectives for Three Years (2023-2025)	Applicable Initiative(s) & Tracking ID(s)	Applicable Regulations, Codes, Standards, and Best Practices (see note)	Method of Verification	Completion Date	Reference (section & page #)
Continue to conduct comprehensive outreach to identify households with AFN persons.	Public emergency communication strategy EP-3 Engagement with access and Functional Needs Populations COE-2	CPUC's PSPS guidelines and rules	Contract with communications firm to automate notifications; demonstration of automated process; post-event reports	Ongoing	Section 8.4.4

Note: An asterisk indicates that the electrical corporation exceeds a particular code, regulation, standard, or best practice. The electrical corporation must provide a reference to the appendix section and page providing further documentation, justification, and substantiation.

Table 9-4 PSPS Objective (10-year plan)

Objectives for Ten Years (2026-2032)	Applicable Initiative(s) & Tracking ID(s)	Applicable Regulations, Codes, Standards, and Best Practices (see note)	Method of Verification	Completion Date	Reference (section & page #)
Evaluate and adjust as appropriate PSPS activation thresholds as grid hardening initiatives are completed and the risk of ignitions is reduced.	Emergency preparedness plan EP-1	CPUC's PSPS guidelines and rules	N/A	Ongoing	Section 8.4.2
Reassess high risk areas and sectionalizing switches as grid hardening initiatives are completed and the risk of ignitions is reduced in the high-risk areas. (For example, as a	Emergency preparedness plan EP-1	CPUC's PSPS guidelines and rules	N/A	Ongoing	Section 8.4.2

Objectives for Ten Years (2026-2032)	Applicable Initiative(s) & Tracking ID(s)	Applicable Regulations, Codes, Standards, and Best Practices (see note)	Method of Verification	Completion Date	Reference (section & page #)
high-risk area is shrunk due to grid hardening efforts, new sectionalizing devices may be needed to be able isolation only the smaller high-risk area.)					
As social media and communications technology continue to evolve, evaluate how to adapt PSPS communications plan to improve and streamline communications with stakeholders and customers.	Public emergency communication strategy EP-2		Contract with communications firm to automate notifications; demonstration of automated process; post-event reports Internal records of outreach	Ongoing	Section 8.4.4

Note: An asterisk indicates that the electrical corporation exceeds a particular code, regulation, standard, or best practice. The electrical corporation must provide a reference to the appendix section and page providing further documentation, justification, and substantiation.

9.1.4 Targets

Initiative targets are forward-looking quantifiable measurements of activities identified by each electrical corporation in its WMP. Electrical corporations will show progress toward completing targets in subsequent reports, including QDRs and WMP Updates.

The electrical corporation must list all targets it uses to track progress on reducing the scope, scale, and frequency of PSPS for the three years of the Base WMP. Energy Safety's Compliance Assurance Division and third parties must be able to track and audit each target.⁴⁸ For each initiative target, the electrical corporation must provide the following:

- Utility Initiative Tracking IDs.
- Projected targets for the three years of the Base WMP and relevant units.
- The expected "x% risk impact" for each of the three years of the Base WMP. The expected x% risk impact is the expected percentage risk reduction per year, as described in Section 7.2.2.2.
- Method of verifying target completion.

The electrical corporation's targets must provide enough detail to effectively inform efforts to improve the performance of the electrical corporation's initiatives aimed at reducing the scope, scale, and frequency of its PSPS events.

Table 9-5 PSPS Targets

Initiative Activity	Tracking ID	2023 Target & Unit	x% Risk Impact 2023	2024 Target & Unit	x% Risk Impact 2024	2025 Target & Unit	x% Risk Impact 2025	Method of Verification
Covered Conductor Installation – Circuit miles (34kV & 4kV)	GD_1	12.9	17.4%	12.9	17.4%	5.1	17.4%	Completed Work Orders
Covered Conductor Installation – Circuit miles (Radford Line)	GD_2	2.7	62.5%	0	N/A	0	N/A	Completed Work Orders
Number of Customers Impacted	EP_1	160 ⁹	N/A	160	N/A	133	N/A	QDR

⁹ The number of customers impacted is calculated by estimating the average number of customers impacted per year based upon the number of PSPS events that is expected annually *i.e.*, every approximately 1 out of 25 years for 2023 and 2024, and 1 out of 30 years in 2025.

Initiative Activity	Tracking ID	2023 Target & Unit	x% Risk Impact 2023	2024 Target & Unit	x% Risk Impact 2024	2025 Target & Unit	x% Risk Impact 2025	Method of Verification
Number of Circuits De-energized	EP_1	0.08 ¹⁰	N/A	0.08	N/A	0.07	N/A	QDR
Number of PSPS events	EP_5	0.04	N/A	0.04	N/A	0.03	N/A	QDR

To date BVES has not experienced conditions to invoke a PSPS and, thus, has never executed a PSPS event. Additionally, analysis of historical weather since 2015 indicates conditions to warrant invoking a PSPS have not occurred in the BVES service area during that time period. However, there is always some small, and likely increasing likelihood that abnormal fire threat weather (*i.e.*, exceptionally dry and windy conditions) may require BVES to invoke to a PSPS. The winter of 2023 is a good example of anomalous conditions; during that winter BVES experienced the most snow on record by over 20 inches. Similarly, at some point BVES could experience dry conditions and high winds well beyond normal that would trigger PSPS conditions. Climate change and frequent and persistent droughts increase the likelihood of environmental conditions that could lead to reaching a PSPS threshold. Conversely, as BVES continues to harden its grid, the threshold for invoking a PSPS increases and, therefore, the likelihood further decreases. Therefore, there will always be some PSPS risk within the BVES service territory for the foreseeable future.

BVES remains committed to continue developing the capability to better calculate PSPS risk using probabilistic models. As of now, BVES currently estimates the PSPS risk to be a 1 in 25 year event that would affect at most 2 circuits and 4,000 customers given the grid conditions in 2023 and 2024 (projected). Given further grid hardening efforts, BVES evaluated that the PSPS risk in 2025 to be a 1 in 30 year event that would affect at most 2 circuits and 4,000 customers. Thus, the target values in Table 9-5 for “Number of Customers Impacted”, “Number of Circuits De-energized”, and “Number of PSPS events” are calculated for 2023 and 2024 based on PSPS being a 1 in 25 year event and for 2025 based on PSPS being a 1 in 30 year event.

The initiatives in the Table 9-5 are designed to mitigate that risk and ensure readiness in the case of conditions requiring PSPS activation. Actions are taken on these initiatives on a quarterly basis and updates and adjustments are made on an as needed basis. BVES’s PSPS Exercises also help to determine the effectiveness of the initiatives and guide future updates.

9.1.5 Performance Metrics Identified by the Electrical Corporation

Performance metrics indicate the extent to which an electrical corporation’s Wildfire Mitigation Plan is driving performance outcomes. Each electrical corporation must:

¹⁰ The number of circuits de-energized is calculated by estimating the average number of circuits impacted per year based upon the number of PSPS events that is expected annually *i.e.*, every approximately 1 out of 25 years for 2023 and 2024, and 1 out of 30 years in 2025.

- *List the performance metrics the electrical corporation uses to evaluate the effectiveness of reducing reliance on PSPS*

For each of these performance metrics listed, the electrical corporation must:

- *Report the electrical corporation's performance since 2020 (if previously collected)*
- *Project performance for 2023-2025*
- *List method of verification*

The electrical corporation must ensure that each metric's name and values are the same in its WMP reporting as its QDR reporting (specifically, QDR Table 2 and QDR Table 3). Metrics listed in this section that are the same as performance metrics required by Energy Safety and reported in QDR Table 2 (Performance Metrics)50 must match those reported in QDR Table 2. Metrics listed in this section that are not the same as any of the performance metrics identified by Energy Safety and reported in QDR Table 2 must match those reported in QDR Table 3.

The electrical corporation must:

- *Summarize its self-identified performance metric(s) in tabular form*
- *Provide a brief narrative that explains trends in the metrics*

Table 9-6 provides an example of the minimum acceptable level of information.

In addition to the table, the electrical corporation must provide a narrative (two pages maximum) explaining its method for determining its projected performance on these metrics (e.g., PSPS consequence modeling, retrospective analysis).

PSPS Evolution Timeline

In 2022, BVES contracted with Technosylva to provide real-time situational awareness through on-demand fire spread predictions and impact analysis, wildfire risk forecasting for customer assets and the service area using daily weather prediction integration and asset risk analysis using historical weather climatology. BVES plans to use this to analyze whether PSPS activation should occur, or at least add granularity to the PSPS threshold, in the future. Additional quantitative analysis of this projected evolution will be available over the year with full deployment in 2023.

In 2022, BVES updated its current PSPS Plan and Protocols to align with Phase 3 de-energization guidelines issued under D. 21-06-034. In addition to this effort, BVES revised its PSPS Plan and Protocol to be more action-oriented and concise to promote its effectiveness during an implementation. While BVES does not anticipate an increase in PSPS activation, pre- and post-season activities for PSPS awareness have been made more robust through quarterly engagements with members of the public safety partner network. BVES held a table-top simulation on April 15, 2022, enabling a run-through process of protocol activation with emergency and fire response personnel. On June 21, 2022, BVES conducted a PSPS functional exercise which included a community awareness workshop to address pre-season concerns, review its protocols, and forecast for proactive de-energization. BVES filed its annual Pre-Season Report on July 1, 2022, with the CPUC.

BVES also conducted public outreach and published its vision for necessity of PSPS on its website. Due to previous, ongoing, and future grid hardening efforts, the projected risk outlook relative to system hardening efforts carried out on prioritized circuits indicates a lower risk

forecast as these initiatives are executed over ten years. This reduces the likelihood and need to initiate PSPS events.

BVES has not initiated any PSPS events over the past three years and does not forecast an imminent need to de-energize in the future based on a one, three, or ten-year forecast. The two tables below correlate high wind events (gusts and sustained winds) with High-Risk Days (days with NFDRS that are Brown, Orange, or Red) over the past 6 years. The data indicates that the threshold for BVES to direct a PSPS event was not experienced in the BVES service area.

BVES Table 9-1 Highest Daily Wind Gust and Sustained Wind on High-Risk Days

Highest Daily Wind Gust on High-Risk Days							
Wind Gusts	2016	2017	2018	2019	2020	2021	2022
>55	0	0	0	0	0	0	0
50 to 54	0	0	0	0	0	0	0
40 to 49	0	0	0	1	1	2	1
30 to 39	7	5	6	1	5	5	3
20 to 29	78	39	64	27	65	51	56
<20	66	74	59	58	90	27	31
Highest Daily Sustained Wind on High-Risk Days							
Wind Gusts, Sustained	2016	2017	2018	2019	2020	2021	2022
>55	0	0	0	0	0	0	0
50 to 54	0	0	0	0	0	0	0
40 to 49	0	0	0	0	0	0	0
30 to 39	0	0	0	0	0	1	0
20 to 29	2	6	5	3	7	4	4
<20	149	112	124	84	154	83	87

BVES Table 9-2 National Fire Danger Rating System (NFDRS) Historic Data

NFDRS	2016	2017	2018*	2019*	2020	2021	2022
G-Low Risk	71	109	26	189	108	87	40
Y-Moderate Risk	144	138	169	66	97	187	232
B-High Risk	138	103	122	78	152	90	91
O-High Risk	9	15	7	9	6	0	0
R-High Risk	4	0	0	0	3	0	0

*NFDRS not available for some days due to Federal Government shutdown.

Because BVES has not had to initiate PSPS events, it is not quantifiable to reduce the frequency, scope, or duration of future PSPS events. However, BVES does not view lack of PSPS events as a case for complacency. Accordingly, BVES incorporates PSPS lessons learned from BVES's observation and review of PSPS actions taken by other utilities in California.

In addition to its own plan for proactive de-energization, BVES may also be impacted by PSPS events triggered by SCE, because SCE's system supplies the majority of electric power to

BVES's system. Accordingly, BVES closely monitors and coordinates with developments at SCE and is ready to respond to any SCE PSPS that may cut imports to BVES. Thus far, SCE has not enacted a PSPS on a power supply line to BVES.

Because BVES has never enacted a PSPS and believes there is a low-likelihood BVES will need to enact a PSPS in the future, BVES does not have a defined vision for the continued evolution of its PSPS Plan. However, BVES recognizes climate change is changing historical weather patterns and fire conditions including severity and length of the fire season. In future WMP Updates, BVES will continue to assess the historical record of fire weather conditions to determine any instances where a PSPS activation would have been justified using BVES's PSPS thresholds to assist in scenario development of forecasted risk. Taking no action to harden circuits or reduce the impact of PSPS events, would leave BVES's customers and stakeholders vulnerable to future extreme fire weather events that could necessitate PSPS. Therefore, over the course of the ten-year planning period, grid hardening initiatives, enhanced vegetation management programs, more robust forecasting capabilities, and increased situational awareness will continue to keep the likelihood of PSPS activation remote despite changing climate and forest conditions in the BVES service territory. Additionally, BVES will continue to coordinate with public safety partners and community members and distribute PSPS Plan and wildfire safety updates ahead of each wildfire season.

The data provided in is a summary based on the most current information available at the time and is subject to modification resulting from additional analyses, internal outage audits and assessments, completed following submission of this 2023 WMP Update.

Scope, scale, and frequency of PSPS activations will be mitigated through BVES's seasonal operational posture that directs the following actions taken throughout the year:

1. The Radford Line is de-energized from April to October or as otherwise recommended by the Field Operations Supervisor. Re-energization can be achieved should the forecasted demand require additional generation, for planned maintenance, system upgrades, or other-directed action. No redundancy degradation exists with this operational protocol since the supply lines from the Lucerne area are separate and independent of one another. The Radford Line assists to supply power during winter high load periods as BVES profiles as a winter-peaking utility.
2. From April to October, BVES will place certain auto-reclosers, fuse TripSavers, and switches in "manual" operation such that they will not shut and test upon detection of a fault. A specific list of switched mechanisms will be derived ahead of each fire season to ensure load forecasts align with present conditions to the best ability possible. The completion of the Grid Automation Project, which establishes connectivity and control of these devices, will necessitate a policy revision or re-evaluation.
 - a. When an auto-recloser, switch, or fuse-replacing TripSavers placed in "Manual" due to the above policy trips opens, the affected portions of the de-energized circuit or feeder will be patrolled prior to re-energizing them. If the cause is likely known and the fire risk is "Green" or "Yellow," the Field Operations Supervisor may authorize the Line Crew to test the device once. If the device trips open again, the circuit or feeder must be thoroughly patrolled to determine the fault and ensure there is no risk of causing fire.

3. Due to reduced load in non-winter period, the Utility Engineer & Wildfire Mitigation Supervisor developed specific fast trip, three-shot settings for auto-reclosers and other protective devices in the field to enhance fire prevention. The list of affected devices will be provided to the Utility Manager and the Field Operations Supervisor. Additionally, the Field Operations Supervisor will provide the settings that the Field Operations staff will be required to set on each device. Specific dates to enter these reduced settings will be recommended by the Field Operations Supervisor and approved by the Utility Manager. Engineering staff will not change device settings without the Field Operations Supervisor’s authorization.

It should be noted that while BVES is able to evaluate its facilities and determine the limiting wind speeds when distribution facilities are possibly at high risk, BVES is not able to determine the strength or health of vegetation surrounding bare conductors outside of the required vegetation clearance zones as well as other structures that may come loose and impact BVES distribution facilities. Therefore, BVES may determine a need to proactively de-energize facilities during high fire threat and high wind conditions. This would be done in close consultation and coordination with local government and agencies. Isolating areas with switching devices allow for sectionalization of the areas affected, which will be communicated to affected parties if a decision to activate PSPS is made.

Table 9-6 Projected PSPS Performance

Performance Metrics	2020	2021	2022	2023 Projected	2024 Projected	2025 Projected	Method of Verification (e.g., third-party evaluation, QDR)
PSPS Notification	0	0	0	0	0	0	QDR
Circuits De-energized	0	0	0	0	0	0	QDR
Customers impacted	N/A	N/A	N/A	0	0	0	QDR

9.2 Protocols on PSPS

The electrical corporation must describe its protocols on PSPS implementation including:

- Risk thresholds (e.g., wind speed, FPI, etc.) and decision-making process that determine the need for a PSPS. Where the electrical corporation provides this information in another section of the WMP, it must provide a cross-reference here rather than duplicating responses.
- Method used to compare and evaluate the relative consequences of PSPS and wildfires.
- Outline of the strategic decision-making process for initiating a PSPS (e.g., a decision tree). Where the electrical corporation provides this information in another section of the WMP, it must provide a cross-reference here rather than duplicating responses.
- Protocols for mitigating the public safety impacts of PSPS, including impacts on first responders, health care facilities, operators of telecommunications infrastructure, and water electrical corporations/agencies.

The protocols on PSPS, including the following elements, are described in detail in the attached PSPS Plan. BVES updated its existing PSPS Plan to align with D. 21-06-034 Phase 3

guidelines. BVES also made additional revisions to make the PSPS Plan more actionable, focused, and concise.

While BVES does not have a formal quantitative method to evaluate the potential consequence of PSPS and wildfires, lessons learned can be drawn from similar utilities across the state. BVES has not experienced a wildfire event or a PSPS activation to capture challenging and successful takeaways. Once BVES fully implements Technosylva’s services, BVES will be able to have a near real-time ability to quantify the consequence of wildfires, and, therefore, the ability to evaluate and compare the wildfire consequence and risk to the consequences of a PSPS event.

Currently, the highest probability for triggering a PSPS event within the BVES service territory is the loss of SCE’s energy imports to the BVES service area due to a SCE-directed PSPS of the SCE supply lines. BVES imports from SCE are subject to PSPS activation initiated by SCE. SCE may activate a proactive de-energization of these lines even if these circuits within the BVES service area and conditions do not meet BVES PSPS thresholds. To address the possibility of SCE-directed PSPS events, BVES proposes to construct an energy storage project of approximately 5 MW/20 MWh (four-hour) lithium-ion utility-grade battery serving the BVES service area. In conjunction with the existing Bear Valley Power Plant and potential utility scale solar, BVES would be able to initially meet its energy demands during a supply drop from SCE for several hours depending on load shedding strategy. BVES will continue with project planning and evaluation of an energy storage and solar facility within the BVES service territory, though, this project timeline has been extended due to siting delays.

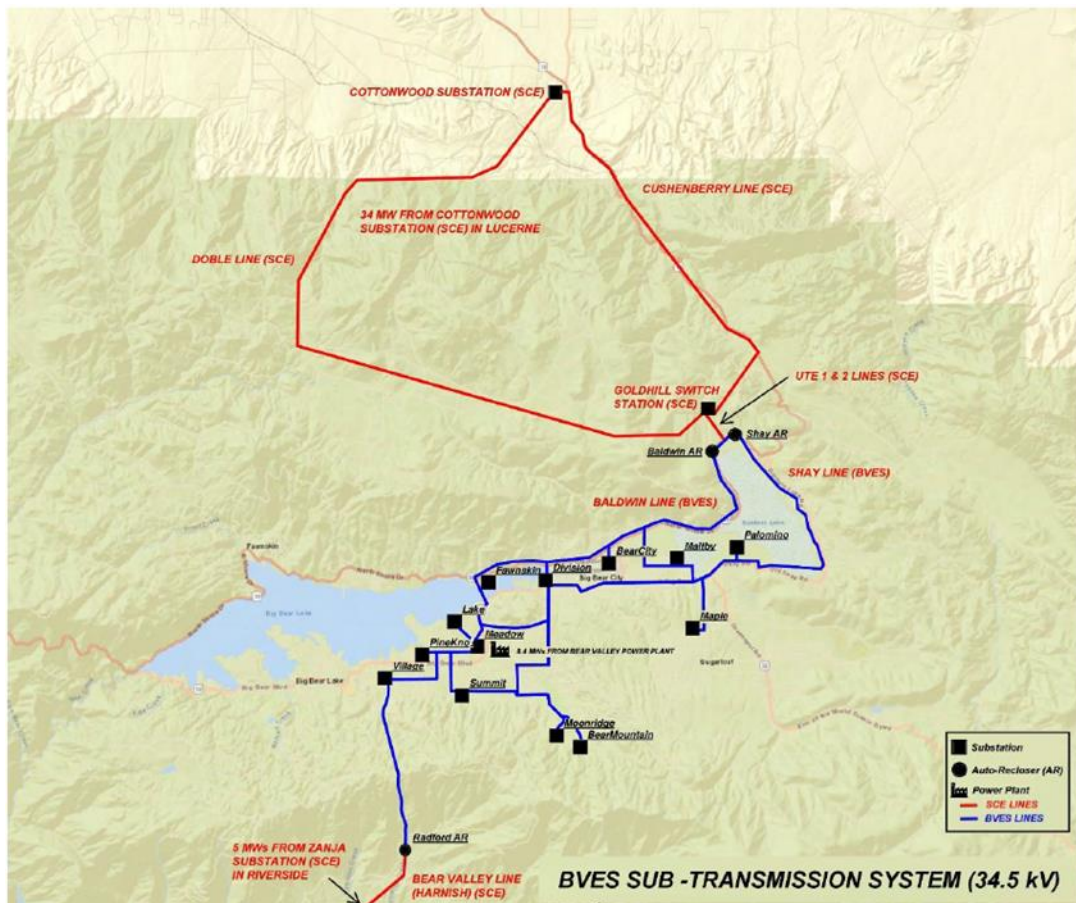

Figure 9-2 BVES Supply Lines, Sources of Power and Sub-Transmission System

The table below outlines BVES’s action plan for addressing partial or complete loss of power due to SCE supply line de-energization events.

BVES Table 9-3 BVES Action for SCE Lines De-Energized due to PSPS

Condition	BVES Action
SCE De-energizes Doble or Cushenberry Line for PSPS.	<p>Notify key internal staff and brief Field Operations staff on condition for situational awareness.</p> <p>Energize Radford Line as needed to meet load demand. If the Utility Manager deems it necessary, energize the Radford Line as needed for reliability.</p> <p>Startup BVPP as needed to meet load demand.</p> <p>No reduction on load necessary, since the Doble and Cushenberry are capable of carrying the other’s load.</p> <p>Implement applicable portions of BVES Emergency Response Plan for a partial loss of SCE supply lines</p>
SCE De-energizes Bear Valley Line for PSPS.	<p>Notify key internal staff and brief Field Operations on conditions for situational awareness.</p> <p>If Radford is energized, shift loads to Shay Line prior to de-energizing for PSPS. Generally, this should be done about 4 hours prior to the SCE de-energizing the line.</p> <p>If needed, start up BVPP to meet load demand.</p> <p>If needed, instruct interruptible customers (Bear Mountain Resorts) to reduce load as needed to meet load demand.</p> <p>Implement applicable portions of BVES EDRP for a partial loss of SCE supply lines</p>
SCE De-energizes Doble or Cushenberry and Bear Valley Lines for PSPS.	<p>Notify key internal staff and brief Field Operations on conditions for situational awareness.</p> <p>Since the Doble and Cushenberry are capable of carrying the other’s load, follow the procedure for “SCE De-energizes Bear Valley Line for PSPS” above.</p> <p>Prepare for potentially losing all SCE supply lines into BVES service area.</p> <p>Prepare for sustained BVPP operations and rolling blackouts.</p> <p>Evaluate distribution circuit loads.</p> <p>Implement applicable portions of BVES Emergency Response Plan for a partial loss of SCE supply lines.</p>

Condition	BVES Action
<p>SCE De-energizes Doble and Cushenberry Lines for PSPS.</p>	<p>Notify key internal staff and brief Field Operations on condition for situational awareness. If not already done, energize the Radford Line. Four hours prior to SCE de-energizing the lines, per the Field Operations Supervisor's direction, shift as much of the load to BVPP and Radford Line as follows: Open the Shay and Baldwin automatic reclosers. "Express" the Radford Line to Meadow Substation without overloading the Radford Line per Field Operations' switching order. Startup BVPP, place enginators online and increase load to within the combined capacity of the BVPP and Radford Line. Implement BVES Emergency Response Plan for sustained loss of SCE supplies from Lucerne including "rolling blackout" procedures. Prepare for sustained BVPP operations and rolling blackouts. Frequently monitor distribution circuit loads.</p>
<p>SCE de-energizes Doble, Cushenberry, and Bear Valley Lines for PPS.</p>	<p>Notify key internal staff and brief Field Operations on condition for situational awareness. If the Radford Line is energized, shift loads to the Shay Line. Four hours prior to SCE de-energizing the lines, per the Field Operations Supervisor's direction, perform the following: Start up all BVPP enginators. Reduce system load to within the capacity of BVPP by isolating distribution circuits as directed by the Field Operations Supervisor. Once system load is matched with BVPP capacity, open the Shay and Baldwin automatic reclosers. Implement BVES EDRP for sustained loss of all SCE supply lines including "rolling blackout" procedures.</p>

Section 5 of the attached PSPS Plan outlines the PSPS Protocols, which includes the tactical and strategic decision for initiating a PSPS/de-energization. Section 4 describes the conditions that could lead to a PSPS enactment, and Section 2 describes the chain of command for initiating a PSPS event. Section 4 of the BVES PPS Plan is being updated to include the protocols listed in Section 8.1.8.1 and BVES Table 8-4 FPI Operational Action

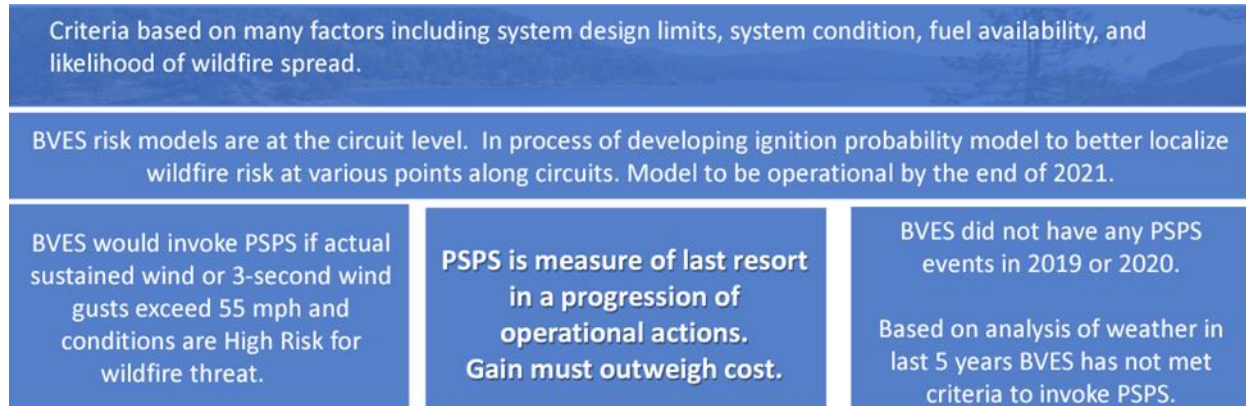

Figure 9-3 PPS Decision-Making Criteria

In summary, BVES considers the following when determining conditions that would meet or exceed thresholds for de-energization:

- Design strength and other characteristics of distribution overhead facilities,
- Vegetation density,
- FPI,
- NWS advisories,
- Local weather forecasts and advisories,
- BVES meteorologist’s forecast,
- Information from BVES installed weather stations,
- Real-time information from trained personnel positioned in high-risk areas, and
- Input from state and local authorities and Emergency Management Personnel.

“Extreme fire weather conditions” are deemed to be forecasted or exist when the FPI is High, Very High or Extreme, high winds (45 mph or greater) are forecasted or measured, and the BVES meteorologist forecasts high fire threat conditions. Once it is determined that “extreme fire weather conditions” are forecasted or exist, BVES Staff will implement BVES PPS Procedures that may ultimately lead to de-energization of affected circuits at the direction of the President.

Protocols for mitigating the public safety impacts of PPS, including impacts on first responders, health care facilities, operators of telecommunications infrastructure, and water electrical corporations/agencies

Section 6 of the PPS Plan describes BVES’s communication protocols designed to mitigate the public safety impacts of PPS on the community. Due to the significant impact that a PPS event may have on the community and customers, it is essential that early and accurate communications be conducted throughout the PPS event coincides with local government, agencies, partner organizations (including emergency management community and first responders, CALOES, county and local governments, independent living centers, and representatives of people/communities with access and functional needs), and customers. BVES takes additional steps to ensure that vulnerable, marginalized, and at-risk communities

are sufficiently informed of PSPS activities and wildfire outreach. As part of its public outreach, BVES is working towards increasing representation of people with AFN, senior citizen groups, business owners, and public health and healthcare providers including those with medical needs. This includes a CRC and communications regarding PSPS.

BVES's efforts since January 1, 2022, include the following:

- Increased social media posts regarding AFN education and how to self-identify
- Created and uploaded an AFN informational video on BVES's social media platforms and website
- Added AFN self-identification letter to the BVES website
- Entered into a confidentiality agreement to share BVES's AFN and Medical Baseline population with the City of Big Bear Lake and the local fire agencies
- Added additional CRC information and accommodations to the website
- Implemented a PSPS portal for critical facilities and community-based organizations
- Updated the AFN application to be available in English and Spanish on BVES's website
- Trained Customer Service representatives to inquire on all calls about potentially AFN-eligible members in customer households
- Purchased portable batteries for PSPS events that are reserved for Medical Baseline and AFN community members

A small number of BVES customers reside in mobile home parks or in multi-unit residences that have electric master meters. Among these customers, BVES identified five locations to include in its medical baseline tracking sheets. Since July 1, 2022, BVES has been including AFN applications in English and Spanish, CARE applications, Medical Baseline applications, and informational flyers on PSPS and its CRC for master metered property owners and their tenants.

Specific details on how BVES engages with communities is outlined below:

BVES hosts and advertises its end of year public meeting where WMP, PSPS, and reliability plans are presented through local radio and newspaper. BVES will ensure its website is updated and contains the current WMP and associated video. BVES also uses Facebook to regularly distribute the WMP including the WMP's identified equipment upgrades, vegetation management, and operational improvements. Finally, BVES issues newsletters that include information regarding the WMP and PSPS plans. BVES will ensure all communications and outreach portals will be maintained in English.

BVES, in collaboration with its contract public relations firm, has also implemented new plans to further enhance its ability to engage vulnerable individuals and communities. Working with this firm, BVES will continue its prior communication methods and establish new forms to endeavor to identify and engage with its marginalized and at-risk communities. This included issuing communications in both Spanish and English; as applicable, via mail carrier to its identified customers. This mailer was also made available on BVES's website in the other top identified languages of French, Tagalog, Vietnamese, and Chinese, as well as languages spoken by indigenous communities not in BVES's service territory, such as Mixteco and Zapoteco. BVES also conducted a non-contact electronic survey regarding its WMP outreach and has made the results of the survey available in English and Spanish on its website. Finally, BVES has implemented and began utilizing newly acquired two-way texting capabilities to notify BVES customers about PSPS events or other emergencies.

See example tracking reports for communications delivered throughout 2022. Additional detail is provided in BVES's 2020 and 2021 Wildfire Mitigation Community Outreach Survey Results. BVES conducted two surveys in 2022, to evaluate the effectiveness of its outreach efforts. A total of 423 surveys were completed which included 30 from critical customers. The results are as follows:

- 46% of BVES customers surveyed are aware of wildfire safety communications.
- 41% recall seeing, hearing or reading the phrase, "Public Safety Power Shutoff or PSPS."
- 41% say they would first turn to BVES website for information about a PSPS event.
- 81% have taken action to prevent wildfires or to prepare their home or business.
- 48% are aware of BVES's efforts to prune vegetation.
- 43% are aware they can update their contact information with BVES.
- 83% of those surveyed can be considered AFN.
- 98% indicated it would not be helpful to receive communications in a language other than English.

9.3 Communication Strategy for PSPS

In Section 8.4.4 of the WMP, the electrical corporation must discuss all public communication strategies for wildfires, outages due to wildfires and PSPS, and service restoration. Thus, in this section, the electrical corporation is only required to provide a cross-reference to Section 8.4.4 and any other section of the WMP providing details of the emergency public communication strategy for PSPS implementation.

BVES discusses in detail all public communication strategies for outages due to wildfires and PSPS as well as service restoration in Section 8.4.4 of this WMP. Additionally, Table 6-1 of the BVES PSPS Plan contains a comprehensive template outlining the communications plan for notifying the public and key partners during a potential PSPS activation.

9.4 Key Personnel, Qualifications, and Training for PSPS

In Section 8.4.2.2 of the WMP, the electrical corporation must discuss all key personnel planning, qualifications, and training for wildfires, outages due to wildfires, and PSPS, and service restoration. Thus, in this section, the electrical corporation is only required to provide a cross-reference to Section 8.4.2.2 and any other section of the WMP providing details of key personnel, qualifications, and training for PSPS implementation.

BVES discusses in detail the key personnel, planning, qualifications, and training for wildfires, outages due to wildfires, and PSPS, and service restoration in Section 8.4.2.2 of this WMP. Please refer to this section for details. Additionally, Section 2 of the PSPS Plan describes the Chain of Responsibility during a PSPS and detail on assigned personnel and their roles.

9.5 Planning and Allocation of Resources for Service Restoration due to PSPS

In Section 8.4.5.2 of the WMP, the electrical corporation must address planning of appropriate resources (e.g., equipment, specialized workers) and allocation of those resources to assure the safety of the public during service restoration. Thus, in this section, the electrical corporation is only required to provide a cross-reference to Section 8.4.5.2 and any other section of the WMP providing details of resource planning for PSPS implementation.

Section 4.9 of BVES's PSPS Plan describes the internal strategy to safely re-energize any area that was de-energized as part of a PSPS event. Restoration may take place when wind speeds

in the affected area where PSPS was invoked fall below 50 mph for a minimum period of 20 minutes, and crews assess that the fire weather conditions have subsided to “safe levels.” However, the crews may extend the calm period beyond 20 minutes, if they assess further gusts of greater than 50 mph are likely based on direct observation of local conditions or forecasts indicate a high probability of winds picking up to greater than 50 mph. Crews are to communicate with the Field Operations Supervisor prior to assessing the situation as “safe levels” so that an evaluation of actual conditions in the field may be merged with the latest forecasted information.

Restoration activities include: 1) validating that the extreme fire weather conditions have subsided, 2) conducting field inspections and patrols of facilities that were de-energized, and 3) re-energization of inspected (and repaired, if necessary) circuits. See the table below for additional detail.

Additional information can be found in Section 8.4.5.2 of this WMP.

BVES Table 9-4 PSPS Re-Energization and Post-Event Strategy

PSPS Activity	Phase Event	Internal Action	External Coordination
Restoration	<p>Re-energization</p> <p>(Extreme fire conditions subside to safe levels as validated by field conditions)</p>	<p>Operations & Planning:</p> <p>Field Crews validate that the extreme fire weather conditions have subsided to safe levels as designated by the Field Operations Supervisor and report these conditions to Dispatch.</p> <p>Field Crews conduct field inspections and patrols of facilities that were de-energized.</p> <p>When field inspections and patrols are completed satisfactorily, power is restored to the affected circuits.</p> <p>As SCE restores supply lines, Field Crews conduct switching operations as directed by Field Operations Supervisor to restore systems normal.</p> <p>Customer Service:</p>	<p>Local Government, Agencies, and Partner Organizations:</p> <p>Send “Intent to Restore” notice to local government, agencies, and partner organizations. Encourage widest dissemination of this information.</p> <p>Coordinate with the emergency management community, first responders, and local government in managing restorations.</p> <p>Send “Restoration Complete” notice to local government, agencies, and partner organizations once power is fully restored or an update if restoration is delayed.</p> <p>Update Stakeholders Portal</p> <p>Customer Outreach:</p> <p>Post “Intent to Restore” notice on BVES website and social media.</p> <p>Issue “Intent to Restore” press release for local media.</p>

PSPS Activity	Phase Event	Internal Action	External Coordination
		<p>Finalize “Intent to Restore” notice to include ETR(s) and obtain President’s approval to release.</p> <p>Finalize “Restoration Complete” notice to be issued when power is fully restored and obtain President’s approval to release.</p> <p>Breakdown of CRC including removal/storage of all equipment and supplies</p> <p>Prepare post-event reports</p> <p>Update Stakeholders Portal</p>	<p>Send out “Intent to Restore” notice via IVR.</p> <p>Send out “Intent to Restore” notice via Text</p> <p>Send out “Intent to Restore” notice via email</p> <p>Post “Restoration Complete” notice on BVES website and social media once power is fully restored or an update if restoration is delayed.</p> <p>Issue “Restoration Complete” press release for local media once power is fully restored or an update if restoration is delayed.</p> <p>Send out “Restoration Complete” notice via IVR once power is fully restored or an update if restoration is delayed.</p> <p>Send out “Restoration Complete” notice via Text once power is fully restored or an update if restoration is delayed.</p> <p>Send out “Restoration Complete” notice via email once power is fully restored or an update if restoration is delayed.</p>
Reporting and Lessons Learned	Post-Event	<p>Operations & Planning:</p> <p>Utility Manager conduct lessons learned with applicable staff. Include Customer Service and solicit input from Local Government, Agencies, and Partner Organizations.</p> <p>If applicable, update plan and procedures per the lessons learned.</p> <p>Prepare PSPS Post-Event Report required by ESRB-8 and forward to President</p>	<p>CPUC Safety Enforcement Division:</p> <p>File a report (written) to President of SED no later than 10 business days after the Shutoff event ends per ESRB-8.</p>

PSPS Activity	Phase Event	Internal Action	External Coordination
		and Manager Regulatory Affairs for approval.	

10. Lessons Learned

An electrical corporation must use lessons learned to drive continuous improvement in its WMP. Electrical corporations must include lessons learned due to ongoing monitoring and evaluation initiatives, collaboration with other electrical corporations and industry experts, and feedback from Energy Safety and other regulators.

The electrical corporation must provide a summary of new lessons learned since its most recent WMP submission, and any ongoing improvements to address existing lessons learned. This must include a brief narrative describing the new key lessons learned and a status update on any ongoing improvements due to existing lessons learned. The narrative should be limited to two pages.

The electrical corporation must also provide a summary of how it continuously monitors and evaluates its wildfire mitigation efforts to identify lessons learned. This must include various policies, programs, and procedures for incorporating feedback to make improvements.

Lessons learned can be divided into the three main categories: (1) internal monitoring and evaluation, (2) external collaboration with other electrical corporations, and (3) feedback from Energy Safety or other authoritative bodies. The following are examples of specific potential sources of lessons learned:

- *Internal monitoring and evaluation initiatives:*
 - *Tracking of risk events*
 - *Findings from root cause analyses and after-action reviews*
 - *Drills and exercises*
 - *Feedback from community engagement*
 - *PSPS events*
- *Feedback from Energy Safety or other authoritative bodies:*
 - *Areas for continued improvement identified by Energy Safety in the previous WMP evaluation period*
 - *Findings from wildfire investigations*
 - *Findings from Energy Safety Compliance Division assessments*
 - *Collaborations with other electrical corporations*

In addition to the above potential sources of lessons learned, the electric corporation must detail lessons learned from any and each catastrophic wildfire ignited by its facilities or equipment in the past 20 years, as listed in Section 5.3.2. The electric corporation must also detail specific mitigation measures implemented as a result of these lessons learned and demonstrate how the mitigation measures are being integrated into the electric corporation's wildfire mitigation strategy.

For each lesson learned, the electrical corporation must identify the following in Table 10-1:

- *Year the lesson learned was identified*
- *Subject of the lesson learned*
- *Specific type or source of lesson learned (as identified in the bullet lists above)*
- *Brief description of the lesson learned that informed improvement to the WMP*

- *Brief description of the proposed improvement to the WMP and which initiative(s) or activity(s) the electrical corporation intends to add or modify*
- *Estimated timeline for implementing the proposed improvement*
- *Reference to the documentation that describes and substantiates the need for improvement including:*
 - *Where relevant, a hyperlinked section and page number in the appendix of the WMP*
 - *Where relevant, the title of the report, date of report, and link to the electrical corporation web page where the report can be downloaded*
 - *If any lessons learned were derived from quantifiable data, visual/graphical representations of these lessons learned in the supporting documentation*

The 2023 WMP Update includes reports on actions undertaken over 2022 including activities relating to any deficiencies issued by the OEIS, including lessons learned from BVES and its peer utilities. In addition, the Plan has evolved significantly over the 2020, 2021, and 2022 WMP Update submissions through new templated processes, enhanced data collection and governance, and successful execution of high priority initiatives.

BVES has worked to make updates to its quantitative target setting to align with prioritized mitigation efforts. The 2023 WMP Update includes improvements such as enhanced mapping capabilities as BVES digitizes its asset and inspection practices, more meaningful metric tracking calibrated across multiple internal reporting processes and platforms, and climate-driven ignition probability maps that BVES will use to inform future initiative planning for areas of greatest wildfire risk.

BVES continuously monitors wildfire mitigation efforts. BVES conducts weekly Project Timeline Meetings and weekly Management Briefs where the wildfire mitigation efforts are discussed. If any concern arises, Field Operations, the Engineering Department and Management will quickly find a resolution to the concern. Any concern will be discussed in the weekly meetings until a resolution is found. The lessons learned will be presented to the appropriate employees, contractors, and discussed in the weekly meetings. If a problem is discovered in the field or through inspections, this information will be forwarded to management and will be discussed in these weekly meetings.

In addition, BVES conducts a monthly management-employee Safety Committee Meeting in which any safety concerns will be discussed for wildfire mitigation measures. If a safety concern is discussed, then BVES staff, our health and safety consultant, and management will resolve the issue. A resolution to a concern and lessons learned will be immediately shared with the appropriate employees and the safety committee.

Major themes and lessons learned from the prior WMPs, periodic submissions, and experience with mitigation efforts provide valuable insight into BVES's continuous improvement efforts. BVES experienced success in executing and implementing mitigation strategies and has not recorded a utility-ignited wildfire incident or activated a PSPS. Issues or delays in execution are addressed upon identification throughout the year. BVES continues to provide an open line of communication among the WMP responsible personnel up to and including the President. If a change of strategy is warranted, the appropriate department heads discuss potential actions and monitor any changes. Each quarter, the President, Treasurer, & Secretary meets with the Board of Director's Safety and Operations Committee, which encompasses governing body

members of the Company, to discuss any issues identified during the prior quarter and will discuss proposed alternatives in strategy. This process enables a feedback loop for continuous improvement.

Table 10-1 Table 10-1 provides a summary of lessons learned in 2020, 2021, and 2022 and corresponding changes in the BVES 2023 WMP Update.

Table 10-1 Lessons Learned

ID #	Year of Lesson Learned	Subject	Type or Source of Lesson Learned	Description of Lesson Learned	Proposed WMP Improvement	Timeline for Implementation	Reference
01	2020 / 2021		Resource Allocation Methodology	Internal and external resources are required to fill key roles for WMP implementation	BVES hired direct roles to oversee prioritized aspects of the WMP program and processes. However, external consultant support is still a necessity for some areas.	Completed 2021	Section 6; pg. 42 Section 7.1; pg. 85-86
02	2020 / 2021		Situational Awareness, Grid Design and System Hardening	External constraints related to federally managed or private lands impact initiative schedules and implementation and require active management	Execution of system hardening, and situational awareness initiatives resulted in some minor delays over the 2020-21 timeframe. For example, BVES was able to complete the last two weather station installations in early 2021 after significant delays. Similarly, BVES has pushed out the schedule for its energy storage project due to land siting issues.	Completed 2021	Section 8.3.1.1 – 8.3.1.3; pg. 233-238
03	2020 / 2021		Grid Design and System Hardening	Replicated initiatives among California IOUs on	BVES has worked to better account for its mitigation measures	Completed 2021	Section 8.1; pg. 109-186

ID #	Year of Lesson Learned	Subject	Type or Source of Lesson Learned	Description of Lesson Learned	Proposed WMP Improvement	Timeline for Implementation	Reference
				similar time schedules causes material procurement delays and increased costs for system hardening initiatives such as covered conductor hardening	under varying WMP mitigation category initiative listings, which results in slight deviations from planned expenditure. These issues are addressed by a revised accounting methodology that has been applied to align to the latest OEIS issued initiative listing. BVES has moved to a year-ahead purchasing schedule for system hardening stock based on initiative efficiencies and historic replacement trends. Projections on stock have also improved.		
04	2020 / 2021		Grid Design and System Hardening	Winter months snow loading requires careful planning of field work	Due to the topography and climate of the region, BVES experiences seasonal delays due to inability to perform field work during winter weather conditions. As substantive mitigation measures are	Ongoing	Section 8.1.1.1 – 8.1.1.3; pg. 110-126

ID #	Year of Lesson Learned	Subject	Type or Source of Lesson Learned	Description of Lesson Learned	Proposed WMP Improvement	Timeline for Implementation	Reference
					deployed within the earlier years of the WMP program, this concern will lessen, and strategic operations can be better refined to avoid such harsh winter conditions.		
05	2020 / 2021		Risk Assessment and Mapping	Determination of quantitatively driven metrics and risk spend efficiency (RSE) values are needed to adequately measure initiative effectiveness for existing and enhanced technologies	BVES was not able to update all its RSE values in 2021 within the quarterly data report (QDR) updates due to initiative recategorization and lack of sustained metrics, which result in meaningful baseline data metrics.	Ongoing	Section 6; pg. 43-84
06	2020 / 2021		Risk Assessment and Mapping	Determination of quantitatively driven metrics and RSE values are needed to adequately measure initiative effectiveness for existing and enhanced technologies	BVES has deployed grid hardening activities on prioritized circuits to reduce future risk events. The intent is to lower the number of risk events captured in the QDR metrics as demonstrated spark-resistant measures are	Completed 2021	Section 6; pg. 43-84

ID #	Year of Lesson Learned	Subject	Type or Source of Lesson Learned	Description of Lesson Learned	Proposed WMP Improvement	Timeline for Implementation	Reference
					<p>applied to the system (e.g., number of blown fuse events recorded over time). BVES completed its program to replace all conventional fuses with current limiting and electronic fuses. The resulting metrics indicate this effort is already reducing blown fuse events, a significant ignition risk factor.</p>		
07	2020 / 2021		Risk Assessment and Mapping	<p>Determination of quantitatively driven metrics and RSE values are needed to adequately measure initiative effectiveness for existing and enhanced technologies</p>	<p>BVES works in its third year of hardening efforts. Overall risk events have not begun to indicate a downward trend in activity, apart from blown fuse tracking. The anticipated result fewer risk events on the system year over year. Risk predictions and recorded incidents determine the baseline and BVES will track these metrics for future WMP Updates.</p>	On-going	Section 6; pg. 43-84

ID #	Year of Lesson Learned	Subject	Type or Source of Lesson Learned	Description of Lesson Learned	Proposed WMP Improvement	Timeline for Implementation	Reference
08	2020 / 2021		Risk Assessment and Mapping	Determination of quantitatively driven metrics and RSE values are needed to adequately measure initiative effectiveness for existing and enhanced technologies	BVES has replaced an increased number of poles and determined needs for fire resistant wrapping as inspection programs are carried out. Metrics do not indicate a meaningfully scaled trend, but they do convey increased intrusive inspections of poles for remediation or replacement, for which BVES has met its internal targets.	On-going	Section 6; pg. 43-84
09	2020 / 2021		Risk Assessment and Mapping	Improved data tracking, equipment inventorying practices, and refined definitions for specific metrics leads to instances of impacted quantitative metrics	In preparation for this filing, BVES reviewed the completed 2021 metrics, as well as its projects initiated to mitigate against wildfire ignitions and damage to BVES equipment and facilities, to determine whether current scheduling and planned execution is sufficient in its 2022 WMP Update. BVES has also been able to achieve greater	Completed 2021	Section 6; pg. 43-84

ID #	Year of Lesson Learned	Subject	Type or Source of Lesson Learned	Description of Lesson Learned	Proposed WMP Improvement	Timeline for Implementation	Reference
					granularity in weather data with no identified increase in severe weather. Due to better data tracking, equipment inventory practices, and refined definitions for specific metrics, BVES has seen instances of impacted quantitative metrics from 2020 to 2021. In years prior, BVES had not been able to effectively leverage existing data.		
10	2020 / 2021		Risk Assessment and Mapping	The ignition risk and consequence mapping project has provided useful insight into simulations of fire threats	The modeling exercise will influence future planning as current initiatives are carried out. The models and maps were finalized in late 2021, providing an initial screening into areas of greatest concern beyond the High Fire-Threat District (HFTD) and wildland-urban interface (WUI) designations. In future reporting and	Completed 2021	Section 6; pg. 43-84

ID #	Year of Lesson Learned	Subject	Type or Source of Lesson Learned	Description of Lesson Learned	Proposed WMP Improvement	Timeline for Implementation	Reference
					mitigation measure determination, these maps will contribute to navigate decision-making along with existing risk modeling tools.		
11	2020 / 2021		Stakeholder Cooperation and Community Engagement	Apply findings from public safety partners and community coordination throughout the year to inform future planning	Drawing upon lessons learned from other California utilities, BVES has increased its community engagement activities over 2021 from 2020 as well as engaging more broadly with the direct public safety partners within the service area.	Ongoing	Section 8.5.4 – 8.5.5; pg. 361-366
12	2022		Tracking of Risk Events	The need for BVES to follow the Emergency Response Disaster Plan (EDRP) precisely	No direct link to WMP	N/A	N/A
13	2022		Drills and Exercises and the associated Community Engagement	The feedback from Drills and Exercise is vital to the advancement of BVES programs, specifically those related to PSPS	Actions Taken in 2022: (1) BVES improved its coordinated communication with external parties, partners, and agencies by maintaining its	Completed 2022	Section 8.4.2; pg. 266-284 8.4.3; pg. 294-327 9.1.2; pg. 368-369 9.1.4; pg. 375

ID #	Year of Lesson Learned	Subject	Type or Source of Lesson Learned	Description of Lesson Learned	Proposed WMP Improvement	Timeline for Implementation	Reference
					<p>PSPS portal and verifying key contact lists in advance of the wildfire season, (2) increased exercise complexity and interaction, (3) provided additional backup training for various emergency roles and levels or responsibilities, and (4) prepared for both in-person and remote work emergencies.</p>		
14	2022		Continued Improvement per Energy Safety Guidance	<p>More detail and more identifiers in its customer database would benefit BVES</p> <p>Energy Safety Advised BVES to make updates in its Spatial Data to include more information for clarity and granularity</p>	<p>Both these items apply to Customer Outreach and Emergency Response. No direct connection to WMP but guided changes to internal BVES plans.</p> <p>Per Energy Safety request, BVES added flags in November 2022 to the Customer Data Base regarding customers with security or access concerns. This allows BVES to know ahead</p>	Completed 2022	QDR

ID #	Year of Lesson Learned	Subject	Type or Source of Lesson Learned	Description of Lesson Learned	Proposed WMP Improvement	Timeline for Implementation	Reference
					<p>of time if there are concerns when entering a customer sight.</p> <p>Per discussions with Energy Safety, the Spatial Data was upgraded in the 2022 QDRs to include Initiatives (Grid Hardening, Vegetation Management, Asset Inspections, Vegetation Inspections) and FEATURE CLASSES (Switchgears, Transformer Sites, Primary Distribution Lines, Support Structures, Unplanned Outages, Lightning Arrestors).</p>		
15	2022		Covered Conductor Working Group	The utilities agree that it is helpful to share information, practices, and data across the utilities as this can lead to improvements in reducing wildfire	General review of communication plans/targets for the 2023 cycle	Ongoing	Section 8.5.5; pg. 363-366

ID #	Year of Lesson Learned	Subject	Type or Source of Lesson Learned	Description of Lesson Learned	Proposed WMP Improvement	Timeline for Implementation	Reference
				risk, safety incidents, and the impacts of PSPS, and improvements with other utility objectives. Several shared discussions of materials and procedures have helped improved BVES's covered conductor program.			
16	2022		Risk Model Working Group	The Risk Model Working Group has provided BVES with significant amount of detailed information concerning Risk Modeling especially from the Large Utilities which utilize more detailed modeling than BVES.	The information gained can help shape how BVES uses its risk modeling resources and makes decisions moving forward.	Ongoing	Section 8.5.5; pg. 363-366

11. Corrective Action Program

In this section, the electrical corporation must describe its corrective action program. The electrical corporation must present a summary description of the relevant portions of its existing procedures.

The electrical corporation must report on how it maintains a corrective action program to track formal actions and activities undertaken to:

- *Prevent recurrence of risk events*
- *Address findings from wildfire investigations (both internal and external)*
- *Address findings from Energy Safety's Compliance Assurance Division (i.e., audits and notices of defect and violation)*
- *Address areas for continued improvement identified by Energy Safety as part of the WMP evaluation*

The electrical corporation must report on how it reviews each improvement area in accordance with its corrective action program. At a minimum, the electrical corporation must:

- *Identify insufficient occurrence and response: Identify targeted corrective actions for areas where the event occurrence, response, or feature was insufficient.*
- *Identify actions to reduce recurrence: Identify improvement actions (as applicable) to reduce the likelihood of recurrence, improve response/mitigation actions, or improve operational procedures or practices.*
- *Track implementation: Track the improvement action plan and schedule in the electrical corporation's action tracking system.*
- *Improve external communication: For areas where weaknesses were identified in the response of external agencies, develop a communication plan to share the information and conclusion with the responsible agency. The completion of this action and the agency's response must be documented.*
- *Integrate lessons learned from across the industry: Identify applicable generic lessons learned to improve the overall effectiveness of the electrical corporation WMP.*
- *Share lessons learned with others: Identify and communicate any significant generic lessons learned that should be disseminated broadly (i.e., to other electrical corporations and responsible regulatory authorities, such as Energy Safety or CAL FIRE).*

The WMP should not include detailed corrective action plans for each risk event, finding, and/or improvement area. However, this documentation must be made available to Energy Safety upon request.

In 2022 there were no audits or related findings from Energy Safety or Internal/External Investigations. It is BVES's policy to address all results of investigation (Internal, External, Energy Safety Compliance Assurance Division) within the window enforced by the discovering party. BVES does, however, prioritize audit findings requiring a corrective action plan. Any corrective action plan requiring an extended timeline to address would be tracked and monitored through a project plan.

BVES maintains documented plans for follow up and continuing to ensure that continuous improvement efforts incorporate any lessons learned. For example, BVES contracts with BSI, a group of safety consultants, to review and update safety procedures and ensure they are in accordance with current best practices and standards. BVES also adheres to FEMA's 6-step

planning process as preparation for and review of any event and ensures there is a thorough debrief following an event to capture lessons learned.

Energy Safety provided feedback on BVES's 2022 WMP in its decision letter. The items identified, progress and updates from that feedback are in BVES Table 11-1 below.

BVES Table 11-1 2022 WMP Feedback and Status

Issue #	Title	Status	Comments
BVES 21-07	Lack of detail on prioritization of initiatives based on determined risk	Improving maturity on tracking for this initiative, improvements expected by 2023.	With the change in WMP template and differing requested information, BVES believes that Section 6 & 7 of the current WMP provide detail to support assessment of previous WMP issue
BVES-21-09	Lack of asset inspection quality assurance and quality control (QA/QC) program	<p>BVES has been working to improve the maturity of the asset inspection quality assurance and quality control program by 2023. Specifically, BVES is focusing on the following areas:</p> <ul style="list-style-type: none"> - BVES plans to schedule patrol, detailed, and other inspections based on modeling and risk assessments. - BVES plans to include lines and equipment typically responsible for ignitions and near misses in its inspection procedures and checklists, as opposed to only items required by statute and regulations. - BVES plans to base procedures and checklists on predictive modeling and to increase the granularity from a service territory to a circuit level. - BVES plans to include performance history and past operating conditions when accounting for maintenance and repair procedures. 	BVES accelerated implementation and improved its asset inspection QA/QC programs and continues to demonstrate progress in section 8.1.4. It is important to note that BVES has now fully implemented its QA/QC program and is no longer operating on a “interim” program

Issue #	Title	Status	Comments
RN-BVES-22-03	BVES has not sufficiently connected its risk assessment with its mitigation initiative prioritization	<p>Continuing to monitor the below efforts:</p> <p>a) Integrate its response to BVES-21-07, found in Appendix A, into WMP Section 7.3.3 “Grid Design and System Hardening.”</p> <p>b) Demonstrate that its risk assessments directly inform the prioritization of initiatives, instead of broadly stating that risk is a consideration or defaulting prioritization to only HTFD Tier 2 and Tier 3 designations.</p> <p>c) Demonstrate that its future planned grid hardening mitigation initiatives, particularly covered conductor, will address the highest risk circuits as self-assessed and identified by BVES and its relevant contractor(s).</p> <p>d) Describe how it selected the location of its covered conductor pilot program.</p>	<p>BVES improved its initiative prioritization program in 2022 and better aligned it with the risks presented in its service territory. This is presented in Sections 6 & 7. BVES has recently implemented Technosylva’s WRRM, which will be the primary risk model for prioritizing WMP initiatives in BVES’s 2024 WMP Update. Furthermore, in BVES’s 2024 WMP Update, it expects to have calculated likelihood and consequence for relevant risks.</p>
RN-BVES-22-04	BVES has not provided sufficient information on quality assurance & quality control (QA/QC)	<p>BVES was required to:</p> <p>a) Provide details on progress made developing and implementing its formal QA/QC process, including implementation timing.</p> <p>b) Provide results of the “interim” QA/QC processes BVES has used for assets, including details on what type of QA/QC was performed, the percentage of asset inspections on which BVES completed QA/QC, and the results of the QA/QC performed since the 2021 Update.</p>	<p>BVES accelerated implementation and improved its QA/QC programs and continues to demonstrate progress in section 8.1.4 & 8.2.5.</p>

Issue #	Title	Status	Comments
RN-BVES-22-06	BVES has misinterpreted data management initiatives	BVES was required to describe how it currently manages all data relevant to wildfire mitigation and any planned or ongoing improvements to these systems, in accordance with the 2022 WMP Guidelines. BVES should not limit the discussion to the provision of quarterly spatial data required by Energy Safety.	BVES continues to improve its data management for asset and vegetation management through iRestore, its GIS program, Technosylva, and other tools to better track, monitor, and share key WMP data. BVES is evolving its programs to an enterprise system with spatial capability.
RN-BVES-22-07	BVES does not describe how quantifiable risk reductions and RSE estimates inform initiative selection	BVES was required to provide: a) An overview of its decision-making framework that includes the rankings of relative decision-making factors (e.g., planning and execution lead times, resource constraints, etc.) and pinpoints where quantifiable risk reductions and RSE estimates are considered in the initiative selection process. b) A cascading, dynamic “if-then” style flow chart to effectively demonstrate this prioritization process.	See discussion above in response to RN-BVES-22-03.
RN-BVES-22-10	BVES does not describe how its PSPS planning has evolved	BVES was required to: a) Provide more information to describe how its planning has evolved, as specified by Section 8.3 of the Guidelines. This should include lessons learned from other utilities and internal exercises, and how those were used to update its PSPS Plan. b) File a revised PSPS Plan within 30 days of Energy Safety’s Decision on BVES’s 2022 Update integrating the requirements of D.21-06-034.53.	BVES files a revised PSPS Plan in 2022 fulfilling the request of RN-BVES-22-10 as well as meeting Phase III requirements. This is also addressed in sections 8.4 and 9 of this WMP.

BVES is involved with and participates in several working groups to gather and share lessons learned and best practices across a variety of topics and specialty areas. Individual personnel are assigned to participate in each group and will report back any applicable information for consideration in future improvements. A full list of the working groups and their respective updates or subject matter can be found below in BVES Table 11-2.

BVES Table 11-2 Working Groups

Working Group Title	Description
Covered Conductor Working Group (and multiple sub-working groups)	Utilities meet to discuss the effectiveness and alternatives to covered conductors. Several sub-working groups meet to for detailed discussions on specific topics.
Risk Modeling Working Group	Utilities, Energy Safety, and industry experts meet to discuss ideas and methods on how to improve modeling which evaluates wildfire risk.
Utilities Best Learn from Each Other Working Group	Working Group will begin in 2023. The working group will discuss lessons learned to help disseminate useful information throughout the industry.
Electric Vehicle Working Group.	Utilities meet to discuss electric vehicle technologies.

12. Notice of Violation and Defect

Within a Notice of Violation (NOV) or Notice of Defect (NOD), Energy Safety directs an electrical corporation to correct a violation or defect within a specific timeline, depending on the risk category of the violation or defect. The electrical corporation has 30 days to respond to the NOV or NOD and provide a plan for corrective action. Following completion of corrective action, the electrical corporation must provide Energy Safety with documentation validating the resolution or correction of the identified violation or defect. Energy Safety includes the electrical corporation's response and the resolution status of any violations or defects in the summaries it provides to the CPUC.

In of the WMP, the electrical corporation must provide a list of all open violations and defect

BVES does not currently have any open Notice of Violation (NOV) or Notice of Defect (NOD). To date, BVES has not received an NOV or NOD. If and when, BVES receives an NOV or NOD, appropriate and timely corrective actions will be taken, and the associated documentation needs will be met.

Table 12-1 Open Violations and Defects

ID	Type	Severity	Date of Notice	Date of Response	Summary Description of Violation/Defect	Estimated Completion Date	Summary Description of Correction
N/A	N/A	N/A	N/A	N/A	N/A	N/A	N/A

Appendix A. Definitions

Unless otherwise expressly stated, the following words and terms, for the purpose of these Guidelines, have the meanings shown in this chapter.

A.1 Terms Defined in Other Codes

Where terms are not defined in these Guidelines and are defined in the Government Code, Public Utilities Code, or California Public Resources Code, such terms have the meanings ascribed to them in those codes.

A.2 Terms Not Defined

Where terms are not defined through the methods authorized by this section, such terms have ordinarily accepted meanings such as the context implies.

A.3 Definition of Terms

Term	Definition
Access and functional needs population (AFN)	Individuals, including, but not limited to, those who have developmental or intellectual disabilities, physical disabilities, chronic conditions, or injuries; who have limited English proficiency or are non-English speaking; who are older adults, children, or people living in institutionalized settings; or who are low income, homeless, or transportation disadvantaged, including, but not limited to, those who are dependent on public transit or pregnant. (California Government Code 8593.3(f)(1) and
Asset (utility)	Electric lines, equipment, or supporting hardware.
At-risk species	See “high-risk species.”
Benchmarking	A comparison between one electrical corporation’s protocols, technologies used, or mitigations implemented, and other electrical corporations’ similar endeavors.
Calibration	Adjustment of a set of code input parameters to maximize the resulting agreement of the code calculations with observations in a specific scenario. ¹
Catastrophic wildfire	A fire that caused at least one death, damaged over 500 structures, or burned over 5,000 acres.
Circuit miles	The total length in miles of separate transmission and/or distribution circuits, regardless of the number of conductors used per circuit (i.e., different phrases).

¹ Adapted from T. G. Trucano, L. P. Swiler, T. Igusa, W. L. Oberkampf, and M. Pilch, 2006, “Calibration, validation, and sensitivity analysis: What’s what,” , vol. 91, no. 10–11, pp. 1331– 1357.

Consequence	The adverse effects from an event, considering the hazard intensity, community exposure, and local vulnerability.
Contact by object ignition likelihood	The likelihood that a non-vegetative object (such as a balloon or vehicle) will contact utility-owned equipment and result in an ignition.
Contact by vegetation ignition likelihood	The likelihood that vegetation will contact utility-owned equipment and result in an ignition.
Contractor	Any individual in the temporary and/or indirect employ of the electrical corporation whose limited hours and/or time-bound term of employment are not considered “full-time” for tax and/or any other purposes.
Critical facilities and infrastructure	<p>Facilities and infrastructure that are essential to public safety and that require additional assistance and advance planning to ensure resiliency during PSPS events. These include the following:</p> <p>Emergency services sector:</p> <ul style="list-style-type: none"> • Police stations • Fire stations • Emergency operations centers • Public safety answering points (e.g., 9-1-1 emergency services) <p>Government facilities sector:</p> <ul style="list-style-type: none"> • Schools • Jails and prisons <p>Health care and public health sector:</p> <ul style="list-style-type: none"> • Public health departments • Medical facilities, including hospitals, skilled nursing facilities, nursing homes, blood banks, health care facilities, dialysis centers, and hospice facilities (excluding doctors’ offices and other non-essential medical facilities) <p>Energy sector:</p> <ul style="list-style-type: none"> • Public and private utility facilities vital to maintaining or restoring normal service, including, but not limited to, interconnected publicly owned electrical corporations and electric cooperatives <p>Water and wastewater systems sector:</p> <ul style="list-style-type: none"> • Facilities associated with provision of drinking water or processing of wastewater, including facilities that pump, divert, transport, store, treat, and deliver water or wastewater <p>Communications sector:</p> <ul style="list-style-type: none"> • Communication carrier infrastructure, including selective routers, central offices, head ends, cellular switches, remote terminals, and cellular sites <p>Chemical sector:</p> <ul style="list-style-type: none"> • Facilities associated with manufacturing, maintaining, or distributing hazardous materials and chemicals (including Category N-Customers as defined in D.01-06-085) <p>Transportation sector:</p>

	<ul style="list-style-type: none"> Facilities associated with transportation for civilian and military purposes: automotive, rail, aviation, maritime, or major public transportation <p>(D.19-05-042 and D.20-05-051)</p>
Customer hours	Total number of customers, multiplied by average number of hours (e.g., power outage).
Danger tree	Any tree located on or adjacent to a utility right-of-way or facility that could damage utility facilities should it fall where (1) the tree leans toward the right-of-way, or (2) the tree is defective because of any cause, such as: heart or root rot, shallow roots, excavation, bad crotch, dead or with dead top, deformity, cracks or splits, or any other reason that could result in the tree or main lateral of the tree falling. (California Code of Regulation Title 14 § 895.1)
Data cleaning	Calibration of raw data to remove errors (including typographical and numerical mistakes).
Dead fuel moisture content	Moisture content of dead vegetation, which responds solely to current environmental conditions and is critical in determining fire potential.
Detailed inspection	In accordance with General Order (GO) 165, an inspection where individual pieces of equipment and structures are carefully examined, visually and through routine diagnostic testing, as appropriate, and (if practical and if useful information can be so gathered) opened, and the condition of each is rated and recorded.
Disaster	A serious disruption to the functioning of a community or a society at any scale due to hazardous events interacting with conditions of exposure, vulnerability, and capacity, leading to one or more of the following: human, material, economic, and environmental losses and impacts. The effect of the disaster can be immediate and localized but is often widespread and could last a long time. The effect may test or exceed the capacity of a community or society to cope using its own resources. Therefore, it may require assistance from external sources, which could include neighboring jurisdictions or those at the national or international levels. (United Nations Office for Disaster Risk Reduction [UNDRR].)
Discussion-based exercise	Exercise used to familiarize participants with current plans, policies, agreements, and procedures or to develop new plans, policies, agreements, and procedures. Often includes seminars, workshops, tabletop exercises, and games.
Electrical corporation	Every corporation or person owning, controlling, operating, or managing any electric plant for compensation within California, except where the producer generates electricity on or distributes it through private property solely for its own use or the use of its tenants and not for sale or transmission to others.
Emergency	Any incident, whether natural, technological, or human caused, that requires responsive action to protect life or property but does not result

	in serious disruption of the functioning of a community or society. (FEMA/UNDRR.)
Enhanced inspection	Inspection whose frequency and thoroughness exceed the requirements of a detailed inspection, particularly if driven by risk calculations.
Equipment ignition likelihood	The likelihood that utility-owned equipment will cause an ignition through either normal operation (such as arcing) or failure.
Exercise	An instrument to train for, assess, practice, and improve performance in prevention, protection, response, and recovery capabilities in a risk-free environment. (FEMA.)
Exposure	The presence of people, infrastructure, livelihoods, environmental services and resources, and other high-value assets in places that could be adversely affected by a hazard.
Fire ecology	A scientific discipline concerned with natural processes involving fire in an ecosystem and its ecological effects, the interactions between fire and the abiotic and biotic components of an ecosystem, and the role of fire as an ecosystem process.
Fire Potential Index (FPI)	Landscape scale index used as proxy for assessing real-time risk of a wildfire under current and forecasted weather conditions.
Fire season	The time of year when wildfires are most likely for a given geographic region due to historical weather conditions, vegetative characteristics, and impacts of climate change. Each electrical corporation defines the fire season(s) across its service territory based on a recognized fire agency definition for the specific region(s) in California.
Frequency	The anticipated number of occurrences of an event or hazard over time.
Frequent PSPS events	Three or more PSPS events per calendar year per line circuit.
Fuel density	Mass of fuel (vegetation) per area that could combust in a wildfire.
Fuel management	Removal or thinning of vegetation to reduce the potential rate of propagation or intensity of wildfires.
Fuel moisture content	Amount of moisture in a given mass of fuel (vegetation), measured as a percentage of its dry weight.
Full-time employee (FTE)	Any individual in the ongoing and/or direct employ of the electrical corporation whose hours and/or term of employment are considered “full-time” for tax and/or any other purposes.
Game	A simulation of operations that often involves two or more teams, usually in a competitive environment, using rules, data, and procedures designed to depict an actual or assumed real-life situation.
Goals	The electrical corporation’s general intentions and ambitions.

GO 95 nonconformance	Condition of a utility asset that does not meet standards established by GO 95.
Grid hardening	Actions (such as equipment upgrades, maintenance, and planning for more resilient infrastructure) taken in response to the risk of undesirable events (such as outages) or undesirable conditions of the electrical system to reduce or mitigate those events and conditions, informed by an assessment of the relevant risk drivers or factors.
Grid topology	General design of an electric grid, whether looped or radial, with consequences for reliability and ability to support PSPS (e.g., ability to deliver electricity from an additional source).
Hazard	A condition, situation, or behavior that presents the potential for harm or damage to people, property, the environment, or other valued resources. ²
Hazard tree	See danger tree
High Fire Threat District (HFTD)	Areas of the state designated by the CPUC as having elevated wildfire risk, where each utility must take additional action (per GO 95, GO 165, and GO 166) to mitigate wildfire risk. (D.17-01-009.)
High Fire Risk Area (HFRA)	Areas that the electrical corporation has deemed high risk from wildfire, independent of HFTD designation.
Highly rural region	In accordance with 38 CFR 17.701, area with a population of less than seven persons per square mile, as determined by the United States Bureau of the Census. For purposes of the WMP, “area” must be defined as a census tract.
High-risk species	Species of vegetation that (1) have a higher risk of either coming into contact with powerlines or causing an outage or ignition, or (2) are easily ignitable and within close proximity to potential arcing, sparks, and/or other utility equipment thermal failures. The status of species as “high-risk” must be a function of species-specific characteristics, including growth rate; failure rates of limbs, trunk, and/or roots (as compared to other species); height at maturity; flammability; and vulnerability to disease or insects.
High Wind Warning (HWW)	Level of wind risk from weather conditions, as declared by the National Weather Service (NWS). For historical NWS data, refer to the Iowa State University archive of NWS watches/warnings. ³
HWW overhead (OH) circuit mile day	Sum of OH circuit miles of utility grid subject to a HWW each day within a given time period, calculated as the number of OH circuit miles under a HWW multiplied by the number of days those miles are under said HWW. For example, if 100 OH circuit miles are under a HWW for one day, and 10 of those miles are under the HWW for an additional day, then the total HWW OH circuit mile days would be 110.

² Adapted from SFPE, 2010, “Substantiating a Fire Model for a Given Application,” *Society of Fire Protection Engineers Engineering Guides*.

³ <https://mesonet.agron.iastate.edu/request/gis/watchwarn.phtml>.

Ignition consequence	The total anticipated adverse effects from an ignition at each location in the electrical corporation service territory. This considers the likelihood that an ignition will transition into a wildfire (wildfire spread likelihood) and the consequences that the wildfire will have on each community it reaches (wildfire consequence).
Ignition likelihood	The total anticipated annualized number of ignitions resulting from utility-owned assets at each location in the electrical corporation service territory. This considers probabilistic weather conditions, type and age of equipment, and potential contact of vegetation and other objects with utility assets.
Ignition probability	The relative possibility that an ignition will occur, quantified as a number between 0 percent (impossibility) and 100 percent (certainty). The higher the probability of an event, the more certainty there is that the event will occur. (Often informally referred to as likelihood or chance.)
Ignition risk	The total anticipated annualized impacts from ignitions at a specific location. This considers the likelihood that an ignition will occur, the likelihood the ignition will transition into a wildfire, and the potential consequences – considering hazard intensity, exposure potential, and vulnerability – the wildfire will have on each community it reaches.
Impact/consequence of ignition	The effect or outcome of a wildfire ignition upon objectives that may be expressed by terms including, although not limited to, maintaining health and safety, ensuring reliability, and minimizing economic and/or environmental damage.
Incident command system (ICS)	A standardized on-scene emergency management construct. It is specifically designed to provide an integrated organizational structure that reflects the complexity and demands of single or multiple incidents, without being hindered by jurisdictional boundaries. The ICS is the combination of facilities, equipment, personnel, procedures, and communications operating within a common organizational structure, designed to aid in the management of resources during incidents.
Initiative	Measure or activity, either proposed or in process, designed to reduce the consequences and/or probability of wildfire or PSPS.
Integrated public alert warning system (IPAWS)	System allowing the President to send a message to the American people quickly and simultaneously through multiple communications pathways in a national emergency. IPAWS also is available to the United States federal, state, local, territorial, and tribal government officials to alert the public via the Emergency Alert System (EAS), Wireless Emergency Alerts (WEA), National Oceanic and Atmospheric Administration (NOAA), Weather Radio, and other NWS dissemination channels; the internet; existing unique warning systems; and emerging distribution technologies.
Invasive species	A species (1) that is non-native (or alien) to the ecosystem under consideration and (2) whose introduction causes or is likely to cause economic or environmental harm or harm to human health.

Level 1 finding	In accordance with GO 95, an immediate safety and/or reliability risk with high probability for significant impact.
Level 2 finding	In accordance with GO 95, a variable safety and/or reliability risk (non-immediate and with high to low probability for significant impact).
Level 3 finding	In accordance with GO 95, an acceptable safety and/or reliability risk.
Limited English Proficiency (LEP) population	Population with limited English working proficiency based on the International Language Roundtable scale.
Line miles	The number of miles of transmission and/or distribution conductors, including the length of each phase and parallel conductor segment.
Live fuel moisture content	Moisture content within living vegetation, which can retain water longer than dead fuel.
Locally relevant	In disaster risk management, generally understood as the scale at which disaster risk strategies and initiatives are considered the most effective at achieving desired outcomes, this tends to be the level closest to impacting residents and communities, reducing existing risks, and building capacity, knowledge, and normative support. Locally relevant scales, conditions, and perspectives depend on the context of application.
Match-drop simulation	Wildfire simulation method forecasting propagation and consequence/impact based on an arbitrary ignition.
Memorandum of Agreement (MOA)	A document of agreement between two or more agencies establishing reciprocal assistance to be provided upon request (and if available from the supplying agency) and laying out the guidelines under which this assistance will operate. It can also be a cooperative document in which parties agree to work together on an agreed-upon project or meet an agreed objective.
Mitigation	Activities to reduce the loss of life and property from natural and/or human-caused disasters by avoiding or lessening the impact of a disaster and providing value to the public by creating safer communities.
Model uncertainty	The amount by which a calculated value might differ from the true value when the input parameters are known (i.e., limitation of the model itself based on assumptions). ⁴
Multi-attribute value function (MAVF)	Risk calculation methodology introduced during CPUC's Safety Model Assessment Proceedings (S-MAP) and Risk Assessment and Mitigation Phase (RAMP) proceeding. This methodology is established in D.18-12-014 but may be subject to change pursuant to R.20-07-013.
Mutual aid	Voluntary aid and assistance by the provision of services and facilities, including but not limited to electrical corporations, communication, and

⁴ Adapted from SFPE, 2010, "Substantiating a Fire Model for a Given Application," *Society of Fire Protection Engineers Engineering Guides*.

	transportation. Mutual aid is intended to provide adequate resources, facilities, and other support to electrical corporations whenever their own resources prove inadequate to cope with a given situation.
National Incident Management System (NIMS)	A systematic, proactive approach to guide all levels of government, nongovernment organizations, and the private sector to work together to prevent, protect against, mitigate, respond to, and recover from the effects of incidents. NIMS provides stakeholders across the whole community with shared vocabulary, systems, and processes to successfully deliver the capabilities described in the National Preparedness System. NIMS provides a consistent foundation for dealing with all incidents, ranging from daily occurrences to incidents requiring a coordinated federal response.
Near miss	Term previously used for an event with probability of ignition (now “Risk event”).
Objectives	Specific, measurable, achievable, realistic, and timely outcomes for the overall WMP strategy, or mitigation initiatives and activities that a utility can implement to satisfy the primary goals and subgoals of the WMP program.
Operations-based exercise	Type of exercise that validates plans, policies, agreements, and procedures; clarifies roles and responsibilities; and identifies resource gaps in an operational environment. Often includes drills, functional exercises (FEs), and full-scale exercises (FSEs).
Overall utility risk	The comprehensive risk due to both wildfire and PSPS incidents across a utility’s territory; the aggregate potential of adverse impacts to people, property, critical infrastructure, or other valued assets in society.
Overall utility risk, ignition risk	See Ignition Risk.
Overall utility risk, PSPS risk	See PSPS Risk.
Parameter uncertainty	The amount by which a calculated value might differ from the true value based on unknown input parameters. (Adapted from Society of Fire Protection Engineers [SFPE] guidance.)
Patrol inspection	In accordance with GO 165, a simple visual inspection of applicable utility equipment and structures designed to identify obvious structural problems and hazards. Patrol inspections may be carried out in the course of other company business.
Performance metric	A quantifiable measurement that is used by an electrical corporation to indicate the extent to which its WMP is driving performance outcomes.
Population density	Population density is calculated using the American Community Survey (ACS) one-year estimate for the corresponding year or, for years with no such ACS estimate available, the estimate for the immediately preceding year.

Preparedness	A continuous cycle of planning, organizing, training, equipping, exercising, evaluating, and taking corrective action in an effort to ensure effective coordination during incident response. Within the NIMS, preparedness focuses on planning, procedures and protocols, training and exercises, personnel qualification and certification, and equipment certification.
Priority essential services	Critical first responders, public safety partners, critical facilities and infrastructure, operators of telecommunications infrastructure, and water electrical corporations/agencies.
Property	Private and public property, buildings and structures, infrastructure, and other items of value that may be destroyed by wildfire, including both third-party property and utility assets.
Protective equipment and device settings.	The electrical corporation's procedures for adjusting the sensitivity of grid elements to reduce wildfire risk, other than automatic reclosers (such as circuit breakers, switches, etc.). For example, PG&E's "Enhanced Powerline Safety Settings" (EPSS).
PSPS consequence	The total anticipated adverse effects of a PSPS for a community. This considers the PSPS exposure potential and inherent PSPS vulnerabilities of communities at risk.
PSPS event	The period from notification of the first public safety partner of a planned public safety PSPS to re-energization of the final customer.
PSPS exposure potential	The potential physical, social, or economic impact of a PSPS event on people, property, critical infrastructure, livelihoods, health, local economies, and other high-value assets.
PSPS likelihood	The likelihood of a PSPS being required by a utility given a probabilistic set of environmental conditions.
PSPS risk	The total anticipated annualized impacts from a PSPS event at a specific location. This considers the likelihood a PSPS event will be required due to environmental conditions exceeding design conditions and the potential consequences – considering exposure potential and vulnerability – of the PSPS event for each affected community.
Public safety partners	First/emergency responders at the local, state, and federal levels; water, wastewater, and communication service providers; community choice aggregators (CCAs); affected publicly owned electrical corporations/electrical cooperatives; tribal governments; Energy Safety; the Commission; the California Office of Emergency Services; and CAL FIRE.
Red Flag Warning (RFW)	Level of wildfire risk from weather conditions, as declared by the NWS. For historical NWS data, refer to the Iowa State University archive of NWS watches/warnings. ⁵

⁵ <https://mesonet.agron.iastate.edu/request/gis/watchwarn.phtml>.

RFW OH circuit mile day	Sum of OH circuit miles of utility grid subject to RFW each day within a given time period, calculated as the number of OH circuit miles under RFW multiplied by the number of days those miles are under said RFW. For example, if 100 OH circuit miles are under RFW for one day, and 10 of those miles are under RFW for an additional day, then the total RFW OH circuit mile days would be 110.
Risk	A measure of the anticipated adverse effects from a hazard considering the consequences and frequency of the hazard occurring. ⁶
Risk component	A part of an electric corporation's risk analysis framework used to determine overall utility risk.
Risk evaluation	The process of comparing the results of a risk analysis with risk criteria to determine whether the risk and/or its magnitude is acceptable or tolerable. (ISO 31000:2009).
Risk event	An event with probability of ignition, such as wire down, contact with objects, line slap, event with evidence of heat generation, or other event that causes sparking or has the potential to cause ignition. The following all qualify as risk events: <ul style="list-style-type: none"> • Ignitions • Outages not caused by vegetation • Outages caused by vegetation • Wire-down events • Faults • Other events with potential to cause ignition
Risk management	Systematic application of management policies, procedures, and practices to the tasks of communication, consultation, establishment of context, and identification, analysis, evaluation, treatment, monitoring, and review of risk. (ISO 31000.)
Rule	Section of Public Utilities Code requiring a particular activity or establishing a particular threshold.
Rural region	In accordance with GO 165, area with a population of less than 1,000 persons per square mile, as determined by the U.S. Bureau of the Census. ⁷ For purposes of the WMP, "area" must be defined as a census tract.
Seminar	An informal discussion, designed to orient participants to new or updated plans, policies, or procedures (e.g., to review a new external communications standard operating procedure).
Sensitivity analysis	Process used to determine the relationships between the uncertainty in the independent variables ("input") used in an analysis and the

⁶ Adapted from D. Coppola, 2020, "Risk and Vulnerability," *Introduction to International Disaster Management*, 4th ed.

⁷ https://www.cpuc.ca.gov/gos/GO95/go_95_rule_18.htm

	uncertainty in the resultant dependent variables (“output”). (SFPE guidance.)
Slash	Branches or limbs less than four inches in diameter, and bark and split products debris left on the ground as a result of utility vegetation management. (This definition is consistent with California Public Resources Code section 4525.7)
Span	The space between adjacent supporting poles or structures on a circuit consisting of electric lines and equipment. “Span level” refers to asset-scale granularity.
Tabletop exercise (TTX)	A discussion-based exercise intended to stimulate discussion of various issues regarding a hypothetical situation. Tabletop exercises can be used to assess plans, policies, and procedures or to assess types of systems needed to guide the prevention of, response to, or recovery from a defined incident.
Target	A forward-looking, quantifiable measurement of work to which an electrical corporation commits to in its WMP. Electrical corporations will show progress toward completing targets in subsequent reports, including QDRs and WMP Updates.
Trees with strike potential	Trees that could either “fall in” to a power line or have branches detach and “fly in” to contact a power line in high-wind conditions.
Uncertainty	The amount by which an observed or calculated value might differ from the true value. For an observed value, the difference is “experimental uncertainty”; for a calculated value, it is “model” or “parameter uncertainty.” (Adapted from SFPE guidance.)
Urban region	In accordance with GO 165, area with a population of more than 1,000 persons per square mile, as determined by the U.S. Bureau of the Census. For purposes of the WMP, “area” must be defined as a census tract.
Utility-related ignition	See reportable ignition.
Validation	Process of determining the degree to which a calculation method accurately represents the real world from perspective of the intended uses of the calculation method without modifying input parameters based on observations in a specific scenario. (Adapted from ASTM E 1355.)
Vegetation Management (VM)	Trimming and removal of trees and other vegetation at risk of contact with electric equipment.
Verification	Process to ensure that a model is working as designed, that is, that the equations are being properly solved. Verification is essentially a check of the mathematics. (SFPE guidance.)
Vulnerability	The propensity of predisposition of a community to be adversely affected by a hazard, including the characteristics of a person, group, or

	service and their situation that influences their capacity to anticipate, cope with, resist, and recover from the adverse effects of a hazard.
Wildfire consequence	The total anticipated adverse effects from a wildfire on a community that is reached. this considers the wildfire hazard intensity, the wildfire exposure potential, and the inherent wildfire vulnerabilities of communities at risk.
Wildfire exposure potential	The potential physical, social, or economic impact of wildfire on people, property, critical infrastructure, livelihoods, health, environmental services, local economies, cultural/historical resources, and other high-value assets. This may include direct or indirect impacts, as well as short- and long-term impacts.
Wildfire intensity	The potential intensity of a wildfire at a specific location within the service territory given a probabilistic set of weather profiles, vegetation, and topography.
Wildfire mitigation strategy	Overview of the key mitigation initiatives at enterprise level and component level across the electrical corporation's service territory, including interim strategies where long-term mitigation initiatives have long implementation timelines. This includes a description of the enterprise-level monitoring and evaluation strategy for assessing overall effectiveness of the WMP.
Wildfire risk	See Ignition Risk.
Wildfire spread likelihood	The likelihood that a fire with a nearby but unknown ignition point will transition into a wildfire and will spread to a location in the service territory based on a probabilistic set of weather profiles, vegetation, and topography.
Wildland-urban interface (WUI)	The line, area, or zone where structures and other human development meet or intermingle with undeveloped wildland or vegetation fuels (National wildfire Coordinating Group). Enforcement agencies also designate the WUI as the area at significant risk from wildfires, established pursuant to Title 24, Part 2, Chapter 7A.
Wire down	Instance where an electric transmission or distribution conductor is broken and falls from its intended position to rest on the ground or a foreign object.
Work order	A prescription for asset or vegetation management activities resulting from asset or vegetation management inspection findings.
Workshop	Discussion that resembles a seminar but is employed to build specific products, such as a draft plan or policy (e.g., a multi-year training and exercise plan).

A.4 Definitions of Initiatives by Category

Category	Section #	Initiative	Definition
----------	-----------	------------	------------

Overview of the Service Territory	5.4.5	Environmental compliance and permitting	Development and implementation of process and procedures to ensure compliance with applicable environmental laws, regulations, and permitting related to the implementation of the WMP.
Risk Methodology and Assessment	6	Risk Methodology and Assessment	Development and use of tools and processes to assess the risk of wildfire and PSPS across an electrical corporation's service territory.
Wildfire Mitigation Strategy Development	7	Wildfire Mitigation Strategy Development	Development and use of processes for deciding on a portfolio of mitigation initiatives to achieve maximum feasible risk reduction and that meet the goals of the WMP.
Grid Design, Operations, and Maintenance	8.1.2.1	Covered conductor installation	Installation of covered or insulated conductors to replace standard bare or unprotected conductors (defined in accordance with GO 95 as supply conductors, including but not limited to lead wires, not enclosed in a grounded metal pole or not covered by: a "suitable protective covering" (in accordance with Rule 22.8), grounded metal conduit, or grounded metal sheath or shield). In accordance with GO 95, conductor is defined as a material suitable for: (1) carrying electric current, usually in the form of a wire, cable or bus bar, or (2) transmitting light in the case of fiber optics; insulated conductors as those which are surrounded by an insulating material (in accordance with Rule 21.6), the dielectric strength of which is sufficient to withstand the maximum difference of potential at normal operating voltages of the circuit without breakdown or puncture; and suitable protective covering as a covering of wood or other non-conductive material having the electrical insulating efficiency (12kV/in. dry) and impact strength (20ft.-lbs) of 1.5 inches of redwood or other material meeting the requirements of Rule 22.8-A, 22.8-B, 22.8-C, or 22.8-D,
Grid Design, Operations, and Maintenance	8.1.2.2	Undergrounding of electric lines and/or equipment	Actions taken to convert overhead electric lines and/or equipment to underground electric lines and/or equipment (i.e., located underground and in accordance with GO 128).

Grid Design, Operations, and Maintenance	8.1.2.3	Distribution pole replacements and reinforcements	Remediation, adjustments, or installations of new equipment to improve or replace existing distribution poles (i.e., those supporting lines under 65kV), including with equipment such as composite poles manufactured with materials reduce ignition probability by increasing pole lifespan and resilience against failure from object contact and other events.
Grid Design, Operations, and Maintenance	8.1.2.4	Transmission pole/tower replacements and reinforcements	Remediation, adjustments, or installations of new equipment to improve or replace existing transmission towers (e.g., structures such as lattice steel towers or tubular steel poles that support lines at or above 65kV).
Grid Design, Operations, and Maintenance	8.1.2.5	Traditional overhead hardening	Maintenance, repair, and replacement of capacitors, circuit breakers, cross-arms, transformers, fuses, and connectors (e.g., hot line clamps) with the intention of minimizing the risk of ignition.
Grid Design, Operations, and Maintenance	8.1.2.6	Emerging grid hardening technology installations and pilots	Development, deployment, and piloting of novel grid hardening technology.
Grid Design, Operations, and Maintenance	8.1.2.7	Microgrids	Development and deployment of microgrids that may reduce the risk of ignition, risk from PSPS, and wildfire consequence. "Microgrid" is defined by Public Utilities Code section 8370(d).
Grid Design, Operations, and Maintenance	8.1.2.8	Installation of system automation equipment	Installation of electric equipment that increases the ability of the electrical corporation to automate system operation and monitoring, including equipment that can be adjusted remotely such as automatic reclosers (switching devices designed to detect and interrupt momentary faults that can reclose automatically and detect if a fault remains, remaining open if so).
Grid Design, Operations, and Maintenance	8.1.2.9	Line removals (in HFTD)	Removal of overhead lines to minimize the risk of ignition due to the design, location, or configuration of electric equipment in HFTDs.
Grid Design, Operations, and Maintenance	8.1.2.10	Other grid topology improvements to minimize risk of ignitions	Actions taken to minimize the risk of ignition due to the design, location, or configuration of electric equipment in HFTDs not covered by another initiative.

Grid Design, Operations, and Maintenance	8.1.2.11	Other grid topology improvements to mitigate or reduce PSPS events	Actions to mitigate or reduce PSPS events in terms of geographic scope and number of customers affected not covered by another initiative.
Grid Design, Operations, and Maintenance	8.1.2.12	Other technologies and systems not listed above	Other grid design and system hardening actions which the electrical corporation takes to reduce its ignition and PSPS risk not otherwise covered by other initiatives in this section.
Grid Design, Operations, and Maintenance	8.1.3.1	Asset inspections	Inspections of overhead electric transmission lines, equipment, and right-of-way.
Grid Design, Operations, and Maintenance	8.1.4	Equipment maintenance and repair	Remediation, adjustments, or installations of new equipment to improve or replace existing connector equipment, such as hotline clamps.
Grid Design, Operations, and Maintenance	8.1.5	Asset management and inspection enterprise system(s)	Operation of and support for centralized asset management and inspection enterprise system(s) updated based upon inspection results and activities such as hardening, maintenance, and remedial work.
Grid Design, Operations, and Maintenance	8.1.6	Quality Assurance / Quality Control	Establishment and function of audit process to manage and confirm work completed by employees or contractors, including packaging QA/QC information for input to decision-making and related integrated workforce management processes.
Grid Design, Operations, and Maintenance	8.1.7	Open work orders	Actions taken to manage the electrical corporation's open work orders resulting from inspections that prescribe asset management activities.
Grid Design, Operations, and Maintenance	8.1.8.1	Equipment Settings to Reduce Wildfire Risk	The electrical corporation's procedures for adjusting the sensitivity of grid elements to reduce wildfire risk.
Grid Design, Operations, and Maintenance	8.1.8.2	Grid Response Procedures and Notifications	The electrical corporation's procedures it uses to respond to faults, ignitions, or other issues detected on its grid that may result in a wildfire.
Grid Design, Operations, and Maintenance	8.1.8.3	Personnel Work Procedures and Training in Conditions of Elevated Fire Risk	Work activity guidelines that designate what type of work can be performed during operating conditions of different levels of wildfire risk. Training for personnel on these guidelines and the procedures they prescribe, from normal operating

			procedures to increased mitigation measures to constraints on work performed.
Grid Design, Operations, and Maintenance	8.1.9	Workforce Planning	Programs to ensure that the electrical corporation has qualified asset personnel and to ensure that both employees and contractors tasked with asset management responsibilities are adequately trained to perform relevant work.
Vegetation Management and Inspection	8.2.2.1	Vegetation inspections	Inspections of vegetation around adjacent to electrical facilities and equipment that may be hazardous by growing, blowing, or falling into electrical facilities or equipment.
Vegetation Management and Inspection	8.2.3.1	Pole clearing	Plan and execution of vegetation removal around poles per Public Resources Code section 4292 and outside the requirements of Public Resources Code section 4292 (e.g., pole clearing performed outside of the State Responsibility Area).
Vegetation Management and Inspection	8.2.3.2	Wood and slash management	Actions taken to manage all downed wood and “slash” generated from vegetation management activities.
Vegetation Management and Inspection	8.2.3.3	Clearance	Actions taken after inspection to ensure that vegetation does not encroach upon electrical equipment and facilities, such as tree trimming.
Vegetation Management and Inspection	8.2.3.4	Fall-in mitigation	Actions taken to identify and remove or otherwise remediate trees that pose a high risk of failure or fracture that could potentially strike electrical equipment.
Vegetation Management and Inspection	8.2.3.5	Substation defensible space	Actions taken to reduce ignition probability and wildfire consequence due to contact with substation equipment.
Vegetation Management and Inspection	8.2.3.6	High-risk species	Actions taken to reduce the ignition probability and wildfire consequence attributable to high-risk species of vegetation.
Vegetation Management and Inspection	8.2.3.7	Fire-resilient rights-of-way	Actions taken to promote vegetation communities that are sustainable, fire-resilient, and compatible with the use of the land as an electrical corporation right-of-way.

Vegetation Management and Inspection	8.2.3.8	Emergency response vegetation management	Planning and execution of vegetation activities in response to emergency situations including weather conditions that indicate an elevated fire threat and post-wildfire service restoration.
Vegetation Management and Inspection	8.2.4	Vegetation management enterprise system	Operation of and support for centralized vegetation management and inspection enterprise system(s) updated based upon inspection results and activities such as hardening, maintenance, and remedial work.
Vegetation Management and Inspection	8.2.5	Quality Assurance / Quality Control	Establishment and function of audit process to manage and confirm work completed by employees or contractors, including packaging QA/QC information for input to decision-making and related integrated workforce management processes.
Vegetation Management and Inspection	8.2.6	Open work orders	Actions taken to manage the electrical corporation's open work orders resulting from inspections that prescribe vegetation management activities.
Vegetation Management and Inspection	8.2.7	Workforce planning	Programs to ensure that the electrical corporation has qualified vegetation management personnel and to ensure that both employees and contractors tasked with vegetation management responsibilities are adequately trained to perform relevant work.
Situational Awareness and Forecasting	8.3.2	Environmental monitoring systems	Development and deployment of systems which measure environmental characteristics, such as fuel moisture, air temperature, and velocity.
Situational Awareness and Forecasting	8.3.3	Grid monitoring systems	Development and deployment of systems that checks the operational conditions of electrical facilities and equipment and detects such things as faults, failures, and recloser operations.
Situational Awareness and Forecasting	8.3.4	Ignition detection systems	Development and deployment of systems which discover or identify the presence or existence of an ignition, such as cameras.
Situational Awareness and Forecasting	8.3.5	Weather forecasting	Development methodology for forecast of weather conditions relevant to electrical corporation operations, forecasting weather conditions and conducting analysis to incorporate into utility decision-making, learning and updates to reduce

			false positives and false negatives of forecast PSPS conditions.
Situational Awareness and Forecasting	8.3.6	Fire potential index	Calculation and application of a landscape scale index used as a proxy for assessing real-time risk of a wildfire under current and forecasted weather conditions.
Emergency Preparedness	8.4.2	Emergency preparedness plan	Development and integration of wildfire- and PSPS-specific emergency strategies, practices, policies, and procedures into the electrical corporation's overall emergency plan based on the minimum standards described in the GO 166.
Emergency Preparedness	8.4.3	External collaboration and coordination	Actions taken to coordinate wildfire and PSPS emergency preparedness with relevant public safety partners including the state, cities, counties, and tribes.
Emergency Preparedness	8.4.4	Public emergency communication strategy	Development and integration of a comprehensive communication strategy to inform essential customers and other stakeholder groups of wildfires, outages due to wildfires, and PSPS and service restoration, as required by Public Utilities Code section 768.6.
Emergency Preparedness	8.4.5	Preparedness and planning for service restoration	Development and integration of the electrical corporation's plan to restore service after an outage due to a wildfire or PSPS event.
Emergency Preparedness	8.4.6	Customer support in wildfire and PSPS emergencies.	Development and deployment of programs, systems, and protocols to support residential and non-residential customers in wildfire emergencies and PSPS events.
Community Outreach and Engagement	8.5.2	Public outreach and education awareness program	Development and deployment of public outreach and education awareness program(s) for wildfires; outages due to wildfires, PSPS events, and protective equipment and device settings; service restoration before, during, and after the incidents and vegetation management.
Community Outreach and Engagement	8.5.3	Engagement with access and functional needs populations	Actions taken understand, evaluate, design, and implement wildfire and PSPS risk mitigation strategies, policies, and procedures specific to access and functional needs customers.

Community Outreach and Engagement	8.5.4	Collaboration on local wildfire mitigation planning	Development and integration of plans, programs, and/or policies for collaborating with communities on local wildfire mitigation planning, such as wildfire safety elements in general plans, community wildfire protection plans, and local multi-hazard mitigation plans.
Community Outreach and Engagement	8.5.5	Best practice sharing with other utilities	Development and integration of an electrical corporation's policy for sharing best practices and collaborating with other electrical corporations on technical and programmatic aspects of its WMP program.

Appendix B. Supporting Documentation for Risk Methodology and Assessment

Note: as part of its 2023-2025 WMP, the electrical corporation is required to provide the “Summary Documentation” as defined by this appendix. For all other requirements in this appendix, the electrical corporation must be readily able to provide the defined documentation in response to a data request by Energy Safety or designated stakeholders.

The risk modeling and assessment in the main body of these Guidelines and electrical corporation’s WMP are focused on providing a streamlined overview of the electrical corporation risk framework and key findings from the assessment necessary to understand the wildfire mitigation strategy presented in Section 7.

The focus of this appendix is to provide additional information pertaining to the risk modeling approach used by the electrical corporation. This includes the following:

- Additional detail on model calculations supporting the calculation risk and risk components
- Additional detail on the calculation of risk and risk components
- More detailed presentation of the findings

The following sections establish the reporting requirements for the approaches used by the electrical corporation to calculate each risk and risk component. These have been synthesized and adapted from guidance documents on model quality assurance developed by many agencies, with a focus on guidance related to machine learning, artificial intelligence, and fire science and engineering. These guidance documents include those from the Institute of Electrical and Electronics Engineers (IEEE),⁸ the Society of Fire Protection Engineers (SFPE),⁹ the American Society for Testing and Materials (ASTM International),¹⁰ the U.S. Nuclear Regulatory Commission (NRC),¹¹ the Electric Power Research Institute (EPRI), the National Institute of Standards and Technology (NIST),¹² and the International Organization for Standardization (ISO).¹³

⁸ IEEE, 2022, “P2841/D2: Draft Framework and Process for Deep Learning Evaluation.”

⁹ SFPE, 2010, “Substantiating a Fire Model for a Given Application,” Engineering Guides.

¹⁰ ASTM, 2005, “ASTM E1472: Standard Guide for Documenting Computer Software for Fire Models,” ASTM International.

ASTM, 2005, “ASTM E1895: Standard Guide for Determining Uses and Limitations of Deterministic Fire Models,” ASTM International.

ASTM, 2005, “ASTM E1355: Standard Guide for Evaluating the Predictive Capability of Deterministic Fire Models,” ASTM International.

¹¹ U.S. NRC, EPRI, Jensen Hughes, NIST, 2016, “NUREG-1824: Verification and Validation of Selected Fire Models for Nuclear Power Plant Applications. Supplement 1.”

U.S. NRC, EPRI, Hughes Associates, Inc., NIST, California Polytechnic State University, Westinghouse Electric Company, University of Maryland, Science Applications International Corporation, ERIN Engineering, 2012, “NUREG-1934: Nuclear Power Plant Fire Modeling Application Guide.”

¹² NIST, 1981, “NBS SP 500-73: Computer Model Documentation Guide.”

¹³ ISO, 2013, “ISO/TR 16730:2013: Fire Safety Engineering: Assessment, Verification and Validation of Calculation Methods.”

ISO, 2021, “ISO/IEC TR 24027:2021: Information Technology: Artificial Intelligence (AI) – Bias in AI Systems and AI Aided Decision Making.”

ISO, 2021, “ISO/IEC TR 24029:2021: Artificial Intelligence (AI): Assessment of the Robustness of Neural Networks.”

B.1 Summary Documentation

The electrical corporation must provide high-level information on the calculation of each risk and risk component used in its risk analysis. The summary documentation must include each of the following:

- **High-level bow tie schematic** showing the inputs, outputs, and interaction between risk components in the format shown in Figure B-1. An example is provided below.
- **High-level calculation procedure schematic** in the format shown in Figure B-2. This schematic must show the logical flow from input data to outputs, including separate items for any intermediate calculations in models or sub-models and any input from subject matter experts.
- **High-level narrative describing the calculation procedure** in a concise executive summary. This narrative must include the following:
 - Purpose of the calculation/model
 - Assumptions and limitations
 - Description of the calculation procedure shown in the bow tie and high-level schematics
 - Description of how outputs will be characterized and presented (e.g., visualization) to decision makers
 - Concise description and timeline of planned changes to the calculation procedure over the triennial WMP cycle, including any key improvements from the Energy Safety Wildfire Risk Modeling Working Group and plans to align with the consensus Risk Modeling Requirements by January 1, 2024.

B.1.1 Overall Utility Risk (R1)

High-level bow tie schematic

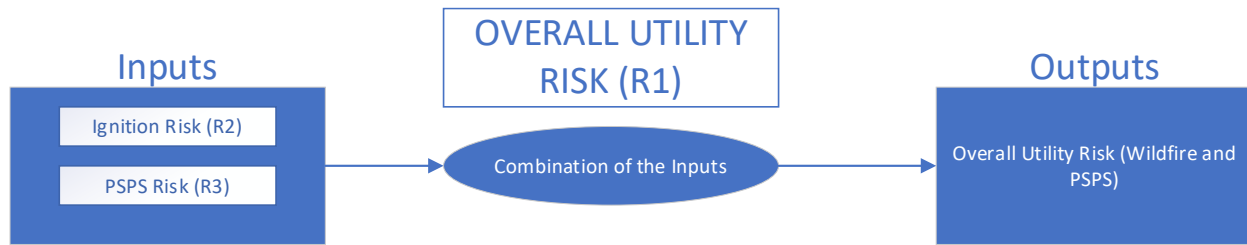

High-level calculation procedure schematic

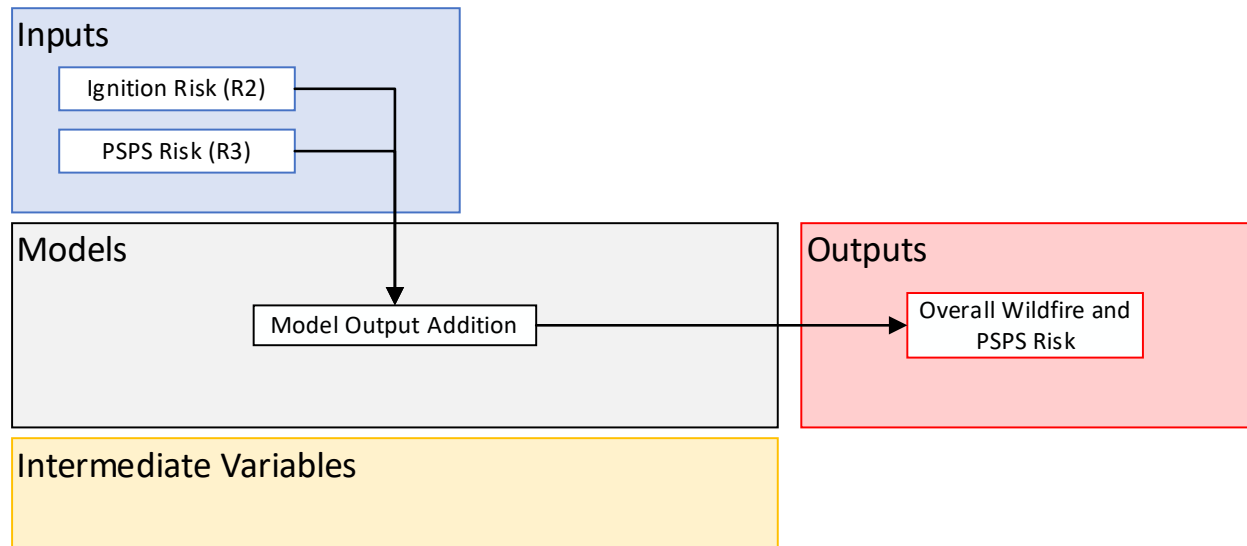

High-level narrative

- *Purpose of the calculation/model*

The Overall Utility Risk is a combination of Ignition Risk and PSPS Risk and is intended to provide the overall risk by circuit.

- *Assumptions and limitations*

The Overall Utility Risk is based on sub-component calculations such as ignition likelihood, wildfire consequence, etc. These calculations have built in assumptions and limitations that would carry through to the Overall Utility Risk calculation.

- *Description of the calculation procedure shown in the bow tie and high-level schematics*

Overall Utility Risk is the addition of Ignition Risk and PSPS Risk.

With the incorporation of the DIREXYON model, BVES will be able to calculate wildfire risk at a greater level of precision. The image below provides insight into the calculation that is used by the DIREXYON model to determine risk level at the circuit level. The DIREXYON model uses the data provided by Technosylva to calculate wildfire risk levels.

Fire risk and PSPS components of the model constitute the core of the model. The fire risk assessment integrates multiple factors, including asset related characteristics, equipment ignition, and vegetation contact. Simultaneously, the PSPS risk assessment considers wildfire

spread, hazard intensity, exposure potential and community vulnerability, providing a comprehensive overview of the network's resilience to both fire-related incidents and PSPS events. All the calculations are considering three weather trends, categorized as optimistic, normal, and pessimistic, based on Technosylva percentiles.

Asset Value Information for Period 2026

Characteristic [Utility Risk] calculation
End of Step

$$(0.5 \times 4.973) + (0.5 \times 14.27) = 9.621$$

$$(\text{123 Configurable FireRisk weight} \times \text{f}_{\text{FR}} \text{ Fire Risk}) + (\text{123 Configurable PSPS weight} \times \text{f}_{\text{PSPS}} \text{ PSPS - Risk}) = \text{f}_{\text{UR}} \text{ Utility Risk}$$

- *Description of how outputs will be characterized and presented (e.g., visualization) to decision makers*

BVES will be able to use Overall Utility Risk and its sub-components (Ignition Risk and PSPS Risk) and present them as values to the decision makers to aid in determination of mitigation initiative prioritization. In its most common form will be the use of output values but heat maps of the outputs may also be used.

Through the implementation of the DIREXYON model, that utilizes the Technosylva data, BVES can track the journey of each asset in each year based on each iteration, verifying the evolution of asset characteristics over time. This format enables validation of specific interventions triggered at precise moments, providing insights into their impacts. In addition to the individual asset level data, BVES can also view aggregated results within the DIREXYON risk models. The DIREXYON model presents simulation outcomes in an aggregated format, offering a holistic view of the overall network condition, required investments, and other key performance indicators at a collective level. This format facilitates a comprehensive evaluation of the network's overall health and performance. The integrated dashboard within the DIREXYON risk models offers BVES versatile views, tailored to cater to various roles such as executives, asset managers, and more. These views can seamlessly switch between detailed insights and holistic overviews, providing a customized experience for different stakeholders (please see the image below to see the Power BI views available to BVES through the DIREXYON risk models).

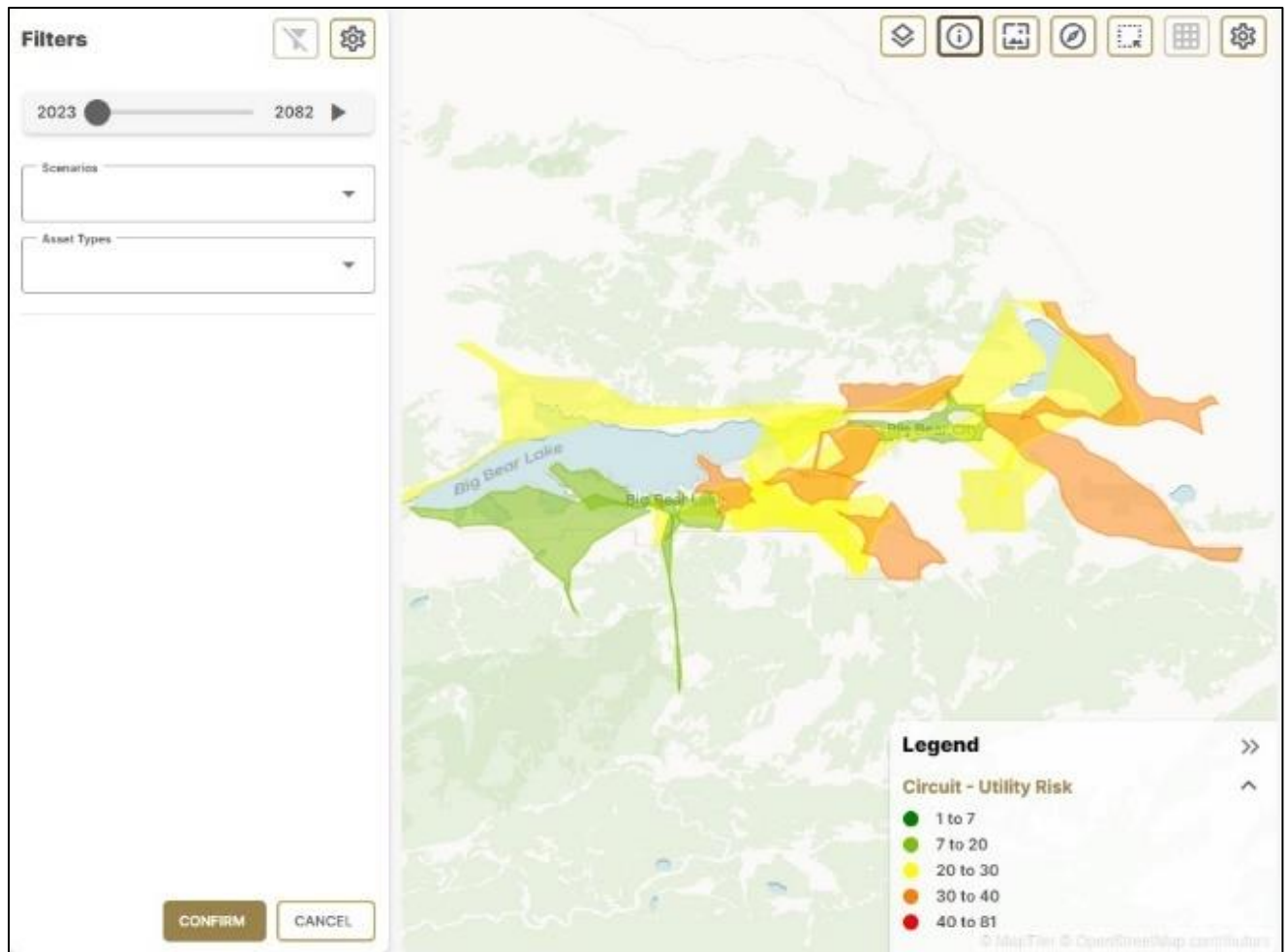

- *Concise description and timeline of planned changes to the calculation procedure over the triennial WMP cycle, including any key improvements from the Energy Safety Wildfire Risk Modeling Working Group and plans to align with the consensus Risk Modeling Requirements by January 1, 2024.*

BVES will review feedback from the working groups that it has been involved in including the Wildfire Risk Model Working Group and assess the need for improvements or changes. BVES plans to include more data and documentation for this risk model/component in future WMPs. Additionally, BVES plans to complete formal implementation and staff training on the WFA-E model to develop proficient model users and implement use of the WRRM and FPI in evaluating asset risks.

B.1.2 Ignition Risk (R2)

High-level bow tie schematic

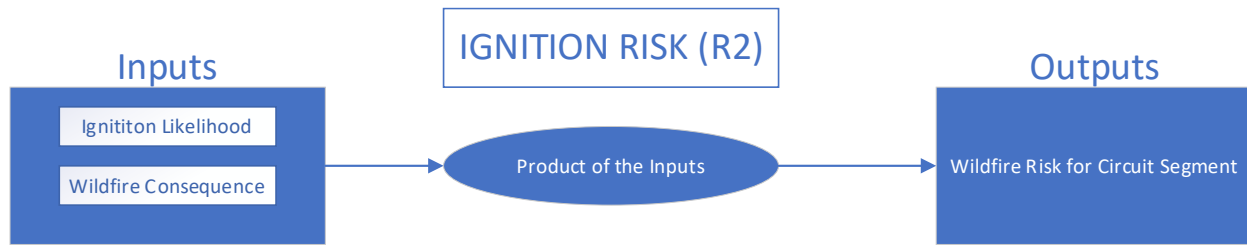

High-level calculation procedure schematic

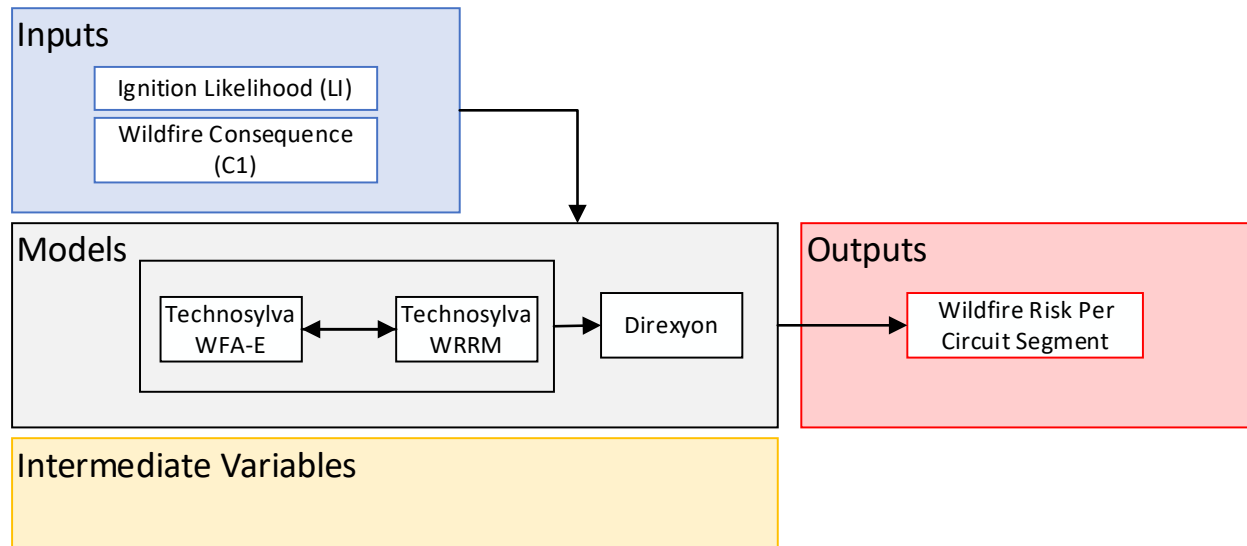

High-level narrative

- *Purpose of the calculation/model*

The ignition risk model by DIREXYON can also be understood as wildfire risk. It is designed to demonstrate the geospatial risk of ignition and the associated expected consequences of BVES's assets, equipment, and operations across the service territory.

- *Assumptions and limitations*

The risk calculation is based on assumptions and limitations from more granular sub-components (e.g., likelihood of ignition, wildfire consequences, etc.). This model assumes all like equipment, vegetation, and other factors behave in the same manner under the expected conditions. The models are limited by ability to fully adjust for combined mitigation affects. Additionally, areas that appear similarly on mapping and modeling often have great variation among sites. For example, the entry of the presence of Tier 3 HFTD designation may not reflect stretches of sparse vegetation or cleared ground under overhead equipment.

- *Description of the calculation procedure shown in the bow tie and high-level schematics*

Ignition or Wildfire Risk in the DIREXYON risk models is a multiplication of the Ignition Likelihood and Wildfire Consequence.

- *Description of how outputs will be characterized and presented (e.g., visualization) to decision makers*

Ignition or wildfire risk in the DIREXYON models can be broken down into its two components (ignition likelihood and wildfire consequence).

- *Concise description and timeline of planned changes to the calculation procedure over the triennial WMP cycle, including any key improvements from the Energy Safety Wildfire Risk Modeling Working Group and plans to align with the consensus Risk Modeling Requirements by January 1, 2024.*

BVES will review feedback from the working groups that it has been involved in including the Wildfire Risk Model Working Group and assess the need for improvements or changes. BVES plans to include more data and documentation for this risk model/component in future WMPs. Additionally, BVES plans to complete formal implementation and staff training on the WFA-E model to develop proficient model users and implement use of the WRRM in evaluating asset and wildfire risks.

B.1.3 PPS Risk (R3)

High-level bow tie schematic

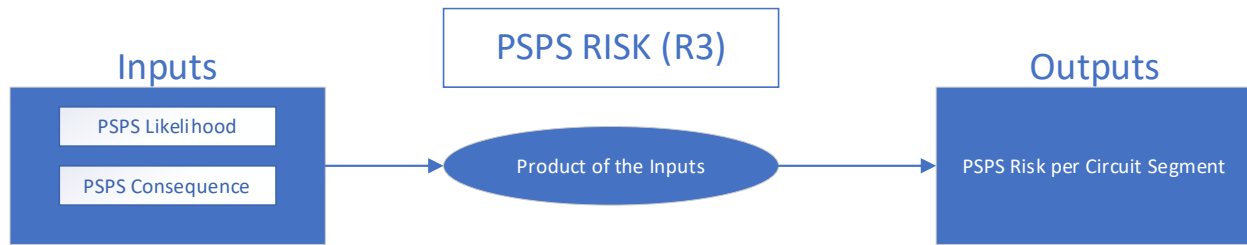

High-level calculation procedure schematic

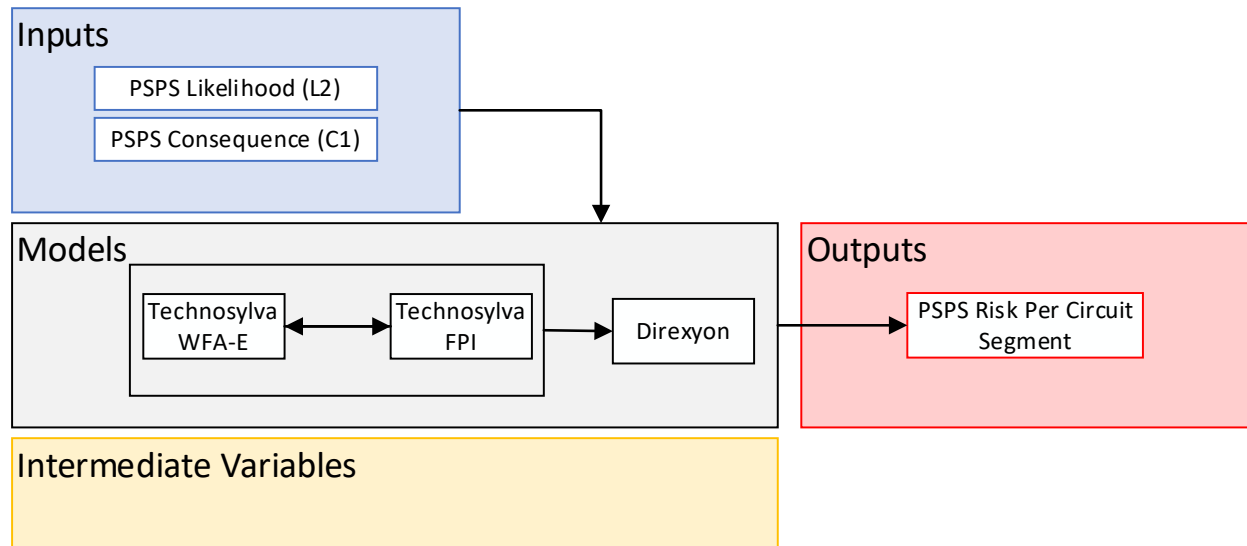

High-level narrative

- *Purpose of the calculation/model*

For the PPS risk, the DIREXYON model calculates the overall PPS risk, based on two inputs – PPS likelihood and PPS consequences.

- *Assumptions and limitations*

The risk calculation is based on assumptions and limitations from more granular sub-components – PPS likelihood and PPS consequences.

- *Description of the calculation procedure shown in the bow tie and high-level schematics*

In the DIREXYON model, PPS risk is a product of PPS likelihood and PPS consequences.

PPS risk assessment considers wildfire spread, hazard intensity, exposure potential and community vulnerability, providing a comprehensive overview of the network's resilience to PPS events

The DIREXYON risk model computes PPS risk at the circuit level, and the cumulative risk at circuit level contributes to the overall utility risk of the network. Similar to the fire risk, PPS risk comprises two components: probability of PPS and consequence of PPS:

Asset Value Information for Period 2026

Characteristic [PSPS - Risk] calculation
End of Step

$$3.114 \times 4.583 = 14.27$$

$$f_{\text{PSPS}}^{\text{Consequences}} \times f_{\text{PSPS}}^{\text{Probability Score}} = f_{\text{PSPS}}^{\text{Risk}}$$

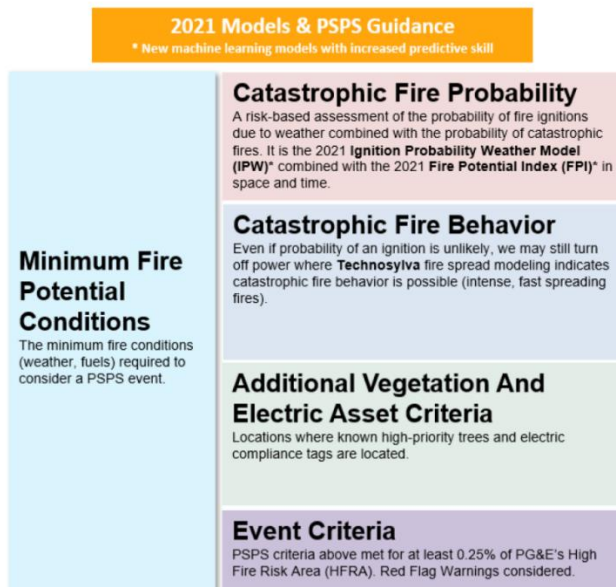

Fig. 1. High level overview of 2021 Distribution PSPS guidance

Fire behavior classes (1-5) are defined in segment level based on two components of Technosylva that is Fire Rate of Spread, and Flame length.

FIRE BEHAVIOR CLASS		ros (ch/h) 100 ch/h = 1.25 mi/h					
		VERY LOW 0 - 2	LOW 2 - 5	MODERATE 5 - 20	HIGH 20 - 50	VERY HIGH 50 - 150	EXTREME >150
fl (ft)	VERY LOW 0 - 1	1	1	1	1	2	3
	LOW 1 - 4	1	1	2	2	3	4
	MODERATE 4 - 8	1	2	2	3	4	5
	HIGH 8 - 12	1	2	3	3	4	5
	VERY HIGH 12 - 25	2	3	3	4	5	5
	EXTREME >25	3	3	4	4	5	5

- Description of how outputs will be characterized and presented (e.g., visualization) to decision makers

In the DIREXYON risk model, PSPS Risk components (likelihood and consequences) can be shown individually or shown as a single risk score per circuit, depending on the purpose of the presentation. There is the individual asset level debug screen, as well as the aggregated results BI dashboard. An example of the view is shown in the image below.

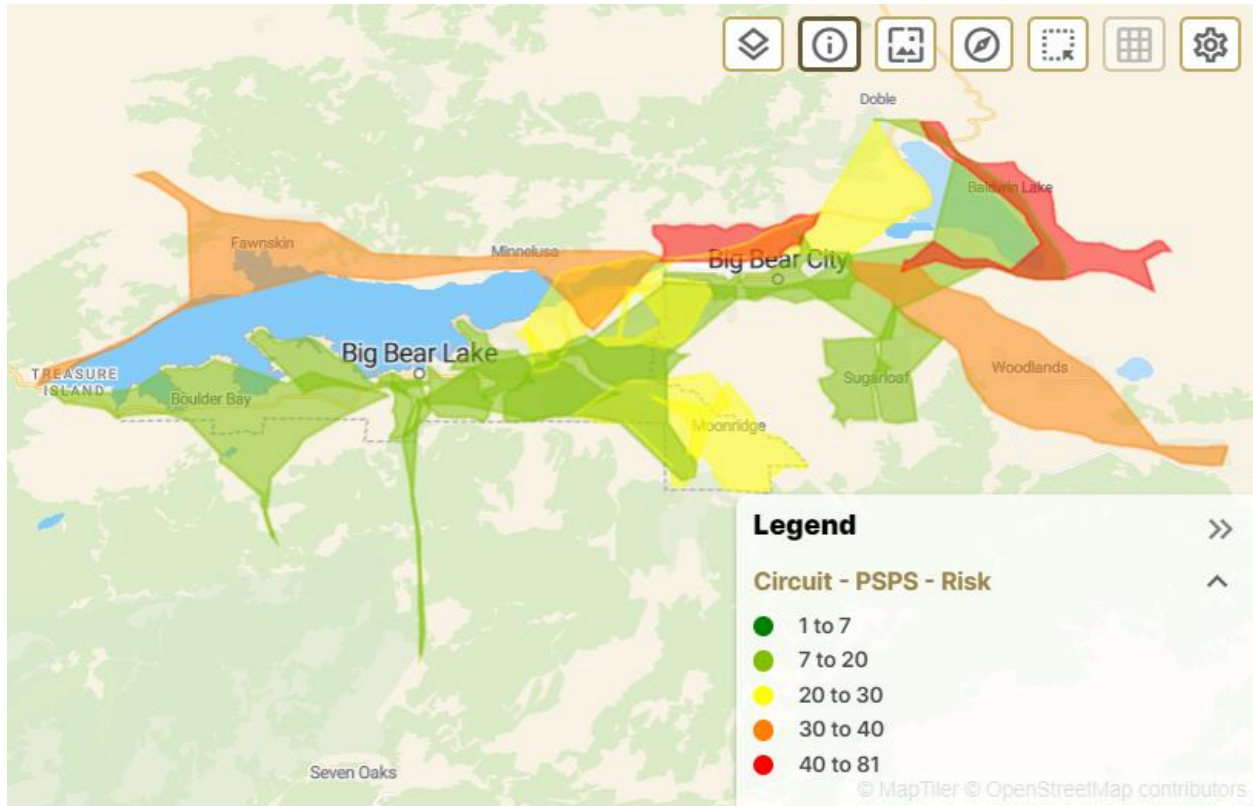

- *Concise description and timeline of planned changes to the calculation procedure over the triennial WMP cycle, including any key improvements from the Energy Safety Wildfire Risk Modeling Working Group and plans to align with the consensus Risk Modeling Requirements by January 1, 2024.*

BVES will review feedback from the working groups that it has been involved in including the Wildfire Risk Model Working Group and assess the need for improvements or changes. BVES plans to include more data and documentation for this risk model/component in future WMPs. Additionally, BVES plans to complete formal implementation and staff training on the WFA-E model to develop proficient model users and implement use of the WRRM and FPI in evaluating PSPS risks.

B.1.4 Ignition Likelihood (LI)

High-level bow tie schematic

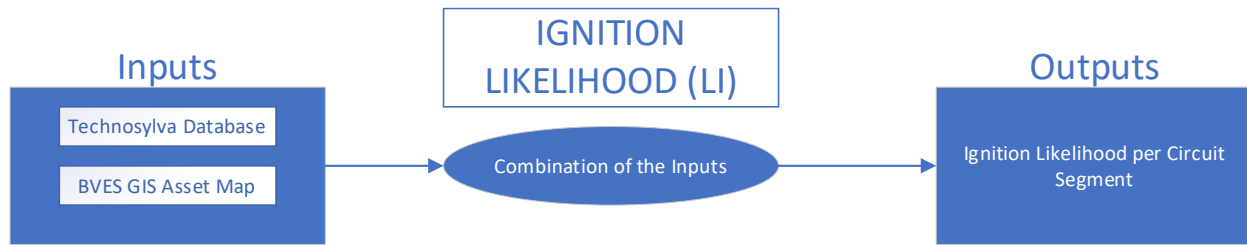

High-level calculation procedure schematic

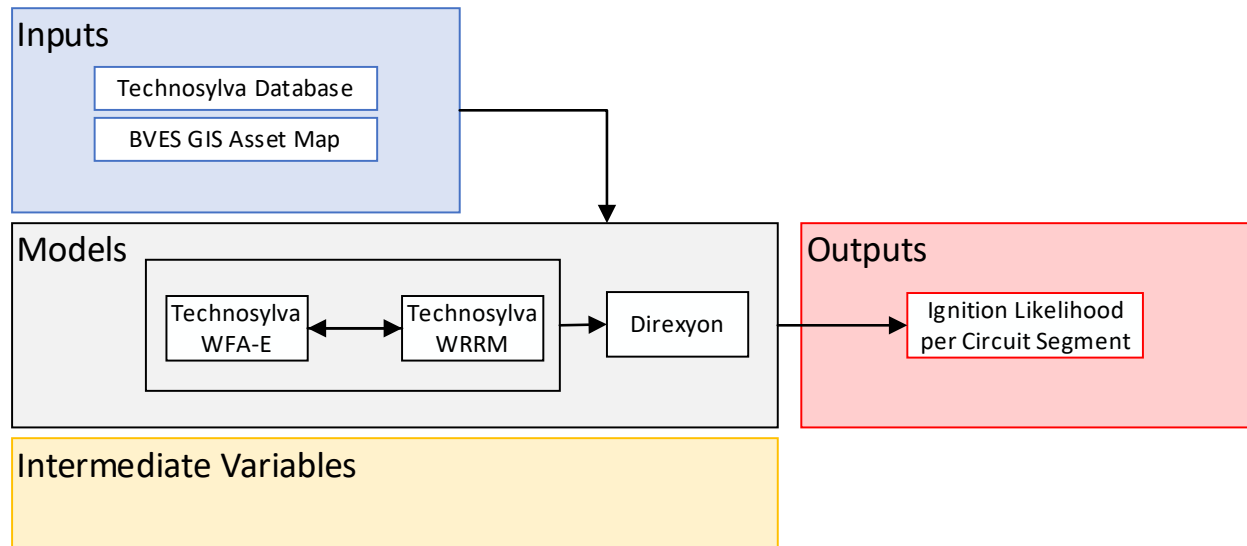

High-level narrative

- *Purpose of the calculation/model*

In the DIREXYON model, ignition likelihood is synonymous with probability of ignition, which is based on inputs of the risk likelihood models (e.g., Equipment Likelihood of Ignition, Contact from Vegetation Likelihood, and Contact from Object Likelihood).

- *Assumptions and limitations*

The probability of ignition is a probabilistic assessment of each asset's pre-mitigated ignition likelihood (wildfire likelihood) prior to mitigation deployment.

- *Description of the calculation procedure shown in the bow tie and high-level schematics*

LI is the sum of the ignition component probabilities at that location (i.e., equipment ignition likelihood, contact from vegetation ignition likelihood, and contact by object ignition likelihood).

- *Description of how outputs will be characterized and presented (e.g., visualization) to decision makers*

Ignition likelihood can be broken down into its components (i.e., equipment ignition likelihood, contact from vegetation ignition likelihood, and contact by object ignition likelihood) and can be further broken down into individual contact types and equipment failures.

- *Concise description and timeline of planned changes to the calculation procedure over the triennial WMP cycle, including any key improvements from the Energy Safety Wildfire Risk Modeling Working Group and plans to align with the consensus Risk Modeling Requirements by January 1, 2024.*

BVES will review feedback from the working groups that it has been involved in including the Wildfire Risk Model Working Group and assess the need for improvements or changes. BVES plans to include more data and documentation from Technosylva for this risk model/component in future WMPs. Additionally, BVES plans to complete formal implementation and staff training on the WFA-E model to develop proficient model users and implement use of the WRRM and FPI in evaluating asset, fire, and PSPS risks.

B.1.5 Wildfire Likelihood (L1)

High-level bow tie schematic

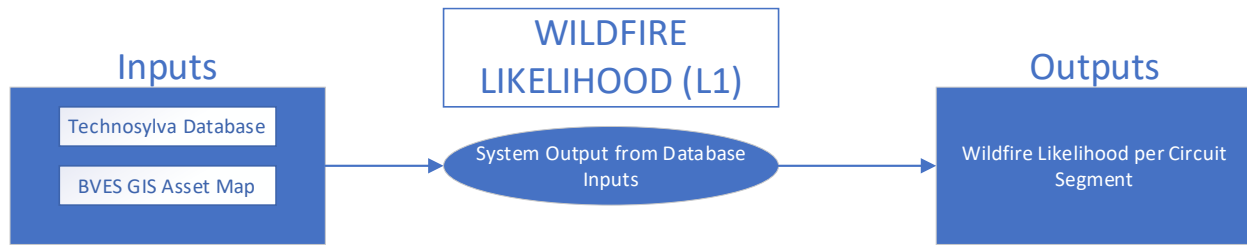

High-level calculation procedure schematic

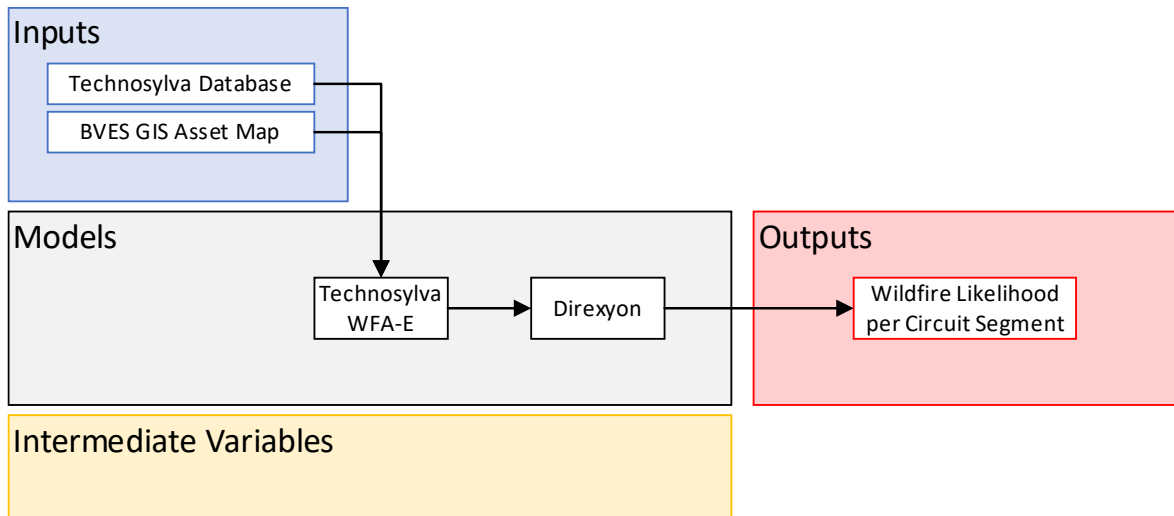

High-level narrative

- *Purpose of the calculation/model*

Understanding the wildfire likelihood per circuit segment.

- *Assumptions and limitations*
- *Description of the calculation procedure shown in the bow tie and high-level schematics*

BVES has enhanced their risk modeling efforts through implementation of Technosylva and DIREXYON. The DIREXYON model utilized Technosylva data to develop a holistic risk overview that encompasses wildfire likelihood. The probability of fire gauges the likelihood of fire ignition specific to each asset type. It is calculated as the product of the Technosylva-calculated Probability of Ignition (POI) and XY condition modifiers (CMs). The image below represents the probability of fire risk calculations along with overall CM calculations for poles.

Asset Value Information for Period 2026

Characteristic [Probability of Fire - Scaled] calculation
End of Step

$$\min(0.4 \times 0.625, 1) = 0.25$$

$$\min(f_{P_0} \text{ Probability of Fire} \times f_{X_3} \text{ CM - Final}, 1) = f_{X_3} \text{ Probability of Fire - Scaled}$$

Characteristic [CM - Final] calculation
End of Step

$$1 \times 1.25 \times 0.5 \times 1 = 0.625$$

$$f_{X_1} \text{ CM - Firewrap} \times f_{X_2} \text{ CM - Vegetation} \times f_{X_3} \text{ CM - Equipment} \times f_{X_4} \text{ CM - Pole Material} = f_{X_3} \text{ CM - Final}$$

XY Condition modifiers

Condition modifiers in the model are to show the impact of asset characteristics and specific interventions on the calculated probability of fire by Technosylva. For example, if a bare conductor is replaced with a covered conductor, what is the impact on probability of fire? Accordingly, the following condition modifiers are defined in individual asset levels as detailed below:

Conductor Condition Modifiers

Conductor Material:

This modifier assesses the effect of conductor material (such as copper or other materials) on overall fire risk. Notably, copper conductors are associated with a higher probability of igniting a fire. Consequently, substituting copper conductors with non-copper materials reduces the fire risk by 50%, while the reverse—replacing non-copper materials with copper—increases the risk by 50%. Please note that, the 50% values are a placeholder in the model that needs to be adjusted with more insights from subject matter experts.

This nuanced approach enables users to quantify the potential risk mitigation or escalation associated with changes in conductor types.

Conductor Type:

This condition modifier delineates the effects of various conductor types, specifically comparing covered and uncovered variants. Transitioning from uncovered to covered conductors notably diminishes the associated fire risk. Consequently, implementing coverings on previously non-covered conductors results in a 50% reduction in fire risk. Please note that this value is taken from available literature and serves as a placeholder in the model, and with further insight from BVES and access to historical events correlated with conductor types, adjustments can be made for a more accurate assessment.

Accordingly, the conductor probability of fire is the product of Technosylva-calculated Probability of Ignition (POI), CM – Conductor Material, and CM – Conductor type.

These two condition modifiers specifically address the equipment ignition likelihood within the identified gap.

Transformer Condition Modifiers

Transformer failure:

This condition modifier encapsulates the impact of transformer degradation on the probability of fire. Transformer degradation is characterized by age and different Kva ratings. Additionally, an asset-specific accidental failure probability of 0.002 is incorporated into the risk/failure model. In the absence of historical failure data from BVES, the accidental failure probability of 0.002 serves as a placeholder, derived from the findings of a study by S. Tenbohlen (2011)(5).

The current condition modifier for transformers is derived from a Weibull failure curve, considering transformer age, KVA, and accidental failure probability. Specifically, for a brand-new transformer or pole, the condition modifier (CM) is 1. As transformers age, the CM exponentially increases from 1 to 2.

The 0.2% probability of accidental failure for transformers addresses the Contact by Object Ignition Likelihood within the identified gap.

This data provides valuable insights into the potential risks associated with transformer conditions.

Pole Condition Modifiers

Fire Wrap:

This condition modifier assesses the impact of installing fire wraps on wooden poles as a risk mitigation measure. Accordingly, the installation of fire wraps on wooden poles initially without them can result in a 10% reduction in probability of fire.

Pole material:

This condition modifier evaluates the impact of pole material on fire risk, with wooden poles generally posing a higher risk of ignition compared to metal poles. The modifier facilitates an understanding of the potential risk reduction by replacing wooden poles with steel in the network. Currently, replacing wood material with non-wood reduces the fire risk by 10%.

Vegetation

Vegetation is incorporated into the model as an integral part of the pole asset type. The likelihood of fire caused by vegetation varies based on the state of trees—whether they have fallen, grown, or the overall tree density (Fall in, Grow in, and Tree density). Markov chains are employed to model the probability of transitioning from the best zone (4) to the worst zone (1), dependent on the number of years since the last vegetation inspection.

For all three mentioned metrics, a zone value is predicted annually based on the elapsed time since the last vegetation management intervention. Consequently, with an increasing number of years since the last vegetation management intervention, the probability of transitioning from the best zones to the worst zones rises. In simpler terms, without regular inspections, there is a

heightened risk of the vegetation around the equipment growing unchecked, thereby increasing the likelihood of fires.

The final CM vegetation is the product of three Condition Modifiers (CMs) CM – Fall in, CM – Grow in, and CM – Density. For each metric if the tree's state remains unaltered compared to the initial state, the related CM is set at 1. However, if it deteriorates, the CM adjusts from 25% to 100% (based on the initial and current zones), and if it improves, it decreases by 25% to 75%. This meticulous approach ensures a nuanced representation of the impact of vegetation on fire risk within the model. Please note that this value serves as a placeholder, and with further insight from BVES and access to historical fall-in and grow-in data, adjustments can be made for a more accurate assessment. Each of the identified metrics is briefly explained below:

Grow-In

This metric relies on a shape file provided by BVES, representing the likelihood of tree branches growing into power lines and causing fires. The clear level in the data interprets the Grow-in values.

Fall-In

Data for this metric is sourced from a shape file provided by BVES. Calculated based on tree height and the distance of the tree to the pole, Fall-In zones are defined depending on the minimum height required for a tree to impact an asset. This determination considers the pole height, tree distance to pole, and the specified minimum heights.

Density

Data for this metric comes from the VegManagementDataPartner, with no specific aggregation performed on the dataset. It represents the density of vegetation around the assets.

These condition modifiers address the contact from vegetation ignition likelihood within the identified gap.

Equipment

A pole linked to high-risk equipment, such as a transformer and/or conductor, inherently carries an elevated fire risk. This condition modifier encapsulates the cumulative effect of calculated Condition Modifiers (CMs) for transformers and conductors, providing a comprehensive assessment of the associated risk for a given pole.

- *Description of how outputs will be characterized and presented (e.g., visualization) to decision makers.*
- *Concise description and timeline of planned changes to the calculation procedure over the triennial WMP cycle, including any key improvements from the Energy Safety Wildfire Risk Modeling Working Group and plans to align with the consensus Risk Modeling Requirements by January 1, 2024.*

BVES will review feedback from the working groups that it has been involved in including the Wildfire Risk Model Working Group and assess the need for improvements or changes. BVES plans to include more data and documentation for this risk model/component in future WMPs. Additionally, BVES plans to complete formal implementation and staff training on the WFA-E

model to develop proficient model users and implement use of the WRRM and FPI in evaluating wildfire risks.

B.1.6 Wildfire Consequence (C1)

High-level bow tie schematic

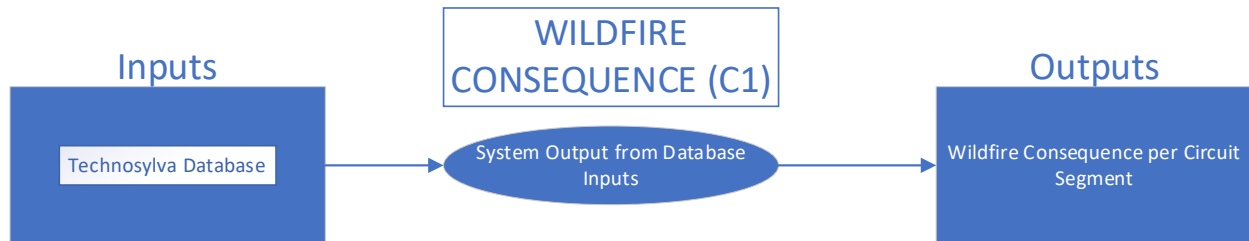

High-level calculation procedure schematic

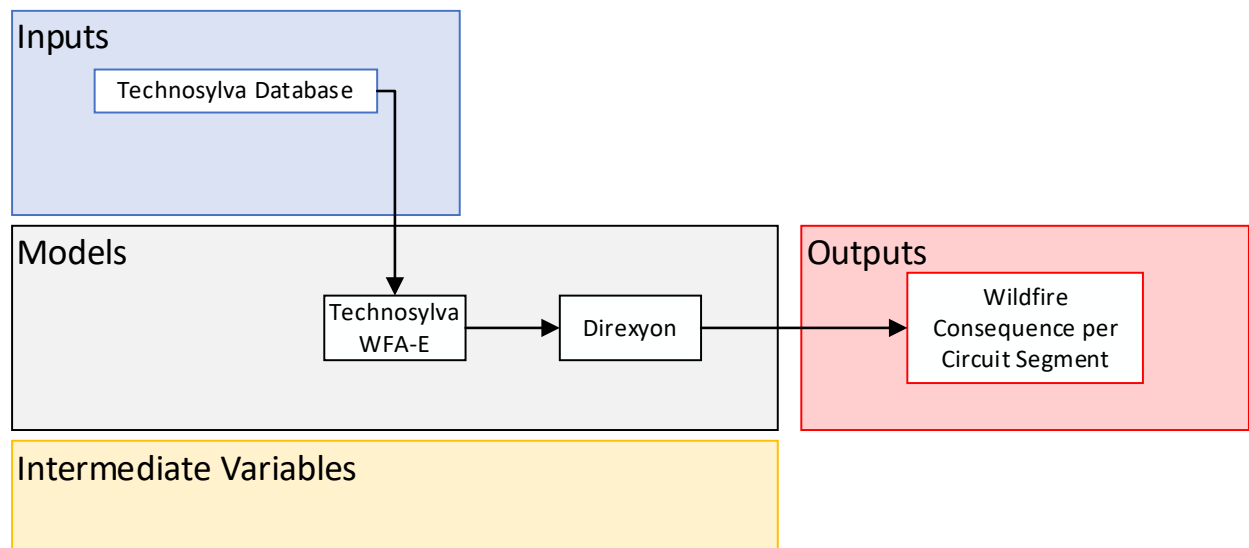

High-level narrative

- *Purpose of the calculation/model*

The purpose of the model is to assess wildfire consequence based on match-drop simulations for utility asset locations.

- *Assumptions and limitations*
- *Description of the calculation procedure shown in the bow tie and high-level schematics.*

Consequence of fire values delineate the impact of fire on population, buildings destroyed, and acres burned. These values, determined by Technosylva at the segment level, remain constant across all asset types within the same segment. The mentioned consequences are grouped into safety, environmental, and finance impact with user-defined weights that can be easily adjusted upon running the simulation.

- *Description of how outputs will be characterized and presented (e.g., visualization) to decision makers*

The attached screenshot represents the calculated consequence of fire in segment level based Technosylva data and configurable weights. In the DIREXYON model, the location of area that can be highly affected by fire can be visualized on a map as bellow:

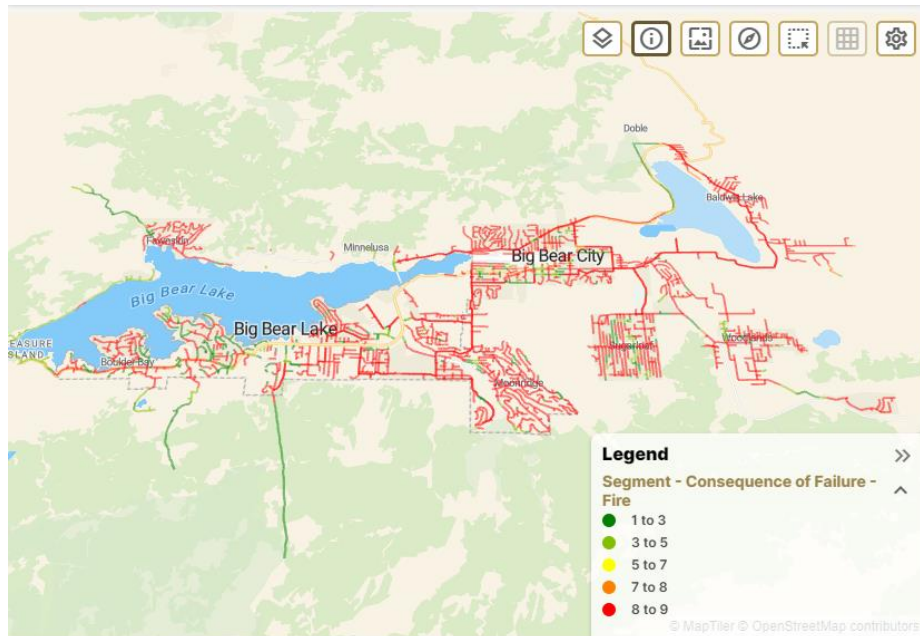

- *Concise description and timeline of planned changes to the calculation procedure over the triennial WMP cycle, including any key improvements from the Energy Safety Wildfire Risk Modeling Working Group and plans to align with the consensus Risk Modeling Requirements by January 1, 2024.*

BVES will review feedback from the working groups that it has been involved in including the Wildfire Risk Model Working Group and assess the need for improvements or changes. BVES plans to include more data and documentation for this risk model/component in future WMPs. Additionally, BVES plans to complete formal implementation and staff training on the WFA-E model to develop proficient model users and implement use of the WRRM and FPI in evaluating wildfire risks and consequences.

B.1.7 PSPS Likelihood (L2)

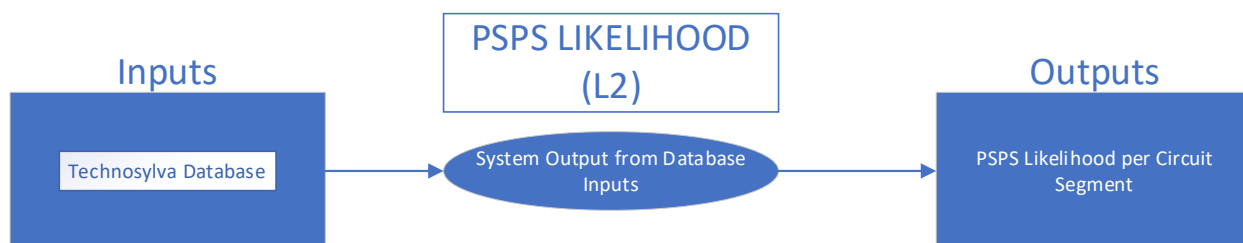

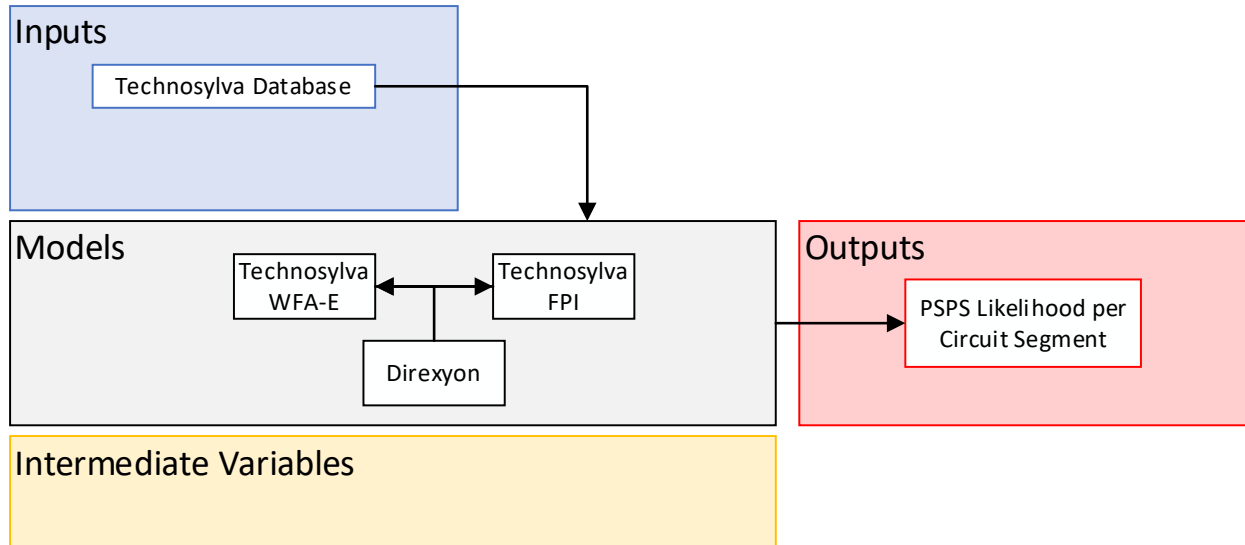

High-level narrative

- *Purpose of the calculation/model*

The purpose of the calculation is to determine the PPS likelihood for a given circuit segment given data inputs.

- *Assumptions and limitations*
- *Description of the calculation procedure shown in the bow tie and high-level schematics*

In the absence of FPI data from Technosylva and based on the available literature by PG&E (6), PPS probability is defined based on calculated fire probabilities in individual asset levels (POI*CMs) and fire behavior index.

Asset Value Information for Period 2026

Characteristic [PPS - Probability] calculation
End of Step

$$\min(0.2239 \times 2, 1) = 0.4478$$

$$\min(\text{POI} \times \text{Fire Behaviour Index - Numerical}, 1) = \text{PPS - Probability}$$

- *Description of how outputs will be characterized and presented (e.g., visualization) to decision makers*
- *Concise description and timeline of planned changes to the calculation procedure over the triennial WMP cycle, including any key improvements from the Energy Safety Wildfire Risk Modeling Working Group and plans to align with the consensus Risk Modeling Requirements by January 1, 2024.*

BVES will review feedback from the working groups that it has been involved in including the Wildfire Risk Model Working Group and assess the need for improvements or changes. BVES plans to include more data and documentation for this risk model/component in future WMPs.

B.1.8 PSPS Consequence (C2)

High-level bow tie schematic

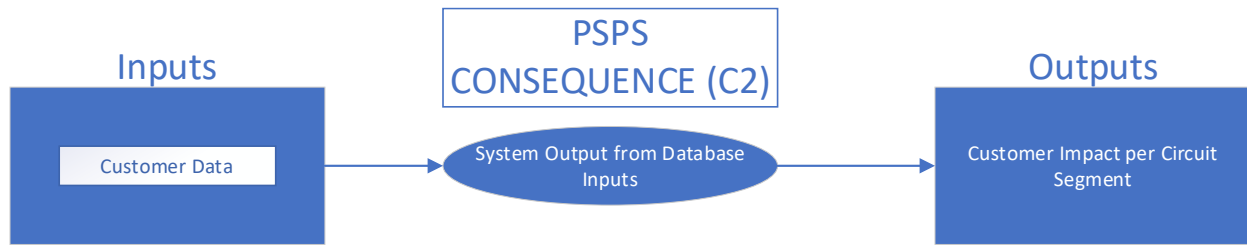

High-level calculation procedure schematic

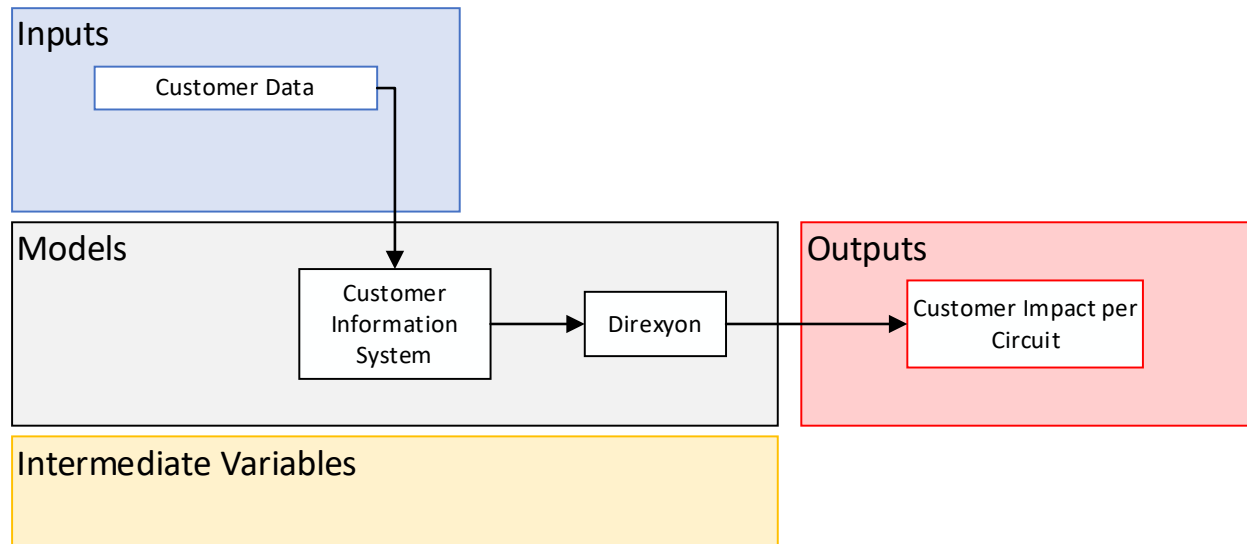

High-level narrative

- *Purpose of the calculation/model*

The purpose of the calculation is to determine the projected customer impact for a given circuit segment in the form of customer per circuit.

- *Assumptions and limitations*
- *Description of the calculation procedure shown in the bow tie and high-level schematics*

PSPS Consequence values outline the repercussions of Public Safety Power Shutoffs (PSPS) on distinct categories, including vulnerable individuals (AFN customers), the general population, and affected buildings. These consequences are categorized into PSPS vulnerability and PSPS exposure, with customizable user-defined weights that can be easily adjusted upon running the simulation.

Asset Value Information for Period 2026

Characteristic [PSPS - Consequences] calculation
End of Step

$$(0.5 \times 1) + (0.5 \times 5.227) = 3.114$$

$$\left(\text{123 Configurable PSPS Vulnerability Consequence Weight} \times f_{X_i} \text{ PSPS - Vulnerability} \right) + \left(\text{123 Configurable PSPS Exposure Consequence Weight} \times f_{X_i} \text{ PSPS - Exposure} \right) = f_{X_i} \text{ PSPS - Consequences}$$

Characteristic [PSPS - Exposure] calculation
End of Step

$$(0.25 \times 5.863) + (0.75 \times 5.016) = 5.227$$

$$\left(\text{123 Building Destroyed Impact Configurable Weight (PSPS)} \times \text{Building Destroyed Impact - Score} \right) + \left(\text{123 Population Impact Configurable Weight (PSPS)} \times \text{Population Impact - Score} \right) = f_{X_i} \text{ PSPS - Exposure}$$

- Description of how outputs will be characterized and presented (e.g., visualization) to decision makers

Highly affected area by PSPS events can be visualized on a map:

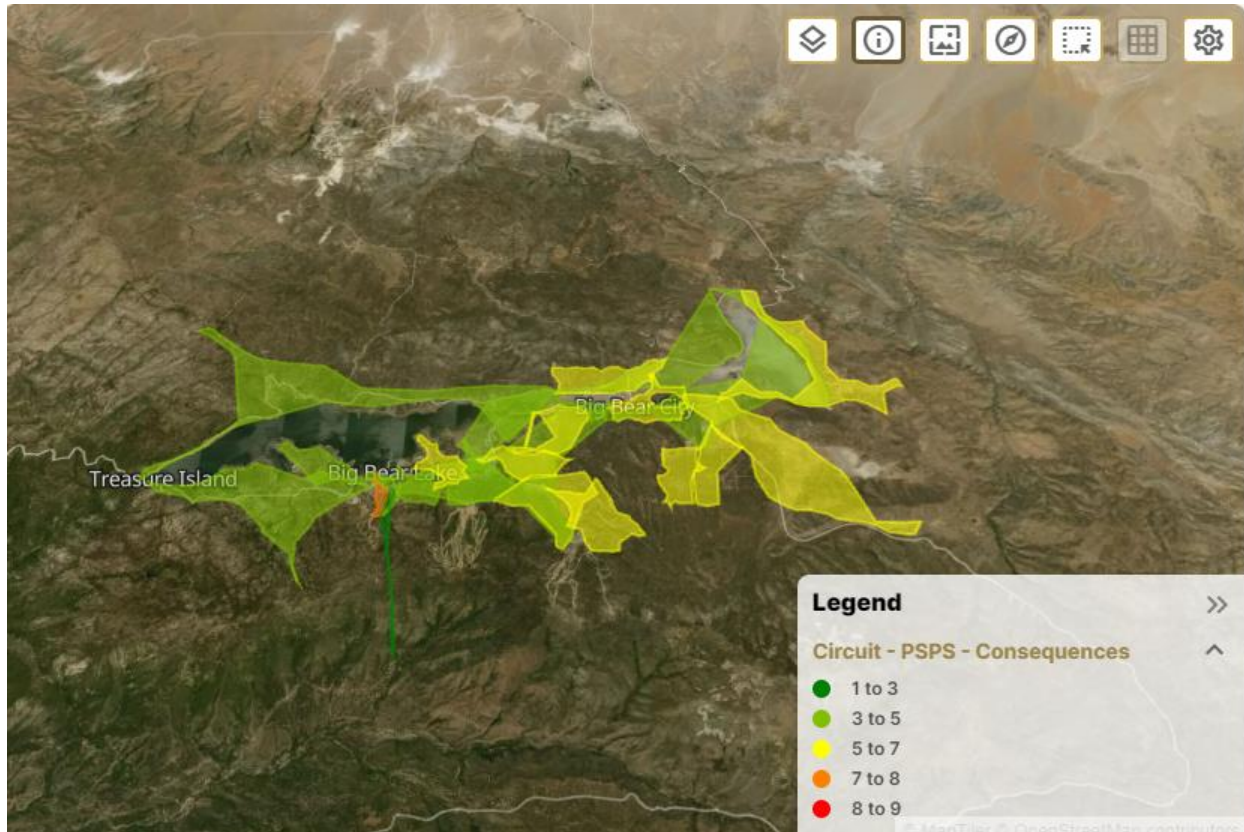

- *Concise description and timeline of planned changes to the calculation procedure over the triennial WMP cycle, including any key improvements from the Energy Safety Wildfire Risk Modeling Working Group and plans to align with the consensus Risk Modeling Requirements by January 1, 2024.*

BVES will review feedback from the working groups that it has been involved in including the Wildfire Risk Model Working Group and assess the need for improvements or changes. BVES plans to include more data and documentation for this risk model/component in future WMPs. Additionally, BVES plans to complete formal implementation and staff training on the WFA-E model to develop proficient model users and implement use of the WRRM in evaluating PSPS risks and consequences.

B.1.9 Equipment Ignition Likelihood (LE)

High-level bow tie schematic

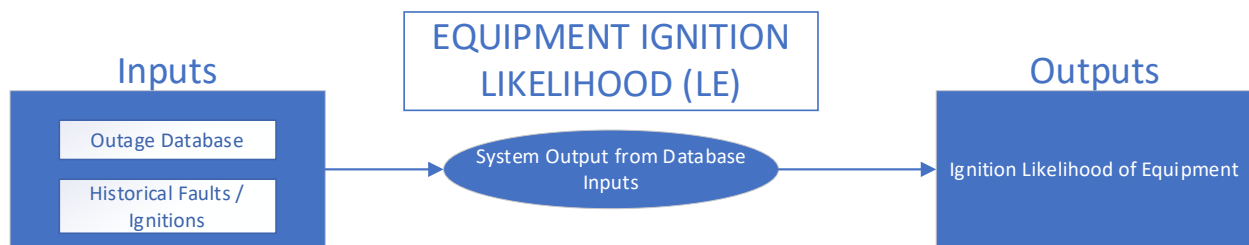

High-level calculation procedure schematic

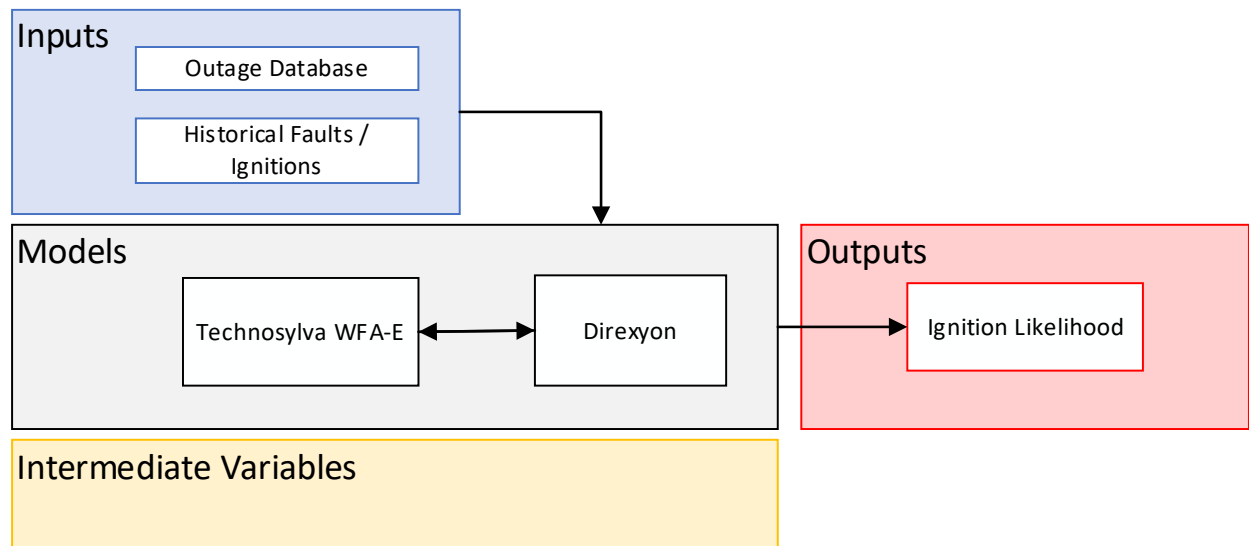

High-level narrative

BVES collaborated with DIREXYON to introduce a new risk modeling tool to BVES's wildfire risk mitigation practices. The model is completed; however, as of the date of this filing the model is not fully implemented. BVES staff are completing training by DIREXYON on the model and BVES will need to set certain modifier values and risk weightings before the model is fully operational. BVES expects the model to be in full operation by Q4 2024. Updates to Appendix B including the addition of the DIREXYON's White Paper have been made as part of BVES Risk Modeling updates. The following paragraphs describe the DIREXYON risk model.

- *Purpose of the calculation/model*

The purpose of the model is to identify the impact of asset/equipment characteristic in probability of fire. For example, calculating probability of fire for a bare conductor vs cover conductor and showing the risk reduction by covering conductor. According to the literature, there is a higher chance of copper conductor to catch on fire and cause a wildfire.

- *Assumptions and limitations*
- *Description of the calculation procedure shown in the bow tie and high-level schematics*

BVES has enhanced their risk modelling efforts through the incorporation of DIREXYON. DIREXYON builds asset models and has defined condition modifiers to identify the impacts of wildfire that is caused by equipment ignition. For the current phase of the project, conductor type and material are used to estimate the equipment ignition likelihood as bellow:

Conductor Material

This modifier assesses the effect of conductor material (such as copper or other materials) on overall fire risk. Notably, copper conductors are associated with a higher probability of igniting a fire. Consequently, substituting copper conductors with non-copper materials reduces the fire risk by 50%, while the reverse—replacing non-copper materials with copper—increases the risk by 50%. This nuanced approach enables users to quantify the potential risk mitigation or escalation associated with changes in conductor types.

Conductor Type

This condition modifier delineates the effects of various conductor types, specifically comparing covered and uncovered variants. Transitioning from uncovered to covered conductors notably diminishes the associated fire risk. Consequently, implementing coverings on previously non-covered conductors results in a 50% reduction in fire risk.

Accordingly, the conductor probability of fire is the product of Technosylva-calculated Probability of Ignition (POI), CM – Conductor Material, and CM – Conductor type.

- *Description of how outputs will be characterized and presented (e.g., visualization) to decision makers*
- *Concise description and timeline of planned changes to the calculation procedure over the triennial WMP cycle, including any key improvements from the Energy Safety Wildfire Risk Modeling Working Group and plans to align with the consensus Risk Modeling Requirements by January 1, 2024.*

BVES will review feedback from the working groups that it has been involved in including the Wildfire Risk Model Working Group and assess the need for improvements or changes. BVES plans to include more data and documentation for this risk model/component in future WMPs. Additionally, BVES plans to complete formal implementation and staff training on the WFA-E model to develop proficient model users and implement use of the WRRM and FPI in evaluating wildfire risks including equipment ignition likelihood.

B.1.10 Contact with Vegetation Ignition Likelihood (LV)

High-level bow tie schematic

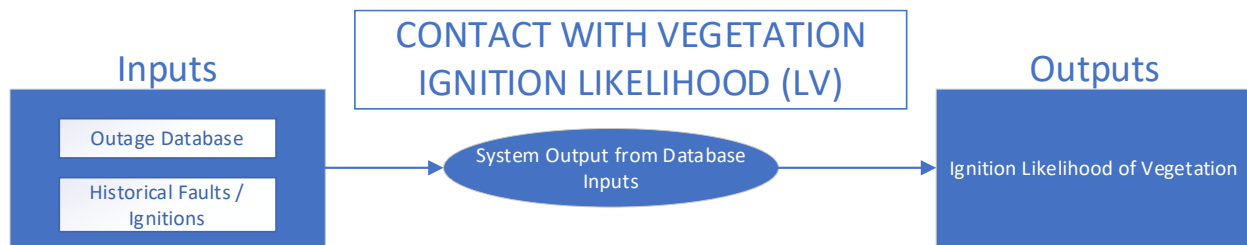

High-level calculation procedure schematic

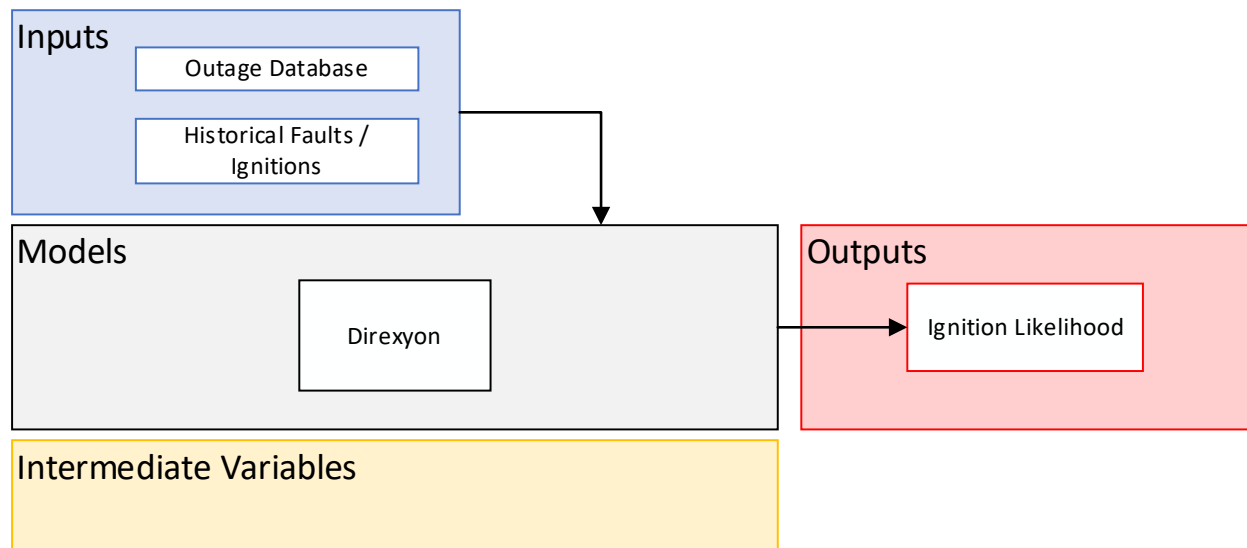

High-level narrative

- *Purpose of the calculation/model*
- *Assumptions and limitations*
- *Description of the calculation procedure shown in the bow tie and high-level schematics*

BVES has brought in DIREXYON to enhance our risk modelling efforts that incorporates the likelihood of fire caused by vegetation into their models, which varies based on the vegetation—whether they have fallen, grown, or the overall tree density (fall in, grow in, and tree density). Markov chains are employed to model the probability of transitioning from the best zone (4) to the worst zone (1), dependent on the number of years since the last vegetation inspection.

For all three mentioned metrics, a zone value is predicted annually based on the elapsed time since the last vegetation management intervention. Consequently, with an increasing number of years since the last vegetation management intervention, the probability of transitioning from the best zones to the worst zones rises. In simpler terms, without regular inspections, there is a heightened risk of the vegetation around the equipment growing unchecked, thereby increasing the likelihood of fires. The final CM vegetation is the product of three Condition Modifiers (CMs) CM – Fall in, CM – Grow in, and CM – Density. For each metric if the tree's state remains unaltered compared to the initial state, the related CM is set at 1. However, if it deteriorates, the CM adjusts from 25% to 100% (based on the initial and current zones), and if it improves, it decreases by 25% to 75%. This meticulous approach ensures a nuanced representation of the

impact of vegetation on fire risk within the model. Each of the identified metrics is briefly explained below:

Fall-In

Data for this metric is sourced from a shape file provided by BVES. Calculated based on tree height and the distance of the tree to the pole, Fall-In zones are defined depending on the minimum height required for a tree to impact an asset. This determination considers the pole height, tree distance to pole, and the specified minimum heights.

Density

Data for this metric comes from the VegManagementDataPartner, with no specific aggregation performed on the dataset. It represents the density of vegetation around the assets.

These condition modifiers address the contact from vegetation ignition likelihood within the identified gap.

- *Description of how outputs will be characterized and presented (e.g., visualization) to decision makers*
- *Concise description and timeline of planned changes to the calculation procedure over the triennial WMP cycle, including any key improvements from the Energy Safety Wildfire Risk Modeling Working Group and plans to align with the consensus Risk Modeling Requirements by January 1, 2024.*

BVES will review feedback from the working groups that it has been involved in including the Wildfire Risk Model Working Group and assess the need for improvements or changes. BVES plans to include more data and documentation for this risk model/component in future WMPs. Additionally, BVES plans to complete formal implementation and staff training on the WFA-E model to develop proficient model users and implement use of the WRRM and FPI in evaluating wildfire risks including vegetation ignition likelihood.

B.1.11 Contact by Object Ignition Likelihood (LO)

High-level bow tie schematic

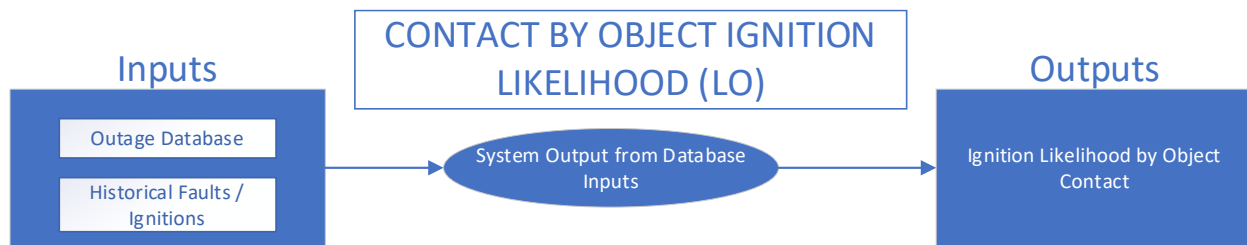

High-level calculation procedure schematic

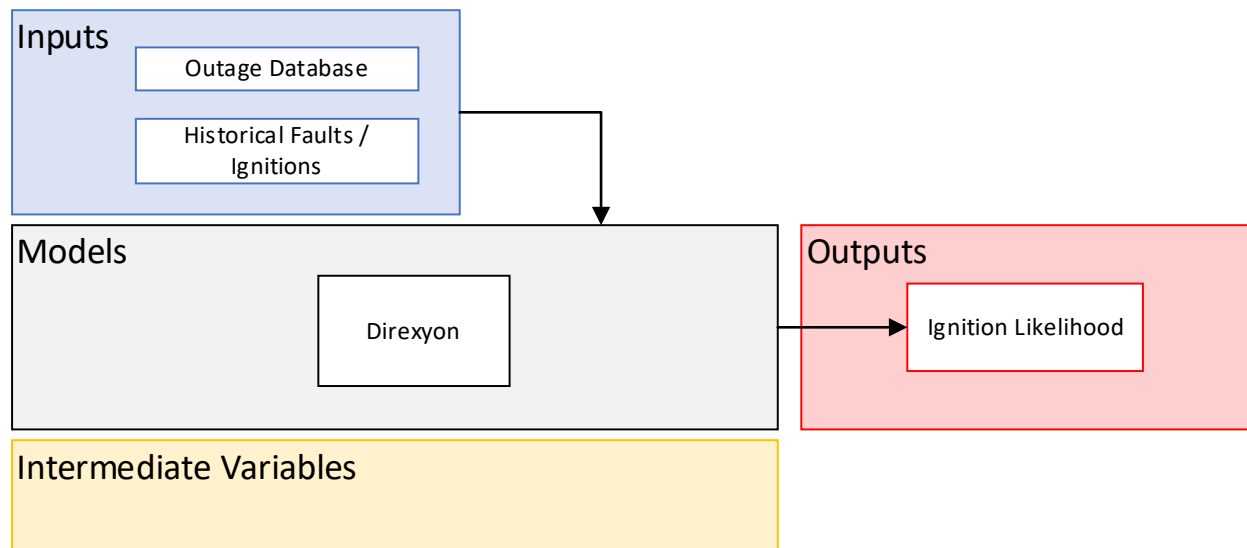

High-level narrative

BVES collaborated with DIREXYON to introduce a new risk modeling tool to BVES's wildfire risk mitigation practices. The model is completed; however, as of the date of this filing the model is not fully implemented. BVES staff are completing training by DIREXYON on the model and BVES will need to set certain modifier values and risk weightings before the model is fully operational. BVES expects the model to be in full operation by Q4 2024. Updates to Appendix B including the addition of the DIREXYON's White Paper have been made as part of BVES Risk Modeling updates. The following paragraphs describe the new risk model.

- *Purpose of the calculation/model*
- *Assumptions and limitations*
- *Description of the calculation procedure shown in the bow tie and high-level schematics*
- *Description of how outputs will be characterized and presented (e.g., visualization) to decision makers*

As the model is still in development BVES is not yet aware how the output will be characterized and presented to decision makers. Following the completion of the development phase BVES will have a better understanding of the output and how it can be used by decision makers in the wildfire mitigation process.

- *Concise description and timeline of planned changes to the calculation procedure over the triennial WMP cycle, including any key improvements from the Energy Safety Wildfire Risk Modeling Working Group and plans to align with the consensus Risk Modeling Requirements by January 1, 2024.*

BVES will review feedback from the working groups that it has been involved in including the Wildfire Risk Model Working Group and assess the need for improvements or changes. BVES plans to include more data and documentation for this risk model/component in future WMPs. Additionally, BVES plans to complete formal implementation and staff training on the WFA-E model to develop proficient model users and implement use of the WRRM and FPI in evaluating wildfire risks including contact by object ignition likelihood.

B.1.12 Burn Probability (LB)

High-level bow tie schematic

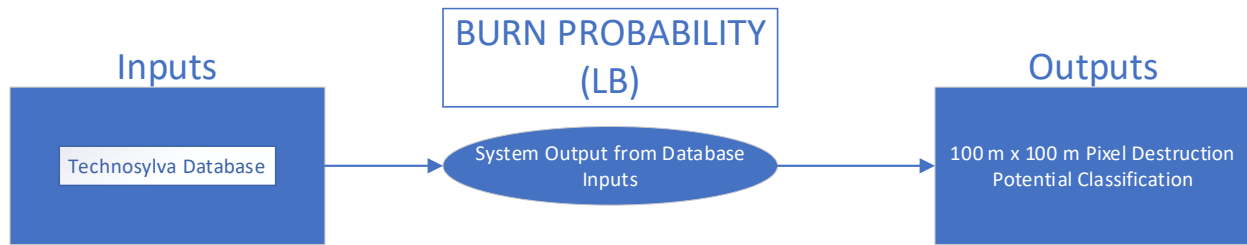

High-level calculation procedure schematic

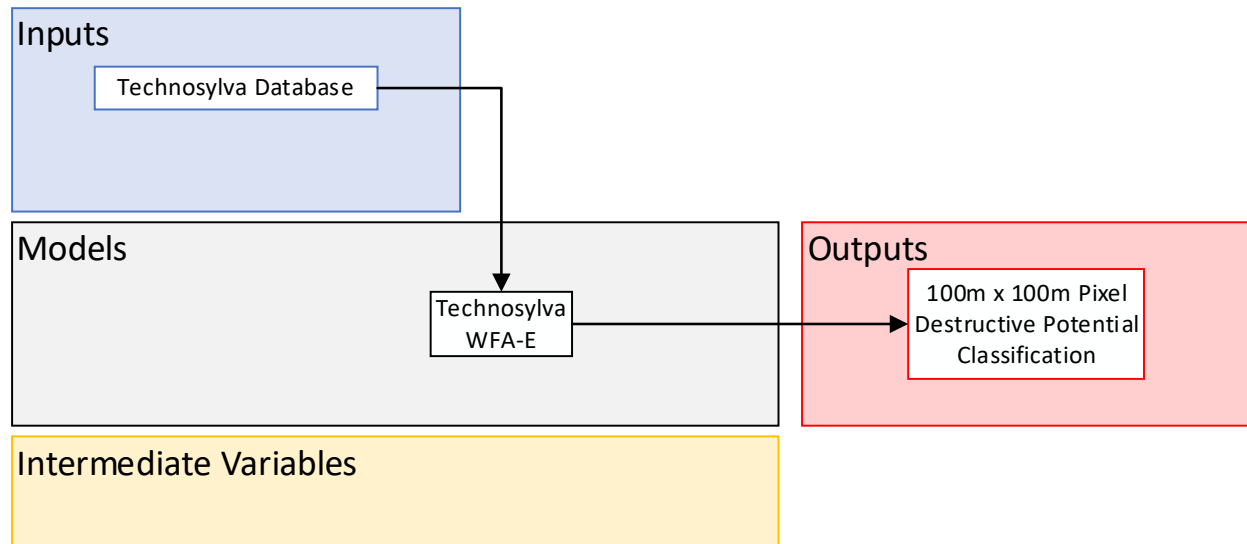

High-level narrative

- *Purpose of the calculation/model*
- *Assumptions and limitations*
- *Description of the calculation procedure shown in the bow tie and high-level schematics*
- *Description of how outputs will be characterized and presented (e.g., visualization) to decision makers*
- *Concise description and timeline of planned changes to the calculation procedure over the triennial WMP cycle, including any key improvements from the Energy Safety Wildfire Risk Modeling Working Group and plans to align with the consensus Risk Modeling Requirements by January 1, 2024.*

BVES will review feedback from the working groups that it has been involved in including the Wildfire Risk Model Working Group and assess the need for improvements or changes. BVES plans to include more data and documentation for this risk model/component in future WMPs. Additionally, BVES plans to complete formal implementation and staff training on the WFA-E model to develop proficient model users and implement use of the WRRM and FPI in evaluating wildfire risks including burn probability.

B.1.13 Wildfire Hazard Intensity (WHI)

High-level bow tie schematic

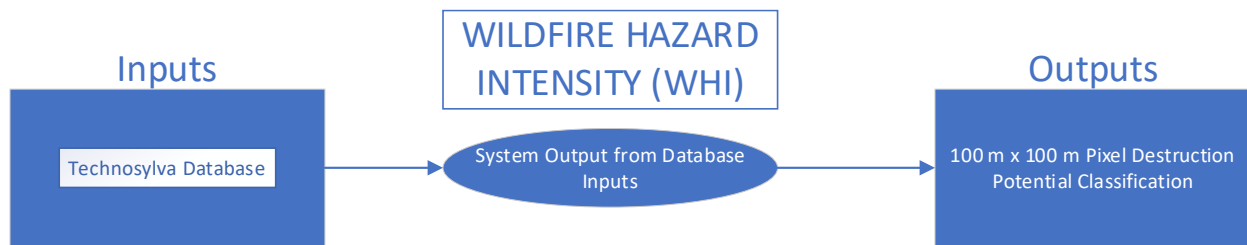

High-level calculation procedure schematic

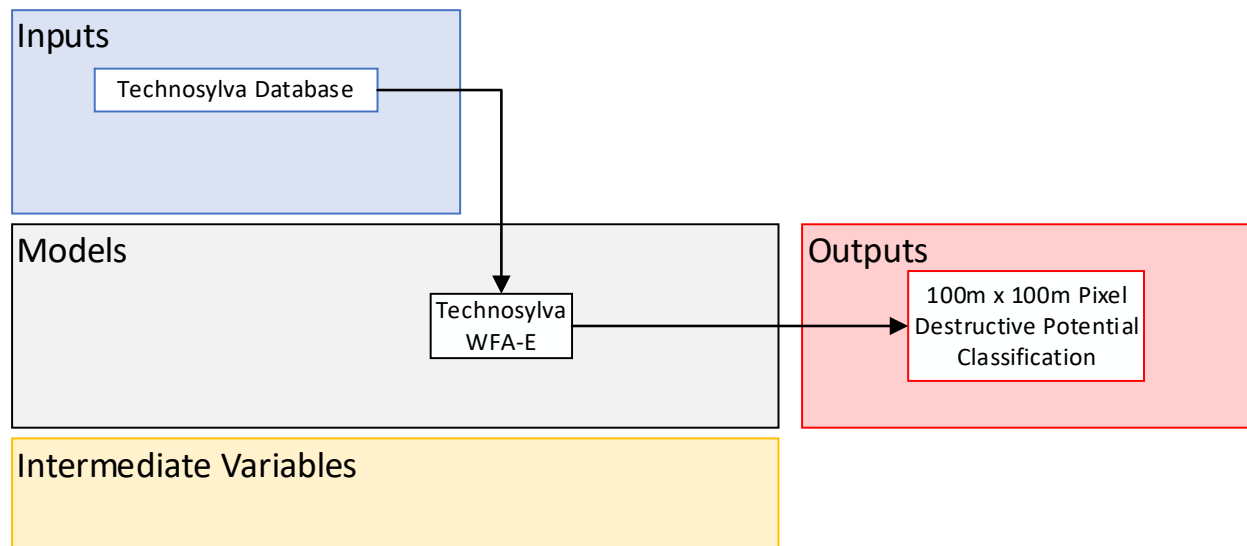

High-level narrative

- *Purpose of the calculation/model*
- *Assumptions and limitations*
- *Description of the calculation procedure shown in the bow tie and high-level schematics*
- *Description of how outputs will be characterized and presented (e.g., visualization) to decision makers*
- *Concise description and timeline of planned changes to the calculation procedure over the triennial WMP cycle, including any key improvements from the Energy Safety Wildfire Risk Modeling Working Group and plans to align with the consensus Risk Modeling Requirements by January 1, 2024.*

BVES will review feedback from the working groups that it has been involved in including the Wildfire Risk Model Working Group and assess the need for improvements or changes. BVES plans to include more data and documentation for this risk model/component in future WMPs. Additionally, BVES plans to complete formal implementation and staff training on the WFA-E model to develop proficient model users and implement use of the WRRM and FPI in evaluating wildfire risks including wildfire hazard intensity.

B.1.14 Wildfire Exposure Potential (WEP)

High-level bow tie schematic

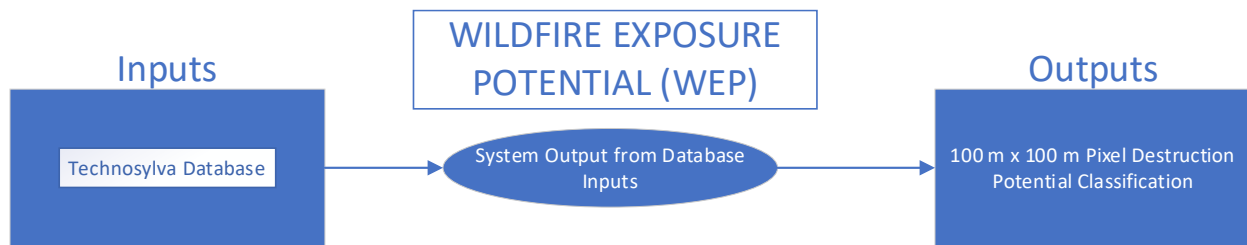

High-level calculation procedure schematic

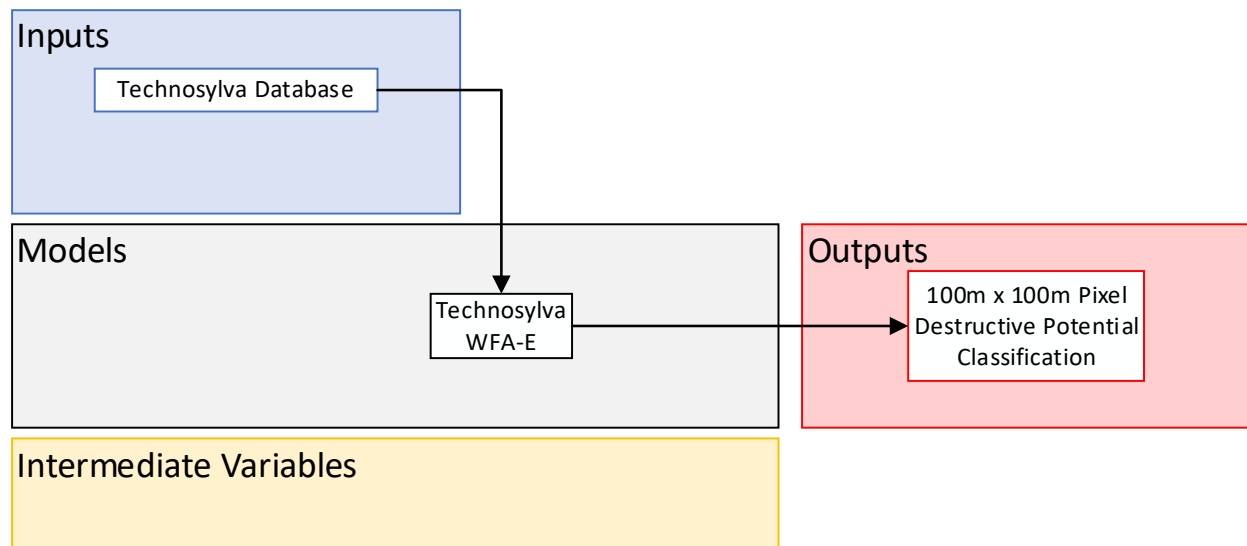

High-level narrative

- *Purpose of the calculation/model*

The purpose of the model is to provide a visual tool that displays the physical, social, and economic impact of a wildfire on the people property, critical infrastructure, livelihoods, health, environmental services, local economies, cultural/historical resources, and other high-value assets. These may include direct or indirect impacts, as well as short- and long-term impacts.

- *Assumptions and limitations*
- *Description of the calculation procedure shown in the bow tie and high-level schematics*
- *Description of how outputs will be characterized and presented (e.g., visualization) to decision makers*
- *Concise description and timeline of planned changes to the calculation procedure over the triennial WMP cycle, including any key improvements from the Energy Safety Wildfire Risk Modeling Working Group and plans to align with the consensus Risk Modeling Requirements by January 1, 2024.*

BVES will review feedback from the working groups that it has been involved in including the Wildfire Risk Model Working Group and assess the need for improvements or changes. BVES plans to include more data and documentation for this risk model/component in future WMPs. Additionally, BVES plans to complete formal implementation and staff training on the WFA-E

model to develop proficient model users and implement use of the WRRM and FPI in evaluating wildfire risks including wildfire exposure potential.

B.1.15 Wildfire Vulnerability (WV)

High-level bow tie schematic

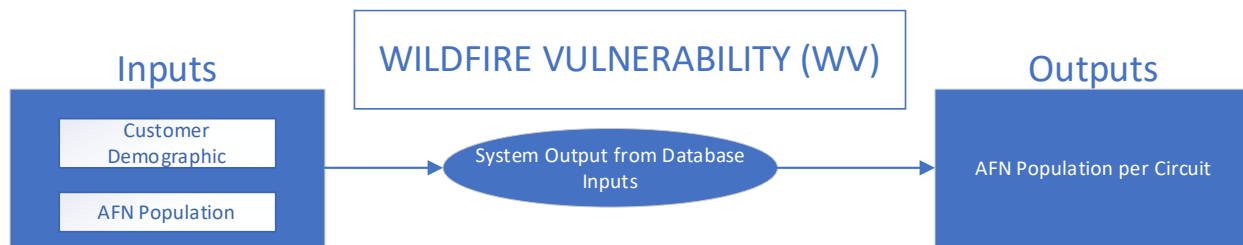

High-level calculation procedure schematic

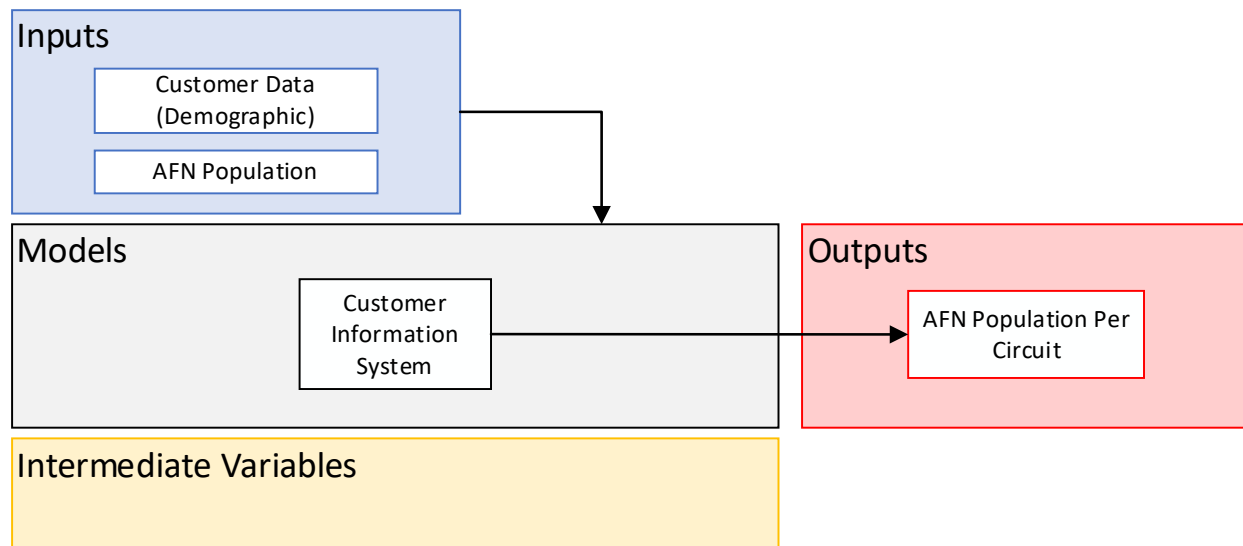

High-level narrative

- *Purpose of the calculation/model*

The purpose of this calculation is to determine the AFN population per circuit which will be used as an input in determining the Wildfire Risk for a circuit segment.

- *Assumptions and limitations*

The assumption or limitation of this risk component is that the evaluation process assumes all AFN customers have registered themselves with BVES. It is highly likely that there are customers that would fall in the AFN category that BVES is not aware of due to the need for customer action.

- *Description of the calculation procedure shown in the bow tie and high-level schematics*

BVES will evaluate the customer data and the AFN population data that is available in the Customer Information System to determine the number of AFN customers per circuit.

- *Description of how outputs will be characterized and presented (e.g., visualization) to decision makers*

The output from Wildfire Vulnerability will be a customer's/circuit unit that will be used as a sub-component for Wildfire Risk. While the output metrics will be visible to decision makers it will primarily be used in determination of Wildfire Risk.

- *Concise description and timeline of planned changes to the calculation procedure over the triennial WMP cycle, including any key improvements from the Energy Safety Wildfire Risk Modeling Working Group and plans to align with the consensus Risk Modeling Requirements by January 1, 2024.*

BVES will review feedback from the working groups that it has been involved in including the Wildfire Risk Model Working Group and assess the need for improvements or changes. BVES plans to include more data and documentation for this risk model/component in future WMPs. Additionally, BVES plans to complete formal implementation and staff training on the WFA-E model to develop proficient model users and implement use of the WRRM and FPI in evaluating wildfire risks including wildfire vulnerability of BVES system and customers.

B.1.16 PSPS Exposure Potential (PEP)

High-level bow tie schematic

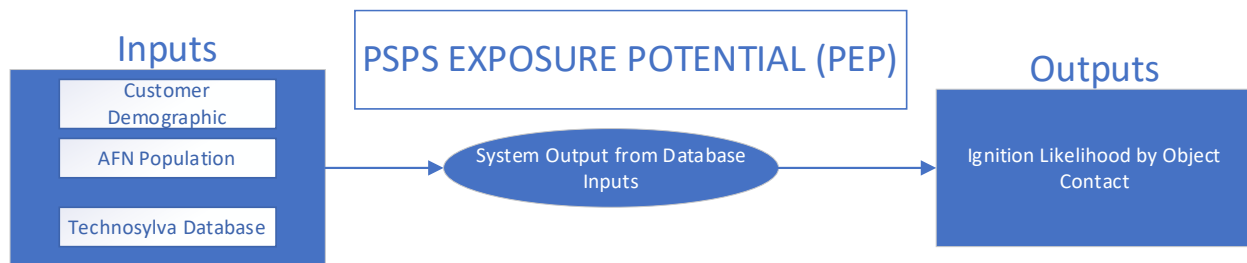

High-level calculation procedure schematic

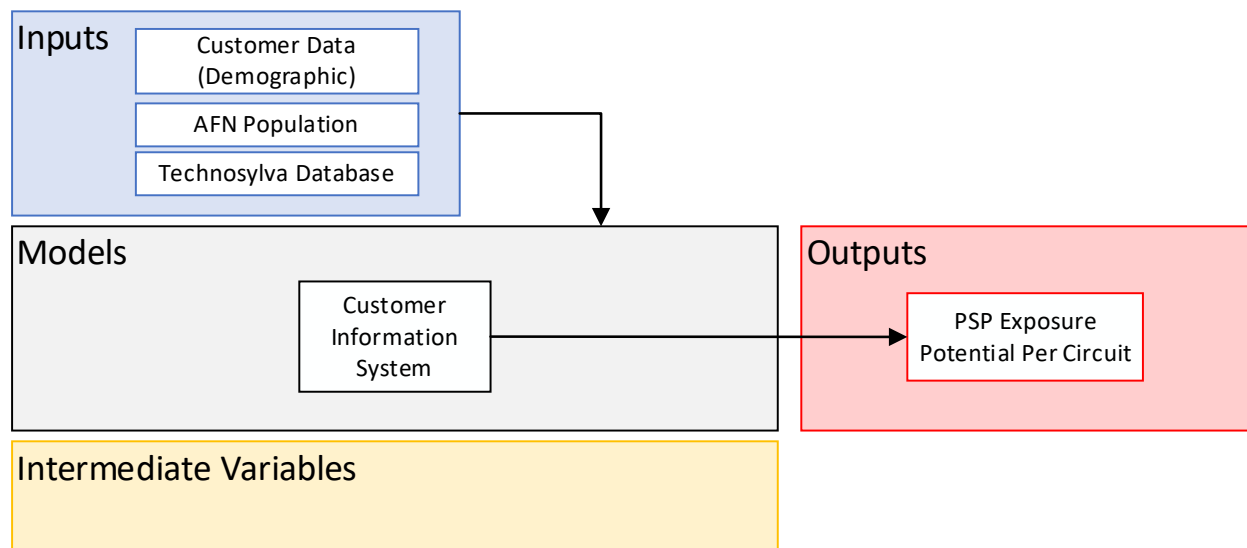

High-level narrative

BVES collaborated with DIREXYON to introduce a new risk modeling tool to BVES's wildfire risk mitigation practices. The model is completed; however, as of the date of this filing the model is not fully implemented. BVES staff are completing training by DIREXYON on the model and BVES will need to set certain modifier values and risk weightings before the model is fully operational. BVES expects the model to be in full operation by Q4 2024. Updates to Appendix B including the addition of the DIREXYON's White Paper have been made as part of BVES Risk Modeling updates. The following paragraphs describe the new risk model.

- *Purpose of the calculation/model*

The purpose of this calculation is to determine exposure potential for AFN customers if/when a PSPS event occurs. This model takes into account PSPS Vulnerability (PV)

- *Assumptions and limitations*

The assumption or limitation of this risk component is that the evaluation process assumes all AFN customers have registered themselves with BVES. It is highly likely that there are customers that would fall in the AFN category that BVES is not aware of due to the need for customer action. There also may be additional limitations associated with database update cycles, but that has not yet been determined

- *Description of the calculation procedure shown in the bow tie and high-level schematics*

The bow tie model and high-level schematic are representative of what BVES believes the process will look like. Following the completion of the development phase an accurate model can be made available.

- *Description of how outputs will be characterized and presented (e.g., visualization) to decision makers*

As the model is still in development BVES is not yet aware how the output will be characterized and presented to decision makers. Following the completion of the development phase BVES will have a better understanding of the output and how it can be used by decision makers in the wildfire mitigation process.

- *Concise description and timeline of planned changes to the calculation procedure over the triennial WMP cycle, including any key improvements from the Energy Safety Wildfire Risk Modeling Working Group and plans to align with the consensus Risk Modeling Requirements by January 1, 2024.*

BVES will review feedback from the working groups that it has been involved in including the Wildfire Risk Model Working Group and assess the need for improvements or changes. BVES plans to include more data and documentation for this risk model/component in future WMPs. Additionally, BVES plans to complete formal implementation and staff training on the WFA-E model to develop proficient model users and implement use of the WRRM and FPI in evaluating wildfire risks including wildfire vulnerability of BVES system and customers.

B.1.17 PSPS Vulnerability (PV)

High-level bow tie schematic

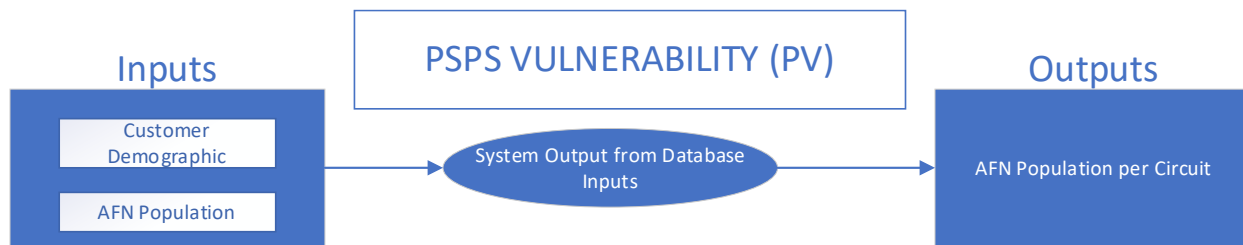

High-level calculation procedure schematic

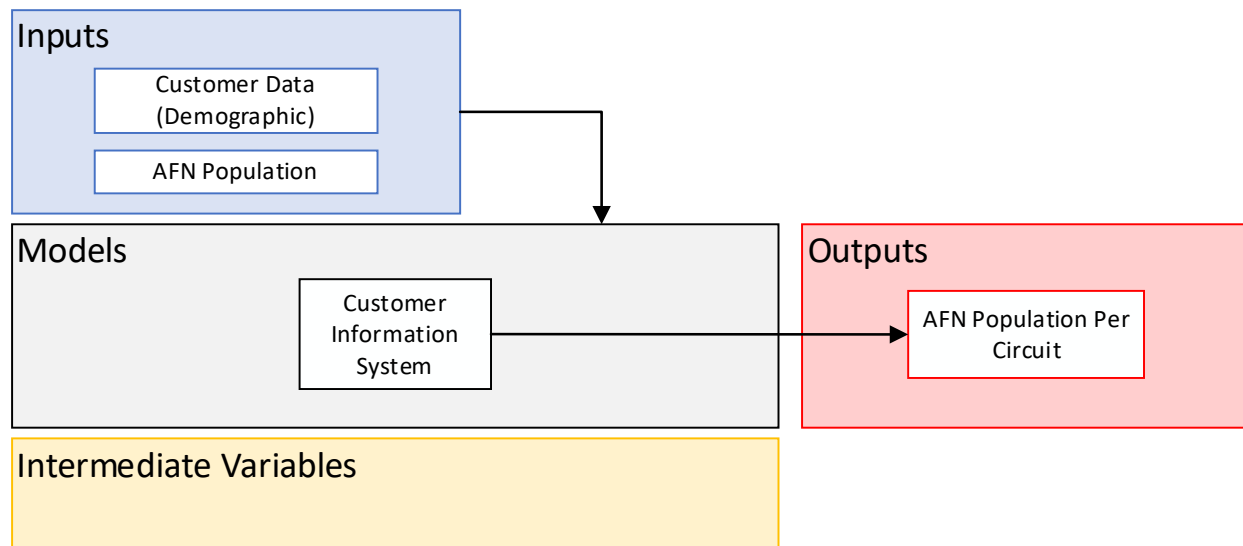

High-level narrative

- *Purpose of the calculation/model*

The purpose of this calculation is to determine the AFN population per circuit which will be used as an input in determining the PSPS Risk for a circuit segment.

- *Assumptions and limitations*

The assumption or limitation of this risk component is that the evaluation process assumes all AFN customers have registered themselves with BVES. It is highly likely that there are customers that would fall in the AFN category that BVES is not aware of due to the need for customer action.

- *Description of the calculation procedure shown in the bow tie and high-level schematics*

BVES will evaluate the customer data and the AFN population data that is available in the Customer Information System to determine the number of AFN customers per circuit.

- *Description of how outputs will be characterized and presented (e.g., visualization) to decision makers*

The output from PSPS Vulnerability will be a customer's/circuit unit that will be used as a sub-component for PSPS Risk. While the output metrics will be visible to decision makers it will primarily be used in determination of PSPS Risk

- *Concise description and timeline of planned changes to the calculation procedure over the triennial WMP cycle, including any key improvements from the Energy Safety Wildfire Risk Modeling Working Group and plans to align with the consensus Risk Modeling Requirements by January 1, 2024.*

BVES will review feedback from the working groups that it has been involved in including the Wildfire Risk Model Working Group and assess the need for improvements or changes. BVES plans to include more data and documentation for this risk model/component in future WMPs. Additionally, BVES plans to complete formal implementation and staff training on the WFA-E model to develop proficient model users and implement use of the WRRM and FPI in evaluating wildfire risks including PSPS vulnerability of BVES system and customers.

Figure B-1. Example Bow Tie Schematic

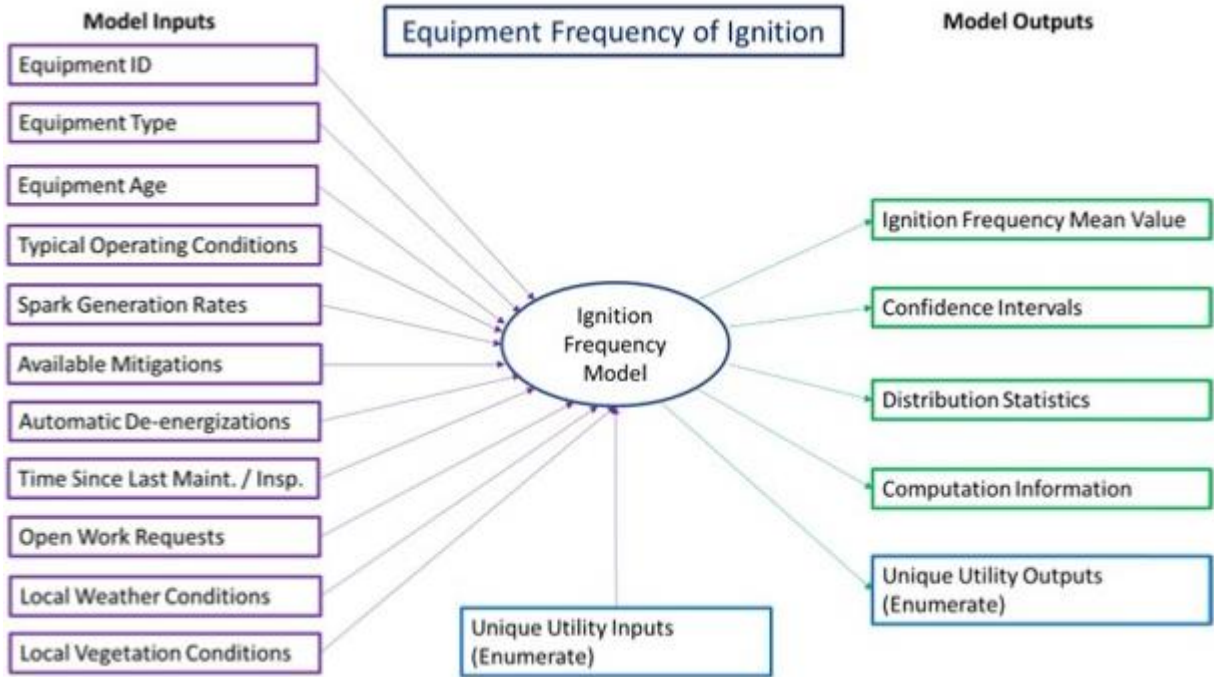

Figure B-2. Example Calculation Schematic

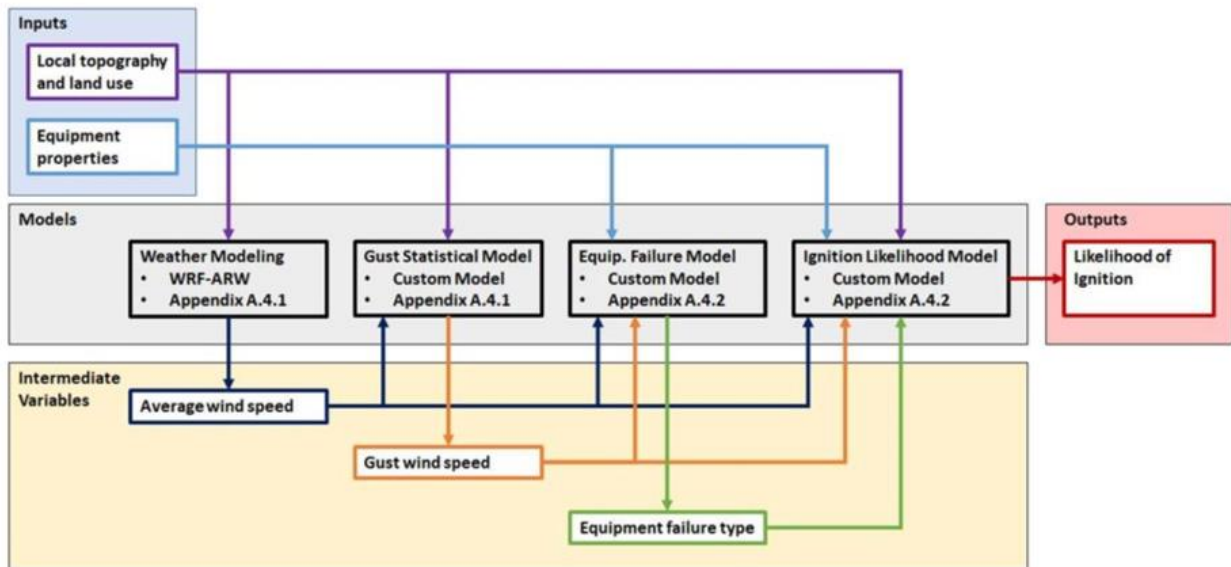



Table of Contents

1	Technical Model Documentation	2
1.1	Purpose	2
1.2	Applicability	2
2	Technical Documentation	2
2.1	Problem or Function	2
2.1.1	Problem Modeled	2
2.2	Technical Description	3
2.2.1	Theoretical and Mathematical Foundations	3
2.3	Theoretical Foundation	4
2.3.1	Phenomenon and Physical Laws (Model Basis)	4
2.3.2	Governing Equations	5
2.3.3	Assumptions	6
2.3.4	Independent Review Results (see Guide ASTM E 1355)	7
2.4	Mathematical Foundation	7
2.4.1	Techniques, Procedures, Algorithms	7
2.4.2	References to Techniques and Algorithms	8
2.4.3	Equations and Implementation	10
2.4.4	Limitations (see Guide ASTM E 1895)	19
2.5	Data Libraries	19
2.5.1	Landscape Characteristics	20
2.5.2	Surface and Canopy Fuels	20
2.5.3	Weather and Atmospheric Data	23
2.5.4	Fuel Moisture	25
2.5.5	Values at Risk	26
2.5.6	Possible Ignition Sources	27
2.5.7	Fire Activity	27
2.5.8	Summary of Input Data Sources	28
2.5.9	Fire Potential Index (FPI)	32



Technosylva Statement of Confidentiality

This document has been developed by Technosylva, Inc. in support of our IOU customers for use in WMP development and submittal, and subsequent data requests. Confidential sections have been removed from this document and the remaining sections are considered non-confidential and can be shared in their entirety.

Confidential information is provided in its entirety to the customer to support their understanding of modeling and technical details employed in the subscription products used by the customer. As necessary, Technosylva will endeavor to provide additional generic descriptions for this confidential content to support customer submittal requirements when requested.



1 Technical Model Documentation

1.1 Purpose

The Office of Energy Infrastructure (OEIS) requires transparency in risk calculation methodologies supporting Wildfire Mitigation. Per the guidelines, OEIS has specific requirements for technical documentation, substantiation, and data governance of the models used in risk calculations for the WMP. This template outlines the required technical documentation and substantiation for the models, while the [WMP Data Governance Framework](#) covers the data governance requirements for the models.

1.2 Applicability

The applicability of the model documentation and governance applies to every model included in the [Wildfire Mitigation Plan](#) filed with the OEIS.

2 Technical Documentation

2.1 Problem or Function

2.1.1 Problem Modeled

Define the problem modeled for function performed by the program, for example, calculation of fire growth, smoke spread, people movement, etc.

The application of wildfire behavior modeling and risk analysis is used to quantify the potential impacts from possible electric utility infrastructure asset caused ignitions. The basis of this modeling is that not all ignitions (fires) are created equal, and each asset caused ignition can have substantially different consequence based on ignition location and related landscape characteristics.

The wildfire modeling and risk analysis derives a set of consequence metrics that quantify impacts. This includes potential acres burned, population impacted, number of buildings threatened, and estimated number of buildings destroyed. These are currently derived using an 8-hour simulation duration, based on a typical first burning period. Testing is underway to evaluate different fire durations based on suggestions in the most recent WMP Guidelines.

Technosylva's Wildfire Analyst™ (WFA) product is used to conduct the modeling, deliver modeling outputs, and monitor and visualize results with software applications.

The wildfire behavior modeling and risk analysis is applied to address two different, yet similar, scenarios. First, the modeling is used with historical re-analysis WRF weather data to support the mitigation planning process. The WFA FireSight, previously called Wildfire Risk Reduction Model (WRRM), is used to quantify risk metrics from millions of wildfire simulations using the numerous WRF weather scenarios defined. This wildfire consequence data is then combined with probability of failure and ignition analysis developed internally to define composite risk values to support prioritization decision making for asset hardening and related mitigation.

Secondly, the modeling is also used with daily WRF-based weather forecast data to calculate consequence based risk metrics for all assets as possible ignition sources to support operational requirements. Other key input datasets such as surface and canopy fuels, and live fuel moisture and dead fuel moisture, are developed daily using Machine Learning (ML) models to calculate the wildfire



behavior outputs as part of the risk analysis model. Wildfire risk forecasts are derived daily, or sometimes twice daily, with a multi-day outlook on an hourly basis. This information is used as input into key decision making related to operational requirements, such as PSPS, resource allocation and deployment, field operations, etc.

Note that the Technosylva Wildfire Analyst™ product is comprised of three discrete applications – FireSim, FireRisk and FireSight. “FireRisk” is the new name for the application formerly called “FireCast”. This was renamed to better meet platform functionality naming consistency. Accordingly, all references to FireRisk are identical to all functionality previously provided under the name “FireCast”. Also note that the platform is now called Wildfire Analyst. “Enterprise” has been removed from the product platform name. To meet PacifiCorp requirements, a subscription to all three applications is required.^[4] These include:

1. WFA FireRisk – daily asset-based risk forecasting to support operational needs, such as PSPS (previously called FireCast), including all situational awareness capabilities.
2. WFA FireSim – on-demand wildfire spread modeling to support real-time incident analysis and “what if” analysis for pending weather events to support operational needs.
3. WFA FireSight – risk analysis for assets using historical fire scenarios to ensure comprehensive understanding of asset ignition probability and consequence to support mitigation planning, such as WMP prioritization and development (previously called WRRM). FireSight includes integration of outage analytics, probability of outage/failure, and probability of ignition as well as built-in integrations to support calculations for risk reduction, mitigation effectiveness and risk spend efficiency.

FireRisk and FireSim support operational needs while FireSight supports enterprise risk management and mitigation planning needs. FireSight is implemented separately from FireRisk and FireSim.

2.2 Technical Description

2.2.1 Theoretical and Mathematical Foundations

Convey a thorough understanding of the theoretical and mathematical foundations, referencing the open literature where appropriate.

The basis of the wildfire risk modeling for electric utility assets lies in the published, proven and accepted fire science for wildfire behavior modeling. The Technosylva WFA product used to create risk metrics for both operational and planning initiatives utilizes the best-in-class fire science available. Technosylva has been able to operationalize proven wildfire behavior models and validate these models through on-going collaboration with CAL FIRE and the US Forest Service Missoula Fire Laboratory as the only unique vendor selected. This collaboration provides the operational platform to test and validate a suite of wildfire behavior and risk models that are utilized for statewide intelligence and operations by CAL FIRE, and by each IOU in California for operations and mitigation.

To support the model R&D and implementation, Technosylva regularly publishes peer reviewed and accepted articles regarding these models. Technosylva has been involved in 30+ publications over the past 24 months, with 11 as the principal investigator. Some of these publications are referenced on the Technosylva web site at <https://technosylva.com/scientific-research/>.



The published fire science provides the theoretical foundation for the operational models, tempered by validation analysis conducted on an on-going basis, to continually refine the models to match what occurs with observed wildfire behavior. The rest of this section provides a detailed description of the theoretical and mathematical foundation for the WFA models.

2.3 Theoretical Foundation

2.3.1 Phenomenon and Physical Laws (Model Basis)

Describe the theoretical basis of the phenomenon and the physical laws on which the model is based.

Fire is a self-sustained and usually uncontrolled sequence of processes basically carried out by the combination of fuel, oxygen and heat. In forest fires (also referred to as wildland fire or wildfire), the fuel is given by the vegetation layer composed of trees, bushes and all kinds of dead and living foliage (organic matter). The oxygen is abundantly present in the atmosphere and the heat is caused by the combustion of the flame and transported mainly by radiation and convection within the vegetation.

A quick review of the process involved could be described as follows. Consider a homogeneous flammable solid material like wood to which an external heat flux has been imposed. As the solid material absorbs the heat it raises its temperature at a rate dependent on the net heat capacity of the material (mix of all the components of the solid, including water). As the temperature increases, the moisture content in the solid diminishes and eventually dries up the solid. A further increase of the temperature causes the pyrolysis process of the wood (around 550 K), the organic material decomposes into a stream of volatile gasses (smoke, carbon and oxygen) and into solid remains like char (nearly pure carbon), and ashes (incombustible minerals like calcium, potassium, etc). The pyrolyzed fuel vapor convects and diffuses, mixing with the oxygen of the atmosphere and forming a combustible mixture. The high gas temperature favors the initiation of a gas phase combustion reaction in the combustible-oxidizer mixture. The compound molecules break apart, the atoms recombine with the oxygen to form water, carbon dioxide and some other products. The whole process is ruled by many factors, the types of char and volatile, the amount of oxygen and the exact chemical reactions taking place. The temperature difference between the gasses released in the pyrolysis process and the ambient air together with the gained temperature due to the oxidation reaction (around 1000 K), generates a buoyancy flow that raises up the hot combusting gas forming the characteristic flames of the fire.

In the wildland, fire behavior deeply depends on the vegetation (type, size and vertical arrangement), terrain, wind and moisture conditions of the vegetation (dead and living material). From a descriptive perspective, wildfires main observables are the fires Rate of Spread (ROS), flame length, flame intensity, heat per unit area, flame depth, and residence time. Depending on the behavior of the fire it may be classified as surface and crown fire. Surface fires burn loose needles, moss, lichen, herbaceous vegetation, shrubs, small trees and sampling that are at or near the surface of the ground. Crown fires burn forest canopy fuels, which include live and dead foliage/ branches, lichens in trees, and tall shrubs that lie well above the surface fuels. They are usually ignited by a surface fire. Crown fires can be passive or active. Passive crown fires involve the burning of individual trees or small groups of trees (often called torching). Active crown fires, or also referred to as running crown fires, present a solid wall of flame from the surface through the canopy fuel layers.

Fire growth from an ignition point can be split into four distinct phases (Fire science 2021), in the first phase the fire starts to burn slowly as the influx of air caused by the buoyancy flow of hot gasses causes the flames to tilt inwards. Once the fire has spread enough from the ignition point, wind is able to enter



the already burned vegetation and pushes the flames away from the center and tilts them towards the unburned fuels, increasing the heat transfer, and therefore accelerating the fire. As the fire moves further away from the center, the acceleration of the fire depends more on the local characteristics of the curvilinear front. Finally, the fire may reach a steady-state when the fire line is uniform enough so that it can be considered of infinite length.

2.3.2 Governing Equations

Present the governing equations and the mathematical model employed.

Fire modeling is a highly challenging problem from both the physical and the numerical point of view, and consequently historical advances in this field have always been forced to a compromised position due to the desire of practical usefulness, computer capabilities, required input data, and existing numerical methods. It is only by the consideration of these requirements that the primary natural approaches to the problem can be understood. The primary broad approaches are physical models, quasi-empirical models, and empirical ones.

Physical models are the most complex and have the advantage to be more generally valid across different fuels and weather conditions (Cruz 2017). They are usually posed as a set of coupled differential equations derived from conservation laws and defined on a usually bidimensional domain representing the vegetation layer considered as a porous medium where the main variables develop. The degree of approximation of the initial semi-physical description of the problem, as well as the rest of physical effects considered in the modeling may vary greatly from one model to another. Despite these different approaches, a conventional 2D multiphase model, sketching vegetation temperature through a convection reaction diffusion equation, and a solid combustible material evolution in time may serve as a simple example for illustration purposes.

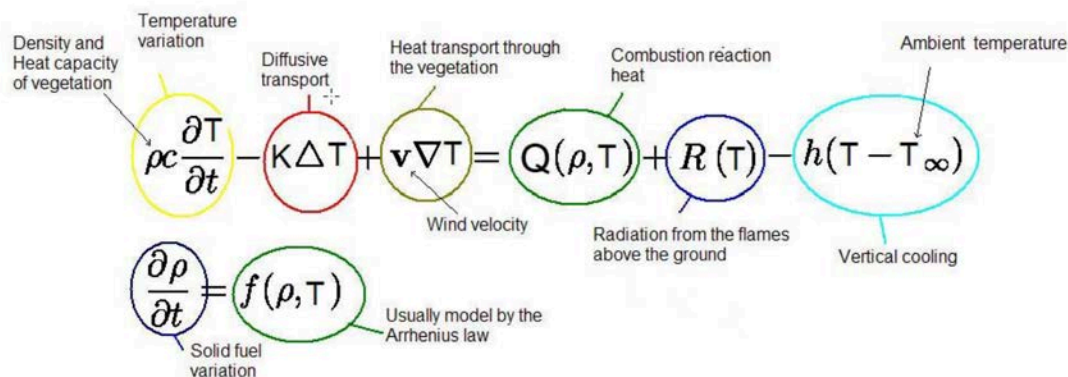

Example of a 2D multiphase model sketching vegetation temperature and solid combustible

Even though physical models are very promising, they are not easy to make operational because in many cases the detailed input data they need is not readily available, and because they require a lot of computer processing capability, as they usually use adaptive meshes to keep track of the burning front. Some numerical methods used for solving these models are the Finite Element Method (FEM), Finite Difference methods (FDM), etc.

Empirical and semi-empirical models are mainly based on experimental data: laboratory runs, controlled outdoor fires, or well documented wildland fires. The difference between the empirical and



semi-empirical approach is that the former ones contain no physical basis at all and are generally statistical in nature, while the later use some form of physical framework on which the statistical model is based (Andrews 2018, Sullivan 2009). These models are largely developed to support decision making and are the main operational models used today. They are typically able to predict the source dataset with mean absolute percent errors between 20 and 40% (Cruz et al. 2013)

Further review of existing fire modeling approaches can be found in Catchpole and De Mestre (1986), Weber (1991), Pastor et al. (2003), Sullivan (2009a,b,c)

2.3.3 Assumptions

Identify the major assumptions on which the fire model is based and any simplifying assumptions.

The following are some of major assumptions contained in the models

- The physical framework development is based on an idealized situation in steady state spread which may not fit some extreme behavior of fires.
- Fuels are assumed to be continuous and uniform for the scale of the input (typically between 10 to 30 meter (m) resolution)
- Fire characteristics at a point only depend on the conditions at that point (point-functional model). This means that there are certain non-local phenomena like:
 - Increase of ROS due to a concave front.
 - Fire interaction between different parts of the same fire or a different one
- Fire spread is assumed to be elliptical although there are several variations such as double ellipse, oval, egg-shape, etc.
- Weather is given hourly and is assumed to remain constant during that time. There is no interpolation in time to compute the evolution of weather between hours.
- Reliability of weather inputs in the mid-range forecast (2 to 5 days)
- Fire is not coupled with the atmosphere in any way. This may seem like a major limitation in the model as wind is a main contribution to fire spread and at present many models (specially physical ones) try to couple wind and fire. The main reasons for us not to consider the coupling is:
 - It would make it infeasible to run millions of simulations considering the coupling effect.
 - Empirical and semi-empirical models have been developed using an average wind speed as an input, so it is not clear that considering more granular wind at the front is advisable.
- Fire is always assumed to be fully developed. Fire acceleration, flashover, or decay is not considered.
- Atmospheric instability which may have a deep impact on ROS (beer 1991) is not considered in the model.
- Gusts are not considered in the model
- No interaction between slope and wind other than creating an effective or equivalent wind. This means that fire is assumed to have an elliptical shape no matter the alignment of wind and slope.
- Models have been developed with scarce empirical data. The abundance of today's fire data sources, however, is allowing us to better adjust models to observed fire patterns.
- Fuel array description of the vegetation may not perfectly describe fuel characteristics.
- Spotting is only considered in surface fires



2.3.4 Independent Review Results (see Guide ASTM E 1355)

Provide the results of any independent review of the theoretical basis of the model. Guide E1355 recommends a review by one or more recognized experts fully conversant with the chemistry and physics of the fire phenomena but not involved with the production of the model.

The core models implemented in WFA form the basis of most operational propagation models in use today (Andrews et al 1980, Gould 1991). They have been implemented in well-known software like NEXUS (Scott and Reinhardt 2001), Fire and Fuels Extension to Forest Vegetation Simulator (FFE-FVS) (Reinhardt and Crookston 2003), FARSITE (Finney 2004), Fuel Management Analyst (FMAPlus) (Carlton 2005), FlamMap (Finney 2006) and BehavePlus (Andrews et al. 2008). Nevertheless, forest fires are a very difficult phenomenon to simulate which depends on many different factors and typical simulations are able to predict the source dataset with mean absolute percent errors between 20 and 40% (Cruz et al. 2013)

One of the important facts in fire simulation is the definition of the fuel models, with analysis providing different results for different fuels and regions. For example, Sanders (2001) observed a pattern of over-prediction by FARSITE in fuel models 1, 2, 5 by a large margin, moderate in fuel 10 and some underprediction for fuel model 8. Zigner et al (2020) used two case studies during strong winds revealing that FARSITE was able to successfully reconstruct the spread rate and size of wildfires when spotting was minimal. However, in situations when spotting was an important factor in rapid downslope wildfire spread, both FARSITE and FlamMap were unable to simulate realistic fire perimeters. Ross et al. (2006) used measurements from temperature sensors during prescribed burns in the Appalachian Mountains to recreate the fires and compared fire behavior simulated by FARSITE. They obtained a set of ROS adjustment factors that better represented the observed fire behavior obtaining a ROS adjustment factor of 1.5 and 2 for fuels 9 and 11 respectively, and a decreasing factor of 0.2 to the fuel type 6.

Apart from these reviews Technosylva has been constantly improving the accuracy and performance of the published fire models to better adjust the results to observed fire behavior. This includes a better definition of the fuel types, improved forecast of live fuel moisture content, modifications to the crown fire modeling initialization scheme, and automatic fire adjustment based on data assimilation techniques using ROS adjustment factor. In addition, Technosylva has implemented more than 21 additional models into the WFA platform to enhance accuracy and address known limitations of published fire models. These improvements include crown fire analysis, ember and spotting, urban / non-burnable area encroachment, consequence and impact quantification, etc. It is important to note that improvement of the fire modeling platform of choice necessitates not only improvements in mathematical algorithms but substantial improvements in the accuracy and resolution of input data sources. These work in concert to enhance the modeling and outputs to match observed and expected fire behavior. A robust operationalization of fire models requires constant and on-going research, testing, validation and implementation of both models and data sources.

2.4 Mathematical Foundation

2.4.1 Techniques, Procedures, Algorithms

Describe the mathematical techniques, procedures, and computational algorithms employed to obtain numerical solutions.



The fire propagation model in WFA is a point-punctual model where the fire characteristics at a given point (cell) only depends on the conditions at that cell (weather, terrain, vegetation). This fits well in fire simulation as most of wildfire characteristics mainly depend on local characteristics (Di Gregorio et al 2003), but excludes the effects of non-local phenomena.

The overall resolution is done using a Cellular Automata (CA) where space is discretized into cells (from 10 m to 30 m resolution), and physical quantities take on a finite set of values at each cell. The potential ROS at each cell at any time is given by the propagation models (surface and crown fire). CA models directly incorporate spatial heterogeneity in topography, fuel characteristics, and meteorological conditions, and they can easily accommodate any empirical or theoretical fire propagation mechanism, even complex ones (Collin et al. 2011)

Spotting is introduced as a random event where firebrands can be lifted and generate secondary ignition points ahead of the fire (in the direction of the wind).

The time evolution is done using a Minimum Travel Time (Fast-Marching) algorithm. This algorithm is similar to the well-known Dijkstra’s (1959) algorithm but more adapted to grids instead of the original model that uses graphs. This approach has been used with success in many forest fires propagation models like FlamMap (Finney 2002) and many others (CITES). The algorithm provides a solution of the Eikonal equation of a spreading curve subject to a given speed function $ROS(\mathbf{x})$. This is done by searching for the fastest fire travel time along straight line transects of neighboring cells in the lattice. The number of neighboring cells considered determines the angle discretization of the spreading fire. The neighborhood or degrees of freedom, u , in WFA ranges from 8 cells (Moore neighborhood) to 32 cells.

2.4.2 References to Techniques and Algorithms

Provide references to the algorithms and numerical techniques.

The Technosylva WFA platform utilizes numerous models to address specific operational requirements. These models are integrated into an extendible platform that facilitates continued improvement as R&D advancements are made. The following table lists the primary models employed on WFA :

Model	Model Reference	Notes
Surface fire	Rothermel 1972, Albin 1976 Kitral IntecChile	WFA uses the core Rothermel model for fire propagation, however it can be configured for custom versions to support any empirical or semi empirical fire model. This has been done for different models employed in other countries, i.e. Chile, Canada, etc. In this regard, WFA platform is easily extended for use in unique geographies.
Crown Fire	Van Wagner (1977,1989,1993); Finney (1998); Scott and Reinhardt (2001)	Critical surface intensity and critical ROS for crown fire initialization. Expected ROS and flame intensity.
Time Evolution	Technosylva (Monedero, Ramirez 2011)	Fast-Marching method adapted to fire simulations. Minimum Travel Time algorithm with 32 degrees of freedom.



Model	Model Reference	Notes
High-Definition Wind	Forthoffer et al (2009)	High resolution wind model obtained through the integration of the USFS WindNinja software. Note: Technosylva is also the contractor for the USFS Missoula Fire Sciences Lab. for the on-going enhancement and customization of the WindNinja software. This provides Technosylva a unique understanding of the model science foundation and implementation approaches.
Wind Adjustment Factor	Andrews 2012	Wind speed conversion with height. Based on Albini and Baughman (1979); Baughman and Albini (1980); Rothermel (1983); Andrews (2012)
Fire Shape	Andrews 2018,	Unique ellipse based solely on the effective wind speed.
Live Moisture Content	Cardil et al.	Machine learning Algorithm based on historical NDVI weather reading
Dead Moisture Content	Nelson (2002)	
Spark Modeling	Technosylva	Ignition point displacement based on wind speed
Urban Encroachment	Technosylva 2016	Includes several variations of urban encroachment algorithms developed internally to facilitate spread of fires into non-burnable urban fuels. This incorporates a distance-based friction model. Based on research publications by NIST.
Spotting	Technosylva 2019	Surface spotting model for wind driven fires. Albini (1983a, 1983b); Chase (1984); Morris (1987)
Building Loss Factor	Technosylva (Cardil xxx)	Machine Learning algorithm taking into account building conditions. Based on historical damage inspection data on buildings affected by fires over the past 13 years

Many of these models were originally published from research by the USFS Missoula Fire Sciences Laboratory. Technosylva has implemented, and enhanced these models, in addition to developing new models. Most Technosylva custom developed models are supported by journal publications as part of our corporate R&D program. Some of these models are referenced on the Technosylva web site at <https://technosylva.com/scientific-research/>. Key references are provided below for many of the models employed in the WFA platform.

- Beer, T. The interaction of wind and fire. *Boundary-Layer Meteorol* 54, 287–308 (1991). <https://doi.org/10.1007/BF00183958>



- Cruz Miguel G., Alexander Martin E. (2010) Assessing crown fire potential in coniferous forests of western North America: a critique of current approaches and recent simulation studies. *International Journal of Wildland Fire* 19, 377-398.
- Cruz, Miguel G.; Alexander, Martin E. (2013). Uncertainty associated with model predictions of surface and crown fire rates of spread. *Environmental Modelling & Software*. 47: 16-28.
- Scott, J.H. 2006. Comparison of crown fire modeling systems used in three fire management applications. USDA For. Serv. Res. Pap. RMRS-RP-58.
- Scott, J.H., and Reinhardt, E.D. 2001. Assessing crown fire potential by linking models of surface and crown fire behavior. USDA For. Serv. Res. Pap. RMRS-RP-29.
- Bennett, M., S.A. Fitzgerald, B. Parker, M. Main, A. Perleberg, C.C. Schnepf, and R. Mahoney. 2010. Reducing Fire Risk on Your Forest Property. PNW 618: 40 p.
- Fire Science Core Curriculum. 2017. OSU Extension Service, EM 9172: 197p
- Gould, James. (1991). Validation of the Rothermel fire spread model and related fuel parameters in grassland fuels. *Proceedings of the Conference on Bushfire Modelling and Fire Danger Rating Systems*. 51-64.
- Di Gregorio, Salvatore & Bendicenti, E.. (2003). Simulations of Forest Fires by the Cellular Automata Model.
- J. Glasa and L. Halada. On elliptical model for forest fire spread modeling and simulation. *Mathematics and Computers in Simulation*, 78(1):76–88, 2008.
- T. Ghisu, B. Arca, G. Pellizzaro, and P. Duce. A level-set algorithm for simulating wildfire spread. *CMES Computer Modeling in Engineering & Sciences*, 102(1):83–102, 2014
- Dijkstra, E. W. (1959). A note on two problems in connection with graphs. *Numerische Mathematik*, 1(1), 269–271.
- Finney, M A, (2002). Fire growth using minimum travel time methods. *Canadian Journal of Forest Research*, 1420-1421, 32(8)
- Sanders, Kristen A., "Validation and calibration of the FARSITE fire area simulator for Yellowstone National Park" (2001). *Graduate Student Theses, Dissertations, & Professional Papers*. 3990. <https://scholarworks.umn.edu/etd/3990>
- A. Collin, D. Bernardin & O. Séro-Guillaume (2011) A Physical-Based Cellular Automaton Model for Forest-Fire Propagation, *Combustion Science and Technology*, 183:4, 347-369,
- Zigner, K.; Carvalho, L.M.V.; Peterson, S.; Fujioka, F.; Duine, G.-J.; Jones, C.; Roberts, D.; Moritz, M. Evaluating the Ability of FARSITE to Simulate Wildfires Influenced by Extreme, Downslope Winds in Santa Barbara, California. *Fire* **2020**, 3, 29. <https://doi.org/10.3390/fire3030029>
- Phillips, Ross J.; Waldrop, Thomas A.; Simon, Dean M. 2006. Assessment of the FARSITE model for predicting fire behavior in the Southern Appalachian Mountains. *Proceedings of the 13th biennial Southern Silvicultural Research Conference*. Gen. Tech. Rep. SRS-92. Asheville, NC: U.S. Department of Agriculture, Forest Service, Southern Research Station: 521-525

2.4.3 Equations and Implementation

Present the mathematical equations in conventional terminology and show how they are implemented in the code.

Summary



The mathematical model used to simulate surface fire spread is the model developed by Rothermel (1972) with some modifications from Albini (1976) and some minor adjustments from Technosylva. It accepts the initial 13 fuel models (Anderson 1982) as well as Scott and Burgan’s (2005) dynamical fuels where there is a transfer load between the herbaceous and dead classes. Among other outputs this model provides the surface fire rate of spread, flame length and flame intensity in the direction of maximum spread (head front). Crown fire is implemented using the model developed by Van Wagner (1977,1993) which computes the transition viability to crown fire, as well as the expected ROS and intensity in active crown fires. Spotting is modeled as a pseudo random event. The maximum expected spotting distance from the fire is obtained using the wind-driven model developed by (Albini 1983a; Albini 1983b; Chase 1984) and then embers are generated randomly on the front of the fire and the actual traveled distance is computed also randomly based on the maximum distance available. In this modeling there is no tracking of individual embers in the air. Wind speed profiles at different heights (2m, 10m, 20ft) are obtained through a logarithmic wind profile found in Andrews (2012). Fire is assumed to spread following an elliptical shape only dependent on the effective wind speed (Andrews 2012). The time evolution is done using a Fast-Marching method on a regularly spaced landscape grid of a Cellular Automata.

Surface Fire

The default propagation engine implemented in WFA is Rothermel's (1972) surface model with the modifications proposed by Albini (1976) and the requirements to accept Scott and Burgan (2005) fuel models. The basic equation in the model predicts the heads fire rate of spread without wind or slope:

$$R_0 = I_R \xi / \rho_b \epsilon Q_{ig}$$

Here I_R is the reaction intensity (energy released rate per unit area of the fire front), ξ the propagating flux ratio, ρ_b the bulk density, ϵ the effective heating number, and Q_{ig} the heat of ignition. The equation is derived by applying the energy conservation to a unit volume of fuel ahead of a steadily advancing fire in a homogeneous fuel bed. In this model, the ROS may be viewed as the ratio between the heat flux received by the unburned fuel ahead of the fire (numerator) and the heat required to ignite it (denominator).

The input parameters to compute the ROS in the case of no wind or slope are the moisture content and the characteristics of the vegetation. Moisture content is given by the 1h, 10h and 100h dead moisture content, and the woody and herbaceous live moisture content. Fuels are assumed to be a mixture of different vegetation types depending on their class (dead or live) and size (less than 0.25 inch, 0.25-1 inch, 1-3 inch), with each class having different surface to volume ratio and loads. The inputs required to define a fuel type is given in the following table:

			LOAD				SAV					
Fuel	1h	10h	100h	herb	woody	1h	herb	woody	Dyn	Depth	MoistExt	heat

Table: input variables for each fuel type.

Here Dyn (dynamic) is a boolean variable to define if there should be a transfer between the herbaceous load and the dead one based on the herbaceous content. In general, SAV values (the fineness of the



fuel) strongly affects the ROS and flame length of the fire, while the fuel load does not affect the rate of spread but can have a strong effect on the flame length.

The effect of wind and slope can be incorporated in the model through a couple of dimensionless parameters depending on the midflame wind speed U and the terrain angle θ :

$$ROS = R_0 (1 + \Phi_w + \Phi_s)$$

with

$$\Phi_s = 5.275 \beta - 0.3 (\tan \theta)$$

$$\Phi_w = C * U^B (\beta / \beta_{op})^{-E}$$

Where β_{op} and β are the optimum and standard packing ratios respectively, and C , B , and E are parameters depending on the surface to volume ratio σ :

$$C = 7.47 * \exp(-0.133 \sigma^{0.55});$$

$$B = 0.02526 \sigma^{0.54}$$

$$E = 0.715 * \exp(-0.000359 * \sigma)$$

The slope and wind factors are summed together to obtain the final ROS. If they are not aligned the resultant vector defines the direction of maximum spread (which will be between the direction of wind and the direction of slope). This final slope-wind factor can also be used to compute an equivalent or effective wind speed causing the same effect as the combined effect of wind and slope. To do that we simply inverse the equation of the wind factor to obtain:

$$U_e = [\Phi_w (\beta / \beta_{op})^E / C]^{-1/B}$$

The Rothermel model predicts fire characteristics (ROS, flame length, etc) only in the direction of maximum spread (head front) obtained from the combined effect of wind and slope. To compute the ROS in a direction different from the direction of maximum spread, and to be able to use the model in a 2D landscape it is assumed that a free burning fire perimeter from a single ignition point has an elliptical shape. There are several different approaches to compute the ellipse (or ellipses) eccentricity based on wind and slope (Albini [2], Anderson 1983 [6], Alexander, etc). The present implementation follows the equations in Andrews (2008) depending on the effective wind speed U_e in mi/h in the direction of maximum spread. The length to width ratio is given by:

$$L/W = 0.1 + 0.25 U_e$$

Or equivalently the eccentricity e is given by

$$e = (Z^2 - 1)^{0.5} / Z$$

so that the ROS in any direction ϕ is given by

$$ROS(\phi) = ROS (1 - e) / (1 + e)$$

One of the most important variables of fire is the amount of heat it generates as this is the main contributor to fire spread and fire severity. The amount of heat can be measured using different variables like the reaction intensity (IR), the Heat per Unit Area (HPA) or the fireline intensity. The Reaction intensity is the rate of energy release per unit area within the flaming front (with units of energy/area/time), heat per unit area is the amount of heat energy released per unit area within the



flaming front (units of energy/area), fire line intensity is the rate of heat energy released per unit time per unit length of the fire front (units of energy/distance/time). Fireline intensity is independent of the depth zone and It is calculated as the product of the available fuel energy and the ROS of the fire (Byram 1959):

$$I_b = HA \cdot ROS$$

Where The heat per unit area depends on the reaction intensity of the fire (IR) and the time that the area is in the flaming front (residence time tr)

$$H_A = I_R \cdot tr = 384 \cdot I_R / \sigma$$

In this model the flame length and Byram's intensity are closely related by:

$$FL = 0.45 I^{0.46}$$

Where the flame length is in feet and the intensity in Btu/ft/sc.

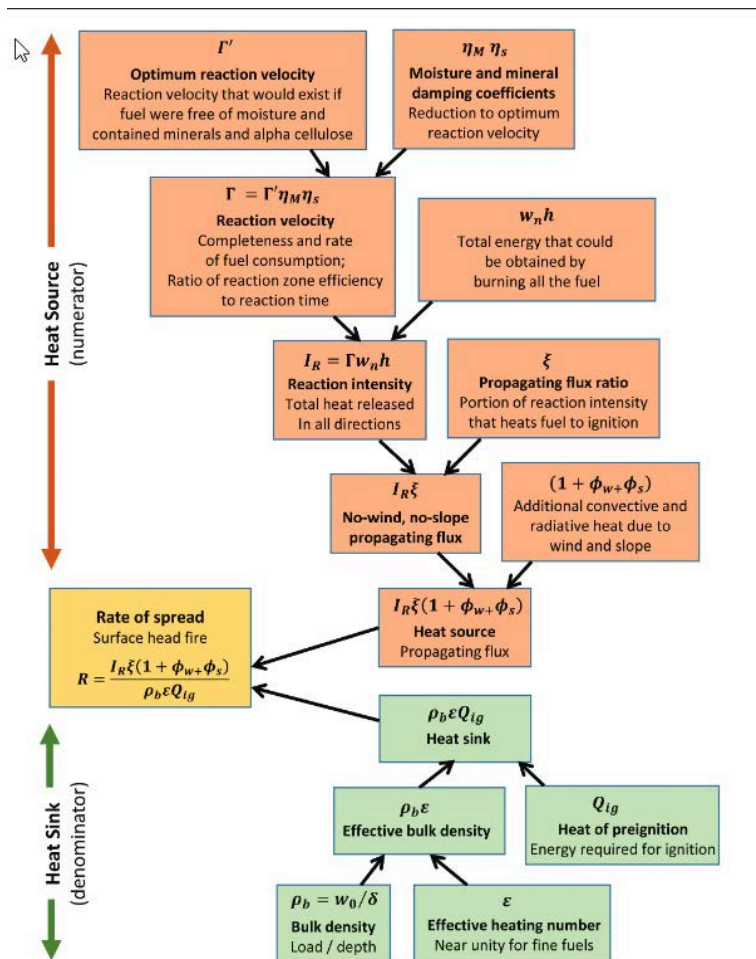

Fig X: Flow of Calculation provided in Andrews (2018)



For a much more in-depth discussion of the Rothermel surface model please read Andrews (2018) and Rothermel (1972).

Crown fire

Crown fires burn forest canopy fuels. They are usually generated by surface fires and represent a major change in fire behavior due to an increased rate of spread and heat released. Crown fires can be passive, active or conditional based on the capacity of the surface fire to move into areal fuels, and to the capacity of the burning canopy to move between individual trees.

Crown fire initiation occurs when the surface fire provides enough heat to raise the temperature of the canopy fuel to ignition temperature. In Van Wagner (1977) model, this minimum intensity is given by:

$$I_{ini} = (0.01 * CBH (460 + 25.9 FMC))^{1.5}$$

Where CBH is the canopy base height (m) and FMC is the foliage moisture content of the canopy cover. Foliar moisture content (FMC) is usually not known, but it is assumed that for most species old foliage should be around 100 percent and this value has been used as a default value when no other information is available (Scott 2001). This approach however does not consider any known humidity conditions of the site and in WFA the FMC is computed based on the 100h moisture content as follows:

$$FMC = 75 + 2 \cdot m100h$$

Once the fire has transitioned to the canopy it is necessary to have a critical mass-flow rate for the fire to be self-sustained. Vang Wagner found this critical mass to be 0.05 kg m⁻² sec⁻¹ (Scott 2001) which can be used to determine a minimum crown fire rate of spread only dependent on the Canopy Bulk Density (CBD) and given by

$$R_{active} = 3 / CBD$$

Other existing models not used in WFA are Alexander (1998) which is very similar to Van Wagner (1977) but includes additional inputs like flaming residence time, plume angle and fuel bed characteristics, Cruz et al. (1999) fire transition model, and Cruz et al. (2002) crown fire spread model given by:

$$ROS = c1 U^{c2} CBD \cdot C3 \cdot e^{c4 \cdot EFM}$$

Where U is the wind at 10m, CBD the canopy bulk density, EFM is the fine dead moisture content, and C1, C2, C3, C4 are a set of regression coefficients.

The model for the ROS of crown fires was computed by Rothermel (1991) through a linear regression between observed crown ROS and the surface fire model. It states that the crown fire of an active ROS is 3.34 times the rate of spread of the surface model 10 assuming a 0.4 wind reduction factor.

$$R = 3.34(R_{10})_{40\%}$$

Based on these conditions, crown fire may be classified as:

- Surface fire if neither the intensity nor the minimum crown ROS is met
- Passive Crown fire (torching): Fire spreads through the surface fuels, occasionally torching overstory trees. Overall ROS is that of the surface fire.
- Conditional Crown: Fire cannot transition to crown, but active crown fire is possible if there was a fire transition to crown by other means
- Active Crown: Fire spreads through the overstory tree canopy if both conditions are met



Fire Type		Active crown fire?	
		No	Yes
Transition to crown fire?	No	Surface	Conditional Crown
	Yes	Torching	Crowning

Crown fire classification as shown in BehavePlus

Van Wagner’s crown fire transition and propagation models are well known and used operationally but have shown to have a significant underprediction bias when used in assessing potential crown fire behavior in conifer forests of western North America (Cruz et al. 2010). To try to correct this bias Technosylva has introduced two new parameters in the model that have been adjusted based on the analysis carried out by the scientific team using data from the last two fire seasons in California. The model introduces two new parameters 1) a crown factor multiplier for the Canopy Bulk Density (CBD) which decreases the minimum crown ROS required to have an active crown fire, and a factor that forces a smooth transition between the surface and the crown fire behavior. The final ROS of the overall fire when crown fire type is conditional or crowning is a weighted average of surface and crown ROS

$$ROS = surfROS * (1 - \alpha) + \alpha * crownRos$$

Where the value α ranges from 0 to 1 and depends on the **active ratio** in the following way:

$$\alpha = activeRatio^{1/smoothFactor}$$

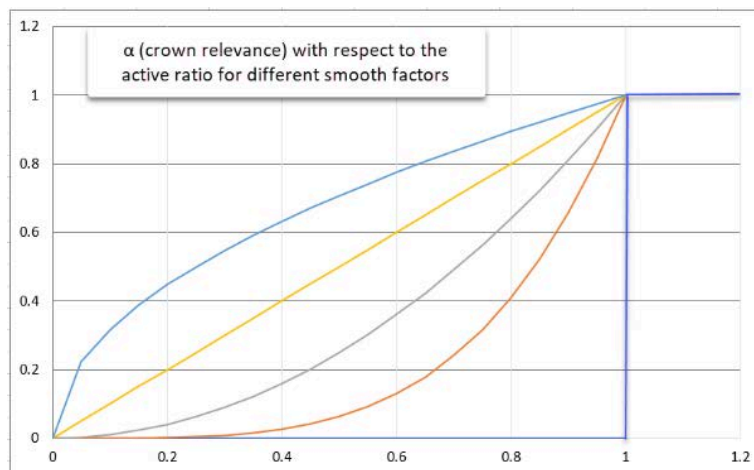

Example effect of the smooth factor (0 blue, 0.25 red, 0.5 gray, 1 yellow) in the crown contribution for active ratios lower than 1

At present, with WFA the crown CBD factor is set to 1.2 and the smooth factor to 0.4. This approach to provide a gradual transition in the fire’s rate of spread (and flame length) from the initial onset of crowning similar to the crown fraction burned (CFB) (Alexander 1998) used in other modeling systems like FlamMap, FARSITE or Nexus, with the main difference being the smoothing function itself. Cruz et al. observes that there is no evidence of such a smooth transition between surface and crown fire regimes in the experimental data but rather an abrupt transition is observed far more commonly. In our context, however, where the main aim is to produce a forecast risk and not to simulate an individual fire we



consider that it is important to reflect the fact that the fire conditions are close to generate an active crown fire.

For a more in-depth discussion of the crown fire models please read Cruz et al (2010) Scott et al. (2006)

Wind adjustment factor

Fire simulations require wind speed at midflame to compute surface fire spread and at 20ft to compute crown fire characteristics. To convert the wind between the two heights, WFA uses the wind adjustment factor (WAF) found in Andrews (2012) and implemented in the software BehavePlus and Farsite. The model is based on the work of Albini and Baughman (1979) and Baughman and Albini (1980), using some assumptions made by Finney (1998). This implementation considers two different models for sheltered and unsheltered conditions from the overstory. As described in Andrews (2012), the unsheltered WAF is based on an average wind speed from the top of the fuel bed to a height of twice the fuel bed depth. The sheltered WAF is based on the assumption that the wind speed is approximately constant with height below the top of a uniform forest canopy. Sheltered WAF is based on the fraction of crown space occupied by tree crowns. The unsheltered WAF model is used if crown fill portion is less than 5 percent. Midflame wind speed is the 20-ft wind multiplied by the WAF.

Unsheltered WAF depends on the surface fuel bed depth (in feet):

$$WAF = \frac{1.83}{\ln \ln \left(\frac{20+0.36H}{0.13H} \right)}$$

Sheltered WAF:

$$WAF = \frac{0.555}{\sqrt{fH} \ln \ln \left(\frac{20+0.36H}{0.13H} \right)}$$

With H, the canopy height, and f, the crown fill portion, depending on the canopy cover (CC) and the crown ratio (CR):

$$f = CC * CR / 3$$

$$CR = (CH - CBH) / CH$$

CR is the ratio of the crown length to the total height of a tree.

Time evolution

The fire models can predict the potential ROS of the front at any point and direction but are not able to compute the evolution of the fire perimeter in time. The main models to do that are:

- 1) Using Huygens principle of wave propagation like in Farsite (xxx) and discretizing in time
- 2) Using a Minimum Travel Time Algorithm or Fast Marching method, and discretizing in space
- 3) Using the more general but usually slower Level Set Method.

In the context of wildfires, Huygens principle states that each point on a fire front is in itself the source of an elliptical wavelet (fire) which spreads out in an independent way in the forward direction. This approach is numerically solved by splitting the perimeter into a set of nodes, computing the evolution of those nodes in the direction normal to the perimeter based on the ROS given by the propagation model and a given time steps, and then reconstructing the front based on the position of the transported nodes. The main weakness of vector-based approaches is the need for a computationally costly algorithm for generating the convex hull fire-spread perimeter at each time step, especially in the



presence of fire crossovers and unburned islands (Ghisu et al. 2014). Raster based implementations are computationally more efficient (Glasa et al. 2008), but can suffer from significant distortion of the produced fire shape if the number of neighboring cells considered (number of possible spread directions) is low.

Spotting

Wildfires can create powerful updrafts which launch burning firebrands into the atmosphere, these firebrands are then carried horizontally by the wind landing some distance downwind from the source and creating a new ignition. Due to its unpredictable nature, fire-spotting modeling, here, is considered through a statistical approach.

Encroachment

Encroachment is a critical component in the WFA fire modeling simulations as it affects the number of buildings, assets, facilities and population impacted. It does not have a relevant effect on other impact metrics. To take advantage of enhanced algorithms for spread encroachment using adjacent fuels and fire behavior data, the non-burnable (and especially urban) fuel classification needed to be updated to provide better granularity and characterization of the type of urban/WUI. Accordingly, to test these methods an enrichment of the current fuels data was developed by Technosylva to delineate urban fuels into different types of urban and also a level of density of buildings. This enhancement of the basic Scott and Burgan fuel models is used in combination with enhanced encroachment algorithms to more accurately calculate potential impacts to buildings and population.

Urban areas have been classified into classes depending on their structure (roads, urban core, isolated, sparse) and their surrounding fuels, characterized as high versus low fire behavior fuels). Specific encroachment factors can then be applied to each grouping.

Spark Modeling

Electrical failures can cause sparks and produce an ignition meters away from the asset location. To take this into account, the WFA allows the ignition point location to be displaced if the underlying vegetation type is either non-combustible or WUI. This displacement is in the direction of the wind and is proportional to the wind speed. The displacement distance and wind speed algorithm has been developed using expert opinion from electric utility engineers familiar with asset failure and ignition probability.

Weather

WFA requires historical daily weather data to run the fire simulations. The minimum required variables are the wind speed at 10m, the dead moisture content, and the live moisture content. More explicitly:

- Northward 10m wind speed
- Eastward 10m wind speed
- Dead moisture content 1hr
- Dead moisture content 10hr
- Dead moisture content 100hr
- Herbaceous moisture content



- Woody moisture content

The dead moisture may be given by the client or may be computed based on the Nelson model. Similarly, the herbaceous moisture content may be provided by the client or may be computed using Technosylva's Machine Learning algorithm based on historical NDVI weather reading. The Technosylva DFM model has been developed to meet customer needs using the latest modeling approaches. The input wind speed required by the propagation model is 20ft; to convert the initial 10m wind speeds to 20ft, we use a logarithmic profile from Andrews (2012) leading to a 13% wind speed reduction.

Weather data is obtained from the Weather Research and Forecasting (WRF) Model weather forecast data. The forecast weather has a 2 km resolution which can lead to sharp changes in weather conditions between neighboring cells. In order to increase accuracy and meet the underlying 30m cell size resolution of the fuels data, weather data is interpolated spatially using a bilinear interpolation scheme. The smoothing of the source weather data ensures that integration with the wildfire behavior models results in outputs that do not have hard edges in the data.

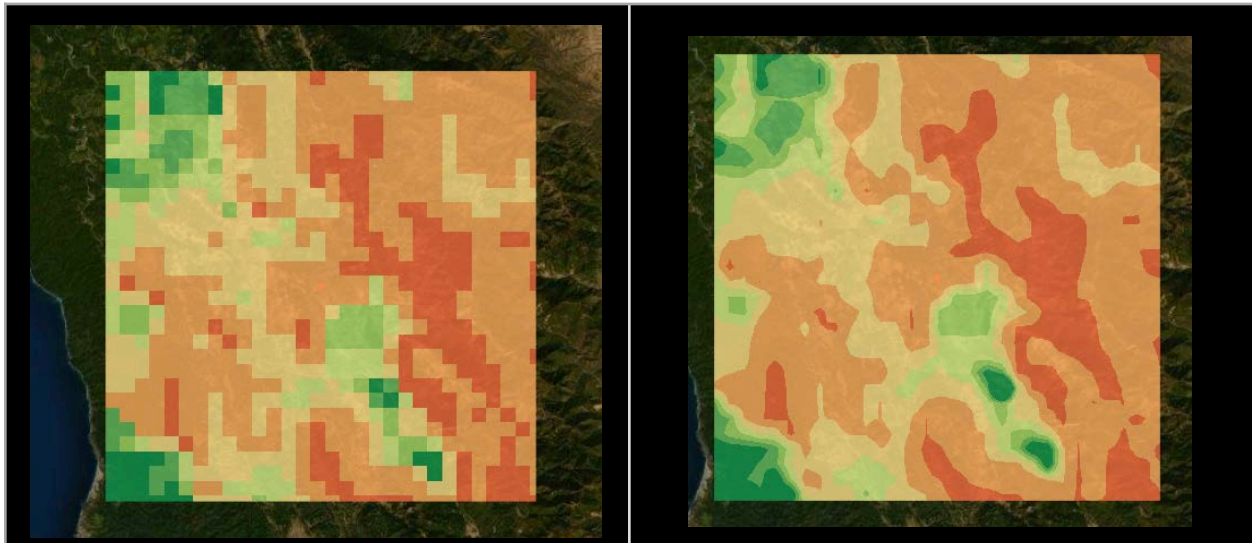

Left: Initial weather definition. Right interpolated weather definition

Impact and consequence value calculation

Wildfire spread modeling is undertaken with asset ignition locations to derive potential impacts. The output impact values (risk metrics) are assigned back to the asset ignition point location. Using this approach allows us to differentiate between the risk output associated with different assets (and their ignition locations) using the same weather data although weather values may vary based on spatial location and time of day (hourly). For both operational and mitigation applications, the wildfire spread modeling is conducted using High Performance Computers (HPC) and typically involves hundreds of millions of spread simulations. The amount of simulation will vary depending operational use with daily forecasts versus mitigation planning use with hundreds of weather scenarios.

The main goal for the WFA simulations is to create a forecast risk associated to each ignition point and surrounding area. This is done by running individual simulations and associating the following main risk metrics back to each ignition point. The following baseline risk metrics are calculated from the spread simulations



- Acres Burned (referred to as Fire Size Potential)
- Number of Buildings Threatened
- Estimated Number of Buildings destroyed
- Population impacted

Numerous conventional fire behavior outputs are also calculated, the most important being:

- Rate Of Spread (ROS)
- Flame Length (FL)
- Fire Behavior Index (FBI) – combination of ROS and FL

2.4.4 Limitations (see Guide ASTM E 1895)

Identified the limitations of the model based on the algorithms and numerical techniques.

The Technosylva WFA platform is an integration of numerous speciality models designed to address specific scientific requirements and methods.

The following assumptions applied to the models used in WFA:

- The physical framework development is based on an idealized situation in steady state spread
- Rate Of Spread at a point only depends on the conditions at that point (point-functional models). This means that there is no increase in speed due to non-local contributions of the fire front.
- Fire model is not directly coupled with the atmosphere. Fire will not modify local atmosphere. However, this is being addressed with seamless integration with the WRF-SFIRE model in development at San Jose State University, Wildfire Interdisciplinary Research Center. WRF-SFIRE is an option available to WFA customers to address specific convection based fire scenarios.
- Fire is always assumed to be fully developed with fire acceleration, flashover, or decay not being considered.
- Atmospheric instability, which may have a deep impact on ROS (Beer 1991), is not considered in the model in any way.
- Gusts are not considered in the model
- No interaction between slope and wind other than creating an effective or equivalent wind. This means that fire is assumed to have an elliptical shape no matter the alignment of wind and slope.
- Experimental data is scarce and the empirical adjustment of models have been based on wind tunnel experiments and a few well documented fires
- Fuel array description of the vegetation may not perfectly describe fuel characteristics.
- Spotting is only considered in surface fires

2.5 Data Libraries

Provide background information on the source, contents, and use of data libraries.

This section provides a brief summary of the key input datasets required for wildfire behavior analysis and risk analysis. The following categories of input data are:

1. Landscape characteristics
2. Weather and atmospheric data



3. Fuel moisture
4. Values at risk (highly valued resources and assets)
5. Possible ignition sources
6. Fire activity

2.5.1 Landscape Characteristics

This includes a range of possible data that describe the characteristics of the landscape. The most important data are related to surface and canopy fuels, and vegetation. There are many publications available that describe these datasets, many from the USFS Missoula Fire Lab. Most use the Scott & Burgan 2005 Fuels Model Set standard for classification of fuels data.

Standard fire behavior analysis input layers are:

1. Terrain – elevation, slope, aspect
2. Surface fuels (Scott & Burgan 2005)
3. Canopy fuels
 - a. Canopy height
 - b. Canopy base height
 - c. Canopy bulk density
 - d. Canopy closure
4. WUI and Non Forest Land Use classes (Technosylva, 2020)

2.5.2 Surface and Canopy Fuels

For these layers, data developed by Technosylva is used. Technosylva provides an annual fuel updating subscription where initial fuels is developed using advanced remote sensing object segmentation methods using high resolution imagery, available LiDAR & GEDI, and other standard imagery sources, such as NAIP, Sentinel 2 and Landsat. This is supplemented with in-the-field surveys to verify the fuels for possible areas of concern and to validate the fuels classification. Surface and canopy fuels data is critical for accurate fire behavior modeling, so it is paramount that this data is up-to-date, and when used, results in the observed and expected fire behavior.



Survey Date

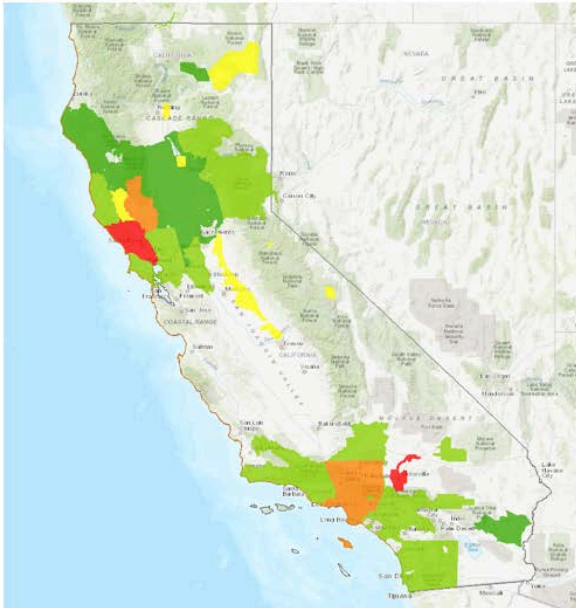

Summary

- 2019 → 14,906,880 ac
- 2018 → 26,874,880 ac
- 2017 → 4,423,040 ac
- 2016 → 6,377,600 ac
- 2013 → 2,319,360 ac

Point Cloud Density

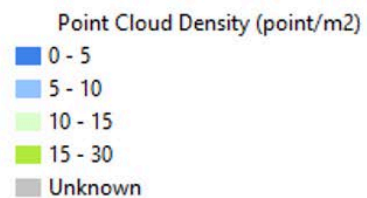
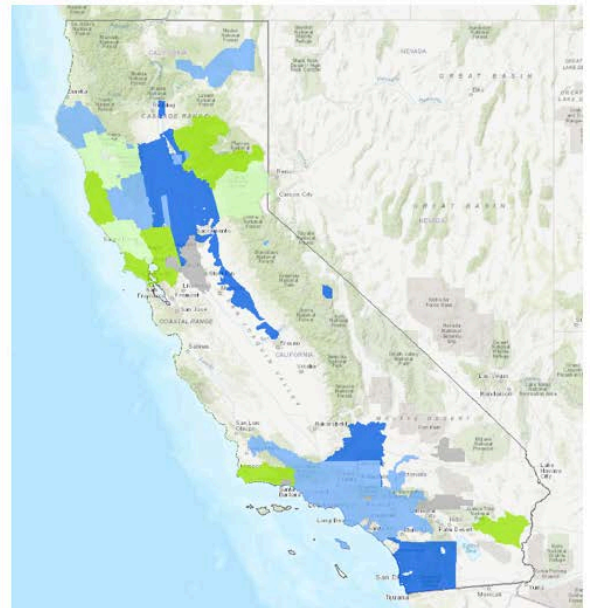

LIDAR Data used for Technosylva Fuels 2021, with capture date and points density

Surface and canopy fuels are updated throughout the year, to accommodate changes to the fuels, typically monthly during fire season. This ensures that all major disturbances, such as fires, urban growth, landslides, etc. are updated in the fuels data. A variety of methods, including burn severity analysis, are used to update the fuels. Up to date fuels data is critical to ensuring the fire behavior outputs from our modeling are accurate, as it is a key input into risk analysis.

Technosylva continually tests new fuels datasets that become available from other sources, such as LANDFIRE, federal risk assessment regional projects, and independent sources, such as the California Forest Observatory data. Unfortunately, the publicly available data does not perform at the level required when confronted with operational testing. In general, these publicly available data do not result in fire behavior outputs that facilitated accurate predictions. Ultimately with any fuels dataset, the quality and accuracy of the fuels is measured on whether it produces 'observed and expected fire behavior'. Fortunately, Technosylva is able to test this data, and other fuels data including their custom data, operationally on a daily basis with CAL FIRE and the IOUs against active wildfires to see how it performs.



Updates to the fuels, and algorithms that use the fuels data for fire behavior modeling are on-going with us, as we continue to enhance the data and algorithms to match observed fire behavior across the state. These methods and algorithms are proprietary.

WUI and Non-Forest Fuels Land Use classes are based on a Technosylva proprietary method that characterizes WUI and other land uses classes that have been a typical limitation of the Scott and Burgan classification, as they are defined in general non burnable classes. In combination with the Surface Fuels, this provides a solid foundation for fire behavior and impact analysis.

The following two figures present an example of publicly available LANDFIRE data commonly used for fire modeling, and the custom Technosylva fuels used.

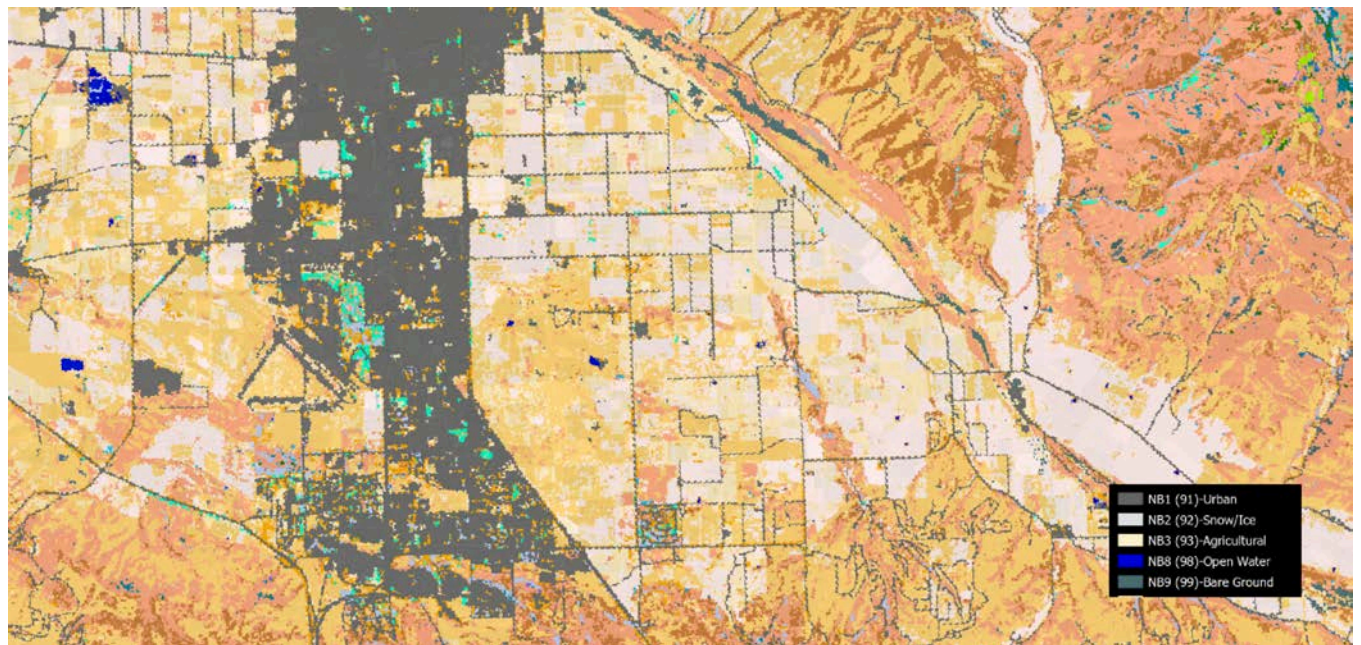

LandFire Fuels – Non Burnable Classes

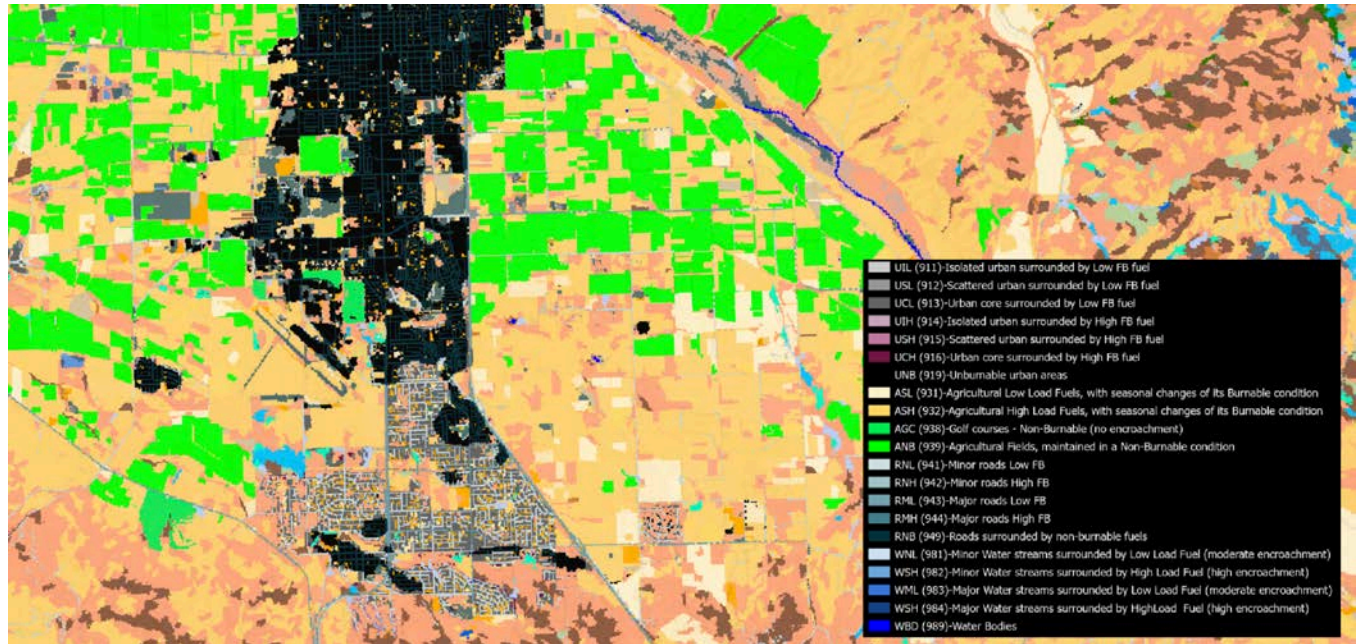

Technosylva Fuels Dec 2021 – WUI and Non-Forest Fuels Classes

2.5.3 Weather and Atmospheric Data

WRF data is developed using third party weather and predictive services experts available through commercial providers. Data is 2 km spatial resolution and hourly (temporal) for a multi-day period, up to five+ days. Multiple forecasts are generated daily.

Weather observation data can also be used along with, or independently, to support fire behavior analysis. This data is typically available through published weather stations on MesoWest, or through commercial providers, such as Synoptic. The methods of how this data can be integrated within the Technosylva software and processes is proprietary.

The following figure shows a typical 2km WRF model of wind speed overlaid with weather stations data (WFA software example).



Predicted (WRF model) and Observed Wind (Weather Stations, Synoptic)



2.5.4 Fuel Moisture

Fuel moisture data is also a key input into fire behavior modeling. Fuel moisture can be characterized as either Dead or Live fuel moisture. Standard methods for measuring and quantifying fuel moistures are well documented in publications by the USFS Missoula Fire Lab and other research agencies.

However, to date the ability to accurately predict live and dead fuel moistures at high resolution has been limited. Only a few IOUs and commercial vendors are producing daily estimates that can be integrated into fire modeling. Technosylva produces both a dead and live fuel moisture data product that combines historical and current sample data with remotely sensing imagery in a machine learning model to estimate daily data products. These methods are proprietary although they are substantiated with several publications and on-going collaboration between the IOUs, Technosylva and fire weather and behavior research agencies. This fuel moisture data product is used by CAL FIRE and several IOUs across seven western US states.

The following figure shows the Technosylva Dead Fuel Moisture overlaid with weather stations data (WFA software example).

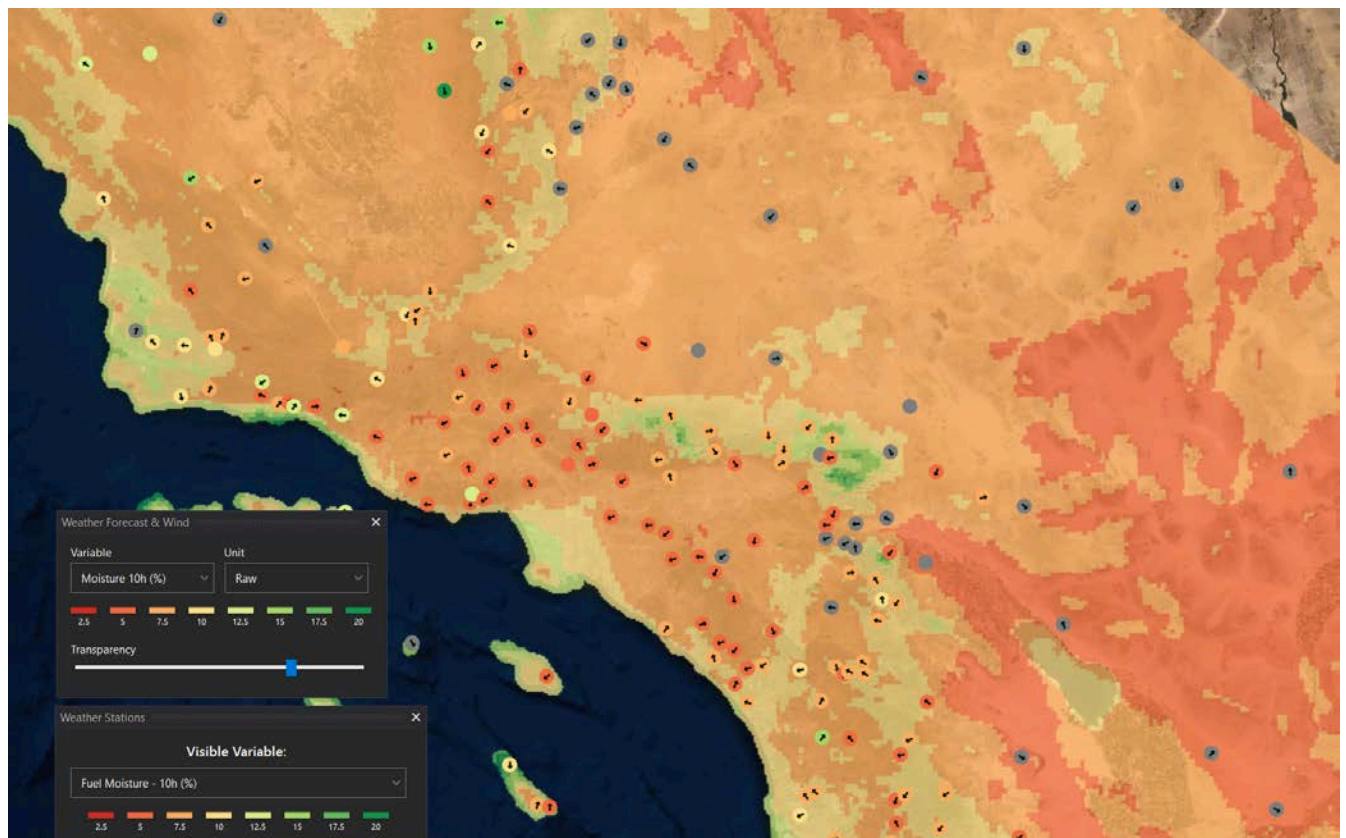

Predicted (WRF model) and Observed 10-hr Fuel Moisture (Weather Stations, Synoptic)



2.5.5 Values at Risk

Values-at-Risk data reflects the resources and assets that exist across that landscape that we are concerned about. Typically, ‘resources’ refers to natural items while ‘assets’ refers to man made items. Wildfire modeling is used to identify the “risk” associated with resources and assets, with risk representing the possibility of loss or harm occurring due to wildfire.

VAR data is typically characterized into public safety or financial impacts. Technosylva IOU customers use similar input datasets for VAR, such as population count (location), building footprints, and critical facilities. A variety of datasets exist to define the location and characteristics of these VAR, each with varying temporal and spatial accuracy. Census data is a common source for population data along with ORNL LandScan data (population count). LandScan has become a de facto standard for static wildfire risk assessments across the Nation in the past 10 years. It is available through the Dept. of Homeland Security HSIP program for certified vendors of government agencies, or the agencies themselves. It is typically updated every 2 years with a 90 meter spatial resolution of population count. Technosylva currently uses the latest 2021 LandScan data for calculating population impacts.

The Microsoft Buildings Footprint dataset is a publicly available free data source used as a starting point by many vendors and agencies. Technosylva has taken this data and updated it using local high resolution imagery data sources to enhance the data. The original Microsoft data is a good starting point, however it does have holes with missing data and some misrepresentation of buildings with natural features. This data was updated in 2020 by Microsoft. This provides the primary source for the buildings data used by Technosylva.

Population and buildings are the two primary datasets used as input into wildfire risk analysis, although most IOU customers add confidential data to derive more detailed consequence metrics. These are proprietary to the IOUs and cannot be shared by Technosylva.

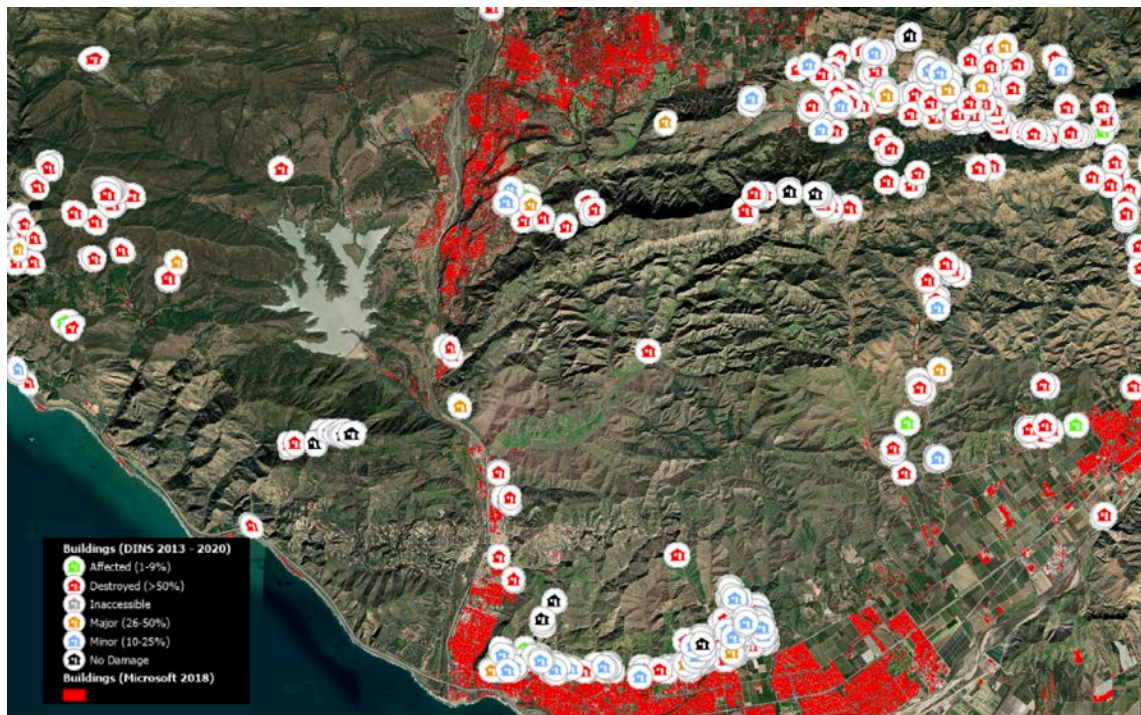



Buildings (Microsoft 2020) and Damaged Inspections data (DINS) from CAL FIRE

2.5.6 Possible Ignition Sources

Wildfire ignition data varies greatly depending on the organization and purpose of the wildfire risk analysis. Traditionally, agency driven risk assessments will use historical fire location data to create Historical Fire Occurrence datasets, reflecting ignition density over a specific time period. This data is obtained from federal and state fire reporting systems.

IOUs are often concerned with using their assets as possible ignition sources, in equipment failure scenarios or extreme weather events, where a spark from an electric utility asset may cause a fire ignition. Risk can be assessed related to the probability of ignition for electric utility assets, or more commonly with the potential spread and impacts of a wildfire ignited by an asset. Technosylva provides integration of both ignition and spread analysis to derive risk metrics using VAR data. This focuses on assigning possible consequence back to the electric utility assets to identify those assets more prone to having significant impacts should a wildfire ignite. Different proprietary methods exist to integrate and model probability of ignition data for electric utility assets with consequence modeling. Referred to as “asset wildfire risk” this information can be used to support operational decisions, such as PSPS, resource allocation and placement, and stakeholder communication, in addition to short and long term mitigation planning efforts, reflected in IOU WMPs. The weather and fuels inputs will vary depending on the purpose of these risk analyses.

IOUs and agencies are also concerned with non-asset wildfire ignitions and the risk associated with these ignitions due to possible spread and potential impacts. Technosylva has developed proprietary methods for deriving territory wide risk that integrates millions of possible ignition points with wildfire spread modeling to derive standard risk outputs, similar to “asset risk” metrics. These output metrics vary greatly depending on the customer and purpose for using the risk data. The methods and outputs are proprietary.

2.5.7 Fire Activity

The fire activity data used to support operational situational awareness is captured from different sources:

- VIIRS and MODIS Satellite hotspots, from public sources (FIRMS)
- GOES 16 and 17 data based on agreement with providers to the IOUs
- Lighting data also from IOU’s providers
- Fire Perimeters from Open Wildfire data from NIFC
- Fire activity from National Guard data from Fire Guard program
- Alert Wildfire Cameras integration

The following figure shows an example of Fire Activity data integrated into the Technosylva WFA system. All data is temporal and displayed color coded based on a selected time from the software timeline.

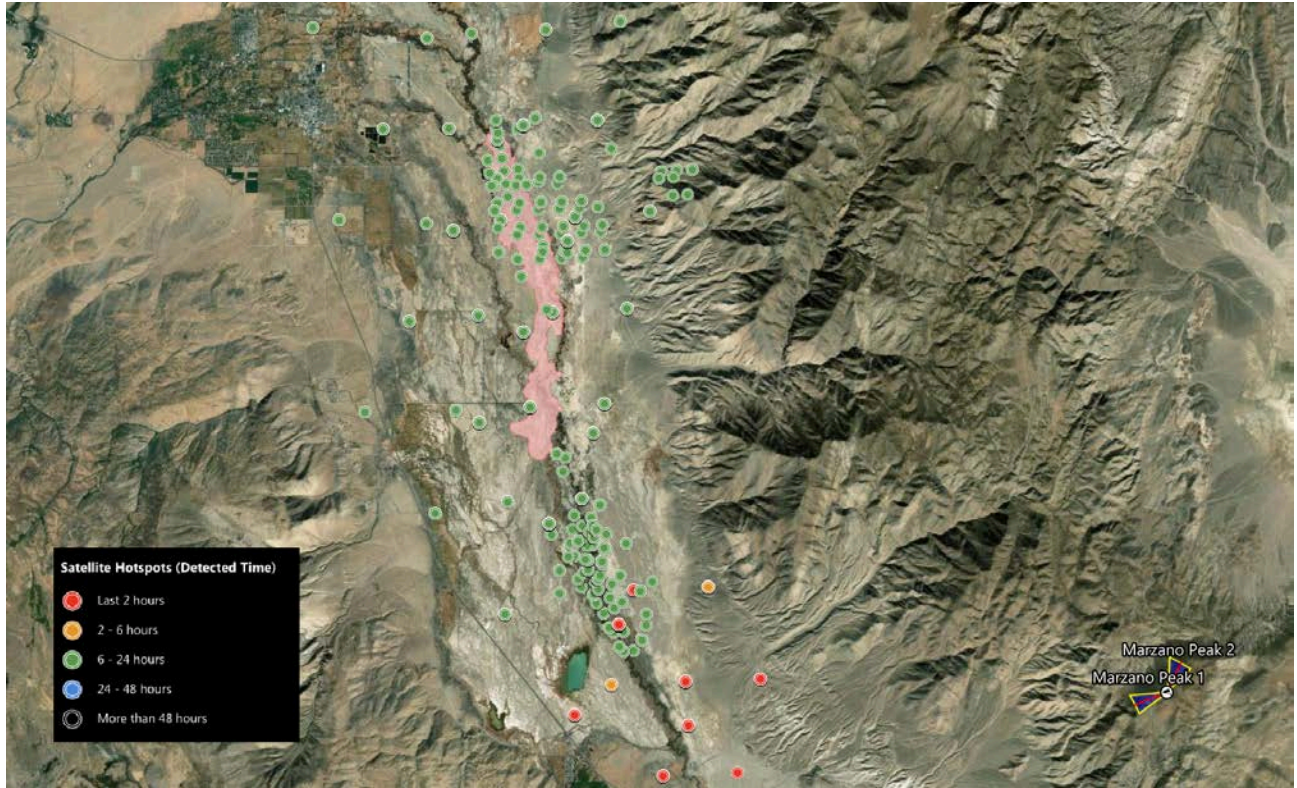

Hotspots, Fire Perimeters and Alert Wildfire Cameras

2.5.8 Summary of Input Data Sources

The following table presents a summary of the data sources used in the wildfire risk analysis. Some data varies slightly depending on mitigation versus operational use.

DATASET	SPATIAL RESOLUTION (meters)	TEMPORAL RESOLUTION	DATA VINTAGE	SOURCE
Landscape Characteristics				
TERRAIN	10	YEARLY		USGS
SURFACE FUELS	30/10	PRE FIRE SEASON, MONTHLY UPDATE IN FIRE SEASON, END OF FIRE SEASON	2020	TECHNOSYLVA
WUI AND NON FOREST FUELS LAND USE	30/10	TWICE A YEAR	2020	TECHNOSYLVA
CANOPY FUELS (CBD,CH,CC,CBH)	30/10	PRE FIRE SEASON, MONTHLY UPDATE IN FIRE SEASON,	2020	TECHNOSYLVA



DATASET	SPATIAL RESOLUTION (meters)	TEMPORAL RESOLUTION	DATA VINTAGE	SOURCE
		END OF FIRE SEASON		
ROADS NETWORK	30	YEARLY		USGS
HYDROGRAPHY	30	YEARLY		USGS
CROPLANDS	30	YEARLY	1997	USDA
Weather and Atmospheric Data				
WIND SPEED	2000	HOURLY / 124 HOUR FORECAST	1990	ADS/DTN
WIND DIRECTION	2000	HOURLY / 124 HOUR FORECAST	1990	ADS/DTN
WIND GUST	2000	HOURLY / 124 HOUR FORECAST	1990	ADS/DTN
AIR TEMPERATURE	2000	HOURLY / 124 HOUR FORECAST	1990	ADS/DTN
SURFACE PRESSURE	2000	HOURLY / 124 HOUR FORECAST	1990	ADS/DTN
RELATIVE HUMIDITY	2000	HOURLY / 124 HOUR FORECAST	1990	TECHNOSYLVA
PRECIPITATION	2000	HOURLY / 124 HOUR FORECAST	1990	ADS/DTN
RADIATION	2000	HOURLY / 124 HOUR FORECAST	1990	ADS/DTN
WATER VAPOR MIXING RATIO 2m	2000	HOURLY / 124 HOUR FORECAST	1990	ADS/DTN
SNOW ACCUMULATED - OBS	1000	DAILY	2008	NOAA
PRECIPITATION ACCUMULATED - OBS	4000	DAILY	2008	NOAA
BURN SCARS	10	5 DAYS	2000	NASA/ESA
WEATHER OBSERVATIONS DATA	Points	10 MIN	1990	SYNOPTIC
Fuel Moisture				
HERBACEOUS LIVE FUEL MOISTURE	250	DAILY / 5-DAY FORECAST	2000	TECHNOSYLVA



DATASET	SPATIAL RESOLUTION (meters)	TEMPORAL RESOLUTION	DATA VINTAGE	SOURCE
WOODY LIVE FUEL MOISTURE	250	DAILY / 5-DAY FORECAST	2000	TECHNOSYLVA / ADS
1 hr DEAD FM	2000	HOURLY / 124 HOUR FORECAST	1990	TECHNOSYLVA / ADS
10 hr DEAD FM	2000	HOURLY / 124 HOUR FORECAST	1990	TECHNOSYLVA / ADS
100 hr DEAD FM	2000	HOURLY / 124 HOUR FORECAST	1990	TECHNOSYLVA / ADS



DATASET	SPATIAL RESOLUTION (meters)	TEMPORAL RESOLUTION	DATA VINTAGE	SOURCE
Values at Risk				
BUILDINGS	Polygon footprints	YEARLY	2020-21	MICROSOFT/TECHNOSYLVA
DINS	Points	YEARLY	2014-21	CAL FIRE
POPULATION	90	YEARLY	2019	LANDSCAN,ORNL
ROADS	Vector lines	YEARLY	2021	CALTRANS
SOCIAL VULNERABILITY	Plexels	YEARLY	2021	ESRI GEOENRICHMENT SERVICE
FIRE STATIONS	Points	YEARLY	2021	ESRI, USGS
BUILDING LOSS FACTOR	Building footprints	YEARLY	2022	TECHNOSYLVA
CRITICAL FACILITIES	Points	YEARLY	2021	FRAP – CAL FIRE
Potential Ignitions locations				
IOU DISTRIBUTION & TRANSMISSION LINES	Linear segments	Updated quarterly	2022	IOUs
IOU POLES & EQUIPMENT	Points	Updated quarterly	2022	IOUs
Fire Activity				
HOTSPOTS MODIS	1000	TWICE A DAY	2000	NASA
HOTSPOTS VIIRS	375	TWICE A DAY	2014	NASA
HOTSPOTS GOES 16/17	3000	10 MIN	2019	NASA
FIREGUARD	Polygons	15 MIN	2020	NATIONAL GUARD
FIRE SEASON PERIMETERS	Polygons	DAILY	2021	NIFS
HISTORIC FIRE PERIMETERS	Polygons	YEARLY	1900	CAL FIRE
ALERT WILDFIRE CAMERAS	Live Feeds	1 min	Real Time	AWF Consortium
LIGHTING STRIKES	1000	1 MIN	Real Time	EARTH NETWORKS / OTHERS



2.5.9 Fire Potential Index (FPI)

FPI quantifies the fire activity potential over the territory aiming to assist operational decision-making to reduce fire threats and risks. FPI allows agencies to easily analyze the short-term fire danger that could exist across the service territory and better communicate the wildfire potential on any given day and time, promoting safe and reliable operations.

Hexel-based (h3) FPI is a forecast product, which is produced on a daily basis, calculated every 3 hours at different h3 resolutions from level 4 to 8 (182 ac and 1km resolution approximately). One of the main advantages of this index is that it was calibrated with real fires (2012 to 2022) using VIIRS hotspots as a proxy of fire activity.

FPI estimates the expected daily number of VIIRS hotspots in a h3-hexel level 6.

FPI comprises several variables including fuels, terrain and weather:

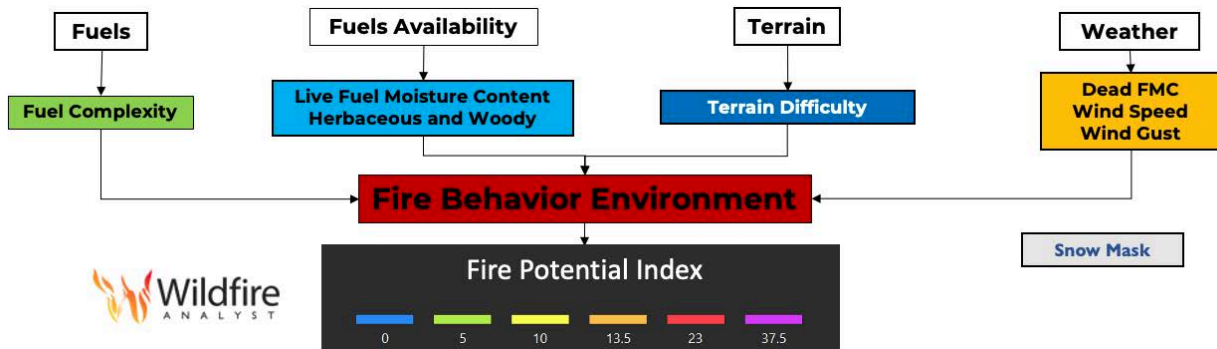

Technosylva has integrated FPI into its operational decision-making WFA enterprise to facilitate its use operationally.

FPI promotes proactive and reactive operational measures through standard operating procedures aiming to reduce the likelihood facilities and assets will be the source of ignition for a fire when FPI is high or extreme.

FPI can be used to inform operation decisions (restrictions on the type of work being performed), as an input to PSPS decision-making and to make risk informed mitigation decisions.

Fire Potential Index products developed for electrical utilities usually include weather data: wind speed, wind gusts, and both dead and live fuel moisture content. Technosylva’s FPI also includes the Fuel Complexity (fuel structure, load and age) and Terrain Difficulty. These are key inputs of the classical fire triangle that explain fire behavior.

Technosylva’s Fire Potential Index (FPI) has been empirically trained and validated with real fire activity. The product is hexel-based (h3) allowing a better temporal and spatial analysis of outcomes, including the analysis by district or any administrative division.

DIREXYON



Bear Valley Electric Service

Phase 1 – Implementation of DIREXYON Suite
for distribution assets
Preliminary Report

March 14, 2024

Contents

Contents	1
Executive Summary	2
Solution Methodology	5
Program Building	5
Program Scheduling	6
Program Ordering, Receiving, Distribution and Installing	6
Project Methodology	8
Utility Risk	9
Fire Risk	10
Use Cases	18
Scenarios (Technosylva dependent)	65
Results	66
Individual Asset Level (Debug screen):	66
Aggregated Results (BI dashboard):	68
Assumptions and Way Forward	80
References	83

Executive Summary

The DIREXYON Solution specializes in advanced financial modelling and integrated decision support systems, leveraging artificial intelligence to aid asset-intensive industries in capital planning and strategic objectives. DIREXYON has offered asset management, risk management, and financial modelling solutions for over 21 years and is committed to providing end-to-end solutions to its customers. Asset managers, financial officers, project managers, and key decision-makers are provided with asset management capabilities as well as long-term forecasts of possible interventions and investment scenarios through advanced, combinatorial simulation techniques.

Investment scenarios generated by DIREXYON ensure sound resource management, optimized decision-making, and an understanding of risk's impact on desired results. And the volume at which DIREXYON can generate and process risk-return scenarios is a key differentiator within the asset investment planning space.

DIREXYON's expertise has empowered numerous organizations to lead in risk management and financial optimization. Thanks to the team's diverse expertise in asset management, finance, accounting, IT, modeling, and mathematics, these multidisciplinary strengths foster integration of innovative ideas in IT systems and their application to financial, asset, and risk management fields. With a trusted, international track record, DIREXYON has assisted asset management and capital investments in various sectors, including infrastructure, financial institutions, and power utilities.

Leveraging the use of the DIREXYON Solution, this project is dedicated to developing an advanced fire risk model that seeks to bridge critical gaps in BVES's risk modeling capabilities, as outlined in Section 6.2.2 of the 2023 Wildfire Mitigation Plan (WMP). Our focus is on integrating decision-making policies within existing constraints, emphasizing a comprehensive evaluation of the network's conditions. The key areas identified for enhancement are as follow:

1. Equipment ignition likelihood;
2. Contact from vegetation ignition likelihood;
3. Contact by object ignition likelihood;
4. Wildfire spread likelihood;
5. Wildfire hazard intensity;
6. Wildfire exposure potential
7. Wildfire vulnerability
8. PSPS exposure potential
9. Vulnerability of community to PSPS

The figure below provides a high-level schematic of the inputs, the modeling components as well as the outputs and insights generated as part of the first phase of the implementation of DIREXYON for Bear Valley Electric Service’s distribution assets.

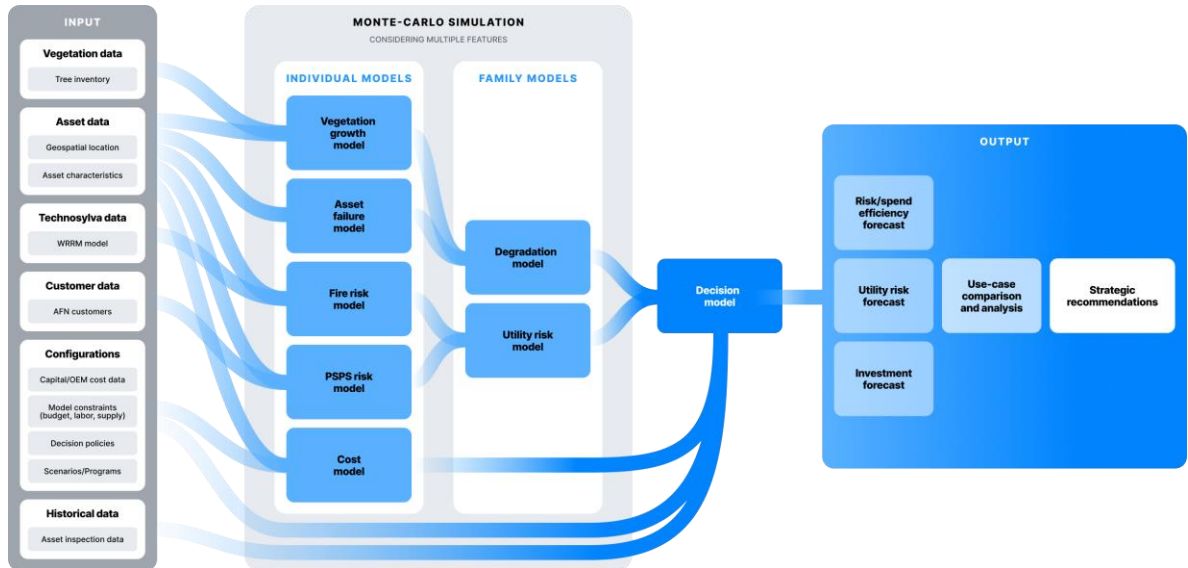

Figure 1 : DIREXYON Phase 1 Schematic for BVES Fire Risk Assessment

Fire risk and PSPS components of the model constitute the core of the model. The fire risk assessment integrates multiple factors, including asset related characteristics, equipment ignition, and vegetation contact. Simultaneously, the PSPS risk assessment considers wildfire spread, hazard intensity, exposure potential and community vulnerability, providing a comprehensive overview of the network’s resilience to both fire-related incidents and PSPS events. Three distinct use cases have been outlined to offer comprehensive insights into the necessary investment levels to meet regulatory minimums, ascertain the current state of affairs, assess the short-term and long-term impacts of the existing BVES strategy on network conditions, and explore alternative fire mitigation strategies. Within each use case, we consider three weather trends, categorized as optimistic, normal, and pessimistic, based on varying Technosylva percentiles.

Dealing with various uncertainties in real-world scenarios, relying solely on deterministic approaches for predicting asset behavior seems impractical. Deterministic methods claim to pinpoint the exact time of asset failure, which may not align with the inherent unpredictability of real-world situations, where assets can fail before or after the predicted timeframe. Similarly, cost estimation introduces another layer of uncertainty. In contrast, Monte Carlo simulations represent stochastic approaches capable of forecasting the probabilities associated with multiple potential outcomes for assets. At DIREXYON, our utilization of Monte-Carlo simulations involves calculating a vast array of potential scenarios for asset degradation, cost uncertainties, and other variables, offering a more realistic and robust perspective on the range of possible outcomes.

This approach ensures a thorough examination of scenarios under different climatic conditions, enhancing the robustness of the analysis.

In conclusion, this project in the first phase seeks to rectify identified gaps within Bear Valley's 2023 Wildfire Mitigation Plan (WMP) while furnishing users with a tool for testing and appraising diverse fire mitigation strategies.

The results of this analysis indicates that The BVES Strategy's investment approach (use case 2), focusing on more than just meeting the GO165 minimum requirements (use case 1), demonstrates substantial long-term value by consistently maintaining fire risks at lower levels. By incorporating a variety of mitigation measures such as extensive vegetation management, fire wrap installations, and the proactive replacement of conductors, the strategy realizes a lower and more stable fire risk. This suggests that a relatively higher initial outlay for comprehensive fire risk mitigation measures can provide significant sustained benefits. The long-term payoff of this approach is clear when compared to Use Case 3, where the strategic choice to replace wood poles with more durable steel poles implies high upfront costs but promises greater savings over time due to reduced maintenance and replacement needs.

When making strategic decisions, stakeholders must weigh the benefits of upfront investments against long-term operational savings and the overarching goal of risk management. Use Case 3 offers an intriguing balance by potentially reducing the need for future interventions, which could be especially compelling given its implications for risk reduction and enhanced network resilience. As infrastructure ages, the investment strategies behind these use cases are crucial, with the proactive and preventative measures of Use Cases 2 and 3 likely resulting in lower average infrastructure ages and correspondingly lower costs and risks in the long run. The executive choice ultimately depends on the desired balance between managing immediate costs, ensuring long-term savings, and achieving a resilient, reliable power supply for all customers, including the most vulnerable who rely on consistent electricity access.

The outcomes empower decision-makers with a comprehensive understanding of network conditions, enabling proactive risk management and informed decision-making for a more resilient and secure energy infrastructure.

Solution Methodology

The DIREXYON Solution enables program design activities. Program design requires the combination of all three core capabilities, i.e. asset forecasting, decision-making and portfolio management, and can be viewed as the end result of the approach. The DIREXYON Solution encompasses a powerful asset modelling tool where an unlimited number of models could be configured by simple "drag and drop". Its simplicity allows users to model their asset portfolio without the need for programming. First, sophisticated asset evolution and condition models, risk models, level of services, KPIs and any other relevant indicators can be configured. Then, an unlimited number of intervention options as well as their costs and impacts can be defined. Finally, realistic scenarios can be built by simple configuration of user-defined constraints.

In addition, the DIREXYON Solution is designed to enable the organization to formalize the internal decision-making processes that are driving asset management planning strategies. The entire decision-making process can be realistically modeled using decision trees that are then used to perform a combinatorial analysis. A decision tree represents a series of decisions, and the criteria used, leading to the application of an intervention choice. The criteria can be related to the condition of the assets, the use of the assets, the degradation of the assets, the different risks, constraints, standards, etc. Decision trees also allow to manage unforeseen events, such as equipment failures or defects. The scenario and optimization module of the platform can be used to configure and launch several Monte-Carlo simulations (scenarios), simultaneously when needed, to compare several strategies. This approach allows the evaluation of conditional scenarios (what-if scenarios), sensitivity analysis and the evaluation of the impact of constraints on the ability to deliver programs.

Considering the stochastic nature of asset evolution is a key component of an advanced asset management methodology, the DIREXYON Solution provides a global perspective of the risk associated with the tested strategies. The user is also able to evaluate the impact of the actions undertaken on the probability of achieving the targeted objectives. The decision-making acuity provided by the DIREXYON Solution allows decision-makers to evaluate these options according to their risk tolerance.

Program Building

The DIREXYON Solution provides the ability to build user-defined specific programs for any asset class and for any type of investment (inspection, maintenance, replacement, etc.) by using decision trees. These programs can be conditioned on any relevant attributes (e.g. location, model, load, circuit, material, etc.) or constraint. Forecasting the entire portfolio of assets in the long-term allows

the ability to identify investment opportunities and build relevant programs to address the short, medium, and long-term needs.

As an example, users could easily configure a Wood Pole Replacement Program, triggered by pole material (Material = Wood). Program specifications could then be assessed more precisely through the configuration of a Pole Replacement Program intervention using the modelling tool. For example, one could seek a program where wood poles over a certain age in high fire risk circuits are prioritized to be replaced by steel poles.

Program Scheduling

A key feature of the DIREXYON Solution is the ability to forecast its whole portfolio of assets over time to get a better understanding of the evolution of the condition of the network and forecast needs for capital investment. This forecast is crucial to program scheduling. As such, asset evolution over time will be computed by applying degradation and condition models configured in the modelling tool. Then, for each year considered in the simulation, each asset and/or group of assets will be exposed to user-defined decision trees. The simulation time scale can be user defined, depending on the client's required granularity for program planning (months, quarters, years). This combinatorial approach, where a set of user-defined criteria leads to a specific intervention, dynamically triggers interventions when asset condition or applicable constraints are reached. Interventions can be bundled into programs.

As programs will be triggered at the right location, at the right time, and for the right assets and/or groups of assets, program scheduling is then automatically performed through the simulation process. Users can test a variety of program parameters, by simulating scenarios (predictions) with different trigger levels, constraints and/or program specifications. Using the optimization toolkit, clients can optimize scheduling by setting up an objective function under a defined set of constraints (e.g. minimize costs while keeping an average circuit-level fire risk below a certain threshold).

Program Ordering, Receiving, Distribution and Installing

Using the decision tool, users can configure decision-trees to model a decision process based on client-specific business rules for ordering, receiving, distribution and installing interventions and trigger those based on user-defined criteria.

As mentioned in the previous section, the simulation time scale is user-defined. For example, program building, and scheduling can be performed on an annual basis over the long-term to forecast needs and find the most profitable strategies from an entire asset portfolio lifecycle perspective. Then, program shaping could be done monthly over a shorter period. This flexibility offered by the platform allows for optimization of performance by selecting the right time scale and simulation duration based on scenario objectives.

Project Methodology

From a modeling standpoint, DIREXYON has organized assets hierarchically, wherein each asset type comprises multiple individual assets, each with its dedicated risk, degradation, and decision model.

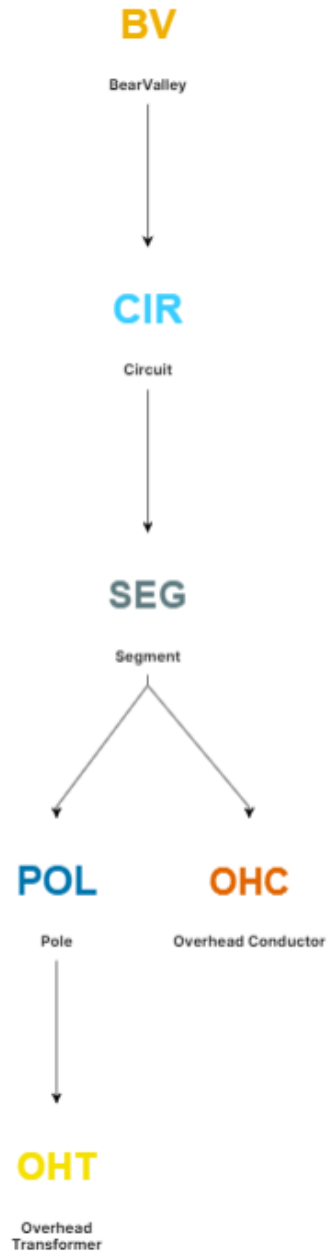
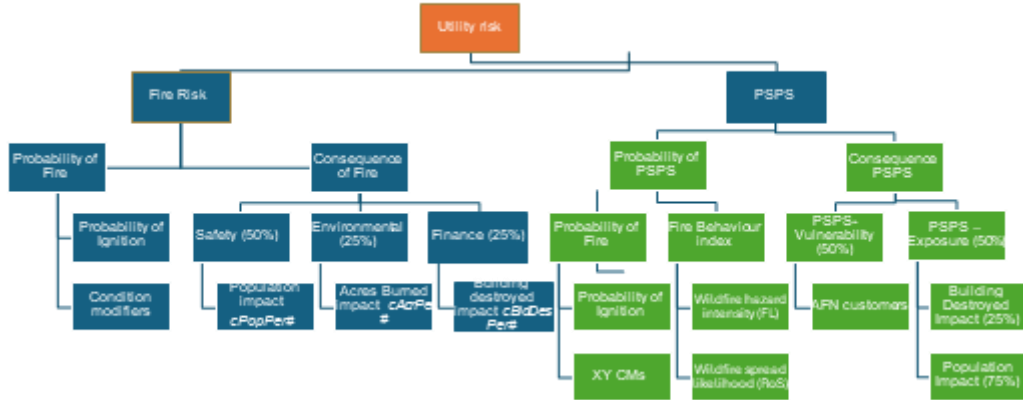

Figure 2 : Overview of Asset Hierarchy in DIREXYON

At the heart of this model lies the concept of risk, embodying adverse events, specifically fires and PSPS incidents in this context. The current approach calculates risk by multiplying the probability of these adverse events by their potential consequences. Put simply, probability reflects the likelihood of these events happening, while consequence details the potential impact if the event does occur. The following chart summarizes the risk model:



Utility Risk

Utility risk is encapsulated by the average **fire risk at the individual asset level** and the calculated **PSPS risk at the circuit level**. While subject matter experts initially allocate a 50% weight to each component, this weighting is **configurable** and can be easily adjusted during the simulation process. The attached screenshot represents the utility risk calculations in the circuit level.

Asset Value Information for Period 2026

Characteristic [Utility Risk] calculation
End of Step

$$(0.5 \times 4.973) + (0.5 \times 14.27) = 9.621$$

$$\left(\text{123 Configurable FireRisk weight} \times \text{Fire Risk} \right) + \left(\text{123 Configurable PSPS weight} \times \text{PSPS - Risk} \right) = \text{Utility Risk}$$

Fire Risk

The DIREXYON Solution computes **fire risk at the individual asset level**, and the cumulative risk at each level contributes to the overall fire risk assessment of the entire network. Each individual asset type's fire risk comprises two components: **probability of fire and consequence of fire**, explained below:

Asset Value Information for Period 2026

Characteristic [Fire Risk (Test)] calculation
End of Step

$$2.75 \times 1 = 2.75$$

$$f_{xy} \text{ Consequence of Fire Test} \times f_{xy} \text{ Probability of Fire - Score (Test)} = f_{xy} \text{ Fire Risk (Test)}$$

Probability of Fire

The probability of fire gauges the likelihood of fire ignition specific to each asset type. It is calculated as the product of the Technosylva-calculated Probability of Ignition (POI) and XY condition modifiers (CMs). The attached screenshot represents the probability of fire risk calculations along with overall CM calculations for poles.

Asset Value Information for Period 2026

Characteristic [Probability of Fire - Scaled] calculation
End of Step

$$\min(0.4 \times 0.625, 1) = 0.25$$

$$\min(f_{xy} \text{ Probability of Fire} \times f_{xy} \text{ CM - Final}, 1) = f_{xy} \text{ Probability of Fire - Scaled}$$

Characteristic [CM - Final] calculation
End of Step

$$1 \times 1.25 \times 0.5 \times 1 = 0.625$$

$$f_{xy} \text{ CM - Firewrap} \times f_{xy} \text{ CM - Vegetation} \times f_{xy} \text{ CM - Equipment} \times f_{xy} \text{ CM - Pole Material} = f_{xy} \text{ CM - Final}$$

XY Condition modifiers

Condition modifiers in the model are to show the impact of asset characteristics and specific interventions on the calculated probability of fire by Technosylva. For example, if a bare conductor is

replaced with a covered conductor, what is the impact on risk mitigation? Accordingly, the following condition modifiers are defined in individual asset levels as detailed below:

Conductor Condition Modifiers

Conductor Material

This modifier assesses the effect of conductor material (such as copper or other materials) on overall fire risk. Notably, copper conductors are associated with a higher probability of igniting a fire. Consequently, substituting copper conductors with non-copper materials reduces the fire risk by 50%, while the reverse—replacing non-copper materials with copper—increases the risk by 50%. Please note that, the 50% values are a placeholder in the model that needs to be adjusted with more insights from subject matter experts.

This nuanced approach enables users to quantify the potential risk mitigation or escalation associated with changes in conductor types.

Conductor Type

This condition modifier delineates the effects of various conductor types, specifically comparing covered and uncovered variants. Transitioning from uncovered to covered conductors notably diminishes the associated fire risk. Consequently, implementing coverings on previously non-covered conductors results in a 50% reduction in fire risk. Please note that this value is taken from available literature (1- 4) and serves as a placeholder in the model, and with further insight from the client and access to historical events correlated with conductor types, adjustments can be made for a more accurate assessment.

Accordingly, the conductor probability of fire is the product of Technosylva-calculated Probability of Ignition (POI), CM – Conductor Material, and CM – Conductor type.

These two condition modifiers specifically address the Equipment Ignition Likelihood within the identified gap.

Transformer Condition Modifiers

Transformer failure

This condition modifier encapsulates the impact of transformer degradation on the probability of fire. Transformer degradation is characterized by age and different Kva ratings. Additionally, an asset-specific accidental failure probability of 0.002 is incorporated into the risk/failure model. In the absence of historical failure data from BVES, the accidental failure probability of 0.002 serves as a placeholder, derived from the findings of a study by S. Tenbohlen (2011)(5).

The current condition modifier for transformers is derived from a Weibull failure curve, considering transformer age, Kva, and accidental failure probability. Specifically, for a brand-new transformer or pole, the condition modifier (CM) is 1. As transformers age, the CM exponentially increases from 1 to 2.

The 0.2% probability of accidental failure for transformers addresses the Contact by Object Ignition Likelihood within the identified gap.

This data provides valuable insights into the potential risks associated with transformer conditions.

Pole Condition Modifiers

Fire Wrap

This condition modifier assesses the impact of installing fire wraps on wooden poles as a risk mitigation measure. Accordingly, the installation of fire wraps on wooden poles initially without them can result in a 10% reduction in fire risk. Please note that this value serves as a placeholder in the model that is confirmed by subject matter experts, and with further insight from the client, adjustments can be made for a more accurate assessment.

Pole material

This condition modifier evaluates the impact of pole material on fire risk, with wooden poles generally posing a higher risk of ignition compared to metal poles. The modifier facilitates an understanding of the potential risk reduction by replacing wooden poles with steel in the network. Currently, replacing wood material with non-wood reduces the fire risk by 10%. Please note that this value serves as a placeholder in the model that is also confirmed by subject matter experts, and with further insight from the client, adjustments can be made for a more accurate assessment.

Vegetation

Vegetation is incorporated into the model as an integral part of the pole asset type. The likelihood of fire caused by vegetation varies based on the state of trees—whether they have fallen, grown, or the overall tree density (Fall in, Grow in, and Tree density). Markov chains are employed to model the probability of transitioning from the best zone (4) to the worst zone (1), dependent on the number of years since the last vegetation inspection.

For all three mentioned metrics, a zone value is predicted annually based on the elapsed time since the last vegetation management intervention. Consequently, with an increasing number of years since the last vegetation management intervention, the probability of transitioning from the best zones to the worst zones rises. In simpler terms, without regular inspections, there is a heightened risk of the vegetation around the equipment growing unchecked, thereby increasing the likelihood of fires.

The final CM vegetation is the product of three Condition Modifiers (CMs) CM – Fall in, CM – Grow in, and CM – Density. For each metric if the tree's state remains unaltered compared to the initial state, the related CM is set at 1. However, if it deteriorates, the CM adjusts from 25% to 100% (based on the initial and current zones), and if it improves, it decreases by 25% to 75%. This meticulous approach ensures a nuanced representation of the impact of vegetation on fire risk within the model. Please note that this value serves as a placeholder, and with further insight from the client and access to historical fall-in and grow-in data, adjustments can be made for a more accurate assessment. Each of the identified metrics is briefly explained below:

Grow-In

This metric relies on a shape file provided by the client, representing the likelihood of tree branches growing into power lines and causing fires. The clear_level in the data interprets the Grow-in values.

Fall-In

Data for this metric is sourced from a shape file provided by the client. Calculated based on tree height and the distance of the tree to the pole, Fall-In zones are defined depending on the minimum height required for a tree to impact an asset. This determination considers the pole height, tree distance to pole, and the specified minimum heights.

Density

Data for this metric comes from the VegManagementDataPartner, with no specific aggregation performed on the dataset. It represents the density of vegetation around the assets.

These condition modifiers address the contact from vegetation ignition likelihood within the identified gap.

Equipment

A pole linked to high-risk equipment, such as a transformer and/or conductor, inherently carries an elevated fire risk. This condition modifier encapsulates the cumulative effect of calculated Condition Modifiers (CMs) for transformers and conductors, providing a comprehensive assessment of the associated risk for a given pole.

Consequence of Fire

Consequence of fire values delineate the impact of fire on population, buildings destroyed, and acres burned. These values, determined by **Technosylva at the segment level**, remain constant across all asset types within same segment. The mentioned consequences are grouped into safety, environmental, and finance impact with **user-defined weights** that can be easily adjusted upon running the simulation. The attached screenshot represents the calculated consequence of fire in segment level based Technosylva data and configurable weights:

Asset Value Information for Period 2026

Characteristic [Consequence of Failure - Fire (Test)] calculation
End of Step

$$0.25 \times 7 + 0.25 \times 2 + 0.5 \times 4 = 4.25$$

$$\boxed{123 \text{ Acres Impact - Weight (WildFire)}} \times \boxed{f_{X_5} \text{ Acres Impact - Score - Test}} + \boxed{123 \text{ Destroyed Building Impact - Weight (WildFire)}} \times \boxed{f_{X_5} \text{ Destroyed Building Impact - Score (Test)}} + \boxed{123 \text{ Population Impact - Weight (WildFire)}} \times \boxed{f_{X_5} \text{ Population Impact - Score (Test)}} = \boxed{f_{X_5} \text{ Consequence of Failure - Fire (Test)}}$$

PSPS Risk

The DIREXYON suite computes PSPS risk at the **circuit level**, and the cumulative risk at circuit level contributes to the overall utility risk of the network. Similar to the fire risk, PSPS risk comprises two components: probability of PSPS and consequence of PSPS, explained below:

Asset Value Information for Period 2026

Characteristic [PSPS - Risk] calculation
End of Step

$$3.114 \times 4.583 = 14.27$$

$$\boxed{f_{X_5} \text{ PSPS - Consequences}} \times \boxed{f_{X_5} \text{ PSPS - Probability Score}} = \boxed{f_{X_5} \text{ PSPS - Risk}}$$

PSPS Probability

In the absence of FPI data from Technosylva and based on the available literature by PG&E (6), PSPS probability is defined based on calculated fire probabilities in individual asset levels (POI*CMs) and fire behaviour index.

Asset Value Information for Period 2026

Characteristic [PSPS - Probability] calculation
End of Step

$$\min\left(\frac{123}{100} \text{ Probability of Fire} \times \frac{123}{100} \text{ Fire Behaviour Index - Numerical}, 1\right) = \frac{123}{100} \text{ PSPS - Probability}$$

$\min(0.2239 \times 2, 1) = 0.4478$

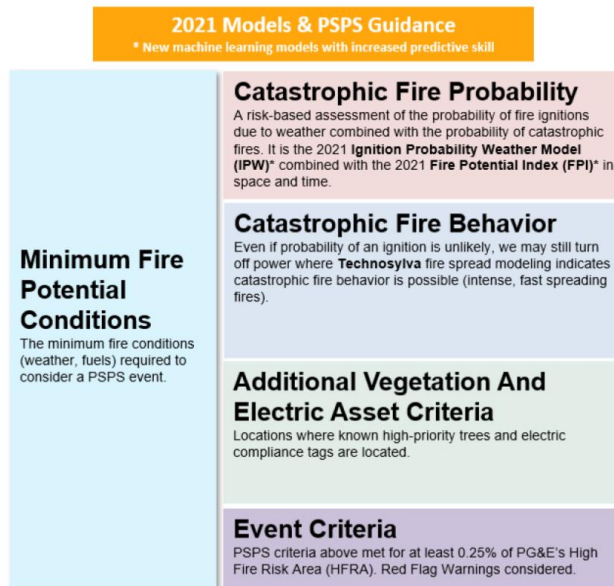

Fig. 1. High level overview of 2021 Distribution PSPS guidance

Fire behaviour classes (1-5) are defined in **segment level** based on two components of Technosylva that is Fire Rate of Spread, and Flame length as below:

FIRE BEHAVIOR CLASS		ros (ch/h) 100 ch/h = 1.25 mi/h					
		VERY LOW 0 - 2	LOW 2 - 5	MODERATE 5 - 20	HIGH 20 - 50	VERY HIGH 50 - 150	EXTREME >150
fl (ft)	VERY LOW 0 - 1	1	1	1	1	2	3
	LOW 1 - 4	1	1	2	2	3	4
	MODERATE 4 - 8	1	2	2	3	4	5
	HIGH 8 - 12	1	2	3	3	4	5
	VERY HIGH 12 - 25	2	3	3	4	5	5
	EXTREME >25	3	3	4	4	5	5

PSPS Consequence

PSPS Consequence values outline the repercussions of Public Safety Power Shutoffs (PSPS) on distinct categories, including **vulnerable individuals (AFN customers)**, the general population, and affected buildings. These consequences are categorized into PSPS vulnerability and PSPS exposure, with customizable user-defined weights that can be easily adjusted upon running the simulation.

Asset Value Information for Period 2026

Characteristic [PSPS - Consequences] calculation
End of Step

$$(0.5 \times 1) + (0.5 \times 5.227) = 3.114$$

$$\left(\text{123 Configurable PSPS Vulnerability Consequence Weight} \times f_{X_h} \text{ PSPS - Vulnerability} \right) + \left(\text{123 Configurable PSPS Exposure Consequence Weight} \times f_{X_h} \text{ PSPS - Exposure} \right) = f_{X_h} \text{ PSPS - Consequences}$$

Characteristic [PSPS - Exposure] calculation
End of Step

$$(0.25 \times 5.863) + (0.75 \times 5.016) = 5.227$$

$$\left(\text{123 Building Destroyed Impact Configurable Weight (PSPS)} \times f_{X_h} \text{ Building Destroyed Impact - Score} \right) + \left(\text{123 Population Impact Configurable Weight (PSPS)} \times f_{X_h} \text{ Population Impact - Score} \right) = f_{X_h} \text{ PSPS - Exposure}$$

Use Cases

Three distinct use cases are crafted to drive insights in this phase of analysis, aiming to elucidate the necessary investments for meeting regulatory minimums, understand the present state of the network, anticipate its short-term and long-term evolution under the existing Bear Valley strategy, and explore alternative mitigation approaches. The outlined use cases are as follows:

1. GO.165 Requirements:
 - a. Focuses solely on meeting the minimum requirements stipulated by GO.165.
2. Current BVES Strategy:
 - a. Satisfies the minimum requirements of GO.165 with added measures:
 - i. Installation of fire wraps
 - ii. Proactive replacement of bare conductors
 - iii. Implementation of vegetation management strategies
3. Alternative Mitigation Strategy:
 - a. Explores the consequences of replacing wooden poles with steel, as an alternative to fire wrap installation in the current BVES strategy.

These use cases aim to familiarize the client with the diverse analyses and insights achievable through the DIREXYON Solution. By exploring different scenarios, we highlight the Solution's versatility in risk assessment, strategy evaluation, and decision-making, providing a concise yet comprehensive overview of its capabilities. The following will outline the step-by-step journey of one asset for each of the pole, overhead conductor, and overhead transformer asset types throughout a model simulation for each of the use cases. Each use case is simulated over 60 years and 50 iterations.

GO.165 Requirements

Decision trees in the model reflect the maximum allowable inspection cycle lengths for poles, as described in the table below:

Table

	Patrol		Detailed		Intrusive	
	Urban	Rural	Urban	Rural	Urban	Rural
Transformers						
Overhead	1	2	5	5	---	---
Underground	1	2	3	3	---	---
Padmounted	1	2	5	5	---	---
Switching/Protective Devices						
Overhead	1	2	5	5	---	---
Underground	1	2	3	3	---	---
Padmounted	1	2	5	5	---	---
Regulators/Capacitors						
Overhead	1	2	5	5	---	---
Underground	1	2	3	3	---	---
Padmounted	1	2	5	5	---	---
Other Assets						
Overhead Conductor and Cables	1	2	5	5	---	---
Streetlighting	1	2	x	x	---	---
Wood Poles under 15 years	1	2	x	x	---	---
Wood Poles over 15 years which have not been subject to intrusive inspection	1	2	x	x	10	10
Wood poles which passed intrusive inspection	---	---	---	---	20	20

Source: GO95_128_&165_Seminar.pdf (CPUC Utilities Safety and Reliability Branch)

Poles

This use case will follow the step-by-step journey of Pole 0593BV of iteration 1 between the start of the simulation in 2023, to its replacement in 2027:

The screenshot shows a GIS interface with a map of a residential neighborhood. A specific pole is highlighted on the map. Below the map, there are two panels providing details about the selected asset.

Initial Characteristics		Asset Details	
Characteristic	2022	Description	POL - 0593BV
CIRCUIT_ID	Goldmine Circuit	Asset Type Importation Code	POL
Fall in - Markov	Zone 2	Asset Type Description	Pole
FIRE_WRAP	False	Client Asset Code	
Grow in - Markov	Zone 1	ID	5397
HEIGHT	35	Parent #1	Bear Valley
INSTALLDATE	1995	Parent #2	Goldmine Circuit
INTINSP_INSPECT_DT	2011	Parent #3	4365 - D4364
Major Route?	N/A		
MATERIAL	Wood		
Tree Density	Medium		

Degradation

The pole is 28 years of age at the start of the simulation and ages by one year between 2023 and 2027.

Characteristic: Degradation Type:

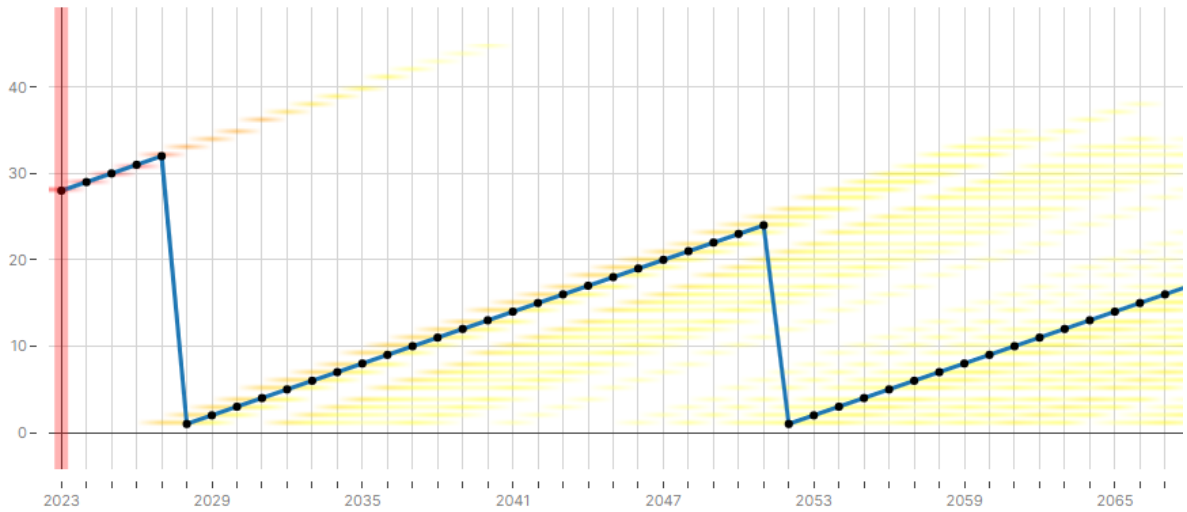

Between 2023 and 2026, the model does not trigger a failure for this asset, as seen in the decision tree below:

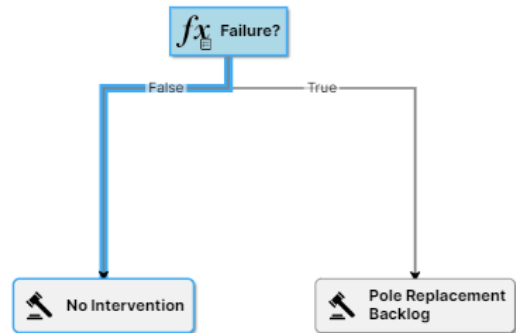

Detailed Inspections

Given that inspection cycle frequencies are set at the circuit level, the decision tree must validate whether the parent circuit of Pole 0593BV, Goldmine Circuit, is triggered for detailed inspection. Between 2023 and 2027, no detailed inspections take place on Goldmine Circuit, as this circuit is set on a 5-year cycle starting in 2028:

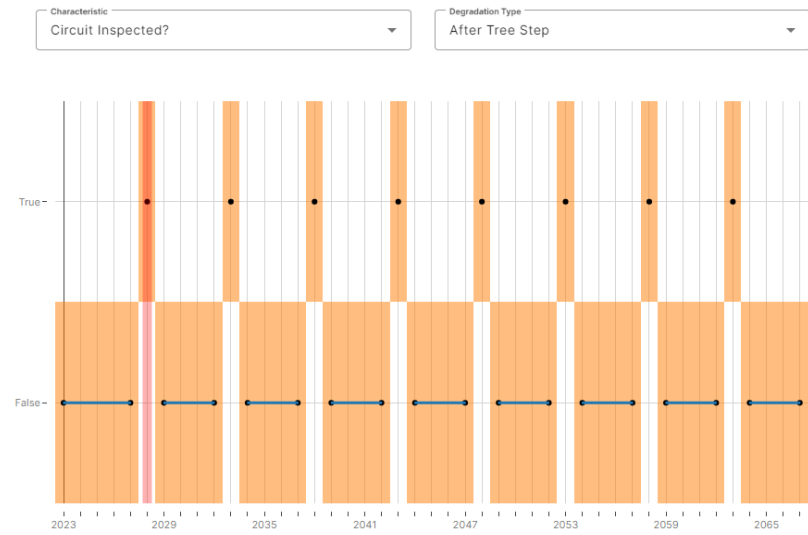
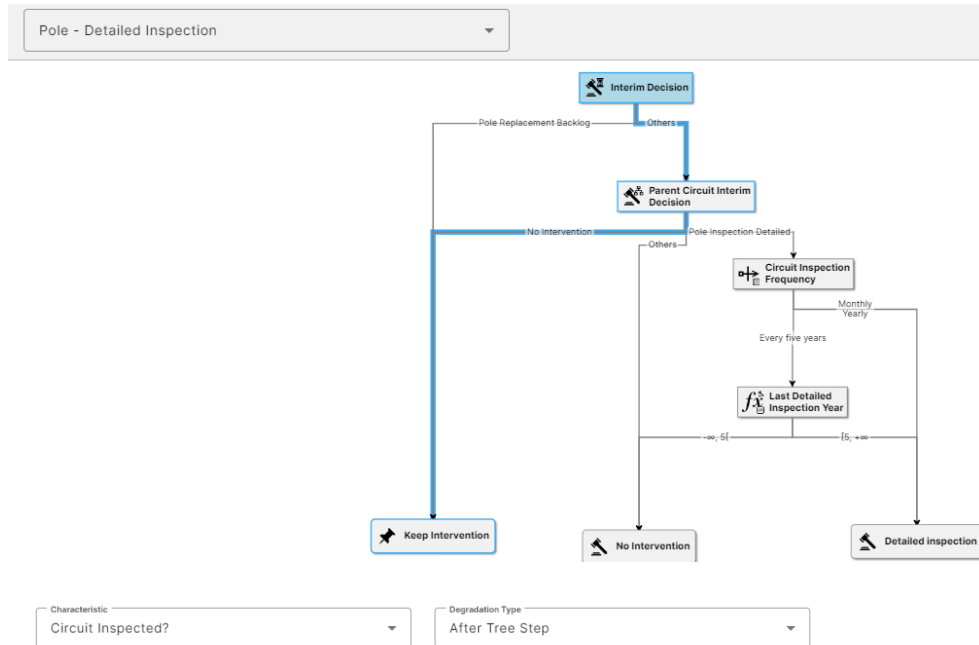

Intrusive Inspections

Intrusive inspection cycle frequencies are set at the pole level, but the information is brought to the parent circuit level to optimize the prioritization of interventions. In other words, if a pole is marked for intrusive inspection – is 10 years since its previous intrusive inspection – all other poles within that circuit that meet the criteria for intrusive inspections will be inspected. In 2023, Pole 0593BV is

triggered for intrusive inspection, therefore all other poles within Goldmine Circuit will run through the intrusive inspection decision tree. Because Pole 0593BV is over 15 years old and the model has triggered a “Passed” status on its previous intrusive inspection, the inspection cycle is set to 20 years. The years since the pole’s last intrusive inspection is 12 years, therefore it does not require one in 2023.

Pole - Intrusive Inspection

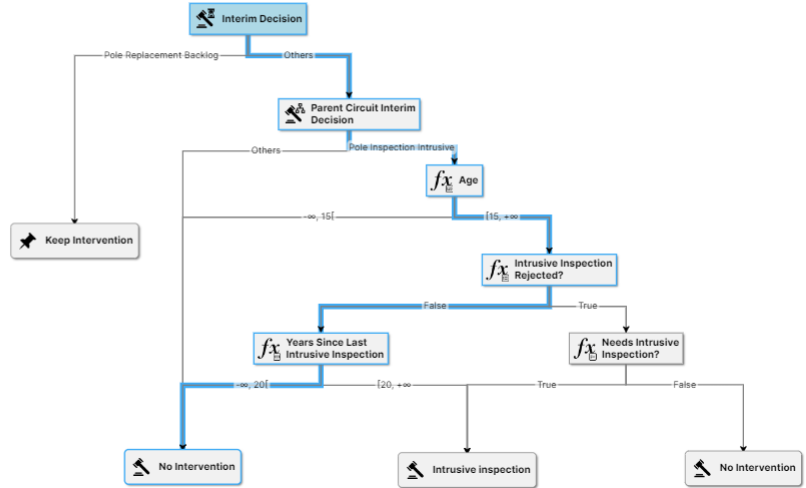

Characteristic: Years Since Last Intrusive Inspection

Degradation Type: Before Step

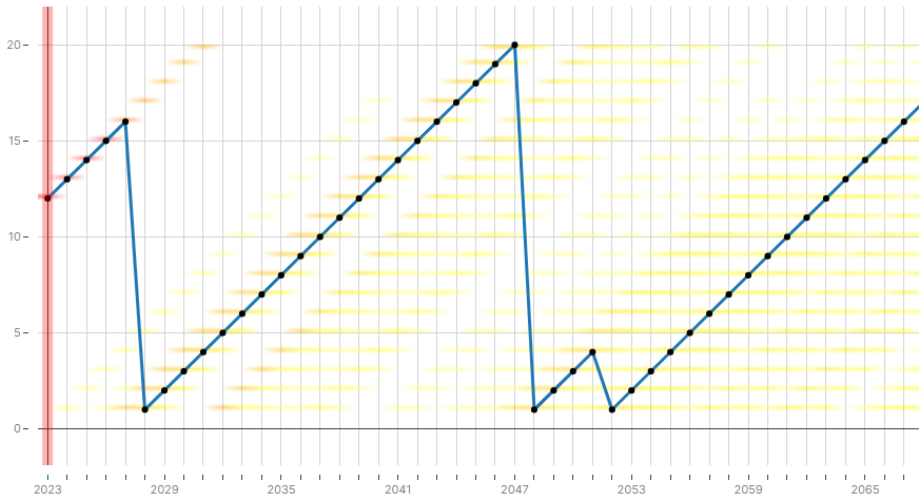

Grid Hardening

As part of the GO.165 minimum requirements, vegetation management around poles takes place every 5 years. As seen in the image below, vegetation management occurs on Pole 0593BV in 2028.

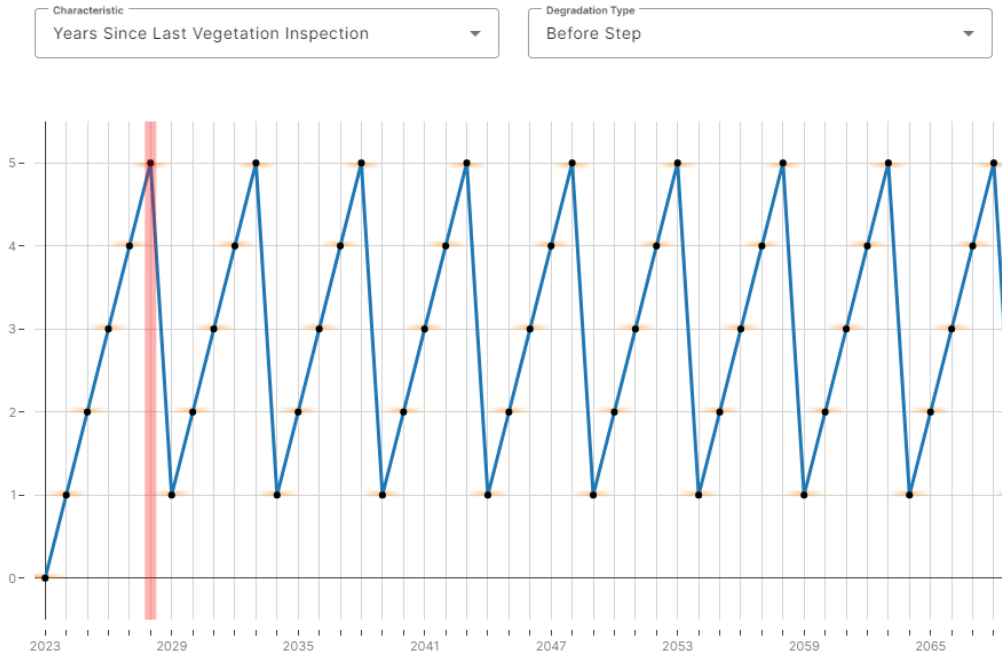

The decision tree checks whether the years since the last vegetation inspection for each pole is 5 years or over:

Grow In / Fall In Management

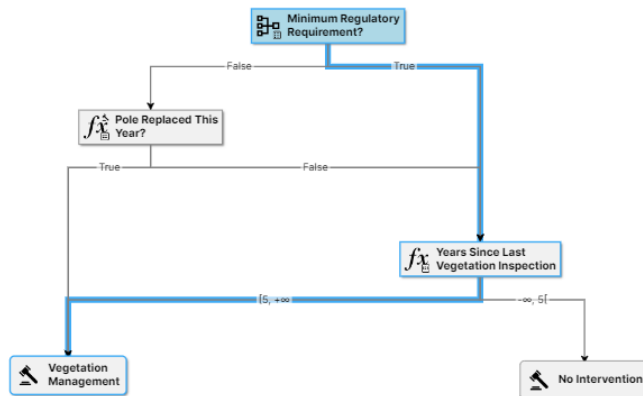

Vegetation management has an impact on risk mitigation, as it reduces the probability of fire for this specific asset which, in turn, reduces its fire risk:

Characteristic: Probability of Fire - Scaled | Degradation Type: Before Step

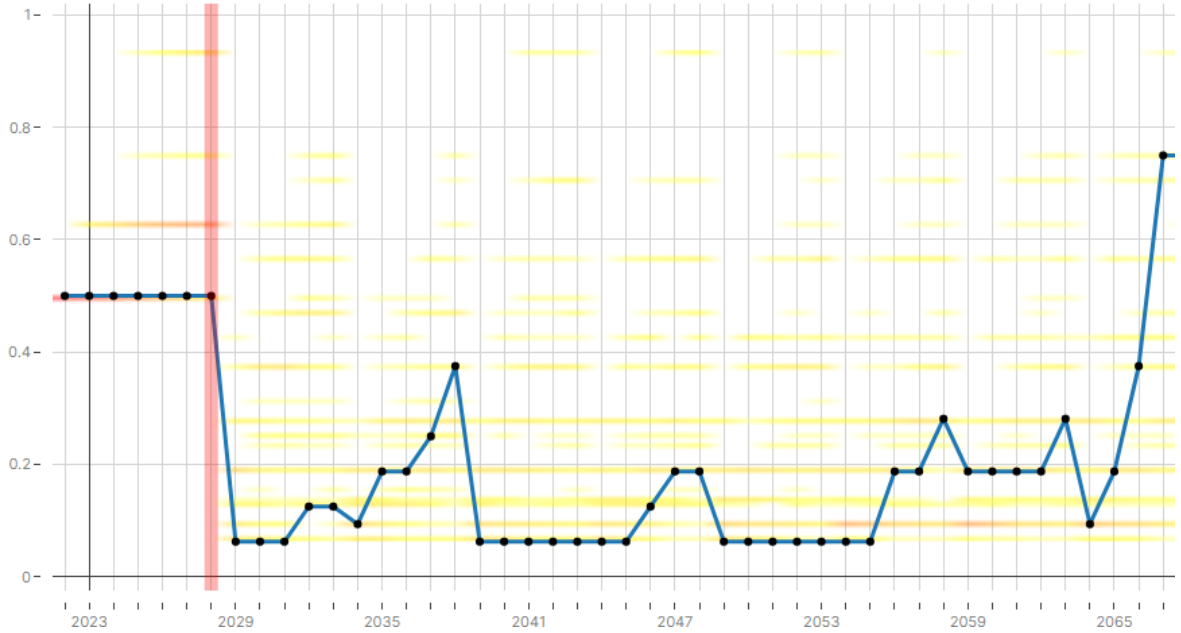

Characteristic: Fire Risk (Test) | Degradation Type: Before Step

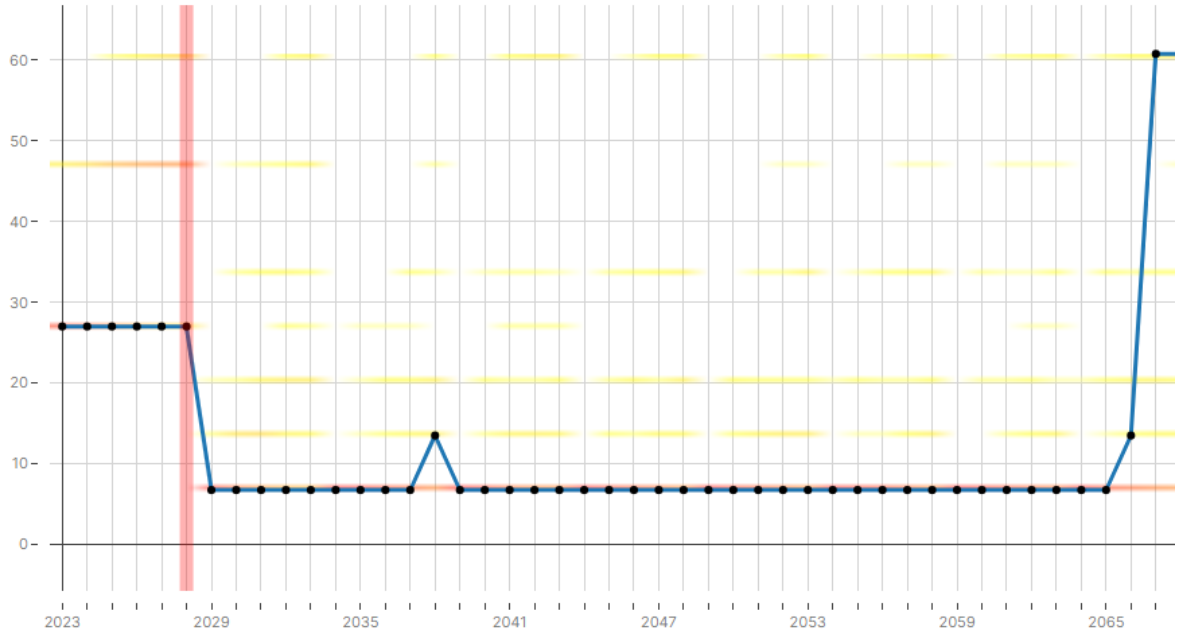

Replacement

Between 2023 and 2026, the model does not trigger an end-of-life failure on Pole 0593BV and, as a result, is not triggered for replacement:

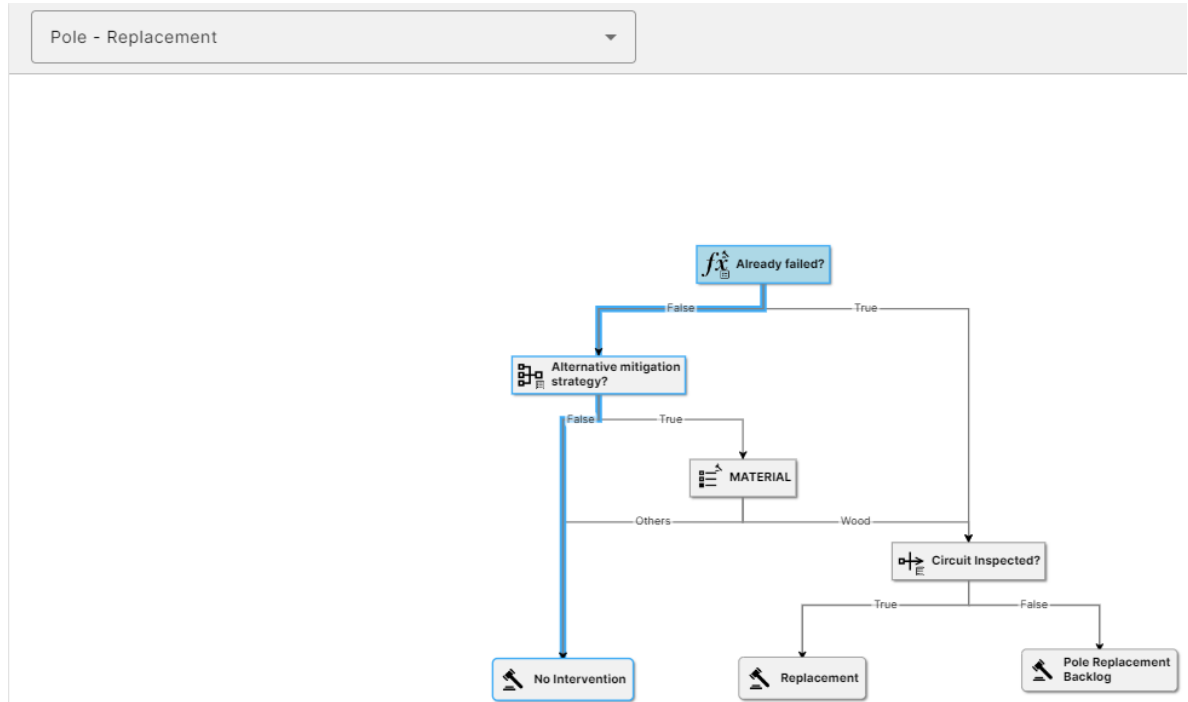

However, in 2027 the model triggers an end-of-life failure for this pole and because Goldmine Circuit is triggered for intrusive inspection, Pole 0593BV is triggered for replacement.

Pole - Replacement

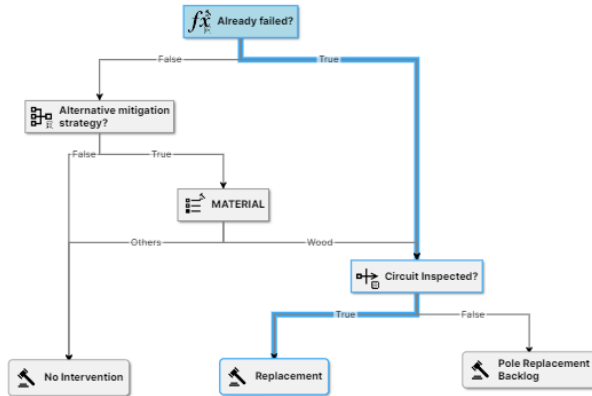

A pole replacement budget cap is set at \$6,000,000 per year. The prioritization order is set at the circuit level, meaning all poles flagged for replacement within an inspected circuit will be replaced, if there is sufficient budget available, before moving to the next circuit in the prioritization order. In this situation, sufficient budget was available to replace poles in Goldmine Circuit.

Pole - Replacement

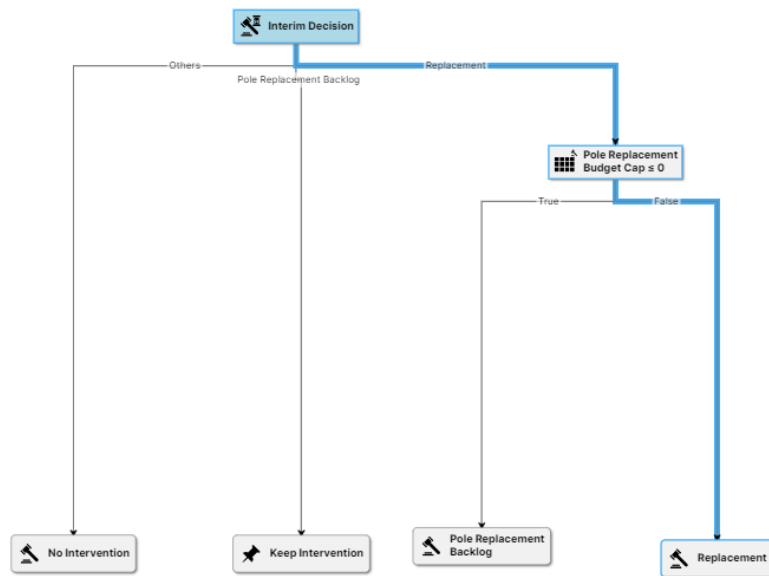

The pole replacement will reset several characteristic values (Age, Years Since Last Detailed Inspection, Years Since Last Intrusive Replacement) as well as trigger replacement costs:

Characteristic	Beginning of Step	End of Step
Age	32	0
Years Since Last Detailed Inspection	4	0
Pole Replacement Backlog - Numerical	1	0
Years Since Last Intrusive Inspection	16	0
Age Range - Map	30-35	0-5
Number of Replacements	0	1
Wood to Steel Ratio - Cost	1	1.204
Wood to Composite Ratio - Cost	1	1.687
Replacement Labor - Cost (Constant)	0	10K
Replacement Labor - Cost (Current)	0	10K
Total Cost (Constant)	0	15.11K
Replacement - Cost	0	15.11K
Last Detailed Inspection Year	2023	2027
INSTALLDATE	1995	2027
INTINSP_INSPECT_DT	2011	2027
Replacement B Material - Cost	0	2500
Replacement B Material - Cost	0	2500
Replacement Material - Cost (Constant)	0	2606
Replacement Material Distribution -	0	2606
Replacement Material - Cost (Current)	0	2606

Overhead Transformers

This use case will follow the step-by-step journey of Overhead Transformer T10002BV of iteration 1 between the start of the simulation in 2023, to its replacement in 2028:

The screenshot displays a software interface with a map and a data table. The map shows a residential neighborhood with streets like West Big Bear Boulevard, West Mojave Boulevard, Sherwood Boulevard, West Aeroplane Boulevard, and Rainbow Boulevard. A green shaded area is visible on the map. The interface includes tabs for Summary, Analysis, Map, Degradations, Occurrences, Asset Value Details, and Step by Step. Below the map, there are two tables: 'Initial Characteristics' and 'Asset Details'.

Initial Characteristics		Asset Details	
Characteristic	2022	Description	OHT - T10002BV
Installation Year	1985	Asset Type Importation Code	OHT
KVAA	25	Asset Type Description	Overhead Transformer
KVAB	0	Client Asset Code	
KVAC	0	ID	2093
KVAMEAN	8.333	Parent #1	Bear Valley
Number of Cust...	14	Parent #2	Shay Circuit
Phase	Single P	Parent #3	7033 - T551

Degradation

The overhead transformer is 38 years of age at the start of the simulation and ages by one year between 2023 and 2027.

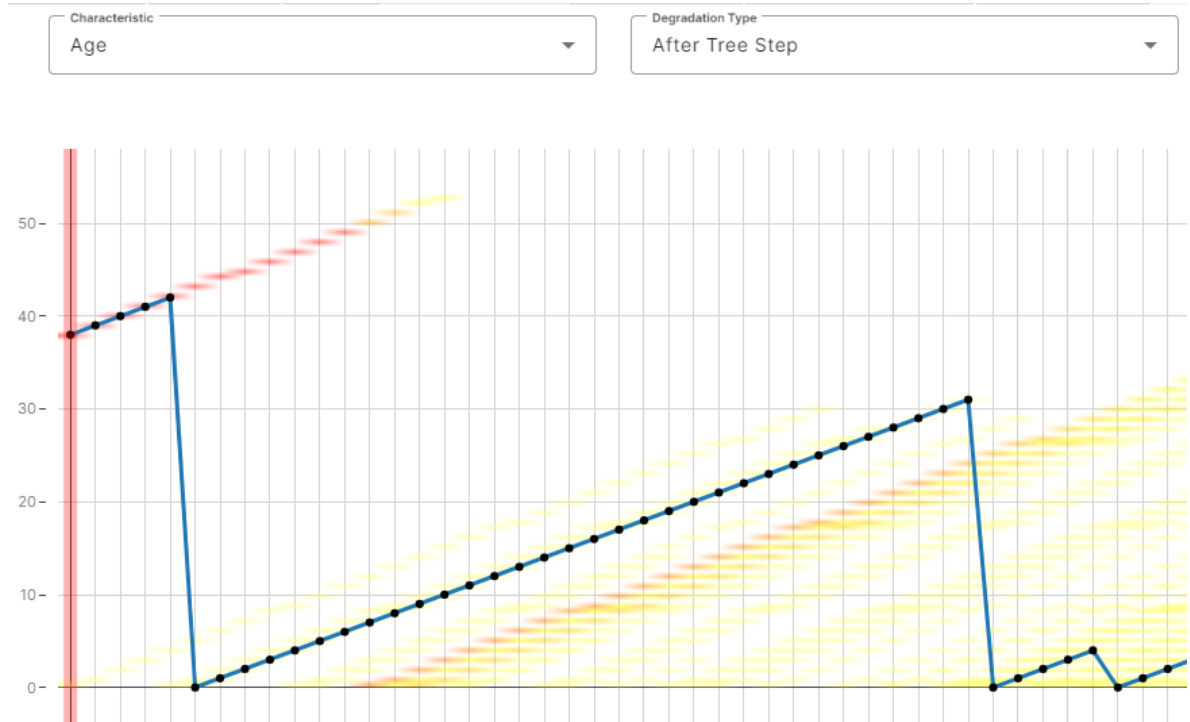

Between 2023 and 2027, the model does not trigger a failure for this asset, as seen in the decision tree below:

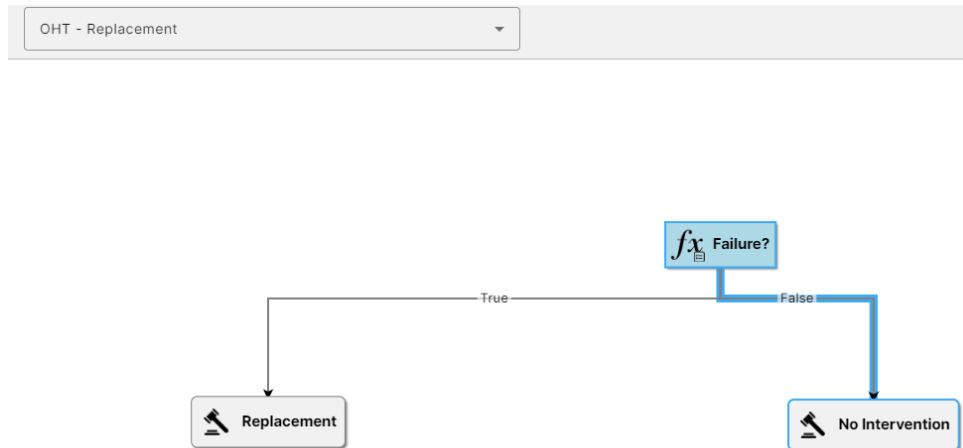

Detailed Inspections – Intrusive Inspections

Detailed inspections and intrusive inspections for overhead transformers have not been incorporated in this current phase of the model, as the decision logic has not been defined by BVES.

Replacement

In 2028, the model triggers an end-of-life failure for Overhead Transformer T10002BV:

OHT - Replacement

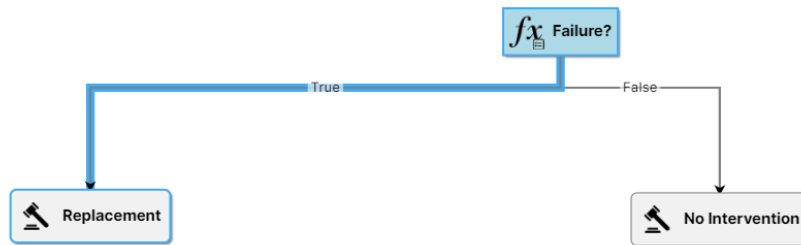

The overhead transformer replacement budget cap is set at \$200,000 per year. The prioritization order is set at the circuit level according to fire risk, meaning assets within circuits with the highest average fire risk will be prioritized. before moving to the next circuit in the prioritization order. When the budget reaches below 0, assets of the remaining circuits in the priority list must wait for the following year if they need to be replaced. In this situation, the OHT replacement budget was below 0 when OHT T10002BV ran through the decision tree and was marked as Replacement Backlog.

OHT - Replacement

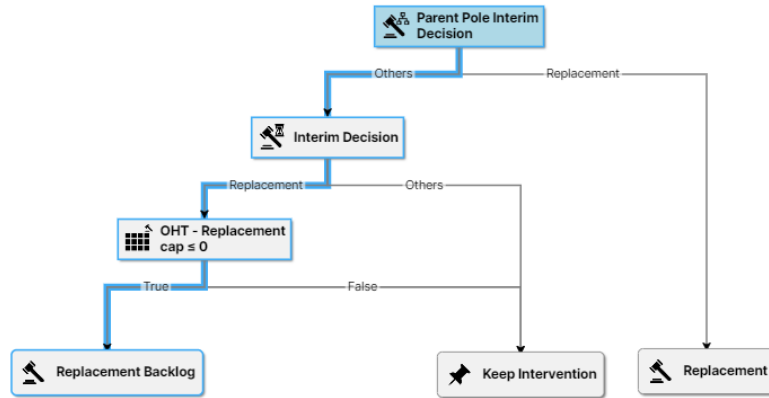

However, the parent of OHT T10002BV, Pole 10002BV was marked for replacement as the model has triggered a failed stress test:

Pole - Replacement for equipment

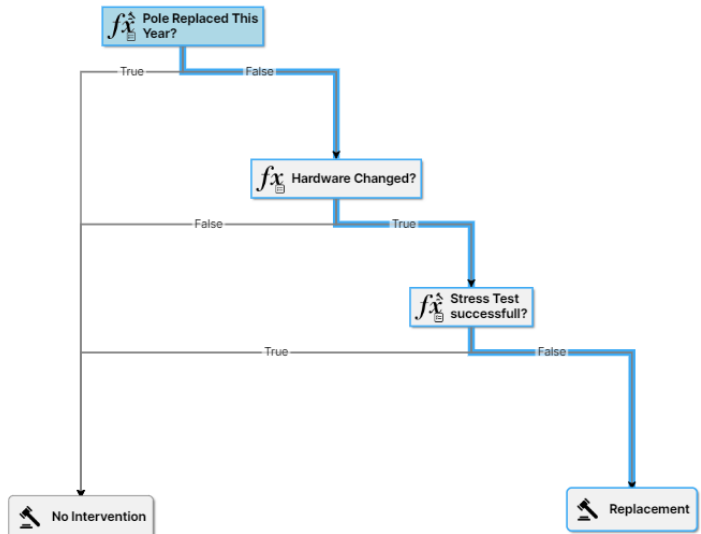

The decision tree considers the logic that any equipment on a pole needing replacement will also be replaced:

OHT - Replacement for equipment

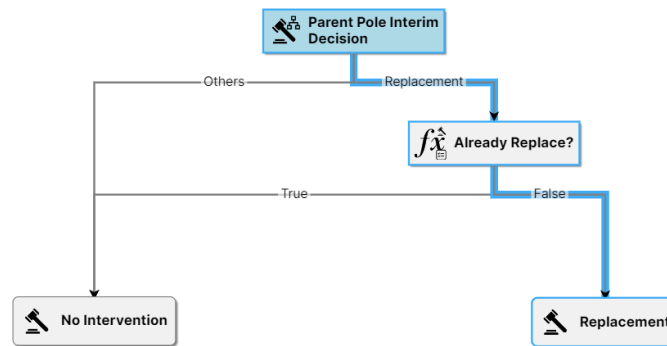

The overhead transformer replacement will reset several characteristic values (Age, Probability of Failure, Probability of Fire, CM – Overhead Transformer Failure) as well as trigger replacement costs:

Characteristic	↑	Beginning of Step	End of Step
Age		43	0
Age Range - Map		40-45	0-5
Already Failed?		True	False
Already Replace?		False	True
B material - Cost (Constant Value)		0	1200
B material - Cost (Current Value)		0	1200
CM - Overhead Transformer Failure		1.005	1.002
Failure - Numerical		1	0
Failure?		True	False
Installation Year		1985	2028
Labor Cost (Constant Value)		0	1075
Labor Cost (Current Value)		0	1075
Number of Replacements		0	1
Probability of Failure		0.006639	0.003
Probability of Failure - Choice		4	3
Probability of failure - Score		4	3
Probability of fire - Final		0.5023	0.501
Replacement Cost Total		0	5191
Replacement Material - Cost (Constant)		0	2916
Replacement Material - Cost (Current)		0	2916

Overhead Conductor

This use case will follow the step-by-step journey of Overhead Conductor OH_10008 T10002BV of iteration 1 between the start of the simulation in 2023, to its replacement in 2037:

Summary Analysis **Map** Degradations Occurrences Asset Value Details Step by Step

© MapTiler © OpenStreetMap contributors

Initial Characteristics		Asset Details	
Characteristic	2022	Description	OH_10008
Conductor Length	207.2	Asset Type Importation Code	OHC
Conductor Material	Copper ...	Asset Type Description	Overhead Conductor
CONDUCTORTYPE	Bare	Client Asset Code	OH_10008
INSTALLDATE	1998	ID	3045
StandardConductorOD	0.162	Parent #1	Bear Valley
wmBaseKv	4.16	Parent #2	Boulder Circuit
		Parent #3	2230 - D2229

Degradation

The overhead transformer is 25 years of age at the start of the simulation and ages by one year between 2023 and 2037.

Characteristic: Age | Degradation Type: After Tree Step

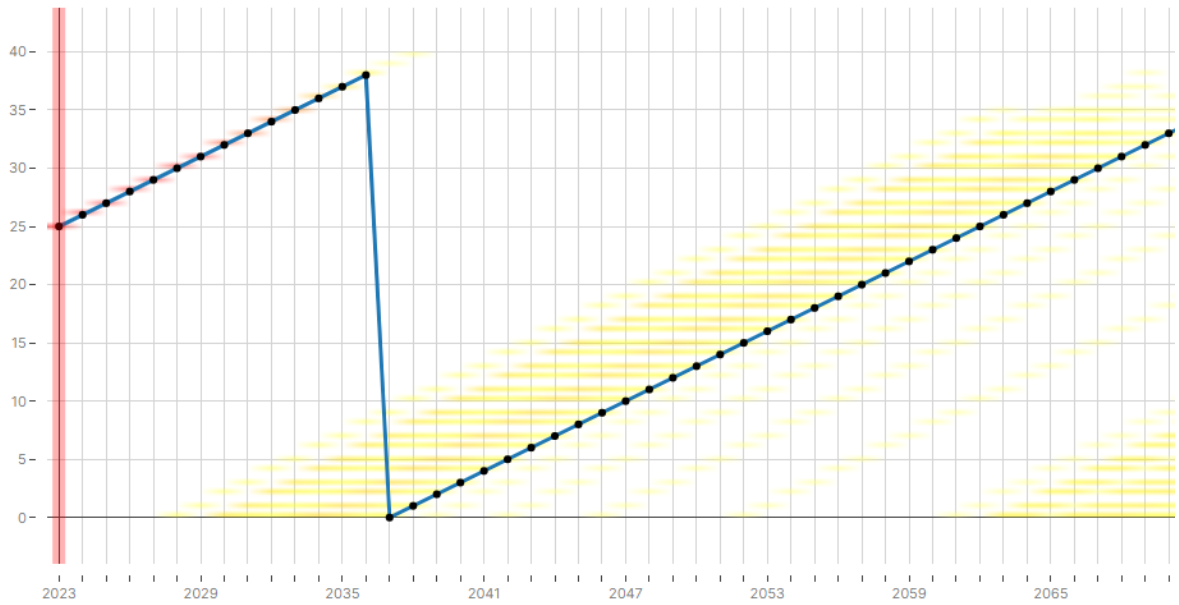

Between 2023 and 2036, the model does not trigger a failure for this asset, as seen in the decision tree below:

OHC - Failure 🔍

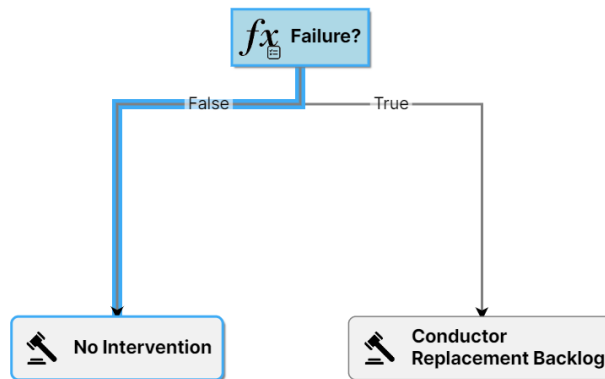

Detailed Inspections – Intrusive Inspections

Detailed inspections and intrusive inspections for overhead conductors have not been incorporated in this current phase of the model, as the decision logic has not been defined by BVES.

Replacement

From 2023 to 2036, no interventions are performed on OH_10008; no end-of-life failures are triggered and the GO.165 minimum requirements use case does not include any proactive replacements to mitigate fire risk:

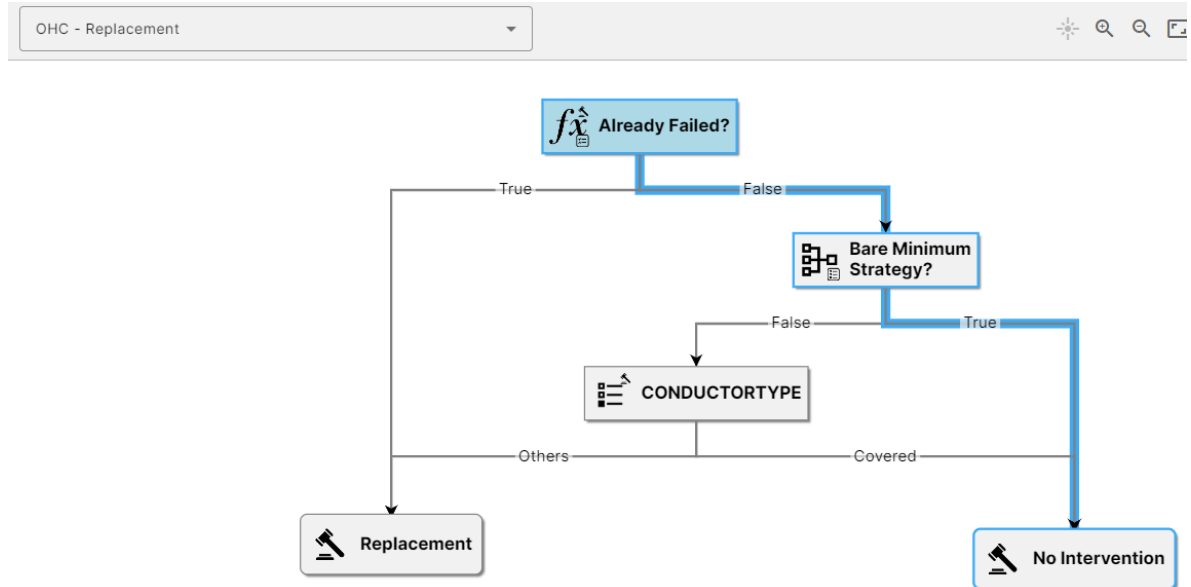

In 2037, the model triggers an end-of-life failure on OH_10008:

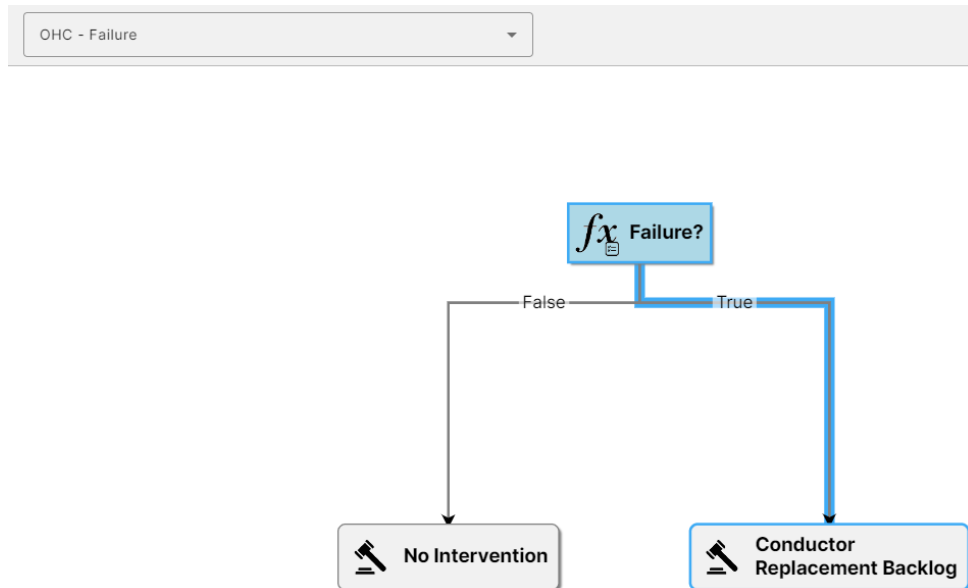

The overhead conductor replacement budget cap is set at \$2,000,000 per year. The prioritization order is set at the circuit level according to fire risk, meaning assets within circuits with the highest average fire risk will be prioritized. before moving to the next circuit in the prioritization order. When

the budget reaches below 0, assets of the remaining circuits in the priority list must wait for the following year if they need to be replaced. In this situation, the overhead conductor replacement budget was above 0 when OH_10008 ran through the decision tree and was marked as Replacement.

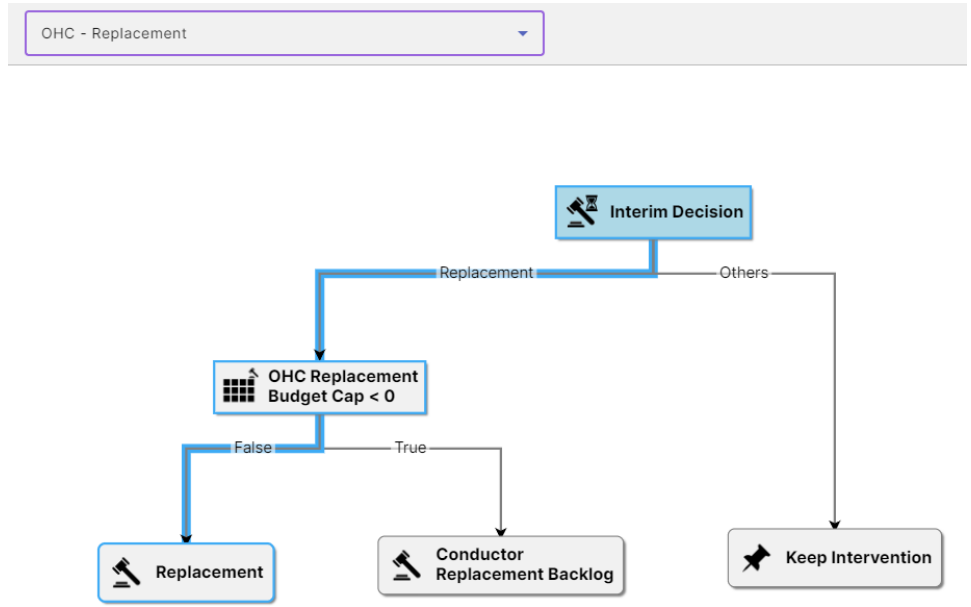

The overhead conductor replacement will reset several characteristic values (Age, Probability of Failure, Installation year) as well as trigger replacement costs:

Characteristic	↑	Beginning of Step	End of Step
Age		39	0
Age Range - Map		35-40	0-5
Already Failed?		True	False
Conductor Changed?		False	True
Conductor Replacement Backlog - Numerical		1	0
Conductor Replacement Backlog?		True	False
INSTALLDATE		1998	2037
Number of Overhead Conductor Replacement		0	1
Replacement Cost Total		0	3977
Replacement Labor - Cost (Constant Value)		0	3500
Replacement Labor - Cost (Current Value)		0	3500
Replacement Material - Cost (Constant Value)		0	476.6
Replacement Material - Cost (Current Value)		0	476.6
Total Cost (Constant)		0	3977

Under the minimum requirements for GO.165, the bare to covered conductor replacement program is not considered. As a result, there are no risk mitigation strategies evaluated for overhead conductors under this use case.

Current BVES Strategy

In addition to the minimum requirements under GO.165, this use case evaluates the impact of the following risk mitigation strategies:

1. Installation of fire wraps on poles
2. Proactive replacement of bare conductors
3. Implementation of vegetation management strategies

Poles

This use case will follow the step-by-step journey of Pole 0593BV of iteration 1 between the start of the simulation in 2023, to its replacement in 2031:

Initial Characteristics		Asset Details	
Characteristic	2022	Description	POL - 0593BV
CIRCUIT_ID	Goldmine Circuit	Asset Type Importation Code	POL
Fall in - Markov	Zone 2	Asset Type Description	Pole
FIRE_WRAP	False	Client Asset Code	
Grow in - Markov	Zone 1	ID	5397
HEIGHT	35	Parent #1	Bear Valley
INSTALLDATE	1995	Parent #2	Goldmine Circuit
INTINSP_INSPECT_DT	2011	Parent #3	4365 - D4364
Major Route?	N/A		
MATERIAL	Wood		
Tree Density	Medium		

Degradation

The pole is 28 years of age at the start of the simulation and ages by one year between 2023 and 2032.

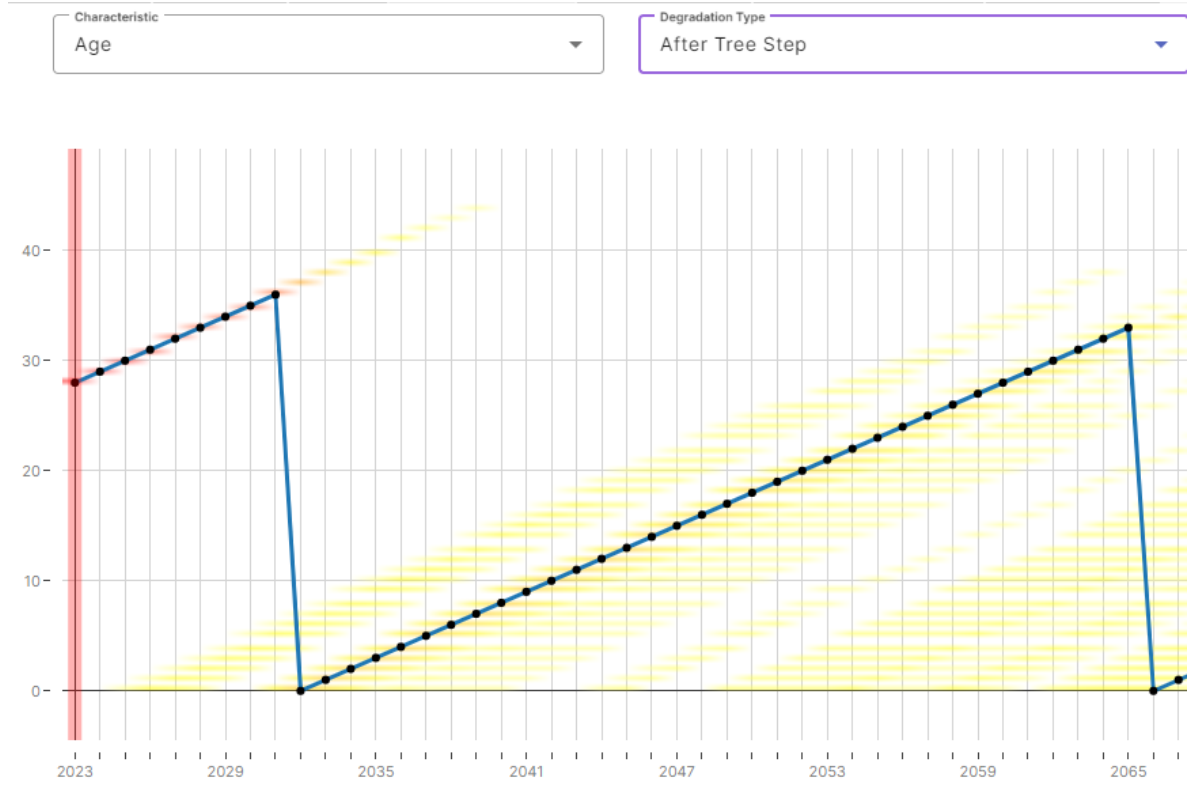

Between 2023 and 2031, the model does not trigger a failure for this asset, as seen in the decision tree below:

Pole - Failure

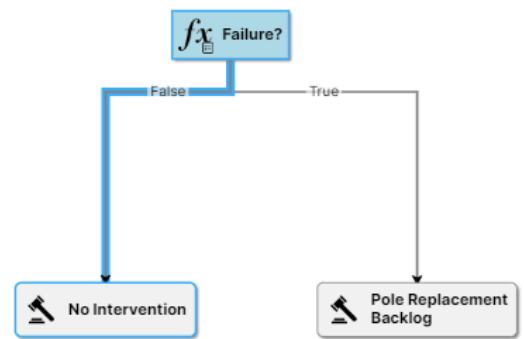

Detailed Inspections

Given that inspection cycle frequencies are set at the circuit level, the decision tree must validate whether the parent circuit of Pole 0593BV, Goldmine Circuit, is triggered for detailed inspection. Between 2023 and 2027, no detailed inspections take place on Goldmine Circuit, as this circuit is set on a 5-year cycle starting in 2028:

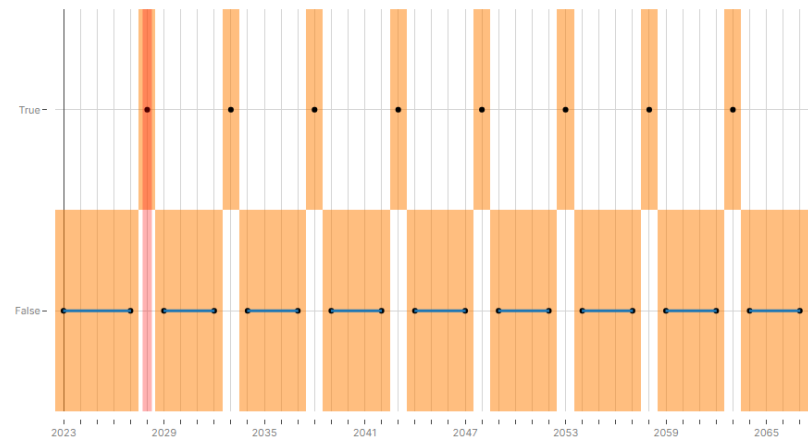
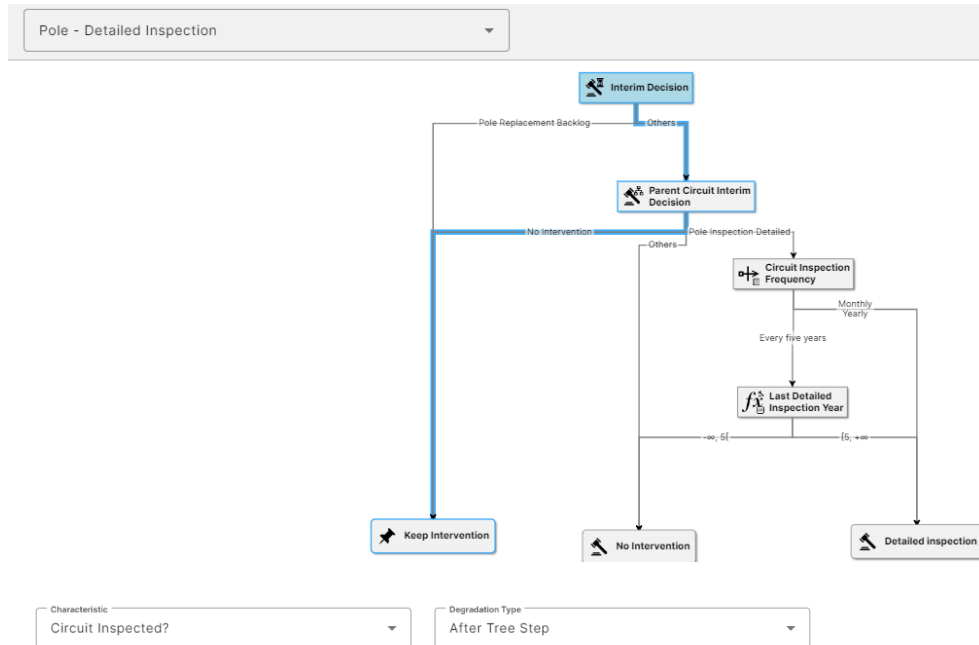

Intrusive Inspections

Intrusive inspection cycle frequencies are set at the pole level, but the information is brought to the parent circuit level to optimize the prioritization of interventions. In other words, if a pole is marked for intrusive inspection – is 10 years since its previous intrusive inspection – all other poles within that circuit that meet the criteria for intrusive inspections will be inspected. In 2023, Pole 0593BV is

triggered for intrusive inspection, therefore all other poles within Goldmine Circuit will run through the intrusive inspection decision tree. Because Pole 0593BV is over 15 years old and the model has triggered a “Passed” status on its previous intrusive inspection, the inspection cycle is set to 20 years. The years since the pole’s last intrusive inspection is 12 years, therefore it does not require one in 2023.

Pole - Intrusive Inspection

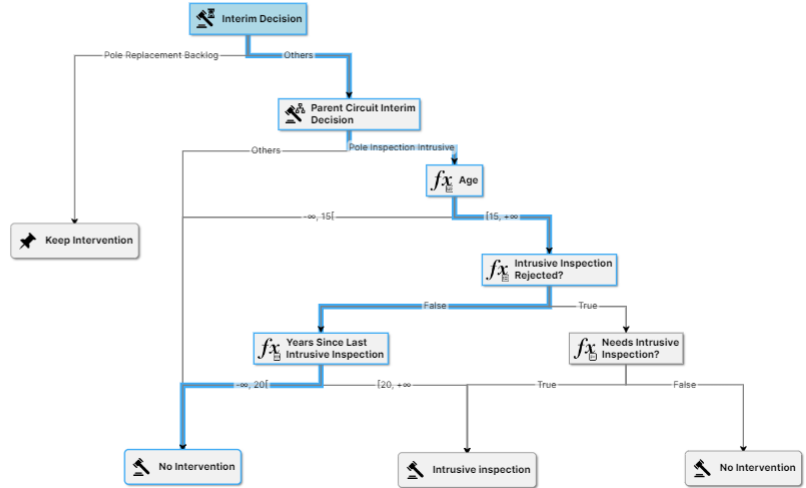

Characteristic: Years Since Last Intrusive Inspection

Degradation Type: After Tree Step

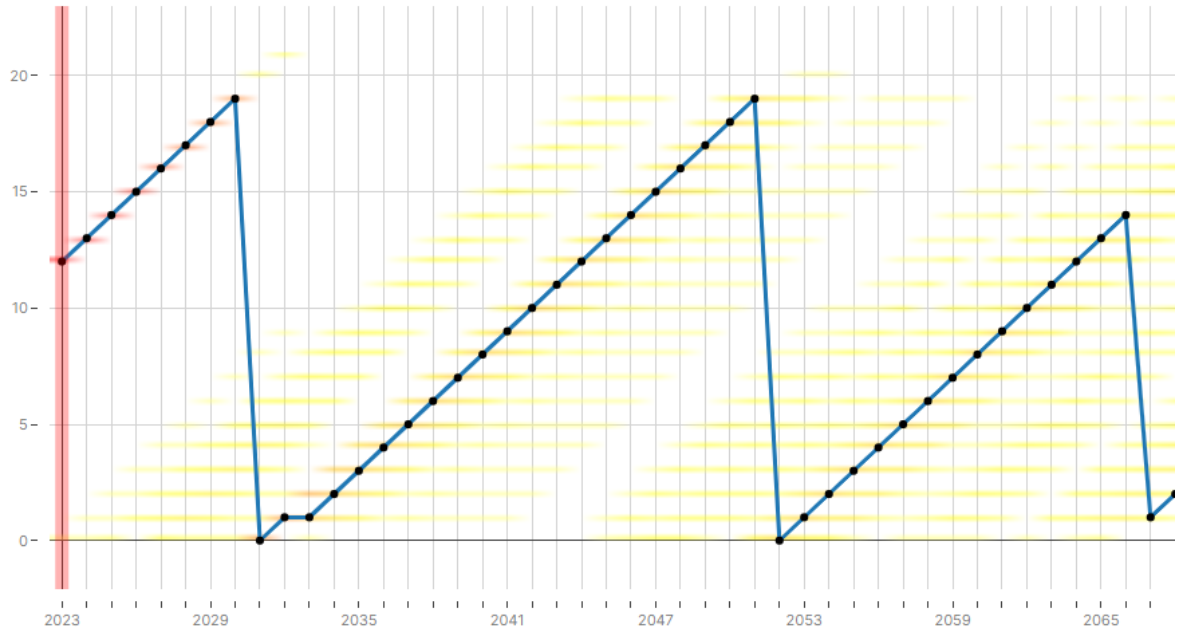

Replacement

Between 2023 and 2031, the model does not trigger an end-of-life failure on Pole 0593BV and, as a result, is not triggered for replacement:

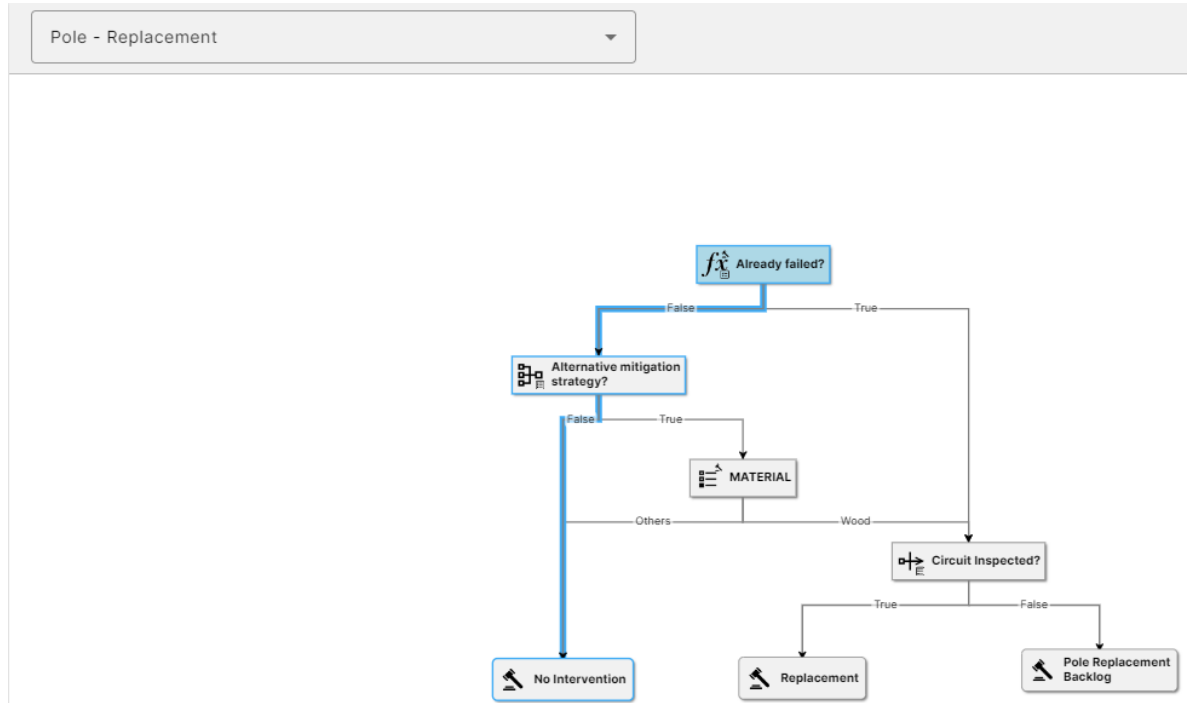

However, in 2032 the model triggers an end-of-life failure for this pole and because Goldmine Circuit is triggered for intrusive inspection, Pole 0593BV is triggered for replacement.

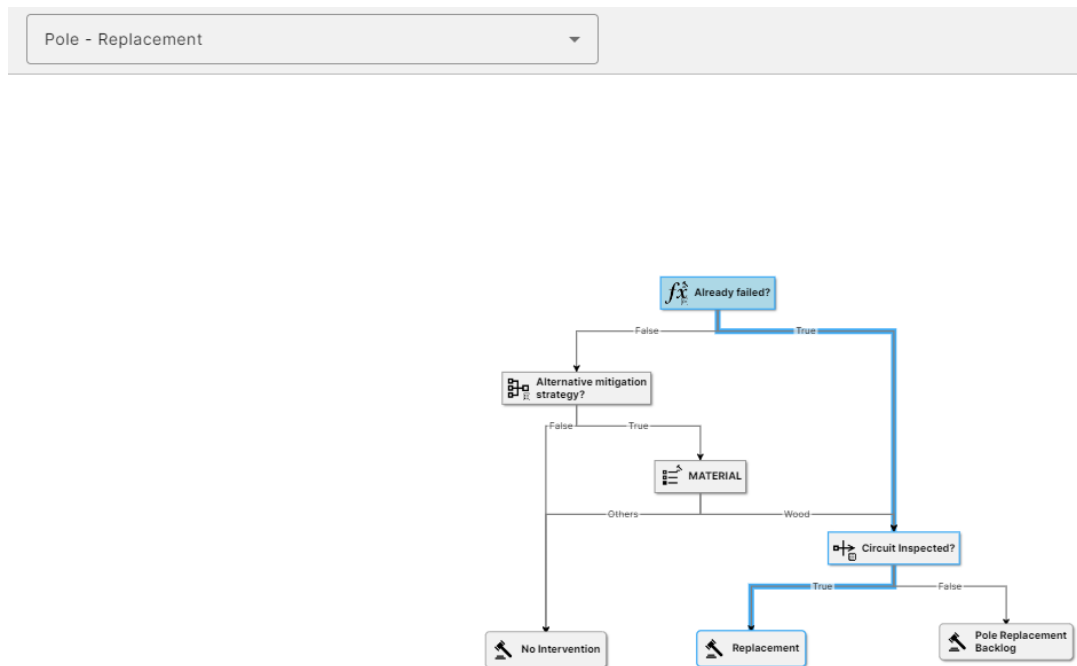

A pole replacement budget cap is set at \$6,000,000 per year. The prioritization order is set at the circuit level, meaning all poles flagged for replacement within an inspected circuit will be replaced, if there is sufficient budget available, before moving to the next circuit in the prioritization order. In this situation, sufficient budget was available to replace poles in Goldmine Circuit.

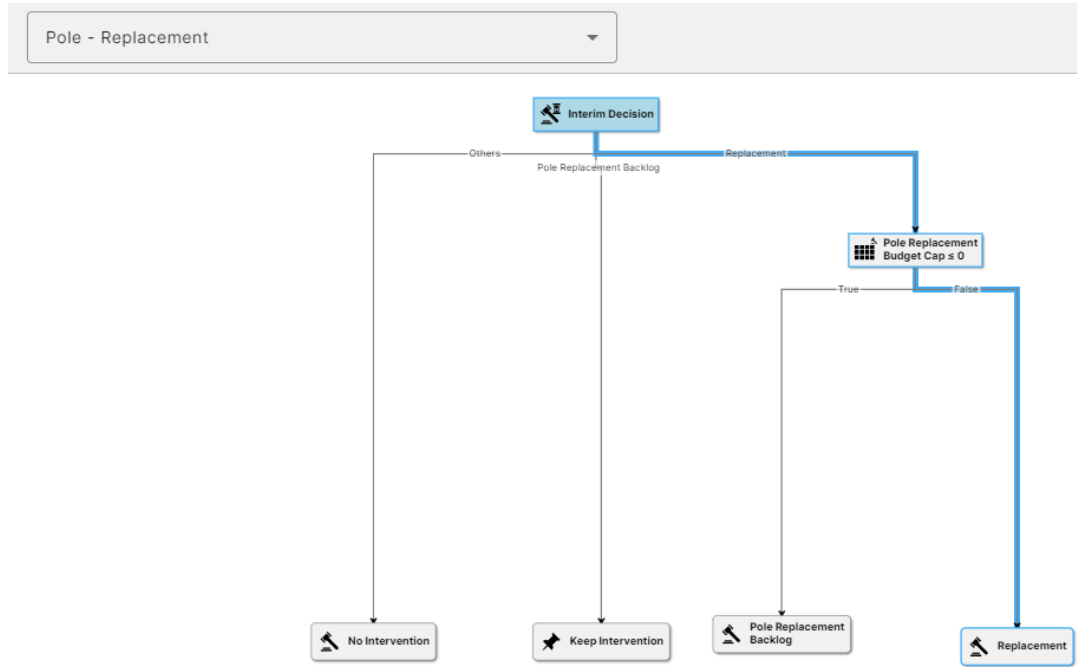

The pole replacement will reset several characteristic values (Age, Years Since Last Detailed Inspection, Years Since Last Intrusive Replacement) as well as trigger replacement costs:

Characteristic	↑	Beginning of Step	End of Step
Age		37	0
Age Range - Map		35-40	0-5
Already failed?		True	False
Asset is replaced?		False	True
Inspection Age Choice		Age-1	Age-0
INSTALLDATE		1995	2032
INTINSP_INSPECT_DT		2031	2032
Last Detailed Inspection Year		2028	2032
Number of Replacements		0	1
Pole Replaced This Year?		False	True
Pole Replacement Backlog - Numerical		1	0
Pole Replacement Backlog?		True	False
Replacement - Cost		0	15.37K
Replacement B Material - Cost		0	2500
Replacement B Material - Cost		0	2500
Replacement Labor - Cost (Constant		0	10K
Replacement Labor - Cost (Current		0	10K
Replacement Material - Cost (Constant		0	2872
Replacement Material - Cost (Current		0	2872

Grid Hardening

There are two interventions included in the grid hardening step: vegetation management and fire wrap installation. Vegetation management occurs around poles every five years as well as for all newly installed poles. The first vegetation management intervention on Pole 0593BV takes place in 2028, as it marks 5 years since the previous vegetation management intervention.

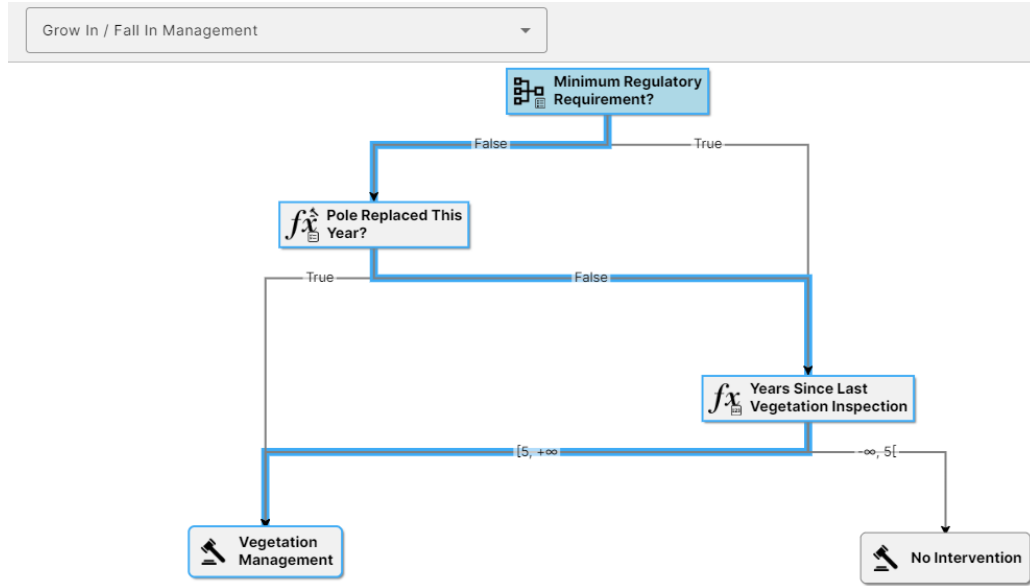

As a result, indicators such as the “CM – Vegetation” coefficient, fire risk, and the probability of fire are reduced for this asset:

Characteristic	↑	Beginning of Step	End of Step
f_x CM - Final		1	0.375
f_x CM - Vegetation		1	0.375
f_x CM - Vegetation Management (Fall In)		1	0.75
f_x CM - Vegetation Management (Grow)		1	0.5
f_x Fall in - Markov		Zone 2	Zone 3
f_x Fire Risk (Test)		27	6.75
f_x Grow in - Markov		Zone 1	Zone 3
f_x Last Vegetation Inspection Year		2023	2028
f_x LiDAR Inspection - Cost (Constant)		0	18
f_x LiDAR Inspection - Cost (Current)		0	18
f_x Probability of Fire - Final - Range		4	1
f_x Probability of Fire - Scaled		0.5	0.1875

Under the current BVES strategy, fire wrapping is installed on a maximum of 500 wooden poles per year. Wood poles located along a major route are prioritized first for fire wrapping. Wood poles triggered for fire wrapping but placed in the backlog due to the yearly cap of 500 being reached, represent the second order of prioritization. Between 2023 and 2028, Pole 0593BV is placed in the fire wrapping installation backlog. In 2029, fire wrapping is installed on the pole:

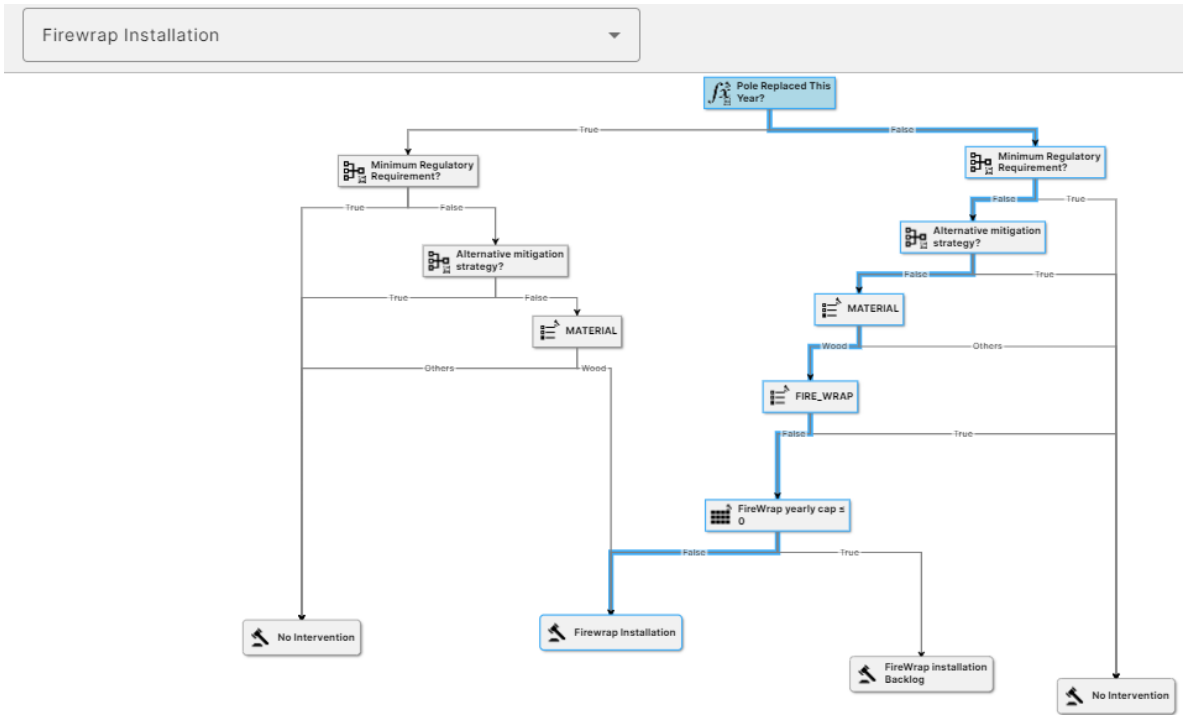

This intervention triggers a reduction in the “CM – Firewrap” coefficient characteristic which, in turn, lowers the probability of fire for this pole:



Characteristic	↑	Beginning of Step	End of Step
$f_{\hat{x}}$ CM - Final		0.5	0.4
$f_{\hat{x}}$ CM - Firewrap		1	0.8
$f_{\hat{x}}$ FIRE_WRAP		False	True
$f_{\hat{x}}$ Firewrap - Cost (Constant Value)		0	100
$f_{\hat{x}}$ Firewrap - Cost (Current Value)		0	100
$f_{\hat{x}}$ Firewrap Backlog - Numerical		1	0
$f_{\hat{x}}$ Firewrap Backlog?		True	False
$f_{\hat{x}}$ Probability of Fire - Scaled		0.25	0.2
$f_{\hat{x}}$ Total Cost (Constant)		9.92	109.9
$f_{\hat{x}}$ Yearly Number of Firewrap		0	1

As mentioned earlier, Pole 0593BV is eventually replaced due to an end-of-life failure in 2032. This triggers another vegetation management intervention and further reduces its fire risk:

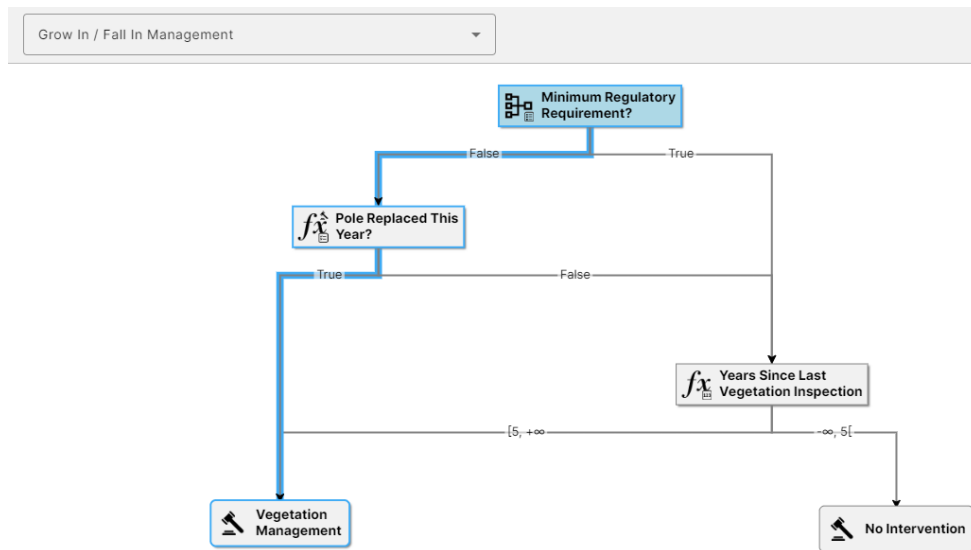



The short timeframe between the initial fire wrap installation in 2028 and the eventual end-of-life replacement of Pole 0593BV in 2023 suggests there may be opportunities to synchronize these interventions by proactively replacing wood poles that have a high probability of failure. Further analysis would be necessary to determine the appropriate threshold to trigger proactive wood pole replacements and may be discussed as part of future model enhancements.

Overhead Transformers

This use case will follow the step-by-step journey of Overhead Transformer T10002BV of iteration 1 between the start of the simulation in 2023, to its replacement in 2030:

Summary Analysis **Map** Degradations Occurrences Asset Value Details Step by Step

© MapTiler © OpenStreetMap contributors

Initial Characteristics		Asset Details	
Characteristic	2022	Description	OHT - T10002BV
Installation Year	1985	Asset Type Importation Code	OHT
KVAA	25	Asset Type Description	Overhead Transformer
KVAB	0	Client Asset Code	
KVAC	0	ID	2093
KVAMEAN	8.333	Parent #1	Bear Valley
Number of Cust...	14	Parent #2	Shay Circuit
		Parent #3	7033 - T551

Degradation

The overhead transformer is 38 years of age at the start of the simulation and ages by one year between 2023 and 2030.

Characteristic: Degradation Type:

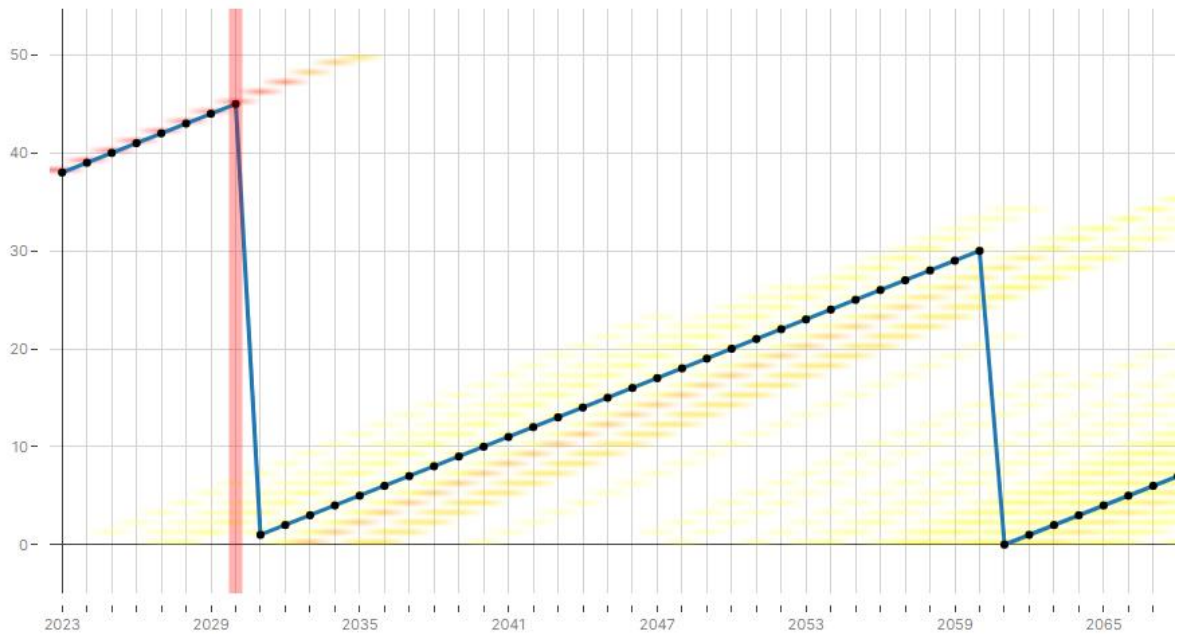

Between 2023 and 2029, the model does not trigger a failure for this asset, as seen in the decision tree below:

OHT - Replacement

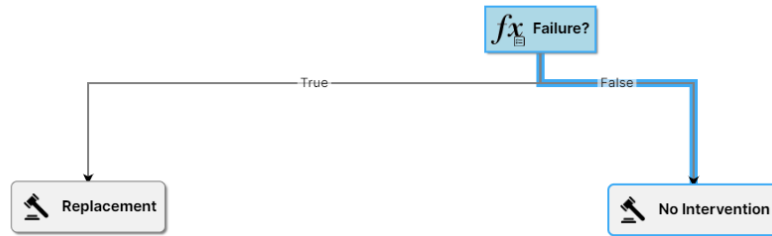

Detailed Inspections – Intrusive Inspections

Detailed inspections and intrusive inspections for overhead transformers have not been incorporated in this current phase of the model, as the decision logic has not been defined by BVES.

Replacement

In 2030, the model triggers an end-of-life failure for Overhead Transformer T10002BV:

OHT - Replacement

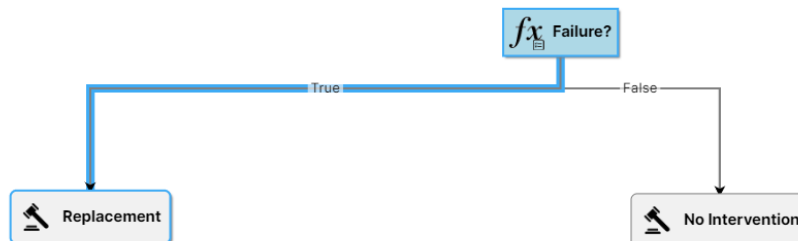

The overhead transformer replacement budget cap is set at \$200,000 per year. The prioritization order is set at the circuit level according to fire risk, meaning assets within circuits with the highest average fire risk will be prioritized. before moving to the next circuit in the prioritization order. When

the budget reaches below 0, assets of the remaining circuits in the priority list must wait for the following year if they need to be replaced. In this situation, the OHT replacement budget was below 0 when OHT T10002BV ran through the decision tree and was marked as Replacement Backlog.

OHT - Replacement

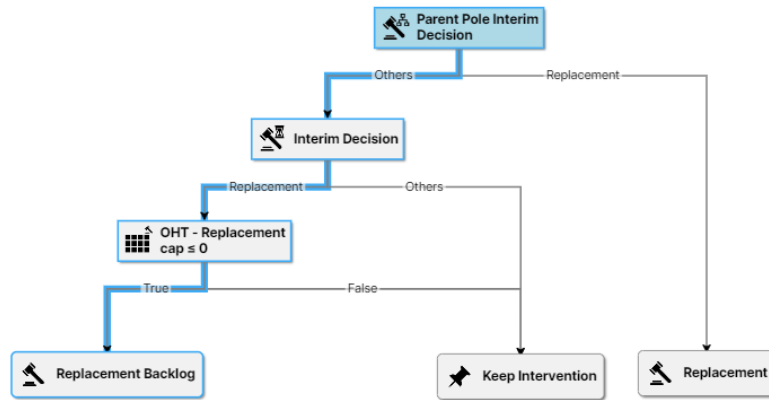

However, the parent of OHT T10002BV, Pole 10002BV was marked for replacement as the model has triggered a failed stress test:

Pole - Replacement for equipment

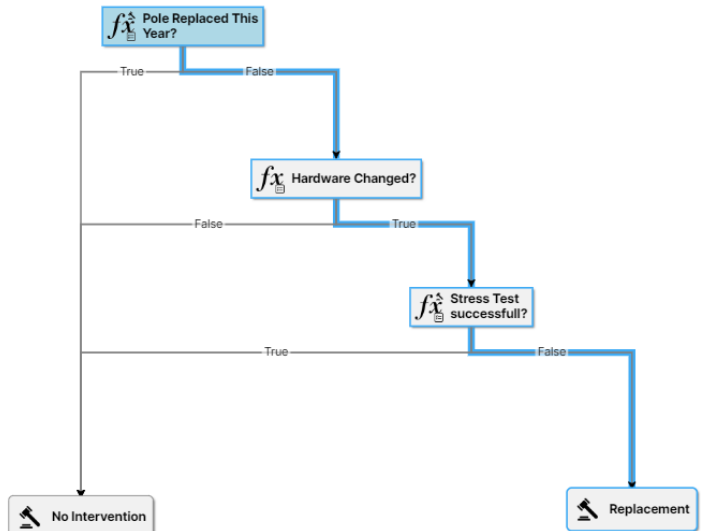

The decision tree considers the logic that any equipment on a pole needing replacement will also be replaced:

OHT - Replacement for equipment

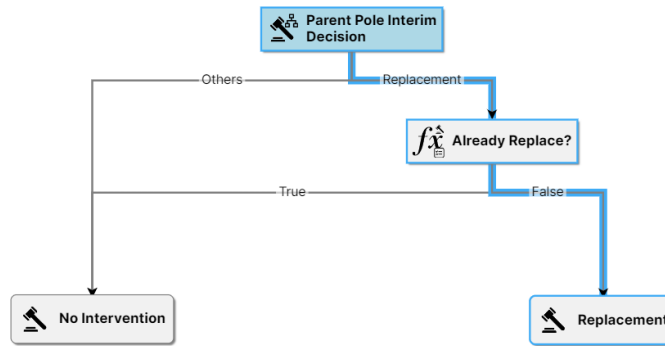

The overhead transformer replacement will reset several characteristic values (Age, Probability of Failure, Probability of Fire, CM – Overhead Transformer Failure) as well as trigger replacement costs:

Characteristic	↑	Beginning of Step	End of Step
Age		45	0
Age Range - Map		45-50	0-5
Already Failed?		True	False
Already Replace?		False	True
B material - Cost (Constant Value)		0	1200
B material - Cost (Current Value)		0	1200
CM - Overhead Transformer Failure		1.007	1.002
Failure - Numerical		1	0
Failure?		True	False
Installation Year		1985	2030
Labor Cost (Constant Value)		0	1075
Labor Cost (Current Value)		0	1075
Number of Replacements		0	1
Probability of Failure		0.01026	0.003
Probability of Failure - Choice		5	3
Probability of failure - Score		5	3
Probability of fire - Final		0.5036	0.501
Replacement Cost Total		0	5191
Replacement Material - Cost		0	2916
Replacement Material - Cost (Current		0	2916

Overhead Conductor

This use case will follow the step-by-step journey of Overhead Conductor OH_10008 T10002BV of iteration 1 between the start of the simulation in 2023, to its replacement in 2032:

Summary
Analysis
Map
Degradations
Occurrences
Asset Value Details
Step by Step

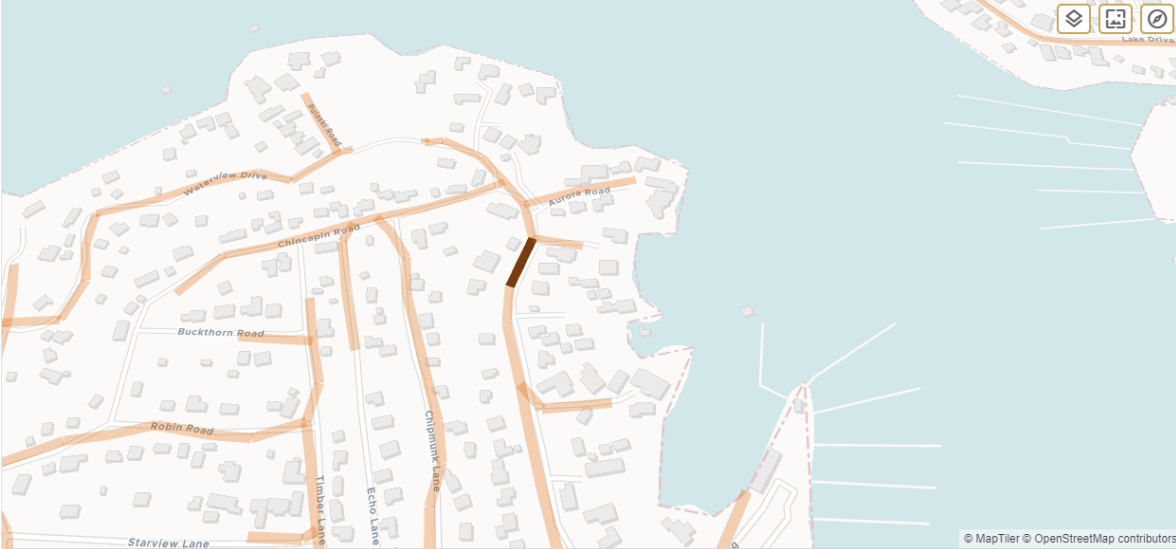

Initial Characteristics

Characteristic	2022
Conductor Length	207.2
Conductor Material	Copper ...
CONDUCTORTYPE	Bare
INSTALLDATE	1998
StandardConductorOD	0.162
wmBaseKv	4.16

Asset Details

Description	OH_10008
Asset Type Importation Code	OHC
Asset Type Description	Overhead Conductor
Client Asset Code	OH_10008
ID	3045
Parent #1	Bear Valley
Parent #2	Boulder Circuit
Parent #3	2230 - D2229

Degradation

The overhead transformer is 25 years of age at the start of the simulation and ages by one year between 2023 and 2032.

Characteristic: Degradation Type:

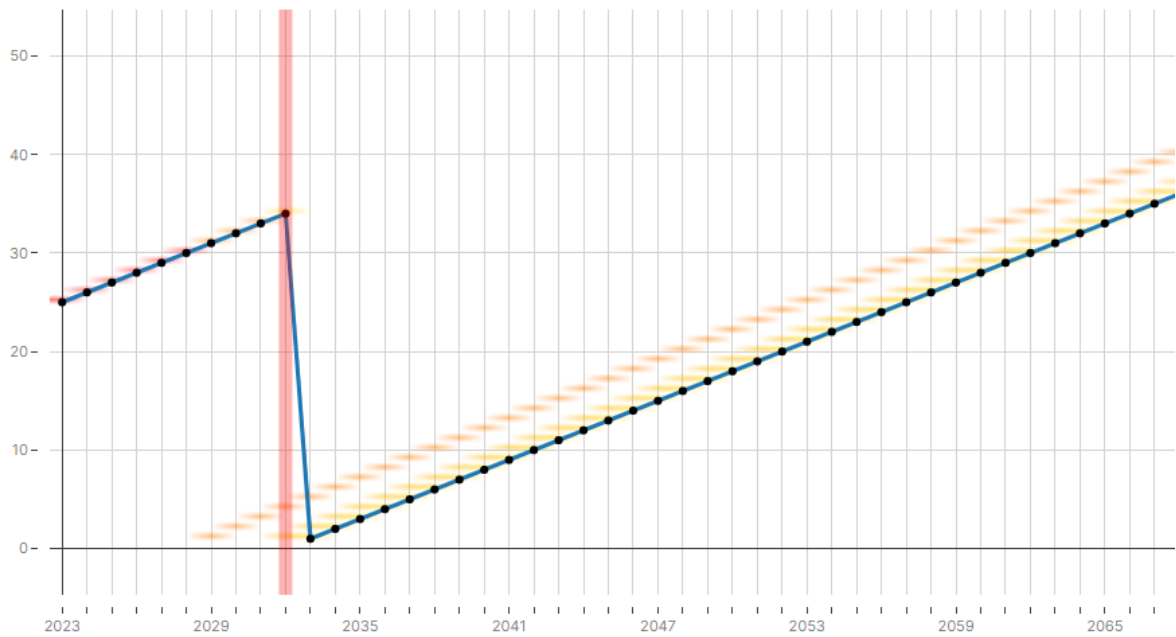

Between 2023 and 2031, the model does not trigger a failure for this asset, as seen in the decision tree below:

OHC - Failure

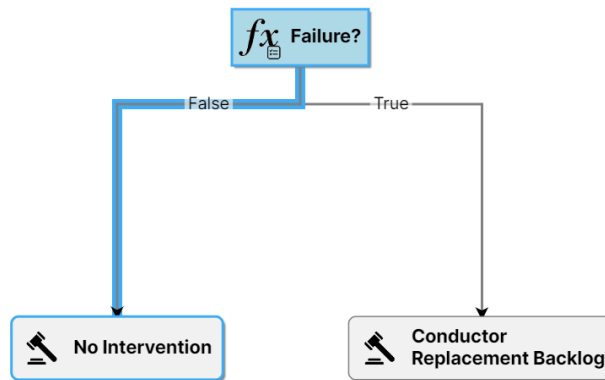

Detailed Inspections – Intrusive Inspections

Detailed inspections and intrusive inspections for overhead conductors have not been incorporated in this current phase of the model, as the decision logic has not been defined by BVES.

Replacement

From 2023 to 2031, no interventions are performed on OH_10008. It is a bare conductor type and although it is flagged for replacement as part of the bare to covered conductor replacement program, the replacement is delayed due to insufficient budget:

OHC - Replacement

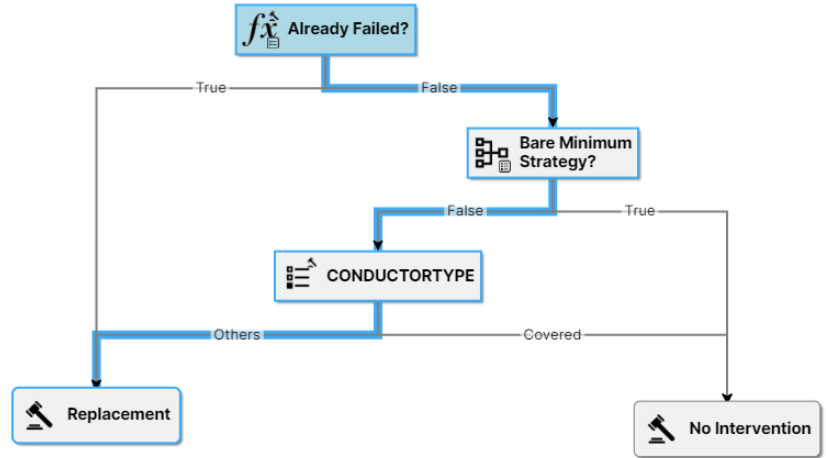

OHC - Replacement

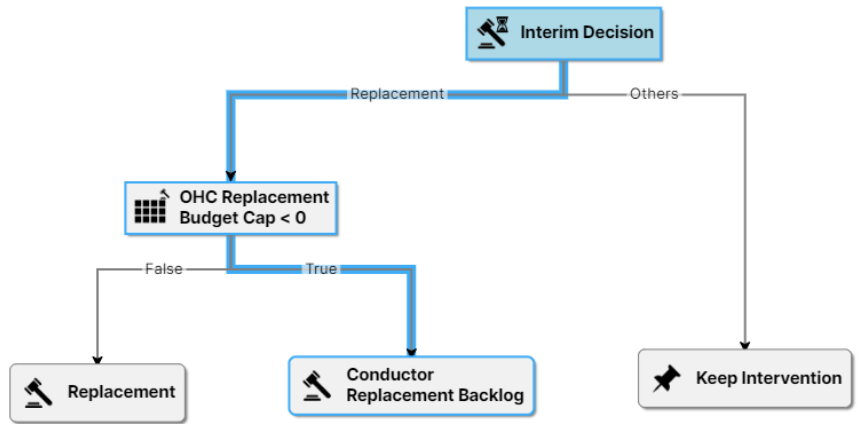

In 2032, OH_10008 is prioritized for replacement:

OHC - Replacement ⊛

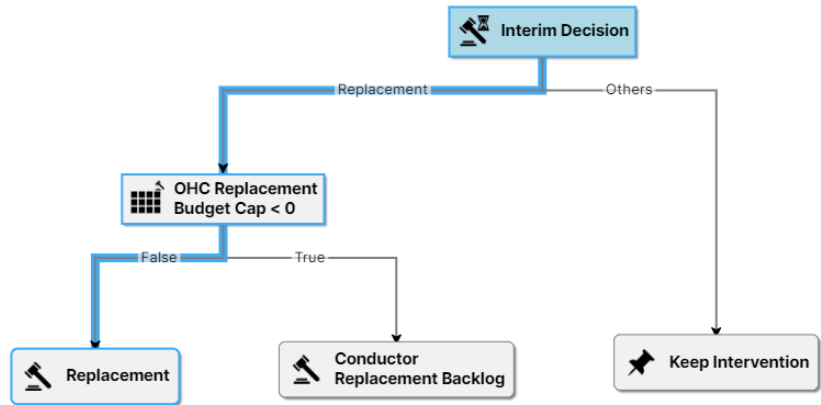

The overhead conductor replacement budget cap is set at \$2,000,000 per year. The prioritization order is set at the circuit level according to fire risk, meaning assets within circuits with the highest average fire risk will be prioritized. before moving to the next circuit in the prioritization order. When the budget reaches below 0, assets of the remaining circuits in the priority list must wait for the following year if they need to be replaced. In this situation, the overhead conductor replacement budget was above 0 in 2032 when OH_10008 ran through the decision tree and was marked as Replacement.

The overhead conductor replacement will reset several characteristic values (Age, Probability of Failure, Installation year) as well as trigger replacement costs:

Characteristic	↑	Beginning of Step	End of Step
Age		34	0
Age Range - Map		30-35	0-5
Already Failed?		True	False
CM - Conductor Type		1	0.5
CM - Final		1	0.5
Conductor Changed?		False	True
Conductor Replacement Backlog -		1	0
Conductor Replacement Backlog?		True	False
CONDUCTORTYPE		Bare	Covered
Fire Risk		45	27
Fire Risk Reduction Benefit		0	18
Fire Risk Reduction Percentage		0	22.22
INSTALLDATE		1998	2032
Number of Bare to Cover		0	1
Number of Overhead Conductor		0	1
Probability of Fire - Final		0.5	0.25
Probability of Fire - Score		5	3
Replacement Cost Total		0	3977
Replacement Labor - Cost (Constant		0	3500
Replacement Labor - Cost (Current		0	3500
Replacement Material - Cost		0	476.6
Replacement Material - Cost (Current		0	476.6
Total Cost (Constant)		0	3977

Converting a bare to a covered conductor reduces the probability of fire which, in turn, reduces the fire risk for this asset:

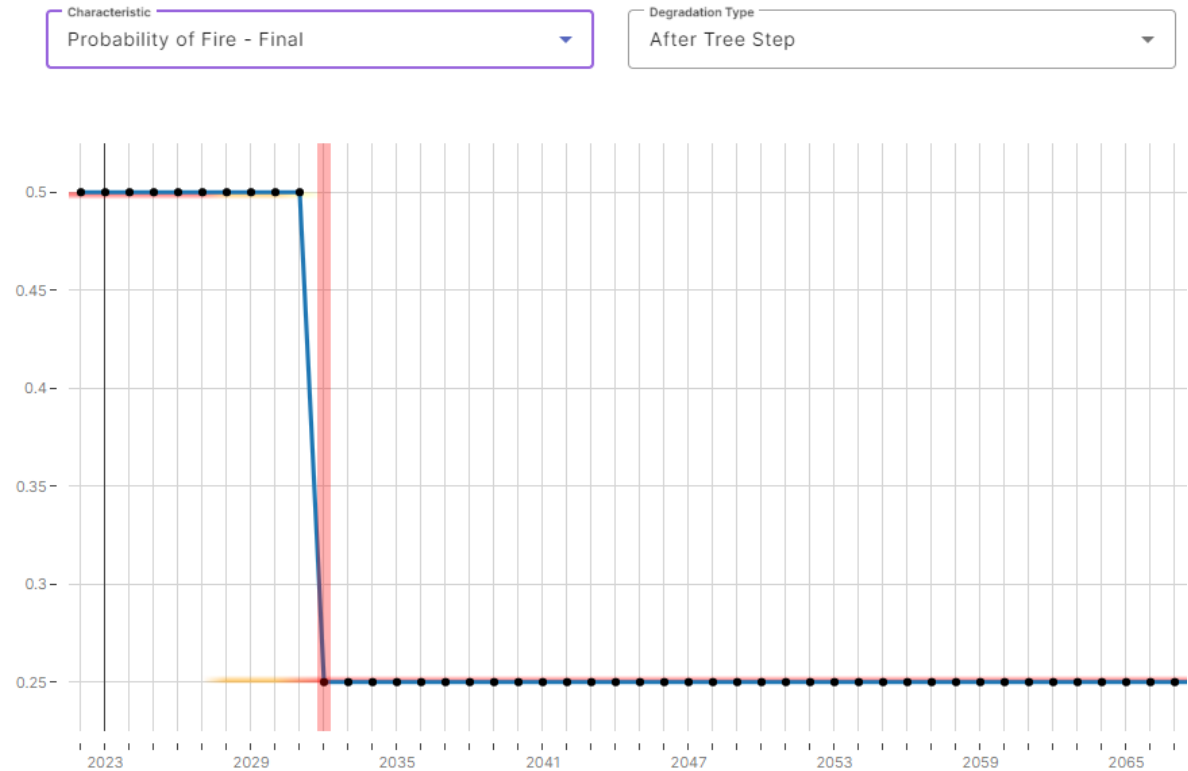

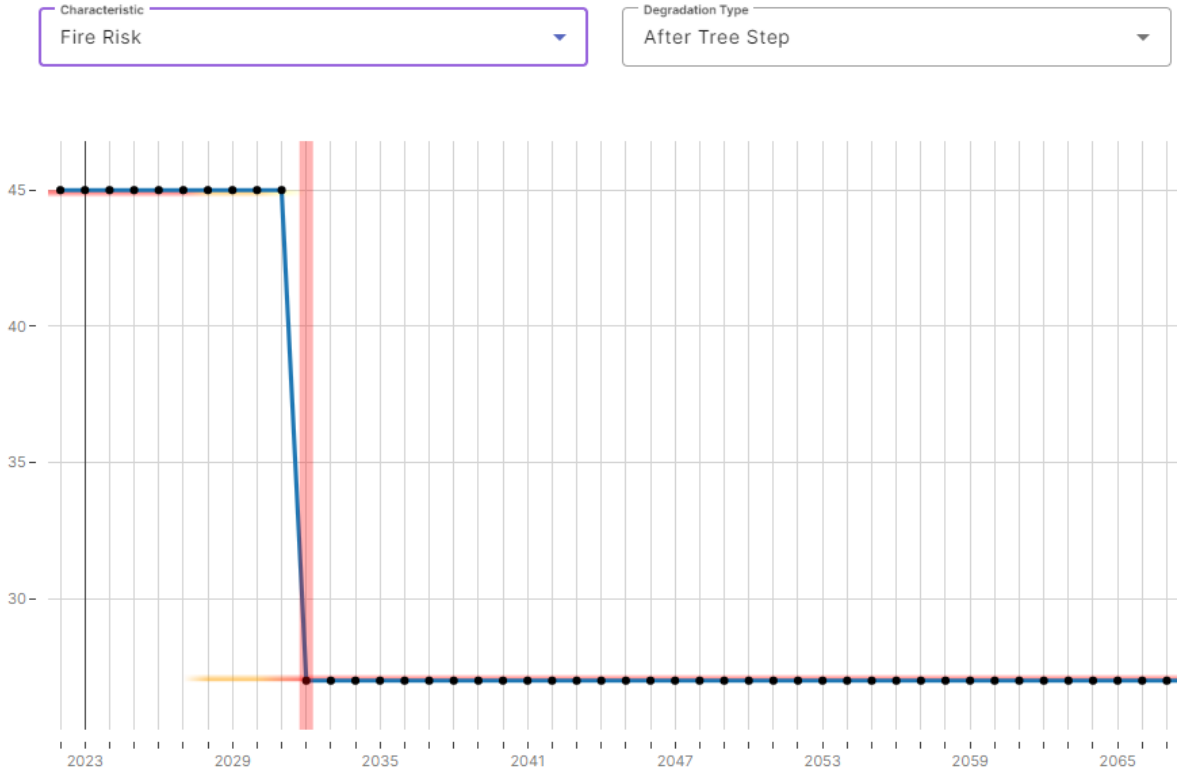

Alternative Mitigation Strategy

This use case explores the impact of replacing wooden poles with steel poles, as an alternative to fire wrapping installation in the current BVES strategy. Given that this use case impacts only poles from a risk mitigation standpoint, overhead conductors and overhead transformers will be excluded from this analysis.

Poles

This use case will follow the step-by-step journey of Pole 0593BV of iteration 1 between the start of the simulation in 2023, to its replacement in 2026:

Summary
Analysis
Map
Degradations
Occurrences
Asset Value Details
Step by Step

© MapTier © OpenStreetMap contributors

Initial Characteristics

Characteristic	2022
CIRCUIT_ID	Goldmine Circuit
Fall in - Markov	Zone 2
FIRE_WRAP	False
Grow in - Markov	Zone 1
HEIGHT	35
INSTALLDATE	1995
INTINSP_INSPECT_DT	2011
Major Route?	N/A
MATERIAL	Wood
Tree Density	Medium

Asset Details

Description	POL - 0593BV
Asset Type Importation Code	POL
Asset Type Description	Pole
Client Asset Code	
ID	5397
Parent #1	Bear Valley
Parent #2	Goldmine Circuit
Parent #3	4365 - D4364

Degradation

The pole is 28 years of age at the start of the simulation and ages by one year between 2023 and 2026.

Characteristic: Degradation Type:

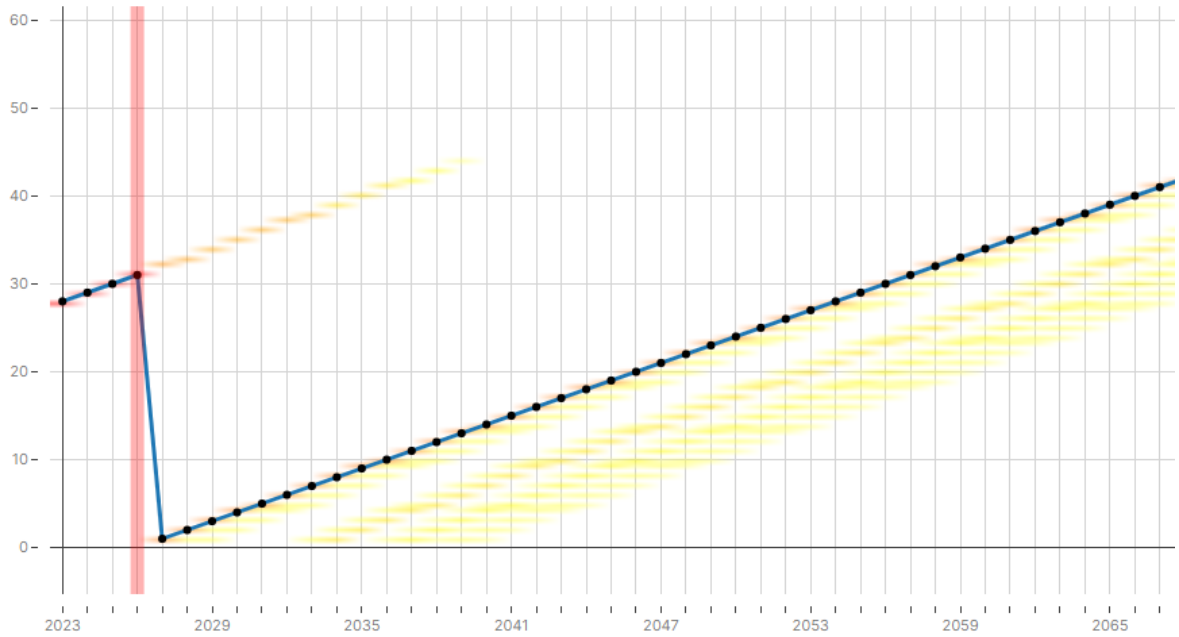

Between 2023 and 2025, the model does not trigger a failure for this asset, as seen in the decision tree below:

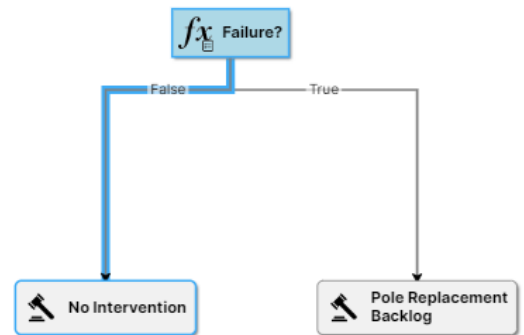

Detailed Inspections

Given that inspection cycle frequencies are set at the circuit level, the decision tree must validate whether the parent circuit of Pole 0593BV, Goldmine Circuit, is triggered for detailed inspection. Between 2023 and 2027, no detailed inspections take place on Goldmine Circuit, as this circuit is set on a 5-year cycle starting in 2028:

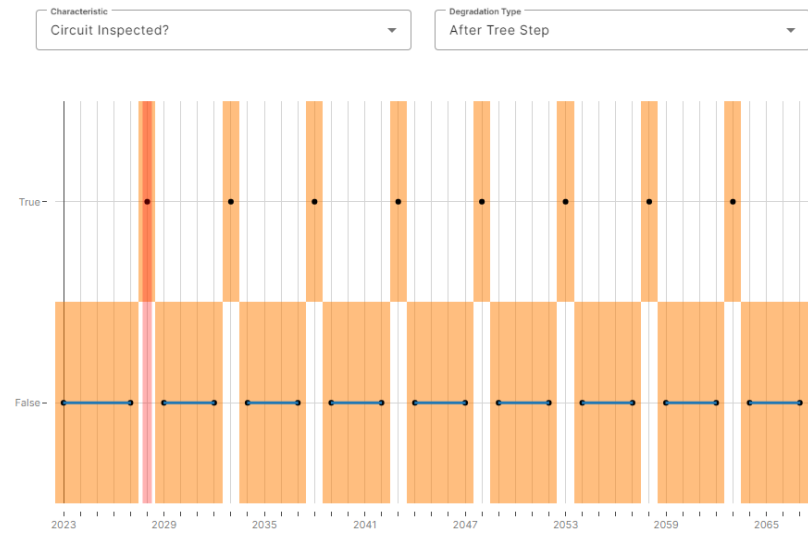
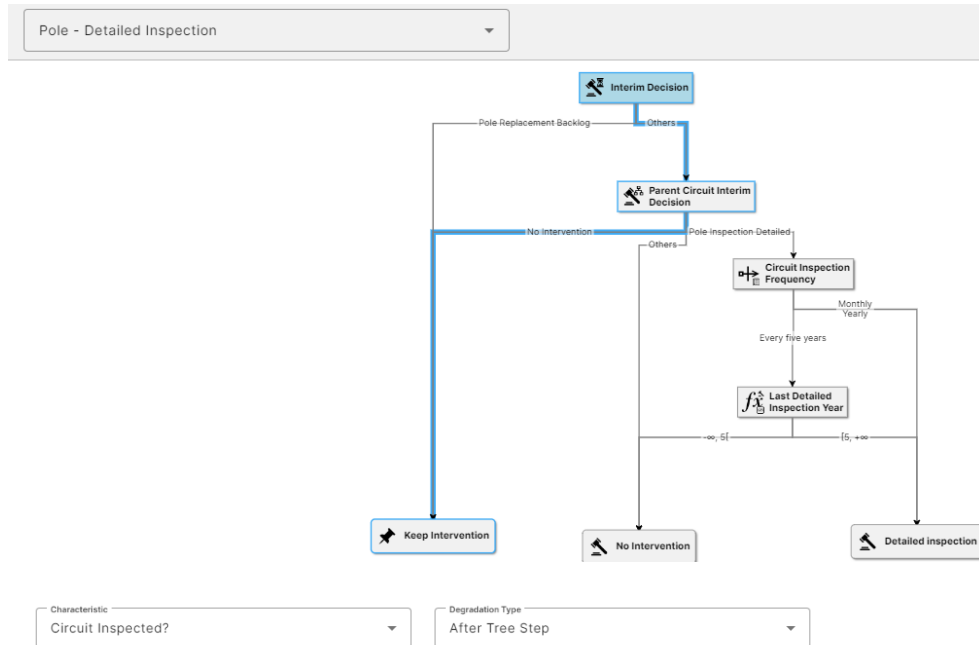

Intrusive Inspections

Intrusive inspection cycle frequencies are set at the pole level, but the information is brought to the parent circuit level to optimize the prioritization of interventions. In other words, if a pole is marked for intrusive inspection – is 10 years since its previous intrusive inspection – all other poles within that circuit that meet the criteria for intrusive inspections will be inspected. In 2023, Pole 0593BV is

triggered for intrusive inspection, therefore all other poles within Goldmine Circuit will run through the intrusive inspection decision tree. Because Pole 0593BV is over 15 years old and the model has triggered a “Passed” status on its previous intrusive inspection, the inspection cycle is set to 20 years. The years since the pole’s last intrusive inspection is 12 years, therefore it does not require one in 2023. An intrusive inspection takes place in 2026, which coincides with the year the pole is replaced:

Pole - Intrusive Inspection

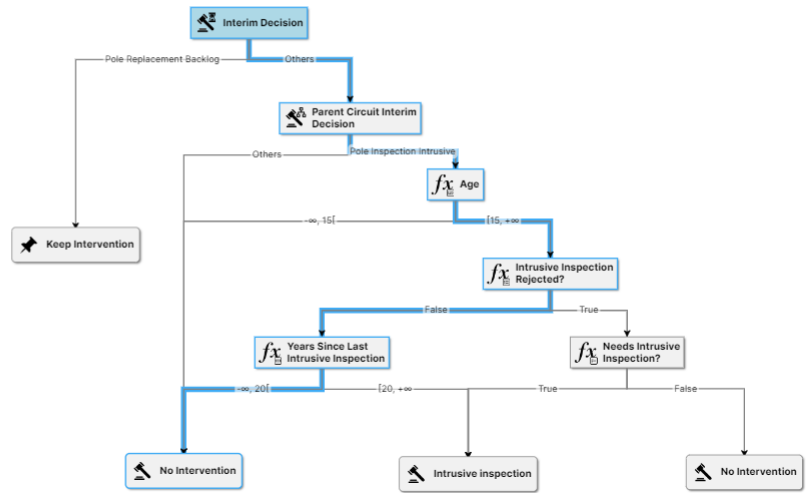

Characteristic: Years Since Last Intrusive Inspection

Degradation Type: Before Step

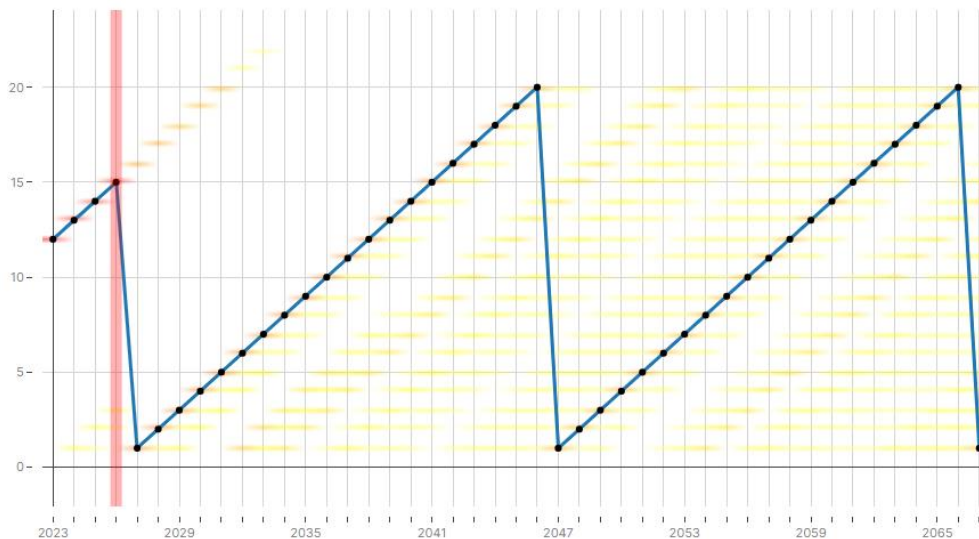

Grid Hardening

As part of the GO.165 minimum requirements, vegetation management around poles takes place every 5 years. As seen in the image below, vegetation management occurs on Pole 0593BV in 2026, which coincides with the year the pole is replaced:

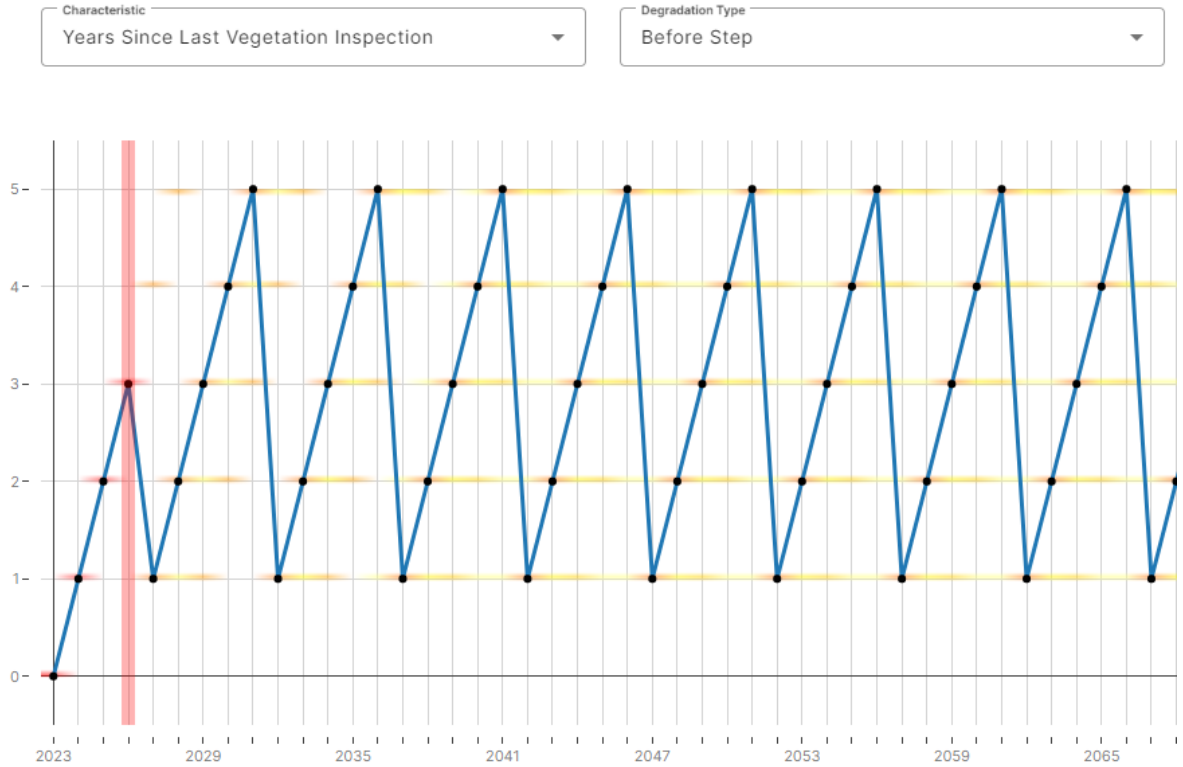

The decision tree checks whether the years since the last vegetation inspection for each pole is 5 years or over or if the pole is replaced this year:

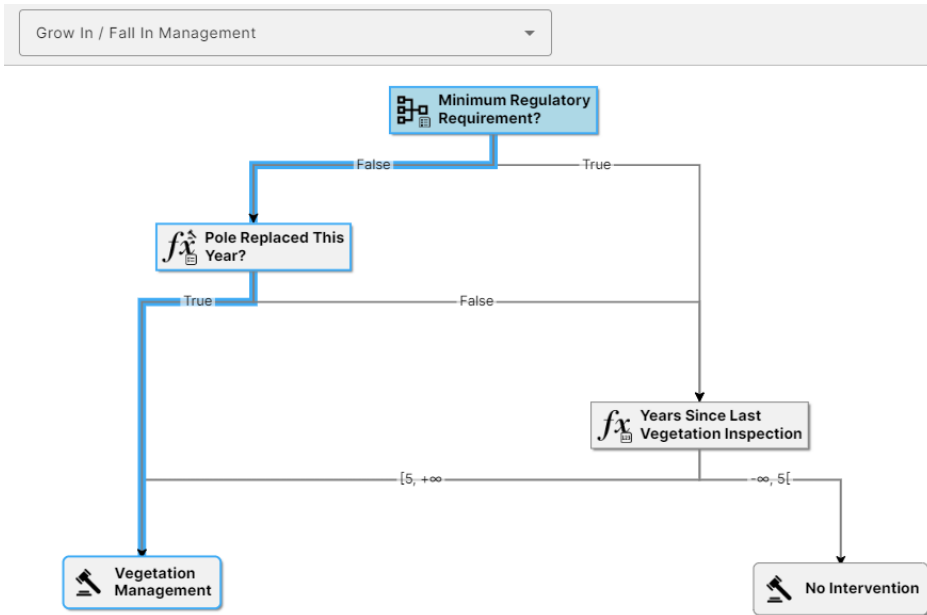

Vegetation management, coupled with a wood to steel pole replacement, have an impact on risk mitigation, as it reduces the probability of fire for this specific asset which, in turn, reduces its fire risk:

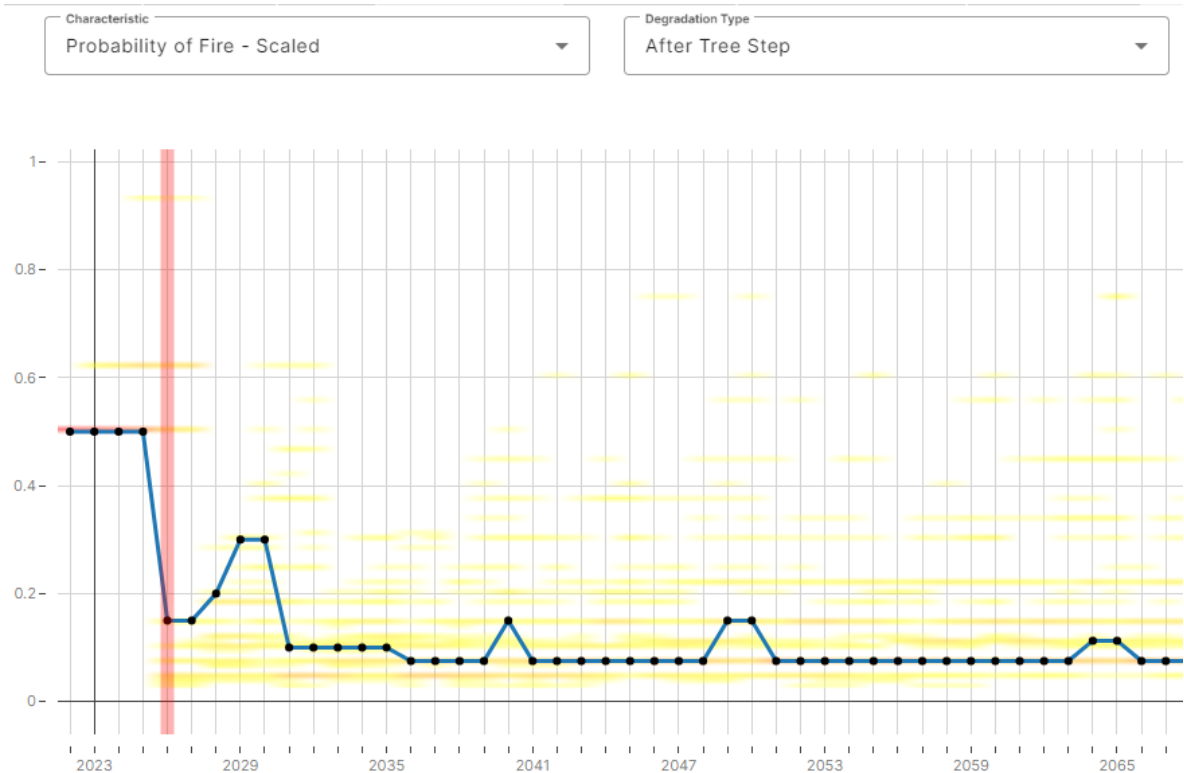

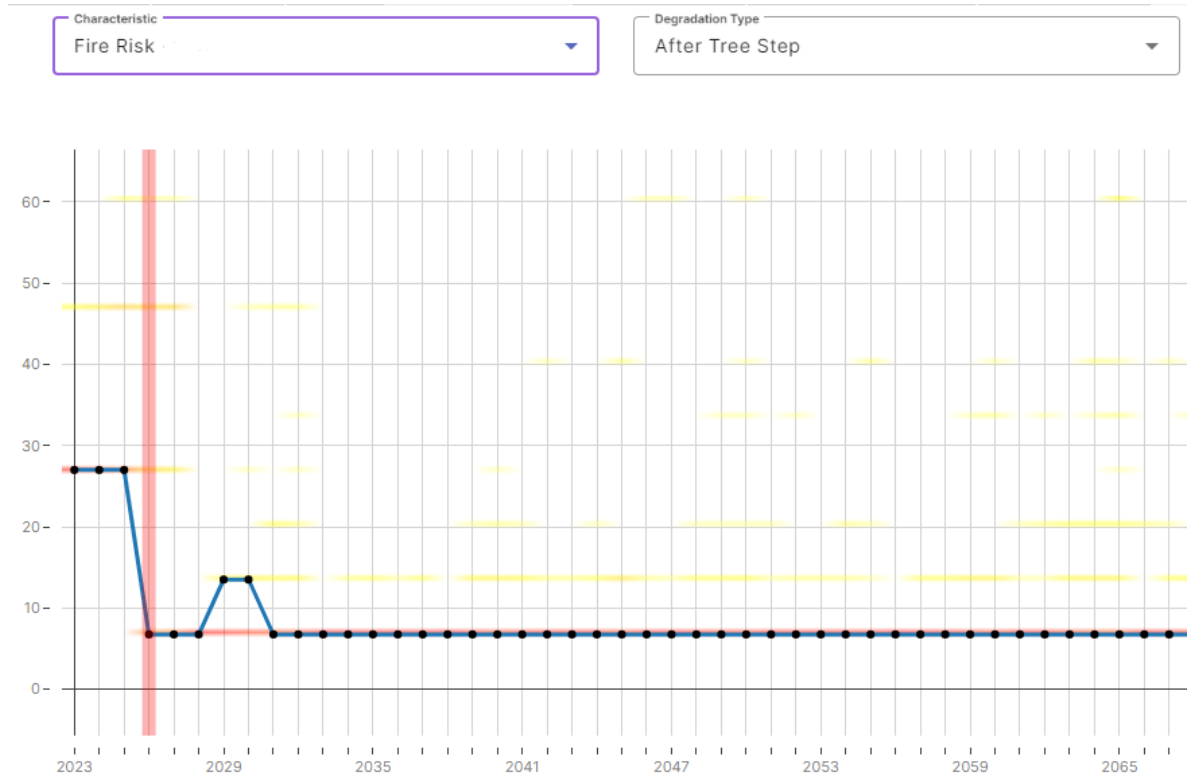

Replacement

Between 2023 and 2025, the model triggers a replacement Pole 0593BV. However, due to insufficient budget the pole is placed in the replacement backlog. Similar to the previous two uses cases, the pole replacement budget cap is set at \$6,000,000 per year. The prioritization order is set at the circuit level, meaning all poles flagged for replacement within an inspected circuit will be replaced, if there is sufficient budget available, before moving to the next circuit in the prioritization order. In this situation, sufficient budget was available to replace poles in Goldmine Circuit.

Pole - Replacement ✖

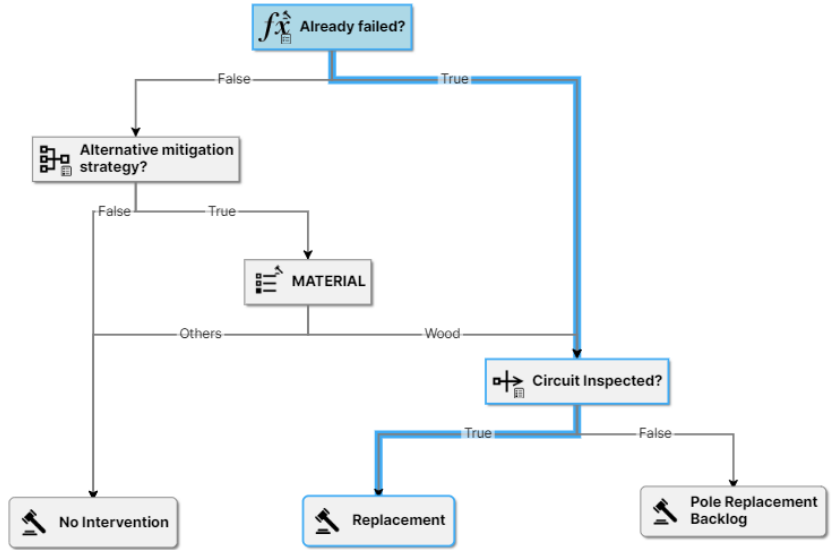

Pole - Replacement ✖

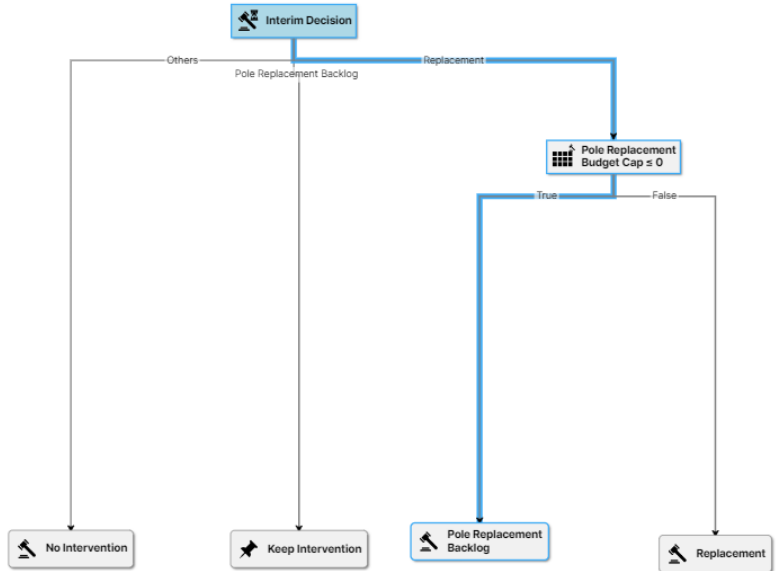

In 2026, the pole replacement budget is above 0 when Pole 0593BV passes through the decision tree, which triggers a replacement:

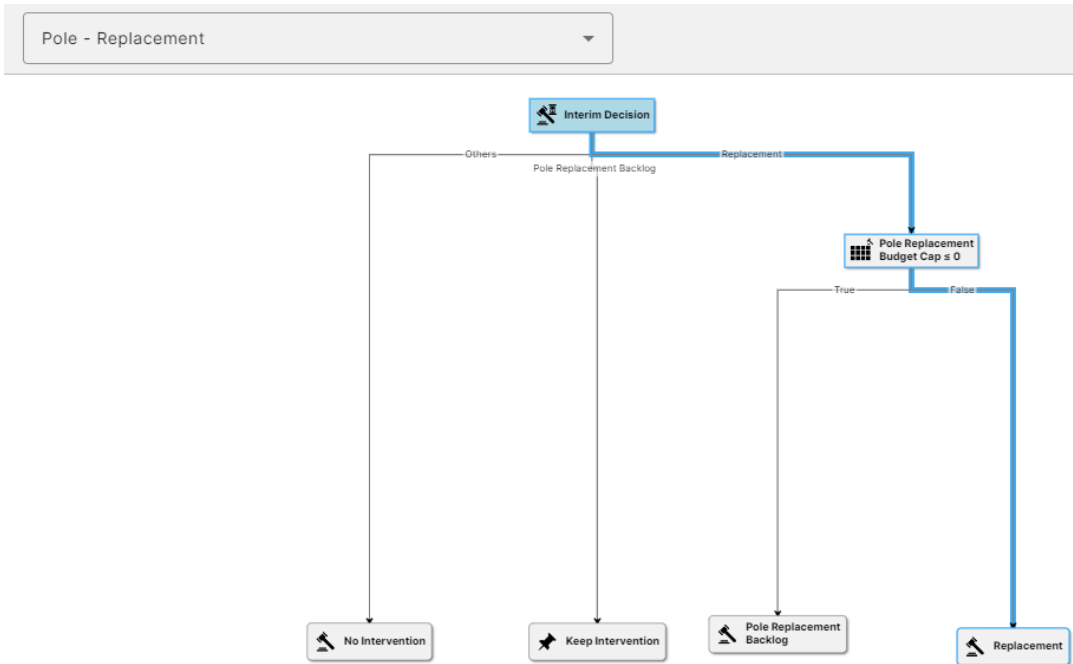

The pole replacement will reset several characteristic values (Age, Material, Years Since Last Detailed Inspection, Years Since Last Intrusive Replacement) as well as trigger replacement costs:

Characteristic	↑	Beginning of Step	End of Step
Age		31	0
Age Range - Map		30-35	0-5
Already failed?		True	False
Asset is replaced?		False	True
CM - Final		1.25	1
CM - Final - Min		0.04	0.05
CM - FireWrap - Min		0.8	1
CM - Pole Material		1	0.8
Fire Risk (Test)		47.25	27
Inspection Age Choice		Age-15	Age-0
INSTALLDATE		1995	2026
INTINSP_INSPECT_DT		2011	2026
Last Detailed Inspection Year		2023	2026
MATERIAL		Wood	Light Weight Steel
Minimum Probability of Fire		0.02	0.025
Needs Intrusive Inspection?		True	False
Number of Replacements		0	1
Pole Replaced This Year?		False	True
Pole Replacement Backlog - Numerical		1	0
Pole Replacement Backlog?		True	False
Probability of Fire - Final - Range		7	4
Probability of Fire - Scaled		0.625	0.5
Probability of Fire - Score (Test)		7	4

Scenarios (Technosylva dependent)

To accommodate variations in weather trends, the model defines three scenarios for each use case, allowing for a comparison of optimistic, normal, and pessimistic conditions. The 20th percentile, 50th percentile, and 80th percentile represent the conditions for each respective scenario. This approach aids the client in making well-informed decisions by considering different levels of risk tolerance corresponding to these scenarios. Looking ahead, we can enhance the model by leveraging Monte-Carlo simulations in this aspect of the model and account for uncertainties in weather trend, allowing us to explore a broader range of Technosylva-calculated percentiles. This improvement will provide a more thorough understanding of potential outcomes across different scenarios, making the model more adaptable and robust in addressing uncertainties.

Results

The DIREXYON suite ensures complete transparency by delivering results in two distinct formats:

Individual Asset Level (Debug screen):

Allows you to track the journey of each asset in each year based on each iteration, verifying the evolution of asset characteristics over time. This format enables validation of specific interventions triggered at precise moments, providing insights into their impacts.

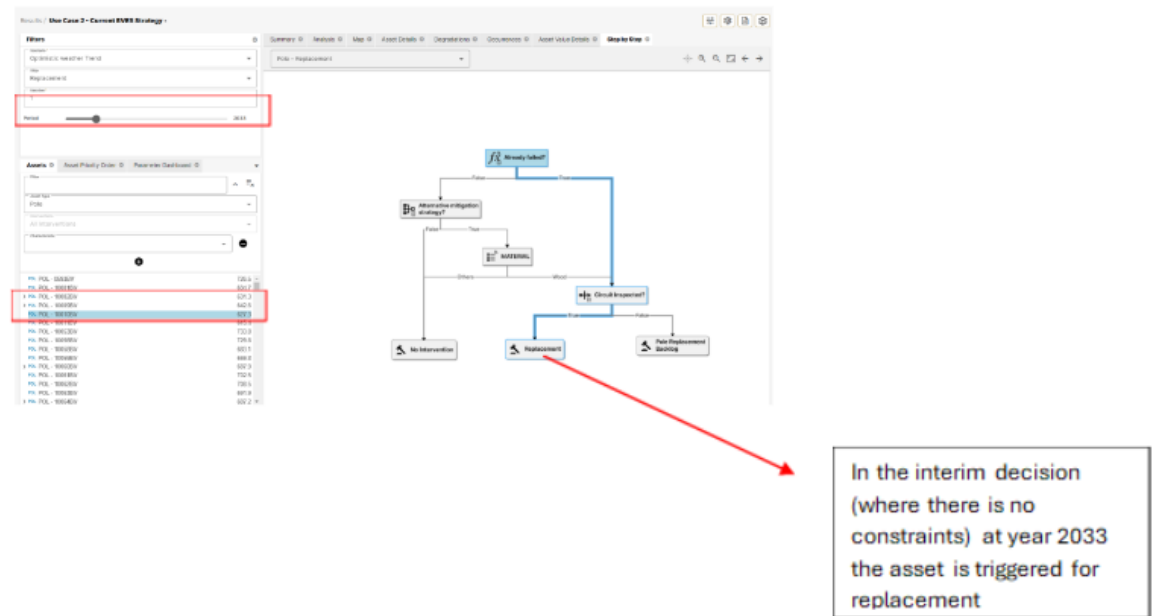
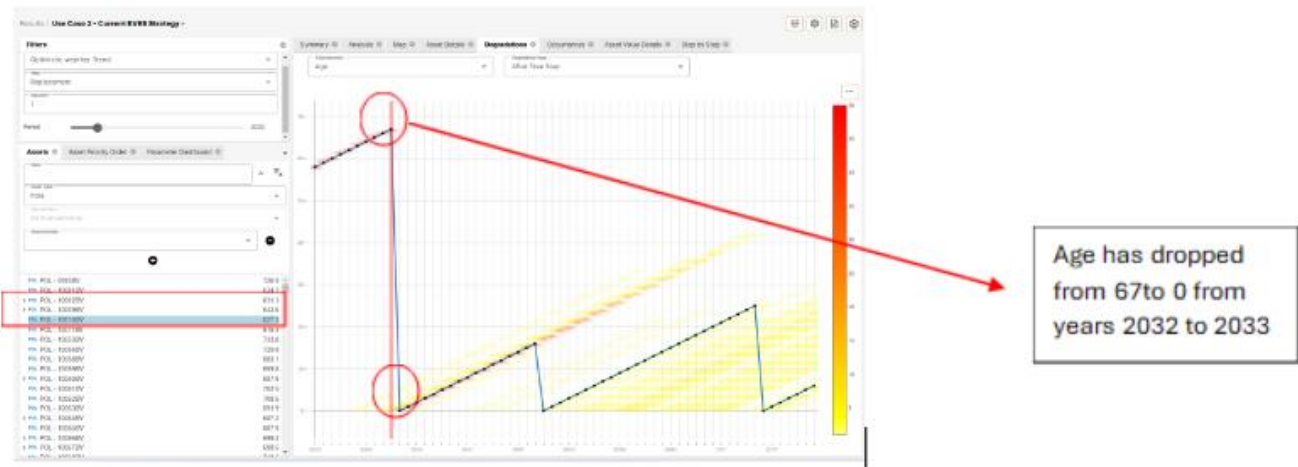

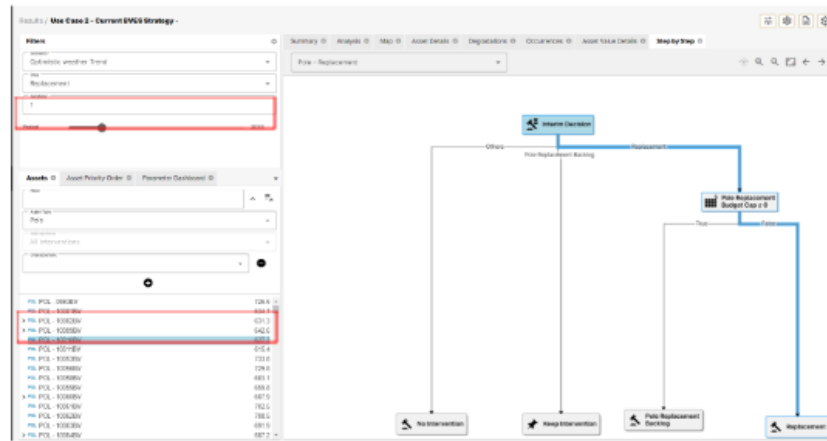

In the final decision (where constraints are considered) at year 2033 the asset is triggered for replacement

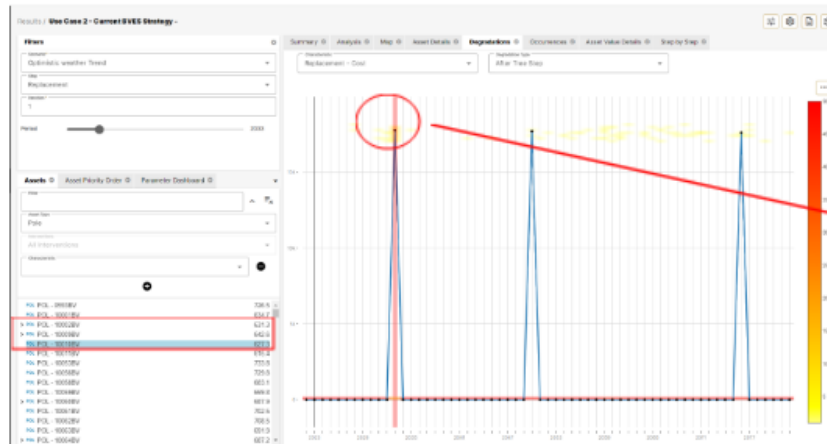

The asset replacement in the same year incurred a cost of \$17,000

Based on the analysis results for asset POL – 10010BV, observing the age evolution reveals a decline to zero by the year 2033. At this juncture, an intervention should be initiated to address the age of the asset. Upon closer examination, navigating through the step-by-step process unveils that the asset has indeed failed. With available budgetary resources, the intervention involves replacing the asset in the same year. The consequential impact of this intervention is twofold: a triggered cost and the restoration of the age, which had dropped to zero. The provided example serves as a simplified showcase of the functionality, and all specified characteristics for each individual asset can be monitored through the debug screen.

Aggregated Results (BI dashboard):

Presents simulation outcomes in an aggregated format, offering a holistic view of the overall network condition, required investments, and other key performance indicators at a collective level. This format facilitates a comprehensive evaluation of the network's overall health and performance. The integrated dashboard within the DIREXYON suite offers versatile views, tailored to cater to various personas such as executives, asset managers, and more. These views can seamlessly switch between detailed insights and holistic overviews, providing a customized experience for different stakeholders.

Current State Dashboard:

The presented screenshot illustrates the current status of assets derived from the client's inventory. Users can effortlessly modify the predefined ranges and colors. This view offers clients insights into the current condition of the network, highlighting details such as the count of uncovered conductors and poles without fire wrap. Armed with this information, clients can strategize and plan to address these elements in the future.

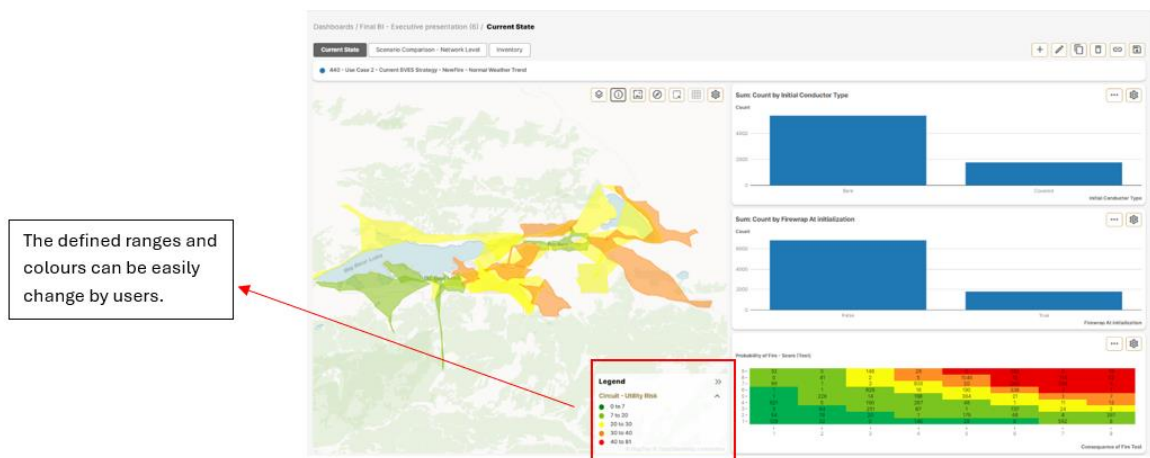

Scenario comparison Dashboard:

The presented screenshots offer a comparative analysis of different investment strategies and their short-term and long-term impacts on the network's condition. Users can utilize this view to assess and compare various investment strategies, their required levels of investment, and their effects on key performance indicators (KPIs) of the network.



Scenario comparison – Total Cost:

The attached screenshot compares three different strategies for spending on infrastructure to manage fire risk.

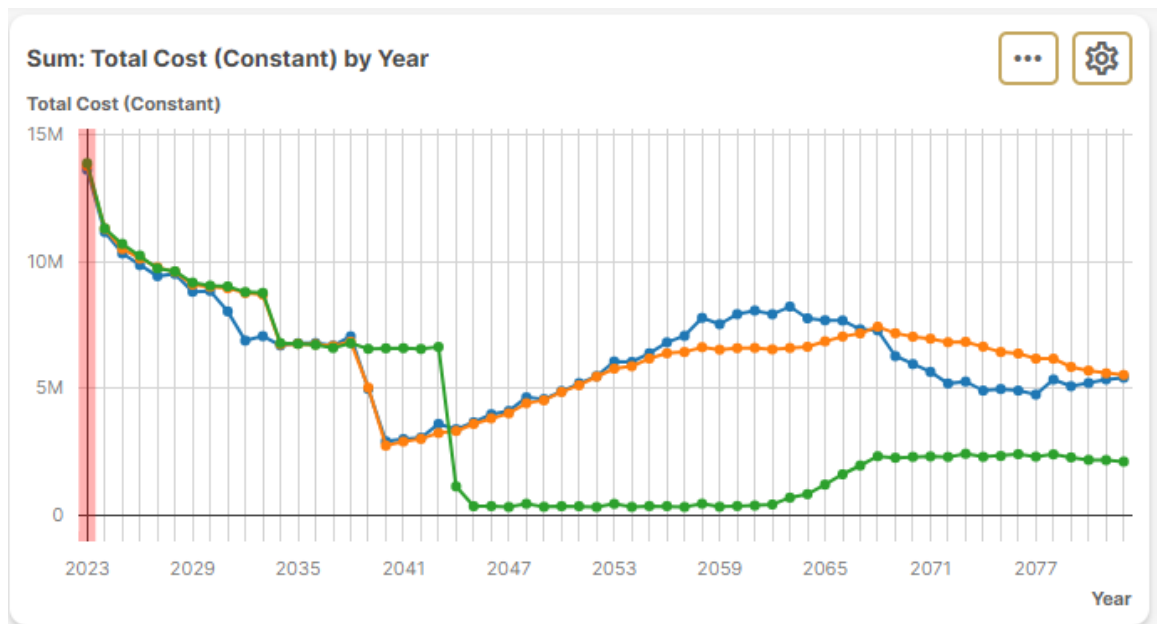

Use Case 1 - GO165 Minimum Requirements: This use case operates under a set of structured assumptions focusing on inspection and maintenance schedules to manage fire risk and infrastructure integrity:

- The strategy is built around maximum allowable inspection cycle lengths for poles, with intrusive inspections scheduled every ten years for poles over 15 years old, complemented

by annual patrol inspections and detailed inspections based on the condition and risk profile of each circuit, which can range from yearly to every five years.

- Asset replacement is reactive, triggered by failures as predicted by established failure curves, and vegetation management is a key component of the fire risk reduction strategy, occurring every five years.

This scenario, while being more cost-effective, **relies primarily on vegetation management** as the key strategy for **reducing fire risk**. Scheduled every five years, this systematic approach helps manage the risk to some extent. However, the limited frequency and scope of vegetation management may not fully address the comprehensive fire risk, especially in areas prone to rapid regrowth or in high-risk fire zones. The cost savings in this use case are significant, reflecting a more reactive and compliance-focused approach.

Use Case 2 - Current BVES Strategy: The second use case includes not only more frequent and extensive vegetation management but also the installation of fire wraps on poles and the proactive replacement of conductors scenario. By choosing to invest in comprehensive fire prevention methods like fire-resistant wraps and safer conductors, the upfront costs are higher.

Use Case 3 - Proactive Steel Pole Replacement: Use Case 3 introduces a different strategy from the previous two, involving the proactive replacement of wood poles with steel poles with the expectation that it will lead to major cost savings over time. Steel poles, being more durable and less prone to fire suggests an understanding that some significant early investments will lead to a smoother financial road ahead, with much lower maintenance requirements. It's a forward-thinking strategy that anticipates less frequent interventions and long-term resilience.

The following paragraphs compare the financial aspects of these use cases in different timeframes.

- **Initial Impact (2023 to 2029):** All three scenarios start with high costs that drop sharply within the first few years. This initial investment phase is similar across the board, indicative of upfront costs likely associated with aging infrastructure.
- **Mid-Term Impact (2029 to 2053):** After the initial decline, the costs in all scenarios start to diverge. The green line (Use Case 3, with steel pole replacement) shows the lowest costs during this period, suggesting that the switch to steel poles may lead to reduced maintenance and replacement costs. The orange line (Use Case 1, GO165 Minimum Requirements) sees a slight increase followed by a plateau, whereas the blue line (Use Case 2, BVES Strategy) climbs higher than Use Case 1, reflecting its more aggressive fire mitigation strategy that includes vegetation management, fire wrap installation, and conductor replacement.

- Long-Term Impact (2053 onwards):** In the long term, the costs associated with the GO165 Minimum Requirements (orange) and the BVES Strategy (blue) become closer but then begin to separate after 2059, with the BVES Strategy trending higher overall. This suggests an ongoing cost associated with the BVES Strategy’s proactive measures. Meanwhile, Use Case 3 (green) continues to show the lowest cost trajectory throughout the period, implying that the investment in steel poles, despite a potential high initial cost, may be economically beneficial over time.

Each of these strategies carries its own set of pros and cons: Use Case 1 is about minimal compliance, leading to a lower but more unpredictable cost curve; Use Case 2 suggests a willingness to invest more consistently for safety and stability; and Use Case 3 aims for a significant upfront investment that could result in the lowest long-term costs. Decision-makers would have to weigh these options against their tolerance for upfront costs, long-term financial planning, and their overall approach to risk management.

Scenario comparison – Fire Risk:

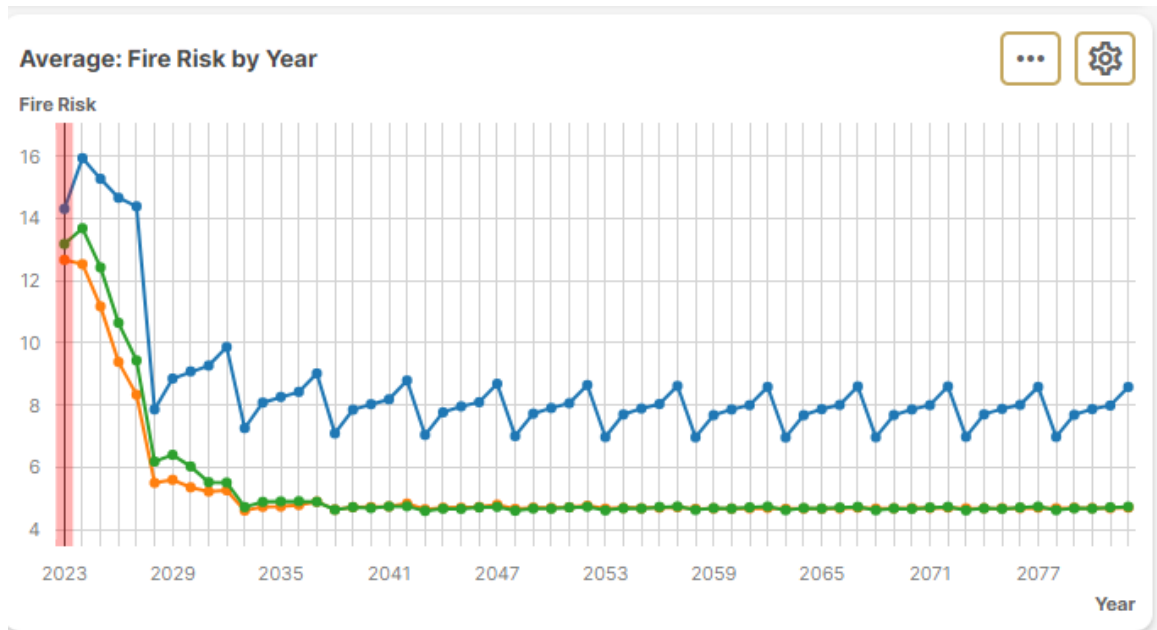

The fire risk graph supports the previously discussed cost implications of each use case by illustrating the effectiveness of their respective fire risk mitigation strategies over time.

Use Case 1 - GO165 Minimum Requirements (Orange Line): The fire risk in this scenario decreases sharply at first, similar to the other strategies, but then experiences variability, with the risk level stabilizing but showing slight increases and fluctuations over the years. This pattern justifies the moderate cost structure seen in Use Case 1, where spending is controlled and follows a

reactive maintenance approach. The higher risk levels compared to Use Case 2 and Use Case 3 indicate that while the costs are contained, so is the effectiveness of the risk mitigation over time.

Use Case 2 - Current BVES Strategy (Blue Line): This scenario shows a significant and rapid decrease in fire risk, which then levels out to a very low and stable line. The persistent low fire risk correlates with the higher costs over time observed in the cost graph for Use Case 2, supporting the strategy's ongoing investment in aggressive fire mitigation measures such as vegetation management and infrastructure upgrades. The graph demonstrates the success of these measures in maintaining a low fire risk consistently over the long term.

Use Case 3 - Proactive Steel Pole Replacement (Green Line): Use Case 3 shows the most dramatic and sustained decrease in fire risk, dropping to the lowest level among the three scenarios and maintaining that level throughout the period. This substantial reduction in fire risk aligns with the cost graph where, after the initial investment, Use Case 3 maintains the lowest costs. This justifies the initial high cost of replacing wooden poles with steel poles, as the strategy not only results in decreased maintenance and replacement needs but also significantly lowers the fire risk.

In summary, the additional investment in the BVES Strategy in comparison to minimum GO165 requirements appears justified when considering the significantly lower fire risk achieved. The approach of integrating various mitigation measures ensures that fire risk is not only reduced but is also maintained at a minimal level consistently over the years. This proactive and multifaceted strategy illustrates the principle that a slightly higher, but steady, investment in comprehensive fire risk mitigation can lead to a disproportionately large and sustained benefit in risk reduction. When comparing Use Case 3 with the other two scenarios, it presents an interesting middle ground. It potentially offers a more significant reduction in fire risk than Use Case 1 due to the inherent fire-resistant properties of steel poles. Compared to Use Case 2, while the investment in steel poles may be substantial upfront, it could result in lower long-term costs due to the decreased frequency of maintenance and replacements.

Overall, while Use Case 1 offers a cost-effective approach relying on periodic vegetation management and compliance with inspection cycles, it may result in a higher fire risk due to less frequent mitigation actions. Use Case 2 requires higher investment in extensive vegetation management, fire wrap installations, and proactive conductor replacements, leading to a substantially lower and more stable fire risk. Use Case 3, with the proactive replacement of wood poles with longer-lasting steel poles, assumes a balance between upfront costs and long-term savings, potentially offering a lower fire risk and reduced need for frequent maintenance.

The choice between these strategies would depend on the value placed on upfront costs versus long-term savings and the acceptable level of fire risk management. Use Case 3's approach, which

anticipates a reduced frequency of future interventions, offers an attractive investment in terms of resilience and risk reduction over the long term.

The "Average Age " graph provides valuable insight into the lifespan of infrastructure within each use case, reflecting the relationship between the age of assets, the level of investment in maintenance and upgrades, and the implications for long-term cost efficiency and risk management.

Scenario comparison – Average Age:

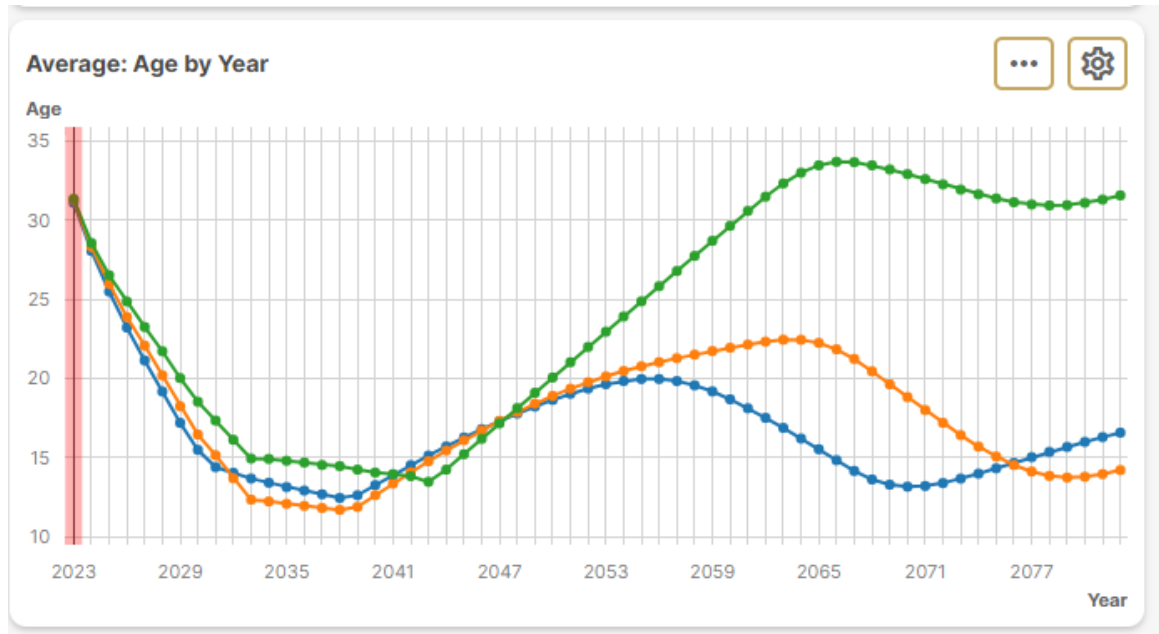

The initial decrease in average age across all three scenarios suggests a common period of heavy investment in new infrastructure, which corresponds with the high upfront costs seen earlier. After this initial phase, the strategies begin to show their long-term effects:

- The orange line (Use Case 1) demonstrates a rebound in the average age, reflecting a maintenance strategy that allows for aging infrastructure until replacement is required by failure or regulation. This mirrors the moderate but fluctuating costs associated with Use Case 1, where investment is timed with maintenance schedules and replacements due to aging components, which also contributes to the slight variability in fire risk.
- The blue line (Use Case 2) shows a more controlled trend in the average age, which levels off after an initial increase. This pattern suggests a consistent investment in upgrading infrastructure, aligning with the higher costs of the BVES Strategy. This consistent renewal of infrastructure helps maintain a low and stable fire risk.
- The green line (Use Case 3), after the steep decline in average age, maintains the lowest average age for a prolonged period before a gradual increase, indicating that the initial

investment in long-lasting steel poles leads to a lasting youthful infrastructure profile. The lower long-term costs and minimal fire risk in Use Case 3 reinforce the effectiveness of this strategy in providing both economic and safety benefits, as less frequent replacements are needed, and the younger infrastructure inherently carries a lower risk.

Overall, the age of infrastructure directly reflects the investment strategies employed. Higher upfront investments in durable infrastructure result in lower average ages and can lead to reduced costs and risks over time, as seen in Use Case 3. More moderate spending that follows aging assets and replaces them as needed leads to cost savings but potentially higher fire risks and average ages, as illustrated by Use Case 1. Use Case 2's approach of continuous renewal balances between maintaining a lower average age of assets and managing fire risk, though at a higher cost.

Scenario comparison – PSPS Risk:

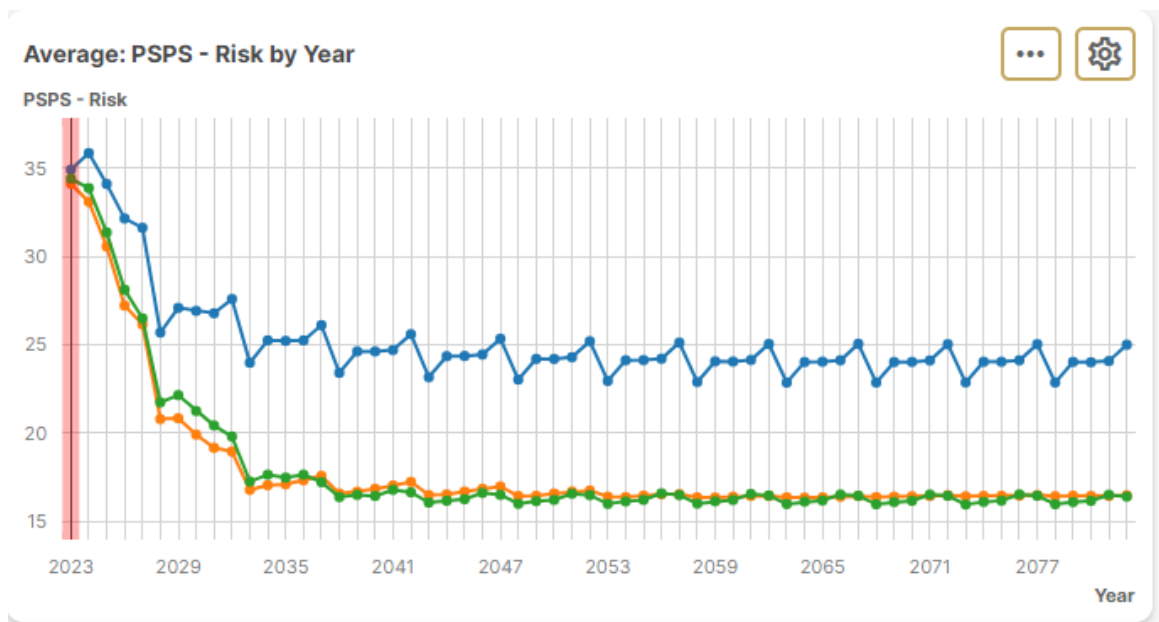

The PSPS risk trends across the strategies illustrate how a focus on resilient infrastructure can profoundly affect the necessity and frequency of Public Safety Power Shutoffs. Investments that enhance the electrical system's resilience, such as the proactive replacement of wood poles with steel, are shown to not only lower fire risk but also reduce the reliance on PSPS as a preventative measure.

With fewer PSPS events, there's less disruption to communities and a lower risk of fire initiation from electrical equipment. This is particularly crucial for AFN customers, for whom power outages can pose serious risks. A strategy that results in a sustained low PSPS risk demonstrates a

commitment to public safety and reliability, highlighting a long-term view where initial higher investments in infrastructure lead to greater stability and fewer impacts from power shutoffs.

On the other hand, a strategy that exhibits a more variable PSPS risk may reflect a more reactive approach, focusing on regulatory compliance rather than pre-emptive upgrades. Such an approach may lead to cost savings but could result in a higher likelihood of power shutoffs and, consequently, a greater impact on vulnerable populations.

In summary, the comparison of these strategies underscores the importance of resilient infrastructure in mitigating fire risk and minimizing the need for PSPS. A robust, proactive approach to infrastructure maintenance and upgrades not only ensures a safer, more reliable power supply but also serves as a critical protective measure for all, particularly for those most in need of consistent power.

Inventory Dashboard:

The screenshot provides a high-level overview of a utility network's risk management under the current BVES strategy across varying weather conditions. It shows the geographical distribution of risk levels across circuits, trends in fire risk over time, and the effectiveness of mitigation strategies in reducing fire incidents. Additionally, it assesses the cost efficiency of investments in risk mitigation.

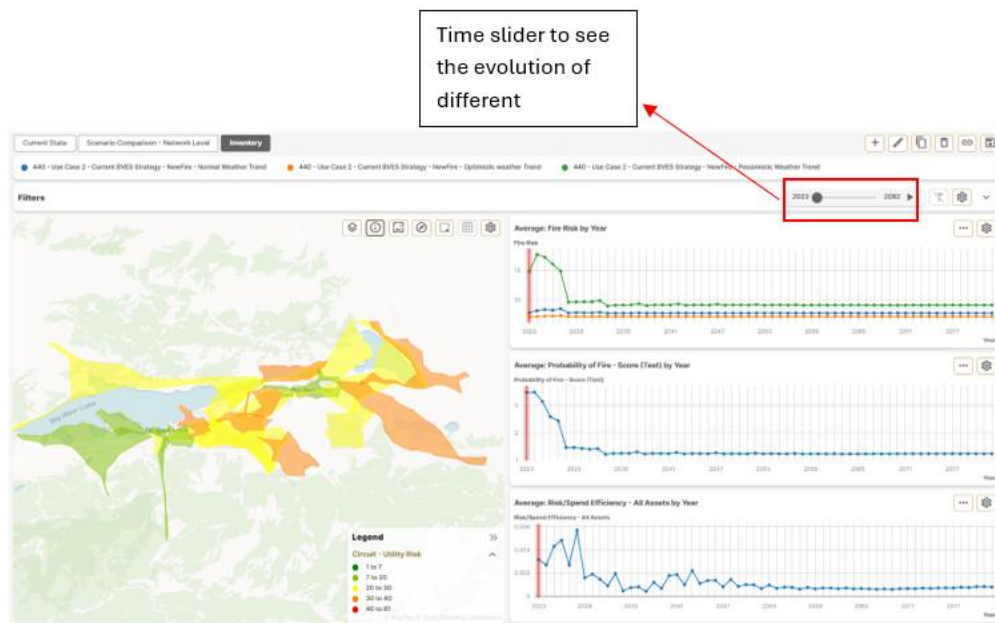

Inventory Dashboard – Map:

Comparing the two maps under the current BVES strategy, we see a clear transition in the utility risk associated with the network's circuits over time. Initially, the circuits display a range of risk levels, with many in the yellow to orange zones, indicating moderate to high utility risk. However, as we move forward in time, there's a visible shift towards more circuits falling into the green zone.

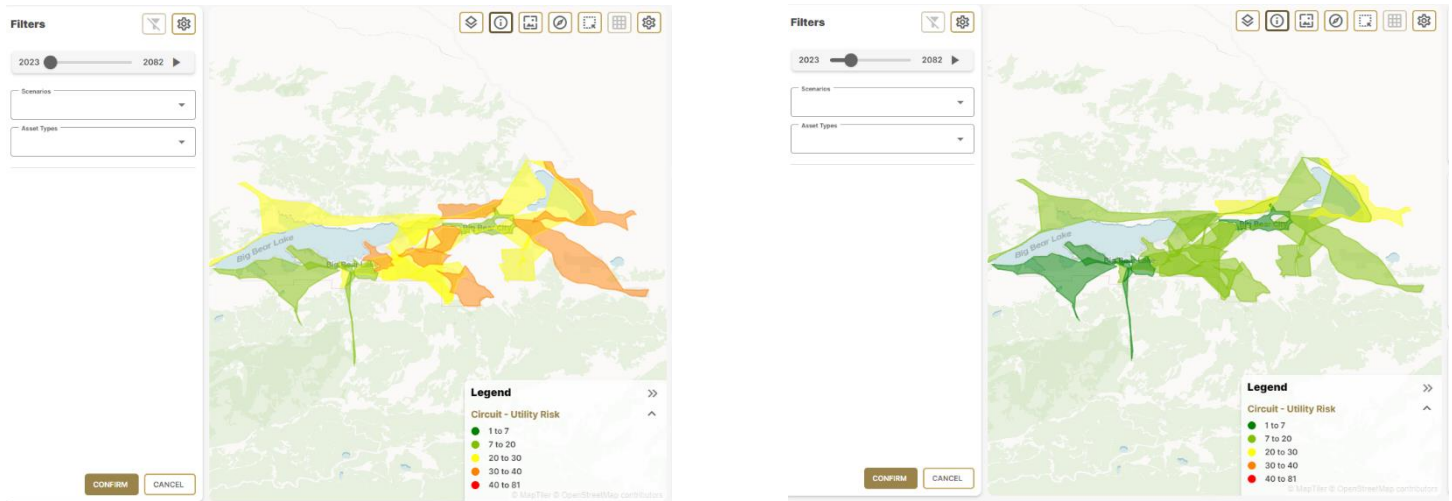

This progression towards green signifies that, over time, the current BVES strategy's mitigation measures are taking effect, reducing the overall utility risk across the network. It's an illustration of how proactive management and investment can lead to tangible improvements in the safety and reliability of the utility infrastructure.

By utilizing the time slider feature, users can observe the impact of the BVES strategy, watching as higher-risk areas (initially in yellow and orange) transition to lower-risk areas (in green). This visual tool demonstrates the potential long-term benefits of the implemented mitigation strategies and the positive outcomes of sustained investment in infrastructure resilience.

Inventory Dashboard – Fire Risk:

The graph shows the performance of the current BVES strategy under three weather scenarios, demonstrating how each scenario influences the effectiveness of the strategy's fire mitigation efforts. Contrary to typical expectations, the green line represents the most challenging weather conditions yet displays the strategy's resilience with only a modest increase in fire risk over time. This indicates that even in the worst weather scenarios, the strategy is robust, effectively preventing significant escalations in fire risk.

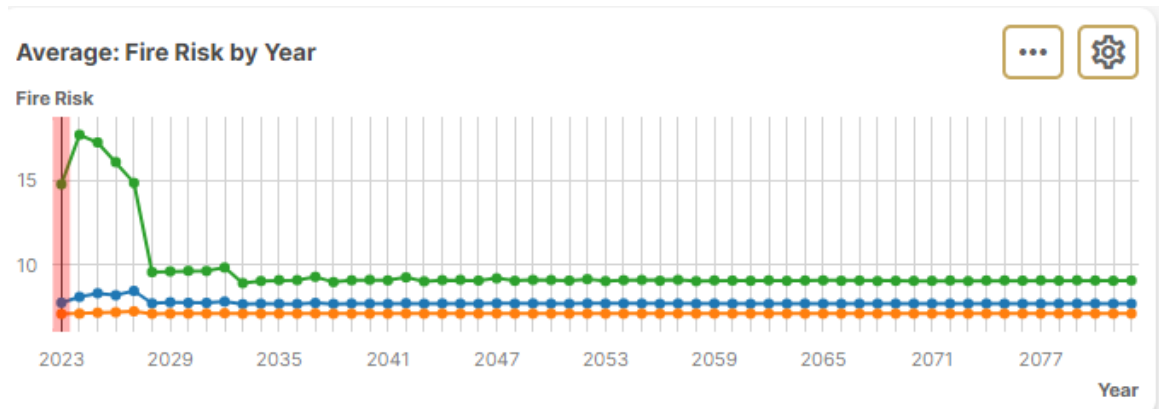

The orange line, starting with the lowest initial risk, shows a relatively stable trend, implying that in the most favorable weather conditions, there's **already a low baseline risk**, and the year-over-year risk reduction is less dramatic because there's less room for improvement.

The blue line indicates average weather conditions, where the risk starts higher, but the BVES strategy's mitigation efforts successfully reduce it over time, although not as low as the best-case scenario represented by the orange line. This suggests that while the strategy is effective across different scenarios, **its impact is most noticeable when there's a higher baseline risk to reduce**.

This interpretation helps clients understand the nuances of risk management: the strategy provides strong resilience in poor conditions (green line), ensures maintenance of low risk in favorable conditions (orange line), and effectively reduces risk in average conditions (blue line). It can inform clients how investments might perform across a spectrum of weather challenges and help them plan for different potential futures.

Inventory Dashboard – Probability of Fire:

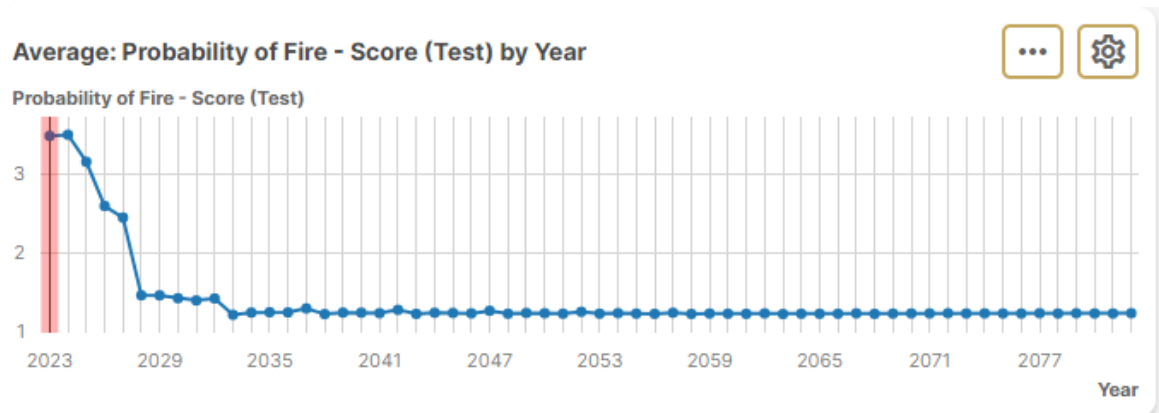

This graph displays the average probability of fire over time, represented as a score that indicates what are the chances of wildfire. The sharp decrease at the beginning shows the immediate impact of implementing the BVES strategy in reducing probability of fire, which includes more frequent vegetation management, the installation of fire wraps on poles, and the replacement of bare conductors with insulated ones. These measures are directly related to reducing the risk of equipment ignition, which is a common cause of utility-related fires. However, after a certain point, the probability stabilizes, indicating that the major fire risk factors have been addressed effectively across the network. This leveling off can be attributed to the successful completion of key mitigation initiatives: all vulnerable poles have been fitted with fire wraps, which protect them from ignition and reduce the likelihood of equipment-caused fires. Simultaneously, all bare conductors have been replaced with covered ones, greatly diminishing the chances of electrical fires. Moreover, the vegetation across the network has been managed to an optimal state, significantly lowering the risk of vegetation contact ignitions.

At this stage, the fire risk has been minimized to such an extent that further reductions are not observed, reflecting the saturation point of mitigation effectiveness.

More frequent vegetation management lowers **the likelihood of contact between vegetation and electrical equipment**, which can be a significant fire starter, especially in dry conditions. By managing vegetation proactively, the probability of such contact, and hence of ignition, is greatly reduced.

The installation of fire wraps on poles is a preventive measure that reduces the **equipment's susceptibility to igniting during a fire**, thereby lowering the probability that utility assets become a source of fire.

Replacing bare conductors with covered ones significantly mitigates the risk of electrical fires. Insulated conductors are less likely to spark if contacted by tree limbs, animals, or other foreign objects, addressing the **"contact by object ignition likelihood."**

Overall, the downward trend of the graph indicates that the BVES strategy's investments in these specific fire mitigation efforts have a sustained effect on reducing the overall probability of fires in the network. This trend reflects the cumulative benefit of the strategy over time, showcasing the importance of proactive measures in maintaining a low fire risk.

Inventory Dashboard – Risk/Spend efficiency:

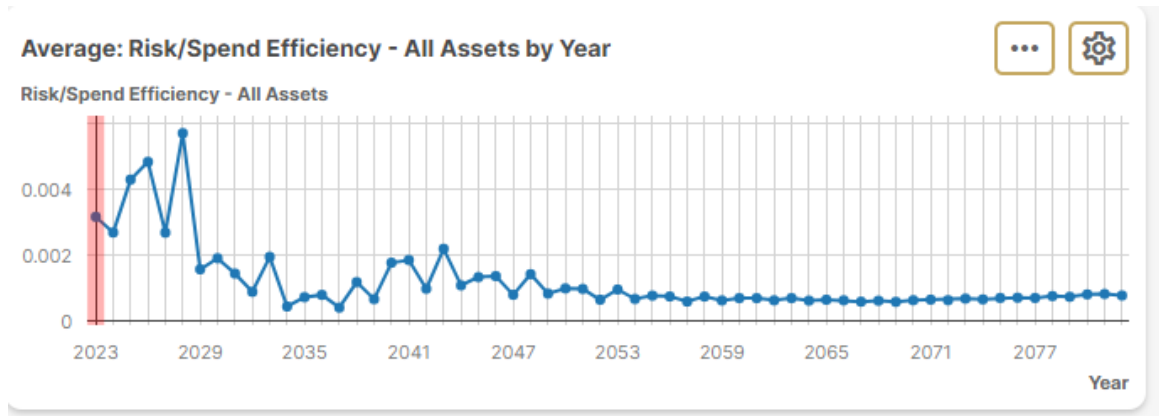

This chart illustrates the risk/spend efficiency for all assets over time, providing insight into how effectively the BVES strategy's investments are translating into risk reduction. The efficiency score measures the percentage of risk reduced per dollar spent.

At the start of the timeline, there's a spike in efficiency, which could be due to initial investments that significantly reduce risk. This suggests that early actions taken to mitigate fire risks, such as upgrading infrastructure or enhancing vegetation management, have a substantial impact relative to the amount spent.

Following this initial peak, the efficiency levels off and then gradually declines, indicating that while investments continue, the amount of risk reduction per dollar spent diminishes over time. This trend is expected as the most critical and effective risk reduction measures are implemented first, and as the system becomes more resilient, further investments yield smaller incremental improvements in risk reduction.

Towards the later years, the efficiency metric stabilizes at a low level. At this point, additional spending on the system may be for maintenance and minor improvements rather than large-scale risk reduction initiatives, reflecting a network that has already achieved significant risk mitigation.

Assumptions and Way Forward

In the initial phase of the project, DIREXYON addressed identified gaps within BVES 2023 WMP. For this phase, certain assumptions were made to facilitate the modeling process:

Exclusion of Inventory and Supply Chain Constraints for steel poles:

It's noted that considerations regarding inventory, supply chain constraints, and the feasibility of steel pole installation over wood poles are not factored into this analysis.

Weibull Parameters for Asset Failure

Lack of historical outage data led to the use of Weibull parameters sourced from subject matter experts or available literature to calculate the probability of asset failure. All values were corroborated with the client.

PSPS Probability Calculation:

Due to the absence of FPI data, DIREXYON utilized other available Technosylva data to calculate PSPS probabilities. The applied methodology aligns with recommendations in PG&E's 2021 guidance on PSPS.

Placeholder Weights in the Model:

The weights assigned to different fire impacts, PSPS impacts, and the participation of fire/PSPS risks in the overall risk are placeholders in the model. These values have been confirmed with subject matter experts and are subject to modification when additional information becomes available.

Scaling of Technosylva Data:

Lack of scaling in Technosylva data, combined with the varied unit measurements for fire characteristics (POI) and conditional values, prompted the use of statistical approaches to scale values. Consequently, the predicted risk scores should undergo validation through actual findings in the field before decisions are made based on DIREXYON's predicted values.

In the upcoming phase, DIREXYON recommends the following enhancements and refinements:

PSPS Model Enhancement

- Augment risk modeling by incorporating FPI Technosylva data and factoring in the monetary impact of PSPS. This includes strategies to reduce the impact on AFN customers, exploring battery storage options, and more.

Integration of Other Asset Types

- Include other asset types in the model to accommodate diverse fire mitigation strategies, such as proactive fuse replacement and assessing AFN impacts.
- Consider fire caused by different asset types and adjust the overall framework accordingly.

Vegetation Modeling as a Separate Asset:

- Model vegetation as a distinct asset, allowing for the testing of various vegetation management strategies.

Designing Additional Use Cases:

- Explore and create new use cases, testing additional what-if scenarios to further refine the model
 - Assessing the Benefits of Using Fire-Resistant conductor Materials to Replace Copper Conductors

Model Refinements:

- Utilize Monte-Carlo simulations with Technosylva data to better account for uncertainties in weather trends.
- Enhance scaling with additional insights from the client.
- Calibrate Weibull curves based on historical outage and replacement data for improved accuracy.

References

1. https://www.pacificorp.com/content/dam/pcorp/documents/en/pacificorp/wildfire-mitigation/2022_WMP_Update_Attachment_6_CC_Effectiveness_Workstream_R0.pdf
2. <https://ieeexplore.ieee.org/abstract/document/9300013/authors#authors>
3. <https://energized.edison.com/stories/insulated-wires-help-reduce-wildfire-risk>
4. <https://tdworld.com/wildfire/article/21146172/covered-conductor-a-wildfire-mitigation-solution>
5. http://vlabs.iitkgp.ac.in/vhvlab/html/pages/CD/topics_a-h/G-026-TEN-F.pdf
6. https://www.cpuc.ca.gov/-/media/cpuc-website/divisions/safety-and-enforcement-division/meeting-documents/pmps-readiness-briefings-august-2021/pge-pmps-public-briefing-832021.pdf?sc_lang=en&hash=465EA8A6AAE040B6E4F87409B3695842

Appendix C. Additional Maps

In this appendix, the electrical corporation must provide the additional maps required by the Guidelines. As stated in the General Directions, if any additional maps needed for clarity (e.g., the scale is insufficiently large to show useful detail), the electrical corporation must either provide those additional maps in this appendix or host applicable geospatial layers on a publicly accessible web viewer. If the electrical corporation chooses the latter option, it must refer to the specific web address in appropriate places throughout its WMP. Additionally, the electrical corporation must host these layers until the submission of its 2026-2028 WMP or until otherwise directed by Energy Safety. The electrical corporation may not modify these publicly available layers without cause or without notifying Energy Safety.

Below is a list of the WMP Guidelines sections which require additional maps:

Section Number	Section Title
5.3.2	Fire History
5.4.3.2	Social Vulnerability and Exposure to Electrical Corporation Wildfire Risk
6.4.1.1	Geospatial Maps of Top Risk Areas within the HFRA

Section 5.3.2 Catastrophic Wildfire History

Additional Maps cannot be provided as BVES has not experienced a catastrophic wildfire to date.

Section 5.4.3.2 Social Vulnerability and Exposure to Electrical Corporation Wildfire Risk

The map that was requested in the guidance was provide with the narrative. The detail needed is visible in its present form.

Section 6.4.1.1 Geospatial Maps of Areas with Heightened Risk of Fire

The following maps provide additional detail as requested in Section 6.4.1.1. The first two maps are the output of the in development Technosylva WRRM function. The maps with leading "REAX – " are the result of the REAX Engineering engagement BVES conducted in 2021.

Overhead Distribution Lines Risk Attributes

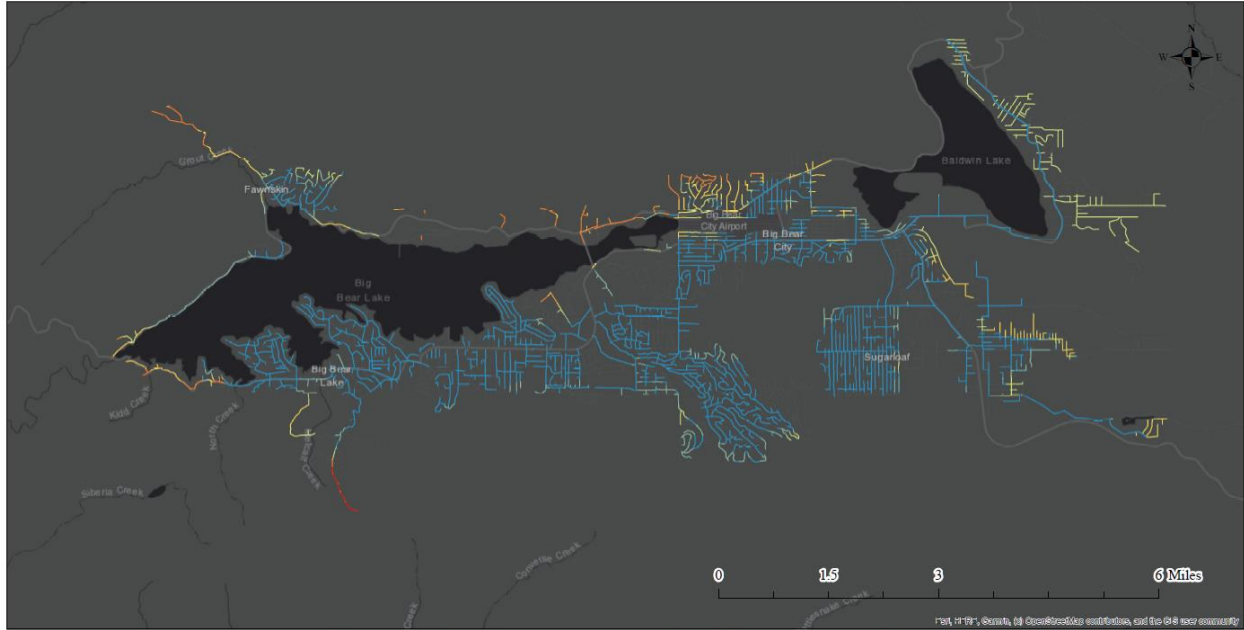

Distribution Expected 2022

Expected 98th Percentile Acres Burned

- 0.00 - 1.13
- 1.13 - 3.52
- 3.52 - 7.27
- 7.27 - 12.43
- 12.43 - 24.79
- 24.79 - 44.79

Overhead Distribution Lines with WRRM Expected Risk Attributes 2022

Covered Conductor Included in Risk Calculation



Overhead Sub)transmission Risk Attributes

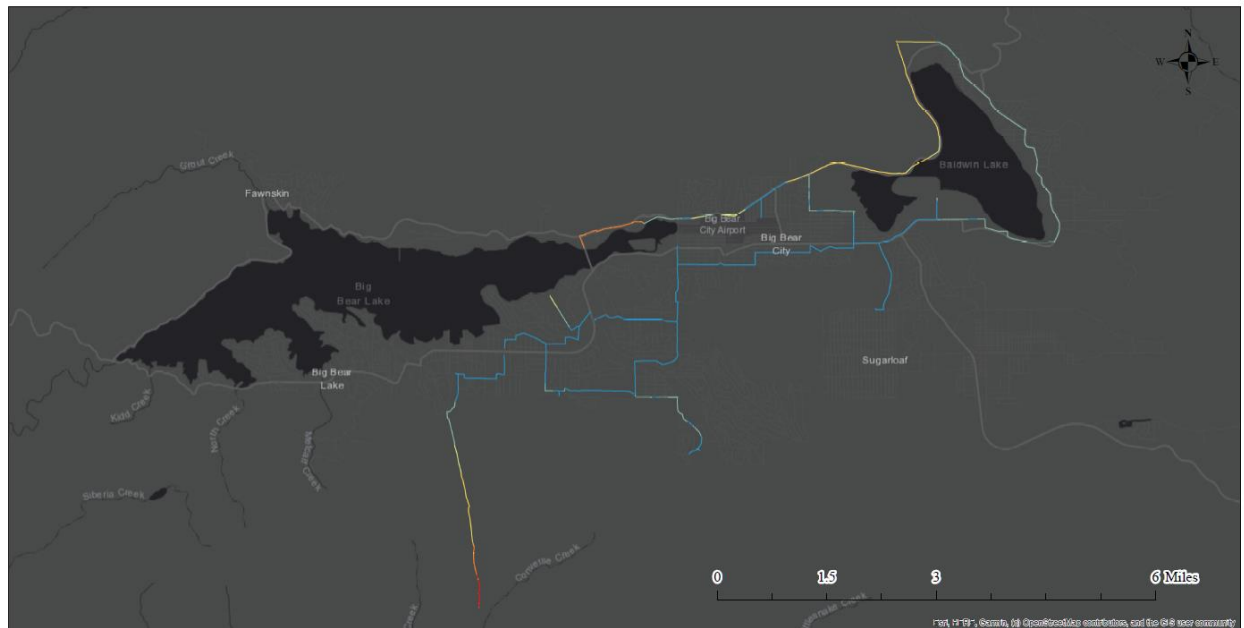

SubTransmission Expected 2022

Expected 98th Percentile Acres Burned

- 0.00 - 0.41
- 0.41 - 2.16
- 2.16 - 4.93
- 4.93 - 8.02
- 8.02 - 12.61
- 12.61 - 18.03

Overhead Sub-Transmission Lines with WRRM Expected Risk Attributes 2022

Covered Conductor Included in Risk Calculation



REAX - Modeled Fire Area (48-hr, Unsuppressed)

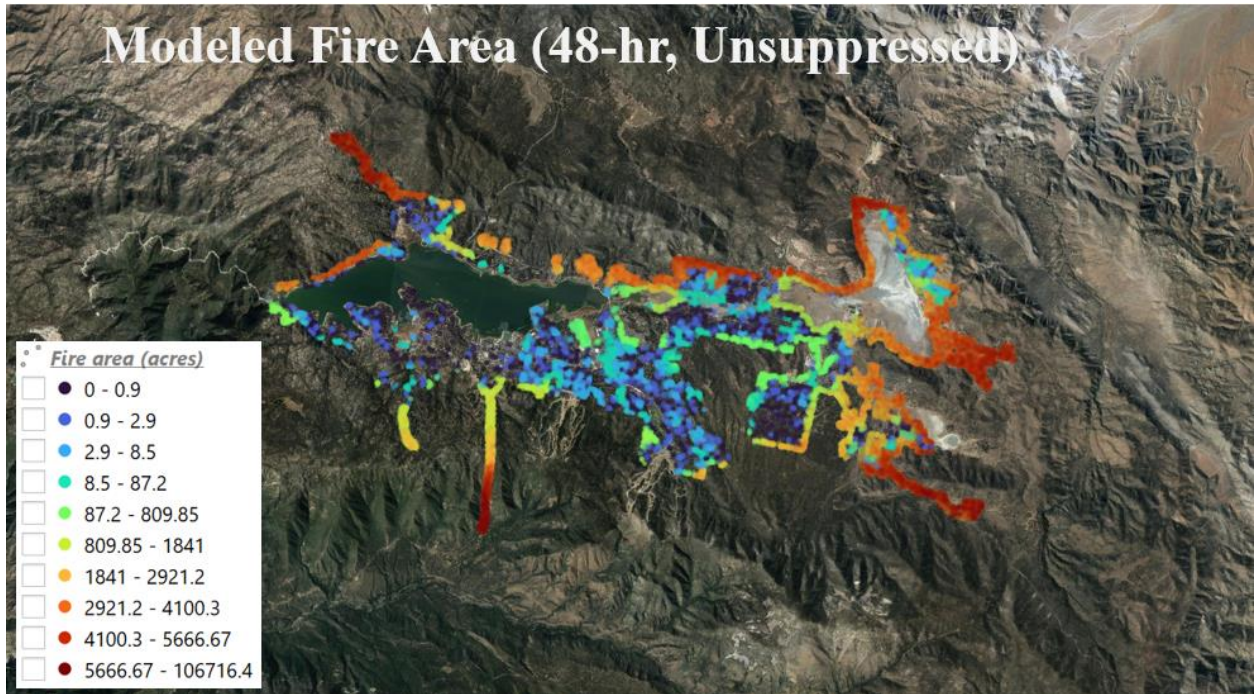

REAX - Modeled Risk from Power Line Ignitions (Based on Fire Area)

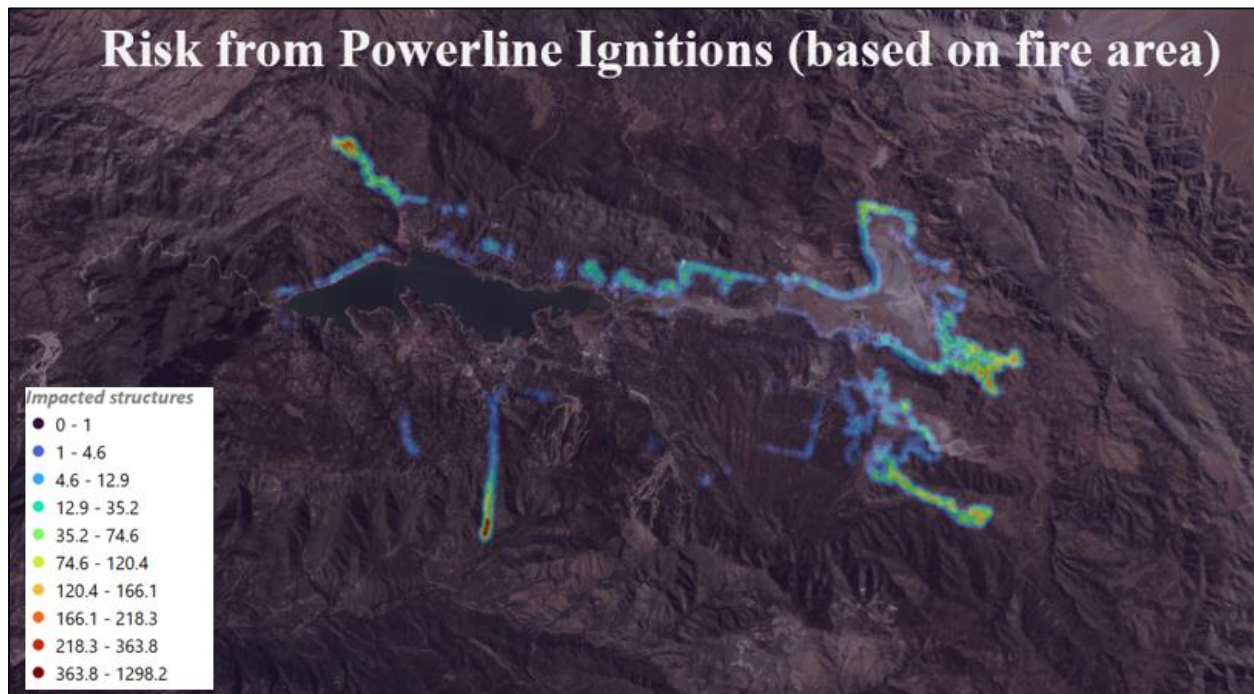

REAX - Modeled Structural Impacts (48-hr, Unsuppressed)

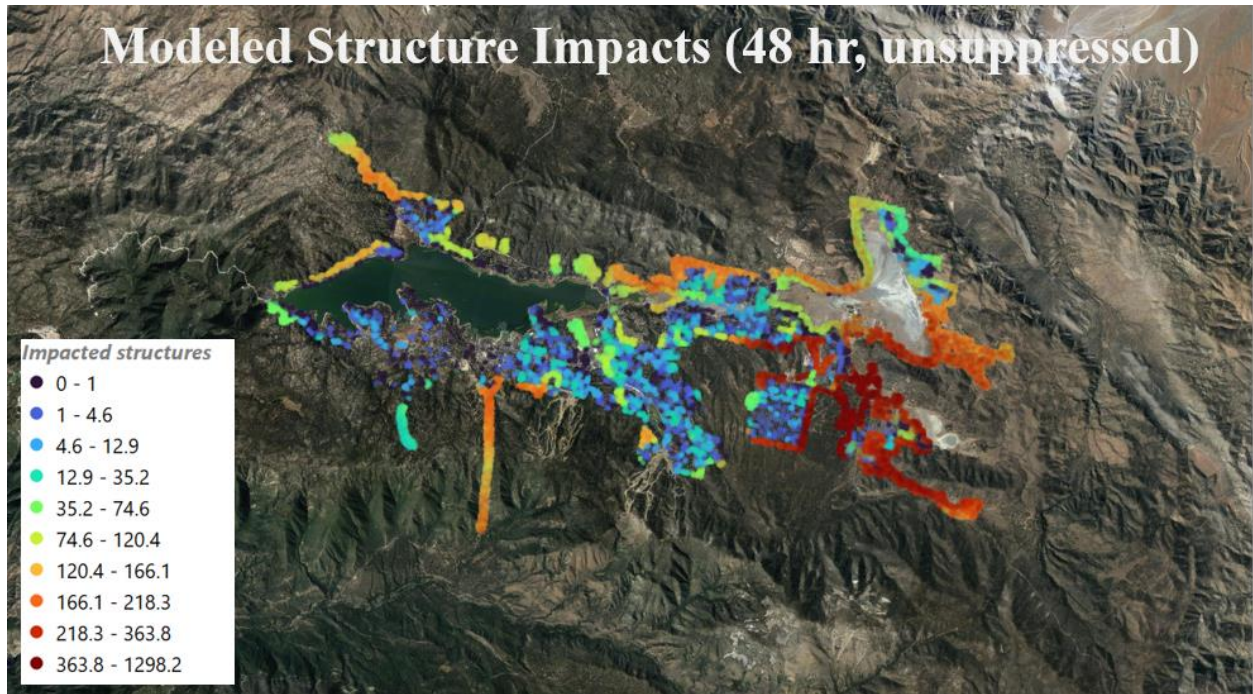

REAX - Modeled Risk from Power Line Ignitions (Structures)

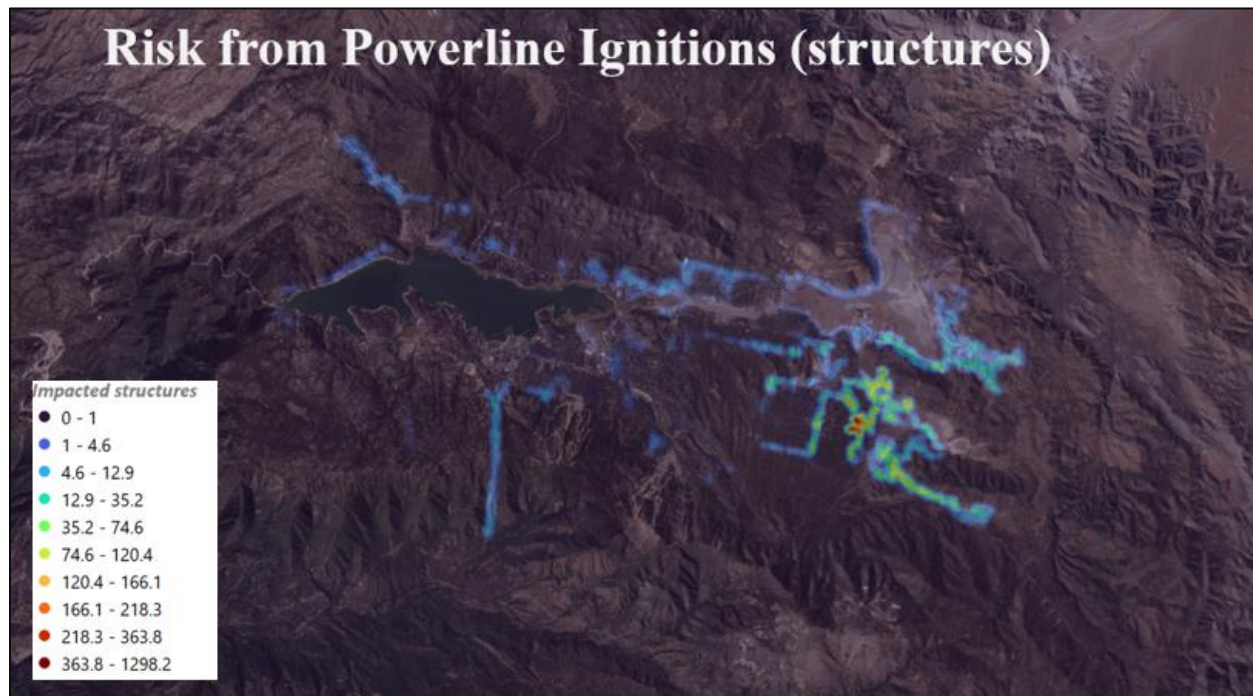

REAX - Annualized Burn Probability from Power Line Ignitions

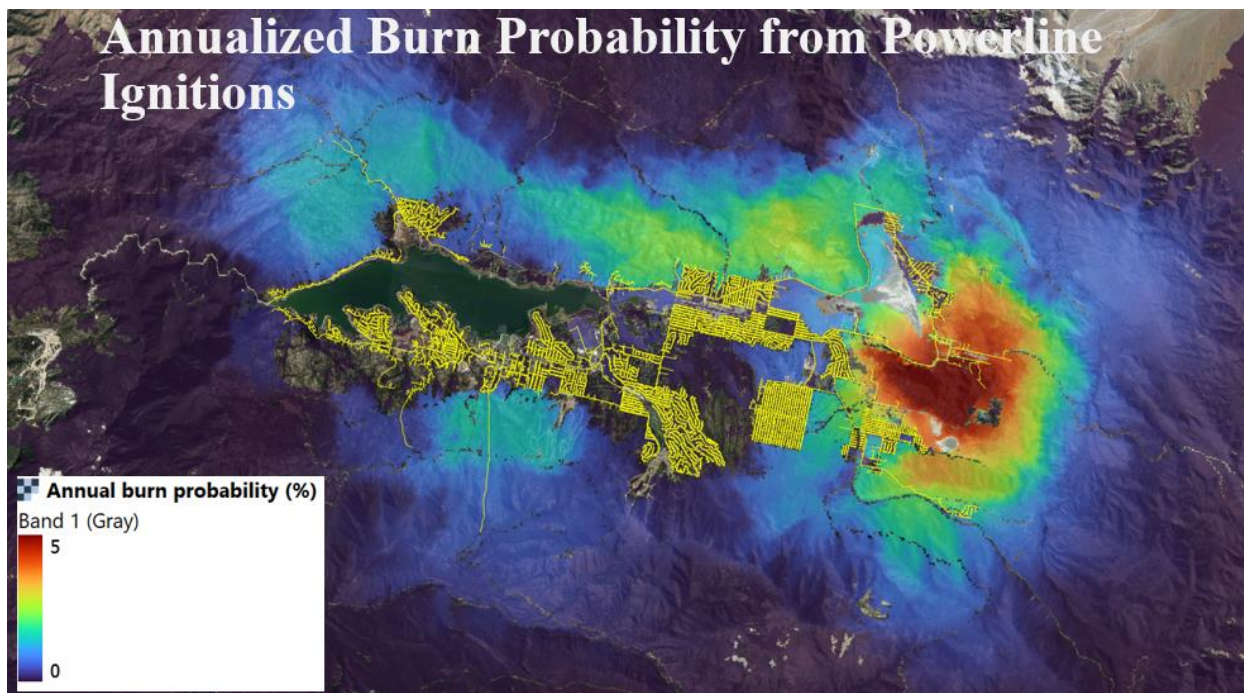

Appendix D. Areas for Continued Improvement

In this appendix, the electrical corporation must provide responses to its areas for continued improvement as identified in the Decisions on the 2022 WMP Updates in the following format:

Code and Title:

Description:

Required Progress:

[Electrical Corporation] Response:

BVES-22-01. Collaboration and Research in Best Practices in Relation to Climate Change Impacts and Wildfire Risk and Consequence Modeling.

Description:

While BVES includes some climate projections within its modeling, BVES does not sufficiently account for climate change in its planning.

Required Progress:

Prior to the submission of their 2023 WMPs, all electrical corporations (not including independent transmission operators) must participate in an Energy Safety-led scoping meeting to discuss how utilities can best learn from each other, external agencies, and outside experts on the topic of integrating climate change into projections of wildfire risk. They must also participate in any follow-on activities from this meeting. In addition, the climate change and risk modeling scoping meeting will identify future topics to explore regarding climate change modeling and impacts relating to wildfire risk. This scoping meeting may result in additional meetings or workshops or the formation of a working group. Energy Safety will provide additional details on the specifics of this scoping meeting in due course.

Response:

BVES has been working to integrate climate modeling into its risk assessments and risk mapping. In 2021, BVES hired Reax Engineering to deliver ignition probability and risk mapping for current and future conditions. These simulations projected likely climactic conditions for 2050 and identified fire risk and consequences from BVES's current overhead assets against the projected conditions.

In 2022, BVES employed Technosylva to produce and deliver more dynamic mapping and modeling capabilities for current, real-time, and projected conditions. This is described in detail in sections 6.1 and 6.2.

BVES-22-02. Inclusion of Community Vulnerability in Consequence Modeling.

Description:

BVES does not currently include the impacts of wildfire on communities, such as community vulnerability, within consequence modeling.

Required Progress:

Prior to the submission of their 2023 WMPs, all electrical corporations (not including independent transmission operators) must participate in an Energy Safety-led scoping meeting

to discuss how to best learn from each other, external agencies and outside experts on the topic of community vulnerability. They must also participate in any follow-on activities from this meeting. In addition, the community vulnerability scoping meeting will identify future topics to explore regarding integration of community vulnerability into consequence modeling and impacts relating to wildfire risk. This scoping meeting may result in an additional meetings or workshops or the formation of a working group. Energy Safety will provide additional details on the specifics of this scoping meeting in due course.

Response:

BVES has increased its awareness and outreach to the Big Bear community which is all vulnerable to wildfire. Additionally, BVES participates in Energy Safety-led scoping meetings. At these meetings, BVES, Energy Safety, local agencies, public safety partners, and other stakeholders to discuss and understand community vulnerability. BVES holds these meetings regularly. Following these meetings, BVES increased its understanding of community needs including its AFN and Medical Baseline Communities. This understanding has led to changes in BVES communication strategy. BVES will continue this outreach to better educate and prepare the Big Bear community in addition to the continuous improvement of Bear Valley's efforts to reduce community impacts. This is addressed in Section 5.4.3.2.

Community vulnerability is also addressed BVES's modeling inputs as described in Section 6.2.1 of the 2023 WMP Update.

BVES-22-03. Wildfire Consequence Modeling Improvements.

Description:

BVES's risk model is limited in its evaluation of wildfire spread based on timing limitations as well as suppression effects.

Required Progress:

As part of Energy Safety's final decisions on the 2022 Updates of PG&E, SCE, and SDG&E, the large IOUs are required to evaluate spread timing and suppression effects for wildfire consequence modeling. BVES must leverage these findings and implement the measures identified by the large IOUs into its consequence modeling, where appropriate. In its 2023 WMP, BVES must explain which measures it selected for implementation and provide a report on its progress.

Response:

BVES has been working with outside parties to better understand potential fire spread especially as it relates to timing and suppression effects for wildfire consequence modeling. In 2021, BVES hired Reax Engineering to produce and deliver wildfire spread modeling for current and future conditions. These simulations projected likely fire spread from different locations throughout BVES's service territory based on millions of simulations based off historical fires in the area, local climate, topography, and projected climactic.

In 2022, BVES employed Techosylva to produce and deliver more dynamic mapping and modeling capabilities for current, real-time, and projected conditions. The WFA-E product, delivered to BVES in early 2023, provides real-time risk monitoring and projects likely fire spread based upon the current conditions. Fire spread simulations can be performed in the WFA-E application at any possible ignition point along BVES's sub-transmission and distribution system. Technosylva will also deliver the WRRM tool in 2023. The WRRM will allow BVES to

simulate conditions, including extreme risk scenarios to better predict fire spread and suppression effects throughout the BVES service territory and into neighboring communities.

BVES-22-04. Integration of Consequence into Risk Assessment.

Description:

BVES has not yet integrated consequence modeling into its Fire Safety Circuit Matrix.

Required Progress:

In its 2023 WMP, BVES must:

- a) Describe how BVES captures safety, reliability, financial, and environmental impacts within its consequence modeling.
- b) Provide details on its integration of consequence into its modeling efforts. If BVES makes limited progress, it must include justification as well as an estimated timeline for completion.
- c) Explain how integration of consequence has shifted its understanding of risk and subsequent prioritization of projects.

Response:

The Fire Safety Circuit Matrix is a great tool for identifying ignition risk by calculating the likelihood of overhead assets and equipment conditions which may lead to an ignition as they interact with the dry, forested, mountainous terrain of BVES's service territory. However, BVES determined that the Fire Safety Circuit Matrix is not the best tool to use for consequence modeling. This somewhat crude tool has served BVES well in identifying the highest risk circuits within its territory and allowing BVES to prioritize mitigation efforts along those circuits to significantly reduce the likelihood that Bear Valley equipment will spark a wildfire. The Fire Safety Circuit Matrix does not contemplate safety, beyond fire risk, nor does it include reliability, financial, and environmental impacts.

To capture consequence modeling BVES employed third-party risk modeler Reax Engineering in 2021 and Technosylva in 2022 to better understand fire likelihood and spread. Reax provided static maps that BVES used in 2022, as a lens to view and assist its prioritization efforts that included risk assumptions from the Risk Based Decision Making Framework, Fire Safety Circuit Matrix, and other sources as another data point in the initiative prioritization decision making process. The Reax products produced consequence in terms of area burned and number of structures impacted. The Technosylva applications provides consequence in terms of area burned, buildings impacted, and population impacted.

Technosylva has been able to deliver a more dynamic fire risk understanding to BVES that shows consequences based on real-time conditions. Technosylva will also providing additional dynamic projections which will help BVES gain a better understanding of projected conditions, fire potential index, and hone its PSPS activation thresholds. In turn, BVES will use these tools to better understand consequences, including safety, reliability, financial, and environmental impacts in its understanding of risk. All of these outputs will be employed by BVES to prioritize its future mitigation initiatives.

BVES-22-05. Prioritization Based on Risk Analysis.

Description:

In Table 5.3-1, BVES only calculated the cumulative top risk coverage estimates since BVES's service territory is only within HFTD Tiers.

Required Progress:

In its 2023 WMP, BVES must provide an update on its progress using risk model output to inform its initiative plans based on highest-risk areas, including determination of the riskiest areas, for all initiatives. This should include:

- a) A discussion of the work completed and/or planned within the top risk ranked circuits, segments, or spans based on BVES's risk modeling.
- b) An explanation of how BVES is using its internal risk-modeling outputs (including ignition and consequence risks) to inform the scope of work, location, resource allocation, and timeline/scheduling of initiatives.

Response:

BVES used its Fire Safety Circuit Matrix as its primary tool for identifying the highest risk circuits and segments by ignition risk. The outcomes from this tool were used along with inputs from the Risk Based Decision Making Framework, Risk Register, and fire models to prioritize mitigation initiatives by those that maximize the risk reduction in the most effective and efficient manner. This is described at length in Section 7.1

BVES-22-06. Fire Potential Index.

Description:

BVES does not use a Fire Potential Index (FPI) to forecast its fire potential, instead using the National Fire Danger Rating System (NFDRS).

Required Progress:

In its 2023 WMP, BVES must describe how it has explored and/or will explore the development and use of an FPI in its service territory to forecast fire potential. If BVES determines there is no value in developing its own FPI and believes the NFDRS fire potential has sufficient granularity, it must describe the analysis that was conducted to make that determination.

Response:

BVES is currently working with Technosylva to develop a Fire Potential Index (FPI) model. The development and use of the model is referenced in the WMP including in Section 6.2.2. BVES expects the completion of this effort in 2023. BVES will update the description of its FPI in the 2024 WMP Update and will begin using its outputs for in the initiative assessment and prioritization of its projects for 2025 and beyond.

BVES-22-07. Integration of SCADA with Weather Station Network.

Description:

BVES has not integrated its weather station network into SCADA.

Required Progress:

In its 2023 WMP, BVES must commit to a timeline for deciding whether or not it plans to integrate its weather stations into SCADA. If BVES determines to integrate its weather stations, it must provide a provide a timeline for development and implementation. If it does not plan to integrate its weather stations into SCADA, BVES must describe its evaluation process, including considerations and outcomes, that led to this decision.

Response:

BVES deployed 20 weather stations that can be remotely monitored between 2019 and 2022. These weather stations provide Bear Valley operations engineers a detailed understanding of weather, including microclimates, across its 32 square mile territory. Additionally, BVES employs a contract meteorologist that gathers data from the weather stations and the National Weather Service and integrates them with the National Fire Danger Rating System (NFDRS) to give BVES a detailed understanding of the current and projected weather affecting BVES. Forecasts are provided daily during the fire season and may be produced more frequently if BVES is facing fire threats or may be approaching its PSPS thresholds. Because the weather stations have their own server and application, BVES has decided that integrating the weather station data into SCADA is not necessary and would in fact clutter the SCADA displays. The weather station application displays the weather at each station in a summary view and allows the user to drill down to each weather station individually for additional information. Additionally, the application is set up to provide email/text alarms to key staff at certain trigger wind speeds. Finally, all of the weather data is captured on the weather station server. Therefore, weather stations will not be integrated into SCADA.

BVES-22-08. Apply Joint Lessons Learned Concerning Covered Conductor.

Description:

BVES has not yet provided goals or timelines for implementing lessons learned from the covered conductor effectiveness joint study.

Required Progress:

In its 2023 WMP, BVES must:

- a) Provide a list of goals with planned dates of implementation for any lessons learned from the covered conductor effectiveness joint study.
- b) Provide a table indicating which WMP sections include changes (compared to its 2021 and 2022 Updates) as a result of the covered conductor effectiveness joint study. This should include, but not be limited to:
 - Changes made to covered conductor effectiveness calculations.
 - Changes made to initiative selection based on effectiveness and benchmarking across alternatives.
 - Inclusion of rapid earth fault current limiter (REFCL), open phase detection (OPD), early fault detection (EFD), and distribution fault anticipation (DFA) as alternatives, including for PSPS considerations.
 - Changes made to cost impacts and drivers.
 - An update on data sharing across utilities on measured effectiveness of covered conductor in-field and pilot results, including collective evaluation.

Response:

- a) BVES applies any lessons learned from its covered conductor program throughout the progression of the program, collecting information on supply logistics, pole replacements necessary to support covered wire installation, and covered wire installation work techniques and rates in order to optimize the program execution. As part of the project, BVES will install utility fiber cable and will use this for future system monitoring efforts (cameras, infrared sensors, system diagnostics sensors, etc.) and for fast acting switches on the circuit.

BVES also participates in the joint utilities workshop on covered wire and will continue to exchange information in this area with other utilities. BVES also attends T&D

conferences and review T&D literature and periodicals on the latest in covered wire operations and maintenance.

b) BVES discusses all aspects of its covered conductor program in section 8.1.2.1.

	Change in Covered Conductor Effectiveness Calculation	Changes to initiative selection based on effectiveness/ benchmarking across alternatives	Inclusion of REFCL, OPD, EFD, and DFA as alternatives including PSPS considerations*	Changes to Cost Impacts and Drivers	Update on data sharing across utilities on measured effectiveness of covered conductor
2023 WMP Update	Section 8.1.2.1	Section 8.1.2.1	N/A	Section 8.1.2.1	Section 8.1.2.1

*Currently, BVES does not have plans for inclusion of rapid earth fault current limiter (REFCL), open phase detection (OPD), early fault detection (EFD), and distribution fault anticipation (DFA) as alternatives, including for PSPS considerations. As these technologies mature, BVES will consider them.

BVES-22-09. Determine Best Practices for Covered Conductor Inspection and Maintenance.

Description:

BVES lacks specific directives for inspection procedures regarding covered conductor inspection and maintenance.

Required Progress:

All electrical corporations (not including independent transmission operators) must work to share and determine best practices for inspecting and maintaining covered conductor, including either augmenting existing practices or developing new programs. This should be considered as a continuation of the covered conductor effectiveness joint study established by Energy Safety’s 2021 WMP Action Statements. The study will continue to be utility-led, with the expectation for Energy Safety to be included as a participant. A report on progress on this continuation of the covered conductor effectiveness joint study will be expected in the 2023 WMPs.

Response:

BVES attends the Covered Conductor Working groups and was also one of the utilities that took part in commissioning a joint study to assess the effectiveness and reliability of covered conductors (CCs) for overhead distribution system hardening. From the working groups and study the following ongoing outcomes have been determined:

- CCs are a mature technology (in use since the 1970s) and have the potential to mitigate several safety, reliability, and wildfire risks inherent to bare conductors. This is due to the reduced vulnerability to arcing/faults afforded by the multi-layered polymeric insulating sheath material.
- Of the 10 hazards that affect bare conductors, CCs have the potential to mitigate six (tree/vegetation contact, wind-induced contact, third-party damage, animal-related damage, public/worker impact, and moisture).
- Laboratory studies and field experience have shown that CCs largely mitigated arcing due to external contact.

- Several CC-specific failure modes exist that require operators to consider additional personnel training, augmented installation practices, and adoption of new mitigation strategies (e.g., additional lightning arrestors, conductor washing programs).

This information is presented in Table 8-63 of this year's WMP.

BVES-22-10. Failure to Demonstrate Installation of Covered Conductor in Highest-Risk Areas.

Description:

BVES continues to tie identification of highest-risk areas to HFTD tier designations and does not provide direct correlations of highest-risk areas with covered conductor project location selection.

Required Progress:

In its 2023 WMP, BVES must:

- a) Demonstrate how BVES's risk modeling informs its prioritization of projects based on sequencing of risk ranking relating to ignition and consequence risk.
- b) Provide a ranked list of BVES's circuit segments based on risk analysis performed.
- c) Provide BVES's analysis on alternative initiatives compared to covered conductor, including effectiveness of risk reduction for BVES's covered conductor program scope.

Response:

Due to BVES HFTD Tier designations, it has set the goal to replace the entire 34.5 kV system with covered wire by 2026, and the entire 4 kV system by 2032. BVES continues to prioritize the highest risk circuits (Table 7-2) in its covered conductor replacement program specifically Radford, which it has created its own wildfire mitigation initiative for. Due to the location of the Radford line, and requirements set forth by the US Forest Service, the program has been delayed, but work on other high-risk circuits in BVES service territory have continued. Last year BVES was able to complete 12.96 circuit miles of replacement.

BVES-22-11. Pole Replacements Aggregated with Covered Conductor.

Description:

BVES's pole replacement program as it relates to wildfire risk is integrated into its covered conductor program and does not describe how BVES identifies and prioritizes pole replacements outside of covered conductor installation.

Required Progress:

In its 2023 WMP, BVES must:

- a) Disaggregate its pole replacement program to include targeted replacements to address known wildfire risk, including egress/ingress issues; OR
- b) Demonstrate that complete aggregation of its covered conductor and pole replacement programs provides the most cost/benefit efficiency.

Response:

BVES does not believe that the statement "complete aggregation" accurately reflects its efforts on Distribution Pole Replacement and Reinforcement. While a large number of the poles that are reinforced or replaced are directly related to the covered conductor replacement programs BVES replaces or reinforces poles in its service territory that pose a risk to utility operations and

wildfire risk. BVES's asset inspection program is used to identify poles that require replacement or remediation. BVES has continued its efforts on its Pole Assessment Program and reinforces or replaces poles that fail assessment. BVES also replaces pole as part of its evacuation route hardening efforts. This has led to numerous pole replacements outside of the covered conductor program. This is described in Table 8-3 and Section 8.1.2. BVES has also begun to track the financials of the Distribution Pole Replacement and Reinforcement as separate line items in Table 11 of the 2023 QDR.

BVES-22-12. Exploration of New Technologies.

Description:

BVES's WMP lacks discussion of exploration, piloting, and monitoring of new technologies, such as DFA, EFD, and REFCL.

Required Progress:

In its 2023 WMP, BVES must:

- a) Explain BVES's process for monitoring pilot programs being performed by IOUs, including BVES's plan and criteria on how and when to decide which technologies to select.
- b) Provide an update on BVES's exploration of technologies being explored by IOUs, including DFA, EFD, and REFCL. This should detail why and how BVES is moving forward with any such technologies.

Response:

BVES does not currently have any pilots or deployments of DFA, EFD, or REFCL technologies underway. BVES continues to monitor and evaluate other utilities experiences with these technologies. If the benefit of such technologies become cost effective BVES will develop a pilot. These technologies will also be more useful to BVES after it completes its grid automation programs described in Section 8.1.2.10.

BVES-22-13. Demonstration of QA/QC Progress for Asset Inspections.

Description:

BVES does not provide adequate details demonstrating use of a formal QA/QC program for its asset inspections, including documentation of its processes and results.

Required Progress:

In its 2023 WMP, BVES must:

- a) Describe the processes for its QA/QC of asset inspections, including supporting documentation of procedures.
- b) Provide the results of the QA/QC of its asset inspections performed in 2022.
- c) Provide quantitative targets for BVES's QA/QC of asset inspections (such as pass rates per quarter).
- d) Demonstrate how BVES documents and performs corrective actions based on QA/QC results and associated programmatic lessons learned.

Response:

BVES continues to mature its QA and QC programs. BVES addresses all of the Required Progress items in Section 8.1.6. These programs are further described in the BVES Asset and Inspection Quality Management Plan which is submitted as an attachment to its 2023 WMP submission.

BVES-22-14. Decline in Pole Loading Assessments.

Description:

BVES is closing out its pole loading assessment program in 2023, despite high failure rates during the assessments completed in 2020 and 2021.

Required Progress:

In its 2023 WMP, BVES must:

- a) Provide justification for why BVES is planning to close out its pole loading assessment program in 2023, including supporting data.
- b) Describe the results of the pole loading assessments completed from 2020 to 2022, including analysis on trends for number and types of failures found.

Response:

BVES is not closing out its Pole Loading and Assessment Program in 2023, it is simply merging the program with its covered wire program and asset inspection program. BVES’s pole loading assessment program is described in Sections 8.1.2 and 8.1.3 of the WMP. BVES plans to perform 850 intrusive inspections in 2023 and conducted 853 in 2022.

BVES performed analysis on pole assessments. In the first table, the analysis looked are poles that were assessed via stress analysis (3D stress analysis SPIDAcalc).

Total Number of Poles That had Stress Calculations on Them	Total Number of Poles with a Safety Factor ≥ 3.5	Total Number of Poles with a Safety Factor ≥ 3.0 and < 3.5	Total Number of Poles with a Safety Factor ≥ 2.67 and < 3.0	Total Number of Poles with a Safety Factor ≥ 2.0 and < 2.67	Total Number of Poles with a Safety Factor ≥ 1.0 and < 2.0	Total Number of Poles with a Safety Factor < 1.0
1619	788	151	122	217	292	49

BVES also looked at a data set of poles that were assessed visually and via intrusive inspection.

Total Number of Poles That Had Intrusive Test Performed on Them	Total Number of Poles Failed Assessment	Total Number of Poles Requiring Replacement	Total Number of Poles Requiring Remediation	Failure Modes			
				Stress Calculation Fail	Internal Rot (Intrusive Fail)	Uncorrectable GO-95 Discrepancy	Other (70 Year old + , Car Hit Pole)
1780	95	49	46	76	72	11	3

BVES-22-15. Effectiveness of Various Asset Inspection Initiatives.

Description:

BVES is conducting multiple types of additional inspections but has not provided data demonstrating justification and effectiveness of these initiatives.

Required Progress:

In its 2023 WMP, BVES must:

- a) Include a list of the data being tracked to measure effectiveness across asset inspection initiatives (third-party ground patrols, light detection and ranging (LiDAR), unmanned aerial vehicle (UAV) imagery, UAV thermography, etc.).
- b) Describe BVES's findings based on the data provided in (a), including lessons learned on the scale and scope of these programs moving forward.
- c) Provide any best practices and lessons learned gathered from other utilities regarding asset inspections that BVES has implemented.

Response:

The entirety of BVES's asset inspection program is described in detail in Section 8.1.3 of the 2023 WMP. This includes a description of prompts a), b), and c) above.

The following tables illustrate the effectiveness of the additional inspections.

LiDAR						
Year	Number of Circuit Miles Inspected	Number of Possible Findings	Number of Actual Findings	Number of Actual Level 1 Findings*	Number of Actual Level 2 Findings*	Number of Actual Level 3 Findings*
2019	211	8430	4615	96	1709	2810
2020	211	1920	748	50	301	397
2021	211	508	509	13	133	363

*Finding level as defined in Rule 18 of GO-95.

UAV HD Photography/Videography						
Year	Number of Circuit Miles Inspected	Number of Possible Findings	Number of Actual Findings	Number of Actual Level 1 Findings*	Number of Actual Level 2 Findings*	Number of Actual Level 3 Findings*
2021	211	952	235	1	6	228

*Finding level as defined in Rule 18 of GO-95.

UAV HD Thermography						
Year	Number of Circuit Miles Inspected	Number of Possible Findings	Number of Actual Findings	Number of Actual Level 1 Findings*	Number of Actual Level 2 Findings*	Number of Actual Level 3 Findings*
2021	211	25	25	0	0	25

*Finding level as defined in Rule 18 of GO-95.

3 rd Party Ground Patrol						
Year	Number of Circuit Miles Inspected	Number of Possible Findings	Number of Actual Findings	Number of Actual Level 1 Findings*	Number of Actual Level 2 Findings*	Number of Actual Level 3 Findings*
2019	211	NA	416	0	0	416
2020	211	NA	397	0	0	397
2021	211	NA	228	1	6	221

*Finding level as defined in Rule 18 of GO-95.

BVES-22-16. Vegetation Management Quality Control Personnel Qualifications.

Description:

BVES staff who perform vegetation management QC checks have limited direct experience in arboriculture or forestry, other than performing BVES's QC checks.

Required Progress:

BVES must:

- a) Consider alternative staffing for its vegetation management QC checks, including considering employing or contracting with certified arborists or registered professional foresters to perform these checks.
- b) In its 2023 WMP, report on how it considered alternative staffing for vegetation management QC checks and any resulting action it has taken or will take.

Response:

The objective of BVES's vegetation management QA/QC program is to promote consistent and effective vegetation management action by establishing an oversight and audit process to review the work completed by employees or contractors, including packaging QA/QC information for input to decision-making and workforce management processes. This initiative includes the identification and actionable outcomes of deficiencies and inspection protocols executed in the field. This will support improvement of work outcomes, training of personnel involved in vegetation management, and applying lessons learned from internal and external evaluations and audits.

In 2023, BVES aims to continue to execute vegetation management QC per its vegetation management QC procedures. In 2022, BVES set a QC target to conduct 72 QC reviews, more specifically 18 QC reviews per quarter. BVES selected 72 as its annual target based off of its qualified staff availability (6 individuals conducting at minimum 1 QC review a month) and wanting to maintain regularity of review. QC reviews are to be conducted by qualified staff designated in the BVES vegetation management procedures manual. Quarterly audits will be conducted by the Wildfire Mitigation and Reliability Engineer, and the annual program audit by the contracted Forester (BVES staff qualifications are discussed in Section 8.2.7).

BVES's has significantly improved its QA/QC effort over the past two years. These practices are described in detail in Section 8.2.5.

BVES-22-17. Participate in Vegetation Management Best Management Practices Scoping Meeting.

Description:

Vegetation management processes and protocols for the reduction of wildfire risk are not uniform across electrical corporations.

Required Progress:

Prior to the submission of their 2023 WMPs, BVES and all other electrical corporations (not including independent transmission operators) must participate in an Energy Safety-led scoping meeting to discuss how utilities can best learn from each other and future topics to explore regarding vegetation management best management practices for wildfire risk reduction. BVES must also participate in any follow-on activities to this meeting. This vegetation management

best management practices scoping meeting may result in additional meetings or workshops or the formation of a working group. Energy Safety will provide additional details on the specifics of this scoping meeting later in 2022.

Response:

BVES has participated in EnergySafety-led scoping meetings to discuss how utilities can best learn from each other and future topics to explore regarding vegetation management best management practices for wildfire risk reduction. BVES has also participated in all follow-on activities to the scoping meetings. Best practices adopted by BVES are highlighted in Table 8-12 and described throughout Section 8.2, particularly 8.2.1.

BVES-22-18. Updates on Protective Device Settings.

Description:

BVES does not currently implement changes to protective device settings, such as fast-trip or fast-curve settings.

Required Progress:

In its 2023 WMP, BVES must:

- a) Include its timeline for exploration of sensitivity changes to protective device settings.
- b) Provide an update on its progress towards exploring sensitivity changes to protective device settings, including findings from coordination studies and details on any changes made to settings, if applicable.

Response:

BVES's protective curve settings are always set to the fast trip settings and are not adjusted throughout the year. It is BVES's belief that its ability to always operate under this setting and still provide reliable power to its customers removes the need to explore sensitivity changes to its protective device settings. BVES uses the following protocols based off time of year and associated fire threat:

- From approximately November 1st through March 31st, the system is focused on safety and reliability and devices are set as follows:
 - All fuse TripSavers fuses are set to three trips to lockout.
 - All auto-reclosers are set to three trips to lockout.
 - Radford 34.5kV line is energized and its recloser set to three trips to lockout.
- From approximately April 1st through October 31st, BVES adopts a more defensive operational scheme during the non-winter months. To accomplish this, the utility enacts the following operational settings:
 - All TripSavers fuses are set to non-reclosing.
 - All auto-reclosers are set to non-reclosing.
 - Radford 34.5 kV line is de-energized.

BVES-22-19. Reporting of Data Management Systems.

Description:

BVES has not fully described its data management systems and planned improvements in accordance with the WMP Guidelines.

Required Progress:

In its 2023 WMP, BVES must provide detailed descriptions of its existing data systems, integration, and planned upgrades, in the following sections:

- Section 8.1.5, “Asset Management and Inspection Enterprise System”
- Section 8.2.4, “Vegetation Management Enterprise System”
- Section 8.3.2, “Environmental Monitoring Systems”
- Section 8.3.3.5, “Grid Monitoring Enterprise System”
- Section 8.3.4.5, “Ignition Detection Enterprise System”
- Section 8.3.5.5, “Weather Forecasting Enterprise System”

In general, the 2023-2025 WMP Technical Guidelines require the electrical corporations to describe the parameters of each enterprise system for data management, including inputs, data storage, integration with other systems, and any planned updates. Each section above has slightly different requirements, tailored to the system being discussed. Considering the identified need for improvement in data governance reporting, BVES must avoid providing only general information and describe each system in detail.

Response:

BVES made significant progress in migrating its many databases, which were mostly in spreadsheets, to a centralized geographic data repository. BVES engaged the support of a consultant to identify gaps and make recommendations for methods to address its GIS process and to immediately update the records in the required format. This initiative resulted in developing a common data definition, increase digitization of field work activities, and update system interfaces to automate data flow into GIS for Energy Safety reporting. Using the Energy Safety GIS Data Reporting Requirements and Schema as a guide, initial data governance steps were taken to define the system of record and assessing initial data quality for each of the required feature datasets in the OEIS schema.

BVES’s 2023 WMP Section 8.1.5 (especially Table 8-2) provides additional detail per the Continued Improvement Guidance was provided in the Sections referenced above. BVES, as stated in its 2022 WMP, was transitioning to the use of a software system (iRestore) from its existing excel based methods. BVES is currently in use as both its Asset Management and Inspection Enterprise System as well as Vegetation Management Enterprise System.

BVES-22-20. Updating Decision-Making Process.

Description:

BVES’s current decision-making process for initiative selection is linear and does not adequately demonstrate where and how BVES considers risk and risk-spend efficiencies (RSEs) in its project selection.

Required progress:

In its 2023 WMP, BVES must:

- a) Provide a more dynamic decision-making flow chart that considers “if-then” scenarios and more accurately demonstrates considerations across different initiatives, as well as lessons learned.
- b) Provide more details on how risk reductions and RSEs are weighted within the decision-making process, including details on how both are considered for actual project selection.

Response:

This topic is addressed and thoroughly discussed throughout Sections 6 and 7 of the 2023 WMP.

BVES-22-21. Improving Stakeholder and Community Engagement.

Description:

BVES lacks a plan for improving the effectiveness of its stakeholder and community engagement efforts.

Required Progress:

In its 2023 WMP, BVES must provide a plan that includes, but need not be limited to, the following components:

- a) Strategies for developing partnerships with organizations representing Native American, limited English proficiency, MBL, and AFN communities.
- b) Actions planned to improve community-level awareness of BVES wildfire mitigation and PSPS strategies.
- c) The most recent community awareness survey results, target benchmarks for improving the level of community awareness, and a timeline for reaching those benchmarks.

Response:

Following the continued improvement guidance received in its 2022 WMP Decision, BVES entered into a confidentiality agreement to share BVES's AFN and Medical Baseline population with City of Big Bear Lake and the local fire agencies in an effort to strength its ability to represent and provide the resources needed for its Native American, limited English proficiency, and AFN communities. In conjunction with this partnership BVES also made available via its website an information bifold in other top identified languages such as French, Tagalog, Vietnamese, and Chinese, as well as languages spoken by indigenous communities, such as Mixteco and Zapoteco. BVES also conducted a non-contact electronic survey regarding its WMP in 2022, with a total of 423 survey responses including 30 form critical customers. Additional efforts related to BVES efforts to improve the effectiveness of its stakeholder and community engagement efforts can be found in Sections 8.5 and 9.2 of the WMP.

BVES-22-22. Describe How PSPS Planning Is Evolving.

Description:

BVES's 2022 Update does not fully describe how it will evolve its PSPS planning beyond 2022.

Required Progress:

In its 2023 WMP, BVES must continue to apply up-to-date capabilities, protocols, and lessons learned from exercises and other utilities and incorporate them into an annually updated PSPS plan.

Response:

BVES's PSPS planning continues to evolve. In 2022, BVES performed its first functional exercise in addition to its annual tabletop exercise. These exercises helped identify weaknesses in the familiarity of the PSPS Plan and communication challenges.

BVES also updated its PSPS Plan in 2022 to include all of the Phase 3 elements required by the Public Commission and took that opportunity to streamline and reorganize its PSPS Plan.

The revised plan is more focused and actionable and includes clear roles, responsibilities, actions, and objectives.

In 2023, with the help of Technosylva's WFA-E, BVES will enhance its modeling capabilities to help attenuate its PSPS thresholds to maximize wildfire safety and minimize service disruptions to its customers.

BVES-22-23. Commit to Short-Term PSPS Reduction Targets.

Description:

BVES's 2022 Update does not fully describe quantified short-term PSPS reduction commitments and mitigation initiative targets either in Table 11 or in Section 8.

Required Progress:

In its 2023 WMP, BVES must provide quantifiable risk reduction projections of potential need for and potential frequency, scope, and duration of PSPS events during the plan term, including timelines for achieving these reduction projections. Energy Safety expects that BVES will be able to more fully quantify this information as it deploys its risk consequence modeling capability in 2023.

Response:

BVES has not had a PSPS event to date. In its 2023 WMP BVES incorporated PSPS risk reductions by program year for its Covered Conductor Program to provide more detail to the risk reduction efforts directly associated with PSPS. BVES is also using Technosylva's WFA-E model daily which provides an outlook of Fire Risk and Area Size and will be used during Fire Season to aid in the evaluation of PSPS need.

Appendix E. Referenced Regulations, Codes, and Standards

In this appendix, the electrical corporation must provide in tabulated format a list of referenced codes, regulations, and standards. An example follows.

Name of Regulation, Code, or Standard	Brief Description
Public Utilities Code section 8386	Statute related to electrical lines and equipment.
Public Utilities Code section 768.6	Statute related to emergency and disaster preparedness plans.
Public Resources Code section 4292	Statute related to firebreaks near a utility pole.
R.20-07-013	Regulation related to risk-based decision-making framework used to minimize safety risks.
R.15-06-009	Regulation related to a response to an attack on the system.
D.19-04-020	Decision related to sharing the safety performance metrics reports that document the previous year's data with the Commission.
D.17-12-024	Decision related to regulations to enhance fire safety, such as Fire-Threat Maps.
D.21-05-019	Decision related to emergency and disaster preparedness plans and notification/reporting of electric service outages.
D.21-06-034.53	Decision related to de-energization of power lines in dangerous conditions.
General Order 95	Standards for Overhead Electric Line Construction.
General Order 128	Standards for Construction of Underground Electric.
General Order 165	Standards for electric distribution and transmission facilities.
General Order 166	Standards for Operation, Reliability, and Safety during Emergencies and Disasters.
General Order 174	Standards for Electric Utility Substations
Title 14 section 29200	Regulation regarding a record's "confidential designation".

Appendix F.

Bear Valley Electric Service, Inc. Emergency & Disaster Response Plan

March 31, 2022

Approved by: Paul Marconi Digitally signed by Paul Marconi
Date: 2022.03.30 13:29:45
-07'00'

Paul Marconi, President, Treasurer, & Secretary

Bear Valley Electric Service, Inc. Emergency & Disaster Response Plan

1. Purpose and Introduction.
 - 1.1. Plan Goals
 - 1.2. Plan Vision
 - 1.3. Plan Policy
 - 1.4. Plan Responsibility
 - 1.5. General Overview
 - 1.6. Definitions

2. Emergency & Disaster Response Organization
 - 2.1. Standardized Emergency Management System(SEMS)
 - 2.2. BVES Emergency Organization
 - 2.3. BVES Emergency Operations Center (EOC)
 - 2.4. Roles and Responsibilities
 - 2.4.1. Incident Commander
 - 2.4.2. Public Information Group
 - 2.4.3. Operations Group
 - 2.4.3.1. Emergency Manager
 - 2.4.3.2. Strategic Operations Supervisor (SOS)
 - 2.4.3.3. Emergency Service Representative (ESR)
 - 2.4.3.4. System Monitor
 - 2.4.3.5. Damage Assessment Team (DAT)
 - 2.4.3.6. Line Crews
 - 2.4.3.7. Engineering Technical Support
 - 2.4.3.8. Bear Valley Power Plant (BVPP) Operators
 - 2.4.3.9. IT Operations Support
 - 2.4.4. Logistics Group
 - 2.4.5. Planning Group
 - 2.4.6. Finance & Administration Group
 - 2.5. Plan Changes

3. Emergency & Disaster Response Event Preparations
 - 3.1. Preparations
 - 3.2. Emergency Response Preparations Checklist
 - 3.3. Contingency Operating Procedures
 - 3.4. Mobile Emergency Generation
 - 3.5. Material and Equipment
 - 3.6. Vehicles
 - 3.7. Contracts for Services
 - 3.8. Mutual Aid
 - 3.8.1. California Utilities Emergency Association
 - 3.8.2. Mountain Mutual Aid Association

Bear Valley Electric Service, Inc. Emergency & Disaster Response Plan

- 3.9. Communications Layers and Message Deck
- 3.10. Staff Roster and Recall List
- 3.11. Key External Contacts List
- 3.12. Emergency Operations Center and BVES Main Facility

- 4. Emergency & Disaster Response Procedures
 - 4.1. Emergency Response Plan Implementation and Emergency Operations Center Activation
 - 4.1.1. Response Levels
 - 4.1.2. Plan Activation

 - 4.2. Essential Elements of Information (EEI)
 - 4.3. Restoration Strategy
 - 4.3.1. Restoration Strategy Assumptions
 - 4.3.2. Restoration Priorities
 - 4.3.3. Restoration Progression
 - 4.3.4. Loss or Significant Reduction of Supply
 - 4.3.5. Downed Wire Response
 - 4.3.6. Sub-Transmission and Distribution (T&D) Casualties

 - 4.4. EOC and Emergency Response Workflows
 - 4.4.1. EOC Setup
 - 4.4.2. EOC Staffing
 - 4.4.3. Managing Field Activities
 - 4.4.4. Workflows
 - 4.4.5. Situation Report
 - 4.4.6. Damage Assessments
 - 4.4.7. Work Orders

 - 4.5. Resources
 - 4.5.1. California Utilities Emergency Association (CUEA)
 - 4.5.2. Contracted Services
 - 4.5.3. Big Bear Valley Mountain Mutual Aid Association (“MMAA”)

 - 4.6. Catastrophic Events Memorandum Account (CEMA)
 - 4.7. Evacuation
 - 4.7.1. Critical Workers
 - 4.7.2. Evacuation Order

 - 4.8. End State
 - 4.9. After Action Reports
 - 4.10. Annual Emergency Response Plan Training and Exercise

Bear Valley Electric Service, Inc. Emergency & Disaster Response Plan

- 4.10.1. Annual Training
 - 4.10.2. Annual Exercise
 - 4.10.3. Exercise Notice
 - 4.10.4. Exercise Evaluation
 - 4.10.5. Emergency Response Outreach Training
5. Emergency & Disaster Response Communications Plan
- 5.1. Strategy Overview
 - 5.2. Establish Multiple and Effective Communication Channels
 - 5.2.1. Outbound Communications
 - 5.2.2. Inbound Communications
 - 5.2.3. Internal Communications
 - 5.3. Conduct Pre-Incident Outreach and Education
 - 5.3.1. City and County Outreach
 - 5.3.2. General Public, Customer and Stakeholder Outreach and Education (before an emergency)
 - 5.4. Provide Outreach in Prevalent Languages
 - 5.5. Provide Emergency Incident Communications
 - 5.5.1. Set Expectations and Develop Trust
 - 5.5.2. Notify and Engage Key Stakeholders
 - 5.5.3. Notify Customers and General Public
 - 5.5.4. Media Engagement Procedures
 - 5.5.4.1. Authorized Media Engagement
 - 5.5.4.2. Press Release Content
 - 5.5.4.3. Press Release Protocols
 - 5.5.5. Post Emergency Event Close-out Statement
 - 5.6. Reports to the Commission
6. Customer Support in Emergencies
- 6.1. Support for Low Income Customers
 - 6.2. Billing Adjustments
 - 6.3. Deposit Waivers
 - 6.4. Extended Payment Plans
 - 6.5. Suspension of Disconnection and Nonpayment Fees
 - 6.6. Repair Processing and Time
 - 6.7. Access to Utility Representatives
 - 6.8. Access to Outage Reporting and Emergency Communications

List of Figures

Figure 1-1: EDRP Goals

Bear Valley Electric Service, Inc. Emergency & Disaster Response Plan

- Figure 2-1: SEMS Organization
- Figure 2-2: BVES Emergency Organization
- Figure 5-1: Press Release Protocol

List of Tables

- Table 2-1: Possible Alternate Emergency Operation Centers
- Table 3-1: List of Minimum Contingency Contracted Services
- Table 3-2: Bear Valley Mountain Mutual Aid Association Membership
- Table 3-3: Key External Contacts
- Table 4-1: BVES Outage and Emergency Response Levels
- Table 4-2: Essential Elements of Information
- Table 4-3: Restoration Priorities for Sub-Transmission Circuits, Substations, and Distribution Circuits
- Table 4-4: BVES System Sources of Power
- Table 4-5: Actions for Loss of Supplies
- Table 4-6: Downed Wire Response
- Table 4-7: CUEA Mutual Assistance Process

List of Appendices

- Appendix A: EOC Preparedness and Setup Checklist
- Appendix B: Emergency Response Preparations Checklist
- Appendix C: Contingency Contracted Services
- Appendix D: BVES Staff Roster and Recall List
- Appendix E: Key External Contacts List
- Appendix F: Emergency Response Workflows
- Appendix G: Sample Situation Report (SITREP)
- Appendix H: Sample Damage Assessment Form
- Appendix I: Sample Work Order Jacket
- Appendix J: Sample Mutual Assistance Agreement Letter

Bear Valley Electric Service, Inc. Emergency & Disaster Response Plan

1. **Purpose and Introduction.** The Emergency & Disaster Response Plan (EDRP) is provided to all Bear Valley Electric Service, Inc. (“BVES”) employees to ensure an efficient, effective and uniform response during an emergency situation. BVES recognizes the importance of an integrated EDRP in order to safely provide for the energy needs of our customers and the requirements of our stakeholders in the event of an emergency.

The EDRP outlines BVES’ philosophy and procedures for managing major emergencies that may disrupt electric service to our customers or threaten the health and safety of the people in the communities we serve. The EDRP further establishes the structure, processes and protocols for the BVES’s emergency response and identifies departments and individuals that are directly responsible for that response and critical support services. In addition, it provides a management structure for coordination and deployment of the essential resources necessary for the response.

The EDRP is designed to provide a framework for managing and responding to:

- Large outages
- Numerous smaller outages
- Potential for large outages
- Potential for numerous smaller outages
- Any combination of the above

The EDRP may be invoked as a precautionary measure when there is a strong potential for outages or in response to actual outages. The EDRP is designed to be implemented as needed in conjunction with other procedures, plans, and policies such as:

- Public Safety Power Shutdown Plan
- Wildfire Mitigation Plan
- Field Operations and Engineering Procedures
- Customer Service Procedures
- Other organizations such as State, County, and City Emergency Disaster Plans

The EDRP complies with the requirements set forth in the Public Utilities Commission of the State of California’s General Order No. 166, Standards for Operation, Reliability, and Safety during Emergencies and Disasters.

1.1. **Plan Goals.** When an emergency occurs, BVES’ response actions are guided by the following overriding emergency goals (in order of priority):

- **Safety:** Protect the life-safety of our customers, employees and the general public.
- **Restoration of Power:** Restore electric service to customers in a safe and timely manner.
- **Communications:** Keep customers, stakeholders, and staff informed.

Bear Valley Electric Service, Inc. Emergency & Disaster Response Plan

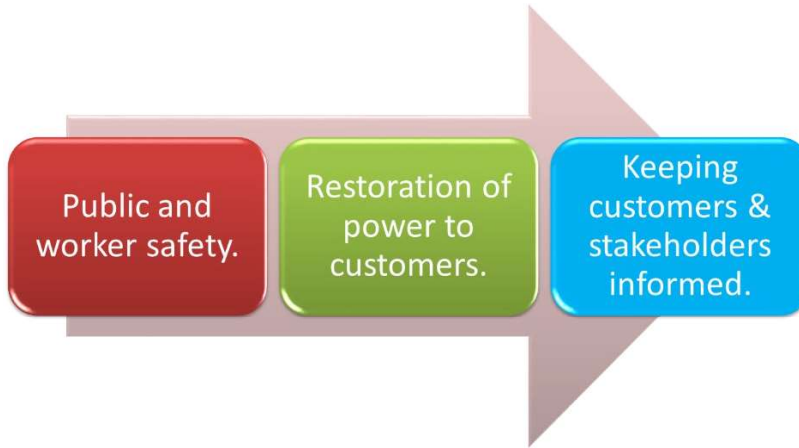

Figure 1-1: EDRP Goals

1.2. **Plan Vision.** BVES strives to meet customer needs through effective risk assessment, mitigation, preparedness, response and communications. Our vision is to achieve excellence in emergency management performance.

1.3. **Plan Policy.** BVES strives to utilize effective emergency management principles that enhance the BVES's ability to provide safe and reliable electric power and its ability to communicate timely and accurate information to customers and stakeholders by:

- Conducting effective risk assessments for operating and business functions;
- Developing appropriate prevention or risk mitigation strategies;
- Implementing comprehensive emergency preparedness programs;
- Responding with appropriate resources to address emergencies;
- Communicating with customers and other stakeholders with timely and accurate information;
- Recovering from events safely and expeditiously; and
- Improving continuously.

Since major outage events and emergencies are rarely similar in all respects, the EDRP is constructed in such a way to provide BVES management with a trained and operationally ready workforce and a response operations process that may be employed as required to deal with the unique aspects of each major outage and emergency event.

The effectiveness of the EDRP is based on BVES' commitment to prepare for, to implement, and to review procedures after each implementation. An after action review process shall facilitate continuous improvement in the BVES's response and restoration processes.

Execution of the appropriate response to affect rapid and safe recovery is dependent upon the scalability of this plan. For example, storm intensities and the number of customers affected vary and, therefore, the level of recovery resources committed to each event is adjusted as appropriate even though the operational concepts remain consistent.

Bear Valley Electric Service, Inc. Emergency & Disaster Response Plan

1.4. **Plan Responsibility.** It is the responsibility of all Managers and Supervisors to ensure the EDRP is reviewed by all staff and is updated when appropriate. Specific responsibilities are provided throughout the EDRP.

1.5. **General Overview.** BVES customers receive electric service through an overhead and underground distribution system. Extreme weather events such as heavy rain, hail, snow, ice, lightning, high winds, and/or extreme dry heat may adversely impact the integrity of the distribution system, resulting in occasional interruptions of electric service. The distribution system is also susceptible to damages as a result of major disasters, such as earthquakes, flooding, wildfires, and mud and rock slides. Furthermore, in the interest of public safety, BVES may deem it necessary to proactively de-energize large portions of the distribution system to protect the public; for example, BVES may de-energize circuits or portions of circuits during extreme fire threat weather conditions. BVES normally imports power to its service area via Southern California Edison's (SCE) transmission lines. Therefore, the BVES service area may be susceptible to outages caused by events outside of its services area. All of the above may result in major power outages of varying extent and length depending on the severity of the event. Since electricity is a critical element in our daily lives, prompt restoration is a reasonable customer expectation and a BVES goal. In the case of major disasters, rapid and efficient restoration of power; especially to critical infrastructure, is essential to overall community disaster recovery.

The response to customer outages caused by severe weather events, other disasters or events affecting power delivery to the BVES service area is predicated on recognizing and understanding the magnitude of the event as well as the availability of resources to support the restoration process. This plan has been designed to provide a systematic organized response plan for the purpose of promoting a safe and efficient recovery from any of those conditions. Since the potential of sustaining damages is highest for storm situations, the plan specifically addresses these situations but it may easily be adapted to major outages caused by other disasters or causes.

It is also recognized that no plan can possibly predict and cover every emergency situation. Therefore, the EDRP provides a structure that is based on a set of reasonable assumptions for the most likely emergencies requiring emergency response; but it also provides the BVES's Incident Commander the authority, flexibility, and discretion to alter the BVES's emergency response to tailor it to the specific emergency situation in order to optimize the utilization of BVES resources and to achieve the emergency response goals in an effective and efficient manner.

A critical component of the EDRP is close coordination with stakeholders that depend on BVES's service and assistance for their response actions and who may, also, be able to assist BVES in its response actions. The coordination must occur in developing the plan, training on the plan, executing the plan, and in plan refinements. Some of BVES's major stakeholders include:

- Local officials (City of Big Bear Lake (CBBL) and San Bernardino County)
- State officials (California Public Utilities Commission)
- San Bernardino County Office of Emergency Services (County OES)
- Big Bear Fire Department

Bear Valley Electric Service, Inc. Emergency & Disaster Response Plan

- California Department of Forestry and Fire Protection (CAL FIRE)
- U.S. Forest Service
- San Bernardino County Sheriff's Department Big Bear Lake Patrol Station
- California Highway Patrol (CHP) Arrowhead Area
- California Department of Transportation (Caltrans)
- Big Bear Area Regional Wastewater Agency (BBARWA)
- Big Bear City Community Services District (CSD)
- Big Bear Lake Water Department (DWP)
- Big Bear Municipal Water District (MWD)
- Southwest Gas Corporation
- Bear Valley Community Hospital
- Bear Valley Unified School District
- Big Bear Chamber of Commerce
- Big Bear Airport District
- Big Bear Mountain Resort
- Various media and communications companies

Accurate, effective and timely communications with key stakeholders is critical in emergency response and, therefore, it is essential that business relationships be developed before emergency response is necessary. Understanding stakeholders' key staff, contact information, roles and responsibilities, and capabilities are extremely useful in achieving successful emergency response.

1.6. Definitions.

Accessible: A condition which permits safe and legal access.

Access and Functional Needs Populations: Refers to those populations with access and functional needs as set forth in Government Code § 8593.3. Access and functional needs population consists of individuals, including but not limited to, individuals who have developmental or intellectual disabilities, physical disabilities, chronic conditions, injuries, limited English proficiency or who are non-English speaking, older adults, children, people living in institutionalized settings, or those who are low income, homeless, or transportation disadvantaged, including, but not limited to, those who are dependent on public transit or those who are pregnant.

Appropriate Regulatory Authority: The agency or governmental body responsible for regulation or governance of the utility.

Critical Customers: Customers requiring electric service for life sustaining equipment.

Emergency or Disaster: An event which is the proximate cause of a major outage, including but not limited to storms, lightning strikes, fires, floods, hurricanes, volcanic activity, landslides, earthquakes, windstorms, tidal waves, terrorist attacks, riots, civil disobedience, wars, chemical spills, explosions, and airplane or train wrecks.

Bear Valley Electric Service, Inc. Emergency & Disaster Response Plan

Essential Customers: Customers representing critical infrastructure and Public Safety Partners.

Major Outage: Consistent with Public Utilities Code Section 364, a major outage occurs when 10 percent of the electric utility's serviceable customers experience a simultaneous, non-momentary interruption of service. For utilities with less than 150,000 customers within California, a major outage occurs when 50 percent of the electric utility's serviceable customers experience a simultaneous, non-momentary interruption of service.

Measured Event: A Measured Event is a Major Outage (as defined herein), resulting from non-earthquake, weather-related causes, affecting between 10% (simultaneous) and 40% (cumulative) of a utility's electric customer base. A Measured Event is deemed to begin at 12:00 a.m. on the day when more than one percent (simultaneous) of the utility's electric customers experience sustained interruptions. A Measured Event is deemed to end when fewer than one percent (simultaneous) of the utility's customers experience sustained interruptions in two consecutive 24-hour periods (12:00 a.m. to 11:59 p.m.); and the end of the Measured Event in 11:59 p.m. of that 48-hour period.

Public Safety Partners: First/emergency responders at the local, state and federal level, water, wastewater and communication service providers , community choice aggregators (CCAs), affected publicly-owned utilities (POUs)/ electrical cooperatives, tribal governments, the Commission, CalOES and CAL FIRE.

Safety Standby: Interim activities undertaken to mitigate immediate public safety hazards

Serviceable Customer: A customer prepared and properly equipped to receive service where both the customer's electrical service facilities and those facilities of the utility necessary to serve the customer can be legally and physically accessed in a safe manner.

Sustained Outage: An electric service interruption (0 voltage) lasting greater than 5 minutes.

Bear Valley Electric Service, Inc. Emergency & Disaster Response Plan

2. **Emergency Response Organization.** The EDRP requires that in responding to emergencies, the BVES's staff shall be organized largely based on the Standardized Emergency Management System (SEMS) as interpreted by the BVES. The SEMS structure utilized by BVES is a utility compatible Incident Command Structure (ICS) framework designed to manage emergency incidents and events.

2.1. **Standardized Emergency Management System.** SEMS is an emergency preparedness and response system that has been endorsed by the State of California. It is the cornerstone of California's emergency response system and the fundamental structure for the response phase of emergency management. It unifies all elements of California's emergency management community into a single integrated system and standardizes key elements. Additionally, it provides a common structure for all organizations responding to an emergency situation and a means of systematic planning. The benefits of using the SEMS include:

- Use of common terminology among agencies.
- Use of parallel organizational functions among agencies.
- Provides a standard means of systematic planning.

The basic SEMS organization structure is shown in Figure 2-1, SEMS Organization:

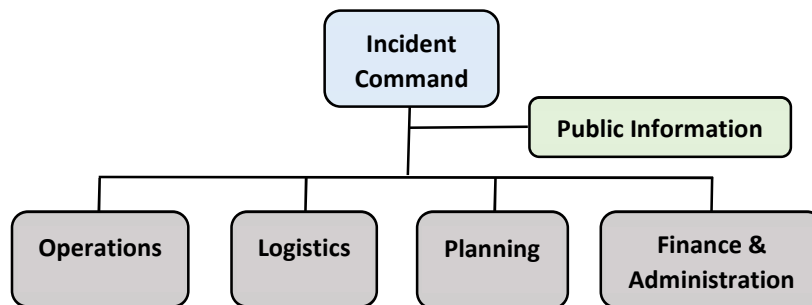

Figure 2-1: SEMS Organization

By organizing the response team along the SEMS structure, the BVES emergency response team is able to coordinate with other government and agencies via their corresponding groups. For example, BVES Operations would coordinate directly with the City of Big Bear Lake Emergency Operations Center or the San Bernardino County OES Operations Groups as applicable. Additionally, when BVES sends a representative to these two centers the representative shall already have a good understanding of the emergency response organization.

2.2. **BVES Emergency Organization.** The organization chart presented below in Figure 2-2, BVES Emergency Organization, provides the BVES Emergency Organization structure for the full mobilization (Level 1) of BVES' staff in responding to emergencies per this plan. It is the intent that this organizational structure would operate out of an Emergency Operations Center (EOC) established by BVES and be sustainable for long-term emergency response activities.

Bear Valley Electric Service, Inc. Emergency & Disaster Response Plan

BVES Emergency Organization

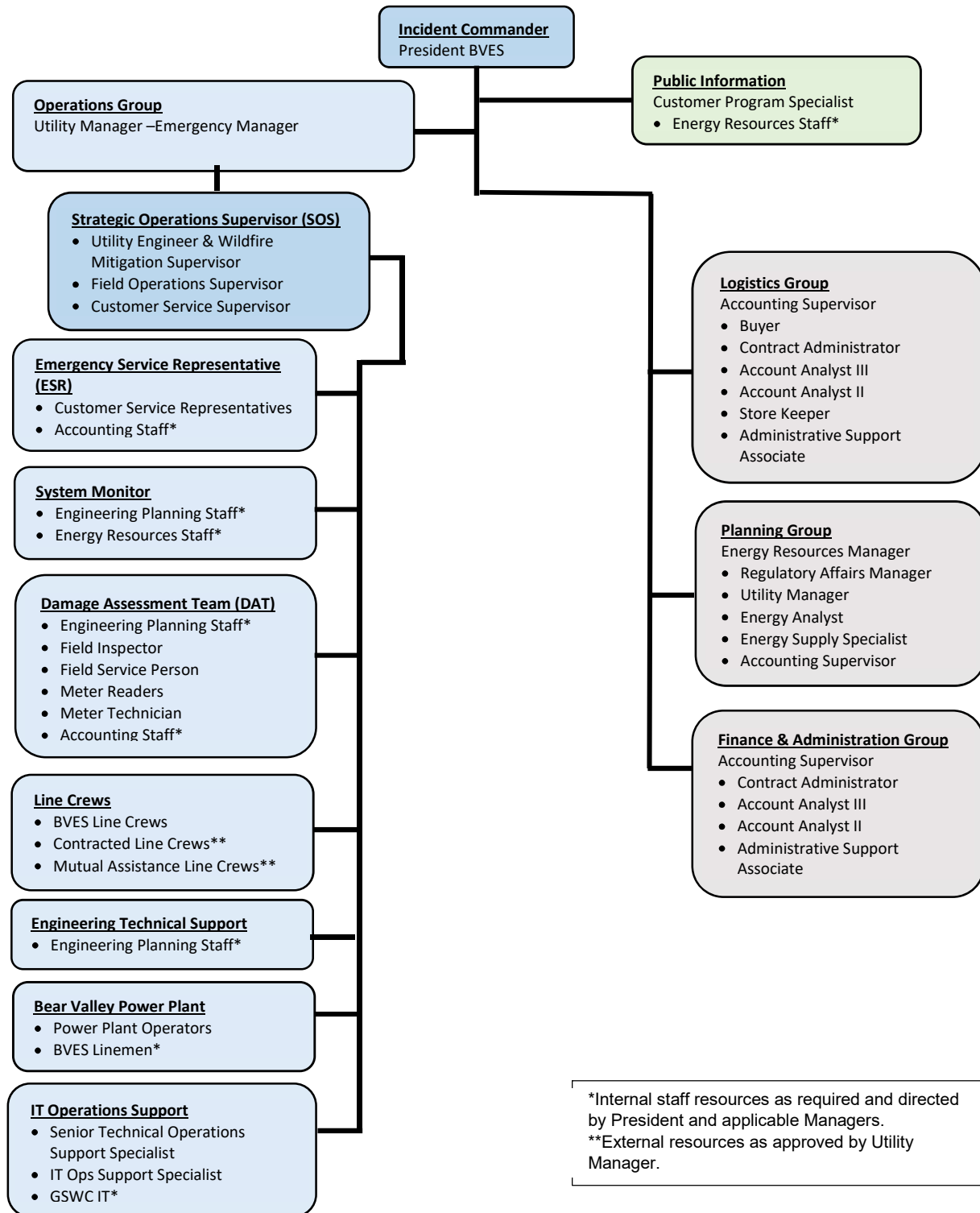

Figure 2-2: BVES Emergency Organization

The specific description of roles and responsibilities for the positions in the BVES Emergency Organization are provided in Section 2.4.

Bear Valley Electric Service, Inc. Emergency & Disaster Response Plan

2.3. **BVES Emergency Operations Center (EOC).** An EOC shall be designated for BVES staff use in the event of an emergency. The EOC is the central command and control facility responsible for carrying out the principles of emergency preparedness and emergency response functions described in the EDRP, ensuring public and worker safety, continuity of operations, and timely communications with customers and stakeholders.

An EOC is primarily responsible for strategic direction and operational decisions. Due to the relatively small size of BVES, the Strategic Operations Supervisor (SOS) under the direction of the Operations Group at the EOC shall provide tactical emergency response direction and directly control field assets. The activities under the SOS' management at the EOC shall include all dispatch functions to include customer communications and field operations. For the purpose of the EDRP, when "dispatch" functions are referred to the EOC they are intended for the SOS and supporting team at the EOC.

The common functions of the EOC is to collect, gather and analyze data; make decisions that protect public and worker safety and property; safely maintain and/or restore continuity of operations, within the scope of applicable regulations and laws; and disseminate those decisions to all concerned customers and stakeholders in a timely manner.

2.3.1. The EOC is where the Incident Command, Operations, Planning, Logistics, Financial & Administration, and Public Information groups are located and come together. It serves as the central point for:

- Information gathering and dissemination.
- Directing emergency and restoration operations at both the strategic and tactical level.
- Coordinating with other external agencies and stakeholders.
- Developing and issuing customer and stakeholder communications.
- Evaluating available resources and requesting or relinquishing resources as appropriate.

2.3.2. The EOC shall meet the following requirements:

- Be available for immediate occupancy.
- Have access to backup electrical power.
- Contain access to multiple communication systems such as telephones, mobile phones, VHF radio, internet service, Interactive Voice Response (IVR), etc.
- Be equipped with emergency supplies, system maps and operating information.
- Be capable of sustaining long-term emergency response.

2.3.3. The primary EOC for BVES shall be located at BVES' Main Office at 42020 Garstin Dr., Big Bear Lake, CA 92315 in the "Main Conference Room."

2.3.3.1. The Utility Manager is responsible for ensuring the primary EOC is ready for immediate occupancy. Appendix A, EOC Preparedness and Setup Checklist, provides a list of equipment, capabilities, materials and supplies that should be available to the primary EOC. Some items need not be located in the EOC, but should be in close proximity and readily accessible to EOC staff. The Senior Technical Operations Support Specialist shall maintain

Bear Valley Electric Service, Inc. Emergency & Disaster Response Plan

Appendix A up to date as configuration and technology changes are implemented and provide the Administrative Support Associate the latest version of the checklist. The checklist will also be maintained in the EOC.

2.3.3.2. If the primary EOC will not be ready for immediate occupancy, the Utility Manager shall establish an alternate EOC that is ready for immediate occupancy and shall notify BVES staff. Table 2-1 below provides a list of possible alternate EOCs to be considered.

Table 2-1: Possible Alternate Emergency Operation Centers

<u>Location</u>	<u>To Be Considered</u>
Operations & Planning spaces at the BVES Main Office	Primary EOC not available. Also consider this site, when scope of emergency response activation is reduced (such as Level 2 activation) and all or most activity is carried out by Field Operations.
BVES's General Office in San Dimas, California	When evacuation of the BVES service area is ordered.
State or County's Incident Commander's base camp	When the BVES Main Office is not accessible.
Other suitable area designated by the Utility Manager	When primary EOC is not accessible or available and the above options are not the optimal location.

2.3.3.3. In selecting an alternate EOC location, the Utility Manager shall at a minimum consider the following factors:

- Safety of BVES emergency response staff
- Location of hazards and potential movement of hazards
- Location of the emergency
- Communications capability and ability to coordinate efficiently with stakeholders
- Location and accessibility to BVES resources (staff, equipment, material, etc.)

2.4. **Roles and Responsibilities.** This section provides the general intended roles and responsibilities of the BVES Emergency Organization shown in Figure 2-2. It should be noted that the Incident Commander and Group Leaders have the authority to modify roles and responsibilities of those under their responsibility to optimally respond to the specific emergency event. When modifications are made, these should be included during the after action report for the event so that possible changes to the EDRP may be considered. BVES has a small staff, therefore, in the interest of sustainability, efficiency and effectiveness, some staff are “dual hatted” and may be assigned multiple roles and responsibilities.

2.4.1. Incident Commander

2.4.1.1. President, BVES is the primary BVES staff assigned. Alternates that may be assigned include: Utility Manager, Energy Resources Manager, Regulatory Affairs Manager, or other BVES officials as directed by the Chief Executive Officer (CEO).

2.4.1.2. Incident Commander reports directly to the CEO.

Bear Valley Electric Service, Inc. Emergency & Disaster Response Plan

2.4.1.3. Overall responsible for organizing and directing the EDRP by providing strategic direction for the emergency response. Activities associated with the Incident Commander are mostly strategic in nature and include, but are not limited to:

- Direct EOC activation. Based on the emergency level and the particular situation surrounding the emergency, may direct partial activation of the EOC.
- Authorize de-activation of the EOC (or any partial de-activation).
- Authorize use of alternate EOC location when appropriate.
- Provide timely and accurate updates to Senior BVES management (CEO, CFO, VP Regulatory Affairs, etc.) of emergency response.
- Approve and/or conduct high-level communications with federal, state, county, and/or city officials as well as other utilities and non-governmental organization (NGOs).
- Approve and/or conduct external communications with media and the public.
- Approve regulatory reports for outages, incidents and accidents (GO-95, GO-128 & GO-166). Work closely with Regulatory Affairs at the General Office (GO).
- Approve situation reports that may be requested by external organizations such as California Utility Emergency Association (CUEA), State of California Office of Emergency Services (OES), San Bernardino County OES, City of Big Bear Lake, California Public Utilities Commission (Safety Enforcement Division and Energy Division), local Incident Commander, etc.
- Ensure Operations, Planning, Logistics, and Finance & Administration Groups (SEMS) are properly resourced to respond to emergency.
- Lead periodic update meetings with the BVES SEMS Group Leaders.
- Approve requests for mutual aid.
- Approve use of emergency contracting and procurement provisions.

2.4.2. Public Information Group.

2.4.2.1. Customer Program Specialist is the primary BVES staff assigned to this group. Alternates who may be assigned include: Energy Supply Specialist, Customer Service Supervisor, or others as designated by the Incident Commander. Generally, the Customer Program Specialist and Energy Supply Specialist (or other staff assigned) shall alternate shifts.

2.4.2.2. Public Information reports directly to the Incident Commander on all public information issues and coordinates directly with the leaders of the Operations, Planning, Logistics and Finance & Administration Groups to stay informed on the latest status of the emergency response. Attends BVES SEMS leadership meetings.

2.4.2.3. Public Information facilitates communication with all stakeholder groups, including the news media and provides a variety of public information services during an electric system emergency. Activities associated with Public Information include, but are not limited to:

- Develop public engagement strategy and directs all aspects of public messaging.
- Keep customers, stakeholders, BVES management and employees informed on the status of the emergency response including extent of outages, cause of outages, damage and

Bear Valley Electric Service, Inc. Emergency & Disaster Response Plan

casualty assessments, restoration efforts in progress and planned, estimated time to restore service, and updates to the emergency response through widely available communications channels.

- Act as the central point of contact for any external public inquiries.
- Prepare and distribute public information releases for media, website, social media, interactive voice response and two-way text messages, state and local government, and other BVES stakeholders.
- Prepare and distribute responses to media inquiries.
- Coordinate with the General Office and other stakeholder public information officials.
- Work closely with the Incident Commander, public relations contractor and General Office (Regulatory Affairs) on public engagement.
- Work closely with other SEMS Groups to be informed of latest information.
- Provide line crews, customer service and other staff who operate in the field or interact directly with customers with the latest information to be shared with public.
- Coordinate participation in joint press conferences with other stakeholders as needed or directed.
- Organize press conferences as needed or as directed.
- Assist in preparing the Incident Commander and other BVES staff for press conferences and interviews.
- Follow media and social media for discussion of BVES and develop rapid response to dispel erroneous information.
- Update BVES website, social media, local media, interactive voice response and two-way text messages, and other communications platforms as conditions change.
- Activate advertising campaigns with local media when appropriate.

2.4.3. Operations Group. The Operations Group is overall responsible for all of the emergency response actions in the field necessary to safely restore service to customers. As such, this group is made up of customer service, line crews, field operations, engineering and planning, and power generation staff and contractors. The Emergency Manager leads this group.

2.4.3.1. Emergency Manager. Utility Manager is the primary BVES staff assigned. Alternates who may be assigned include: Energy Resource Manager, Utility Engineer & Wildfire Mitigation Supervisor and Field Operations Supervisor. The Emergency Manager reports directly to the Incident Commander. Activities associated with the Emergency Manager are partly strategic and partly tactical in nature and include, but are not limited to:

- Ensure public, employee and contractor safety is top priority in all restoration activities.
- Authorize deviations to the EDRP as necessary to safely, efficiently and effectively execute restoration activities.
- Attend BVES SEMS leadership meetings.
- Issue the work schedule and shift rotations for all staff and contractors assigned to the Operations Group.
- Direct the number of Emergency Service Representatives, System Monitors, Damage Assessment Teams, and Line Crews to be assigned per shift.
- Ensure staff and contractors are adequately rotated to allow for rest and safe operations.
- Authorize overtime labor expense as needed.

Bear Valley Electric Service, Inc. Emergency & Disaster Response Plan

- Direct all restoration and emergency response activities in the field.
- Keep Incident Commander and Public Information informed of progress.
- Drive to obtain and communicate “estimated time of restoration” (ETR) for outages and update this information as the situation progresses.
- Coordinate with other SEMS Groups.
- Constantly evaluate restoration progress and optimize utilization of available resources to safely, efficiently and effectively restore service.
- Identify and request additional resources when needed and stand-down resources when no longer required.
- Coordinate restoration activities with other external entities (City, County, Fire Department, Sheriff, CHP, Forestry Service, CALTRANS, other utilities, contractors, etc.).
- Assign and dispatch a knowledgeable BVES representative to local government and/or agency Incident Command as needed.
- Ensure outages, incidents, and accidents are properly documented.
- Assist in preparing regulatory reports for outages, incidents, and accidents (GO-95, GO-128 & GO-166).
- Prepare external situation reports as requested.
- Ensure cost recovery records and documentation for restoration work are being maintained as requested by the Finance and Administration Group.
- Review weather forecast and other external information to optimize restoration response.
- Prepare mutual aid inquiries and requests.
- Communicate logistics requirements to complete restoration activities.
- Work collaboratively with other stakeholder organizations and the General Office as applicable on logistics issues.
- Perform other operations activities as directed by the Incident Commander.

2.4.3.2. *Strategic Operations Supervisor (SOS)*. The Field Operations Supervisor, Utility Engineer & Wildfire Mitigation Supervisor, and Customer Service Supervisor are the primary BVES staff assigned. Alternates who may be assigned include: Utility Manager and the Regulatory Compliance Project Engineer. The SOS reports directly to the Emergency Manager. Activities associated with the SOS are mostly tactical in nature and include, but are not limited to:

- Ensure public, employee and contractor safety is top priority in all restoration activities.
- Maintain the “common operational picture” in the EOC. Utilizes the Outage Management System (OMS), Supervisory Control and Data Acquisition (SCADA), CC&B, GIS applications, and other applications to manage information and data in support of restoration efforts.
- Act as the Emergency Manager’s direct representative in the EOC and direct all operations activities to include all dispatch functions while the EOC is activated. For the purpose of this EDRP, the SOS is equivalent to “Dispatch” and the terms may be used interchangeably.
- Function as the central Dispatch during EDRP implementation. Receive, prioritize, dispatch, and resolve all Field Activities (FA’s) and Transmission and Distribution (T&D) system problems reported by other means per BVES priorities identified in the EDRP.
- Direct all restoration and emergency response activities in the field.

Bear Valley Electric Service, Inc. Emergency & Disaster Response Plan

- Direct and supervise the Emergency Service Representative(s), System Monitor, Damage Assessment Team(s), Line Crews (BVES, contracted and/or mutual aid), Bear Valley Power Plant Operators, IT Operations Support and Contracted Services (for example, snow removal, vegetation management, etc.) in all aspects of EDRP activities.
- Ensure resources are safely, efficiently and effectively deployed per the EDRP priorities and as directed by the Emergency Manager.
- Recommend to the Emergency Manager whether to increase, maintain, or decrease restoration resources to safely, efficiently, and effectively execute the restoration activities.
- Properly document outages, incidents, and accidents.
- Maintain cost recovery records and documentation of work completed as requested by the Finance Group at the General Office.
- Review weather forecast and other external information to optimize restoration response.
- Develop logistics requirements necessary to complete restoration activities.
- Keep Emergency Manager and Public Information informed of progress.
- Update Situation Report.
- Dispatch the Bear Valley Power Plant (BVPP) as needed. Coordinate any logistics necessary to operate the power plant.
- Ensure accurate and detailed status of T&D switches, equipment and facilities are maintained in the EOC and updated as changes occur.
- Approve field switching orders and direct all field switching operations.
- Mostly operate in the EOC but may go out to the field as needed to personally view issues. When departing the EOC, the SOS should designate a knowledgeable staff member to be in charge of the EOC during his absence. It may be advantageous for the off-going SOS to tour outage sites immediately after shift and provide the SOS a report. Alternatively, it may be advantageous for the on-coming SOS to tour outage sites prior to shift.

2.4.3.3. Emergency Service Representative (ESR). BVES staff who are assigned to this task are the Customer Service Representatives and the Customer Service Specialist. The number of ESR staff assigned per shift shall be directed by the Emergency Manager. Other staff may be requested to augment the ESR Team or to augment certain functions of the ESR Team (for example, EOC staff may be used to call back customers as needed). Additionally, the ESR function or some portions of the ESR function may be transferred to BVES's contracted call center during non-business hours when call volume is low. ESR staff reports directly to the SOS. Activities associated with the ESR Team include, but are not limited to:

- Process incoming customer calls.
- Issue FA's as appropriate.
- Route FA's to EOC dispatch for action.
- Update the Outage Management System as applicable.
- Assist EOC Dispatch in organizing and prioritizing incoming FA's as directed by SOS.
- During extremely high volume periods, alternative procedures may be employed to route FA's more efficiently as directed by the Emergency Manager. For example, the ESRs may be requested to route a periodic CSV file from CC&B of new FA's to EOC Dispatch instead of individual FA's.
- May be assigned to provide first layer of sorting FA's by type (outage, line down, etc.) as directed by the SOS.

Bear Valley Electric Service, Inc. Emergency & Disaster Response Plan

- Respond to customer inquiries on system status using latest information from EOC.
- Provide SOS information on customers with “Life Support” and Access and Functional Needs (AFN) customers affected by outages.
- Update IVR and two-way text messages as directed by the SOS.
- Update Customer Care and Billing (CC&B) with results of completed FA’s from EOC.
- Call customers to verify power restoration as directed by SOS.
- Normally ESR staff perform assigned duties in the Customer Service area. The Emergency Manager may direct ESR staff to work at another area.

2.4.3.4. *System Monitor*. Staff assigned to this position are directed by the Emergency Manager and are generally selected from the following staff: Energy Analyst, Regulatory Compliance Project Engineer, Wildfire Mitigation & Reliability Engineer, Utility Planner, GIS Specialist, Engineering Technician, Engineering Inspector, Substation Technician, Meter Technician, Field Inspector, Senior Account Analyst, Account Analyst, and Administrative Support Associate. Other staff as deemed qualified by the Emergency Manager may also be assigned. Normally, one System Monitor shall be assigned per shift but additional System Monitors may be assigned to certain shifts when activity is expected to be high. The System Monitor reports directly to the SOS. Activities associated with the System Monitor include, but are not limited to:

- Assist the SOS in maintaining the “common operational picture” in the EOC. Utilizes the Outage Management System (OMS), SCADA, CC&B, GIS applications, and other applications to manage information and data in support of restoration efforts.
- Work closely with Emergency Service Representatives to transfer information.
- Update the Situation Report.
- Assist in receiving, prioritizing, dispatching, and resolving all FA’s and T&D system problems reported by other means per BVES priorities identified in the EDRP.
- Take reports from the Line Crews, Damage Assessment Teams and other field assets and communicate this information to appropriate EOC staff.
- Document outages, incidents, and accidents.
- Maintain cost recovery records and documentation of work completed as requested by the Finance and Administration Group.
- Review weather forecast and other external information and provide this information to the SOS and Emergency Manager.
- Maintain status of the BVPP as needed.
- Assist SOS in maintaining an accurate and detailed status of T&D switches, equipment and facilities in the EOC.
- Assist the SOS in execution of responsibilities as directed.
- Perform assigned duties in the EOC.

2.4.3.5. *Damage Assessment Team (DAT)*. Staff assigned to this team are as directed by the Emergency Manager and are generally selected from the following staff: Field Inspector, Substation Technician, Meter Technician, Field Serviceperson, Meter Readers, Wildfire Mitigation & Reliability Engineer, Utility Planner, GIS Specialist, Engineering Technician, Engineering Inspector, Buyer, Storekeeper, Regulatory Compliance Project Engineer, and Energy Analyst. Other staff as deemed qualified by the Emergency Manager may also be

Bear Valley Electric Service, Inc. Emergency & Disaster Response Plan

assigned to this team. Normally, each DAT shall consist of two people. At least one DAT shall be assigned to each shift. Additional DATs may be assigned to certain shifts when activity is expected to be high. The DAT reports directly to the SOS. Activities associated with the DAT include, but are not limited to:

- Assist the SOS in execution of responsibilities as directed.
- Perform field investigations as directed by SOS.
- Keep the SOS informed of their position when out in the field.
- Provide detailed assessments and documentation including photographs and video of damage to SOS.
- Coordinate with and assist Line Crews as directed by SOS.
- Normally travel in pairs; especially during storm and other potentially hazardous conditions and at night. When conditions are favorable, the Emergency Manager may permit DAT field inspections to be performed by a single person.
- When not in the field, perform duties in the EOC as directed by the SOS.

2.4.3.6. Line Crews. Staff assigned to this crew are BVES Journeyman Lineman Crews (including Apprentice employees). Other BVES staff that are Journeyman Lineman (for example, Field Inspector) may be assigned as needed and directed by the Emergency Manager to augment BVES Line Crews. Emergency Manager may also assign Contracted Line Crews and Line Crews from other utilities through mutual aid agreements. The Emergency Manager shall direct the specific crew sizes, shift lengths and rotations, and functions (such as construction, service response, wire down and minor damage response, switching operations, patrols, damage assessments, etc.). The Line Crews report directly to the SOS. Activities associated with the Line Crews include, but are not limited to:

- Perform field activity work (such as construction, service response, wire down and minor damage response, switching operations, patrols, damage assessments, etc.) as directed by SOS.
- Keep SOS informed of work progress and developments in the field.
- Keep SOS informed of the status of T&D switches, equipment and facilities.
- Provide information (such as labor hours, equipment usage, and material consumption) to allow the collection of accurate cost recovery records and documentation for work completed.
- Assist in documenting outage and T&D system damage and restorations efforts.
- Consult with SOS on technical issues that may require Engineering & Planning evaluation and input.
- Request additional resources as needed.
- Operate Bear Valley Power Plant engines as directed.

2.4.3.7. Engineering Technical Support. The primary assigned are Engineering and Planning staff (Utility Engineer & Wildfire Mitigation Supervisor, Regulatory Compliance Project Engineer, Utility Planner(s), Wildfire Mitigation & Reliability Engineer, GIS Specialist, Engineering Technician, and Engineering Inspector) as designated by the Emergency Manager. This function may be augmented by mutual aid from other utilities and/or qualified contractors as the Emergency Manager deems necessary. Normally, Engineering Technical Support is an

Bear Valley Electric Service, Inc. Emergency & Disaster Response Plan

“on-call” function as requested by the SOS. Engineering and Planning staff are generally “dual hatted” and perform other EDRP functions as assigned by the Emergency Manager. When there is a need for Engineering Technical Support, the System Monitor and SOS shall prioritize the specific workload for each Engineering and Planning staff (for example, Utility Planner may be pulled from the DAT to perform planning activities such as loading assessments on pole replacements and then return to DAT duties once the engineering work is completed).

2.4.3.8. *BVPP Operators*. Primary assigned are the BVPP Operators. BVES Journeyman Lineman may also be assigned as directed by the Emergency Manager. Additionally, the Emergency Manager may contract out for additional BVPP Operators, if needed. The Emergency Manager shall direct BVPP Operators and their shift schedule as necessary to support the anticipated or actual dispatching of the power plant. The BVPP Operators report directly to the SOS. Activities associated with the BVPP Operators include, but are not limited to:

- Operate the BVPP as directed by SOS.
- Maintain BVPP at the ready when not dispatched.
- Ensure backup systems fully operational.
- Ensure readiness to perform “Black Start” procedure.
- Request additional resources as needed.
- Document materials and labor hours expended.

2.4.3.9. *IT Operations Support*. Primary assigned is the Senior Technical Operations Support Specialist and the Technical Operations Support Specialist. GSWC IT resources may provide backup support for this function. IT Support shall report directly to the SOS. Activities associated with IT Support include, but are not limited to:

- Ensures utmost business continuity by monitoring and maintaining EOC, Operations & Planning, Customer Service, Accounting and Energy Resources communications and IT systems are operating properly.
- Provides support to ensure connectivity to critical applications.
- Coordinates communications and IT systems issues with GSWC IT.
- Resolves local IT and network connectivity issues with field equipment and systems (for example, SCADA).
- Coordinates communications and connectivity with other entities as directed.
- Assists with other duties as directed by the SOS.

2.4.4. Logistics Group.

2.4.4.1. The Accounting Supervisor is the primary BVES staff assigned in charge of the Logistics Group. Alternates that may be assigned include the Senior Accounting Analyst, Buyer or others as designated by the Incident Commander.

2.4.4.2. The Logistic Group shall normally be made up Accounting Supervisor, Senior Account Analyst, Buyer, Storekeeper, Accounting Analyst, Administrative Support Associate, and other staff as designated by the Incident Commander.

Bear Valley Electric Service, Inc. Emergency & Disaster Response Plan

2.4.4.3. Logistics Group reports directly to the Incident Commander on all logistics issues and coordinates directly with the leaders of the Operations, Planning, Logistics and Finance & Administration Groups to provide optimal logistics support to ensure restoration activities are safe, efficient and effective. Activities associated with Logistics Group include, but are not limited to:

- Group leader attends BVES SEMS leadership meetings.
- Maintain at least one group member at the EOC. EOC presence may be modified to “on call” when logistics work is not significant (for example, during night shift) as approved by the Incident Commander.
- Work closely with Emergency Manager and SOS to forecast contracted services, equipment and material requirements for restoration activities.
- Invoke contracts for response services as requested by the Emergency Manager (for example, emergency line work, snow clearing, tree trimming and clearing, etc.).
- Process emergency contracts and procurement requests as needed to support emergency restoration activities.
- Ensure materials for recovery activities are available, issued to Line Crews as needed, and properly documented when utilized or consumed.
- Ensure vehicle fleet fueled, winterized and ready to support response activities.
- Ensure BVES facilities properly functioning to support EOC and response activities.
- Arrange meals as necessary for staff engaged in response activities.
- Arrange lodging and other mobilization logistics for mutual aid and contracted crews as requested by the Emergency Manager.
- Work collaboratively with other stakeholder organizations and the General Office as applicable on logistics issues.
- Perform other logistics activities as directed by the Incident Commander.
- Develop lists of lessons learned for after action evaluation and improvements to logistics.

2.4.5. Planning Group.

2.4.5.1. The Energy Resources Manager is the primary BVES staff assigned in charge of the Planning Group. Alternates that may be assigned include the Utility Manager, Regulatory Affairs Manager, or others as designated by the Incident Commander.

2.4.5.2. The Planning Group shall normally be made up of the Regulatory Affairs Manager, Utility Manager, Customer Care and Operations Support Supervisor, Accounting Supervisor, Energy Supply Specialist, Energy Analyst, and other staff as designated by the Incident Commander.

2.4.5.3. The Planning Group reports directly to the Incident Commander on all planning issues and coordinates directly with the leaders of the Operations, Logistics and Finance & Administration Groups to provide optimal planning support to ensure restoration activities are safe, efficient and effective. Activities associated with Planning Group include, but are not limited to:

- Group leader attends BVES SEMS leadership meetings.

Bear Valley Electric Service, Inc. Emergency & Disaster Response Plan

- Maintain at least one group member at the EOC. EOC presence may be modified to “on call” when planning work is not significant (for example, during night shift) as approved by the Incident Commander.
- Work closely with Emergency Manager to develop a high level restoration strategy.
- Evaluate the adequacy of response and recommend adjustments as needed.
- Evaluate weather forecasts and other event information to develop contingencies.
- Determine if Catastrophic Emergency Memorandum Account (CEMA) request is appropriate and coordinate with local government officials and Regulatory Affairs on emergency declarations.
- Develop load forecasts and plan sources of energy supply to best meet load demand.
- Work collaboratively with other stakeholder organizations and the General Office as applicable on planning issues.
- Perform other planning activities as directed by the Incident Commander.
- Develop lists of lessons learned for after action evaluation and improvements to plans.

2.4.6. Finance & Administration Group.

2.4.6.1. The Accounting Supervisor is the primary BVES staff assigned in charge of the Finance and Administration Group. Alternate staff may be assigned include the Energy Resource Manager, Senior Account Analyst, or others as designated by the Incident Commander.

2.4.6.2. The Finance & Administration Group shall normally be made up of the Senior Account Analyst, Account Analyst, Administrative Support Associate, and other staff as designated by the Incident Commander.

2.4.6.3. The Finance & Administration Group reports directly to the Incident Commander on all finance and administration issues and coordinates directly with the leaders of the Operations, Logistics and Planning Groups to provide optimal Finance & Administration support to ensure that restoration activities are safe, efficient and effective. Activities associated with Finance & Administration Group include, but are not limited to:

- Group leader attends BVES SEMS leadership meetings.
- Maintain at least one group member at the EOC. EOC presence may be modified to “on call” when planning work is not significant (for example, during night shift) as approved by the Incident Commander.
- Work closely with Operations & Logistics Groups to track expenses (labor, invoices for services, materials consumed, etc.).
- Ensure clear guidance provided to groups to ensure expenses properly tracked.
- Treat each event as possible Catastrophic Event, which costs could be authorized for recovery.
- Execute CUEA administrative requirements as needed.
- Work collaboratively with other stakeholder organizations and the General Office as applicable on finance and administration issues.
- Perform other finance and administrative activities as directed by the Incident Commander.

Bear Valley Electric Service, Inc. Emergency & Disaster Response Plan

- Develop lists of lessons learned for after action evaluation and improvements to finance and administration.

2.5. **Plan Changes.** BVES Incident Commander has the authority to modify this plan including the organizational structure as needed to optimally respond to the specific emergency at hand. Specifically, the Incident Commander, must evaluate each emergency situation and determine:

- To what extent should the BVES Emergency Organization be staffed.
- To what extent should the EOC be activated.
- Should additional resources (for example, mutual aid and/or contracted services) be mobilized.

Bear Valley Electric Service, Inc. Emergency & Disaster Response Plan

3. Emergency Response Event Preparations.

3.1. **Preparations.** Emergency Response preparations are a long-term process for which each BVES Department must be constantly ready, especially during the winter months. Preparations for emergency response are best achieved through training on the EDRP, continuous evaluation of the plan, coordination and outreach with external stakeholders, provisioning emergency response materials and equipment, and establishing mechanisms to rapidly bring emergency response resources to the service area such as mutual aid agreements, contracts, and other partnering agreements.

3.2. **Emergency Response Preparations Checklist.** Appendix B, Emergency Response Preparations Checklist, is designed to assist Managers and Supervisors in short-term emergency response preparations.

3.2.1. The President shall direct the execution of the Emergency Response Preparations Checklist based on available forecasting information. In general, it is easier to stand down from a forecasted storm event that does not materialize than to ramp up in the middle of a major storm event. Therefore, erring on the side of being ready is always the better choice. The President may direct the suspension of the Emergency Response Preparations Checklist if the forecast changes and it is no longer warranted.

3.2.2. The checklist is ideally triggered at the 96-hour point prior to a potential emergency response event such as a major forecasted winter storm. However, staff must be flexible and understand not all emergency response events will be accurately forecasted; hence, the implementation time of this checklist may be significantly less than 96-hours. In the event that major outages occur without warning, it is still useful to go through the Emergency Response Preparations Checklist and complete the preparatory checklist items as applicable.

3.2.3. The checklist is designed to be all-inclusive of plausible emergency response to storm events for the BVES service area such as winter snow storms. Therefore, certain preparatory items may not be applicable for all emergency response events; for example, vehicle snow chains may not be required during a loss of import power supply lines from Southern California Edison (SCE). The Utility Manager may direct that certain items on the checklist need not be executed as applicable. Additionally, the Utility Manager may direct new preparatory items be added to the checklist depending on specific impending conditions. The Utility Manager shall use this checklist as applicable when extreme fire threat weather that could result in PSPS conditions is forecasted. The Utility Manager shall keep the President informed of any changes to the checklist.

3.2.4. During after action reviews for emergency response events as well as the annual Emergency Preparedness and Response Plan drill, the Emergency Response Preparations Checklist should be reviewed for adequacy and updated as applicable.

3.3. **Contingency Operating Procedures.** The Field Operations Supervisor shall develop pre-approved switching orders and operating procedures that would most likely to be used in the more plausible loss of supply and outage scenarios. The Field Operations Linemen, the

Bear Valley Electric Service, Inc. Emergency & Disaster Response Plan

Power Plant Operators, and other applicable BVES Staff should train on these procedures as applicable so that in the event they are needed, the procedures are readily available, approved, and understood by staff. Switching orders and operating procedures should include at a minimum the following:

- BVPP Black Start System Line-up Switching Order.
- BVPP Black Start Engine Startup Procedures (with and without back-up BVPP generator).
- Switching Order to express the Radford SCE Source to Meadow Substation.
- Rolling blackout procedure when only Radford SCE Source and BVPP are available (13.4 MW Capacity Limit).
- Rolling blackout procedure when only BVPP is available (8.4 MW Capacity Limit).
- Load shedding procedures and priorities.
- Proactive de-energization of high risk circuits in the event of extreme fire threat weather.

3.4. Mobile Emergency Generation. The Utility Manager shall ensure that there is a contingency plan to connect mobile emergency generators to the BVES system to provide emergency power. The contingency plan should at a minimum include the following:

- Source at least 5 MWs of mobile emergency generation (may be multiple generators) that may be brought to the BVES service area within 24 hours of being requested. If possible, at least two vendor sources should be identified.
- Identify the fuel requirements and replenishment source(s) for the proposed mobile emergency generation.
- Identify the locations in the BVES system where the mobile emergency generators would be located and connected to the BVES system.
- Identify the connection type and ensure that this is compatible with the sourced mobile emergency generators and the BVES system.
- Identify if any networking is required by the supplier for the mobile emergency generators to operate and, if so, how this shall be accomplished.
- Identify any protection needed and ensure that it is available between the source mobile emergency generators and the BVES system connection points.
- Identify the operating control requirements for the sourced mobile emergency generators (for example, monitoring requirements, startup and shutdown procedures, voltage and load regulation, phase synchronization, operating checks and maintenance, operator labor requirements, etc.) and address how these shall be accomplished (for example, supplier shall operate the mobile emergency generators, etc.).

3.5. Material and Equipment. Obtaining material and equipment is always a challenge given that the BVES service area is remotely located and at approximately 7,000 feet in mountainous terrain with only three points of access. The roads present a significant challenge to large trucks under most conditions and all vehicles in wintery ice and snow conditions. Therefore, it is essential to the success of BVES' emergency response plan that certain minimum levels of materials and equipment be always readily available in the BVES service area.

Bear Valley Electric Service, Inc. Emergency & Disaster Response Plan

3.5.1. The Utility Manager shall provide the Accounting Supervisor a minimum quantity of T&D equipment and materials to maintain at BVES to allow timely repairs to likely T&D system failures (overhead facilities, underground facilities, and substation equipment). Additionally, the Utility Manager should identify other vital spares to sustain BVPP operations.

3.5.2. The Field Operations Supervisor shall provide the Accounting Supervisor the minimum quantities of materials and supplies necessary to safely operate field crews involved in restoration repairs. These supplies should include items such as traffic control markers and signs, caution cones, portable site lighting, caution lighting, yellow CAUTION tape and red DANGER tape, portable safety barriers, personal protective equipment (PPE), winter and foul weather gear, etc.

3.5.3. All Managers and Supervisors shall ensure that their staff that would be assigned to operate in the field have available to them the appropriate PPE, adequate weather protection (cold weather gear, rain gear, sunscreen and head gear, etc.), and equipment to perform their duties as assigned by the EDRP.

3.5.4. The Buyer and Storekeeper under the supervision of the Accounting Supervisor shall ensure the equipment and materials identified above are stocked to the minimum quantities. Additionally, they shall ensure the identified equipment and materials are readily sourced and may be ordered and delivered in short timeframe.

3.6. **Vehicles.** All Managers and Supervisors are responsible for ensuring that the vehicles and trucks assigned to them and their employees are ready to operate safely and as needed during restoration activities under the anticipated weather and terrain challenges of the BVES services area.

3.6.1. The Accounting Supervisor shall develop a minimum list of equipment for all BVES vehicles to operate safely in the anticipated weather and terrain conditions including snow and ice that are reasonably encountered in the BVES service area (for example, snow tires, snow chains, shovel, first aid kit, light, fire extinguisher, etc.).

3.6.2. The Field Operations Supervisor shall develop a list of any additional equipment necessary for all utility trucks (digger and bucket trucks), work trucks (foreman and Dutyman trucks) and other vehicles used by Field Operations employees to operate safely and as needed in the anticipated weather and terrain conditions that are reasonably encountered in the BVES service area.

3.6.3. The Storekeeper under the direction of the Accounting Supervisor shall coordinate with the applicable Managers and Supervisors to ensure all vehicles and trucks are fully equipped, properly serviced, and ready to safely operate as needed in the anticipated weather and terrain conditions that are reasonably encountered in the BVES service area.

3.6.4. If a vehicle is not properly equipped, in good working order, and/or safe to operate for the current or anticipated conditions, it should be identified as such by the applicable Manager or Supervisor that is responsible for the vehicle or truck and restricted in use (for example, if a vehicle is not equipped with snow tires and chains, it should not be used in snow conditions).

Bear Valley Electric Service, Inc. Emergency & Disaster Response Plan

3.7. **Contracts for Services.** During emergency restoration response activities, outside contracted services may be required to ensure efficient and effective restoration of electric service. However, it is extremely difficult to source and contract out services on short notice during an emergency. Therefore, Managers and Supervisors should identify the critical contracted services that may be reasonably expected to be needed for restoration activities, source providers of these services, and establish emergency contract agreements in accordance with the BVES's procurement policy.

3.7.1. **Table 3-1** lists the contracted services that should have pre-arranged emergency contract agreements in place.

Table 3-1: List of Minimum Contingency Contracted Services

Contracted Service	Responsibility	Additional Emergency Requirement
T&D overhead and underground high voltage utility power line construction.	Utility Manager	<ul style="list-style-type: none"> • Must have 24/7 contact. • Onsite within 8 hours.
T&D substation and major electrical equipment troubleshooting, repair and replacement services.	Utility Manager	<ul style="list-style-type: none"> • Must have 24/7 contact. • Onsite within 24 hours.
T&D work package design and development services.	Utility Engineer & Wildfire Mitigation Supervisor	<ul style="list-style-type: none"> • Onsite within 48 hours.
Civil construction for utility underground infrastructure repair and construction, road and sidewalk repair and construction, retaining wall repair and construction, backhoe services, hauling and other civil construction services.	Field Operations Supervisor	<ul style="list-style-type: none"> • Must have 24/7 contact. • Onsite within 8 hours.
Crane and lifting Services.	Field Operations Supervisor	<ul style="list-style-type: none"> • Must have 24/7 contact. • Onsite within 8 hours.
Vegetation clearance from high voltage overhead power lines and tree removal.	Field Operations Supervisor	<ul style="list-style-type: none"> • Must have 24/7 contact. • Onsite within 8 hours.
Airborne inspection, heavy lift and construction services	Utility Manager	<ul style="list-style-type: none"> • Must have 24/7 contact.
Environmental cleanup and mitigation to oil and hazmat spills.	Accounting Supervisor	<ul style="list-style-type: none"> • Must have 24/7 contact. • Onsite within 8 hours.
Welding and metal fabrication services.	Field Operations Supervisor	<ul style="list-style-type: none"> • Must have 24/7 contact. • Onsite within 8 hours.
Snow removal for BVES Main Facility and Stockyard, substations and other areas as directed.	Field Operations Supervisor	<ul style="list-style-type: none"> • Must have 24/7 contact. • Onsite within 4 hours.
Troubleshooting, repair and replacement parts for emergency generators (Main Office and BVPP).	Field Operations Supervisor	<ul style="list-style-type: none"> • Must have 24/7 contact. • Onsite within 12 hours.
Mechanical and electrical troubleshooting, repair services and replacement parts for BVPP equipment and support systems (Waukesha Model VHP7104GSI engine/generator sets).	Field Operations Supervisor	<ul style="list-style-type: none"> • Must have 24/7 contact. • Onsite within 12 hours.
Utility Truck troubleshooting, repair and support services	Field Operations Supervisor	
Vehicle troubleshooting, repair and support services	Storekeeper	
Diagnostic and technical support services for SCADA and associated network systems.	Senior Technical Operations Support Specialist	

Bear Valley Electric Service, Inc. Emergency & Disaster Response Plan

Contracted Service	Responsibility	Additional Emergency Requirement
Diagnostic and technical support services for Outage Management System (OMS) and related applications.	Senior Technical Operations Support Specialist	
Diagnostic and technical support services for Interactive Voice Recording (IVR) and related applications.	Customer Service Supervisor	
Diagnostic and technical support services for BVES's phone system.	Senior Technical Operations Support Specialist	
Diagnostic and technical support services for BVES's internal and external network and connectivity systems.	Senior Technical Operations Support Specialist	
Diagnostic and technical support services for BVES's External Website.	Customer Program Specialist	
Public relations (PR) services	Customer Program Specialist	<ul style="list-style-type: none"> • Must have 24/7 contact. • Provide remote PR response within 2 hours
Media advertising services	Customer Program Specialist	

3.7.2. Many of the services listed in Table 3-1 are used in the normal course of BVES operations through already established contracts. Where this is the case, it is advantageous to include any additional emergency response requirements rather than sourcing to different suppliers.

3.7.3. The Administrative Support Associate in coordination with the Utility Manager and Accounting Supervisor shall develop a list of Contingency Contracted Services and file the list in Appendix C, Contingency Contracted Services. The list shall be in tabular format and at a minimum include the following information:

- Contractor Entity Name
- Services Provided with brief description of any specific emergency requirements
- Point of Contact
- Contact phone numbers including afterhours numbers
- Main Office location

The list shall be reviewed and updated by the Administrative Support Associate each quarter.

3.7.4. Where onsite mobilization is required to perform the requested services, Managers and Supervisors should carefully consider the feasibility for the contractor to reach the BVES service area in a timely manner given the remote and mountainous terrain.

3.7.5. When advanced warning or forecasting is available, the Utility Manager may direct pre-positioning of equipment and materials to improve the ability of the contractor to mobilize. For example, a contractor for T&D overhead and underground high voltage utility power line construction may be requested to pre-position trucks at BVES ahead of a snow storm.

3.7.6. When advanced warning or forecasting is available, it is generally useful for Managers and Supervisors alert their points of contact for contracted services that there may be an impending requirement for their services.

Bear Valley Electric Service, Inc. Emergency & Disaster Response Plan

3.8. **Mutual Aid.** Mutual Aid agreements are an efficient and effective resource multiplier available to BVES restoration efforts. Therefore, it is extremely important that these agreements be maintained current and that staff understand what resources they may provide and how to request the resources.

3.8.1. California Utilities Emergency Association. The California Utilities Emergency Association (CUEA) Mutual Aid Agreement allows member utilities to request and obtain labor, materials, and/or equipment resources from other member utilities in a rapid manner on a reimbursable basis. BVES shall be an active member of CUEA and shall participate in the Energy Committee meetings and activities as feasible. Generally, CUEA meetings and activities provide information on emergency response planning at other utilities and state agencies. Additionally, CUEA is an excellent forum for organizations to discuss best practices. The Utility Manager shall be responsible for managing CUEA mutual aid agreement and shall ensure processes are in place and applicable Operations Staff are trained to:

- Inquire about CUEA resources and make formal mutual aid requests in accordance with the CUEA agreement.
- Provide mobilization support such as lodging and meals to responding mutual aid crews and other labor resources provided through CUEA.
- Direct and manage mutual aid crews and other labor resources provided through CUEA.
- Provide logistics support (materials, equipment and other resources as needed) to mutual aid crews and other labor resources provided through CUEA.

The Administrative Support Associate shall ensure CUEA documents are available to the Operations Group and in the EOC.

The Accounting Supervisor shall ensure processes are in place to account for and pay for CUEA mutual aid resources that respond to BVES' aid requests. This shall require close coordination with the Operations Group.

3.8.2. Mountain Mutual Aid Association. The mission of the Big Bear Valley Mountain Mutual Aid Association ("MMAA") is to coordinate and facilitate resources to minimize the impact of disasters and emergencies on people, property, the environment, and the economy. This is accomplished by detailed valley-wide evacuation planning and dedicated support to all involved emergency responders and their agencies. MMAA's vision is to prepare Big Bear Valley citizens, tourists, businesses, and governments to maximize their resistance to disaster through preparedness, mitigation, response, and recovery activities. BVES shall be an active member of MMAA and shall actively participate in the MMAA meetings and activities. This is especially important in establishing strong personal business relationships with key players and stakeholders in the community such that during an emergency event, the BVES Team is working with stakeholders it is already familiar with. **Table 3-2** provides a listing of the MMAA current membership. The Utility Manager shall be responsible for managing MMAA mutual aid agreement and shall ensure processes are in place and applicable Operations Staff are trained to:

- Coordinate activities with MMAA.
- Request support and resources of MMAA members.

Bear Valley Electric Service, Inc. Emergency & Disaster Response Plan

MMAA has the ability to provide a wide range of direct support to BVES restoration activities during emergency response including traffic controls, road-clearing services, coordination with local government agencies, other utilities, and other nongovernmental organizations, and communications with the public. Additionally, one of the most significant strengths of MMAA is its ability to coordinate through its member organizations support and relief for customers experiencing extended sustained major power outages. This may include health and welfare checks, shelters, meals, cooling centers, restroom and shower stations, etc.

Table 3-2: Bear Valley Mountain Mutual Aid Association Membership

Organization		
<ul style="list-style-type: none"> • City of Big Bear Lake • Big Bear Fire Department • San Bernardino County Fire • San Bernardino County Department of Public Health • San Bernardino County Office of Emergency Services (OES) • San Bernardino County Sheriff's Department • San Bernardino County Transportation Authority • San Bernardino County Emergency Communications Service (ECS) • U.S. Forest Service • California Highway Patrol • California Department of Transportation 	<ul style="list-style-type: none"> • Big Bear Airport • Big Bear City Community Services District • Big Bear Lake Department of Water & Power • Big Bear Lake Municipal Water District • Big Bear Area Regional Water Authority • Bear Valley Electric Service, Inc. • Southwest Gas • Bear Valley Community Healthcare District • Bear Valley Unified School District • Mountain Area Regional Transit Authority 	<ul style="list-style-type: none"> • Bear Mountain Ski Resorts • Big Bear Chamber of Commerce • Big Bear Lake Resort Association • Big Bear Valley Recreation & Park District • American Red Cross • Big Bear Community Emergency Response Team (CERT) • Big Bear Valley Community Organizations Active in Disaster (COAD) • Big Bear Valley Voluntary Organizations Active in Disaster (VOAD) • Civil Air Patrol • Salvation Army

3.9. Communications Layers and Message Deck. Communications with stakeholders and customers during emergency response is one of BVES' top three priorities. The Customer Service Supervisor with the support of the Customer Program Specialist shall ensure the following:

- Multiple layers of communications are established to reach customers. These should include agreements with local media (newspaper, internet news, radio stations, etc.), BVES Website, BVES social media, Interactive Voice Response (IVR) System, email blast, etc.
- Training applicable staff and testing all of the established communications layers.
- Leveraging the communications platforms available to other stakeholder organizations. For example, the Big Bear Chamber of Commerce has an email blast channel to its member businesses and the City of Big Bear Lake has an email blast channel to many of its residents.
- Developing pre-approved message templates that properly guide staff preparing communications to customers and stakeholders with the necessary information to provide a useful update. For example, pre-staged press releases, website messages, social media messages, IVR messages, etc. on sustained outages may be prepared well in advance of any emergency with "fill-in-the-blanks" for the specific event.

Bear Valley Electric Service, Inc. Emergency & Disaster Response Plan

3.10. **Staff Roster and Recall List.** A critical component of successfully implementing the EDRP is the ability to rapidly recall staff as need. Therefore, it is critical that contact information for each staff be maintained up to date and be made available to staff that would execute the recall.

3.10.1. The Administrative Support Associate is responsible for maintaining and updating the BVES Staff Roster and Recall List. This list shall be filed in Appendix D, BVES Staff Roster and Recall List, to the EDRP. This list shall be reviewed for accuracy each quarter by the Administrative Support Associate and updated as needed.

3.10.2. When new staff join or staff terminate their employment at BVES, the Administrative Support Associate shall update BVES Staff Roster and Recall List.

3.10.3. Additionally, when staff change their contact information, it is essential that they inform their Supervisor and the Administrative Support Associate so that the recall roster may be updated.

3.10.4. The recall roster should include at a minimum employee name, home phone, mobile phone, personal email, and address. It is critically important that the roster have a phone number where the employee may be contacted at any time. The address is important because in a major storm it may be safer and more efficient to send a BVES vehicle to pick up staff to respond to the EDRP and staff up the EOC. Personal email is important because an initial group email blast may be sent to set in motion mobilization of the EOC, while calling each staff member is pursued.

3.10.5. The Administrative Support Associate shall develop and update as necessary a group email address for staff using both their personal and work email addresses for recall purposes.

3.11. **Key External Contacts List.** BVES' ability to contact external stakeholders and resource providers is critical to successfully executing EDRP restoration activities.

3.11.1. The Administrative Support Associate in coordination with Managers and Supervisors shall develop the Key External Contacts List and file the list in Appendix E, Key External Contacts List. The list shall be in tabular format and at a minimum include the following information:

- Key External Contact Entity Name
- Point of Contact
- Contact phone numbers including afterhours numbers
- Email
- Main Office location
- Category of Key External Contact per Table 3-3

The list shall be reviewed and updated by the Administrative Support Associate each quarter.

Bear Valley Electric Service, Inc. Emergency & Disaster Response Plan

3.11.2. Managers and Supervisors should provide the Administrative Support Associate updates to the Key External Contacts List as changes occur.

3.11.3. Table 3-3 provides the minimum key external contact categories that should be included in the Key External Contacts List.

Table 3-3: Key External Contacts

Category
• State government, agencies and departments
• Local government, agencies and departments
• Critical Customers
• Public Safety Partners
• Utilities
• Non-governmental organizations (business and community organizations; volunteer relief and aid groups; other disaster relief entities)
• Media groups

3.12. **Emergency Operations Center and BVES Main Facility.** Readiness of the EOC and BVES Main Facility to support EDRP restoration activities on short notice is an essential element to successfully executing the EDRP.

3.12.1. The Utility Manager is responsible for ensuring readiness of the EOC as detailed in Section 2.3. Appendix A, EOC Preparedness Checklist, provides a list of equipment, capabilities, materials and supplies that should be available to the primary EOC. The Operations Group should be familiar with this checklist and be trained on setting up the EOC.

3.12.2. Each Manager and Supervisor is responsible for ensuring that facilities and resources under their responsibility are ready to support the EDRP restoration activities.

3.12.3. The Accounting Supervisor is responsible for ensuring the BVES Main Facility is ready to support sustained EOC and EDRP operations to include stocking consumables for EOC and restoration activities, providing staff on-site meals, water and other necessary habitability amenities.

Bear Valley Electric Service, Inc. Emergency & Disaster Response Plan

4. Emergency Response Procedures.

4.1. **Emergency Response Plan Implementation and Emergency Operations Center Activation.** BVES responds to emergencies and outages based on the resource requirements to properly resolve the situation in a safe, timely, efficient and effective manner. When the restoration efforts are beyond the capabilities of the normally assigned Field Operations staff and normal Customer Service resources, the EDRP should be implemented.

4.1.1. Response Levels. There are three basic outage response levels that BVES uses. Level 1 and 2 pertain to the EDRP and Level 3 refers the normal BVES working hours and afterhours Field Operations and Customer Service outage response procedures and processes. When the EDRP is activated, Level 1 or 2 are used to describe level of EOC activation and restoration response process. Level 3 is the normal Service Crew (or Dutyman for afterhours) response process to outages and system problems during the course of normal T&D operations. The response levels to outages and emergencies are summarized in Table 4-1.

Table 4-1: BVES Outage and Emergency Response Levels

Response	Event Type	Action	Comments
Level 1	High Risk Long-term*	EOC fully activated EDRP processes implemented	It is preferred to fully activate EOC and then shift to Level 2 activation, if full response determined to not be necessary.
Level 2	Moderate Risk Short-term	EOC partially activated EDRP processes implemented	Level of EOC activation and EDRP implementation as directed by Utility Manager.
Level 3	Low Risk Short-term	Normal Service Crew/Dutyman and Customer Service processes	These events are normally within the capability of assigned Service Crew or Dutyman to resolve with the normal on call resources.

*Long-term is generally defined as 12 hours.

4.1.2. Plan Activation. The President shall direct activation of the EDRP and, therefore, the EOC and shall also direct the applicable response Level. The President should consider the following in evaluating whether or not to implement the EDRP and, if the EDRP is to be implemented, to what Level (1 or 2) to activate the EOC:

- Will resources beyond BVES' normal outage response posture be required and to what extent? Will external resources (mutual aid and/or contracted services be required)?
- Will the restoration efforts be long-term (generally 12 hours or greater)? If long-term, how long?
- Will the restoration efforts be more efficient if the BVES staff is organized for around the clock customer service and field operations?
- Will the restoration efforts require increased management and logistics support beyond that of the Field Operations Supervisor?
- Is the outage (or high potential for outage) expected to have significant impact on BVES customers and/or stakeholders?

Bear Valley Electric Service, Inc. Emergency & Disaster Response Plan

- Will rapid and close coordination be required with other government and agencies directing response actions to an emergency (for example, Incident Commander for a wildfire in or adjacent the BVES service area)?
- Will communications efforts require increased and dedicated resources beyond the normal Customer Service communications posture?

4.1.2.1. In considering the above factors, the President shall drive to ensure that the BVES response is at the appropriate level to achieve a safe, timely, and prudent allocation of resources in the best interest of customers and other stakeholders.

4.1.2.2. The EDRP will be directed in response to an extended outage as a result of proactive de-energization (public safety power shutdown) to shut off power in high risk areas when extreme fire conditions present a clear and imminent danger to public safety. The focus of implementing the EDRP in this circumstance would be to improve coordination with local government and agencies and provide affected customers relief resources generally through mutual aid (MMAA) as needed. Specific public safety power shutdown procedures are provided separately in the BVES Public Safety Power Shutdown Plan.

4.1.2.3. The President shall direct activation of the EOC in situations where an outage has not yet occurred but the likelihood is significant. An example of a high risk situation is a wildfire that has not yet resulted in outages but has the potential to do so and/or may require rapid and close coordination with the Fire Incident Commander.

4.1.2.4. It is generally preferred to fully activate EOC and then shift to Level 2 activation as conditions warrant. By bringing in the full EOC organization, the staff can be briefed on the situation and then stood down with specific instructions tailored to the Level 2 response requirements.

4.1.2.5. When the EOC is directed to be activated, the President shall designate staff to utilize Appendix D, BVES Staff Roster and Recall List, to alert employees to staff the EOC. Additionally, a group email should be sent out to staff using their work and personal email address.

4.1.2.6. When the EDRP is implemented for training, such as for the annual drill, the Utility Manager shall put controls in place to prevent drill activities from interfering and/or confusing staff, customers, and stakeholders with real-world BVES operations.

4.2. **Essential Elements of Information (EEI).** EEIs are key information that the Incident Commander and EOC Group Leaders need in order to make timely and informed decisions on emergency response. The EEIs listed in Table 4-2, Essential Elements of Information, are critical to the BVES Emergency Leadership Team's ability to assess the emergency situation and decision making in emergency response. Therefore, obtaining this information and continually updating it must be a priority for all staff assigned to the emergency response efforts.

Table 4-2: Essential Elements of Information

Bear Valley Electric Service, Inc. Emergency & Disaster Response Plan

EEI	Remarks
<p>Potential hazards that impact the safety and health of BVES employees, contracted and mutual assistance personnel, first responders, and the public</p>	<p>Safety is our top priority. Therefore, it is vitally important to identify potential hazards so that resources may be properly allocated to assessing, mitigating and eliminating the hazards.</p>
<p>Updated common operating picture based on indications and sensors, forecasts, and the accumulation of information from the field</p>	<p>Maintaining a common operating picture is a primary function of the EOC staff so that each Group is able to provide a coordinated and collaborative uniform response to the emergency. Additionally, the common operating picture leads to consistent messaging with customers and stakeholders based on the best available information.</p>
<p>Facility and equipment assessments and operational impacts to BVES' business operations</p> <ul style="list-style-type: none"> • Status of Power Delivery Systems <ul style="list-style-type: none"> ○ 34.5 kV sub-transmission system ○ Substations ○ Distribution system • Status of Power Supply (Cause of supply disruptions and estimated time of restoration) <ul style="list-style-type: none"> ○ SCE Supplies from Goldhill ○ SCE Supply from Redlands ○ Bear Valley Power Plant • Status of Communications <ul style="list-style-type: none"> ○ Internet connectivity ○ SCADA network ○ BVES work radios ○ Land line phones ○ Cell phones ○ Internal network connectivity ○ Weather station network ○ BVES Website ○ BVES Social Media • Status of IT Applications <ul style="list-style-type: none"> ○ CC&B ○ IVR/two-way text ○ OMS ○ GIS applications ○ SCADA • Status of facilities, equipment, and materials <ul style="list-style-type: none"> ○ Emergency Operations Center ○ BVES Main Office ○ BVES Yard ○ Work trucks and vehicles ○ Poles, wire, transformers and other material 	<p>Identifying causes of power delivery system (T&D) outages and supply disruptions is essential to determining the proper restoration actions to be taken.</p> <p>Maintaining accurate status as conditions in the field change and restoration activities progress throughout the emergency response is key to ensuring restoration resources are properly allocated and optimized at all times.</p> <p>Developing estimated time of restoration (ETR) is critical information that our customers and stakeholders need in order for them plan their responses and mitigations to the outage. ETRs must be updated as they change.</p> <p>Communications are often the weak link in emergency response. During an emergency some communications may be degraded and alternate systems may be necessary. Therefore, understanding the status of communication systems is critical to ensuring connectivity with field crews, damage assessment teams customers, and stakeholders.</p> <p>Many utility activities rely upon IT systems for rapid and efficient response. These systems are also susceptible to degradation during an emergency and workarounds may be necessary. Therefore, identifying IT problems and/or limitations is vital to directing effective restoration activities.</p> <p>As a result of the emergency or for other reasons, facilities and equipment may be degraded and material availability may be limited. Therefore, knowing the status of facilities, equipment, and materials is essential to developing restoration actions.</p>
<p>Status of contracted and mutual aid assistance requests</p>	<p>Outside line crew assistance, tree trimming services, crane support, snow removal services, civil construction services, and other outside assistance is often critical to successfully executing restoration activities. Therefore, is critical to fully understand:</p> <ul style="list-style-type: none"> • Which entity (or entities) are providing resources? • What specific resources they are providing (equipment and personnel)?

Bear Valley Electric Service, Inc. Emergency & Disaster Response Plan

EEI	Remarks
	<ul style="list-style-type: none"> • How and when will they arrive at BVES's service area? • What logistic support will they require?
Limitations on access and transportation due to flooding, roadway damage, debris, or other closures	Access to BVES's service area under normal circumstances is limited. During an emergency, it is plausible that some or all of the access may be interrupted, which will significantly impact the ability to bring resources to BVES. Additionally, access to certain areas within the service area may be severely impaired due to the emergency. Therefore, it is critical that the EOC Team fully understand access limitations and have backup plans in place.
Interdependencies between BVES, government agencies, other utilities (water, gas, and electric), and critical infrastructure	Outages may have significant impact on government agencies, other utilities (water, gas, and electric), and critical infrastructure; especially, when their backup systems fail. Therefore, the EOC Team must be fully aware of how outages are impacting the area and coordinate a prioritized restoration plan that fully considers the above.
BVES staff supporting other agencies (for example, Incident Commander representative)	Imbedding a BVES representative with the on scene Incident Commander and/or local government EOCs (City or County) has proven to be highly effective in coordinating emergency response actions. The EOC Team must communicate frequently with the imbedded BVES representative to ensure coordinated and uniform emergency response.

4.3. **Restoration Strategy.** Outage events and emergencies are rarely similar in all respects; therefore, this general restoration strategy is constructed to provide the EOC Team with a scalable and flexible restoration strategies that can be employed as required to deal with the unique aspects of each major outage and emergency event.

4.3.1. Restoration Strategy Assumptions. Restoration strategies and guidance in the EDRP assume that the BVES system is in its **normal winter line-up** as follows:

- Bear Valley Power Plant (BVPP) is available for normal full power operations (8.4 MW).
- Goldhill SCE sub-transmission power lines and facilities from Cottonwood (Doble, Cushenberry, Goldhill Switch Station, and Ute 1 & 2) are fully operational and connected to the BVES system at the Shay and Baldwin Auto-Re-closers (34 MW).
- Radford SCE sub-transmission power lines and facilities from Zanja are fully operational and connected to the BVES system at the Radford Auto-Re-closer (5 MW).
- BVES T&D systems are in the normal system line-up.

Therefore, staff must ensure that when implementing guidance provided in the EDRP that they fully understand the current line-up of the BVES system and, if there are deviations to the normal winter line-up, they must properly account for these deviations in their restoration actions. It should be noted that under normal conditions, the Field Operations Supervisor

Bear Valley Electric Service, Inc. Emergency & Disaster Response Plan

controls the system line-up and during EOC activation the system line-up is controlled by the SOS.

4.3.2. Restoration Priorities. The Utility Manager shall direct the specific restoration priorities keeping safety (public and worker) as the top priority. In most cases, based on best available information regarding the situation and available restoration resources, resources shall be dispatched to restore systems to achieve the following restoration priorities:

- **Public safety** in the affected areas;
- **Worker safety** in performing the restoration work;
- **Critical infrastructure** Sheriff's Department, hospital, Fire Department, key City & County facilities, other utility facilities (water, sewage, gas, communications), Airport, Traffic Control, Incident Commander Site, Incident Base Camp, Incident Evacuation Centers, communications (Spectrum and various cell providers), radio stations;
- Major commercial activities critical to **continuity of community services**: gas stations, food stores, supply stores, repair shops, eateries and lodging facilities to support outside first responders (CAL FIRE), as well as financial institutions.
- **Medical Baseline Customers** and **Access and Functional Needs Customers**
- **Number of customers** affected; and
- **Length of time** customers have been without power;

4.3.3. Restoration Progression. In directing restoration efforts to achieve the priorities of Section 4.2.2 above, the Operations Group shall generally find it most efficient to dedicate restoration resources to restoring the following types of facilities in the prescribed order to optimally restore electric service:

- Energy supply sources Southern California Edison (SCE) supply lines, Bear Valley Power Plant (BVPP), etc.
- Sub-transmission circuits (34.5 kV)
- Substations
- Distribution circuits (4 kV)
- Feeders
- Distribution transformers
- Individual customer service lines

Taking into account restoration priorities and progression, Table 4-3 below provides guidance on the restoration priorities for sub-transmission circuits, substations, and distribution circuits. This guidance must be tempered by many factors including the actual cause of the outage(s), available resources, time to conduct repairs, access to repair sites, etc. Therefore, the Utility Manager must have wide discretion when developing the specific restoration priorities and may choose to deviate from the general guidance.

Table 4-3: Restoration Priorities for Sub-Transmission Circuits, Substations, and Distribution Circuits

Bear Valley Electric Service, Inc. Emergency & Disaster Response Plan

Priority	Sub-Transmission Circuit	Substation	Distribution Circuit		Comments
1	Baldwin	Meadow	Garstin		<ul style="list-style-type: none"> • Key critical infrastructure. • Connects BVPP
2	Shay/Radford	Pineknot Village Maltby Division	Interlaken Boulder Harnish Country Club	Georgia Paradise Erwin Lake Castle Glen	<ul style="list-style-type: none"> • Additional critical infrastructure • Major commercial activities & airport • Large number of residential customer.
3	NA	Moonridge Maple Bear City Fawnskin Palomino	Eagle Lagonita Fox Farm Clubview Sunset	Goldmine Holcomb Pioneer Sunrise	<ul style="list-style-type: none"> • Mostly residential customers
4	NA	Bear Mountain Summit Lake	Geronimo Skyline	Lift Pump House	<ul style="list-style-type: none"> • Mostly interruptible customer.

4.3.4. Loss or Significant Reduction of Energy Supply. BVES normally imports all of the supplies necessary to meet customer demand via SCE power lines and augments the supplies using the BVPP when the maximum capacity from the SCE Cottonwood lines are reached. Table 4-4 provides information on BVES system sources of power.

Table 4-4: BVES System Sources of Power

Source	Capacity	Comments
Goldhill: Includes SCE lines and facilities from Cottonwood (Doble, Cushenberry, Goldhill Switch Station, and Ute 1 & 2).	34 MW	Connected to the BVES system at the Shay and Baldwin Auto-Re-closers
Radford: Includes SCE line (Bear Valley) and facilities from Zanja.	5 MW	Connected to the BVES system at the Radford Auto-Re-closer
Power Plant: Includes Bear Valley Power Plant (BVPP) generation equipment and facilities.	8.4 MW	Seven 1.2 MW natural gas fired engines
Net Energy Metering & Distributed Energy Resources	3.3 MW	Distributed throughout system. Limited to day-light production only

Table 4-5 provides guidance on some of the more likely loss of energy supply scenarios to the BVES Service Area. Each of these scenarios assumes a complete loss of the affected power source(s). However, it should be realized that it is also possible that certain power sources may be degraded providing some limited capacity instead of being completely lost. In these cases, the Operations Group should follow the framework provided in Table 4-5 modified to take into account the limited supply capacity of the degraded power source(s).

Table 4-5: Actions for Loss of Supplies

Actions	Loss of all SCE Supplies (Goldhill & Radford)	Loss of SCE Goldhill Supplies	Loss of SCE Radford Supply	Loss of BVPP
Contact and coordinate with SCE.	Call SCE Lugo Substation and SCE Control Center Colton. Obtain system status, actions in progress or scheduled and	Call SCE Lugo Substation. Obtain system status, actions in progress or scheduled and ETR.	Call SCE Control Center Colton. Obtain system status, actions in progress or scheduled and ETR.	NA

Bear Valley Electric Service, Inc. Emergency & Disaster Response Plan

Actions	Loss of all SCE Supplies (Goldhill & Radford)	Loss of SCE Goldhill Supplies	Loss of SCE Radford Supply	Loss of BVPP
	estimated time of restoration (ETR).			
Assess situation	Based on ETR for all or partial energy supplies and demand, take all or some of the actions specified below as appropriate.	Based on ETR for all or partial energy supplies and demand, take all or some of the actions specified below as appropriate.	If situation is long-term, work with interruptible customers to coordinate timing of their loads to reduce or eliminate interruptions.	If situation is long-term, work with interruptible customers to coordinate timing of their loads to reduce or eliminate interruptions.
Activate EOC	Yes – Level 1 Event	Yes – Level 2 Event	No – Level 3 Event	No – Level 3 Event
Switching Operations	Line-up system for BVPP Black Start Procedures	Express Radford to Meadow.	Shift Village Substation to Shay Line	NA
Dispatch BVPP	Execute BVPP Black Start Procedures and Start up Enginators one at a time being careful to not exceed the load capacity.	Start up Enginators one at a time being careful to not exceed the load capacity.	Start up Enginators as needed based on load.	Conduct actions to repair BVPP.
Interrupt interruptible customers	Will be required to meet demand.	Will be required to meet demand.	Possibly required to meet demand. Work with customers to coordinate demand to reduce or eliminate interruptions.	Possibly required to meet demand. Work with customers to coordinate demand to reduce or eliminate interruptions.
Rolling blackout procedures	Will be required to meet demand.	Will be required to meet demand.	Not likely required.	Not likely required.
Contract emergency mobile generation	Consider based on ETR if greater than 24 hours.	Consider based on ETR if greater than 24 hours.	Not likely required.	Not likely required.
Public Engagement	Work with community and stakeholder to reduce non-essential loads. Keep customers and stakeholders informed of ETR and rolling blackouts.	Work with community and stakeholder to reduce non-essential loads. Keep customers and stakeholders informed of ETR and rolling blackouts.	Not likely required.	Not likely required.
Compliance reporting	Conduct CPUC Major Outage Report per GO-166 due to greater than 50% of customers experiencing outage.	Conduct CPUC Major Outage Report per GO-166 due to greater than 50% of customers experiencing outage.	Conduct CPUC Major Outage Report per GO-166 if media coverage expected or occurs.	Not likely required.
Load forecasting	Energy Resources to provide detailed hourly forecasts and make recommendations to support load with BVPP and mobile generation.	Energy Resources to provide detailed hourly forecasts and make recommendations to support load with BVPP and mobile generation.	Energy Resources to provide detailed hourly forecasts and make recommendations to support load without Radford Line.	Energy Resources to provide detailed hourly forecasts and make recommendations to support load without BVPP.

4.3.5. Downed Wire Response. During a major storm, BVES may receive many trouble calls reporting primary and service lines down throughout the service area. Wires down that present an imminent fire or electrocution hazard or are identified as being primary distribution line voltage shall receive top priority. In general, higher priority shall be assigned to calls involving wires blocking state highways or wires down on buildings or vehicles. Personnel investigating downed wire shall determine the wire type (primary, secondary or service conductor) and take actions as directed by the SOS and per Table 4-6, Downed Wire Response.

Table 4-6: Downed Wire Response

Conductor	Action
Primary	

Bear Valley Electric Service, Inc. Emergency & Disaster Response Plan

Conductor	Action
	<ul style="list-style-type: none"> • If a fire has started or the threat of fire is imminent, call 911 and then call the SOS to have the circuit de-energized by the most rapid means possible (this may require dropping the main BVES supply transmission lines remotely). • Warn others to stay clear. • Isolate the area by setting up CAUTION tape and traffic cones and barriers. • Call into the EOC the exact location (address and pole numbers). • If wire is energized, but not a fire threat stay at site until Lineman Crew takes over or the line is de-energized. • Once line is de-energized, area isolated and/or Lineman Crew onsite, proceed to next location as directed by SOS.
Secondary	<ul style="list-style-type: none"> • If a fire has started or the threat of fire is imminent, call 911 and then call the SOS to have the circuit de-energized by the most rapid means possible. • Warn others to stay clear. • Isolate the area by setting up CAUTION tape and traffic cones and barriers. • Call into the EOC the exact location (address and pole numbers). • If wire is energized and located near a school, high pedestrian area, on a main roadway, or near a conductive structure, but not a fire threat stay at site until Lineman Crew takes over or the line is de-energized. • Once line is de-energized or it is determined that the area is low risk and the area isolated and/or Lineman Crew onsite, proceed to next location as directed by SOS.
Service	<ul style="list-style-type: none"> • If a fire has started or the threat of fire is imminent, call 911 and then call the SOS to have the circuit de-energized by the most rapid means possible. • Warn others to stay clear. • Isolate the area by setting up CAUTION tape and traffic cones and barriers. • Call into the EOC the exact location (address and pole numbers). • If wire is energized and located near a school, high pedestrian area, on a main roadway, or near a conductive structure, but not a fire threat stay at site until Lineman Crew takes over or the line is de-energized. • Once line is de-energized or it is determined that the area is low risk and the area isolated and/or Lineman Crew onsite, proceed to next location as directed by SOS. • If the line is disconnected from the pole, it is not necessary to isolate the area. Simply call the situation into the EOC and proceed to next location as directed by SOS.

4.3.6. Sub-Transmission and Distribution (T&D) Casualties. The most common cause of outages for the BVES services area are casualties to T&D facilities resulting in a major outage, multiple outages of varying sizes, and/or some combination thereof. Restoration from these outages is mostly dependent on the available resources, which can quickly be overwhelmed if not properly managed.

4.3.6.1. The Operations Group shall prioritize restoration activities and resource allocation according to the general priorities identified in Section 4.3.2 and shall restore T&D facilities in the order listed in Section 4.3.3 to achieve these priorities. In establishing restoration priorities, public and worker safety is always the top priority.

4.3.6.2. SOS balances efforts to conduct repairs while attempting to restore service to as many customers as possible by isolating the damaged facilities to as close to the damage as feasible with the goal of minimizing the number of customers affected by the outage. The SOS should evaluate the time to isolate the damage and restore service to some customers against the estimated time to repair the damage and restore power to all customers. The most efficient and effective course of action shall depend on the extent of damage, availability of resources to conduct repairs, and availability of resources to perform switching operations.

Bear Valley Electric Service, Inc. Emergency & Disaster Response Plan

4.3.6.3. Once damaged facilities are identified to the Operations Group, the SOS shall have the facilities field checked by the Damage Assessment Team (DAT) or by other competent staff, such as nearby field crews, to determine the extent of required repairs needed as well as the ability to isolate the damage and restore power to as many customers as possible.

4.3.6.4. Based on the results of the field check, the SOS shall:

- Determine the priority to repair the damages;
- Direct switching operations to restore power to as many customers as possible, if feasible;
- Determine the repair work scope (for example, temporary repair such as shoring up damaged facilities or permanent repair per BVES construction standards, etc.);
- Assign Engineering Planning resources as deemed necessary (for example, perform pole loading assessments for pole replacements);
- Schedule Field Crew resources as applicable;
- Direct assigned Field Crew to draw necessary materials and conduct repairs;
- Inform and periodically update the Public Information Group and Emergency Service Representatives so that they may keep customers and stakeholders informed; and
- Close out or cause to be closed out the applicable Field Activity.

4.4. **EOC and Emergency Response Workflows.** The EOC and emergency response workflows are designed to:

- Develop and maintain an accurate common operational picture.
- Continually assess damage and develop optimal restoration response.
- Dispatch resources for emergency restoration activities.
- Manage field activity reports.
- Keep customers and other stakeholders informed.
- Ensure restoration activities are properly resourced.

4.4.1. EOC Setup. The EOC shall be set up in accordance with Appendix A, EOC Preparedness and Setup Checklist. The Strategic Operations Supervisor in consultation with the Emergency Manager shall direct which applications are to be displayed on the available large screens and projector and how the white board shall be utilized. The displays should be optimized to provide EOC staff and decision makers an accurate common operational picture based on the best information available.

4.4.2. EOC Staffing. The following staff shall normally be present or represented as applicable in the EOC:

- Incident Commander
- Public Information Group
- Emergency Manager
- Strategic Operations Supervisor (SOS)
- System Monitor
- Damage Assessment Team (DAT) – when not assigned to the field

Bear Valley Electric Service, Inc. Emergency & Disaster Response Plan

- Emergency Service Representative (ESR) – normally located in the Customer Service area to reduce noise level in EOC
- Engineering Technical Support
- IT Operations Support – normally located in IT spaces
- Logistics Group
- Planning Group
- Finance & Administration Group

4.4.3. Managing Field Activities. The Emergency Manager may find it useful to manage Field Activities by utilizing a spreadsheet to track each Field Activity by recording and sorting the following information:

- Field Activity Number
- Date
- Time
- Location
- Circuit
- Substation
- Status (Unassigned/Crew Assigned/Completed)
- ETR
- Grouping (often multiple Field Activities are resolved when a common fault/damage location is repaired)
- Customer call back
- Comments
- Other information as deemed necessary by the Emergency Manager

4.4.4. Workflows. The EOC shall process incoming damage reports and service request as Field Activities using the workflows shown in Appendix F, Emergency Response Workflows. The emergency response workflows are provided for Level 1 and 2 activations. For reference, the Level 3 (normal service response) is also provided. The Utility Manager may direct deviations to the workflows if it is determined that a more effective and efficient workflow process may be achieved. When conducting after action reviews for emergency response events as well as the annual Emergency Preparedness and Response Plan drill, the Appendix F, Emergency Response Workflows, should be evaluated for possible changes and improvements, and updated if deemed appropriate.

4.4.5. Situation Report. Developing a common operational picture is an important function of the EOC staff in order to ensure decision making is optimal. One essential tool in developing the common operational picture is to periodically update a Situation Report (SITREP). Appendix G provides an example SITREP. The SITREP should be updated by the SOS at least once per shift and more often if conditions are rapidly changing. The SITREP should be displayed in the EOC and sent to the Incident Commander, Public Information Group, EOC Group Leaders, Emergency Service Representatives, and others as deemed appropriate by the Emergency Manager.

Bear Valley Electric Service, Inc. Emergency & Disaster Response Plan

4.4.6. Damage Assessments. The Damage Assessment Team(s) shall be dispatched from the EOC to investigate Field Activities and other damage reports. They shall complete a Damage Assessment form and provide it to the SOS. Appendix H provides a sample Damage Assessment Form. If they have several sites to visit, they may consider taking a picture of the completed form and sending to the EOC. Also, the DAT should take as many pictures needed to identify the damage and allow for the Engineering Team to plan the necessary repair work for the line crews. For example, the DAT should take pictures of any damaged equipment and facilities so that material may be pulled and staged for the line crews. Also, the DAT may make use of tools such as FaceTime to communicate with the EOC and provide the EOC a complete assessment of the damage conditions and the iRestore First Responder app to quickly make a basic report with location and a picture.

4.4.7. Work Orders. The SOS shall direct the use of Work Order jackets for the more complex repairs so that the scope of work performed and material and equipment utilized is properly documented. These Work Order jackets should include one-line diagrams and material sheets as applicable along with specific instructions from Engineering & Planning if warranted. Appendix I provides a sample Work Order Jacket.

4.5. **Resources**. Using best available information, the Utility Manager shall continually assess the following:

- Resources necessary to execute the restoration activities in a safe, effective and efficient manner;
- Available resources in the Service Area;
- Gaps in resource availability to execute the restoration activities in a safe, effective and efficient manner; and
- When resources from outside entities such as CUEA mutual aid and/or contracted resources may be released.

Based on the above assessments, the Utility Manager shall coordinate with the Logistics Group leader to request additional resources as necessary to fill resource gaps and to relinquish resources when no longer required. Possible resources in addition to BVES resources include CUEA mutual assistance, contracted services and Big Bear Valley Mountain Mutual Aid Association.

4.5.1. California Utilities Emergency Association (CUEA). The Utility Manager shall determine if gapped resources are best provided by utilizing the hCUEA Mutual Aid Agreement, which allows member utilities to request and obtain labor, materials, and/or equipment resources from other member utilities in a rapid manner on a reimbursable basis. The specific process for requesting and receiving mutual aid from member utilities is provided in the CUEA Mutual Aid Agreement. Table 4-7, CUEA Mutual Assistance Process, provides a summary of the process for requesting and receiving CUEA mutual assistance.

Table 4-7: CUEA Mutual Assistance Process

Bear Valley Electric Service, Inc. Emergency & Disaster Response Plan

Process Step	Responsibility	Amplifying Comments
Determine if CUEA Mutual Aid <u>may</u> be required	Utility Manager	The Operations Group evaluates if CUEA resources may be required and if there is a possibility, this should be communicated to the Logistics Group.
Issue a "Mutual Assistance Inquiry Only"	Logistics Group Leader	<p>Providing the CUEA Staff with a Mutual Assistance Inquiry Only allows the CUEA to alert member utilities so that they may evaluate which resources are available without incurring costs. This request is best made via email but it may also be made via phone call. The following information should be included in the inquiry:</p> <ul style="list-style-type: none"> • BVES Contact Name • BVES Contact Phone Number • BVES Contact Email • Type of Emergency • Type of Assistance Requested • Desired Date & Time Needed • Additional Details or Comments
Determine that CUEA Mutual Aid <u>is</u> required.	Utility Manager	Obtain Incident Commander's authorization to proceed with CUEA mutual aid request and then, request Logistics Group make arrangements.
Issue a "Mutual Assistance Formal Request"	Logistics Group Leader	<p>Send the CUEA Staff a Mutual Assistance Formal Request with following information:</p> <ul style="list-style-type: none"> • BVES Contact Name • BVES Contact Phone Number • BVES Contact Email • Type of Emergency • Type of Assistance Requested • Desired Date & Time Needed • Additional Details or Comments <p>This request is best made via email but it may also be made via phone call and then followed up by email.</p>
Pre-arrival coordination	Logistics Group Leader	<p>Once a member utility (referred to as "Assisting Party") agrees to provide resources, the Logistics Group shall work with the Assisting Party point of contact to facilitate all logistics arrangements to include mobilization through demobilization. Specifically, the following information should be obtained:</p> <ul style="list-style-type: none"> • Date and estimated time of arrival of the Assisting Party resources • Name and contact information of the Assisting Party's Team leader • Names and contact information of the Assisting Party Team members • How lodging will be handled ¹ • How meals will be handled ²
Mutual Assistance Agreement Letter	Finance & Administration Group Leader	Once the pre-arrival information is verbally agreed upon, the Finance & Administration Group shall draft the Mutual Assistance Agreement Letter, route it to the Utility Manager and Logistics Group Leader for review and to the Incident Commander for approval signature. Appendix G, Mutual Assistance Agreement Letter, provides a sample letter.

Bear Valley Electric Service, Inc. Emergency & Disaster Response Plan

Process Step	Responsibility	Amplifying Comments
Setup Assisting Party in BVES Accounts Payable System	Finance & Administration Group Leader	Coordinate with the Assisting Party to ensure they are able to invoice BVES in accordance with the CUEA Mutual Aid Agreement. Provide the Assisting Party invoicing instructions to ensure timely payments.
Mobilization	Logistics Group Leader	Coordinate with Assisting Party Team Leader and local facilities to ensure lodging is ready and assist in resolving any arrival issues such as providing information on access to Big Bear Lake, chain requirements and any other travel support (such as permission to pass through areas that may be closed to general public).
Arrival Meeting	Utility Manager and Logistic Group Leader	Upon arrival of the Assisting Party, the Utility Manager and Logistic Group Leader shall meet with the Assisting Party Team Leader, introduce key staff, and go over the following: <ul style="list-style-type: none"> • Safety procedures³ • Coordination meetings⁴ • Communications⁵ • Work controls and construction standards⁶ • Material usage⁷ • Situation update⁸
Tour of Facilities	Utility Manager	Following the Arrival Meeting, the Utility Manager shall have a BVES employee provide the Assisting Party with a brief orientation tour of key facilities essential to supporting their work including the following: <ul style="list-style-type: none"> • EOC • Warehouse • Stockyard • Where to park trucks • Material disposal • Hazmat disposal • Other logistics support (for example, where to fuel trucks)
Demobilization and Departure Out Brief	Utility Manager and Logistic Group Leader	Ensure lodging checkout is completed and bills are paid. Copy receipts. Review material used by Assisting Party and resolve any documentation issues. Discuss any lessons learned or areas for improvement to allow the Assisting Party to be more effective in the future.
Compensation	Utility Manager and Accounting Supervisor	Coordinate with Assisting Party to review invoices in accordance with the CUEA Mutual Aid Agreement with all of the supporting documentation. The Utility Manager should be the approving manager for the invoices.

Notes:

¹It is BVES's responsibility to make lodging arrangements; however, an Assisting Party may desire to make lodging arrangements on their own and be reimbursed per the Mutual Aid Agreement.

²It is BVES's responsibility to provide meals; however, an Assisting Party may desire to make meal arrangements on their own and be reimbursed per the Mutual Aid Agreement.

³Review BVES safety procedures to include tailboard policy and documentation, grounding policy, lock-out/tag-out policy, confined space policy and the BVES Accident Prevention Manual.

⁴Agree upon how the Assisting Party shall interact and receive direction on work from the Operations Group. Sometimes it might be efficient for the Assisting Party to have the Team Leader spend time in the EOC with the Operations Group and out in the field with the Assisting Party crews. Other options include having the Crew Forman check-in before and after each shift.

⁵Establish lines of communications with the Assisting Party Team Leader and crews. They may include cell phones and/or BVES provided radios.

⁶Brief the Assisting Party on BVES work controls including how work will be directed and construction standards used by BVES. Ensure Assisting Party understands what they are permitted to do and when they must seek Engineering approval for any deviations.

⁷Brief the Assisting Party on BVES material control and documentation procedures. Also, agree upon how to replenish truck stock.

Bear Valley Electric Service, Inc. Emergency & Disaster Response Plan

Process Step	Responsibility	Amplifying Comments
--------------	----------------	---------------------

⁸Brief the Assisting Party on the current situation, damage assessments and services that the Assisting Party shall be required to perform. This is an excellent opportunity to develop an initial game plan with the Assisting Party.

4.5.2. Contracted Services. Contracted Services as listed in Table 3-1 should be in place such they may be readily requested. The Utility Manager shall determine which contracted services are needed and the specific scope of work and provide this information to the Logistics Group Leader. The Logistics Group Leader shall contact the requested contracts and make the arrangements to receive the services. Appendix C, Contingency Contracted Services, provides contact information for anticipated contract services.

4.5.2.1. The Logistics Group shall work with the contractor(s) to establish the specific estimated time of arrival, mobilization and demobilization support needed, and the onsite contractor supervisor/foreman contact information.

4.5.2.2. Upon arrival of contracted crews, the Utility Manager, Field Operations Supervisor, and Logistic Group Leader shall meet with the contractor supervisor, introduce key staff, and go over the following:

- **Safety procedures:** Review BVES safety procedures to include tailboard policy and documentation, grounding policy, lock-out/tag-out policy, confined space policy and the BVES Accident Prevention Manual.
- **Coordination meetings:** Agree upon how the contractor shall interact and receive direction on work from the Operations Group. Sometimes it might be efficient for the contractor to have the supervisor spend time in the EOC with the Operations Group and out in the field with the contractor crews. Other options include having the Crew Forman check-in before and after each shift.
- **Communications:** Establish lines of communication with the Assisting Party Team Leader and crews. They may include cell phones and/or BVES provided radios.
- **Work controls and construction standards:** Brief the contractor on BVES work controls including how work shall be directed and construction standards used by BVES. Ensure contractor understands what they are permitted to do and when they must seek Engineering approval for any deviations.
- **Material usage:** Brief the Assisting Party on BVES material control and documentation procedures. Also, agree upon how to replenish truck stock.
- **Situation update:** Brief the contractor on the current situation, damage assessments and services that the contractor shall be required to perform. This is an excellent opportunity to develop an initial game plan with the contractor.

4.5.2.3. Following the Arrival Meeting, the Utility Manager shall have a BVES employee provide the contractor with a brief orientation tour of key facilities essential to supporting their work including the following:

- EOC
- Warehouse
- Stockyard
- Where to park trucks

Bear Valley Electric Service, Inc. Emergency & Disaster Response Plan

- Material disposal
- Hazmat disposal
- Other logistics support (for example, where to fuel trucks)

4.5.2.4. Once the Utility Manager releases the contractor from providing further services, an out brief meeting shall be conducted with the contractor supervisor, Utility Manager and the Logistics Group Leader to ensure the following: lodging checkout is completed and bills are paid (if BVES handled mobilization); review material used by contractor and resolve any documentation issues; and discuss any lessons learned or areas for improvement to allow the contractor to be more effective in the future.

4.5.2.5. If a contract is not in place for contracted services that are determined to be necessary for emergency response actions, the Utility Manager may direct, with the President's prior approval, that emergency contracting procedures per the BVES's procurement policy be executed to obtain the required services. Any verbal service requests should be followed up as soon as feasible in writing (normally by email) by the Logistics Group with the applicable contractor. The email should include the scope of work and price. This should then be followed up with the appropriate procurement documents (for example, contract, service purchase order, etc.).

4.5.3. Big Bear Valley Mountain Mutual Aid Association ("MMAA"). While MMAA does not have power line construction and repair resources, they do have access to significant support resources including traffic controls, road clearing services, coordination with local government agencies, other utilities, and other nongovernmental organizations, and communications with the public. Additionally, one of the most significant strengths of MMAA is its ability to coordinate through its member organizations support and relief for customers experiencing extended sustained major power outages. This may include health and welfare checks, shelters, meals, cooling centers, restroom and shower stations, etc. Therefore, when the Utility Manager determines that some of these resources are needed, he/she shall inform the Logistics Group Leader who shall coordinate with MMAA in accordance with the MMAA Agreement to request and obtain the desired resources. Coordination with MMAA supplied resources should include Point of Contact, resource estimated time of arrival, appropriate briefings and facility tours by the Operations Group (use the guidance in Section 4.3.1), and agreement on reimbursement if applicable.

4.6. **Catastrophic Events Memorandum Account (CEMA)**. CEMA is a process to establish an account to allow utilities to recover the incremental costs incurred to repair, restore or replace facilities damaged during a disaster declared by the appropriate federal or state authorities. If a catastrophic event is declared a state of emergency by the state or federal government, then utilities can record costs caused by the event in this memorandum account. It should be noted that the utility cannot record or request recovery of costs incurred before the date the event is declared a state of emergency. By recording these costs, the utilities can later ask for recovery of these costs from the Commission. The CPUC then reviews these costs and approves them as appropriate.

4.6.1. Anytime the EDRP is activated, accurate records of expenses, labor hours, materials and other costs incurred during the recovery from the disaster shall be maintained such that the

Bear Valley Electric Service, Inc. Emergency & Disaster Response Plan

incremental costs of recovery efforts may be documented in the event CEMA is invoked. The Finance and Administration Group shall provide specific guidance to Staff to ensure accurate records are maintained. Note that often a state of emergency is declared after the event and recovery have transpired, so each EDRP activation should be treated as a CEMA event.

4.6.2. The President shall coordinate with the Regulatory Affairs Manager to ensure that after a state of emergency occurs and BVES begins booking costs resulting from the event, that a letter is sent to the CPUC Executive President within 30 days. The letter shall provide not only the details of the disaster but also an estimate of the costs to be incurred. The Finance and Administration Group shall develop the estimate for the letter with input from the Operations Group.

4.6.3. Regulatory Affairs Manager shall request cost recovery of the CEMA in a formal proceeding. The Utility Manager with assistance from Accounting Supervisor shall provide the necessary details to support Regulatory Affairs in the CEMA filing.

4.7. **Evacuation.** In the event public officials declare an evacuation order, for all or parts of the Big Bear Valley area, staff's first priority is to address the immediate needs and safety of themselves and family, and once that is taken care of then each employee has a role to play as follows.

4.7.1. Critical Workers. Certain staff are considered Critical Workers and are issued an Emergency Pass by the San Bernardino County Sheriff's Department. The Emergency Pass is only to be used for BVES work and in accordance with local authority instructions. The Emergency Pass should never be used for personal reasons. BVES Critical Workers are:

- President
- Utility Manager
- Field Operations Supervisor
- Utility Engineer & Wildfire Mitigation Engineer
- Senior Technical Operations Support Specialist
- All Linemen
- Field Inspector
- Substation Technician
- Meter Technician
- Power Plant Operators
- Other staff as designated by the Utility Manager

Every two years the Administrative Support Associate shall request new Emergency Passes for the BVES staff classified as critical workers. Also, when new staff arrive the Administrative Support Associate shall obtain an Emergency Pass for them if they are classified as critical workers.

4.7.2. Evacuation Order. In the event government authorities declare an evacuation order for the Bear Valley area, all staff shall follow the evacuation procedure. For partial evacuation orders, the Utility Manager shall evaluate the extent and impact of the partial evacuation and determine if this procedure should be executed and if modifications to the procedure are

Bear Valley Electric Service, Inc. Emergency & Disaster Response Plan

warranted. For example, an evacuation order for Fawnskin only would likely result in BVES implementing its EDRP and staffing its EOC, the evacuation procedures would likely not need to be executed.

4.7.2.1. Utility Manager shall:

- Direct all non-evacuated staff actions.
- Implement the EDRP.
- Consult the local government Incident Commander (IC) and/or applicable Emergency Operations Center (City of Big Bear Lake or San Bernardino County OES) and determine the desired condition of the distribution system and any support needed.
- Place the distribution system in a safe condition while supporting as practicable the IC's efforts.
- Determine the necessary support staff required to safely operate the system and in consultation with the local government IC where they should be located. If the local government IC determines support staff may safely be located at the BVES Main Office, then that is preferred. If it is not safe to remain at the BVES Main Office, the BVES support staff shall relocate to the Base Camp being utilized by the IC or other designated area as agreed upon by the IC.
- Inform the President of the plan.
- Provide instructions to Critical Workers.
- Release any staff who are no longer needed and direct them to safely evacuate.
- When the evacuation order is lifted, direct restoration activities as needed and the return to normal operations.

4.7.2.2. Staff classified as Critical Workers shall:

- Report to the designated area as directed by the Utility Manager. Support staff relocating to the Base Camp or other designated area shall bring utility trucks and equipment as determined necessary by the Utility Manager.
- Dispatch to perform tasks as directed by the Operations Group. BVES staff dispatched to perform tasks in the evacuated areas shall always perform these tasks in at least pairs and shall conduct a communications and status check with the Operations Group at least hourly.
- BVES Staff representative should be assigned to the IC's Base Camp to coordinate any support needed. BVES Representative assigned to the local government IC Base Camp or an EOC shall be designated by the Utility Manager, knowledgeable of the BVES distribution system, and have direct access to the Utility Manager such that IC and/or EOC requests are not delayed.
- Consideration shall also be given to providing BVES Staff representative to supporting Emergency Operations Center (City of Big Bear Lake or San Bernardino County OES).
- Released critical workers in the affected areas should evacuate in a safe manner off the mountain in a safe and orderly manner following local authority instructions. Report to the General Office in San Dimas, CA or other area as designated by the Energy Resources Manager.

Bear Valley Electric Service, Inc. Emergency & Disaster Response Plan

4.7.2.3. Non Critical Worker Staff in the affected areas should evacuate in a safe manner off the mountain in a safe and orderly manner following local authority instructions. Report to the General Office in San Dimas, CA or other area as designated by the Energy Resources Manager.

4.7.2.4. Energy Resources Manager shall:

- Direct all evacuated staff actions.
- If the General Office is not to be used as the evacuation point, designate a suitable area for evacuated staff to gather.
- Perform an accounting of the whereabouts of all BVES staff. Inform the President.
- Setup remote support EOC and establish the Planning, Logistics, and Finance & Administration Groups with available staff.
- Establish continuous and reliable communication lines with Operations Group remaining in the service area.
- Provide resources as requested by the Operations Group.
- Provide updates to President, Regulatory Affairs, and Senior GSWC Staff.
- Make preparations to obtain utility mutual assistance via the California Utilities Emergency Association (CUEA) and/or contracted Linemen as determined necessary by the Operations Group.
- When the evacuation order is lifted, coordinate with the President and Utility Manager the orderly and safe return of staff to the service area.

4.7.2.5. Customer Supervisor shall:

- Establish remote customer service support.
- Update public information media as applicable (press releases, website and social media updates, IVR messages, etc.).

4.8. **End State.** The Utility Manager shall direct the transition from emergency response operations under this plan (Level 1 or 2) to normal operations (Level 3) when the following conditions are met:

- BVES system is no longer at risk for continued disruptions due to the incident.
- BVES power supplies are have been restored to meet service area load demand and are evaluated as reliable.
- BVES sub-transmission system is restored to meet service area power delivery needs and is evaluated as reliable.
- BVES substations and distribution systems are restored to meet service area power delivery needs and are evaluated as reliable.
- Response crews have been demobilized.
- System issues and problems are within the normal Level 3 response capabilities.
- Long-term customer support has been established as necessary (for example, following a declaration of a state of emergency because a disaster has either resulted in the loss or

Bear Valley Electric Service, Inc. Emergency & Disaster Response Plan

disruption of the delivery or receipt of utility service and/or resulted in the degradation of the quality of utility service) and is capable of being properly managed by the normal supervisory element.

Generally, the transition from Level 1 shall be progressive to Level 2 as emergency response requirements wind down and then to Level 3.

4.9. **After Action Reports.** Once the incident is officially terminated, the Utility Manager shall schedule and conduct formal hot washes/debriefing sessions with applicable staff and have an After Action Report prepared. The After Action Report should include:

- Dates/times of the incident
- Description of the incident
- Level of plan activation and if the EOC was staffed
- Records of public communications that were performed
- List of damages to system
- List of personal deaths, injuries, and other accidents associated with the incident
- List of external (contracted and mutual aid) resources utilized
- Develop incremental cost of emergency response actions
- Lessons learned
- Evaluation on whether or not the plan was properly followed
- Specific improvement actions including assignment of responsibility to complete and due date

A thorough follow-up includes reviewing all plans and procedures, making the necessary revisions from lessons learned, and ensuring distribution to all stakeholders/plan holders.

4.10. **Annual Emergency Response Plan Training and Exercise.**

4.10.1. Annual Training. The Utility Manager shall conduct staff training for designated personnel on the Emergency Response Plan in preparation for emergencies and major outages each year just before the winter storm season; typically, in September or October. The training shall be designed to overcome problems identified in the evaluations of responses to a major outage or exercise and shall reflect relevant changes to the plan.

4.10.2. Annual Exercise. The Utility Manager shall conduct an exercise annually using the procedures set forth in this emergency plan. If the BVES uses the Emergency Response Plan during the twelve-month period in responding to an event or major outage, the annual exercise is not required for that period. However, the Utility Manager should also evaluate whether or not staff would benefit from the exercise regardless of the fact that the Emergency Response Plan was utilized within the previous 12-month period. For example, if a major change to the Outage Management System is installed since the last Emergency Response Plan activation, it would be appropriate to at a minimum exercise that portion of the plan.

4.10.3. Exercise Notice. The Utility Manager shall provide no less than ten days' notice of the annual exercise to appropriate state and local authorities, including the CPUC, state and

Bear Valley Electric Service, Inc. Emergency & Disaster Response Plan

regional offices of the OES or its successor, the California Energy Commission, and emergency offices of the counties in which the exercise is to be performed.

4.10.4. Exercise Evaluation. The response to an exercise or major outage shall be evaluated per Section 4.9. The evaluation shall be provided to Regulatory Affairs Manager so that it may be forwarded to the CPUC as part of the report required by GO-166 Standard 11.

4.10.5. Emergency Response Outreach Training. The Utility Manager shall conduct outreach with the county and city emergency response officials and participate as applicable in other emergency exercises designed to address problems on electric distribution facilities or services, including those emergency exercises of the state and regional offices of the OES or its successor, and county emergency offices.

4.11. **Initial Notification**. The Utility Manager shall ensure that the notifications in accordance with the requirements provided in BVES's Electric Utility Emergency Reporting Policy and Procedures are achieved within the required timeframes.

Bear Valley Electric Service, Inc. Emergency & Disaster Response Plan

5. Emergency Response Communications Plan.

5.1. **Strategy Overview.** Achieving unity of effort provides for the most effective and efficient emergency response. This is best attained through the “4 C’s” of disaster planning:

- Collaboration
- Cooperation
- Coordination
- Communication

The first three hinge upon effective communications. The overall communications strategy is structured so that all stakeholders receive accurate, timely and consistent information, with an overall message for safety of the public, employees and contractors. Communications with local government agencies, customers and other stakeholders are vital to the successful implementation of the EDRP. The plan aims to identify who should be given specific information, when that information should be delivered, and what communication channels shall be used to deliver the information.

During a major outage the Operations Group shall make it a priority to provide the following information to the Public Information Group:

- **Extent of the outage** – using our Outage Management System (OMS) and available field assessment and data, determine how many customers are affected and in which areas
- **Cause of the outage** – provide in broad terms. If unknown, provide status of crews responding to investigate including updating once the power has been restored.
- **Estimated time of restoration (ETR)** – this is the key information customers want to know. If unknown, state so and update as more information becomes available. Don’t let ETRs become stale (for example, if a posted ETR is extended, update the posting with a revised ETR).

The Customer Service Supervisor is responsible for updating and executing the BVES communications plan in support of the EDRP. The Utility Manager is responsible for ensuring that accurate information from the Operations Group flows to staff responsible for executing the communications plan.

Additionally, the Customer Service Supervisor shall maintain “call center metrics” that measure customer access to information on customer service calls and web host availability during an emergency or disaster.

5.2. **Establish Multiple and Effective Communication Channels.** Establishing a multilayered communications plan utilizing many separate communications channels is essential to ensuring that the communications plan shall be effective in reaching targeted audiences under uncertain and severe conditions, as would be expected for major outages and disasters and/or following such events. For example, some customers may lose their landline capability in a power outage but still have cell phone service. Plan resiliency, therefore is dependent on having many overlapping layers of communications.

Bear Valley Electric Service, Inc. Emergency & Disaster Response Plan

5.2.1. Outbound Communications

- BVES website
- BVES social media
- Online meetings/broadcasts
- Interactive Voice Response System
- Press releases to local media
- Press conference
- Phones – landlines, mobile cellular, and satellite lines
- Email
- Two-way text messaging
- Door hangers
- Keeping staff who interact with customers informed with latest message
- Advertising
- Community workshops and presentations
- Mail (for example, flyers, newsletters)
- Bill inserts
- County and City communication systems
- Big Bear Chamber of Commerce email blast
- City email blast
- Bear Valley local government, agencies and utilities Public Information Group

5.2.2. Inbound Communications:

- Interactive Voice Response System
- Call center phone lines
- BVES social media
- Customer service windows
- Bear Valley local government, agencies and utilities Public Information Group
- Phones – landlines, mobile cellular, and satellite lines
- Email
- Text messaging
- Activate internal PSPS list
- Press inquiries
- iRestore Reports

5.2.3. Internal Communications:

- Phones – landlines, mobile cellular, and satellite lines
- Email
- Text messaging
- FaceTime, Skype, Online Meetings, etc.
- Intranet – shared drives, internal applications, and SharePoint
- Radios – VHF

Bear Valley Electric Service, Inc. Emergency & Disaster Response Plan

- Direct reports

5.2.4. There are many developing and evolving communications technologies; therefore, it is essential that staff continually evaluate the above lists and modify as applicable. Changes should be evaluated each time the plan is updated.

5.2.5. Besides having multiple communications channels, there are three other elements that are essential to ensuring an effective communications strategy:

- Testing and exercising the communications channels frequently so that staff are trained on their usage, target audiences and key stakeholders are familiar with them, and technical issues are resolved prior to an actual emergency. Once testing and exercising of communication channels is complete, adjustments will be made based on lessons learned.
- Establishing good business relationships and rapport with target audiences and key stakeholders prior to any emergency.
- Maintaining accurate contact information with key stakeholders per Section 3.11 (Key External Contacts List) of this plan.

5.3. **Conduct Pre-Incident Outreach and Education.** BVES has developed a multi-level approach to community education and outreach related to public awareness of outages, emergencies, and emergency preparedness. An important aspect of managing expectations is to conduct education and outreach with customers and key stakeholders well in advance of any emergency. This allows target audiences the opportunity to be ready and provides them the knowledge of what to expect and how to prepare in the event of an emergency such as an extended outage due to a major winter storm or other natural disaster. *A community that is knowledgeable and ready for emergency events will be a force multiplier in emergency response actions.*

5.3.1. City and County Outreach. The Utility Manager shall coordinate with city and county officials in compliance with Public Utilities (P.U.) Code Section 768.6, which requires the following outreach by BVES:

- In developing and adopting an emergency and disaster preparedness plan, BVES shall invite appropriate representatives of every city and county within the BVES service area to meet with, and provide consultation to BVES.
- BVES shall provide the point of contact designated by the city and county with an opportunity to comment on draft emergency and disaster preparedness plans.
- Every two years, in order to update and improve BVES's emergency and disaster preparedness plan, BVES shall invite appropriate representatives of every city and county within its service area to meet with, and provide consultation to BVES. All recommendations and input will be considered and updated should it be determined to be beneficial for the EDRP. The meeting shall be noticed and shall be conducted in a public setting that allows for the participation of appropriate representatives of counties and cities within the BVES service area. Participating counties and cities shall be provided with the opportunity to provide written and verbal input regarding BVES's emergency and disaster preparedness plan. For purposes of this public meeting, BVES may convene a closed meeting with

Bear Valley Electric Service, Inc. Emergency & Disaster Response Plan

representatives from every city and county within its service area to discuss sensitive security-related information in BVES's emergency and disaster preparedness plan and to solicit comments.

- BVES shall notify the commission of the date, time, and location of the above meeting. BVES shall memorialize the meeting and shall submit its records of the meeting to the commission.
- BVES may comply with the meeting requirement that is ordered by the Public Utilities Code by : i) making a presentation regarding its emergency and disaster preparedness plan at a regularly scheduled public meeting of each disaster council created pursuant to Article 10 (commencing with Section 8610) of Chapter 7 of Division 1 of Title 2 of the Government Code within BVES' service area; or ii) at a regularly scheduled public meeting of the governing body of each city located within the service area.

5.3.2. General Public, Customer and Stakeholder Outreach and Education (before an emergency). Utilizing BVES website, social media, public workshops, meetings with key stakeholders, press releases, advertising, newsletters, bill inserts, two-way text communication, IVR, and other communications channels, the Utility Manager and Customer Service Supervisor shall work to educate, inform and conduct outreach with the general public, customers and stakeholders such as local government and agencies, community groups and other utilities on the following topics:

- Customer power outage readiness preparation, including publishing a customer checklist for outages
- Backup generators and safety training
- Reporting outages
- Reporting wire down events and how to handle the situation
- Public Safety Power Shutoff policies
- Wildfire prevention measures including the vegetation management, covered wire, and distribution system inspection programs
- Operational initiatives that support wildfire prevention efforts such as re-closer and circuit patrol policies
- Outage restoration strategies used by BVES
- Infrastructure projects to improve safety, reliability and mitigate wildfires
- Other topics as deemed appropriate by the Utility Manager and/or Energy Resources Manager

In addition to the above outreach, the Utility Manager shall endeavor to periodically brief key elements of the EDRP at Big Bear Valley Mountain Mutual Aid Association ("MMAA") meetings, Big Bear Joint Utility meetings, Big Bear Fire Department and Sheriff's Department leadership.

The Utility Manager and Customer Service Supervisor shall develop and implement a strategy to periodically brief local government and agencies on BVES' emergency response plan. During these interactions, it is important to establish business relationships with local government and its agencies, other key community stakeholders, and other utilities so that during emergencies the BVES Leadership Team may seamlessly engage these groups. The

Bear Valley Electric Service, Inc. Emergency & Disaster Response Plan

Utility Manager and Customer Service Supervisor shall develop a contact list of the key staff at local government and agencies to notify during emergency events. The contact list should include preferred and back-up means of contact (for example, mobile phone number, email, office phone, etc.). The contact list shall be verified, corrected and updated as necessary at least every six months by the Administrative Support Associate.

The list of local government and agencies and key stakeholders shall include at a minimum the following organizations:

- Local officials (City of Big Bear Lake (CBBL) and San Bernardino County)
- State officials (normally CPUC Energy Division and Safety Enforcement Division)
- San Bernardino County Office of Emergency Services (County OES)
- Big Bear Fire Department
- California Department of Forestry and Fire Protection (CAL FIRE)
- U.S. Forest Service
- San Bernardino County Sheriff's Department Big Bear Lake Patrol Station
- California Highway Patrol (CHP) Arrowhead Area
- California Department of Transportation (Caltrans)
- Big Bear Area Regional Wastewater Agency (BBARWA)
- Big Bear City Community Services District (CSD)
- Big Bear Lake Water Department (DWP)
- Big Bear Municipal Water District (MWD)
- Southwest Gas Corporation
- Bear Valley Community Hospital
- Bear Valley Unified School District
- Big Bear Chamber of Commerce
- Big Bear Airport District
- Big Bear Mountain Resort
- Local communication companies (Spectrum and various cell providers)

5.4. Provide Outreach in Prevalent Languages. United States Census data shows that the top three primary languages used in California are English, Spanish and Chinese (including Cantonese, Mandarin and other Chinese languages). BVES shall communicate its emergency preparedness outreach and response in English, Spanish, Chinese (including Cantonese, Mandarin and other Chinese languages), Tagalog, and Vietnamese. Additionally, BVES has included two indigenous languages (Zapateco and Mixteco) as part of its wildfire mitigation communications.

5.5. Provide Emergency Incident Communications. Utilizing the multiple communications channels discussed earlier, the Public Information Group and Emergency Response Leadership Team shall engage and educate the general public, local government and its agencies, and other key stakeholders to provide notification of outages and emergencies, estimated time to restore service, cause of outage (if known), and periodic updates as appropriate. The following sections provide detail on how these communications shall be conducted.

Bear Valley Electric Service, Inc. Emergency & Disaster Response Plan

5.5.1. Set Expectations and Develop Trust. When an emergency occurs, BVES shall communicate with the general public, customers, local government and its agencies, and key stakeholders as soon as possible to set expectations and address emergency issues. When business operations or households are disrupted by power outages, customers expect to know how long they shall be impacted. Thus, estimated restoration times (ETRs) shall be developed, monitored, adjusted and communicated. Establishing ETRs is a key function of the Operations Group. Regulators and local government officials shall be notified regarding the impact to communities per GO 166 Standard 6. Customer Service Supervisor shall:

- Work with BVES’s public relations contractor subject matter experts (SMEs) to develop consistent and accurate BVES messaging to customers and stakeholders.
- Employ consistent and frequent multi-channel communications to disseminate information that leverage and reinforce one another.
- Brief employees; especially field staff and customer service representatives, on the latest information so that their interactions with the public are consistent with the messaging.
- Coordinate closely with the Operations Group to provide customers and stakeholders system updates including best known restoration times.
- Ensure that all communications are accurate and always factually correct. If incorrect information is inadvertently issued, then it is important that a correction be issued as soon as known and that the error be acknowledged. If information is not certain, then avoid reporting it or qualify it as appropriate. For example, “BVES has received reports of a downed tree on its power lines on Moonridge Road; field crews have been dispatched to validate the report and assess any damage that may have resulted.”
- Strive to be transparent; it is absolutely critical to our credibility and to ensuring that the public, customers and stakeholders have the upmost confidence in our ability to perform our essential public service – providing safe, reliable, and high quality electric service.
- Per GO 166 Standard 6, BVES shall provide an initial notification within one hour of the identification of a major outage or other newsworthy event. BVES shall also notify the Commission and San Bernardino County Warning Center at the Office of Emergency Services of the location, possible cause and expected duration of the outage. The Warning Center at the OES is expected to notify other state and local agencies of the outage. Subsequent contacts between state and local agencies and BVES shall be conducted between personnel identified in advance, as set forth in Standard 4.B (Communications Strategy with Government). From time to time the Commission staff may issue instructions or guidelines regarding reporting.

5.5.2. Notify and Engage Key Stakeholders. Keeping local government and agency officials as well as other key stakeholders informed of emergencies is critical to their ability to operate and support their missions. It is far more advantageous for these officials and key stakeholders to receive information directly from BVES Leadership in a timely manner rather than via the media.

Utilizing the contact list developed during pre-incident engagement, BVES Leadership should notify local government and agencies and other key stakeholders of emergencies and provide them updates as appropriate. Some of this notification may be achieved by sending to the local “Public Information Officer” developed through MMAA group email notifications and status updates.

Bear Valley Electric Service, Inc. Emergency & Disaster Response Plan

5.5.3. Notify Customers and General Public. The Customer Service Supervisor shall develop pre-planned statements with fill-in-the-blank sections for potential outage and emergency events. These pre-planned statements shall be used as deemed appropriate by the Customer Service Supervisor to update customers and the general public as soon as feasible via the following means:

- News releases (newspaper, online news outlets, radio, etc.)
- Website updates
- Social media updates
- IVR messages
- Two-way text communication
- Email notifications to customers
- Other public and customer engagement media (for example, City of Big Bear Lake's email blast)

Specific guidance on developing press releases and statements and engaging the media is provided in the next section. Customer Service Supervisor shall develop pre-planned statements for IVR and text message use. IVR and text messages should be short – about one sentence – and may refer the customer to additional information sources such as our website or social media. For example, “BVES crews are responding to outages on the North Shore and the estimated time to restore power is 2 pm – additional information is available at www.bves.com.”

5.5.4. Media Engagement Procedures. By proactively engaging the media, BVES is able to reach a wide audience in its service area and establish the opportunity to convey the correct narrative and information to the general public. When engaging the media, it should be understood that in general the media are:

- Professionals at what they do – they are normally just doing their job and are experts at interviews.
- Often, they are deadline driven.

Therefore, when working with the media as a BVES spokesperson, staff must be prepared and properly authorized. Any employee speaking to media whether “on the record” or “off the record” automatically becomes a spokesperson for the BVES willingly or unwillingly.

5.5.4.1. Authorized Media Engagement. The Public Information Group is the authorized group to interact with the media and they shall lead all media engagement efforts. They shall work closely with the Operations Group to ensure they have accurate information, develop press releases with the assistance of the BVES's public relations firm, coordinate releases with other organizations such as local government and agencies, and clear press releases with the President prior to releasing them.

It should be recognized that media representatives could reach out to BVES employees at any time; especially, BVES employees (and their contractors) out in the field. Therefore, Managers and Supervisors must ensure their employees are periodically updated with the status of the

Bear Valley Electric Service, Inc. Emergency & Disaster Response Plan

emergency response and train their employees to respond to direct media reporter inquiries as follows:

- At all times act politely and professionally.
- Write down the reporter's name, organization, and phone number.
- Write down any questions the reporter may have.
- It is acceptable for field crews and staff to respond to questions directly pertaining to the conditions or work being performed by them. For example, it is acceptable for field crews to describe how the weather is impacting their immediate restoration work out in the field.
- However, any larger questions, such as estimated time of restoration, other reported outages, availability of resources (manpower and materials), restoration strategy should be written down and the reporter informed that BVES shall get back to them.
- In all cases, the employee approached by the media must inform their Supervisor or Manager as soon as possible of the inquiry and pass along the contact information, questions asked, and any answers provided. This information must be immediately conveyed to the Public Information Group.
- The Public Information Group should follow up as soon as feasible with the reporter even if the employee responded to the questions.

5.5.4.2. *Press Release Content.* The Public Information Group shall develop press releases from pre-planned press release templates as feasible. These are especially useful in the initial stages of an emergency where information is still sparse. They allow for rapid dissemination of initial information of the emergency scope. As the Operations Group obtains more accurate information from Field Crews, the press releases should be updated accordingly. Additionally, they shall consult with BVES's public relations contractor to develop press releases and an engagement strategy tailored to the specific emergency.

Press releases should make the best attempt at addressing the "who, where, why, what, when, and how" to the emergency event. However, do not delay issuing a press release to obtain all of this information. The information can be relayed in press release updates. Ideally, in a large outage, the following information should be released as it is known:

- **(Who/where)** Location of the outage and who is affected – use geographic locations such as areas or streets (for example, "Moonridge Area", "from the Village to the Dam on the South shore of the lake", "from Pine Knot Ave to Paine Rd on the South Shore of Big Bear Lake", etc.). Avoid using circuit and/or substation names to describe the location, since these names have little meaning to the public.
- **(When)** Time outage started and estimated time of restoration (ETR).
- **(Who)** Number of customers without power. Provide the best estimate available and update as it is changed.
- **(Why/what)** Cause of the outage and location of damage/problem. Use simple descriptions that a non-utility audience would understand (for example, "car hit a ground mounted transformer causing sufficient damage to take it out of service," "an 80-foot tree fell from across the street on Pine Knot Ave onto a major overhead power line," "loss of power supply from Goldhill due to fault on Southern California Edison equipment," etc.).

Bear Valley Electric Service, Inc. Emergency & Disaster Response Plan

- **(When)** Whether or not Field Crews are conducting repairs to restore power. If crews are not on site, provide an estimated time of arrival if available.
- **(How)** Actions being taken to restore power (starting BVPP, conducting field switching to alternate sources of power, conducting repairs to damaged equipment, etc.).

Pictures of the damage and field crews conducting repairs are always very useful.

5.5.4.3. Press Release Protocols. The Public Information Group under the leadership of Customer Program Specialist shall be responsible for drafting and issuing press releases from the BVES to the media. Press releases shall be drafted, approved, and released per the protocol shown in Figure 5-1, Press Release Protocol.

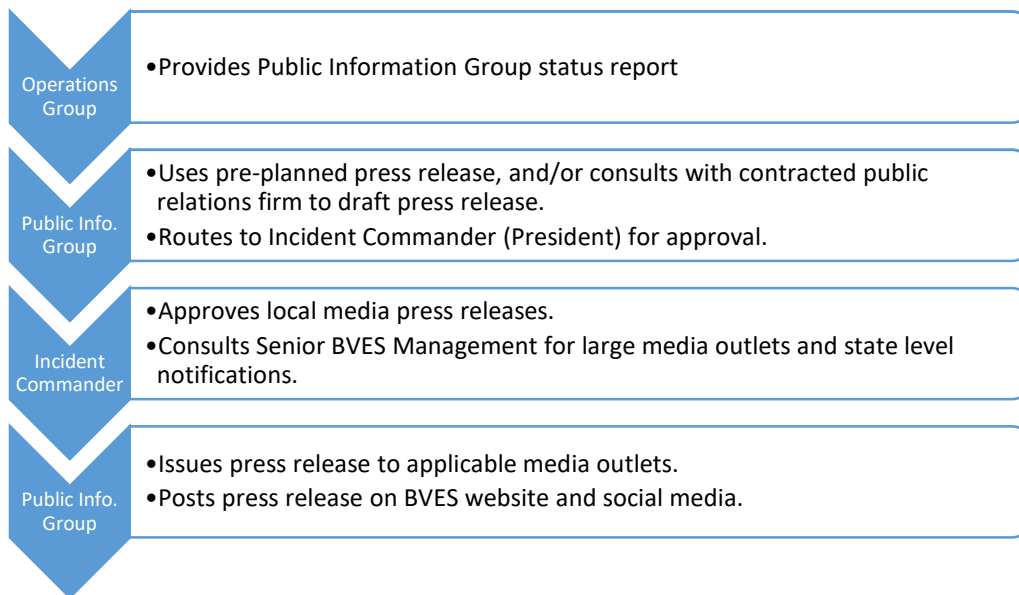

Figure 5-1: Press Release Protocol

5.5.5. Post Emergency Event Close-out Statement. Once the Emergency Response is determined to be no longer necessary, Customer Service Supervisor shall prepare a summary press release and statement providing customers a brief summary of the emergency event and provide any post incident support instructions such as:

- Information on whom to contact at BVES to reconnect service for customers whose weather head or other equipment was damaged preventing immediate service restoration.
- Information on obtaining post incident customer support per Section 6 of this plan.

5.6. **Reports to the Commission.** The Utility Manager shall ensure required reports to the Commission and its Divisions are made in a timely and complete manner. These reports include:

- Notify California Public Utilities Commission (CPUC) and Warning Center at the Office of Emergency Services San Bernardino within one hour of an outage if the outage meets the major outage criteria of GO-166.

**Bear Valley Electric Service, Inc.
Emergency & Disaster Response Plan**

- Notify President Safety Enforcement Division (SED), CPUC within twelve hours of the power being shut-off per ESRB-8.
- Provide a report (written) to President of SED no later than 10 business days after the shut-off event ends per ESRB-8.

Bear Valley Electric Service, Inc. Emergency & Disaster Response Plan

6. **Customer Support in Emergencies.** In the event the Governor of California declares a state of emergency because a disaster has either resulted in the loss or disruption of the delivery or receipt of utility service and/or resulted in the degradation of the quality of utility service, BVES shall implement certain customer service actions as described below. This section provides an overview of the protocols for compliance with requirements adopted by the CPUC regarding activities to support customers. The protocols span customer billing, support for low income, life support, Access and Functional Needs (AFN) customers, and other forms of customer support.

6.1. **Support for Low Income, Life Support and AFN customers.** The Customer Care Team shall freeze low income, life support, and AFN customer accounts and stop all California Alternative Rates for Energy (CARE) High-Usage tracking. The Supervisor shall work with implementation contractors and emergency assistance programs to update affected customers on eligibility requirements and enroll them in assistance programs.

6.2. **Billing Adjustments.** The Customer Care Team shall freeze accounts and stop billing during the disaster event to ensure bills are not estimated or generated for affected customers. Billing shall resume once the case is closed by the Customer Care & Billing (CC&B) technical team, upon notice from the Supervisor.

6.3. **Deposit Waivers.** The Customer Care Team shall add a designated customer contact for all affected customers. The contact shall reside within CC&B for up to one year from the date the emergency ends. This shall allow BVES to easily track the customer's account, so when service is re-established, the utility shall know to waive any associated fees and to expedite customer re-connection.

6.4. **Extended Payment Plans.** The Customer Care Team shall freeze all payments on affected customers' account to avoid affecting their credit. All affected customers shall be notified that an extended payment plan option is available for any past due payments.

6.5. **Suspension of Disconnection and Nonpayment Fees.** The Customer Care Team shall freeze affected customer accounts, so disconnections and nonpayment fees are not generated during the disaster event. Once the emergency ends, the Supervisor and/or Specialist shall contact the CC&B Team to "close" all affected customer cases. This shall automatically transition the customer's account back to the normal state. BVES shall simultaneously begin assisting with service restoration and deposit waivers.

6.6. **Repair Processing and Time.** During emergencies, BVES shall set up specialized repair teams to expedite repair processing. If additional support is needed, BVES shall leverage mutual aid programs with other emergency response resources and shall work with electrical contractors to ensure timely service restoration. Exact timing shall be dependent on the nature of the situation.

6.7. **Access to Utility Representatives.** The BVES Engineering Technician shall arrange for connections and facilitate expedited services. Leveraging its IVR system, BVES shall be able to handle thousands of phone calls simultaneously and divert customers to the appropriate utility representative.

**Bear Valley Electric Service, Inc.
Emergency & Disaster Response Plan**

6.8. **Access to Outage Reporting and Emergency Communications.** During emergencies, BVES shall invoke its emergency communications plan per the EDRP to attempt to reach as many customers as feasible with outage, restoration and recovery information via multilayered communications channels and multiple languages per Section 5.4 of the EDRP.

Appendix G.

Bear Valley Electric Service, Inc. Vegetation Management and Vegetation QA/QC Programs

October 6, 2021

Approved by: Paul Marconi,
President BVES, Inc.
Paul Marconi, President, Treasurer, & Secretary

Digitally signed by Paul
Marconi, President BVES, Inc.
Date: 2021.10.06 07:12:42
07:00'

Bear Valley Electric Service, Inc.
Vegetation Management and Vegetation QA/QC Programs

1. Purpose: Provide requirements for the Vegetation Management (VM) program and VM quality assurance (QA)/quality control (QC) program at Bear Valley Electric Service, Inc. (BVES).

2. Background: Proper clearance of vegetation around high voltage power lines is essential to public safety and ensuring the transmission and distribution (T&D) system is reliable. BVES has established vegetation clearance standards to achieve safe and reliable T&D operations, which are described in Section 3. Efficient, effective, and sustained implementation of the standards is the objective of the VM program described in Section 4. Violation of BVES's vegetation clearance standards significantly increases the risk of ignitions and; therefore, utility caused wildfires when combined with dry weather conditions and high winds. Additionally, such violations increase the probability of vegetation caused outages.

BVES utilizes contractors to provide vegetation clearance services to maintain clearance standards. Ensuring that vegetation clearance operations are actually being performed to the desired standards is an essential element of mitigating the risk of ignition and outages. Therefore, BVES established a VM QA/QC program. The VM QA program is focused on providing confidence that quality requirements will be fulfilled. The VM QC program requires that certain designated BVES Staff perform VM QC checks on a frequent basis. The results of the VM QA/QC programs are essential to alerting BVES to the state of its VM program, which is a critical element for public safety. Section 5 provides guidance on the VM QA/QC program. Having assurance that vegetation clearance efforts are meeting our standards is essential to ensuring public safety from utility caused wildfires. It is critical that if there are problems in vegetation clearance, that BVES is aware of the problems and is able to then dedicate the proper resources toward vegetation clearance efforts to make it effective and resolve any problem areas.

Effective vegetation management requires specialized subject matter expertise; therefore, BVES at times may engage forester consulting services. Some of the duties that may be assigned to the forester include: inspections, auditing, customer contacts and issue resolution, work plans development, specialized projects, contractor safety observations, and vegetation management program documentation and data analysis.

3. Vegetation Clearance Standards: California Public Utilities Commission (CPUC) General Order 95 (GO-95), Rules for Overhead Electric Line Construction, Rule 35 Vegetation Management and Appendix E Guidelines to Rule 35 (trimming guidelines) provides minimum vegetation clearance standards applicable to BVES's T&D system.

3.1. For reference, BVES' Service Area is entirely within a "High Fire-Threat District" with areas classified as Zone 1 and Tiers 2 and 3 per Rule 21.1 of GO-95. Based upon GO-95 requirements (48 inches minimum radial clearance) and on the local climate, likelihood of icing conditions, tree limbs and branches subject to weakening due to high winds and snow weight, elevation, local conditions and access to vegetation for trimming, and species growth rates and characteristics, **the minimum allowable radial clearance of bare line conductors from vegetation is 72 inches** in the BVES service area.

Bear Valley Electric Service, Inc.
Vegetation Management and Vegetation QA/QC Programs

3.2. BVES has established the following requirements to safe clearance along bare line conductors is maintained throughout the BVES service area during the entire length of the vegetation management program cycle:

- **Radial Clearances:** Vegetation that is within the minimum 72-inch safe clearance distance will be trimmed to at least 12 feet in accordance with Appendix E Guidelines to Rule 35 of GO-95. Taking into account vegetation species and growth rates and characteristics, BVES's contractor will trim beyond 12 feet if necessary to ensure that the vegetation remains outside the minimum 72-inch safe clearance distance for the entire length of the vegetation management program cycle (3-years).
 - Vegetation that is outside the minimum 72-inch safe clearance distance but is expected, taking into account vegetation species and growth rates and characteristics, to encroach the 72-inch safe clearance distance prior to the next scheduled preventative vegetation management visit (normally 3 years) will be trimmed to at least 12 feet in accordance with Appendix E Guidelines to Rule 35 of GO-95. Taking into account vegetation species and growth rates and characteristics, BVES's contractor will trim beyond 12 feet if necessary to ensure that the vegetation remains outside the minimum 72-inch safe clearance distance for the entire length of the vegetation management program cycle (3-years).
 - Anytime it is determined that trimming of vegetation is necessary, BVES's contractor shall trim to least 12 feet in accordance with Appendix E Guidelines to Rule 35 of GO-95. Taking into account vegetation species and growth rates and characteristics, BVES's contractor will trim beyond 12 feet if necessary to ensure that the vegetation remains outside the minimum 72-inch safe clearance distance for the entire length of the vegetation management program cycle (3-years).
 - In so far as possible, trimming shall be designed to achieve the appropriate clearance from the power lines without damaging the structural integrity or health of the tree(s).
- **Blue Sky Requirement:** No vertical coverage shall be allowed above BVES sub-transmission lines (34.5 kV).
- **Fast Growing Trees:** All fast growing trees, (poplar, aspen, cottonwood...) will be trimmed to at least 12 feet and removal will be considered. BVES's contractor may determine that additional clearance would be prudent based on growth factors, wind, ice, etc.
- **Drip Line:** All vegetation within the drip line of primary conductors that has the potential of growing into the secondary system or within 12 feet of the energized primary conductors within the 3-year vegetation management program cycle will be removed.
- **Tree Trunk and Major Limb Exception:** Per Section 3.3 below and Appendix A, Trees and Major Limbs in Close Proximity to Bare Conductors, flow chart.
- **Tree Removal:** Trees that are dead, rotten or diseased or dead, rotten or diseased portions of otherwise healthy trees which overhang or lean toward and may fall into a span of power

Bear Valley Electric Service, Inc.
Vegetation Management and Vegetation QA/QC Programs

lines, said trees or portions thereof should be removed. Note that this may apply to trees outside the clearance zone (for example, a dead tree across the street may pose a danger to BVES power lines).

- **Base of Poles/Structures:** For poles or structures that have non-exempt equipment per CALFIRE requirements, all flammable material and vegetation in a 10-foot radius around the base of the pole or structure shall be cut down and removed during each normal vegetation management cycle clearance visit. Exceptions per the effective California Power Line Fire Prevention Field Guide are authorized.
- **Right of Way:** All brush, limbs and foliage in the right of way (ROW) shall be cut up to 8-feet above the ground. All dead, dying, diseased or dried vegetation from 8 feet above the ground to the top of the power lines must be cut down during each normal vegetation management cycle clearance visit. This requirement is applicable to all ROWs in the HFTD Tier 3 and to all ROWs in the HFTD Tier 2 designated as having high strike potential by the Wildfire Mitigation & Safety Engineer. Exceptions per the effective California Power Line Fire Prevention Field Guide are authorized.

3.3. **Tree Trunk and Major Limb Exception.** Appendix A, Trees and Major Limbs in Close Proximity to Bare Conductors, provides the information in this section in flowchart format. If a mature tree whose trunk or major limb is within 48 inches of bare conductors, take the following action:

3.3.1. If the tree or major limb is within 12 inches of the bare conductors regardless of thickness at conductor level, this is a Level 1 discrepancy and shall be immediately remediated by:

- Removing the tree or limb immediately, or
- Installing a tree guard on the line to prevent the tree or limb from contacting the bare conductors and designating the discrepancy as a Level 2 discrepancy to be corrected by removing the tree within 6 months.

3.3.2. If the tree or major limb is less than 6 inches thick at conductor level, then the tree or major limb must be trimmed or removed to achieve 72 inches clearance from bare conductors as follows:

3.3.2.1. If there are no burn marks or evidence of the tree or limb making contact with bare conductors and the clearance is greater than 48 inches, then this is a Level 2 discrepancy and shall be corrected within 12 months.

3.3.2.2. If there are no burn marks or evidence of the tree or limb making contact with bare conductors and the clearance is less than 48 inches but greater than 18 inches, then this is a Level 2 discrepancy and shall be corrected within 180 days. A tree guard should be installed as soon as operationally possible.

Bear Valley Electric Service, Inc.
Vegetation Management and Vegetation QA/QC Programs

3.3.2.3. If there are burn marks or evidence of the tree or limb making contact with bare conductors and/or the clearance is less than 18 inches, then this is a Level 1 discrepancy and shall be immediately remediated by:

- Removing the tree or limb immediately, or
- Installing a tree guard on the line to prevent the tree or limb from contacting the bare conductors and designating the discrepancy as a Level 2 discrepancy to be corrected by removing the tree within 6 months.

3.3.3. If the tree or major limb is greater than 6 inches thick at conductor level and greater than 12 inches from bare conductors, then the tree or major limb shall be evaluated to determine if an exemption per GO-95 Rule 35 may be applied. Take the following action:

3.3.3.1. If there are burn marks present on the tree or major limb or evidence of the tree or limb making contact with the bare conductor, this is a Level 1 discrepancy and shall be immediately remediated by:

- Removing the tree or major limb immediately, or
- Installing a tree guard on the line to prevent the tree or limb from contacting the bare conductors and designating the discrepancy as a Level 2 discrepancy to be corrected by removing the tree within 6 months.

3.3.3.2. If there are no burn marks present on the tree or major limb and no evidence of the tree or limb making contact with the bare conductor, then the tree or major limb may be exempted provided the following:

- Tree has been established in its current location for at least 10 years.
- Tree trunk has a diameter at breast height (DBH) of at least 10”.
- Tree or limb at the conductor level is at least 6” in diameter.
- Tree is not re-sprouting at conductor level during the time of inspection.
- Tree is healthy and not otherwise hazardous.
- Tree is not easily climbable. Note the tree clearance crew can remove branches to render a tree not easily climbable.

3.3.3.3. If the tree cannot satisfy one or more of the above criteria (Section 3.3.3.2), then the tree or major limb must be removed. It should be designated as a Level 2 discrepancy and shall be corrected within 12 months.

3.3.3.4. If the tree satisfies all of the above criteria (Section 3.3.3.2), then the tree may be exempted and remain in place. The tree shall be:

- Documented on Major Woody Stem Form and approved by the Wildfire Mitigation & Reliability Engineer.
- Tracked in the Company’s GIS applications for vegetation management.

Bear Valley Electric Service, Inc.
Vegetation Management and Vegetation QA/QC Programs

- Re-evaluated each year.
- As a precaution, install a tree guard when operationally feasible.

4. Vegetation Management Program: The VM program is designed to ensure the standards described in Section 3 are achieved and sustained throughout the BVES service area.

4.1. Wildfire Mitigation & Reliability Engineer. The VM program shall be the responsibility of the Wildfire Mitigation & Reliability Engineer. Specifically, the Wildfire Mitigation & Reliability Engineer shall:

4.1.1. Establish and ensure BVES's vegetation clearance standards (Section 3) comply with state law, CPUC regulations and other higher authority requirements and achieve the desired public safety and reliability goals of the program given the local environmental conditions of the BVES service area.

4.1.2. Recommend to the President any changes to the BVES vegetation clearance standards (Section 3) that may be required due to:

- Changes in the law, CPUC regulations, other higher authority requirements, and
- Changes in the local service area environment (for example, extended draught conditions, tree pest infestations, etc.) that may warrant a change in clearance standards.

4.1.3. Ensure BVES applies sufficient resources to maintain the BVES vegetation clearance standards (Section 3) throughout the service area.

4.1.4. Recommend to the Utility Manager changes to vegetation management resources as appropriate to maintain compliance with the BVES vegetation clearance standards (Section 3).

4.1.5. Manage all aspects of vegetation management contracts in accordance with BVES's procurement policy. This shall include drafting requests for proposals (RFPs) as applicable, assisting in selecting contractors via the BVES bidding process, reviewing and approving invoices for the Utility Manager or President approval as applicable.

4.1.6. Perform the duties of the BVES Authorized Representative for vegetation management contracts and ensure the contractor is performing in accordance with the contract requirements.

4.1.7. Ensure contractor employees conducting vegetation clearance work are properly trained and certified as required by state law.

4.1.8. Coordinate with contractors and Field Operations to cover power lines or de-energize lines as needed.

4.1.9. Inform Field Operations Supervisor and Customer Program Specialist where vegetation clearance operations will be conducted each week.

4.1.10. Work with the Customer Program Specialist to generate or update customer outreach to educate customers on vegetation management efforts in the BVES service area.

4.1.11. Work with the Customer Service Supervisor or applicable Customer Service staff to resolve customer inquiries or disputes involving vegetation clearance efforts.

Bear Valley Electric Service, Inc.
Vegetation Management and Vegetation QA/QC Programs

- 4.1.12. Coordinate with the City of Big Bear Lake, County of San Bernardino, U.S. Forest Service, CALFIRE, Big Bear Fire Department, and other applicable stakeholders in the area of vegetation clearance efforts.
- 4.1.13. Coordinate with the City of Big Bear Lake, County of San Bernardino, U.S. Forest Service, CALFIRE, Big Bear Fire Department, and other applicable stakeholders in the area of fuels management efforts by the community.
- 4.1.14. Manage all aspects of the VM QA/QC program as described in Section 5.
- 4.1.15. Work closely with the GIS Specialist and contractors to ensure the vegetation clearance efforts are properly documented in the GIS and associated applications.
- 4.1.16. Work closely with the GIS Specialist to develop overlays to support presentations and documents regarding the vegetation management program.
- 4.1.17. Manage and provide oversight of the Third Party Patrols, LiDAR Surveys, Fly-over UAV Surveys, etc., while working closely with the Field Inspector to ensure line inspection programs such as GO-165 Detailed Inspections and GO-165 Patrols are being conducted in compliance with CPUC regulations and BVES requirements and vegetation clearance discrepancies are being identified by the inspections.
- 4.1.18. Manage and provide oversight of the Forester's work activities when assigned. Some of the duties that may be assigned to the Forester include: inspections, auditing, customer contacts and issue resolution, work plans development, specialized projects, contractor safety observations, and vegetation management program documentation and data analysis.
- 4.1.19. Issues or causes to be issued vegetation orders to the contractor.
- 4.1.20. Review the results of line inspection programs such as GO-165 Detailed Inspections, GO-165 Patrols, Third Party Patrols, LiDAR Surveys, Fly-over UAV Surveys, etc. and ensuring any vegetation discrepancies are tracked and resolved. This is normally done by issuing or causing to be issued vegetation orders to the contractor.
- 4.1.21. Discrepancies of a significant safety nature that would be classified as Level 1 per GO-95 Rule 18 should be resolved immediately by notifying the Field Operations Supervisor or Field Inspector who will send the appropriate crew to resolve the issue in an expedient manner. If unable to reach the Field Operations Supervisor or Field Inspector, then notify the Service Crew or Dutyman to resolve the issue.

Examples of Level 1 vegetation discrepancies are vegetation contacting, nearly contacting or arcing to high voltage conductor, vegetation contacting low voltage conductor and compromising structure, etc.

4.1.21.1. Other vegetation discrepancies of an urgent nature (Level 2) but do not rise to the Level 1 classification should be assigned to the contractor as a vegetation order with requirement to resolve within 30-days. Examples of Level 2 vegetation discrepancies are vegetation within 48 inches of high voltage lines, vegetation causing strain or abrasion on low voltage conductor, tree or portions of tree that are dead, rotten or diseased that may fall into power lines, etc.

4.1.21.2. Non-urgent vegetation discrepancies should be tracked as Level 3 discrepancies and resolved by the contractor during the normal vegetation cycle.

Bear Valley Electric Service, Inc.
Vegetation Management and Vegetation QA/QC Programs

4.1.22. Support the preparation of regulatory reports, General Rate Case testimony, Wildfire Mitigation Plan updates, Data Requests and other regulatory requests regarding vegetation management issues.

4.1.23. Support CPUC audits, Office Infrastructure Safety (OEIS) site visits, and other authorized agency reviews of vegetation management.

4.2. Utility Manager. Provides oversight of the VM and VM QA/QC programs. Specifically:

4.2.1. Reviews reports and directs changes to the program as deemed necessary. Keeps the President informed of such changes.

4.2.2. Ensures the VM program is properly resourced. Prepares annual O&M budget for vegetation management efforts.

4.2.3. Responsible for ensuring vegetation contracts are in place and managed per the BVES procurement policy.

4.2.4. Responsible for preparing regulatory reports, General Rate Case testimony, Wildfire Mitigation Plan updates, Data Requests responses and other regulatory requests regarding vegetation management issues. These should all be forwarded to the Regulatory Affairs Manager and the President prior to issuing.

4.2.5. Provides oversight of the VM QA/QC programs described in Section 5.

4.2.6. Responsible for supporting CPUC audits, OEIS site visits, and other authorized agency reviews of vegetation management.

4.3. Utility Engineer & Wildfire Mitigation Supervisor. Provides oversight of the Wildfire Mitigation & Reliability Engineer in managing the VM and VM QA/QC programs. Specifically:

4.3.1. Responsible for ensuring VM QA annual audit and quarterly vegetation management assessments are timely, complete, and accurate in accordance with Section 5.

4.3.2. Responsible for ensuring the Wildfire Mitigation & Reliability Engineer has adequate tools and staff support (GIS, Administrative, etc.) to properly manage the VM and VM QA/QC programs.

4.3.3. Responsible for reviewing vegetation requirements and ensuring the VM program is in compliance with requirements.

4.3.4. Responsible for ensuring VM program is executed per this procedure and BVES's current Wildfire Mitigation Plan.

4.3.5. Responsible for CPUC audits, OEIS site visits, and other authorized agency reviews of vegetation management. Coordinates closely with the Field Operations Supervisor on these matters and all communications with regulatory agencies through the Utility Manager and President.

4.4. Field Operations Supervisor. Provides support to the Wildfire Mitigation & Reliability Engineer in managing the VM and VM QA/QC programs. Specifically:

4.4.1. Provides support as needed to de-energize or cover lines as applicable and provides assistance in resolving vegetation discrepancies.

Bear Valley Electric Service, Inc.
Vegetation Management and Vegetation QA/QC Programs

4.4.2. Closely supports the Utility Engineer & Wildfire Mitigation Supervisor on CPUC audits, OIES site visits, and other authorized agency reviews of vegetation management.

4.4.3. Ensures Field Inspector works closely with the Wildfire Mitigation & Reliability Engineer to achieve VM program requirements.

4.5. Field Inspector. Supports the Wildfire Mitigation & Reliability Engineer in the area of line inspections with regard to identifying, documenting, and tracking vegetation clearance discrepancies. Specifically:

4.5.1. Assists the Wildfire Mitigation & Safety Engineer to achieve VM program requirements.

4.5.2. Assists in ensuring line inspection programs such as GO-165 Detailed Inspections, GO-165 Patrols, Third Party Patrols, LiDAR Surveys, Fly-over UAV Surveys, etc. are being conducted in compliance with CPUC regulations and BVES requirements and vegetation clearance discrepancies are being identified by the inspections.

4.5.3. Assists in reviewing the results of line inspection programs such as GO-165 Detailed Inspections, GO-165 Patrols, Third Party Patrols, LiDAR Surveys, Fly-over UAV Surveys, etc. and ensuring any vegetation discrepancies are tracked and resolved.

4.5.4. Assists in issuing or causing to be issued vegetation orders to the contractor.

4.5.5. Works closely in supporting CPUC audits, OEIS site visits, and other authorized agency reviews of vegetation management.

4.6. GIS Specialist. Supports the Wildfire Mitigation & Reliability Engineer in tracking vegetation clearance efforts and discrepancy management with the GIS and associated applications. Specifically:

4.6.1. Supports data entry and migration of contracted vegetation services and inspection programs into the GIS and associated applications.

4.6.2. Assists in scope of work development for RFPs regarding vegetation management service and inspection programs to ensure data and documentation requirements that are compatible with BVES GIS applications are accurately provided to bidders.

4.6.3. Assists in developing data reports and GIS overlays to support Management, OEIS, CPUC, CALFIRE, and other authorized agency reporting requirements.

4.6.4. Assists in developing overlays to support presentations and documents regarding the VM program.

4.7. Customer Service Supervisor. Works closely with the Wildfire Mitigation & Reliability Engineer on all customer issues regarding vegetation management. Specifically:

4.7.1. Coordinates responses to customer inquiries or disputes with the Wildfire Mitigation & Reliability Engineer.

4.7.2. Takes the lead on any customer complaints filed with the CPUC regarding vegetation management.

4.7.3. Supports customer outreach and education on vegetation management effort.

Bear Valley Electric Service, Inc.
Vegetation Management and Vegetation QA/QC Programs

4.7.4. Ensures BVES Website and Social Media inform customers on where vegetation clearance work is being conducted on a weekly basis.

4.8. Customer Program Specialist. Supports the Wildfire Mitigation & Reliability Engineer on all customer outreach efforts. Specifically:

4.8.1. With input from the Wildfire Mitigation & Reliability Engineer, generates or updates customer outreach media products to educate customers on vegetation management efforts in the BVES service area.

4.8.2. BVES Website and Social Media inform customers on where vegetation clearance work is being conducted on a weekly basis.

4.9. Administrative Support Associate. Provides assistance in administering the VM program and VM QA/QC program. Specifically:

4.9.1. Provides administrative support as described in Section 5 for the VM QA/QC program.

4.9.2. Provides administrative support in the preparation and submission of reports and correspondence associated with the VM program.

5. Vegetation Quality Assurance/Quality Control Program:

5.1. Vegetation Management Quality Assurance Program. The VM QA program is the part of quality management focused on providing confidence that quality requirements will be fulfilled by the VM program. The confidence provided by quality assurance is twofold —internally to management and externally to customers, government agencies, regulators, certifiers, and other stakeholders. The VM QA program consists of the following elements:

- Annual VM Program Audit conducted by the Forester if assigned (if not assigned, the Regulatory Compliance Project Engineer will perform the audit).
- Quarterly VM Program Assessment conducted by the Wildfire Mitigation & Reliability Engineer.
- Periodic VM QC checks conducted by staff per this policy and procedure.

5.2. Annual VM Program Audit. The Annual VM Program Audit will be conducted by the Forester (if not assigned, the Regulatory Compliance Project Engineer will perform the audit) in January each year covering the previous calendar year.

5.2.1. The audit is intended to be a comprehensive review of the VM Program covering at a minimum the areas and questions specified in Appendix B, VM Program Annual QA Audit Areas. The annual audit report shall be due each year by January 31 to the Wildfire Mitigation & Reliability Engineer.

5.2.2. The audit report shall be routed to the President, Utility Manager, Utility Engineer & Wildfire Mitigation Supervisor, and the Field Operations Supervisor for review.

5.2.3. The Wildfire Mitigation & Reliability Engineer shall issue a report of corrective action on issues identified in the annual audit by May 1 each year if applicable.

Bear Valley Electric Service, Inc.
Vegetation Management and Vegetation QA/QC Programs

5.3. Quarterly VM Program Assessment. The Quarterly VM Program Assessment is performed by the Wildfire Mitigation & Reliability Engineer according to the schedule in Table 5-1.

Table 5-1, Quarterly VM Assessment and Report Schedule

Period of Assessment and Report	Report Due Date
January 1 to March 31	April 15
April 1 to June 30	July 15
July 1 to September 30	October 15
October 1 to December 31	January 15

The Wildfire Mitigation & Reliability Engineer shall conduct the Quarterly VM Program Assessment and prepare a quarterly report on the VM Program to the President, Utility Manager, Utility Engineer & Wildfire Mitigation Supervisor, and the Field Operations Supervisor on the status of the program and its results. If assigned, the Forester shall assist in conducting the quarterly assessment and preparing the report.

5.3.2. The report shall include the following at a minimum:

- Brief narrative on the status of the VM program, VM QC Checks program and analysis or commentary on the metrics below as applicable.
- Number of trees trimmed as a result of the vegetation management program.
- Number of trees removed as a result of the vegetation management program.
- Number of Level 1 vegetation discrepancies identified.
- Number of Level 1 vegetation discrepancies resolved.
- Number of Vegetation Orders issued.
- Number of Vegetation Orders resolved.
- Any accidents, incidents, or near misses on the part of vegetation clearance personnel.
- Number of outages where vegetation made contact with power lines and caused the outage (break out those outages where vegetation clearance was in violation of standards)
- List of VM QC Checks performed (include name of evaluator and date performed).
- List of significant findings from VM QC Checks.
- Service area Map showing where contractor worked in the quarter and where contractor will work in the next quarter.
- Where the contractor is in the vegetation cycle plan (e.g., percent complete).
- Corrective action taken on issues noted in previous Quarterly VM Program Assessments.
- Other items that would be useful to Management regarding vegetation management.

5.4. Vegetation Management Quality Control Check Program. The VM QC Check program is designed to check compliance with VM standards in the field. In particular, the program should check VM clearance contractor work. The Wildfire Mitigation & Reliability Engineer will administer the program.

**Bear Valley Electric Service, Inc.
Vegetation Management and Vegetation QA/QC Programs**

5.4.1. Table 5-2, VM QC Check Periodicities, lists the designated staff that shall be assigned VM QC Checks and the periodicity for the checks.

Table 5-2: VM QC Check Periodicities

Title	Periodicity
President	Once every two months (January, March, May, July, September, November)
Utility Manager	Once every two months (February, April, June, August, October, December)
Utility Engineer & Wildfire Mitigation Supervisor	Once every two months (January, March, May, July, September, November)
Field Operations Supervisor	Once every two months (February, April, June, August, October, December)
Regulatory Compliance Project Engineer	Once every two months (January, March, May, July, September, November)
Wildfire Mitigation & Reliability Engineer	Twice per month
Field Inspector	Twice per month
Forester (if assigned)	Twice per month

5.4.2. The Administrative Support Associate shall assign VM QC Checks using the VM QC electronic tracking application.

5.4.3. Evaluators assigned to perform VM QC Checks will be provided a map of the assigned circuit area for the QC Check by the Administrative Support Associate and a copy of the Appendix C VM QC Check Form. These may be provided through the electronic tracking program if equipped. Additionally, the flowchart for Trees and Major Limbs in Close Proximity to Bare Conductors of Appendix A will be made available to evaluators.

5.4.4. Evaluators will inspect the designated circuit for compliance with the VM standards per Section 3 of this policy and procedure and document the results on the VM QC map in accordance with the instructions on the VM QC Check Form of Appendix C. The evaluator will annotate the completed VM QC map with the evaluator’s name and date of the VM QC Check, sign the VM QC map, and route the VM QC map to the Wildfire Mitigation & Reliability Engineer. Additionally, the evaluator will update the VM QC Check Form of Appendix C – this may be done directly in the VM QC Check application if so equipped.

5.4.5. If an evaluator discovers a significant safety issue that would be classified as Level 1 per GO-95 Rule 18, the evaluator should immediately notify the Field Operations Supervisor or Field Inspector who will send the appropriate crew to resolve the issue in an expedient manner. If unable to reach the Field Operations Supervisor or Field Inspector, then notify the Service Crew or Dutyman to resolve the issue. Additionally, notify the Wildfire Mitigation & Reliability Engineer as soon as practical. Examples of Level 1 vegetation discrepancies are vegetation contacting, nearly contacting or arcing to high voltage conductor, vegetation contacting low voltage conductor and compromising structure, etc.

Bear Valley Electric Service, Inc.
Vegetation Management and Vegetation QA/QC Programs

5.4.6. Completed VM QC Checks will be reviewed by the Wildfire Mitigation & Reliability Engineer. The Wildfire Mitigation & Reliability Engineer will issue vegetation orders as applicable to correct any discrepancies noted.

5.4.7. The Wildfire Mitigation & Reliability Engineer will also analyze the results of the VM QC Checks for trends and recommend corrective action to the Utility Manager if deemed necessary. This analysis shall be included in the Quarterly VM Program Assessment report.

5.4.8. The Administrative Support Associate shall check that assigned VM QC checks are being performed in a timely manner and send reminders to individuals alerting them if a VM QC check is overdue.

5.4.9. The VM QC electronic tracking application shall be used, if available, to maintain a record of the VM QC checks, track correction of vegetation orders, and perform program analysis.

Appendix A

Trees and Major Limbs in Close Proximity to Bare Conductors

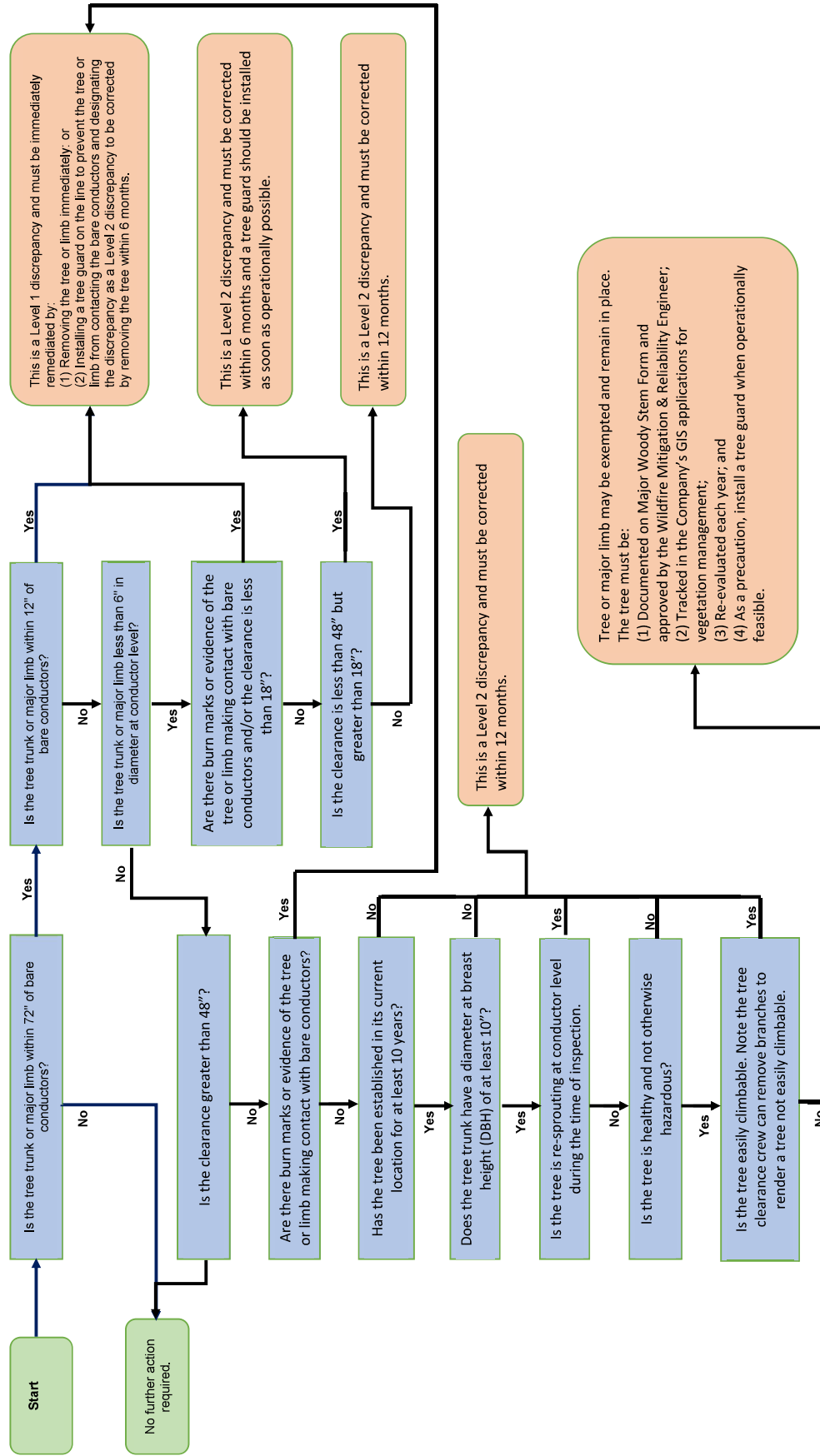

**Bear Valley Electric Service, Inc.
Vegetation Management and Vegetation QA/QC Programs**

Appendix B

VM Program Annual QA Audit Areas	
VM Line Clearance	Is the VM program effective at ensuring vegetation meets required clearance specifications?
	Is the VM program on track with the programmed schedule?
	Is the VM program effective in reducing vegetation contact with bare conductors?
	Are any changes to the VM clearance standards delineated in Section 3 necessary?
	Is the VM clearance contractor(s) executing work in accordance with the VM contract(s)?
	Are changes to the VM Contract Scope of Work needed?
VM Inspections	Are VM inspections (patrol, detailed, LiDAR, etc.) being conducted in accordance with the Company's effective Wildfire Mitigation Plan?
	Are the results of VM inspections being documented, tracked, and resolved in a timely manner in accordance with GO-95 Rule 18?
	For each type of inspection performed, assess whether or not the inspection is effective and useful to assisting in achieving VM program objectives?
	Should additional inspections be performed?
	Is the scheduling of inspections appropriate or should the schedule be modified?
VM QC Checks	Are VM QC Checks being performed in accordance with the requirements of this policy and procedure (Section 5.3)?
	Are personnel performing VM QC Checks sufficiently knowledgeable and qualified to perform the checks?
	Are VM QC Checks documented?
	Are discrepancies identified in VM QC checks being tracked and resolved in a timely manner in accordance with GO-95 Rule 18?
	Are VM QC Checks effective at identifying vegetation clearance issues?
	Should modifications to Appendix B VM QC Check Instructions be made?
VM Quarterly Reports	Are the VM Quarterly Reports being conducted per Section 4.1.24?
	Are the VM Quarterly Reports useful in providing management an assessment of the VM program?
	Should changes be made to the content and/or periodicity of the VM Quarterly Reports?
VM Program	Overall, were the Company's VM Program objectives achieved?
	Are changes recommended to the VM Program Policy and Procedures?
	Are changes in the Company's execution of its VM Program warranted?

**Bear Valley Electric Service, Inc.
Vegetation Management and Vegetation QA/QC Programs**

**Appendix C
Vegetation Management Quality Control Form**

The VM QC Evaluator shall print the QC map and indicate the location of each discrepancy noted by indicating the discrepancy “type” and an arrow showing the approximate location on the map.

Note: Discrepancies of a significant safety nature that would be classified as Level 1 per GO-95 Rule 18 should be resolved immediately by notifying the Field Operations Supervisor or Field Inspector who will send the appropriate crew to resolve the issue in an expedient manner. If unable to reach the Field Operations Supervisor or Field Inspector, then notify the Service Crew or Dutyman to resolve the issue.

Examples of Level 1 vegetation discrepancies are vegetation contacting, nearly contacting or arcing to high voltage conductor, vegetation contacting low voltage conductor and compromising structure, etc.

The QC Evaluator shall indicate the total number of discrepancies for each type on this form. Upon completion of the QC, the QC Evaluator shall update the online QC form, sign and date the map, and return the map to Wildfire Mitigation & Reliability Engineer.

Discrepancy Types:

Type 1: Any vegetation that is within 72” from primary conductors. **Total #:** _____

Type 2: Trimmed vegetation that is not trimmed to a minimum of 12’ from primary conductors. **Total #:** _____

Type 3: Any instances of fast growing trees (poplar, aspen, cottonwood) that were not trimmed out to 12’ regardless of proximity to line. **Total #:** _____

Type 4: Any instances of vertical coverage above BVES sub-transmission lines (34.5 kV). **Total #:** _____

Type 5: Tree and Major Limb infractions: See Trees and Major Limbs in Close Proximity to Bare Conductors flowchart. **Total #:** _____

Type 6: Any tree that is dead, rotten or diseased, or portions of otherwise healthy trees, which overhang or lean toward and may fall into a span of power lines. Note that this may apply to trees outside the clearance zone. **Total #:** _____

Total # of discrepancies: _____

**Bear Valley Electric Service, Inc.
Vegetation Management and Vegetation QA/QC Programs**

Comments:

Appendix H.

Bear Valley Electric Service, Inc. Asset & Inspection Quality Management Plan

December 28, 2021

Approved by: Paul Marconi Digitally signed by Paul Marconi
Date: 2021.12.28 15:34:27 -08'00'
Paul Marconi, President, Treasurer, & Secretary

Bear Valley Electric Service, Inc.
Asset & Inspection Quality Management Plan

1. **Purpose:** To provide policies and procedures to establish an audit process to manage and confirm work completed by employees or subcontractors complies with applicable technical specifications, standards, and codes and meet wildfire mitigation, safety, and reliability objectives.

2. **Scope:** The Quality Management Plan is applicable to all transmission and distribution (T&D) and power generation work with the exception of vegetation management work. A separate document, BVES INC Vegetation Management and Vegetation Management QC Programs Policy and Procedures, outlines the Quality Management Plan for vegetation management work.

3. **Definitions:**
 - 3.1. Quality Assurance (QA) is the part of quality management focused on providing confidence that quality requirements will be fulfilled. The confidence provided by quality assurance is twofold —internally to management and externally to customers, government agencies, regulators, certifiers, and other stakeholders.

 - 3.2. Quality Control (QC) is the part of quality management focused on fulfilling quality requirements. While quality assurance relates to how a process is performed or how a product is made, quality control is more the inspection aspect of quality management.

 - 3.3. Quality Improvement is a set of activities that organizations carry out in order to enhance performance (get better results). Improvement can be achieved by means of a single activity or by means of a recurring set of activities.

 - 3.4. Quality Management (QM) is the coordinated activities to direct and control and the organization with regard to quality.

 - 3.5. Inspection is the process of measuring, examining, and testing to gauge one or more characteristics of a product or service and the comparison of these with specified requirements to determine conformity. Products, processes, and various other results can be inspected to make sure that the object coming off a production line, or the service being provided, is correct and meets specifications.

 - 3.6. External (Contracted) T&D Work is defined as when scope of work where the majority and/or critical tasks are performed by a contractor.

 - 3.7. Internal T&D Work is defined as when scope of work where the majority and/or critical tasks are performed by BVES employees.

 - 3.8. Power Plant Work is defined as when the scope of work is on the Power Plant engines and/or supporting systems.

Bear Valley Electric Service, Inc.
Asset & Inspection Quality Management Plan

3.9. Substation Work is defined as when the scope of work is within the boundaries of a substation.

4. **Overview:** The primary goal of a Quality Management Plan is to ensure that the deliverables from work are of adequate quality and fit-for-purpose. Quality Assurance, Quality Control, and Quality Improvement are integral components of the Quality Management Plan. T&D and power generation work have a direct impact on wildfire mitigations, public and worker safety, and grid resiliency and reliability; therefore, it is essential that work is completed in a manner that is compliant with all applicable technical specifications, standards, and codes.

QA involves thinking about what is required to ensure quality will be achieved, and to set out processes, standards, procedures and/or policies to do that. Typical results of QA are quality plans, inspection and test plans (ITPs), documentation and training. It moves a step up from finding the failures to aiming to prevent or eliminate them. The focus of QA is to provide confidence that requirements and standards are met, and that processes and system have been followed. Some examples of QA:

- A checklist for assembly of product (the procedure/process as a series of steps that must be done).
- A written procedure.
- A set of processes for construction that cover the whole 'life cycle' from getting system requirements, through designing the system, procuring the materials or parts, constructing to applicable standards, testing, and placing in operation.
- A set of processes for a service that cover the whole 'life cycle' from establishing what the system requires, through designing the service, developing and delivering it.

QC is a procedure or set of procedures intended to ensure that a performed service adheres to a defined set of quality criteria or meets the applicable requirements and technical specifications. While QA refers to the confirmation that specified requirements have been met by a product or service, QC refers to the actual inspection of these elements. In order to implement an effective QC program, the organization must decide which specific standards and technical specifications must be met. Then the extent of QC actions must be determined -- for example, the percentage of structures to be inspected for each job and/or the level of detail for each inspection. Next, the results of the QC actions are analyzed to:

- Determine if quality requirements are being fulfilled,
- Expose areas where quality requirements are not being met,
- Identify areas for process improvement even if quality requirements are being fulfilled, and
- Evaluate if QC inspections are sufficient to determine if quality requirements are being fulfilled.

Bear Valley Electric Service, Inc.
Asset & Inspection Quality Management Plan

After this, corrective action and/or process improvements must be decided upon and taken, if warranted. Finally, the QC process must be ongoing to ensure that remedial efforts, if required, have produced satisfactory results and to immediately detect recurrences or new instances of trouble.

5. Roles and Responsibilities:

5.1. Utility Manager. Overall responsible for oversight of the quality management program. Table 6-1, BVES QA Process, in Section 6 details specific areas of responsibility.

5.2. Utility Engineer and Wildfire Mitigation Supervisor. Overall responsible for determining work scope, technical specifications, QA/QC requirements, evaluating QC results, and implementing QC requirements. Table 6-1, BVES QA Process, in Section 6 details specific areas of responsibility.

5.3. Field Operations Supervisor. Overall responsible for fieldwork and supporting the Utility Manager and Utility Engineer and Wildfire Mitigation Supervisor in their responsibilities. Table 6-1, BVES QA Process, in Section 6 details specific areas of responsibility.

5.4. Accounting Supervisor. Overall responsible for providing oversight of the procurement of equipment and material and the contracting of labor and services. Table 6-1, BVES QA Process, in Section 6 details specific areas of responsibility.

5.5. Regulatory Compliance Project Engineer. Responsible for supporting the Utility Engineer and Wildfire Mitigation Supervisor as detailed in Table 6-1, BVES QA Process, in Section 6.

5.6. Project Coordinator. Responsible for conducting QC activities as directed and supporting the Utility Engineer and Wildfire Mitigation Supervisor as detailed in Table 6-1, BVES QA Process, in Section 6.

5.7. GIS Specialist. Responsible for updating the GIS to document work completed and for supporting the Utility Engineer and Wildfire Mitigation Supervisor as detailed in Table 6-1, BVES QA Process, in Section 6.

5.8. Field Inspector. Responsible for conducting QC activities as directed and supporting the Utility Engineer and Wildfire Mitigation Supervisor as detailed in Table 6-1, BVES QA Process, in Section 6.

5.9. Substation Technician. Responsible for conducting QC activities as directed and supporting the Utility Engineer and Wildfire Mitigation Supervisor as detailed in Table 6-1, BVES QA Process, in Section 6.

Bear Valley Electric Service, Inc.
Asset & Inspection Quality Management Plan

5.10. Senior Power Plant Operator. Responsible for conducting QC activities as directed and supporting the Utility Engineer and Wildfire Mitigation Supervisor as detailed in Table 6-1, BVES QA Process, in Section 6.

5.11. Line Crew Foreman. Responsible for conducting QC activities as directed and supporting the Utility Engineer and Wildfire Mitigation Supervisor as detailed in Table 6-1, BVES QA Process, in Section 6.

5.12. Contracts Administrator. Responsible for ensuring qualified contractors are utilized for contracted work and that the contracting is in accordance with the Company’s procurement policies as detailed in Table 6-1, BVES QA Process, in Section 6.

5.13. Buyer. Responsible for ensuring qualified vendors are utilized for procurement of equipment and materials, and that the purchasing is in accordance with the Company’s procurement policies as detailed in Table 6-1, BVES QA Process, in Section 6.

5.14. Storekeeper. Responsible for receipt inspecting material and equipment to ensure it meets the specifications and quality requirements as required by the Purchase Order. Responsible for ensuring material and equipment is properly stored after receipt in accordance with manufacturer directions. Table 6-1, BVES QA Process, in Section 6 details specific areas of responsibility.

6. **Quality Management:** Table 6-1, BVES QA Process, outlines is the standard QA process that BVES follows to achieve the desired quality outcome for T&D and power generation work. Appendix A provides a flowchart of the QA process indicating steps that may be performed in parallel and process improvement loops. Depending on the complexity of the work, the Utility Engineer & Wildfire Mitigation Supervisor may require additional quality steps or may omit quality steps from the QA process as applicable to the specific work scope. Section 7 provides additional guidance on how the QA process is to be implemented.

Quality Step	Activity Description	Staff Involved
1	Determine scope of work (construction, repairs, inspections, etc.).	Responsibility: Utility Engineer & Wildfire Mitigation Supervisor. Support: Regulatory Compliance Project Engineer.
2	Establish applicable work technical specifications, instructions, standards, and material and equipment requirements (Work Order)	Responsibility: Utility Engineer & Wildfire Mitigation Supervisor. Support: Regulatory Compliance Project Engineer, Utility Planner, Engineering Technician, & Buyer.
3	Determine qualifications required of personnel performing the scope of work.	Responsibility: Utility Engineer & Wildfire Mitigation Supervisor. Support: Field Operations Supervisor.
4	Determine level of in process QC and work closeout and acceptance QC necessary to ensure quality requirements are satisfied.	Responsibility: Utility Engineer & Wildfire Mitigation Supervisor. Support: Field Operations Supervisor.

Bear Valley Electric Service, Inc.
Asset & Inspection Quality Management Plan

Quality Step	Activity Description	Staff Involved
5	Select staff to conduct applicable QC.	Responsibility: Utility Engineer & Wildfire Mitigation Supervisor. Support: Field Operations Supervisor.
6	Select qualified contractors (Request for Proposal) and/or staff to conduct the scope of work.	Responsibility: Utility Manager Support: Utility Engineer & Wildfire Mitigation Supervisor, Field Operations Supervisor, Regulatory Compliance Project Engineer, Accounting Supervisor, & Contracts Administrator.
7	Implement directed in process QC and work closeout QC.	Responsibility: Utility Engineer & Wildfire Mitigation Supervisor Support (as applicable): Regulatory Compliance Project Engineer, Engineering Technician, Project Coordinator, Field Inspector, Substation Technician, Senior Power Plant Operator, & Line Crew Foreman
8	Procure material and equipment (Purchase Order).	Responsibility: Buyer Support (as applicable): Accounting Supervisor
9	Receipt inspect material and equipment and properly store it.	Responsibility: Storekeeper Support (as applicable): Buyer, Accounting Supervisor
10	Commence work per scope of work.	Responsibility: Field Operations Supervisor Support (as applicable): Utility Manager, Utility Engineer & Wildfire Mitigation Supervisor, & Project Coordinator
11	Conduct directed in process QC at appropriate process control points.	Responsibility: Regulatory Compliance Project Engineer Support (as applicable): Engineering Technician, Project Coordinator, Field Inspector, Substation Technician, Senior Power Plant Operator, & Line Crew Foreman
12	Evaluate results of in process QC.	Responsibility: Regulatory Compliance Project Engineer Support (as applicable): Engineering Technician, Project Coordinator, Field Inspector, Substation Technician, Senior Power Plant Operator, & Line Crew Foreman
13	Determine if corrective action and/or process improvements warranted based on in process QC.	Responsibility: Utility Engineer & Wildfire Mitigation Supervisor Support (as applicable): Utility Manager, Field Operations Supervisor, & Project Coordinator.
14	Take corrective action if warranted based on in process QC.	Responsibility: Regulatory Compliance Project Engineer. Support (as applicable): Engineering Technician, Project Coordinator, Field Inspector, Substation Technician, Senior Power Plant Operator, & Line Crew Foreman.
15	Implement process improvements if warranted based on in process QC.	Responsibility: Utility Engineer & Wildfire Mitigation Supervisor. Support (as applicable): Utility Manager & Field Operations Supervisor.

Bear Valley Electric Service, Inc.
Asset & Inspection Quality Management Plan

Quality Step	Activity Description	Staff Involved
16	Determine if in process QC is appropriate. If not, implement additional or reduced in process QC as warranted.	Responsibility: Utility Engineer & Wildfire Mitigation Supervisor. Support (as applicable): Utility Manager & Field Operations Supervisor.
17	At work reported complete, document work performed (GIS update, work order closing, drawing update, inspection report, etc.).	Responsibility: Utility Engineer & Wildfire Mitigation Supervisor. Support (as applicable): Project Coordinator, GIS Specialist, Field Inspector, Substation Technician, Senior Power Plant Operator & Line Crew Foreman.
18	Conduct directed work closeout QC when work is completed.	Responsibility: Regulatory Compliance Project Engineer. Support (as applicable): Engineering Technician, Project Coordinator, Field Inspector, Substation Technician, Senior Power Plant Operator, & Line Crew Foreman.
19	Evaluate results of work closeout QC.	Responsibility: Regulatory Compliance Project Engineer Support (as applicable): Engineering Technician, Project Coordinator, Field Inspector, Substation Technician, Senior Power Plant Operator, & Line Crew Foreman
20	Determine if corrective action and/or process improvements warranted based on work closeout QC.	Responsibility: Utility Engineer & Wildfire Mitigation Supervisor Support (as applicable): Utility Manager, Field Operations Supervisor, & Project Coordinator.
21	Take corrective action if warranted based on work closeout QC.	Responsibility: Regulatory Compliance Project Engineer. Support (as applicable): Engineering Technician, Project Coordinator, Field Inspector, Substation Technician, Senior Power Plant Operator, & Line Crew Foreman.
22	If rework is necessary, ensure applicable in process QC and work close QC are conducted as appropriate.	Responsibility: Regulatory Compliance Project Engineer Support (as applicable): Engineering Technician, Project Coordinator, Field Inspector, Substation Technician, Senior Power Plant Operator, & Line Crew Foreman
23	Implement process improvements if warranted based on work closeout QC.	Responsibility: Utility Engineer & Wildfire Mitigation Supervisor. Support (as applicable): Utility Manager & Field Operations Supervisor.
24	Determine if work closeout QC is appropriate. If not, implement additional or reduced work closeout QC as warranted.	Responsibility: Utility Engineer & Wildfire Mitigation Supervisor. Support (as applicable): Utility Manager & Field Operations Supervisor.

Bear Valley Electric Service, Inc.
Asset & Inspection Quality Management Plan

Quality Step	Activity Description	Staff Involved
25	Closeout Work Order.	Responsibility: Utility Engineer & Wildfire Mitigation Supervisor. Support (as applicable): Field Operations Supervisor, Accounting Supervisor, Project Coordinator, GIS Specialist, Field Inspector, Substation Technician, Senior Power Plant Operator & Line Crew Foreman.

7. **Additional QM Guidance.** As discussed in Section 6, depending on the complexity of the work, the Utility Engineer & Wildfire Mitigation Supervisor (for T&D work) and Field Operations Supervisor (for Power Plant work) may require additional quality steps or may omit quality steps from the QA process as applicable to the specific work scope. This section provides guidance to be applied when making the determination for what QA will be applied to specific work and activities.

7.1. Equipment and Material.

7.1.1. Standard Stock Equipment and Material: The Utility Engineer & Wildfire Mitigation Supervisor shall approve the technical specifications of equipment and material to be maintained in standard inventory stock. Utility Engineer & Wildfire Mitigation Supervisor shall coordinate with the Field Operations Supervisor to determine standard stock minimum and maximum value amounts. Additionally, the Utility Engineer & Wildfire Mitigation Supervisor shall work with the Field Operations Supervisor when determining the specific technical specifications of material to be maintained in stock. The Buyer will place purchase orders for equipment and material to qualified vendors to replenish stock to avoid going below the minimum inventory amounts. The Storekeeper will receipt inspect all standard stock items and report discrepancies to the Buyer and Utility Engineer & Wildfire Mitigation Supervisor. For discrepancies affecting the technical specifications or performance of materials, the Utility Engineer & Wildfire Mitigation Supervisor will direct what corrective action(s) should be taken. For non-technical discrepancies (i.e., wrong amount of material received), the Buyer will direct what corrective action(s) should be taken.

7.1.2. Non-Standard Stock Equipment and Material: The Utility Engineer & Wildfire Mitigation Supervisor shall approve the technical specifications of non-standard stock equipment and material prior to purchasing. The Buyer will place purchase orders for the non-standard equipment and material as listed on the approved requisition to qualified vendors. When the equipment and material is received, the Storekeeper will receipt inspect it and will inform the Utility Engineer & Wildfire Mitigation Supervisor. The Utility Engineer & Wildfire Mitigation Supervisor will determine if an additional receipt inspection is necessary by a Subject Mater Expert. The following additional receipt inspections will be required by the Utility Engineer & Wildfire Mitigation Supervisor at a minimum:

- Substation equipment, capacitor banks, electronic fuse trip savers, and field switches will be receipt inspected by the Substation Technician.

Bear Valley Electric Service, Inc.
Asset & Inspection Quality Management Plan

- Distribution overhead and pad mounted transformers will be receipt inspected by a Journeyman Lineman or the Substation Technician.
- IT and communications equipment and material will be inspected by IT staff.
- Weather stations and other digital equipment and sensors will be receipt inspected by IT staff, Substation Technician and/or other SME staff as designated by the Utility Engineer & Wildfire Mitigation Supervisor.
- Meters and meter related equipment and material shall be receipt inspected by the Meter Testman.
- Power Plant equipment and material will be receipt inspected by the Power Plant Senior Operator.

Discrepancies noted in the receipt inspections shall be reported to the Buyer and Utility Engineer & Wildfire Mitigation Supervisor. For discrepancies affecting the technical specifications or performance of materials, the Utility Engineer & Wildfire Mitigation Supervisor will direct what corrective action(s) should be taken. For non-technical discrepancies (i.e., wrong amount of material received), the Buyer will direct what corrective action(s) should be taken.

7.1.3. Equipment and Material Ordered for Specific Projects: The Utility Engineer & Wildfire Mitigation Supervisor will direct if any additional SME receipt inspection(s) are necessary in addition to the Storekeeper's receipt inspection for equipment and material ordered to support a specific project. For example, if the equipment and material is the same equipment and material maintained in stock, the Storekeeper's receipt inspection would normally be sufficient. The Utility Engineer & Wildfire Mitigation Supervisor should use the guidance in Section 7.1.2 to determine if additional receipt inspections are necessary.

7.2. Contracted Services. The Utility Manager shall be responsible for contracting for work from qualified contractors by following the Company's procurement policy. In coordination with the Utility Engineer & Wildfire Mitigation Supervisor, Field Operations Supervisor, Accounting Supervisor, and Contracts Administrator, the Utility Manager shall develop the contracted scope of work and issue a Request for Proposal to qualified contractors. The Utility Manager shall follow the Company's procurement policy in selecting the best value bid from qualified contractors and awarding the contract.

7.3. External (Contracted) T&D Work. In coordination with the Field Operations Supervisor, the Utility Engineer & Wildfire Mitigation Supervisor shall approve specific in-process and closeout QC checks for external T&D work. The Utility Engineer & Wildfire Mitigation Supervisor shall utilize the following guidance:

- Prior to authorizing work, the Utility Engineer & Wildfire Mitigation Supervisor shall review and approve the design, construction drawings, and technical specifications and then issue a Work Order to direct the specified work.

Bear Valley Electric Service, Inc.
Asset & Inspection Quality Management Plan

- The Utility Manager shall establish a contract with a qualified contractor per the Company's procurement policy.
- Equipment and material shall be ordered per Section 7.1 above as applicable once the Work Order is opened.
- The Utility Engineer & Wildfire Mitigation Supervisor in coordination with the Field Operations Supervisor shall determine the specific in process and closeout QC checks to be conducted and select the staff that will conduct the QC checks. Generally, QC checks shall be performed by the Field Inspector or a BVES Journeyman Lineman Foreman.
- Staff that will be involved in the QC checks shall review the Work Order.
- Once the Work Order is authorized, equipment and material is received, contract in place for the contracted work, and the work schedule supports the work, the Field Operations Supervisor in coordination with the Project Coordinator will direct the contractor to conduct the work.
- In-process QC checks may be designated to be conducted periodically (for example, daily when work is in progress), randomly (for example, unannounced when work is in progress), as task related inspections (for example, prior to installing a ground rod the BVES inspector must be on site), and/or a combination the later methods.
- Results of in-process QC checks should be reviewed with the Regulatory Compliance Project Engineer and the Utility Engineer & Wildfire Mitigation Supervisor and corrective action directed if necessary.
- Closeout QC checks shall be designed to confirm the as-built drawings, inspect the quality of the workmanship, and ensure that the designated materials were installed. Additionally, the closeout QC checks will include an audit of the Work Order package.
- When work is reported complete, the Field Operations Supervisor shall direct closeout QC checks be conducted.
- Results of closeout QC checks should be reviewed with the Regulatory Compliance Project Engineer and the Utility Engineer & Wildfire Mitigation Supervisor and corrective action directed if necessary.
- Upon receipt of an invoice for the work, the Project Coordinator shall perform a work package audit and validate the materials and work performed. Project Coordinator shall also perform a validation of billing units, and ensures the Field Inspector's verification of work completion and approval for billing. Invoices will not be approved unless the work meets required standards per the scope of work.

The Utility Engineer & Wildfire Mitigation Supervisor shall review the results of in process and closeout QC checks and the completed Work Order package and will direct re-work and/or other corrective action if necessary. Once, the Utility Engineer & Wildfire Mitigation Supervisor is satisfied the work is of satisfactory quality, the Work Order may be closed out.

7.4. Internal T&D Work. In coordination with the Field Operations Supervisor, the Utility Engineer & Wildfire Mitigation Supervisor shall approve specific in process and closeout QC checks internal T&D work. The Utility Engineer & Wildfire Mitigation Supervisor shall utilize the following guidance:

Bear Valley Electric Service, Inc.
Asset & Inspection Quality Management Plan

- Prior to authorizing work, the Utility Engineer & Wildfire Mitigation Supervisor shall review and approve the design, construction drawings, and technical specifications and then issue a Work Order to direct the specified work.
- Equipment and material shall be ordered per Section 7.1 above as applicable once the Work Order is opened.
- The Utility Engineer & Wildfire Mitigation Supervisor in coordination with the Field Operations Supervisor shall determine the specific in process and closeout QC checks to be conducted and select the staff that will conduct the QC checks. Generally, QC checks shall be performed by a BVES Journeyman Lineman Foreman.
- Staff that will be involved in the QC checks shall review the Work Order.
- Once the Work Order is authorized, equipment and material is received, contract in place for the contracted work, and the work schedule supports the work, the Field Operations Supervisor in coordination with the Project Coordinator will direct the BVES crew to conduct the work.
- In-process QC checks may be designated to be conducted periodically (for example, daily when work is in progress), randomly (for example, unannounced when work is in progress), as task related inspections (for example, prior to installing a ground rod the BVES inspector must be on site), and/or a combination the later methods.
- Results of in-process QC checks should be reviewed with the Regulatory Compliance Project Engineer and the Utility Engineer & Wildfire Mitigation Supervisor and corrective action directed if necessary.
- Closeout QC checks shall be designed to confirm the as-built drawings, inspect the quality of the workmanship, and ensure that the designated materials were installed. Additionally, the closeout QC checks will include an audit of the Work Order package.
- When work is reported complete, the Field Operations Supervisor shall direct closeout QC checks be conducted.
- Results of closeout QC checks should be reviewed with the Regulatory Compliance Project Engineer and the Utility Engineer & Wildfire Mitigation Supervisor and corrective action directed if necessary.
- The Regulatory Compliance Project Engineer shall perform a work package audit and validate the materials and work performed.

The Utility Engineer & Wildfire Mitigation Supervisor shall review the results of in process and closeout QC checks and the completed Work Order package and will direct re-work and/or other corrective action if necessary. Once, the Utility Engineer & Wildfire Mitigation Supervisor is satisfied the work is of satisfactory quality, the Work Order may be closed out.

7.5. Substation Work. The Utility Engineer & Wildfire Mitigation Supervisor shall approve specific in process and closeout QC checks for substation work. The Utility Engineer & Wildfire Mitigation Supervisor shall utilize the following guidance:

Bear Valley Electric Service, Inc.
Asset & Inspection Quality Management Plan

- Prior to authorizing work, the Utility Engineer & Wildfire Mitigation Supervisor shall review and approve the design, construction drawings, and technical specifications and then issue a Work Order to direct the specified work.
- The Utility Engineer & Wildfire Mitigation Supervisor shall approve a specific testing and commissioning program that must be satisfactorily completed prior to accepting major substation work.
- The Utility Manager shall establish a contract with a qualified contractor per the Company's procurement policy.
- Equipment and material shall be ordered per Section 7.1 above as applicable once the Work Order is opened.
- The Utility Engineer & Wildfire Mitigation Supervisor in coordination with the Field Operations Supervisor shall determine the specific in process and closeout QC checks to be conducted and select the staff that will conduct the QC checks. Generally, QC checks shall be performed by the Substation Technician or a BVES Journeyman Lineman Foreman.
- Staff that will be involved in the QC checks shall review the Work Order.
- Once the Work Order is authorized, equipment and material is received, contract in place for the contracted work, and the work schedule supports the work, the Field Operations Supervisor in coordination with the Project Coordinator will direct the contractor to conduct the work.
- In-process QC checks may be designated to be conducted periodically (for example, daily when work is in progress), randomly (for example, unannounced when work is in progress), as task related inspections (for example, prior to making up switch connections, the BVES inspector must be on site), and/or a combination the later methods.
- Results of in-process QC checks should be reviewed with the Regulatory Compliance Project Engineer and the Utility Engineer & Wildfire Mitigation Supervisor and corrective action directed if necessary.
- Closeout QC checks shall be designed to confirm the as-built drawings, inspect the quality of the workmanship, and ensure that the designated materials were installed. Additionally, the closeout QC checks will include an audit of the Work Order package.
- When work is reported complete, the Field Operations Supervisor shall direct closeout QC checks be conducted.
- Results of closeout QC checks should be reviewed with the Regulatory Compliance Project Engineer and the Utility Engineer & Wildfire Mitigation Supervisor and corrective action directed if necessary.
- When conditions are met, the Field Operations Supervisor shall direct performance of the testing and commissioning program. The testing and commissioning program should generally be conducted by a third party independent of the contractor performing the work and/or the Substation Technician. The Substation Technician shall oversee any third party that performs the testing and commissioning program.
- The Utility Engineer & Wildfire Mitigation Supervisor shall review the results of the testing and commissioning program prior to accepting the work as being complete.

Bear Valley Electric Service, Inc.
Asset & Inspection Quality Management Plan

- Upon receipt of an invoice for the work, the Project Coordinator shall perform a work package audit and validate the materials and work performed. Project Coordinator also performs a validation of billing units, and ensures the Substation Technician's verification of work completion and approval for billing. Invoices will not be approved unless the work meets required standards per the scope of work.

Utility Engineer & Wildfire Mitigation Supervisor shall review the results of closeout QC checks and testing and commissioning program, and will direct re-work and/or other corrective action if necessary. Once, the Utility Engineer & Wildfire Mitigation Supervisor is satisfied the work is of satisfactory quality, the Work Order may be closed out.

7.6. Power Plant Work. The Field Operations Supervisor in coordination with the Senior Power Plant Operator shall approve specific in process and closeout QC checks for power plant work. The Field Operations Supervisor shall utilize the following guidance:

- Prior to authorizing work, the Field Operations Supervisor in coordination with the Senior Power Plant Operator shall review and approve the design, construction drawings, and technical specifications and then issue a Work Order with Engineering and Planning support to direct the specified work.
- The Field Operations Supervisor in coordination with the Senior Power Plant Operator shall approve a specific testing and commissioning program that must be satisfactorily completed prior to accepting major power plant work.
- The Utility Manager shall establish a contract with a qualified contractor per the Company's procurement policy.
- Equipment and material shall be ordered per Section 7.1 above as applicable once the Work Order is opened.
- The Field Operations Supervisor in coordination with the Senior Power Plant Operator shall determine the specific in process and closeout QC checks to be conducted and select the staff that will conduct the QC checks. Generally, QC checks shall be performed by the Senior Power Plant Operator or Power Plant Operator.
- Staff that will be involved in the QC checks shall review the Work Order.
- Once the Work Order is authorized, equipment and material is received, contract in place for the contracted work, and the work schedule supports the work, the Field Operations Supervisor in coordination with the Project Coordinator will direct the contractor to conduct the work.
- In-process QC checks may be designated to be conducted periodically (for example, daily when work is in progress), randomly (for example, unannounced when work is in progress), as task related inspections (for example, prior to reassembly of an engine cylinder, the BVES inspector must be on site), and/or a combination the later methods.
- Results of in-process QC checks should be reviewed with the Field Operations Supervisor and the Senior Power Plant Operator and corrective action directed if necessary.

Bear Valley Electric Service, Inc.
Asset & Inspection Quality Management Plan

- Closeout QC checks shall be designed to confirm the as-built drawings, inspect the quality of the workmanship, and ensure that the designated materials were installed. Additionally, the closeout QC checks will include an audit of the Work Order package.
- When work is reported complete, the Field Operations Supervisor shall direct closeout QC checks be conducted.
- Results of closeout QC checks should be reviewed with the Field Operations Supervisor and the Senior Power Plant Operator and corrective action directed if necessary.
- When conditions are met, the Field Operations Supervisor shall direct performance of the testing and commissioning program. The testing and commissioning program should generally be conducted by a third party independent of the contractor performing the work and/or the Senior Power Plant Operator. The Senior Power Plant Operator shall oversee any third party that performs the testing and commissioning program.
- The Field Operations Supervisor and the Senior Power Plant Operator shall review the results of the testing and commissioning program prior to accepting the work as being complete.
- Upon receipt of an invoice for the work, the Project Coordinator shall perform a work package audit and validate the materials and work performed. Project Coordinator also performs a validation of billing units, and ensures the Senior Power Plant Operator's verification of work completion and approval for billing. Invoices will not be approved unless the work meets required standards per the scope of work.

The Field Operations Supervisor and Senior Power Plant Operator shall review the results of closeout QC checks and testing and commissioning program, and will direct re-work and/or other corrective action if necessary. Once, the Utility Engineer & Wildfire Mitigation Supervisor is satisfied the work is of satisfactory quality, the Work Order may be closed out.

Appendix A: BVES QA Process Flow Chart

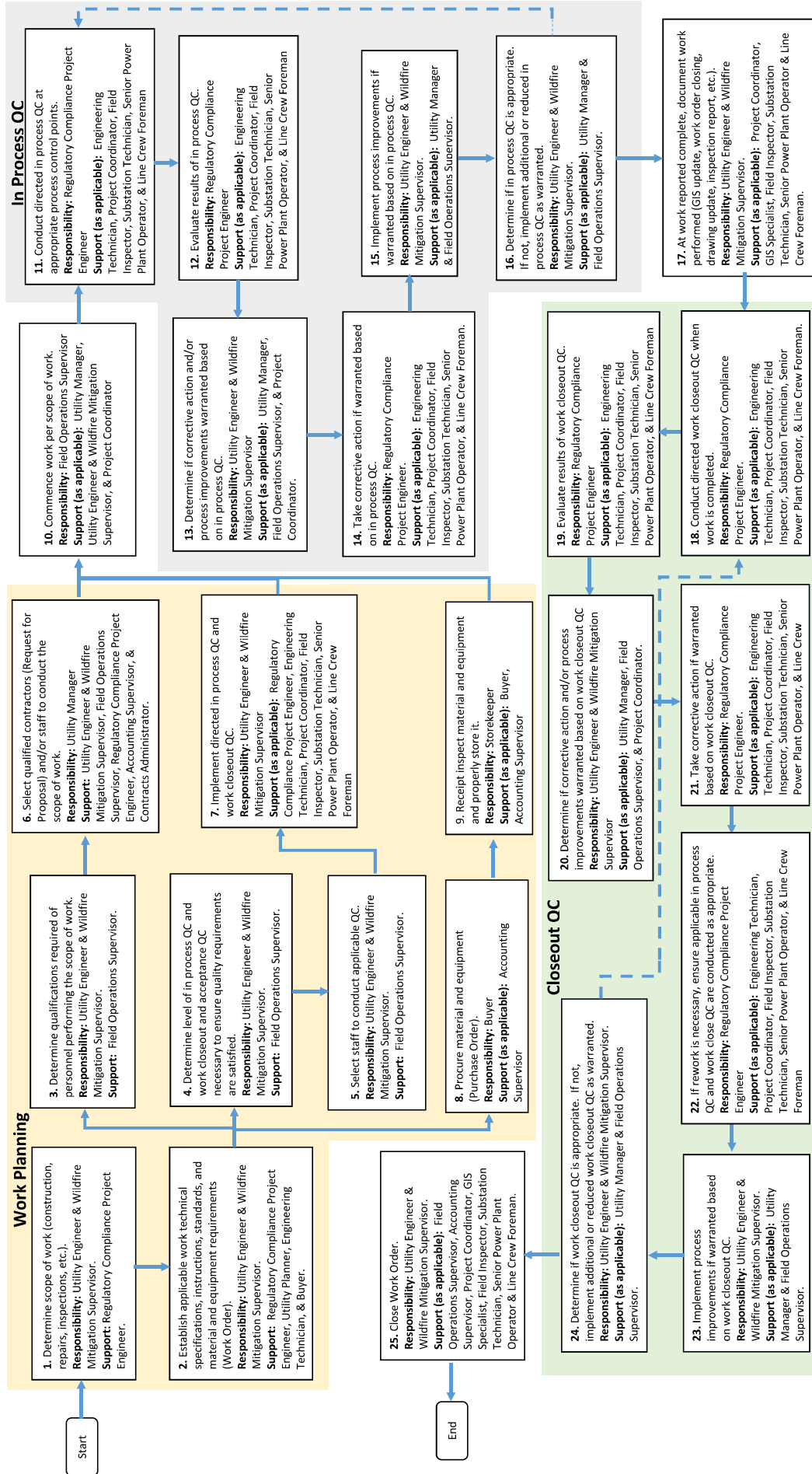

Appendix I.

Bear Valley Electric Service, Inc. Public Safety Power Shutoff Plan

January 31, 2023

Paul Marconi Digitally signed by Paul Marconi
Date: 2023.02.27 06:38:57 -08'00'

Approved by: _____

Paul Marconi, President, Treasurer & Secretary

**Bear Valley Electric Service, Inc.
Public Safety Power Shutoff Plan**

Table of Contents

1. Purpose and Guidelines
 - 1.1. Purpose of PSPS
 - 1.2. Purpose of PSPS Plan
 - 1.3. Measure of Last Resort
 - 1.4. PSPS Coordination
 - 1.5. PSPS Is an Emergency
 - 1.6. Reporting and Continuous Improvement
2. Chain of Responsibility
 - 2.1. President
 - 2.2. Utility Manager
 - 2.3. Field Operations Supervisor
 - 2.4. Utility Engineer & Wildfire Mitigation Supervisor
 - 2.5. Customer Program Specialist
3. Considerations for Plan Activation
 - 3.1. Considerations for PSPS Plan Activation
4. BVES Fire Prevention Procedures
 - 4.1. Fire Prevention
 - 4.2. Seasonal Considerations
 - 4.3. Daily-to-Real-time Considerations
 - 4.4. Pre-Planned Operational Posture
 - 4.5. Public Safety Power Shutdown (PSPS) Consideration
 - 4.6. Restoration from PSPS
5. BVES PSPS Procedures
 - 5.1. Emergency Response and Disaster Plan
 - 5.2. PSPS Phases
 - 5.3. PSPS Exercises
 - 5.4. SCE Directed PSPS Procedures
6. PSPS Public Outreach and Communications
 - 6.1. Importance of Public Outreach
 - 6.2. EDRP Communications Procedures
 - 6.3. PSPS Planned Communications
 - 6.4. Critical Facilities and Infrastructure
 - 6.5. Key Partners

**Bear Valley Electric Service, Inc.
Public Safety Power Shutoff Plan**

7. Compliance with Applicable Statutes and Regulations

List of Tables

Table 4-1: Fuel Dryness and High-Risk Days

Table 4-2: Example NFDRS Forecast

Table 4-3: Significant Fire Potential

Table 4-4: Operational Direction Based on Wildfire Risk Forecast

Table 4-5: Switches to De-energize “At Risk” Areas

Table 5-1: PSPS Phases for PSPS Procedures

Table 5-2: BVES Action for SCE Lines Under PSPS Consideration

Table 5-3: BVES Action for SCE Lines De-energized Due to PSPS

Table 6-1: BVES PSPS Communications Template Listing

List of Appendices

Appendix A: BVES “High Risk Areas” for PSPS Consideration

Appendix B: BVES Supply Lines, Sources of Power and Sub-Transmission System

Appendix C: Common Acronyms

Bear Valley Electric Service, Inc. Public Safety Power Shutoff Plan

1. Purpose and Overarching Guidelines

1.1. Purpose of PSPS. The purpose of proactive de-energization is to promote public safety by decreasing the risk of utility-infrastructure as a source of wildfire ignitions. Generally, proactive de-energization will be referred to as Public Safety Power Shutoff (“PSPS”), which is consistent with the terminology used by the major California investor owned utilities. As a measure of last resort, PSPS activation is consistent with the statutory obligation to protect public safety pursuant to Public Utilities Codes (“PUCs”) § 451 and 399.2(a).

1.2. Purpose of PSPS Plan. This document provides the policies and procedures of Bear Valley Electric Service, Inc. (“BVES”) follows with regard to PSPS and addresses the following operational issues:

- PSPS advance planning and preparations prior to the fire season.
- Procedures leading up to, during, and following extreme fire threat weather events in which PSPS may be invoked. These include BVES’s operational fire prevention actions and procedures.
- Public outreach, coordination with local and government officials, advisory boards, public safety partners, representatives of people/communities with access and functional needs (“AFN”), tribal representatives (if applicable), senior citizen groups, business owners, and public health and healthcare providers including those with medical needs. This includes a Community Resource Center (“CRC”) and communications regarding PSPS.
- Establish guidelines for PSPS exercises.

1.3. Measure of Last Resort. BVES must only deploy PSPS as a *measure of last resort* and must justify why PSPS was deployed over other possible measures or actions. This plan provides the course of action to be followed prior to enacting a PSPS, demonstrating that enacting a PSPS is the measure of last resort.

Customer Engagement. BVES will work to engage its customers and other impacted stakeholders to promote understanding of the purpose of PSPS actions, BVES’s process for initiating it, how to safely manage a PSPS event, and the impacts if deployed.

1.4. PSPS Coordination. Deploying PSPS requires a coordinated effort across multiple state and local jurisdictions and agencies. Coordination in preparation for PSPS is a shared responsibility between BVES, public safety partners, and local governments; however, BVES is ultimately responsible and accountable for the safe deployment of PSPS. BVES must work with the California Governor’s Office of Emergency Services to integrate its warning programs with the agencies and jurisdictions within California that have a role in ensuring that the public is notified before, during, and after emergencies. Throughout this document the collective phrase “Local Government, Agencies, and Partner Organizations” includes applicable local government and agencies, utilities, key

Bear Valley Electric Service, Inc. Public Safety Power Shutoff Plan

non-government and commercial entities and also includes critical facilities and critical infrastructure. Further discussion is provided in Section 5.

1.5. PSPS Is an Emergency. Consequences of PSPS should be treated in a similar manner as other emergencies that may result in loss of power, such as earthquakes or floods.

1.6. Reporting and Continuous Improvement. BVES must report on lessons learned from each PSPS event, including instances when PSPS protocols are initiated, but de-energization does not occur, to continually improve PSPS practices.

BVES must work together with the other utilities to share information and advice to create effective and safe PSPS programs at each utility and ensure utilities are sharing current and accurate information with public safety partners.

2. Chain of Responsibility

2.1. President holds overall responsibility for the PSPS Plan and ensuring it is properly implemented, resourced, trained upon, executed, and updated as appropriate. Furthermore, the President shall ensure proper communications and coordination with local government, agencies and customers.

2.2. Utility Manager is responsible for executing the following actions under BVES PSPS Plan:

- Direct emergency operations under this Plan and the EDRP;
- Ensure monitoring of weather forecasts and actual weather conditions is properly conducted by appropriate staff;
- Direct (the operational activities related to system line-up and PSPS as warranted);
- Ensure Field Operations staff provide timely and accurate information to the Customer Service Supervisor and other staff performing customer and public information functions;
- Work closely and coordinate with counterparts at local government and agencies leading up to a PSPS event, during PSPS, and during restoration procedures ;
- Activate the Wildfire Response Team (WRT) for PSPS procedures
- Determine the appropriate staff composition of the WRT when activated;
- Train or assign training to BVES staff with roles required by this Plan;
- Ensure resources are available to properly execute this plan and identifying any gaps in resources to the President as well as proposed remedies;
- Ensure all regulations are followed required reports are timely submitted to the applicable regulatory bodies, including the Commission and Energy Safety;
- Evaluate whether changes to this plan are warranted and implementing any necessary changes.

**Bear Valley Electric Service, Inc.
Public Safety Power Shutoff Plan**

2.3. Field Operations Supervisor is responsible for executing or directing the following operations in the field to include:

- Monitor (or direct monitoring) weather advisories, consultant forecasts, and the NFDRS forecast at least daily during the fire season;
- Direct and manage operational system line-ups based on conditions as described in this plan;
- Direct and coordinate PSPS procedures in this plan;
- Direct the activities of the WRT;
- Control all switch and system lineup operations;
- Provide (or ensure) timely and accurate information to the Customer Service Supervisor and/or other staff performing customer and public information functions;
- Inform the Utility Manager of any system issues;
- Collect relevant data and maintain documentation including, but not limited to, inspections, operational system lineup, and PSPS activities; and
- Submit to the Utility Manager recommended changes to this plan as warranted.

2.4. Utility Engineer & Wildfire Mitigation Supervisor is responsible for fire prevention planning and engineering design of the electric distribution, sub-transmission and substations to include:

- Ensure system design and construction is in compliance with applicable government rules and regulations to mitigate fire;
- Develop distribution, sub-transmission and substations designs to reduce fire risk;
- Research evaluate, and source materials fire resistant materials and equipment;
- Develop device protective settings and select fuses to enhance fire prevention while taking into account reliability and the served load;
- Support Field Operations and the WRT as directed by the Utility Manager in the execution of system operations per this plan; and
- Submit recommended changes to this plan to the Utility Manager as warranted.

2.5. Customer Program Specialist under the supervision of the Customer Service Supervisor and the Energy Resource Manager is responsible for the BVES Communications Plan to include:

- Notify (or direct to notify) local government, agency, and customer notifications under this plan;
- Establish and maintain customer communications methods and systems equipment to support proactive de-energization notifications per this plan;
- Train staff assigned to issue customer and public information via media notification statements and customer communications methods;
- Developing (or causing to be developed) the contact list of local government and agencies per this plan;
- Direct a customer education strategy to inform customers about BVES's fire mitigation programs including PSPS; and
- Submit to the Utility Manager recommended changes to this plan as warranted.

**Bear Valley Electric Service, Inc.
Public Safety Power Shutoff Plan**

3. Considerations for Plan Activation

3.1. Considerations for PSPS Plan Activation. The BVES service area is susceptible to several conditions in which BVES may activate its PSPS Plan. These are:

- Extreme fire threat weather and fuel conditions in BVES’s service area that warrant BVES to implement PSPS on BVES owned and operated power lines in some or all areas of its service area.
- Extreme fire threat weather and conditions outside of the BVES’s service area, in which Southern California Edison (SCE) directs a PSPS on SCE-owned/operated power lines leading to a partial or complete loss of the three SCE supply lines into the BVES service area. This threat is higher than the likelihood that BVES initiates its own PSPS due to the greater presence extreme fire threat weather and fuel conditions across SCE’s territory than in the BVES service area. In such a case, BVES would seek to supply power to its customers using all available power resources.
- In the circumstance that a PSPS is warranted in some or all areas of the BVES service area and SCE has implemented PSPS actions that result in a partial or complete loss of supplies to the BVES service area.

4. BVES Fire Prevention Procedures

4.1. Fire Prevention.

4.1.1. BVES’ Wildfire Mitigation Plan provides descriptions of system hardening projects, operations and maintenance programs, and other initiatives being pursued by BVES to mitigate wildfire. This PSPS Plan is an extension of the Wildfire Mitigation Plan’s fire prevention efforts.

4.1.2. As system improvements are made and environmental conditions change, the plan will evolve to meet these changes. In creating the plan, BVES has incorporated the input and interests of our stakeholders to ensure that the needs of the community are effectively met while mitigating the risk of wildfire. Community outreach and communications are a key component of this plan as well as maintaining partnerships with the Big Bear Valley Mountain Mutual Aid Association, City of Big Bear Lake, San Bernardino County, Big Bear Fire Department, Big Bear Lake Sheriff’s Department, other local agencies, local utilities, local radio stations, news media, and the public.

4.1.3. PSPS is an operational safety measure of last resort to prevent wildfires. It is logical that the PSPS Plan include BVES’s operational fire prevention plan measures so that the progression of operational steps to be taken by BVES staff is properly sequenced and understood by all stakeholders.

4.1.4. Regulatory Background

Bear Valley Electric Service, Inc.
Public Safety Power Shutoff Plan

Ordering Paragraph 5 of D.12-01-032 required BVES to prepare a Fire Prevention Plan to identify the occurrence of 3-second wind gusts that exceed the structural and mechanical design standards for overhead power-line facilities.

D.14-05-020 modified D.12-01-032 by eliminating the requirement to identify 3-second wind gusts in real time, provided a utility will still address the situation when all three of the following conditions occur simultaneously:

- (i) 3-second wind gusts exceed the structural or mechanical design standards for the affected overhead power-line facilities,
- (ii) these 3-second gusts occur during a period of high fire danger, and
- (iii) the affected facilities are located in a high fire-threat area.

D.14-05-020 also required utilities to identify the specific parts of their service territories where all three conditions listed in Ordering Paragraph I (a) occur simultaneously, based on a minimum probability of 3% over a 50-year period that 3-second wind gusts which exceed the design standards for the affected facilities will occur during a Red Flag Warning in a high fire-threat area. Ordering Paragraph 2 of D.17-12-024 requires each electric investor-owned utility have a fire prevention plan for facilities in the High Fire-Threat District containing the information specified in General Order ("GO") 166, Standard 1, Part E, to the extent applicable to the electric utility's service area and to file a report containing the fire prevention plan annually beginning October 31, 2018.

4.1.5. This plan lists and describes the operational fire prevention measures BVES intends to implement to mitigate the threat of power-line fires generally and in the situation where all three of the conditions listed in GO-166, Standard 1, Part E occur simultaneously. BVES has identified areas potentially susceptible to these conditions. These areas are heavily forested, abundant in available fuel and could threaten the system when high winds occur. When these conditions exist, BVES has pre-identified areas that are targeted for PSPS in Appendix B.

4.2. Seasonal Considerations. Understanding BVES' system demand, service area environmental factors, and wildfire risk drivers allows BVES to operate the system in a manner that is optimized for public safety including wildfire mitigation, reliability, and increased quality of service delivered.

The non-winter months (April through October) bring the following characteristics to BVES's service area:

- Lower load demand due to reduced or minimal tourism and no ski resort snowmaking, therefore BVES' load is generally lowest in April, May, September and October; the load increases somewhat in the summer months of June, July and August;
- Higher ambient temperatures with low humidity that rarely require air conditioning; and
- Higher wildfire risk due to low moisture content in the service area and increase presence of fuel (dry vegetation).

Bear Valley Electric Service, Inc. Public Safety Power Shutoff Plan

Therefore, during the winter months as described above, the BVES distribution system is optimized for safety and reliability. Following the winter season, the system operational focus is more defensive and optimized almost entirely for fire prevention.

4.3. Daily-to-Real-time Considerations. The daily and even hourly changes in environmental and system conditions can change the risk of wildfire significantly. Therefore, the factors affecting Daily-to-Real-time considerations must be understood and be evaluated by the Operations Team to develop the appropriate risk mitigation package on a daily or even more frequently when adverse factors develop or are expected to develop. Some the factors that the Operations Team needs to consider are:

- **Forecasted and actual weather:** Sustained wind speed, wind gust strength, dryness (humidity), precipitation, etc.
- **Fuel inventory:** Buildup of ground cover vegetation, timber on the ground, thickness of forest, etc.
- **Dryness of fuel:** Dryness of dead vegetation, timber on the ground, etc.
- **System design limitations:** Installed bare conductor configuration, conventional expulsion fuses installed in the system, switches with limited protective and remote control capabilities, etc.
- **T&D equipment failure or degradation:** Protective switch failure, loss of remote connectivity with protective devices, etc.
- **Missed or delayed inspection:** Detailed inspection or patrol per GO-95 missed or delayed, GO-174 inspection missed or delayed, other inspection deemed critical missed or delayed, etc.
- **Delayed correction of fire hazard inspection discrepancies:** Correction of “must be fixed before fire season” discrepancies, GO-95 discrepancies not corrected within required periodicity, etc.
- **Operational deviations from normal lineup:** Abnormal system lineup due to planned maintenance, system upgrades, equipment degradation, etc.
- **Degradation in situational awareness:** Failure or loss of connectivity with installed weather stations, loss of NFDRS (e.g., during Federal Government shutdown), loss of remote circuit monitoring, loss of HD Alert Camera coverage, etc.
- **Resource degradation:** Insufficient line crews and/or other key operation staff, loss of utility vehicles, etc.

Daily-to-Real-time considerations always override seasonal considerations.

4.4. Pre-Planned Operational Posture. The operational actions to be taken for forecasted and actual weather, fuel inventory, dryness of fuel, and system design limitation consideration factors are easily pre-determined. Whereas the response to the rest of the Daily-to-Real-time consideration factors, must be individually evaluated to determine their impact on the overall plan. For example, if certain

Bear Valley Electric Service, Inc. Public Safety Power Shutoff Plan

weather stations suffer a failure, the Utility Manager may require the Wildfire Response Team be deployed sooner in a high wind situation.

4.4.1. Seasonal Operational Posture: The following operational actions are to be taken during fire season and are incorporated into BVES's PSPS planning. Generally, BVES considers April to October but specific dates will be recommended by the Field Operations Supervisor and approved by the Utility Manager based upon current conditions and forecasted weather outlook.

- The Radford Line is de-energized. The line will be ready for re-energization should the load demand require it, for planned maintenance or system upgrades, or for other operational reason approved by the Utility Manager. The Utility Manger will inform the President of any changes in the status of the Radford Line.
- Certain Auto-Reclosers (ARs) and Switches are placed in "Manual" (e.g., they will not shut and test upon detecting a fault). The Field Operations Supervisor develops a list of the devices to be placed in "Manual" and forwards the list to the Utility Manager and President.
- All Fuse TripSavers shall be placed in "Manual" (i.e., they will not shut and test upon detecting a fault).
- Due to reduced load in non-winter period, the Utility Engineer & Wildfire Mitigation Supervisor developed specific settings for Auto-Recloser and other protective devices in the field to enhance fire prevention. The list of affected devices will be provided to the Utility Manager and the Field Operations Supervisor. Additionally, the Field Operations Supervisor will be provided the settings that the Field Operations staff will be required to set on each device. Engineering staff will not change device settings without the Field Operations Supervisor's authorization.
- When an Auto-Recloser, Switch, or Fuse TripSaver placed in "Manual" due to the above policy trips open, the affected portions of the de-energized circuit or feeder will be patrolled prior to re-energizing them. If the cause is identified and the fire risk is "Green" or "Yellow," the Field Operations Supervisor may authorize the Line Crew to test the device once. If the device trips open again, the circuit or feeder must be thoroughly patrolled to determine the fault and ensure there is no risk of causing fire.

4.4.2. Daily-to-Real-time Operational Posture: The pre-planned operational postures provided in this section take into account the System Design Limitations factor.

BVES' forecasting framework for fire prevention measures relies on the National Fire Danger Rating System (NFDRS) and contracted meteorologist evaluation of the local forecast. The entire BVES system is in NFDRS Predictive Service Area SC10. The predictive service provides a wildfire risk forecast based on weather,

**Bear Valley Electric Service, Inc.
Public Safety Power Shutoff Plan**

on fuel build up, and fuel dryness among other factors and designates high-risk days as indicated in Table 4-1, Fuel Dryness and High-Risk Days, below:

Table 4-1: Fuel Dryness and High-Risk Days

Fuel Dryness & High Risk Days	Rating	Description
Green	Moist	Little to no risk of fires.
Yellow	Dry	Low risk of large fires in the absence of a “High Risk” event.
Brown	Very Dry	Low/moderate risk of large fires in the absence of a “High Risk” event.
Orange	High-Risk Day	At least a 20% chance of a “Large Fire” due to a combination of either “Dry” or “Very Dry” fuel dryness and a critical burn environment (e.g., Santa Ana winds).
Red	High-Risk Day	At least a 20% chance of a “Large Fire” due to a combination of either “Dry” or “Very Dry” fuel dryness and an ignition trigger (lightening).

An example of the seven-day forecast is provided below in Table 4-2, Example NFDRS Forecast:

Table 4-2: Example NFDRS Forecast

SC09-Western Mountains	Yellow	Yellow	Yellow	Yellow	Yellow	Yellow	Brown
SC10-Eastern Mountains	Brown	Brown	Brown	Brown	Brown	Brown	Brown
SC11-Southern Mountains	Yellow	Yellow	Yellow	Yellow	Yellow	Brown	Yellow

The NFDRS is generally updated 3-5 times per day. Additionally, it should be noted that it has been observed that during the Federal Government shutdowns due to budget issues, the NFDRS forecast is suspended. Therefore, during these periods, the Utility Manager must recommend measures to mitigate this degradation in situational awareness.

The contracted meteorologist integrates the NFDRS with the detailed local forecast specific to BVES’s service area and develops a risk rating as indicated below in Table 4-3, Significant Fire Potential.

**Bear Valley Electric Service, Inc.
Public Safety Power Shutoff Plan**

Table 4-3: Significant Fire Potential

Significant Fire Potential	
	Little or no risk.
	Low risk
	Moderate risk
High Risk Triggers	
	W
	L

The Field Operations Supervisor will monitor the fire risk as designated by the consultant meteorologist, the NFDRS fire danger forecast, and indications from installed weather stations, which are equipped with alarms based on actual wind speed and then direct the proper operational pre-planned response. As indicated in Table 4-4 below, “Brown”, “Red”, and “Orange” are considered elevated fire threat conditions that require the BVES system to be configured for fire prevention over reliability concerns.

**Bear Valley Electric Service, Inc.
Public Safety Power Shutoff Plan**

Table 4-4: Operational Direction Based on Wildfire Risk Forecast

Operations Pre-Planned Action	Green	Yellow	Brown	Orange	Red
Auto-Reclosers and Protective Switches with Reclosing Capability ¹	Automatic ¹	Automatic ¹	Manual (Non-Automatic)		
Patrol following circuit or feeder outage ²	No ^{2,3}	No ^{2,3}	Yes		
Fuse TripSavers ¹	Automatic ¹	Automatic	Manual (Non-Automatic)		
Radford Line Use ⁴	May be energized	May be energized	De-energize ⁵	De-energize	De-energize
Deploy Wildfire Risk Team(s) to "high risk" areas	No	No	Yes, if forecasted sustained wind or 3-second wind gusts expected to exceed 55 or actual sustained wind or 3-second wind gusts exceed 45 mph and expected to increase.		
Forward to Field Operations updated list of medical baseline customers and impacts access and functional needs population	No	No	Yes, if forecasted sustained wind or 3-second wind gusts expected to exceed 55 or actual sustained wind or 3-second wind gusts exceed 45 mph and expected to increase.		
Activate EOC	No	No	Yes, if forecasted sustained wind or 3-second wind gusts expected to exceed 55 or actual sustained wind or 3-second wind gusts exceed 45 mph and expected to increase.		
Prepare Bear Valley Power Plant for sustained operations.	No	No	Yes, if forecasted sustained wind or 3-second wind gusts expected to exceed 55 or actual sustained wind or 3-second wind gusts exceed 45 mph and expected to increase.		
Conduct switching operations to minimize impact of potential PSPS activity	No	No	Yes, if forecasted sustained wind or 3-second wind gusts expected to exceed 55 or actual sustained wind or 3-second wind gusts exceed 45 mph and expected to increase.		
Activate first responder, local government and agency, customer and community, and stakeholders PSPS communications plan	No	No	Yes, if forecasted sustained wind or 3-second wind gusts expected to exceed 55 or actual sustained wind or 3-second wind gusts exceed 45 mph and expected to increase.		
Activate Community Resource Centers	No	No	Yes, if forecasted sustained wind or 3-second wind gusts expected to exceed 55 or actual sustained wind or 3-second wind gusts exceed 45 mph and expected to increase.		
Public Safety Power Shutoff	No	No	Yes, if actual sustained wind or 3-second wind gusts exceed 55 mph. ⁶		

¹ During the non-winter months, certain devices as developed by the Field Operations Supervisor and approved by the Utility Manager will remain in Manual (Non-Automatic) for the entire period regardless of the wildfire risk.

² During the non-winter months, when an Auto-Recloser, Switch, or Fuse TripSaver that was placed in "Manual" due to the above policy trips open, the affected portions of the de-energized circuit or feeder will be patrolled prior to re-energizing them. If the cause is likely known and the fire risk is "Green" or "Yellow," the Field Operations Supervisor may authorize the Line Crew to test the device once. If the device trips open again, the circuit or feeder must be thoroughly patrolled to determine the fault and ensure there is no risk to causing fire.

³No patrol is required. Re-test allowed following check of fault indicators, SCADA, other system indicators, and reports from the field. If the re-test fails, a patrol is mandatory.

⁴ Normally only energized during winter period. If must be de-energized during winter period due to high risk conditions, and load is beyond the capability of the Lucerne supply lines plus the BVPP capacity, then reduce interruptible customer load as needed.

⁵ May be energized if forecasted and actual sustained wind and wind gust conditions are less than 40 mph and the Radford Line is required to meet load demand or the support load due to loss of other power sources or due to planned maintenance when the benefits of the maintenance will overall reduce the risk of wildfire. In all of these cases, the Utility Manger will approve energizing the Radford Line and will inform the President.

⁶The Utility Manager may initiate PSPS if in his judgement the actual conditions in the field pose a significant safety risk to the public.

4.5. Public Safety Power Shutoff (PSPS) Activation Consideration. BVES determined that specific actions per Table 4-4 above should be taken when wind gusts of 3 seconds or more exceed 55 mph and a period of high fire threat danger

Bear Valley Electric Service, Inc. Public Safety Power Shutoff Plan

exists. These conditions are often referred to as “extreme fire threat weather and conditions.”

4.5.1. Despite having a proactive and aggressive vegetation management program, vegetation may still contact power lines; for example, in high winds, branches outside the vegetation clearance zone may break and be blown onto bare conductors and/or trees outside the clearance zone may fall into bare conductors. The specific strength of trees and branches is unknown; therefore, in high winds, it is impossible to predict how every tree and branch in the service territory would be impacted. This condition plays a key role how BVES has selected its tripwire 3-second wind gust speed for PSPS and designated certain locations as “at risk” locations for proactive de-energization during extreme fire weather conditions.

4.5.2. Changes in vegetation density, circuit improvements such as covering bare wire, or other environmental factors may drive BVES to re-evaluate the designated “at risk” line sections in its system and, therefore, specific line sections may be added, removed or modified to the “at risk” list as appropriate in the future.

4.5.3. Because BVES is not able to determine the strength or health of vegetation surrounding bare conductors outside of the required vegetation clearance zones as well as other structures that may come loose and impact BVES distribution facilities. Therefore, BVES may determine a need to proactively de-energize facilities during high fire threat and high wind conditions. This would be done in close consult and coordination with local government and agencies.

4.5.4. In determining whether to invoke PSPS, BVES staff considers factors driving “extreme fire weather” and dangerous threat conditions exist including, but not limited to, the following:

- Design, strength, and other characteristics of distribution overhead facilities.
- Vegetation density.
- NFDRS 7-day fire threat outlook.
- High winds.
- Low humidity.
- National Weather Service advisories.
- Local weather forecasts and advisories.
- BVES meteorologist’s forecast.
- Observed conditions.
- Information from BVES installed weather stations.
- Real-time information from trained personnel positioned in high-risk areas.
- Input from state and local authorities and Emergency Management Personnel.
- Fire threat to electric infrastructure
- Public Safety Risk

**Bear Valley Electric Service, Inc.
Public Safety Power Shutoff Plan**

“Extreme fire weather conditions” are deemed to be forecasted or exist when the National Fire Danger Rating System forecast is “red,” “orange,” or “brown” for area SC-10, high winds (45 mph or greater) are forecasted or measured, and the BVES meteorologist forecasts high fire threat conditions.

If “extreme fire weather conditions” are forecasted or exist, BVES Staff will implement BVES Public Safety Power Shutoff Procedures at the direction of the Utility Manager.

4.5.5 BVES has identified seven sections of “at risk” areas based on the type of distribution facilities (overhead bare conductions, high voltage, etc.), tree and vegetation density, available dry fuel, and other factors. These “at risk” areas are identified on the map in Appendix A. These areas may be selectively de-energized by “opening” the ARs designated in Table 4-5, Switches to De-energize “At Risk” Areas, below.

Table 4-5: Switches to De-energize “At Risk” Areas

Circuit (AR To Be Opened)	Number of Customers
Radford 34kV	0 ¹
North Shore 4kV (Open AR 805)	1021
Erwin 4 kV (Open AR 1128)	197
Boulder 4kV (Open AR 105)	1063
Lagonita 4kV (Open AR 145)	946
Club View 4kV (Open AR 424)	740
Goldmine 4kV (Open AR 405)	950

¹Load is shifted to Shay 34kV line.

BVES expects that if a PSPS is necessary, it should be limited to one or more of these “high risk” areas. However, the Operations Team must monitor the entire service area and invoke PSPS as a measure of last resort on any BVES circuit when condition warrant such action.

4.6. Restoration from PSPS. When wind speeds in the affected area where PSPS was invoked calm below 50 mph for a minimum period of 20 minutes, crews may assess if the fire weather conditions have subsided to “safe levels” to begin the restoration of de-energized circuits. However, the crews may extend the calm period beyond 20 minutes, if they determine further gusts of greater than 50 mph are likely based on their direct observation of local conditions or forecasts indicate a high probability of winds picking up to greater than 50 mph. Crews should communicate with the Field Operations Supervisor prior to assessing the situation as “safe levels” so that an evaluation of actual conditions in the field may be merged with the latest forecasted information. Restoration activities include:

- Validating that the extreme fire weather conditions have subsided to safe levels.
- Conducting field inspections and patrols of facilities that were de-energized.

**Bear Valley Electric Service, Inc.
Public Safety Power Shutoff Plan**

- Repair of any identified immediate hazards (Level 1 inspection conditions)
- Re-energization of inspected circuits.

5. BVES PSPS Procedures

5.1. Emergency Disaster and Response Plan. Section 4 to the BVES Emergency Response and Disaster Plan (EDRP) explains the BVES system sources of power and actions to be taken when there is partial or complete loss of sources of power. Appendix B to the EDRP provides a graphic showing the sources of power available to the BVES system including the SCE supply lines and their capacity. This PSPS Plan provides supplemental guidance in the case of an SCE PSPS event leading to a complete or partial loss of all SCE lines in order to avoid a “black start” of the Bear Valley Power Plant (BVPP). Once PSPS is implemented, outages shall be managed using the guidance of the BVES EDRP and the supplemental guidance of this procedure.

5.2. PSPS Phases. In *Table 5-1, PSPS Phases for PSPS Procedures*, BVES provides a time-line summary of actions to be taken for PSPS on BVES-owned bare wire overhead power lines affecting some or all of the BVES service area or a SCE-directed PSPS affecting the BVES service area.

It should be noted that weather changes can be sudden and the target timelines may end up being shorter than indicated in Table 5-1. PSPS actions are driven by forecasts and actual conditions in the field. The specific phases are:

- **1. Preparatory Phase:** Conducted annually well before extreme fire threat conditions are expected; or when lessons learned or other conditions warrant updating plans, training, or outreach. This involves the developing of communication and notification plans jointly with stakeholders such as CalOES, county and local governments, independent living centers, and representatives of people/communities with AFN. Review and revise plans for establishing CRC(s). BVES currently holds PSPS exercises to further develop their staff to be readily available to properly activate a PSPS event. For further detail regarding BVES Functional Exercise: Bear Valley Wildfire Threat Situation Manual in Appendix F.
- **2. Warning Phase:** Approximately 4-7 days prior to forecasted extreme fire threat weather and conditions, the warning phase involves assessing the whether activating a PSPS may be warranted. If a PSPS is possible or likely, BVES notifies local government, agencies, partner organizations, and customers. This phase includes various levels of notification at the 4-7 days ahead, 4 days ahead, 2-3 days ahead, 1-2 days ahead, and 1-4 hours ahead (PSPS imminent) points in the preparatory process.
- **3. Implementation Phase:** De-energization actions are taken for “at-risk” areas due to observed extreme fire threat weather and conditions or imminent or active SCE-directed PSPS of SCE supply lines to BVES service area.
- **4. Restoration Phase:** This phase enables the safe restoration of power to de-energized circuits following verification that actual extreme fire threat weather and

Bear Valley Electric Service, Inc. Public Safety Power Shutoff Plan

conditions have subsided and/or restoring SCE supply lines when they are re-energized. All de-energized lines must be patrol-inspected for vegetation and equipment hazards and all Level 1 conditions must be remediated before restoring power.

- **5. Reporting and Lessons Learned Phase:** Documenting and reporting to Safety Enforcement Division required information on the PSPS event and capturing lessons learned to ensure future PSPS events benefit from an understanding of what worked and what did not work in previous PSPS events.

5.3. PSPS Exercises. BVES conducts at least one tabletop and one functional simulation exercise annually. These exercises involve participating stakeholders from the Big Bear community and be coordinated with CPUC Cal Fire, Cal OES, communication providers, AFN representatives, and other public safety partners. Additionally, BVES will coordinate with these stakeholders to develop and plan the exercises. The exercises seek to prepare BVES and its community partners for a PSPS and enhance their performance, communication protocols, notification practices, and restoration procedures and test the functionality of the plan to the extent practicable.

BVES will keep detailed records of these plans and submit reports of these exercises to the CPUC as required. BVES will review the exercises to identify strengths and weaknesses of BVES actions, and seek to incorporate lessons learned into this Plan and other associated documentation, as appropriate.

Bear Valley Electric Service, Inc. Public Safety Power Shutoff Plan

Table 5-1: PSPS Phases for PSPS Procedures

Phase	Timeframe	Internal Staff Actions	External Communications and Notifications
<p>Preparatory</p>	<p>Pre-fire season.</p> <ul style="list-style-type: none"> • Conducted annually well before extreme fire threat conditions are expected; or • When lessons learned or other conditions warrant updating plans, training, and/or outreach. 	<p>Planning and Training</p> <ul style="list-style-type: none"> • Managers review and update plans and procedures. • Managers ensure staff are trained on PSPS procedures as applicable. • Reach out to media and community-based organizations to ensure consistent awareness of and availability to third-parties of all messaging and map data, including application programming interfaces that are used for de-energization events. • Customer Service Department will ensure all equipment and supplies for the CRC are functional and readily available. • Coordinate with stakeholders including CPUC, CalFire, CalOES, communications providers, representatives of people/communities with access and functional needs, and other public safety partners to plan de-energization simulation exercises throughout the utility service territories in the areas with the highest historical and forecasted risk for de-energization in advance of fire season. 	<p>Local Government, Agencies, and Partner Organizations:</p> <ul style="list-style-type: none"> • Provide copy of plan and solicit comments. • Incorporate comments as deemed appropriate. • Conduct meetings to discuss procedures. • Update primary and secondary contacts for PSPS communications. • Advisory Board: May consist of public safety partners, communications and water service providers, local and tribal government officials, business groups, non-profits, representatives of people/communities with access and functional needs and vulnerable communities, and academic organizations. <p>Customer Outreach and Education:</p> <ul style="list-style-type: none"> • Post PSPS information and list of PSPS POCs on BVES's website and social media. • Include PSPS information in periodic customer newsletter. • Conduct public workshops. • Provide PSPS notifications via email, telephone calls, Interactive Voice Response (IVR) proactive calling system, and two-way text messaging.
<p>Warning</p>	<p>4-7 Days Ahead</p> <p>When forecasts indicate extreme fire threat weather and conditions may occur</p>	<p>Operations & Planning:</p> <ul style="list-style-type: none"> • Evaluate system for possible impact area(s) and ensure resources ready to support PSPS. • Contact SCE Staff and closely follow status of SCE supply lines (Doble, Cushenberry, and Bear Valley/Radford). • Review operational and maintenance status of sub-transmission system. • Review operational and maintenance status of Bear Valley Power Plant (BVPP). • Review operational and maintenance status of Radford Line. • Consider conducting patrol of Radford Line. • Review National Weather Service (NWS) forecasts, National Fire Danger Rating System (NFDRS) 7-day forecast, and weather and threat assessments from contracted meteorology consultant. • Notify meteorology consultant to provide more frequent forecasts. • Alert customer service to possibility of PSPS. <p>Customer Service:</p>	<p>None</p>

Bear Valley Electric Service, Inc. Public Safety Power Shutoff Plan

		<ul style="list-style-type: none"> Review and edit as applicable templates for PSPS events and the anticipated impacts on BVES Customers. Staff drafts notices to Public Affairs consultant for review, significant changes to templates are made. Create warning notifications to customers via email, telephone calls, IVR proactive calling system, and two-way text messaging. 	
<p>Warning</p>	<p>4 Days Ahead if continuing and consistent forecasts of extreme fire threat weather and conditions</p>	<p>Operations & Planning:</p> <ul style="list-style-type: none"> Closely monitor fire weather alerts from various sources with the goal of refining the forecast (NWS, NFDRS, and meteorology consultant weather and threat assessments). Continue contacts with SCE Staff and closely follow status of SCE supply lines. If any SCE lines are under "PSPS Consideration," take actions per Table 4-2, BVES Action for SCE Lines Under PSPS Consideration. Ensure sub-transmission system is in most reliable condition. Defer or secure from planned maintenance. Ensure BVPP ready to operate. Defer or secure from planned maintenance. Alert Energy Resource Department of possible extended BVPP operations. Consider energizing Radford Line, if deemed necessary for reliability. Closely coordinate with SCE Staff regarding the PSPS status of SCE supply lines. Ensure BVES installed weather stations fully operational. Ensure circuit load monitoring equipment fully operational. Place BVES staff incident responders on alert. <p>Customer Service:</p> <ul style="list-style-type: none"> Finalize "4 Day Alert" email regarding continuing and consistent forecasted extreme fire threat weather and conditions, which may lead to possible BVES directed PSPS and/or SCE directed PSPS. <ul style="list-style-type: none"> provide anticipated impacts on BVES Customers and direction of event. Obtain President's approval to release. Issue a press release to local media (newspaper and radio) and post notification on website. Create warning notifications to customers via email, telephone calls, (IVR) proactive calling system, and two-way text messaging. 	<p>Local Government, Agencies, and Partner Organizations:</p> <ul style="list-style-type: none"> Email "4 Day Alert" to local government, agencies, and partner organizations primary and secondary points of contact. Alert the emergency management community, first responders and local government first.

Bear Valley Electric Service, Inc. Public Safety Power Shutoff Plan

<p>Warning</p>	<p>2-3 Days Ahead Extreme fire threat weather and conditions forecasted with increasing confidence</p>	<p>Operations & Planning:</p> <ul style="list-style-type: none"> Continue to closely monitor fire weather alerts. Prepare staff rotation plans to support continuous field crew operations, BVPP operations, dispatch, and customer service. Evaluate need for additional resources from mutual aid agreements (CUEA and MMAA) and contracted services. Alert additional resources points of contact. Set up processes to frequently monitor BVES installed weather stations. Review pre-approved field Switching Orders against current system line-up and make changes as applicable with Field Operations Supervisor's approval. Keep Customer Service informed of latest forecast to ensure accurate communications with stakeholders. Closely coordinate with SCE Staff regarding SCE supply lines to the BVES service area and take actions per Table 4-2, BVES Action for SCE Lines Under PPS Watch, as applicable. <p>Customer Service:</p> <ul style="list-style-type: none"> Finalize "2-3-Day Notice" regarding forecasted extreme fire threat weather and conditions, about possible BVES directed PPS and/or SCE directed PPS. <ul style="list-style-type: none"> Provide anticipated impacts on BVES Customers and direction of event. Obtain President's approval to release. Issue a press release to local media (newspaper and radio) and post notification on website. Create warning notifications to customers via email, telephone calls, (IVR) proactive calling system, and two-way text messaging. 	<p>Local Government, Agencies, and Partner Organizations:</p> <ul style="list-style-type: none"> Email "2-3 Day Notice" to local government, agencies, and partner organizations primary and secondary points of contact. Coordinate with the emergency management community, first responders and local government first. Encourage widest dissemination of this information. <p>Customer Outreach:</p> <ul style="list-style-type: none"> Post "2-3 Day Notice" on BVES website and social media. Issue "2-3 Day Notice" press release for local media. Send out "2-3 Day Notice" via IVR. Send out "2-3 Day Notice" via Text Send out "2-3 day Notice" via Email
<p>Warning</p>	<p>1-2 Days Ahead Extreme fire threat weather and conditions forecasted with high degree of confidence</p>	<p>Operations & Planning:</p> <ul style="list-style-type: none"> Continue to closely monitor fire weather alerts and observed conditions from various sources with the goal of refining the forecast. If needed, request additional resources from mutual aid agreements (CUEA and MMAA) and contracted services). Keep Customer Service informed of latest forecast to ensure accurate communications with stakeholders. <ul style="list-style-type: none"> Set up CRC and conduct a mock SOE scenario to include testing of all equipment and needed supplies. 	<p>Local Government, Agencies, and Partner Organizations:</p> <ul style="list-style-type: none"> Email "1-2 Day Notice" to local government, agencies, and partner organizations primary and secondary points of contact. Coordinate with the emergency management community, first responders and local government first. Encourage widest dissemination of this information. <p>Customer Outreach:</p> <ul style="list-style-type: none"> Post "1-2 Day Notice" on BVES website and social media. Issue "1-2 Day Notice" press release for local media.

Bear Valley Electric Service, Inc. Public Safety Power Shutoff Plan

		<ul style="list-style-type: none"> ○ Purchase non-perishable food items to provide to our customers including bottled water. ● Continue to closely coordinate with SCE Staff regarding SCE supply lines to the BVES service area and take actions per Table 4-2, BVES Action for SCE Lines Under PSPS Watch, as applicable. ● When directed by the Utility Manager: <ul style="list-style-type: none"> ○ Staff incident responders called in. ○ Incident dispatch established. ○ Field Crews dispatched to monitor various actual field conditions for extreme fire weather and other dangerous conditions throughout the service area and “at risk” areas. ○ Implement BVES EDRP including staffing the EOC as applicable. <p>Customer Service:</p> <ul style="list-style-type: none"> ● Finalize “1-2 Day Notice” regarding imminent extreme fire threat weather and conditions, which may result in BVES directed PSPS and/or SCE directed PSPS. <ul style="list-style-type: none"> - Provide anticipated impacts on BVES Customers and duration of event. - Obtain President’s approval to release. ● Identify medical baseline and AFN customers that may lose power as result of PSPS. ● Issue a press release to local media (newspaper and radio) and post notification on website. ● Issue warning notifications to customers via email, telephone calls, (IVR) proactive calling system, and two-way text messaging 	<ul style="list-style-type: none"> ● Send out “1-2 Day Notice” via IVR. ● Send out “1-2 Day Notice” via Text ● Activate “1-2 day Notice” via Email
<p>Warning</p>	<p>1-4 Hours Ahead When De-Energization Imminent. Extreme fire threat weather and conditions validated by field resources</p>	<p>Operations & Planning:</p> <ul style="list-style-type: none"> ● Closely coordinate with SCE regarding SCE-directed PSPS affecting SCE supply lines into BVES service area and take applicable actions per Table 4-3, BVES Action for SCE Lines De-energized Due to PSPS. ● Frequently monitor BVES installed weather stations. ● Patrol throughout service area especially “at risk” areas to monitor various actual field conditions for extreme fire weather and other dangerous conditions. ● Monitor local wind gusts in “at-risk” areas. <p>Customer Service:</p>	<p>Local Government, Agencies, and Partner Organizations:</p> <ul style="list-style-type: none"> ● Email “De-energization Imminent Notice” to local government, agencies, and partner organizations. ● Coordinate with the emergency management community, first responders, and local government in managing outages due to PSPS. ● Provide list of customers that may be without power and listed as medical baseline customers to Sheriff Department and Fire Department. <p>Customer Outreach:</p>

Bear Valley Electric Service, Inc. Public Safety Power Shutoff Plan

		<ul style="list-style-type: none"> Finalize “De-energization Imminent Notice” regarding imminent PSPS de-energization(s) directed by BVES or SCE <ul style="list-style-type: none"> - Include areas to be de-energized, number of customers without power, and best estimated time to restore (ETR). - Obtain President’s approval to release. Identify medical baseline customers that may lose power. Identify AFN customers that may lose power as result of PSPS Issue a press release to local media and post notification on website. Issue warning notifications to customers via email, telephone calls, (IVR) proactive calling system, and two-way text messaging. 	<ul style="list-style-type: none"> Post “De-energization Imminent Notice” on BVES website and social media. Issue “De-energization Imminent Notice” press releases for local media. Send “De-energization Imminent Notice” via IVR. Send “De-energization Imminent Notice Day Notice” via Text Send “De-energization Imminent Notice” via Email
<p>Implementation</p>	<p>During de-energization event. A PSPS event is initiated.</p>	<p>Operations & Planning:</p> <ul style="list-style-type: none"> Closely coordinate with SCE regarding SCE-directed PSPS affecting SCE supply lines into BVES service area and take applicable actions per Table 4-3, BVES Action for SCE Lines De-energized Due to PSPS. Frequently monitor BVES installed weather stations. Patrol throughout service area especially “at risk” areas to monitor field conditions for extreme fire weather and dangerous conditions. Monitor local wind gusts. De-energize circuits in “at risk” areas as wind gusts reach threshold for de-energization as designated by Field Operations Supervisor. Field Crews may de-energize additional power lines they evaluate as posing a public safety hazard or as directed by Field Operations Supervisor. Prepare GO-166 major outage and ESRB-8 notifications as applicable. <p>Customer Service:</p> <ul style="list-style-type: none"> Finalize “De-energization Notice” regarding extreme fire threat conditions and actual PSPS de-energization(s) directed by BVES and/or SCE. Must include: <ul style="list-style-type: none"> - areas de-energized, - number of customers without power, and best estimated time to restore (ETR). Obtain President’s approval to release. Issue “De-energization Updates” providing status changes such as when the number of customers without 	<p>Local Government, Agencies, and Partner Organizations:</p> <ul style="list-style-type: none"> Email “De-energization Notice” to local government, agencies, and partner organizations. Coordinate with the emergency management community, first responders, and local government in managing outages due to PSPS. Send “De-energization Updates” on the PSPS. Provide list of customers without power and listed as medical baseline and AFN customers to Sheriff Department and Fire Department. Encourage widest dissemination of this information. Notify California Public Utilities Commission (CPUC) and Warning Center at the Office of Emergency Services San Bernardino within one hour of shutting off the power if the outage meets the major outage criteria of GO-166. Notify President Safety Enforcement Division (SED), CPUC within twelve hours of the power being Shutoff per ESRB-8. <p>Customer Outreach:</p> <ul style="list-style-type: none"> Post “De-energization Notice” and “De-energization Updates” (when warranted) on BVES website and social media. Issue “De-energization Notice” and “De-energization Updates” (when warranted) press releases for local media. Send “De-energization Notice” and “De-energization Updates” (when warranted) via IVR. Send “De-energization Notice” and “De-energization Updates” (when warranted) via Text

Bear Valley Electric Service, Inc. Public Safety Power Shutoff Plan

		<p>power or ETR(s) change significantly. Obtain President's approval to release.</p> <ul style="list-style-type: none"> Identify lists of medical baseline customers without power. Issue a press release to local media (newspaper and radio) and post notification on website. Issue warning notifications to customers via email, telephone calls, (IVR) proactive calling system, and two-way text messaging. 	<ul style="list-style-type: none"> Activate "De-energization Notice" and "De-energization Updates" (when warranted) via Email Communicate with emergency services regarding AFN and medical baseline customers.
<p>Restoration</p>	<p>Re-energization Extreme fire conditions subside to safe levels as validated by field conditions</p>	<p>Operations & Planning:</p> <ul style="list-style-type: none"> Validate extreme fire weather conditions have subsided to safe levels as designated by the Field Operations Supervisor and report these conditions to Dispatch. Conduct and patrols of de-energized facilities. Restore power to affected circuits following satisfactory completion of field inspections and patrols. Conduct switching operations as directed by Field Operations Supervisor to restore systems normal as SCE restores supply lines, as applicable. <p>Customer Service:</p> <ul style="list-style-type: none"> Finalize "Intent to Restore" notice to include ETRs and obtain President's approval to release. Finalize "Restoration Complete" notice to be issued when power is fully restored and obtain President's approval to release. Breakdown of CRC including removal/storage of all equipment and supplies. 	<p>Local Government, Agencies, and Partner Organizations:</p> <ul style="list-style-type: none"> Send "Intent to Restore" notice to local government, agencies, and partner organizations. Encourage widest dissemination of this information. Coordinate with the emergency management community, first responders, and local government in managing restorations. Send "Restoration Complete" notice to local government, agencies, and partner organizations once power is fully restored or an update if restoration is delayed. <p>Customer Outreach:</p> <ul style="list-style-type: none"> Post "Intent to Restore" notice on BVES website and social media. Issue "Intent to Restore" press release for local media. Send "Intent to Restore" notice via IVR. Send "Intent to Restore" notice via Text Send "Intent to Restore" notice via Email Post "Restoration Complete" notice on BVES website and social media once power is fully restored or an update if restoration is delayed. Issue "Restoration Complete" press release for local media once power is fully restored or an update if restoration is delayed. Send "Restoration Complete" notice via IVR once power is fully restored or an update if restoration is delayed. Send "Restoration Complete" notice via Text once power is fully restored or an update if restoration is delayed. Send "Restoration Complete" notice via Email once power is fully restored or an update if restoration is delayed.
<p>Reporting and Lessons Learned</p>	<p>Post Event</p>	<p>Operations & Planning:</p> <ul style="list-style-type: none"> Conduct lessons learned with applicable staff. Utility Manager will include Customer Service and solicit input 	<p>CPUC Safety Enforcement Division:</p> <ul style="list-style-type: none"> File a report (written) to President of SED no later than 10 business days after the Shutoff event ends per ESRB-8.

**Bear Valley Electric Service, Inc.
Public Safety Power Shutoff Plan**

		<p>from Local Government, Agencies, and Partner Organizations.</p> <ul style="list-style-type: none"> • Update plan and procedures per the lessons learned, if necessary. • Prepare PSPS Post Event Report required by ESRB-8 and forward to President and Manager Regulatory Affairs for approval. 	
--	--	---	--

**Bear Valley Electric Service, Inc.
Public Safety Power Shutoff Plan**

5.4. SCE-Directed PSPS Procedures. Close coordination with SCE is essential to mitigating the impact of any SCE directed PSPS event that would result in a complete or partial loss of SCE supply lines. The following preparatory coordination steps are established:

- Each year, before fire season, BVES Management Team engages SCE Management on coordination for potential and actual PSPS events.
- BVES Management Team updates contact information with the SCE Key Account Manager for the BVES account, upon any change.
- BVES Field Operations staff updates contact information with the SCE Lugo and Colton Control Stations which have direct operational control over the SCE supply lines to BVES.

When PSPS events are forecasted, the SCE Key Account Manager will coordinate with BVES Management and the SCE Lugo and Colton Control Stations will coordinate directly with the designated BVES Field Operations Team, until the event is complete or canceled.

Table 5-2, BVES Action for SCE Lines Under PSPS Consideration, provides procedures to implement to best prepare the BVES system for a complete or partial loss of SCE supply lines.

Bear Valley Electric Service, Inc. Public Safety Power Shutoff Plan

Table 5-2: BVES Action for SCE Lines Under PSPS Consideration	
Condition	BVES Action
SCE places Doble or Cushenberry Line under PSPS Consideration.	<ol style="list-style-type: none"> 1. Notify key internal staff and brief Field Operations staff on condition for situational awareness. 2. Operations & Planning Manager evaluates energizing Radford Line for improved reliability.
SCE places Bear Valley Line under PSPS Consideration.	<ol style="list-style-type: none"> 1. Notify key internal staff and brief Field Operations staff on conditions for situational awareness. 2. If Radford is energized, shift loads to Shay Line.
SCE places Doble and Cushenberry Lines under PSPS Consideration.	<ol style="list-style-type: none"> 1. Notify key internal staff and brief Field Operations staff on condition for situational awareness. 2. Energize the Radford Line. 3. Prepare for potentially losing all SCE supply lines from Lucerne. 4. Prepare for sustained BVPP operations and rolling blackouts. 5. Evaluate distribution circuit loads.
SCE places Doble or Cushenberry, and Bear Valley Lines under PSPS Consideration	<ol style="list-style-type: none"> 1. Notify key internal staff and brief Field Operations staff on condition for situational awareness. 2. Prepare for potentially losing all SCE supply lines from Lucerne. 3. Prepare for sustained BVPP operations and rolling blackouts. 4. Evaluate distribution circuit loads.
SCE places Doble, Cushenberry, and Bear Valley Lines under PSPS Consideration	<ol style="list-style-type: none"> 1. Notify key internal staff and brief Field Operations staff on condition for situational awareness. 2. Prepare for potentially losing all SCE supply lines into BVES service area. 3. Prepare for sustained BVPP operations and rolling blackouts. 4. Evaluate distribution circuit loads.

Table 5-3, BVES Action for SCE Lines De-energized Due to PSPS, provides procedures to use in the event of a partial or complete loss of SCE supply lines. These procedures are based on procedures in the BVES EDRP and take into account that BVES will closely coordinate with SCE Staff as follows:

- SCE should provide warnings of impending PSPS on the SCE lines about 2 days prior to the event.
- SCE should provide updates to the status of the lines under PSPS consideration.
- SCE should notify BVES at least 4 hours prior to de-energizing any SCE supply lines to BVES service area.

These timely notifications will allow BVES to take preparatory action to shed load to within the expected capacity of its remaining sources of power and allow BVES to avoid a “blackstart” on the BVPP. Therefore, the procedures of Table 5-3 should be followed during PSPS event. However, if there is a sudden complete or partial loss of SCE supply lines, the procedures in Section 4 of the BVES EDRP are more appropriate and should be followed as directed by the Utility Manager.

Bear Valley Electric Service, Inc. Public Safety Power Shutoff Plan

Table 5-3: BVES Action for SCE Lines De-energized Due to PSPS

Condition	BVES Action
SCE De-energizes Doble or Cushenberry Line for PSPS.	<ol style="list-style-type: none"> 1. Notify key staff and brief Field Operations staff on condition for situational awareness. 2. Energize Radford Line if needed to meet load demand and reliability. 3. Startup the BVPP as needed to meet load demand. 4. No reduction on load necessary, since the Doble and Cushenberry are capable of carrying the other's load. 5. Implement BVES EDRPn for a partial loss of SCE supply lines.
SCE De-energizes Bear Valley Line for PSPS.	<ol style="list-style-type: none"> 1. Notify key staff and brief Field Operations staff on condition for situational awareness. 2. If Radford is energized, shift loads to Shay Line prior to de-energizing for PSPS. This should be done about 4 hours prior to the SCE de-energizing the line. 3. If needed, start up the BVPP to meet load demand. 4. If needed, instruct interruptible customers (Bear Mountain Resorts) to reduce load as needed to meet load demand. 5. Implement BVES EDRP for a partial loss of SCE supply lines.
SCE De-energizes Doble or Cushenberry and Bear Valley Lines for PSPS.	<ol style="list-style-type: none"> 1. Notify key staff and brief Field Operations staff on condition for situational awareness. 2. Since the Doble and Cushenberry are capable of carrying the other's load, follow the procedure for "SCE De-energizes Bear Valley Line for PSPS" above. 3. Prepare for potentially losing all SCE supply lines into BVES service area. 4. Prepare for sustained BVPP operations and rolling blackouts. 5. Evaluate distribution circuit loads. 6. Implement BVES EDRP for a partial loss of SCE supply lines.
SCE De-energizes Doble and Cushenberry Lines for PSPS.	<ol style="list-style-type: none"> 1. Notify key staff and brief Field Operations staff on condition for situational awareness. 2. Energize the Radford Line. 3. Four hours prior to SCE de-energizing the lines, per the Field Operations Supervisor's direction, shift as much of the load to the BVPP and Radford Line as follows: <ol style="list-style-type: none"> a. Open the Shay and Baldwin ARs. b. "Express" the Radford Line to Meadow Substation without overloading the Radford Line per Field Operations' switching order. c. Start BVPP, place enginators on-line and increase load to within the combined capacity of the BVPP and Radford Line. d. Implement BVES EDRP for sustained loss of SCE supplies from Lucerne including "rolling blackout" procedures. 4. Prepare for sustained BVPP operations and rolling blackouts. 5. Frequently monitor distribution circuit loads.

Bear Valley Electric Service, Inc. Public Safety Power Shutoff Plan

Table 5-3: BVES Action for SCE Lines De-energized Due to PSPS

Condition	BVES Action
SCE de-energizes Doble, Cushenberry, <u>and</u> Bear Valley Lines for PSPS.	<ol style="list-style-type: none"> 1. Notify key staff and brief Field Operations staff on condition for situational awareness. 2. If the Radford Line is energized, shift loads to the Shay Line. 3. Four hours prior to SCE de-energizing the lines, per the Field Operations Supervisor's direction, perform the following: <ol style="list-style-type: none"> a. Start up all BVPP engines. b. Reduce system load to within the capacity of the BVPP by isolating distribution circuits as directed by the Field Operations Supervisor. c. Once system load is matched with the BVPP capacity, open the Shay and Baldwin ARs. d. Implement BVES EDRP for sustained loss of all SCE supply lines including "rolling blackout" procedures.

**Bear Valley Electric Service, Inc.
Public Safety Power Shutoff Plan**

6. PSPS Public Outreach and Communications

6.1. Importance of Public Outreach. Due to the significant impact a PSPS event may have on the community and customers, early and accurate communications must be conducted throughout the PSPS event in coordination with local government, agencies, partner organizations (including emergency management community and first responders, CALOES, local governments, independent living centers, and representatives of people/communities with AFN), and customers. Effective communications are key to allow stakeholders to take preparatory actions to mitigate the impact of a PSPS event. It is also understood the importance of hosting community workshops to allow for community members to understand the process leading to a PSPS event. BVES hosts exercises and workshops with community to better prepare customers for a PSPS event. BVES also conducts public safety briefings with the CPUC related to de-energization events, including exercises.

BVES retains ultimate responsibility for notification and communication throughout a PSPS event.

6.2. EDRP Communications Procedures. During the time period leading up to the PSPS event, during a PSPS event, and during the restoration period from a PSPS event, the Emergency Response Communications Plan of the EDRP shall be implemented as applicable in conjunction with this plan.

To accomplish this, the BVES shall:

- Develop and use a common nomenclature that integrates with existing state and local emergency response communication messaging and outreach and is aligned with the California Alert and Warning Guidelines.
- Develop multimodal notification and communication protocols and systems to reach customers no matter where the customer is located and deliver messaging in a clear and understandable manner.
- Communicate to customers in different languages and in a way that addresses different access and functional needs using multiple modes/channels of communication.
- Establish a Community Resource Center and work with local organizations to promote community safety (see Appendix C Community Resource Center Protocol).

6.3. PSPS Planned Communications. Table 6-1, BVES PSPS Communications Template Listing, is to be prepared by the Customer Program Specialist and preapproved by the President ahead of an expected PSPS event such to allow BVES staff to quickly initiate effective communications with stakeholders during a PSPS event. The templates are designed to provide a standard “fill in the blank” notice that may be amended depending on the specific situation as applicable. Templates shall initially be reviewed and edited as applicable by BVES’s public relations contractor. Additionally, the templates shall be reviewed annually and/or when lessons learned indicate changes to the templates are appropriate.

Bear Valley Electric Service, Inc. Public Safety Power Shutoff Plan

Table 6-1: BVES PSPS Communications Template Listing

Template	Content	Media	Recipients
4-Day Alert	Provides notice of continuing and consistent forecasted extreme fire threat weather and conditions, which may lead to possible BVES-directed or SCE-directed PSPS. Also, provides anticipated impacts on BVES customers and direction of event.	<ul style="list-style-type: none"> • Email 	<ul style="list-style-type: none"> • Local Government, Agencies, and Partner Organizations (Includes emergency management community and first responders, CALOES, county and local governments, independent living centers, and representatives of people/communities with access and function needs), and customers (including medical baseline and behind-the-meter).
2-3 Day Notice	Provides notice of forecasted extreme fire threat weather and conditions, which may lead to BVES-directed or SCE-directed PSPS. Provides anticipated impacts on BVES customers and duration of event.	<ul style="list-style-type: none"> • Email • BVES Website • Social Media • Press Release • IVR Message • Text Message 	<ul style="list-style-type: none"> • Local Government, Agencies, and Partner Organizations (Includes emergency management community and first responders, CALOES, county and local governments, independent living centers, and representatives of people/communities with access and function needs) and customers (including medical baseline and behind-the-meter).
1-2 Day Notice	Provides notice regarding imminent extreme fire threat weather and conditions, which may result in BVES-directed or SCE-directed PSPS. Also, provides anticipated impacts on BVES Customers and duration of event.	<ul style="list-style-type: none"> • Email • BVES Website • Social Media • Press Release • IVR Message • Text Message 	<ul style="list-style-type: none"> • Local Government, Agencies, and Partner Organizations (Includes emergency management community and first responders, CALOES, county and local governments, independent living centers, and representatives of people/communities with access and function needs) and customers (including medical baseline and behind-the-meter).

Bear Valley Electric Service, Inc. Public Safety Power Shutoff Plan

Table 6-1: BVES PSPS Communications Template Listing

Template	Content	Media	Recipients
De-energization Imminent Notice	Provides notice that BVES-directed or SCE-directed PSPS is imminent (within 1-4 hours) based on extreme fire threat weather and conditions. Also, provides anticipated impacts on BVES customers and duration of event.	<ul style="list-style-type: none"> • Email • BVES Website • Social Media • Press Release • IVR Message • Text Message 	<ul style="list-style-type: none"> • Local Government, Agencies, and Partner Organizations (Includes emergency management community and first responders, CALOES, county and local governments, independent living centers, and representatives of people/communities with access and function needs) and customers (including medical baseline and behind-the-meter).
De-energization Notice	Provides notice of extreme fire threat weather and conditions and PSPS de-energization(s) and includes areas de-energized, number of customers without power, and best estimated time to restore (ETR).	<ul style="list-style-type: none"> • Email • BVES Website • Social Media • Press Release • IVR Message • Text Message 	<ul style="list-style-type: none"> • Local Government, Agencies, and Partner Organizations (Includes emergency management community and first responders, CALOES, county and local governments, independent living centers, and representatives of people/communities with access and function needs) and customers (including medical baseline and behind-the-meter).
De-energization Updates	During de-energization event, provides notice of changes such as when the number of customers without power or ETR changes significantly.	<ul style="list-style-type: none"> • Email • BVES Website • Social Media • Press Release • IVR Message • Text Message 	<ul style="list-style-type: none"> • Local Government, Agencies, and Partner Organizations (Includes emergency management community and first responders, CALOES, county and local governments, independent living centers, and representatives of people/communities with access and function needs) and customers (including medical baseline and behind-the-meter).

Bear Valley Electric Service, Inc. Public Safety Power Shutoff Plan

Table 6-1: BVES PSPS Communications Template Listing

Template	Content	Media	Recipients
Intent to Restore	Provides notice that extreme fire threat weather and conditions have subsided, BVES crews are performing post-PSPS restoration inspections, and ETR.	<ul style="list-style-type: none"> • Email • BVES Website • Social Media • Press Release • IVR Message • Text Message 	<ul style="list-style-type: none"> • Local Government, Agencies, and Partner Organizations (Includes emergency management community and first responders, CALOES, county and local governments, independent living centers, and representatives of people/communities with access and function needs) and customers (including medical baseline and behind-the-meter).
Restoration Complete	Provides notice that power is fully restored.	<ul style="list-style-type: none"> • Email • BVES Website • Social Media • Press Release • IVR Message • Text Message 	<ul style="list-style-type: none"> • Local Government, Agencies, and Partner Organizations (Includes emergency management community and first responders, CALOES, county and local governments, independent living centers, and representatives of people/communities with access and function needs) and customers (including medical baseline and behind-the-meter).

6.4. Critical Facilities and Infrastructure. The term ‘critical facilities’ and ‘critical infrastructure’ refers to facilities and infrastructure essential to the public safety and that require additional consideration for resiliency during PSPS events. The following provides guidance on what constitutes critical facilities and infrastructure:

6.4.1. Emergency Services Sector

- Police Stations
- Fire Stations
- Emergency Operations Centers

6.4.2. Government Facilities Sector

- Schools
- Jails and prisons

6.4.3. Healthcare and Public Health Sector

- Public Health Departments
- Medical facilities, including hospitals, skilled nursing facilities, nursing homes, blood banks, health care facilities, dialysis centers and hospice facilities

Bear Valley Electric Service, Inc. Public Safety Power Shutoff Plan

6.4.4. Energy Sector: Public and private utility facilities vital to maintaining or restoring normal service, including, but not limited to, interconnected publicly-owned utilities.

6.4.5. Water and Wastewater Systems Sector: Facilities associated with the provision of drinking water or processing of wastewater including facilities used to pump, divert, transport, store, treat and deliver water or wastewater.

6.4.6. Communications Sector: Communication carrier infrastructure including selective routers, central offices, head ends, cellular switches, remote terminals and cellular sites.

6.4.7. Chemical Sector: Facilities associated with the provision of manufacturing, maintaining, or distributing hazardous materials and chemicals.

6.5. Key Partners. The follow provides the list of pertinent Local Government, Agencies, and Partner Organizations to BVES PSPS notifications. This list overlaps with the list of what is considered critical facilities and infrastructure:

- Local officials (City of Big Bear Lake and San Bernardino County)
- State officials (normally CPUC Energy Division and Safety Enforcement Division)
- San Bernardino County Office of Emergency Services (County OES)
- Big Bear Fire Department
- California Department of Forestry and Fire Protection (CAL FIRE)
- U.S. Forest Service
- San Bernardino County Sheriff's Department Big Bear Lake Patrol Station
- California Highway Patrol (CHP) Arrowhead Area
- California Department of Transportation (Caltrans)
- Big Bear Area Regional Wastewater Agency (BBARWA)
- Big Bear City Community Services District (CSD)
- Big Bear Lake Water Department (DWP)
- Big Bear Municipal Water District (MWD)
- Southwest Gas Corporation
- Bear Valley Community Hospital
- Bear Valley Unified School District
- Big Bear Chamber of Commerce
- Big Bear Airport District
- Big Bear Mountain Resorts
- Spectrum Communications
- Cell tower providers

Critical Facilities and Infrastructure Plan. For further detail regarding BVES' Critical Facilities and Infrastructure Plan processes and procedures.

7 Compliance. This documented includes requirements invoked by:

**Bear Valley Electric Service, Inc.
Public Safety Power Shutoff Plan**

- Safety and Enforcement Division Resolution, Electric Safety and Reliability Branch Resolution ESRB-8 8 of July 12, 2018: Resolution Extending De-Energization Reasonableness, Notification, Mitigation and Reporting Requirements in Decision 12-04-024 to All Electric Investor-Owned Utilities (IOU).
- California Public Utilities Commission Decision 19-05-036 of May 30, 2019: Guidance Decision on 2019 Wildfire Mitigation Plans Submitted Pursuant to Senate Bill 901.
- California Public Utilities Commission Decision 19-05-040 of May 30, 2019: Decision on 2019 Wildfire Mitigation Plans of Liberty Utilities/CalPeco Electric; Bear Valley Electric Service, a Division of Golden State Water Company; and Pacific Power, a Division of PacifiCorp Pursuant to Senate Bill 901.
- California Public Utilities Commission Decision 19-05-042 of May 30, 2019: Decision Adopting De-Energization (Public Safety Power Shutoff) Guidelines (Phase 1 Guidelines).
- California Public Utilities Commission Decision 20-03-004 of March 12, 2020: Decision on Community Awareness and Public Outreach Before, During and After a Wildfire, and Explaining Next Steps for Other Phase 2 Issues.
- California Public Utilities Commission Decision D20-05-051 of May 28, 2020: Decision Adopting Phase 2 Updated and Additional Guidelines for De-Energization of Electric Facilities to Mitigate Wildfire Risk.
- California Public Utilities Commission Decision D21-06-024 of June 24, 2021: Decision Adopting Phase 3 Revised and Additional Guidelines and Rules for Public Safety Power Shutoffs (Proactive De-Energizations) of Electric Facilities to Mitigate Wildfire Risk caused by Utility Infrastructure

**Bear Valley Electric Service, Inc.
Public Safety Power Shutoff Plan**

Appendix A: BVES “High Risk Areas” for PSPS Consideration

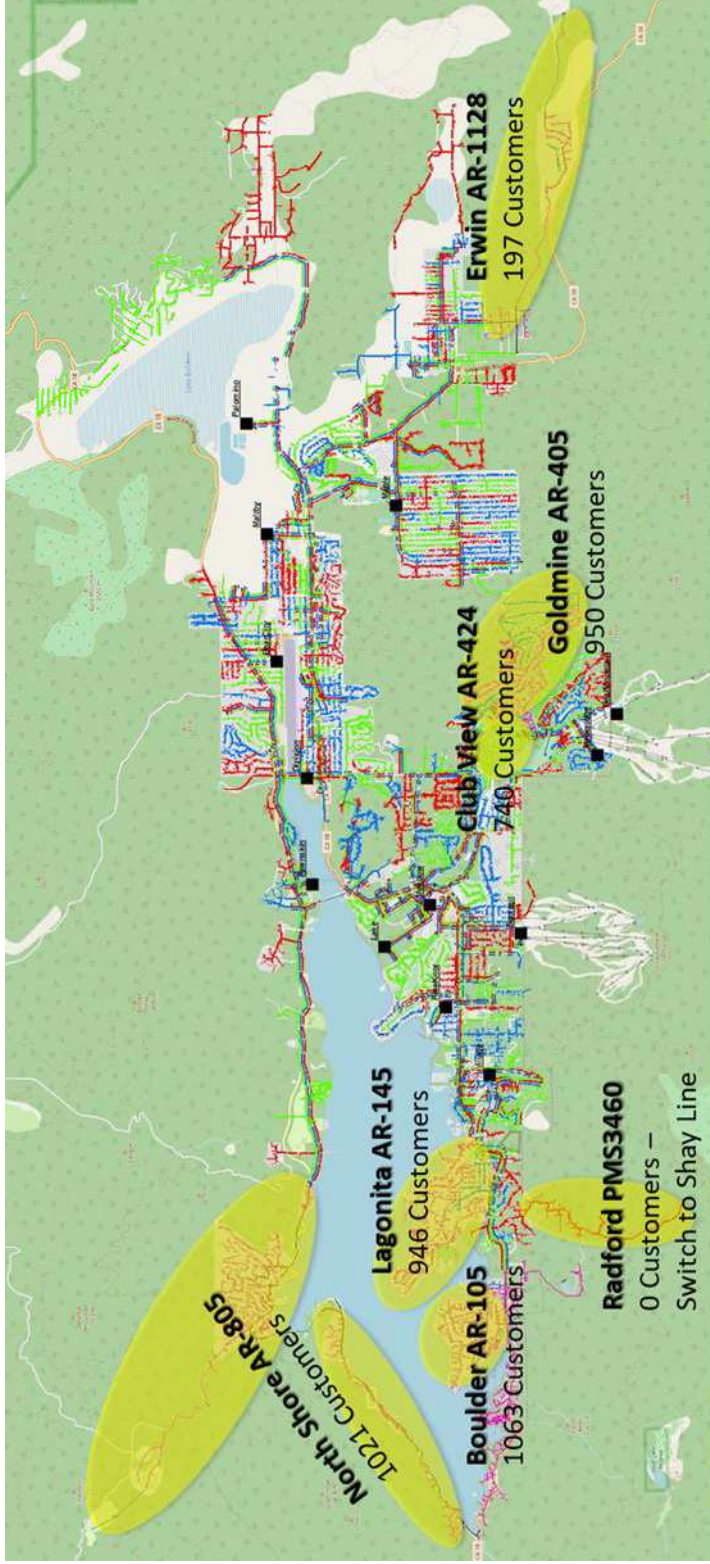

Bear Valley Electric Service, Inc. Public Safety Power Shutoff Plan

Appendix B: BVES Supply Lines, Sources of Power and Sub-Transmission System

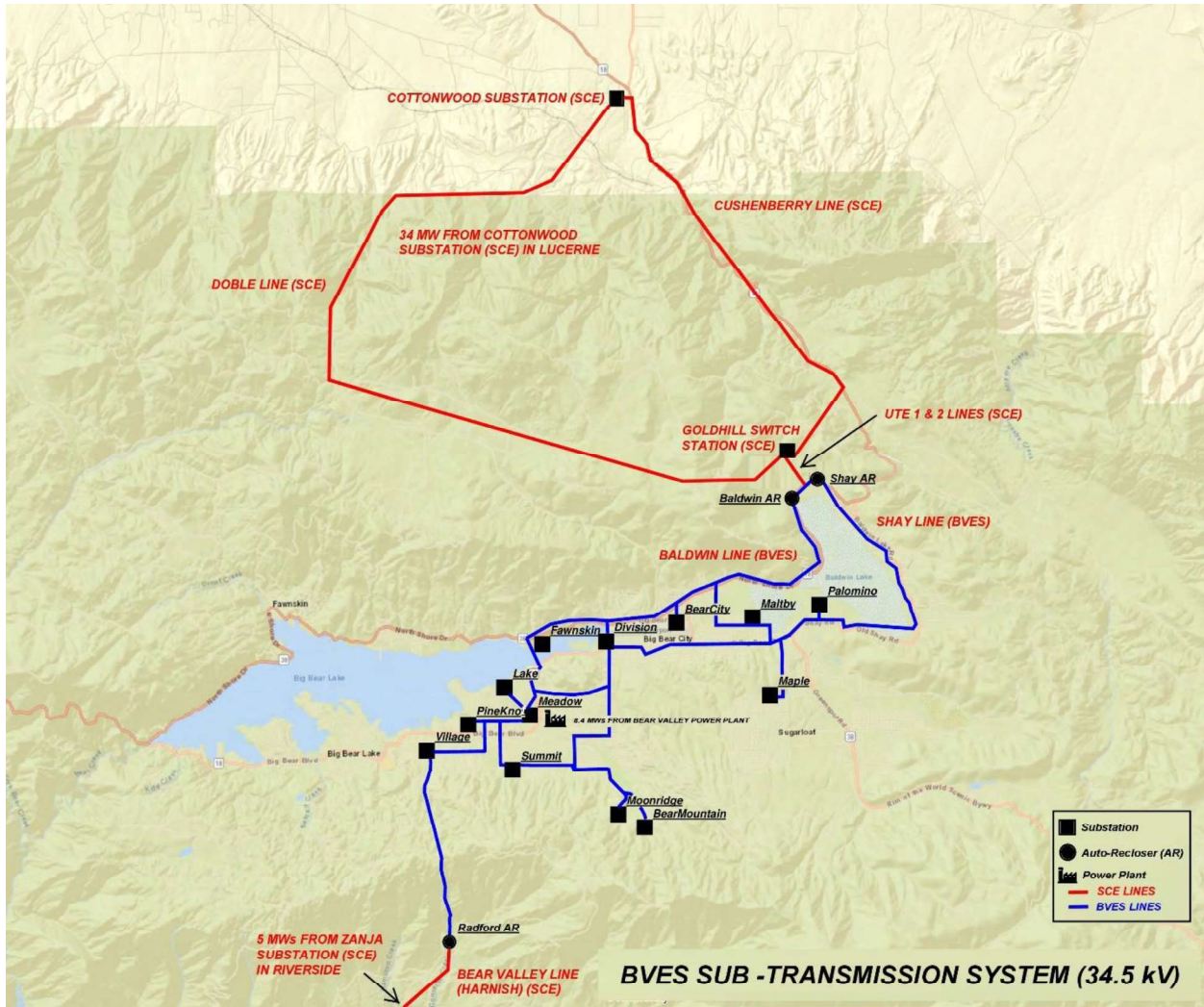

**Bear Valley Electric Service, Inc.
Public Safety Power Shutoff Plan**

APPENDIX C: COMMON ACRONYMS

Acronym	Definition
AAR	After Action Report
COA	Course of Action
DHS	U.S. Department of Homeland Security
EEG	Exercise Evaluation Guide
EOC	Emergency Operations Center
FEMA	Federal Emergency Management Agency
HSEEP	Homeland Security Exercise and Evaluation Program
HSPD	Homeland Security Presidential Directive
HQ	Headquarters
ICS	Incident Command System
IP	Improvement Plan
ISR	Initial Situation Report
N/A	Not Available
NIMS	National Incident Management System
NRF	National Response Framework
NWS	National Weather Service
OPORD	Operations Order
Ops	Operations
POC	Point of Contact
PPD	Presidential Policy Directive
RSOI	Reception, Staging, Onward Movement, and Integration
SitMan	Situation Manual
SME	Subject Matter Expert
SOG	Standard/Standing Operating Guidelines
TBD	To Be Determined
FE	Functional Exercise

Appendix J.

**BEFORE THE PUBLIC UTILITIES COMMISSION
OF THE STATE OF CALIFORNIA**

Order Instituting Rulemaking to Examine Electric
Utility De-Energization of Power Lines in Dangerous
Conditions.

Rulemaking 18-12-005
(Filed December 13, 2018)

**BEAR VALLEY ELECTRIC SERVICE, INC. (U 913 E) PLAN TO
ADDRESS ACCESS AND FUNCTIONAL NEEDS DURING
DE-ENERGIZATION EVENTS**

JEDEDIAH J. GIBSON
DOWNEY BRAND LLP
621 Capitol Mall, 18th Floor
Sacramento, California 95814
Telephone: 916.444.1000
Facsimile: 916.444.2100
Email: jgibson@downeybrand.com

February 1, 2023

Attorneys for Bear Valley Electric Service, Inc.

**BEFORE THE PUBLIC UTILITIES COMMISSION
OF THE STATE OF CALIFORNIA**

Order Instituting Rulemaking to Examine Electric
Utility De-Energization of Power Lines in Dangerous
Conditions.

Rulemaking 18-12-005
(Filed December 13, 2018)

**BEAR VALLEY ELECTRIC SERVICE, INC. (U 913 E) PLAN TO
ADDRESS ACCESS AND FUNCTIONAL NEEDS DURING
DE-ENERGIZATION EVENTS**

In accordance with Ordering Paragraph 3 of Decision (“D.”) 21-06-034 and the guidelines set forth in Appendix A, Section G – Medical Baseline and Access and Functional Needs (AFN) Communities to that decision, Bear Valley Electric Service, Inc. (“BVES”) submits this plan to address access and functional needs (“AFN”) customers and communities during a de-energization event. BVES’ AFN plan is provided in Appendix A.

February 1, 2023

Respectfully submitted,

/s/ Jedediah J. Gibson

JEDEDIAH J. GIBSON
DOWNEY BRAND LLP
621 Capitol Mall, 18th Floor
Sacramento, California 95814
Telephone: 916.444.1000
Facsimile: 916.444.2100
Email: jgibson@downeybrand.com

Attorneys for Bear Valley Electric Service, Inc.

Appendix A

BVES Access and Functional Needs Plan



**BEAR VALLEY ELECTRIC SERVICE, INC.'S
PLAN TO SUPPORT POPULATIONS WITH ACCESS AND
FUNCTIONAL NEEDS DURING PUBLIC SAFETY POWER
SHUTOFFS IN 2023**

FEBRUARY 1, 2023

TABLE OF CONTENTS

EXECUTIVE SUMMARY

INTRODUCTION

Subject Matter Experts (Engage the Whole Community)

Statewide AFN Collaborative Planning Team

1. PURPOSE, SCOPE, SITUATION OVERVIEW, AND ASSUMPTIONS

1.1 Purpose/Background — WHY

1.2 Scope

Identify individuals with Access and Functional Needs (AFN) for Public Safety Power Shutoff (PSPS) support

1.3 Situation Overview

1.3.1 Hazard Analysis Summary – Definition of Risk

List of Risks and Hazards -- Potential Consequences

1.3.2 AFN Population

1.3.3 Success Measures and Metrics

1.3.4 Capability Assessment -Statewide/Local Research
Research and Surveys

1.4 Planning Assumptions

2. CONCEPT OF OPERATIONS

2.1 Preparedness/Readiness (Before Power Shutoff)

2.1.1 AFN Identification Outreach

2.1.2 AFN Support Resources

211 Care Coordination & Referral Service

Resource Planning and Partnerships

2.1.3 Back-Up Power

Portable Battery Program

Generator Program

Resiliency Efforts and Surveys

Individual Action Plans (CERTs, 211, DDAR)

2.1.4 Customer Assistance Programs

- 2.1.5 Emergency Operations Centers
 - Preparation Exercises
 - Training
 - AFN Liaison
 - Customer Care
- 2.1.6 PSPS Preparedness Outreach and Community Engagement
 - AFN Public Education and Outreach
 - Accessibility of Communications
 - CBO Outreach
 - AFN Outreach
 - Tribal Engagement
- 2.1.7 Community Resource Centers (CRCs)
 - Planning and Standards

2.2 PSPS Activation (During – Emergency Operation Center activated)

- 2.2.1 PSPS Communications
 - PSPS Notifications
 - PSPS Customer Notifications
 - Accessible Media Engagement

2.3 Recovery (After – Power has been restored)

- 2.3.1 AFN Support
 - After Action Reviews and Reports
 - Lessons Learned and Feedback
 - Customer Surveys

3. INFORMATION COLLECTION, ANALYSIS AND DISSEMINATION

3.1 Customer Privacy

4. AUTHORITIES AND REFERENCES

4.1 Annual Report and Emergency Response Plan in Compliance with General Order 166

EXECUTIVE SUMMARY

In preparation for the submission of Bear Valley Electric Service, Inc.'s (BVES) Plan to Support Populations with Access and Functional Needs during Public Safety Power Shutoffs (PSPS) in 2023, BVES has participated in the Access and Functional Needs (AFN) Collaborative Planning team, AFN Core Planning Team and provided executive representation on the Statewide Joint IOU AFN Advisory Council. To support individuals with AFN during potential PSPS events, BVES has additionally participated in the creation of an annual support plan with assistance from regional and statewide AFN stakeholders. Beginning in 2023, that plan will leverage the Federal Emergency Management Administration's (FEMA) Comprehensive Preparedness Guide six-step Process. To measure progress on the implementation of that plan, BVES will continue to provide quarterly updates to the California Public Utilities Commission (CPUC).

The main risk identified through collaboration with AFN stakeholders that this plan is intended to mitigate is "Individuals with AFN are unable to use power for devices/equipment for health, safety, and independence due to an unexpected PSPS or are unprepared for a PSPS." BVES followed the same outline as identified with the statewide AFN Collaborative Planning Team to address "Who," "What," and "How" to support individuals with AFN and mitigate risks associated with PSPS events.

WHY

As climate conditions change, wildfires have become a year-round threat. When wildfire conditions present a safety risk to our customers and communities, electric utilities may call for a PSPS as a measure of last resort.

A PSPS, although necessary, disrupts the everyday lives of impacted individuals, including those with AFN. The purpose of this Plan is to mitigate the impact of PSPS on individuals with AFN.

WHO

The Joint IOU Statewide AFN Advisory Council and AFN Core Planning Team developed a definition of Electricity Dependent individuals that this Plan seeks to support. That definition remains unchanged from 2022.

Electricity Dependent Definition: Individuals who are at an increased risk of harm to their health, safety and independence during a Public Safety Power Shutoff for reasons including, but not limited to:

- Medical and Non-Medical
- Behavioral, Mental and Emotional Health
- Mobility and Movement
- Communication

WHAT & HOW

Working alongside the AFN Collaborative Council and AFN Core Planning Team, the IOUs have worked to identify the goals, objectives, and potential opportunities for enhancements in 2023, outlined in this Plan.

The overarching goal is to mitigate impacts of a PSPS on individuals with AFN served by the IOUs through improved customer outreach, education, assistance programs and services.

INTRODUCTION

As climate conditions change, our region is facing drier and hotter weather conditions making wildfires a year-round threat. The IOUs continually monitor weather and other climate conditions to detect fire conditions. When wildfire risk conditions present a safety threat to the safety of our customers and communities, electric utilities may call for a PSPS as a measure of last resort. PSPS de-energization activations disrupt the everyday lives of all individuals impacted. This 2023 Plan focuses primarily on individuals and communities with Access and Functional Needs, as they may be disproportionately impacted by PSPS activations. The plan was developed incorporating elements from the AFN Core Planning Team comprised of leaders in the AFN community and the utilities.

Leveraging the FEMA Comprehensive Preparedness Guide six-step Process, BVES attended AFN Core Planning Team meetings and observed the execution of a “whole community approach” to develop an overarching Joint IOU Statewide template to meet the diverse needs of the individuals with AFN. BVES utilized this template to develop an AFN plan for 2023, despite never implementing a PSPS ever before. BVES acknowledges the significant variance in available resources, system limitations and geographical differences that are evident when compared to larger IOUs throughout the state.

BVES will file its annual plan as required by the CPUC regarding its planned efforts to address people/communities with AFN during PSPS. Additionally, the IOUs will provide the CPUC with quarterly updates regarding the progress towards meeting the established plans and the impact of its efforts to address this population during PSPS.

Subject Matter Experts (Engage the Whole Community)

Each of the IOUs have engaged regional and statewide AFN stakeholders from a broad-spectrum of various expertise for the development of this plan in alignment with Step 1 of the FEMA Process:

FEMA Step 1: Engaging the Whole Community in the Planning. Engaging in community-based planning, planning that is for the whole community and involves the whole community, is crucial to the success of any plan.

On September 14, 2022, the IOUs introduced this effort at the broader Q3 Joint IOU Statewide AFN Advisory Council meeting, invited participation, and subsequently held a kick-off meeting with Core Planning Team members on October 14, 2022. The 2023 AFN Core Planning Team is comprised of 13 organizations representing the diverse needs of the AFN community.

Joint IOUs	San Diego Gas & Electric
	Southern California Edison (SCE)
	Pacific Gas & Electric (PG&E)

AFN Collaborative Council (per the Phase 3 OIR PSPS Decision):	California Foundation for Independent Living Centers (CFILC)
	California Health & Human Services (CHHS)
	California Office of Emergency Services (Cal OES)
	Disability Rights California (DRC)
	Disability Rights Education & Defense Fund (DREDF)
	State Council on Developmental Disabilities (SCDD)
AFN Core Planning Team	American Red Cross
	Bear Valley Electric Service, Inc.
	California Department of Developmental Services (CDDS)
	California Foundation for Independent Living Centers (CFILC)
	Center for Accessible Technology (C4AT)
	Deaf Link, Inc.
	Disability Action Center (DAC)
	Disability Policy Consultant
	Interface Children & Family Services 211
	Liberty Utilities
	North Los Angeles Regional Center (NLACRC)
	Redwood Coast Regional Center (RCRC)
	San Diego Regional Center (SDRC)

As a key component to engage the whole community in planning, BVES is also planning to solicit feedback from the Joint IOU Statewide AFN Advisory Council, their respective Regional PSPS Working Groups (SMJU focus) and other AFN experts. These groups serve as a sounding board and offer insights, feedback, and input on BVES’s customer strategy, programs, and priorities. Regular meetings are scheduled to actively identify issues, opportunities, and challenges related to the IOUs ability to mitigate the impacts of wildfire safety strategies, namely PSPS, and other emergencies throughout California.

AFN Experts:

- Wildfire Community Advisory Meetings
- Big Bear Fire Safe Council
- Local Government
- Cal OES
- CBOs
- SMJU Collaboration

1. PURPOSE, SCOPE, SITUATION OVERVIEW, AND ASSUMPTIONS

1.1 Purpose/Background

During extreme weather or wildfire conditions, electric utilities may proactively turn off power for public safety, as a measure of last resort. Public Safety Power Shutoffs (PSPS) disrupt the everyday lives of all impacted individuals.

The purpose of BVES' plan to support populations with access and functional needs during Public Safety Power Shutoffs is to mitigate the impacts of public safety power shutoff on access and functional needs individuals served by the utility through improved customer outreach, education, assistance programs and services.

BVES is focused on building foundational connections and expanding existing networks within the Big Bear community to continually improve awareness and support of AFN needs. BVES continues to work to understand existing local resources and establish relationships required to support the AFN population throughout the service territory. In addition, BVES will continue coordinating with the Statewide Collaborative Planning Team to make informed improvements through observing practices from larger IOU and agency proven successes.

BVES continues to seek methods of improvement in data collection and analysis, while improving the existing limitations that exist within CIS, OMS and GIS systems. BVES continuously works to vigorously enhance and improve their CIS to record additional AFN categories of customers and is striving to consistently work on OMS integration and testing. System improvements have been a significant area of focus. This effort will continue to be a main point of focus throughout 2023 and beyond.

1.2 Scope

Leveraging the FEMA Comprehensive Preparedness Guide 6 Step Process, BVES along with the IOUs and SMJUs collaborated with the AFN Core Planning Team and have worked to engage the whole community and develop an overarching Statewide approach that meets the diverse needs of the individuals with AFN.

Access and Functional Needs is defined by California Government Code §8593.3 as: *“individuals who have developmental disabilities, physical disabilities, chronic conditions, injuries, limited English proficiencies, who are non-English speakers, older adults, children, people living in institutional settings, or those who are low income, homeless, or transportation disadvantaged, including but not limited to, those who are dependent on public transit and those who are pregnant.”*

Recognizing this is a very broad audience, this plan focuses on minimizing the impact of a PSPS on electricity dependent individuals with AFN. To understand these impacts, the Joint IOU AFN Advisory Council developed a preliminary understanding of the term “electricity dependent.” This preliminary definition is intended to help inform new/enhancements to the programs and resources that are currently available.

The utilities are filing individual versions of their 2023 AFN plans to include territory-specific details for meeting the needs identified by the Core Planning Team. The comprehensive plans

reflect the geographical differences as well as the diverse needs of the AFN community, while optimizing opportunities for consistency statewide.

1.3 Situation Overview

1.3.1 Hazard Analysis Summary – Definition of Risks

FEMA Step 2: *Understand the Situation. Understanding the consequences of a potential incident require gathering information about the potential AFN of residents within the community.*

“Understand the Situation,” continues with identifying risks and hazards. The assessment helps a planning team decide which hazards or threats merit special attention, what actions must be planned for, and the resources likely to be needed.

The key risk identified by the Core Planning team in 2023, which continues into 2024 is *“Individuals with AFN are unable to use power for devices/equipment for health, safety, and independence due to a PSPS.”*

During the planning process, the AFN Core Planning Team emphasized that the needs of individuals with AFN extend well beyond medical devices alone and that the risks are as diverse as the population. The IOUs recognize the impacts of PSPS are dynamic and are committed to supporting customers before, during and after a PSPS.

1.3.2 AFN Population - AFN Identification

BVES is a small electric utility in the Big Bear Lake recreational area of the San Bernardino Mountains located about 80 miles east of Los Angeles that provides electric distribution service to 24,650 residential customers in a resort community with a mix of approximately 40% full-time and 60% part-time residents. Its service area also includes 1,497 commercial, industrial and public-authority customers, including two ski resorts and the local waste-water treatment facility. BVES differs significantly from California’s largest electric investor-owned utilities, Pacific Gas & Electric Company, Southern California Edison Company, and San Diego Gas & Electric Company (collectively, the “Large IOUs”). BVES has a substantially smaller customer base over which to spread fixed costs of service, has a mountainous and remote service territory subject to greater seasonal climate fluctuations, and faces greater resource limitations in comparison to the Large IOUs. The Commission has historically recognized these distinctions between BVES and the Large IOUs. BVES continues work on system modifications to CIS and OMS to allow the recording of AFN customer categories and data beyond medical baseline customers. As of December 31, 2022, the CIS system identifies (197) Medical Base Line (MBL) customers marked as AFN customers. BVES total AFN customers (582).

BVES is continuously working to evaluate and seeks to implement system enhancements, modifications and manual work around on the CIS, OMS, and GIS systems. Data tracking continues to be reviewed for areas of improvement to allow BVES more visibility into the AFN customer population. In 2022, BVES explored options to establish the ability to track AFN categories of customers beyond MBL in the CIS, including the following categorical identifiers: AFN customers enrolled in low-income programs, AFN customers with a physical, intellectual or developmental disability, AFN customers with a chronic condition or injury, AFN customers identified with limited English proficiency, AFN customers in households with

older adults / children, AFN homeless / transportation disadvantaged customers, and an additional AFN category for customers who wish to self-identify but may not necessarily fit into the aforementioned categories.

As a part of BVES' recent and ongoing system improvements, the capability to map AFN customers beyond MBL is anticipated to be integrated into the OMS in the near future and further refined throughout 2023.

- List of Risks and Hazards - Potential Consequences

BVES understands the risk analysis completed by the AFN Core Planning Team and has found it helpful in understanding the variety of diverse risks that exist for AFN populations.

- Customer Research and Surveys

In 2022, BVES partnered with MDC Research to execute two waves of surveys to measure the public's awareness of messaging related to wildfire preparedness and safety. Customers were surveyed at random, targeted for either phone or web administration. Surveys were available to customers in English and Spanish.

The first wave of surveys conducted between June 13, 2022 and June 29, 2022 resulted in completion of 400 surveys, including 13 from critical customers. The second wave of surveys conducted between December 28, 2022 and January 15, 2023 resulted in completion of 423 surveys, including 30 from critical customers.

Notable customer survey findings include:

- Among those reporting that they rely on electricity for medical needs, one quarter are aware of additional notices from BVES.
- 98% of respondents indicated it would not be helpful to receive communications in a language other than English.
- **43%** are aware they can **update their contact information with BVES**, and 61% of those have done so, in line with June 2022 findings.
- Similar to June 2022, 16% say they know **whether their address is in PSPS area**, and **11% are aware of a PSPS map on BVES' website**.

In addition to customer surveys, MDC Research conducted Community Based Organization interviews to request feedback and gather suggestions on the most effective approaches to PSPS communication within the community. The first wave of interviews resulted in two completed CBO interviews, whereas the second wave resulted in four completed CBO interviews.

Notable CBO interview findings include:

- Community Based Organizations interviewed expressed a willingness and ability to share BVES PSPS preparedness information to the community during typical interactions, through social media and by handing out printed materials provided by BVES.

- English and Spanish are the primary languages required for effective communication in the communities BVES provides service to.
- Simplified, easy-to-understand written communications are of importance to reach individuals with all levels of reading comprehension.

Additional survey information used to inform BVES' 2022 approach in effectively reaching customers include findings that email remains the most commonly recalled channel for wildfire preparedness communication. In terms of clarity, direct mail is rated the highest; bill inserts and other websites are rated as the most useful sources of information about wildfire preparedness. Customers say they most often recall seeing or hearing messages about wildfire on TV news, social networks and through word of the mouth.

In 2023, BVES plans to seek out additional resources to collaborate with in executing surveys and research specific to AFN needs before, during and after PSPS events. BVES also plans to explore availability of existing resources and identification of gaps that may exist through further discussions and expansion of relationships with agencies, cities, counties and local organizations.

- Accessibility Webpage and Feedback

BVES plans to continue improvements in accessibility of their webpage. Improvements in 2022 include the addition of 211 resource information on the web, as well as successful development of a self-identification tool for AFN customers in both Spanish and English languages.

1.3.3 Success Measures and Metrics

BVES intends to integrate key performance indicators (KPIs) to measure impacts of PSPS. These indicators include understanding the percentage of individuals with AFN who were aware of what support and resources were available to them during PSPS and the percentage of individuals with AFN who reported being satisfied with level of utility communication around PSPS preparedness and event updates. BVES plans to obtain this information by including these indicators in future AFN surveys. Additional methods to monitoring effectiveness in AFN support include monitoring web traffic and self-identification tool utilization rates, as well as tracking AFN attendance at CRC locations during PSPS events.

1.3.4 Capability Assessment - Statewide/Local Research

FEMA Step 3: Operational priorities – specifying what the responding organizations are to accomplish to achieve a desired end-state for the operation.

BVES has assessed the current state of resources given the matrix provided to the AFN Collaborative Working Team.

PSPS IOU Resource Matrix – Overview

*offered in 2020

Resources		PacifiCorp	Liberty	BVES
Community Resource Centers	Wi-fi, ADA-accessible restroom, bottled water, snacks, charging, chairs, ice, event information & area/weather items	X	X	X
Power Resiliency	Portable backup batteries for Medical Baseline customers			X
	Generator Rebate Program			
Food Replacement	Food Bank Partnerships			
	Meals on Wheels			
	Community Resource Center – Hot meals			
	Grocery Gift Cards		X	
	Food delivery			
Transportation				X
Lodging			X	X
IOU Customer Communications	Annual Preparedness Outreach	X	X	X
	In Language Materials	X	X	X
	Accessible Materials	X	X	X
	CBO Partners	X	X	X
Training	General Information	X	X	X
	Tabletop exercises and full-scale exercises	X	X	X
Community Engagement	IOU hosted events, Webinars, Advisory Boards, Working Groups	X	X	X
PSPS Notifications	Account Holders	X	X	X
	Non-Account Holders (PG&E/SDG&E Address; SCE Zip Code)	X	X	
	Broad: via multicultural media, CBOs, and social media	X	X	X
Notification Confirmation (Phone retries & in person doorbell rings)	Life Support/Critical Care	X	X	X
	Medical Baseline	X	X	X
	Self Certified Vulnerable Customer Status	X		

FEMA: Step 4: Plan Development - Develop and Analyze Courses of Action – This step is a process of generating, comparing, and selecting possible solutions for achieving the goals and objectives identified in Step 3. Planners consider the requirements, goals, and objectives to develop several response alternatives. The art and science of planning helps determine how many solutions or alternatives to consider; what works in one territory might not be available and/or relevant in another territory. While there is a desire to have a consistent response across all the IOUs, it is not entirely possible.

Community Resource Centers: BVES continues to work to establish agreements with community partners and facilities throughout the service territory in preparation for PSPS events. More information on CRCs can be found in section 2.1.2.

Power Resiliency: Section 2.1.5 provides detail on BVES’s current state.

Food Replacement: BVES is exploring options to fulfill this.

Transportation: BVES does not currently partner with transportation / paratransit services and plans to seek out existing transportation / paratransit services available to customers in 2023.

BVES has reached out to the local public transportation service (MARTA) and was informed that they may be able to assist with non-medical transportation on an as available basis.

Lodging: BVES has contracted lodging services for customers during significant outage events on an as needed basis and looks to continue partnership with local organizations to remain aware of community needs.

IOU Customer Communications:

BVES conducts annual preparedness outreach and has an established communications plan for PSPS preparedness communication.

In Language / Accessible Materials: BVES provides all PSPS toolkit information in English and Spanish. BVES looks to continually improve accessibility of materials throughout 2023.

CBO Partners: BVES communicates with Community Based Organizations throughout the service territory and is currently focused on expanding CBO networks throughout 2023.

Training: BVES regularly conducts training, tabletops and PSPS exercises for all BVES employees to prepare for potential PSPS events.

Community Engagement: BVES hosts community meetings throughout the service territory to educate on the PSPS determination and notification process and detailing ways for customers to prepare. When applicable, BVES will co-host meetings with Public Safety Partners and AFN advocacy groups. BVES also discusses PSPS preparation with CBOs during physical and/or virtual meetings throughout the year. BVES provides PSPS materials to CBOs, city, county and school contacts proactively.

PSPS Notifications:

Account holders: BVES provides PSPS notification to account holders. See section 2.2 for more information.

Non-account holders: BVES plans to provide PSPS notification to non-account holders, such as Public Safety Partners, Critical Infrastructure contacts and CBOs. See section 2.2 for more information.

Community Based Organizations: BVES provides PSPS notification through a variety of communication channels. See section 2.2 for more information.

Notification Confirmation: BVES confirms PSPS notification receipt of all potentially impacted MBL customers. BVES treats all MBL customers as critical customers. See section 2.2 for more information.

1.4 Planning Assumptions

- For most PSPS events, there is likely to be advanced notice
- The scope of PSPS events can expand or contract rapidly in a short period
- Effective support of individuals with AFN requires a whole community (i.e., utilities, CBOs, non-profits organizations, government agencies) approach
- PSPS events may occur concurrent with unrelated emergencies

2. CONCEPT OF OPERATIONS

2.1 Preparedness/Readiness (Before Power Shutoff)

2.1.1 AFN Identification Outreach

BVES plans to execute AFN identification outreach through a variety of channels throughout 2023. Additional methods of AFN identification include CBO and community outreach targeted efforts to encourage AFN self-identification and increase awareness of resource availability.

2.1.2 AFN Support Resources

- 211 Care Coordination & Referral Service

BVES plans to continue to engage contacts throughout the State of California to increase collaboration throughout 2023. 2-1-1 offers support to residents of San Bernardino County. BVES successfully implemented a webpage dedicated to 211 customer resource information during 2022. BVES does not currently participate in 211 Care Coordination contracts, however, 211 partnership is an area of focus and further exploration in 2023.

- Resource Planning and Partnerships

BVES anticipates further exploration of CBO and agency partnerships on an ongoing basis throughout 2023 in terms of AFN specific support and resource planning.

2.1.3 Back-Up Power

BVES has program material from SCE's Critical Care Back up battery (CCBB) program and is in the process of incorporating this information into our operating practices. We have staff available to deploy batteries on a small scale and educate each customer on the basic functionality of each battery unit. BVES also has an 8.4MW natural gas generation station in its service territory, available to produce energy during emergency events.

2.1.4 Customer Assistance Programs

- Medical Baseline Allowance Program (MBL)
- Energy Saving Assistance (ESA) Program
- California Alternate Rates for Energy (CARE)

2.1.5 Emergency Operations Centers

BVES will activate their Emergency Operations Center (EOC) if forecasted sustained wind or 3-second wind gusts expected to exceed 55 mph or actual sustained wind or 3-second wind gusts exceed 45 mph and expected to increase. Under normal conditions the Field Operations Supervisor controls the system line-up and during EOC activation the system line-up is controlled by the Storm Operations Supervisor (SOS).

2.1.6 PSPS Preparedness Outreach and Community Engagement

- Advisory Councils
- CBO Outreach

BVES seeks out opportunities to provide PSPS preparedness information through established Community Based Organizations regularly throughout the year. BVES leadership has fostered a working relationship with the City of Big Bear Lake, where the city manager has a direct line of communication with the President of BVES.

BVES executes customer outreach to share information about customer programs (CARE, ESA, MBL) and PSPS awareness through a variety of methods including community events, website resources, social media, bill inserts, targeted outreach to multi-family dwellings and mobile home parks, radio ads (multicultural media), digital ads, print ads and through call center staff. AFN identification and available resource communication will be a focus in 2023.

As a result of recent MDC Research customer and CBO survey results, areas of focus for 2023 include increased messaging around preparation of emergency kits and readiness. Suggestions provided by customer and CBO feedback highlight the effectiveness of increased use of email, local media and driving website traffic to existing PSPS information.

Development of additional materials related to AFN self-identification and available resources is an area of focus for BVES in 2023.

Customer recall increased significantly between the recent two waves of MDC

surveys in terms of emergency services communications. BVES plans to consider ways to further partner with local organizations and emergency services to more effectively reach customers.

Utilizing CBO networks and targeted customer program outreach including multi-family housing, community events and direct mailings are an identified area of opportunity to expand customer communications in terms of AFN identification and increase customer awareness of available resources.

- Tribal Engagement

BVES does not have a tribal community in its service territory.

- Marketing and Communications

BVES has developed the following communications outreach plan to notify access and functional needs (AFN) customers of pertinent Public Safety Power Shutoff (PSPS) status updates, including ongoing proactive education.

BVES will continue to engage AFN customers throughout the year, and especially during wildfire season, to educate on the PSPS determination and notification process and how customers can prepare for prolonged de-energization through the following channels:

Community Meetings: BVES will host community meetings throughout the service territory to educate on the PSPS determination and notification process and detailing ways for customers to prepare. When applicable, BVES will co-host meetings with Public Safety Partners and AFN advocacy groups.

Website: BVES will publish and maintain PSPS web copy outlining BVES' determination and notification process and detailing ways for customers to prepare, including information specific to AFN populations.

Social Media: BVES will post content to Facebook notifying customers of BVE's PSPS determination and notification process and outlining safety information specific to AFN populations.

Customer Email: BVES will distribute an email notifying customers of BVES' PSPS determination and notification process and outlining safety information specific to AFN populations.

Bill Insert/Mail: BVES will distribute a bill insert/mailer notifying customers of BVES' PSPS determination and notification process and outlining safety information specific to AFN populations.

Throughout 2023, BVES plans to assess and enhance communication accessibility. Notable areas of focus are additional Spanish language support and AFN available resource and self-identification information accessibility on BVES webpages.

- Translations

BVES call centers provide customer access to bilingual (Spanish and English) Customer Service Representatives.

2.1.7 Community Resource Centers (CRCs)

BVES has established an internal working group comprised of representatives from a variety of departments including Emergency Management and Wildfire Mitigation to focus on Community Resource Center planning. The group meets to develop plans, determine priorities, and execute required action for CRC preparedness in 2023. This internal group continues to develop a thorough approach to CRC execution and collaborates externally with community stakeholders.

BVES plans to provide snacks, water, device charging ability, Wi-Fi, ADA accessible restrooms, resource information, BVES Customer Service staff (including bilingual representation when possible), portable cell phone chargers, and blankets at CRC location. CRC location present a unique opportunity for program enrollment, PSPS preparedness information sharing and AFN identification, and BVES plans to provide information on CARE, ESA and MBL programs at its CRC. PSPS Toolkit information will be shared in English and Spanish at CRC location.

2.2 PSPS Activation (Emergency Operation Center activated)

2.2.1 MBL Customer Communication

To identify MBL customers for an event, BVES identifies MBL customers with accounts in the potentially impacted PSPS zone. The MBL notification sequence is as follows:

1. OMS notification
2. Two-way Text Communication
3. If no positive contact, phone call to customer from customer service representative.
4. If no positive contact, physical site visit to the residence.
5. If no positive contact, door hanger notification left at the residence.

To contact MBL customers behind master metered accounts, BVES consults a list of master meter locations to determine if these meters are in the Public Safety Power Shut-off (“PSPS”) de-energization zone. Each master meter has a database that provides behind-the-meter information. From this database, BVES can determine if there are MBL customers, who they are, and what units they occupy. The communication steps utilized for MBL customer contact also apply to master meter MBL customer contact.

- PPS Notifications

BVES will notify AFN customers before, during and after a PPS through the following channels (posted and updated as needed):

OMS Alerts: BVES OMS system is alerted of an outage, identifies the outage area, identifies the customers affected, and will distribute an alert through the OMS system notifying customers of the status of the PSPS.

Two-way Text Communications: BVES has the capability of notifying customers who opted in for two-way text communications of an outage, the status of an outage, and restoration of an outage.

Community-Based Organizations (CBO): BVES will notify CBOs that serve AFN populations of the status of the PSPS and request that they distribute the alert to their contact list. CBOs may include:

- Unhoused shelters
- Food banks
- Special needs programs

Critical Facilities & Infrastructure: BVES will notify critical facilities and infrastructure of the status of the PSPS and request that they distribute the alert to their own contact lists.

Critical facilities and infrastructure include:

- Police stations
- Fire stations
- Big Bear Community Hospital

Website: BVES will publish an alert to the website notifying customers of the status of the PSPS and outlining safety information specific to AFN populations.

Social Media: BVES will post content to Facebook notifying customers of the status of the PSPS and outlining safety information specific to AFN populations.

Customer Email: BVES will distribute an email to all customers affected by a PSPS, including those in the AFN community notifying them of the status of the PSPS and outlining safety information specific to their needs. An enhancement in 2023 will include Spanish language messaging within PSPS customer emails.

News Release: BVES will distribute a news release to local media outlets alerting customers of the status of the PSPS and outlining safety information specific to AFN populations. In 2021, BVES added multicultural media outlets to lists of media contacts utilized for PSPS notification.

Customer Service Representatives (CSR): BVES will provide CSRs with information specific to safety guidelines and resources for AFN customers during a PSPS.

All content intended for customers will be translated and disseminated in English and Spanish, when possible. Please note, social media parameters may prohibit the sharing of information in multiple languages. All digital content intended for customers will additionally

be compliant with ADA regulations.

2.3 Recovery (After - Power has been restored)

2.3.1 AFN Customer Support

- After Action Reviews and Reports

BVES intends to continue partnerships with local organizations to remain aware of customer needs before, during and after PSPS events.

- Lessons Learned and Feedback
- Customer Surveys

An area of opportunity in 2023 for BVES is expansion of customer, CBO and public safety partner surveys before and after PSPS events.

3. INFORMATION COLLECTION, ANALYSIS AND DISSEMINATION

3.1 Customer Privacy SMJU

BVES has entered into new confidentiality agreements with both the City of Big Bear Lake and the Big Bear Fire Department to begin the process of data sharing amongst agencies. BVES has also developed new contacts and working relationships with the local Red Cross representatives in its district, as well as other community organizations such as the Mountain Mutual Aid Association and Fire Safe Big Bear. Other efforts to contact visually and hearing- impaired citizens is underway by reaching out to the California Council of the Blind, the Center for Access Technology, Disability Disaster Access Program & Resources, and NorCal Services for the Deaf and Hard of Hearing to better identify customers of need.

4. AUTHORITIES AND REFERENCES

4.1 Annual Report and Emergency Response Plan in Compliance with General Order 166

The Emergency Response Plan (ERP) is provided to all “BVES employees to ensure an efficient, effective and uniform response during an emergency situation. BVES recognizes the importance of an integrated ERP to safely provide for the energy needs of our customers and the requirements of our stakeholders in the event of an emergency.

The ERP further establishes the structure, processes and protocols for the Company’s emergency response and identifies departments and individuals that are directly responsible for that response and critical support services. In addition, it provides a management structure for coordination and deployment of the essential resources necessary for the response.